

Multi-paradigm Methodology for Enterprise Modelling using Agent-based Modelling and System Dynamics

Dushyanthi Mulpuru, Abhishek Yadav and Anwasha Basu

Tata Consultancy Services Research, Pune 411013, India

Abstract

The Covid-19 pandemic has significantly altered business operating models. Enterprise decision makers responsible for devising actionable business operational strategies are confronted with making informed decisions in the state of continuously evolving pandemic landscape. As pandemic concerns subside, their objective is to formulate a workplace opening strategy that mitigates employee infections and the subsequent impact on project delivery. It is therefore critical to appropriately model the underlying aspects of the enterprise system and enable strategy evaluation. Enterprise in this context represents a complex, dynamic system composed of multiple sub-systems with varying characteristics, levels of uncertainty, granularity, data availability and scale. Owing to these distinctions, different modelling paradigms are better suited to individually model these sub-systems, and their integration results in a comprehensive model that is a close approximation of the real system. This paper presents a hybrid/multi-paradigm approach for modelling the enterprise ecosystem, by building on the established concepts of Agent Based Modelling (ABM) and System Dynamics (SD) that enables evaluating the impact of operational strategies on employee infections. The model is formulated as integration of multiple sub-systems and their interactions - infection module, employee and dependent, office infrastructure and society modules. These four dimensions, comprising the enterprise ecosystem, significantly influence the employee infection dynamics. While the SD model quantifies the aggregated infection dynamics of society at the population scale, ABM models fine-grained specifics of employees, dependents, infrastructure, and the resulting infection dynamics.

Keywords

Agent-based modelling, System dynamics, Enterprise multi-modelling, Model development, Covid-19

1. Introduction

The Covid-19 pandemic has greatly influenced the way businesses operate, with a major shift in the employee operating model as employees transitioned to working from home (WFH) [1]. As enterprises formulate post-pandemic workplace strategies, their objective is to 1. Determine the appropriate operating strategy to minimize the infection risk among employees as they transition back to working from offices (WFO). This includes establishing phase wise transition timelines and enforcing suitable procedural and infrastructural restrictions. Since the influence of the pandemic is not uniform across geographies, businesses operating in multiple geographies must devise custom strategies. 2. Establish business continuity plan (BCP) to address the impact

PoEM'2022 Workshops and Models at Work Papers, November 23-25, 2022, London, UK

✉ dushyanthi.mulpuru@tcs.com (D. Mulpuru); y.abhishek1@tcs.com (A. Yadav); anwasha.basu1@tcs.com (A. Basu)



© 2022 Copyright for this paper by its authors. Use permitted under Creative Commons License Attribution 4.0 International (CC BY 4.0).

 CEUR Workshop Proceedings (CEUR-WS.org)

of infections on the employees. The impact of pandemic on an employee can be two-fold. a. Employee infection and b. Infection among dependents/household members. Employees who have been impacted are unavailable to work, and the period of unavailability may vary depending on the severity and must be factored into the project planning process.

Building on this context, an enterprise can be conceptualized as an ecosystem composed of - physical enterprise infrastructure, employee characteristics and their social behavior, dependent characteristics, virus variants and their infection characteristics, and related policies and interventions. An enterprise workplace/infrastructure/office is a collection of physically inter-connected facilities. Employee characteristics on the other hand, include demographic, project, health, and pandemic-related factors such as vaccination and infection history, whereas behavioral characteristics include contact behaviors within different social contexts, such as interactions with other employees within the workplace, with dependents living in the household, as well as with other individuals of the society/geography. Enforced policies (e.g., limiting office visits) and infrastructural constraints (restricting operating capacities of various infrastructure facilities) significantly impact the behavioral patterns thereby influencing the infection spread among employees. Additionally, infection trends prevalent within society/geography (they vary significantly across geographies due to variations in the predominant virus variant, infection rates, demographic differences, pandemic strategies adopted, movement behaviors, and so on), virus characteristics (infectivity rate), and infections within household influence employee infections. The severity of infection in an infected individual varies based on the fatality rate of virus, demographic factors (age, gender, comorbidity), individual's infection history, vaccination status (not vaccinated, partially, fully vaccinated), and efficacy of vaccine. Models intended for supporting decision making on employee and enterprise working models should holistically capture all the above-mentioned factors that contribute towards employee infections to evaluate inter-dependencies of various interventions with the outcomes.

Modelling has been extensively used in determining infection mitigation strategies [2]. [3] presented an overview of various mathematical models such as compartment, statistical, and machine learning models proposed in the literature for analyzing the infection spread and prediction. Well-known compartment models based on differential equations such as SIR (Susceptible Infected Recovered), SEIR (Susceptible Exposed Infected Recovered) [4] assume a homogeneous population, and work well in scenarios where infection dynamics needs to be understood at the population scale. Modelling specialized contexts like workplaces requires capturing heterogeneity in terms of characteristics and behaviour at the individual level, where aggregated models are deemed inefficient. AI (artificial intelligence) forecasts of the infection spread on the other hand, are not yet very accurate [5] due to constraints imposed by lack of adequate and accurate data, and the algorithmic dynamics that rely heavily on the past behavior. Overcoming these limitations, several studies ([6], [7], [8], [9]) used ABM to model individualistic characteristics and behavior in varying contexts such as city, country and provided support to evaluate various intervention strategies for mitigating infections. However, scalability is an issue - they either require high-performance computing services, as in [7] or need to scale down the population to make the simulation manageable, as in [9]. ([8], [6]) despite having richer models, are limited to modelling a specific geography/city and can only scale to tens of thousands of agents. ([10], [11]) used multi-paradigm approach to overcome the limitations of individual paradigms. [10] starts with an agent-based approach and once global structures emerge, switches to an equation-based

aggregated approach, mitigating scalability issues. However, this aggregation is not well suited for analyzing the effects on the individual level, as the local interactions are only considered up until the switching point, whereas [11] combines age-stratified and location-specific SEIR models in an ABM framework to capture virus transmission dynamics aggregated by age cohort in different geographies. ([12], [13]) modelled risk of infection transmission in workplace/facilities. [12] used a combination of microexposure and probabilistic modeling to estimate the infection risk. But, employee infection risk from society is grossly simplified making it less suitable for modelling distinct geographies of organization spread. [13] used ABM to evaluate transmission risks in facilities but is computationally expensive due to model's reliance on stochastic lattice-based movements. Also, heterogeneity in workplace infrastructure as well as infection risk from society are not accounted for.

Modelling practices in general model the entire system using a single paradigm by decomposing the entire system into sub-systems, thereby constraining the models to a specific level of granularity. Multi-paradigm modelling on the other hand, allows for the representation of interactions between elements at different granularities [14]. [15] highlights the importance of modelling objectives in determining the nature of the model, as different modelling objectives lead to different models within same problem situation. Modelling objectives in conjunction with problem structure and data availability helps identifying the levels of granularity that can serve as a basis for determining the appropriate modelling approach. ABM is a logical choice for fine-grained modelling of office infrastructure, employee, dependent and virus models due to the availability of data and its ability to express heterogeneity and support for micro-level interventions for studying emergent behaviour; however, detailed modelling of employee's societal interactions requires modelling the entire society/geography and poses challenges in terms of citizen data availability and model scalability - as modelling citizens in their entirety for multiple geographies (since employees are spread across geographies) becomes computationally expensive, and hence calls for an aggregated modelling using SD. The ecosystem model should therefore - 1. Capture the uncertain and dynamic nature of social system owing to the influences of structural, regulatory, virus factors and 2. Allow for development of integrated models without undermining the model predictions. Our contribution in this regard is a method for modelling enterprise ecosystem to infer infection dynamics of employee and their dependents within the organization by a multi-modelling paradigm, comprising of, a coarse-grained system dynamics approach, and a fine-grained agent-based model. The proposed approach overcomes the issues of data availability and scale while still allowing for a fine-grained representation of the system of focus; and supports micro-level strategy evaluation.

The paper outline is as follows-Section 2 visits the concepts of Agent Based Modelling and System Dynamics, their contrasting capabilities, and explores hybrid SD-ABM architectures for model integration. Section 3 formulates the enterprise ecosystem from the modelling perspective and details the model construction process, describes integration approach and summarizes the results. Section 4 concludes the paper and lays the direction for future work.

2. Background

Agent Based Modelling (ABM) and System Dynamics (SD) are two widely used paradigms for modelling complex dynamic systems in variety of problem domains [16]. They have different concepts for representing the structure/behavior and hold some fundamental assumptions about the system. This section describes the key concepts and characteristics of ABM and SD and their integration approaches.

2.1. Agent Based Modelling

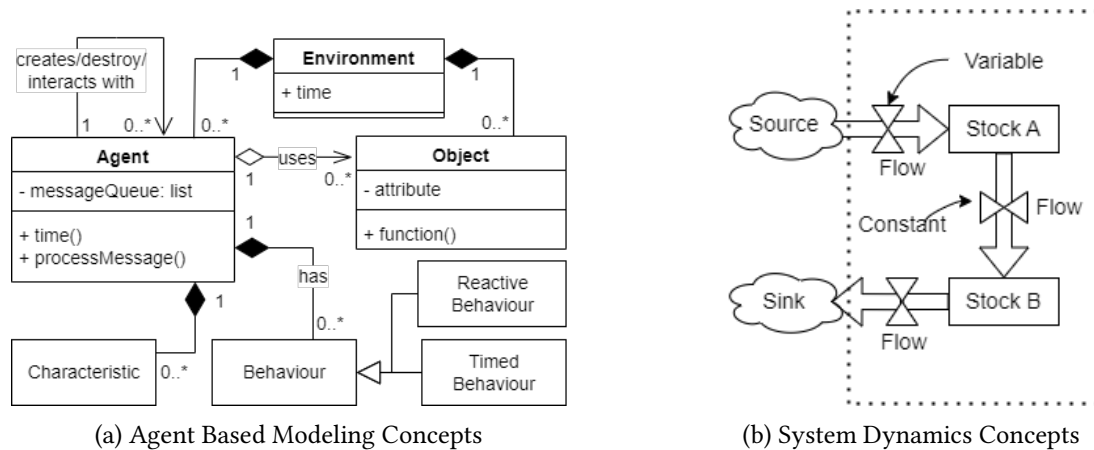

Figure 1: Agent Based Modeling and System Dynamics Concepts

ABM belongs to the class of models in which a system is modelled as a set of interacting autonomous agents having corresponding state and associated behavior. The global behavior of the system emerges through the interaction of agents with each other and with their environment [17]. Figure 1a outlines the key concepts of ABM. Agent is the primitive unit of computation having its own well-defined Behavior as set of rules. An agent's behavior can create/destroy agents, and may trigger change in its own state/attribute or in the environment. The behavior can either be timed or reactive. Timed behaviours are executed by the agent in a timely manner, these behaviours are completely autonomous and can be executed across varying temporal scales for different classes of agents while Reactive behaviours are usually triggered when one agent interacts with another using message passing. Non-Agents (refer Object in the figure 1a) lack autonomous behaviour but function as helper classes to perform computations that are not agent specific. Environment houses all agents and non-agents and the agent's actions are constrained by the environment boundary.

ABM owing to its flexibility to obtain a richer model to achieve high degree of realism and capturing emergent phenomenon makes it an excellent choice to model and simulate complex system-of-systems. Applications of ABM include modelling complex organizational and social systems [17] in a bottom-up manner using domain knowledge and detailed information about micro-behaviours of entities (e.g., citizen, employee etc.) in the system (e.g., building, city,

factories etc.) and global behaviour of the system which is unknown, emerges from the action and interaction of agents. This modeling technique is best suited in scenarios where the system is characterized by complex, nonlinear, discrete interactions between heterogeneous agents, macro/global behavior of the system is not well understood (or) the aggregated dynamics cannot be easily represented through equations and characteristics, but behavior at individual level is known. However, scalability of the agent-based simulation is an inherent limitation, and the high computational requirements yet remains a problem when it comes to modelling large systems. ABM models being purpose specific, needs to be built at the right level of description [17]; which makes it ill-suited for scenarios where micro level details are largely unknown.

2.2. System Dynamics

SD ([18], [19]) is a top-down modelling approach where the system is modelled at the macro-level to analyze the changes in the system over time. The system's dynamic behavior and interactions are represented by a set of differential equations, and realized using machine-simulatable stock and flow models. Figure 1b depicts the central concepts of SD. Stock is a fundamental unit that represents accumulation of a real-world entity. The value of a stock represents the state/snapshot of a system at any point in time. Source and Sink are types of stocks hypothesized to have infinite capacity. Flow, characterized by feedback and delay, denotes the rate at which the entities in the connected stock change their state and is controlled by the valve, which may be dependent on other values that are fixed (represented as Constant) or values that need to be computed just-in-time (represented as Variable). Both constants and variables are collectively referred to as Auxiliary variable.

SD characterized by feedback structures with non-linearity, makes it well suited for understanding the dynamic behavior of complex systems. It provides a macro-perspective and helps understand the overall structure behind complex phenomena. It is widely used to analyze a range of systems [20] and can be used with little or no data as inter-dependencies of the system elements can be incorporated based on the domain expertise. SD is best suited in scenarios where the overall system behaviour is well understood and can be reproduced as a series of feedback loops, and where the focus is on the dynamics at the population level. It is less suited for scenarios where the behavior of individual heterogeneous entities is the key focus of interest since it cannot explain the micro behaviors in a system.

2.3. Hybrid SD-ABM Modelling

The complex, multifaceted systems pose considerable challenges for traditional, single-methodology simulation approaches [21]. Oftentimes, underlying sub-systems feature varying levels of granularity, uncertainty, and are further limited by data availability. In such cases, integrated modelling approaches are the most appropriate, wherein the system components are modelled using the corresponding paradigms that suit them best. Using too many paradigms, on the other hand, may introduce new complexities [14] and hence the advantages of employing multiple paradigms must be balanced against the overhead of integrating them. The choice of hybrid architecture is dependent on the interdependencies of the system components. Several studies attempted to integrate the SD and ABM models and proposed various hybrid SD-ABM

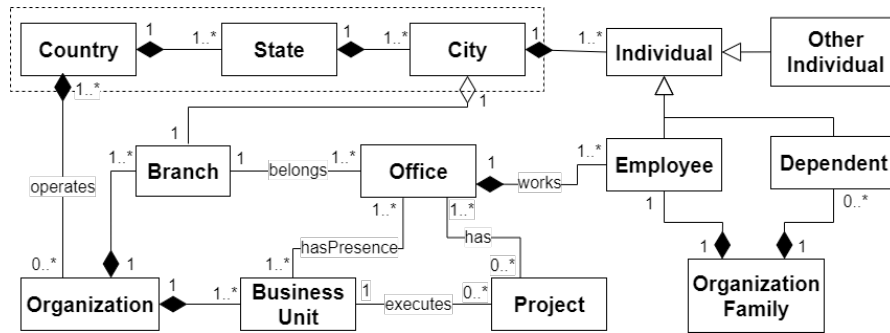

Figure 2: Organizational Structure

architectures for the same. ([22], [23], [24]) presented an overview of the existing theoretical guidance/frameworks on integrating SD and ABM. [21] proposed three broad classes of hybrid SD-ABM integration based on [25]. These are referred to as interfaced, integrated and sequential hybrid designs which differ depending on how either of the SD or ABM single paradigm meta-models interact to produce the model's output. In the sequential class, one simulation paradigm capable of producing the required input for the second simulation is initially executed, and its output is fed as input to the next paradigm. Communication between the paradigms is thus restricted to a single point of time and output of the final model represents the outcome of the overall model. The integrated class incorporates feedback between the paradigms representing a continuous input exchange. The interfaced class, on the other hand, consists of non-sequential execution of paradigms that combine their independent results to form the model outcome without influencing each other. Hybrid SD-ABM architectures have found use in modelling complex systems across diverse range of application areas such as health care, supply chains, environment, and ecology.

3. Model Construction

This section details the components of the enterprise system, identifies the scope and characteristics of each module that helps the modeler determine suitable technique for model specification, discusses the model integration approach, validation and results.

Figure 2 depicts the conceptual model of an organizational structure. An organization operates in different geographies that are decomposed hierarchically. An organization is composed of multiple business units that execute multiple projects from various offices belonging to branches spread across geographies. Employee is based out of one of the offices. Employees and dependents represent an organization family residing in a household in the corresponding geographical location.

The overall ecosystem can be characterized as combination of systems that influence infection spread among organization's employees. Employee exposure to infection, as illustrated in Figure 4, is determined by individual employee movement behavior within the bounded ecosystem (household + office) and aggregated societal behavior at the geographical population level (society). These in turn, are highly influenced by regulatory framework (restrictions within

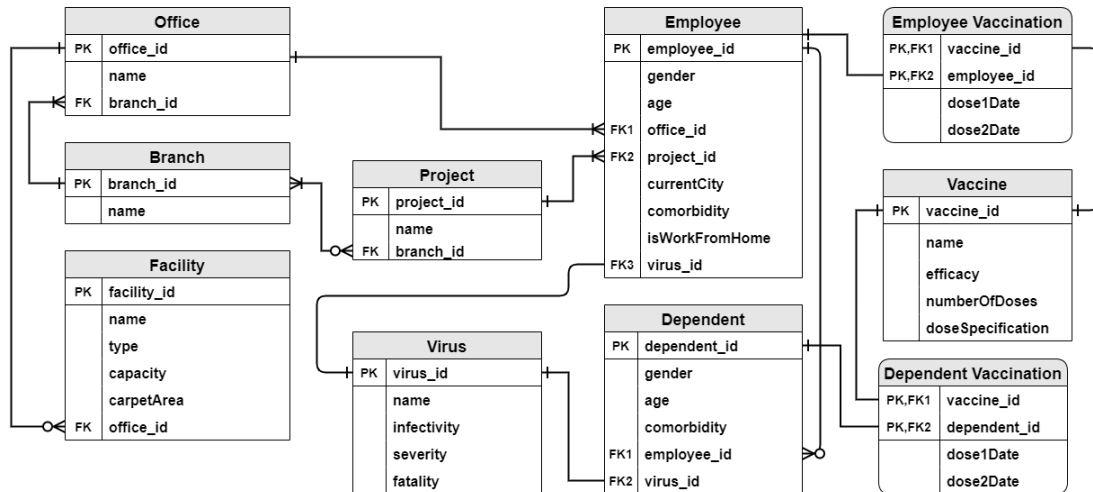

Figure 3: Enterprise Specific Input Data Model

office movement/lock downs in society) and virus characteristics (prevalence of different mutants with varying infectivity). The spread of employees across distinct geographies adds further complexity as each geography has different seroprevalence levels, different rates of infection spread and medical infrastructure that needs to be modelled. The system is decomposed into 4 interacting sub-systems. 1. Infection model 2. Employee model 3. Office Infrastructure model and 4. Society model. The purpose, scope, granularity associated with each of the individual components of the model along with details about experimental factors (levers/configurations), assumptions, and choice of modelling is elucidated in subsequent subsections. This resultant conceptual model forms a basis for developing a simulatable computer model that serves as an aid to decision making within the specified context. Figure 3 outlines the schematic of the enterprise specific Input data model. Output data model constitutes infections trends (Active, Cumulative, Daily) within employees and dependents at various places (E.g. infection from home, office, and society induced infections, respectively). Traversing the employee relationship structure helps to understand the infection trends at various levels (such as office, transport, project, business unit, branch, geography, and so on).

3.1. Infection Model

Susceptible-Exposed-Infectious-Removed (SEIR) model [26] is a well-known epidemic model to predict the dynamics of infectious disease. Broadly, an epidemiological SEIR model represents the following sequential phases of infection in a population: Susceptible (S), Exposed (E), Infectious (I), and Removed (R). Multiple variations of SEIR models exist in literature that account for factors such as birth, death, loss of immunity, vaccination, and reinfection and are usually applied on population scale. Our approach captures the epidemiological spread characteristics and evaluates its effect 1. On employees at the individual level using ABM to account for the individual demographic, health and vaccination factors that can significantly alter the infection progression of a person (employee/dependent), and 2. On the population

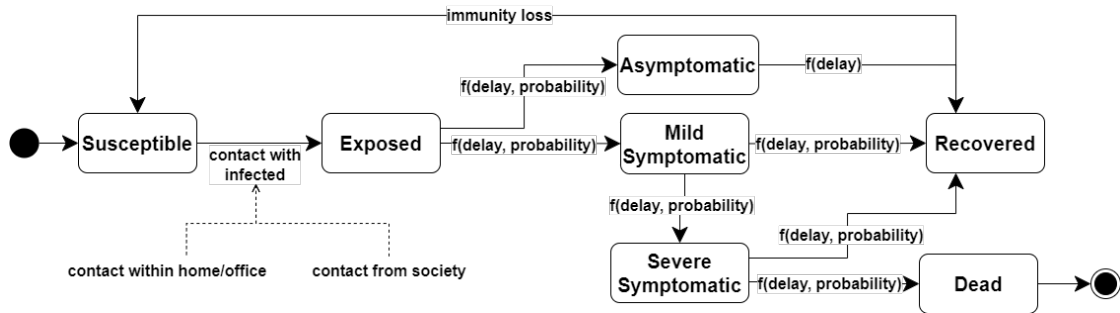

Figure 4: Infection Model

scale using SD to model societal transmission and thus factor its effect on the employee. This section details the treatment of SEIR at an individual context modelled using ABM. Infection model considerations at the population level is covered further in detail in section 3.4.

The ABM Infection Model represents the infection progression in employees and dependents, accounting for the following infection states - *Susceptible (S)*, *Exposed (E)*, *Asymptomatic (AI)*, *Mild Symptomatic (MI)*, *Severe Symptomatic (SI)*, *Recovered (R)*, *Dead (D)*. As depicted in the figure 4, the transition from S to E is the result of combination of 1. Infection incurred through contacts from society - represented by $s2e$ (Susceptible to Exposed) rate, which is the probability that a susceptible person in a given geography gets exposed to virus on a given day. This is resultant of aggregated dynamics at a geography level within the society model explained in detail in section 3.4. 2. Contact through behavioral interactions within household and employee specific interactions with other employees within the office and transport, all of which are obtained from the employee and the office model (section 3.2, 3.3). Remainder of the transitions barring R to S depend on well-established state transition probability model which includes individual demographic (age, gender), and health characteristics (immunization status, comorbidity - diabetes, hypertension, chronic obstructive pulmonary disease (COPD)) from the Employee model, virus characteristics (infectivity, severity and fatality, vaccination bypass probability, recovery period, incubation period, transition probability between various states and the associated delays) of all variants of interests and Vaccine type administered. Table 1 of [6] can be referred for detailed information of the same. Individuals with different co-morbidity, vaccination and demographic values respond to virus differently. R to S transition is simply determined by the likelihood of reinfection and a specified time delay.

The resulting model indicates the infection state of an employee or dependent at any given time. Employee's infection state further influences their office and home movement behaviors within the employee model as they transmit infection during the incubation period and self-isolate upon infection. ABM is the obvious choice for modelling this phenomenon as it best models the micro-level individualistic characteristics and behavior. In the absence of comorbidity information, country-specific age group-gender specific comorbidity distributions are considered.

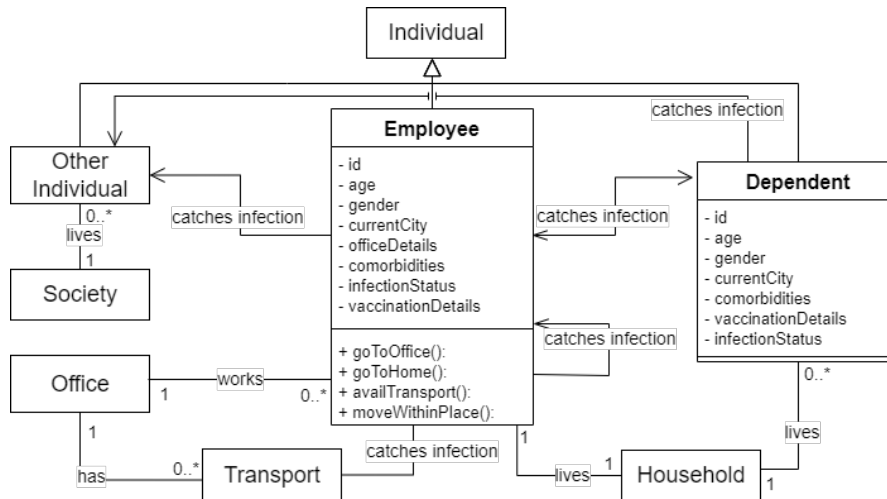

Figure 5: Employee Model

3.2. Employee Model

The Employee model (Figure 5) represents the individual characteristics and behavior of the employee which includes movement and interaction in a bounded environment (office, home) over the course of the day. This estimates the impact of infection on the employee and helps to suitably plan the business continuity to account for the absence. Employees and their dependents are modelled as agents with distinct demographic and health profile residing in a prototypical household in the geography of the office location. State of each anonymized employee include demographic information (age, gender, city), project details (operating unit, business unit, branch), office details (building, seat), health profile/comorbidity (hypertension, diabetic, COPD and no history), infection state (S, E, AI, MI, SI, R and D), vaccination information (vaccine type, date of vaccination, vaccination status - not vaccinated, partially vaccinated, fully vaccinated), current location information (home, office, office transport (bus, cab)/private transport). The dependent state comprises of demographic characteristics, health profile, vaccination details and infection status. Employee vaccination is included in the model and vaccination rate follows the city vaccination rate.

On an average day, an employee interacts with 1. Dependents within the household 2. Other employees within the office premises and during work commute in office provided transport 3. Other individuals in society outside work hours. These interactions serve as avenues for employee infections. Of all the 3 kinds of employee interactions listed, only the household and office interactions are modelled at the individual level. The approximated effect of societal interactions is estimated using an aggregated society model (section 3.4). Determining the consequence of infrastructure policy interventions on an individual employee level establishes the need for an intricately detailed model of the employee interactions in the office, transport and in the household environment (as employees who get infected in household spreads infection in office). In the presence of detailed information and while the model does not result in computational overhead, ABM is a logical choice for representing diverse range of individualistic

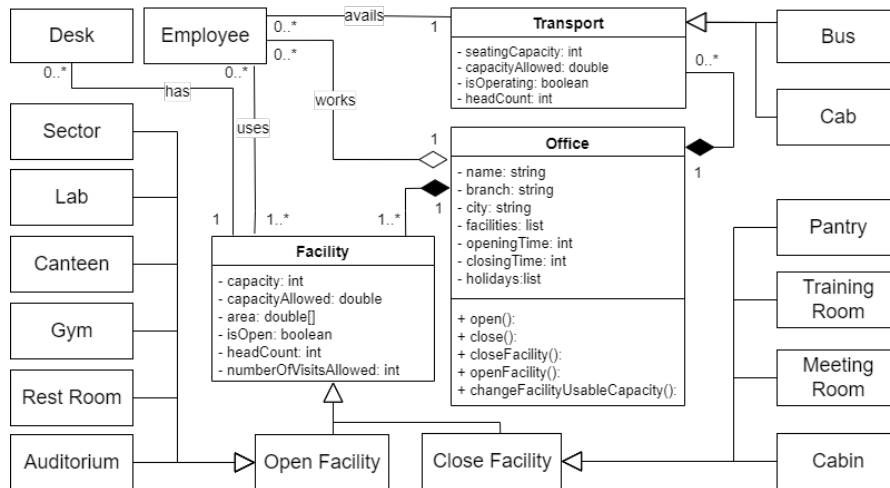

Figure 6: Office Model

characteristics and behaviors and allows for encoding various influences on the individual level.

On a given day, employee visits office basis eligibility constraints (e.g., fully vaccinated, partially vaccinated, age group, should not be currently infected and so on). Timed behavior, such as going to and leaving the office is modelled as a fixed routine-based movement, while movement within the office and at home is modelled as random movement. Within the office, employees move in close proximity to their desks in addition to utilizing various infrastructure facilities described in section 3.3. The probability that the employee utilizes a facility at a given time during office hours is a function of - hourly probability of employee visiting that facility, the facility’s current operating capacity vs. the allowed operating capacity, and the visit frequency allowed vs. number of visits made during the day. All these movements result in contact with other employees. Infection within a place is sampled based on carpet area, susceptible and infected head count in that place. This sampling provides the expected count of infections that can occur within the specific duration, and the employees are appropriately infected. Infection in an open place is modelled distinct to that of closed places as movement within open places is mostly localized regardless of the carpet area, and infection does not depend on overall population density but only on contact with a subset of employees. Additionally, employees interact with household members outside office hours. Contact dynamics within household and transport are modelled similar to that of a closed facility.

3.3. Office Model

The office model captures a detailed representation of the office infrastructure as outlined in Figure 6 using ABM to allow for policy-oriented what-if scenario analysis. Coupling this model with infection and employee models helps analyzing office induced employee infection patterns under varying infrastructural configurations. Office is a physical entity characterized by operating hours (opening and closing time), workdays, location details (city, branch) and is composed of various facilities categorized as Open (characterized by large carpet areas) and

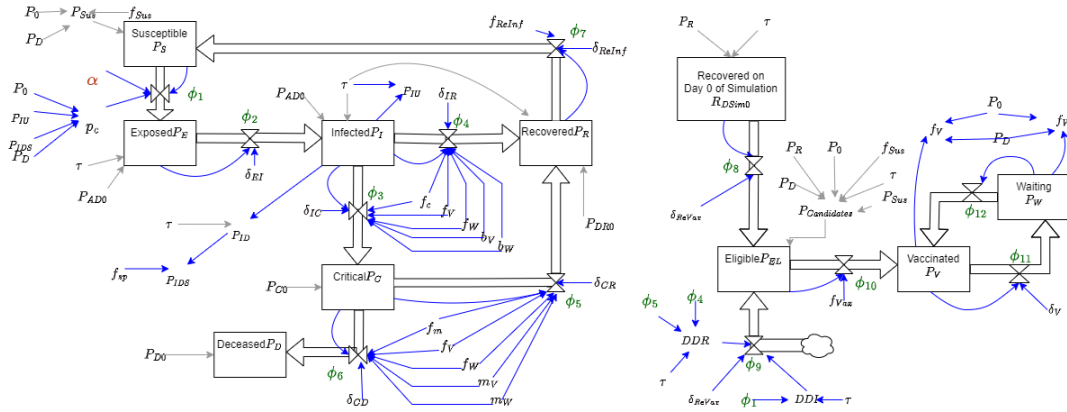

Figure 7: Society Model

Closed facilities. Each facility is characterized by seating capacity, carpet area, allowed capacity, current occupancy and number of visits allowed per employee. Sector, Lab, Canteen, Gym, Rest Room, Auditorium constitutes open facility whereas Pantry, Training Room, Meeting Room, and Cabins are closed facilities. The facilities are equipped with a safe desk layout to ensure social distancing.

These facilities are utilized by the employees at varying times and with varying frequency bounded by the imposed infrastructural constraints (capacity restrictions, visit frequency allowed, and open/close patterns) resulting in varying infection spread. The structural decisions imposed on this model effects the employee behavior patterns and influence the overall system's behavior. The count of office-induced infections is affected by several policy-oriented configurable factors including 1. Percentage of workers doing WFO on any given day based on office capacity restrictions and employee eligibility to go to work 2. Infrastructural layout (safe desk layout), and 3. Workplace facility use policy (restraining allowed occupancy, operational hours, and visit frequency) and ABM is an ideal choice for detailed representation of multiple such offices. Different infection trends emerge when few places are closed or operate with limited capacity. The hierarchical decomposition of the infrastructure helps in the trend analysis of office induced infections starting from a particular instance of any facility of an office up until the organizational level. The dynamics are computed on an hourly basis to understand the infection spread within office premises. Office infrastructure also includes transportation - Cab and Bus characterized by total seating capacity, capacity allowed, current capacity and is availed by a portion of employees for office commute.

3.4. Society Model

The goal of modelling the society is to analyze the employee and dependent infections induced by societal interactions. Although modelling the entire society/geography in a bottom-up manner using ABM is a possibility; however, micro-level modelling of societal interactions and infection dynamics at the geographical scale is infeasible due to 1. Unavailability of data - model construction requires detailed demographic, health details, and the complete nature

of interactions of the entire population as highlighted in section 3.1, which is impossible to obtain. 2. Computationally expensive to scale such models in the presence of large number of geographies. Furthermore, the micro-level behavior of individuals within a society is out of scope of analysis and simplifying the model to capture aggregated behavior does not compromise overall model accuracy as long as the effects of aggregation are appropriately factored in the overall model. These factors narrow down the model's purpose to capturing citizen's virus exposure probability as a result of exposure rate of a given geography/current rate at which the locality is exposed to virus represented using Susceptible to Exposed ($s2e$) rate, which is then fed into the ABM model as depicted in figure 4 (contact from society)

Figure 7 depicts a configurable stock and flow model representing the proposed aggregated society model. It is a modified version of the classic SEIR model introduced in section 3.1 while including the effects of vaccination. Six sequential cohorts - *Susceptible* (P_S), *Exposed* (P_E), *Infected* (P_I), *Critical* (P_C), *Recovered* (P_R) and *Deceased* (P_D) represents the infection phases, and an additional feedback loop from Recovered to Susceptible represents loss of immunity and possibility of reinfection. Cohorts are represented using Stocks, and aggregated population movement from one cohort to another is represented using Flows (indicated with ϕ_i). Flows are governed by a set of factors, which are represented as auxiliary variables, and time delays (indicated using δ_i). Transition of individuals among these states depends on factors including, but not limited to probability of contact with other infected individuals, transmission probability, and virus characteristics like incubation period, infectivity rate, recovery rate, fatality rate, reinfection rate, reduction in critical and fatality rates post vaccination, and transition delays. The flows ϕ_3 (P_I to P_C), ϕ_4 (P_I to P_R), ϕ_5 (P_C to P_R), ϕ_6 (P_C to P_D) depend on vaccine adoption and vaccine efficacy. The concepts of vaccine (and booster dose) adoption and its impact on infection dynamics is comprehended using another simplistic interconnected stock and model containing three stocks: *Eligible* (P_{EL}), *Vaccinated* (P_V) and population who are *Waiting* (P_W) for the next dose. This model infers the proportion of population in a geography that - a) is vaccinated recently and possibly has high vaccine induced immunity (f_v) and b) was vaccinated long back and possibly has less vaccine induced immunity (f_w). These values in turn, are utilized by the infection model. p_c is the probability of coming in contact with infected people (the ratio of infected people contributing to infection spread, to the total living population) and parameter α is a multiplier we use to tune this probability. Components of the proposed stock and flow model are described in detail in [27].

The model is first contextualized using available infection data (including, but not limited to, locality specific net initial population (P_0), reported critical cases (P_{C0}), reported deceased count (P_{D0}), detected active cases (P_{AD0}), detected recoveries (P_{DR0}), and tentative susceptible percentage (f_{Sus}) obtained by querying public databases, census records, government dashboards, authentic media bulletins, and published sero-prevalence surveys. We then estimate parameter α by simulating the model with different α values and comparing simulated trends of detected infected cases (P_I), detected recovered cases (P_R), critical cases (P_C) and number of deceased (P_D) with the actual trends. α is adjusted for prospective future scenarios, such as best case scenario, scenario for complete movement relaxation, emergence of new variant with higher infectivity than known variants. Finally, the $s2e$ rates are computed for all possible scenarios using $s2e$ equation : $s2e = \alpha \times p_c$. This process is repeated for all the geographies of interest and the combined $s2e$ data is then introduced into the ABM to account for the society

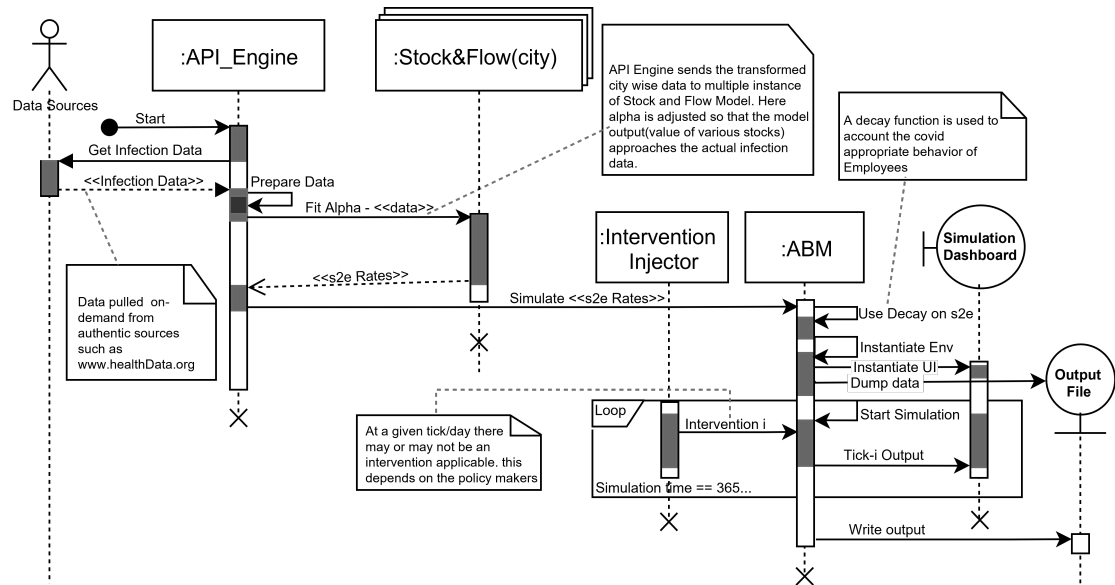

Figure 8: Sequence Diagram of Hybrid Conceptual Model

induced employee infection as indicated in figure 4, and the infection progression follows the process described in the section 3.1.

3.5. Model Integration

Different classes of hybrid architectures were explored in Section 2.3. The proposed approach (Figure 8) adopts a sequential mode since there is no bi-directional interaction between SD and ABM models and it is sufficient to model the aggregated societal infection dynamics independently using SD and communicate its output to the fine-grained ABM model by establishing a single point of data exchange between the two models.

Initially the society module that is external to the ABM is modelled using Stock and Flow. Aggregated infection statistics from various authentic sources as indicated in 3.4 are extracted and transformed using an automated process. Multiple instances of SD model are then run, one for each geography of interest over a configured time-period. The combined results of all the individual instances are collectively utilized by the ABM as input parameters. Prior to doing so, a transformation/decay function is used to account for the impedance mismatch (if it exists) which is the difference in the movement pattern adopted by categories of employees to safeguard themselves during an infection surge in the society. For example, in the case of IT (Information Technology) enterprises where the job profiles do not demand high movement behavior, this safe/reduced movement pattern follows exponential growth to peak infections, followed by exponential decay. The office, employee, dependent, and the infection modules are modelled using ABM and appropriate interventions are introduced using Intervention Injector to evaluate the impact of various candidate interventions. The ABM is then run, taking as input the enterprise specific employee and infrastructural data represented in figure 3, contextual/domain

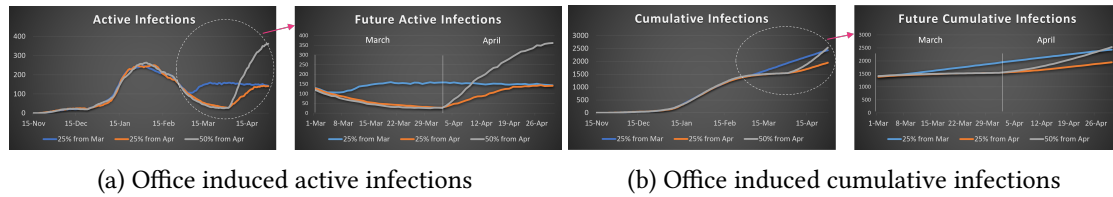

Figure 9: Results

data (virus and vaccine characteristics), intervention parameters along with the output of the impedance mismatch function. The output of the ABM represents the final output of the hybrid model. Various KPIs (Key Performance Indicators) displayed during the simulation using simulation dashboard are then stored into file/database for any further analysis.

3.6. Validation and Results

The proposed approach is validated on a large organization (425K+ employees living with 600K+ registered dependents) with multiple offices spanning multiple geographies (140+ offices across 30+ branches) by running the simulation model with enterprise-specific data (anonymized employee, dependent, and office infrastructure details). History of previous infections served as validation data. The simulation is configured to run over a time period in the past (January to June 2021) for which actual reported data is available, and the simulation results are compared to establish the operational validity of the model. Following validation, several experiments with varying scenarios were carried out to better understand the future infection risk of employees and dependents, thereby impact on the project delivery from opening of offices under varying interventions. Figure 9 depicts the infection trends of a few selected optimistic scenarios under various office operating capacities (25%, 50%) and transition timelines (March, April 2022) with similar micro-level interventions (canteen and medium to large meeting room operating capacities are set to 50%, labs are fully open, and the rest of the facilities remain closed). Figure 9a depicts active office-induced employee infections, Figure 9b shows cumulative infections. While there is a possibility of significant rise in office induced infections with 50% occupancy, this sudden rise is rather miniscule in absolute numbers.

4. Conclusion

As decision-makers devise post-pandemic workplace strategies, it is critical to appropriately model the influencing dimensions of the enterprise ecosystem for evaluating the impact of the candidate strategies on employee infections and project timelines. Complexities arise from the varying nature of the sub-systems in terms of scale, characteristics, level of granularity, uncertainties, and data availability. Given the multi-granular nature of the system, traditional, single-methodology simulation approaches pose significant challenges necessitating the use of integrated modelling approaches to overcome the limitations of the individual modelling paradigms. We presented one such approach that combines SD and ABM, explained the rationale of the modelling choices, illustrated the model building process, and presented a sequential

approach of model integration. The discussed approach modelled the aggregated structures from a societal perspective and finely detailed structure of characteristics and behavior as hierarchical decomposition structures from enterprise perspective. This approach overcomes the issues of data availability and scale while still allowing for a more explicit representation of the system and supports strategy evaluation to enable decision making under uncertainty within continually changing pandemic landscape. Our future work includes modelling and simulating complex domains like sustainability, incorporating other classes of SD-ABM integration, and integrating other kinds of modelling techniques.

References

- [1] B. Boland, A. De Smet, R. Palter, A. Sanghvi, Reimagining the office and work life after covid-19 (2020).
- [2] C. S. Currie, J. W. Fowler, K. Kotiadis, T. Monks, B. S. Onggo, D. A. Robertson, A. A. Tako, How simulation modelling can help reduce the impact of covid-19, *Journal of Simulation* 14 (2020) 83–97.
- [3] J. C. Clement, V. Ponnusamy, K. Sriharipriya, R. Nandakumar, A survey on mathematical, machine learning and deep learning models for covid-19 transmission and diagnosis, *IEEE reviews in biomedical engineering* 15 (2021) 325–340.
- [4] G. Massonis, J. R. Banga, A. F. Villaverde, Structural identifiability and observability of compartmental models of the covid-19 pandemic, *Annual reviews in control* 51 (2021) 441–459.
- [5] W. Naudé, Artificial intelligence against covid-19: An early review (2020).
- [6] S. Barat, R. Parchure, S. Darak, V. Kulkarni, A. Paranjape, M. Gajrani, A. Yadav, An agent-based digital twin for exploring localized non-pharmaceutical interventions to control covid-19 pandemic, *Transactions of the Indian National Academy of Engineering* 6 (2021) 323–353.
- [7] S. L. Chang, N. Harding, C. Zachreson, O. M. Cliff, M. Prokopenko, Modelling transmission and control of the covid-19 pandemic in australia, *Nature communications* 11 (2020) 1–13.
- [8] P. C. Silva, P. V. Batista, H. S. Lima, M. A. Alves, F. G. Guimarães, R. C. Silva, Covid-abs: An agent-based model of covid-19 epidemic to simulate health and economic effects of social distancing interventions, *Chaos, Solitons & Fractals* 139 (2020) 110088.
- [9] C. C. Kerr, R. M. Stuart, D. Mistry, R. G. Abey Suriya, K. Rosenfeld, G. R. Hart, R. C. Núñez, J. A. Cohen, P. Selvaraj, B. Hagedorn, et al., Covasim: an agent-based model of covid-19 dynamics and interventions, *PLOS Computational Biology* 17 (2021) e1009149.
- [10] G. V. Bobashev, D. M. Goedecke, F. Yu, J. M. Epstein, A hybrid epidemic model: combining the advantages of agent-based and equation-based approaches, in: 2007 winter simulation conference, IEEE, 2007, pp. 1532–1537.
- [11] A. Mokhtari, C. Mineo, J. Kriseman, P. Kremer, L. Neal, J. Larson, A multi-method approach to modeling covid-19 disease dynamics in the united states, *Scientific reports* 11 (2021) 1–16.
- [12] S. Vecherin, D. Chang, E. Wells, B. Trump, A. Meyer, J. Desmond, K. Dunn, M. Kitsak, I. Linkov, Assessment of the covid-19 infection risk at a workplace through stochastic

microexposure modeling, *Journal of exposure science & environmental epidemiology* (2022) 1–8.

- [13] E. Cuevas, An agent-based model to evaluate the covid-19 transmission risks in facilities, *Computers in biology and medicine* 121 (2020) 103827.
- [14] C. Lynch, J. Padilla, S. Diallo, J. Sokolowski, C. Banks, A multi-paradigm modeling framework for modeling and simulating problem situations, in: *Proceedings of the Winter Simulation Conference 2014, IEEE, 2014*, pp. 1688–1699.
- [15] S. Robinson, Conceptual modelling for simulation part i: definition and requirements, *Journal of the operational research society* 59 (2008) 278–290.
- [16] H. J. Scholl, Agent-based and system dynamics modeling: a call for cross study and joint research, in: *Proceedings of the 34th annual Hawaii international conference on system sciences, IEEE, 2001*, pp. 8–pp.
- [17] E. Bonabeau, Agent-based modeling: Methods and techniques for simulating human systems, *Proceedings of the national academy of sciences* 99 (2002) 7280–7287.
- [18] J. W. Forrester, Industrial dynamics. a major breakthrough for decision makers, *Harvard business review* 36 (1958) 37–66.
- [19] J. Sterman, *Business dynamics*, Irwin/McGraw-Hill c2000., 2010.
- [20] A. T. Azar, System dynamics as a useful technique for complex systems, *International Journal of Industrial and Systems Engineering* 10 (2012) 377–410.
- [21] C. Swinerd, K. R. McNaught, Design classes for hybrid simulations involving agent-based and system dynamics models, *Simulation Modelling Practice and Theory* 25 (2012) 118–133.
- [22] L. Lättilä, P. Hilletoft, B. Lin, Hybrid simulation models—when, why, how?, *Expert systems with applications* 37 (2010) 7969–7975.
- [23] L. K. N. Nguyen, S. Howick, I. Megiddo, A hybrid simulation modelling framework for combining system dynamics and agent-based models, in: *Operational Research Society Simulation Workshop 2020, 2020*, pp. 385–394.
- [24] C. Guerrero, P. Schwarz, J. H. Slinger, A recent overview of the integration of system dynamics and agent-based modelling and simulation, in: *System Dynamics Conference, 2016*, pp. 1–13.
- [25] J. G. Shanthikumar, R. G. Sargent, A unifying view of hybrid simulation/analytic models and modeling, *Operations research* 31 (1983) 1030–1052.
- [26] N. T. Bailey, et al., *The mathematical theory of infectious diseases and its applications*, Charles Griffin & Company Ltd, 5a Crendon Street, High Wycombe, Bucks HP13 6LE., 1975.
- [27] S. Barat, D. Mulpuru, A. Yadav, A. Basu, V. Kulkarni, S. Samudrala, A. Bhide, P. Thomas, K. Krishna, A. Yadav, et al., A digital twin based approach for ensuring business continuity plan and safe return to workplace, in: *2022 Annual Modeling and Simulation Conference (ANNSIM), IEEE, 2022*, pp. 126–139.