



Developer Guide

AWS Lambda



AWS Lambda: Developer Guide

Copyright © 2024 Amazon Web Services, Inc. and/or its affiliates. All rights reserved.

Amazon's trademarks and trade dress may not be used in connection with any product or service that is not Amazon's, in any manner that is likely to cause confusion among customers, or in any manner that disparages or discredits Amazon. All other trademarks not owned by Amazon are the property of their respective owners, who may or may not be affiliated with, connected to, or sponsored by Amazon.

Table of Contents

What is AWS Lambda?	1
When to use Lambda	1
Key features	2
Create your first function	4
Prerequisites	4
Create the function	6
Invoke the function	12
Clean up	15
Next steps	16
Key Lambda concepts	18
Basic concepts	19
Lambda functions	19
Lambda execution environment and runtimes	20
Triggers and event source mappings	20
The event object	21
Lambda permissions	22
Programming model	25
Execution environment	27
Runtime environment lifecycle	28
Cold starts and latency	34
Reducing cold starts with Provisioned Concurrency	35
Optimizing static initialization	35
Event-driven architectures	38
Benefits of event-driven architectures	38
Trade-offs of event-driven architectures	41
Anti-patterns in Lambda-based event-driven applications	43
Application design	49
Use services instead of custom code	50
Understand Lambda abstraction levels	51
Implement statelessness in functions	51
Minimize coupling	52
Build for on-demand data instead of batches	52
Consider AWS Step Functions for orchestration	53
Implement idempotency	54

Use multiple AWS accounts for managing quotas	54
Frequently asked questions	56
Example apps	59
Example apps	59
File-processing app	60
Create the source code files	61
Deploy the app	64
Test the app	75
Next steps	82
Scheduled-maintenance app	83
Prerequisites	84
Downloading the example app files	84
Creating and populating the example DynamoDB table	94
Creating the scheduled-maintenance app	97
Testing the app	101
Next steps	102
Infrastructure as code (IaC)	103
IaC tools for Lambda	103
Getting started with IaC for Lambda	104
Prerequisites	105
Create a Lambda function	105
View the AWS SAM template for your function	105
Use AWS Infrastructure Composer to design a serverless application	108
Deploy your serverless application using AWS SAM (optional)	113
Testing your deployed application (optional)	115
Using the AWS CDK	116
Prerequisites	116
Step 1: Set up your project	117
Step 2: Define the stack	118
Step 3: Create the function	122
Step 4: Deploy the stack	123
Step 5: Test the function	125
Step 6: Clean up	126
Next steps	126
Lambda runtimes	127
Supported runtimes	127

New runtime releases	130
Runtime deprecation policy	130
Shared responsibility model	131
Runtime use after deprecation	133
Receiving runtime deprecation notifications	134
Deprecated runtimes	135
Runtime version updates	138
Runtime update modes	139
Two-phase runtime version rollout	140
Configuring runtime management	140
Runtime version roll-back	142
Runtime version updates	143
Shared responsibility model	145
Permissions	147
Get data about functions by runtime	148
Listing function versions that use a particular runtime	148
Identifying most commonly and most recently invoked functions	150
Runtime modifications	155
Language-specific environment variables	155
Wrapper scripts	155
Runtime API	159
Next invocation	159
Invocation response	161
Initialization error	161
Invocation error	163
OS-only runtimes	165
Building a custom runtime	166
Custom runtime tutorial	169
Configuring functions	179
.zip file archives	181
Creating the function	181
Using the console code editor	183
Updating function code	183
Changing the runtime	184
Changing the architecture	184
Using the Lambda API	185

Downloading your function code	185
AWS CloudFormation	186
Encryption	186
Container images	193
Requirements	194
Using an AWS base image	195
Using an AWS OS-only base image	196
Using a non-AWS base image	197
Runtime interface clients	197
Amazon ECR permissions	198
Function lifecycle	200
Memory	202
When to increase memory	202
Using the console	203
Using the AWS CLI	203
Using AWS SAM	204
Accepting function memory recommendations (console)	204
Ephemeral storage	205
Use cases	205
Using the console	206
Using the AWS CLI	206
Using AWS SAM	206
Instruction sets (ARM/x86)	208
Advantages of using arm64 architecture	208
Requirements for migration to arm64 architecture	209
Function code compatibility with arm64 architecture	209
How to migrate to arm64 architecture	209
Configuring the instruction set architecture	210
Timeout	212
When to increase timeout	212
Using the console	212
Using the AWS CLI	213
Using AWS SAM	213
Environment variables	215
Defined runtime environment variables	219
Example scenario for environment variables	221

Securing environment variables	221
Retrieving environment variables	224
Attaching functions to a VPC	226
Required IAM permissions	226
Attaching Lambda functions to an Amazon VPC in your AWS account	228
Internet access when attached to a VPC	232
IPv6 support	232
Best practices for using Lambda with Amazon VPCs	233
Understanding Hyperplane Elastic Network Interfaces (ENIs)	234
Using IAM condition keys for VPC settings	235
VPC tutorials	240
Attaching functions to resources in another account	241
Prerequisites	241
Create an Amazon VPC in your function's account	242
Grant VPC permissions to your function's execution role	242
.....	243
Create a VPC peering connection request	243
Prepare your resource's account	244
Update VPC configuration in your function's account	245
Test your function	246
Internet access for VPC functions	248
Inbound networking	273
Considerations for Lambda interface endpoints	273
Creating an interface endpoint for Lambda	274
Creating an interface endpoint policy for Lambda	275
File system	277
Execution role and user permissions	277
Configuring a file system and access point	278
Connecting to a file system (console)	279
Aliases	280
Using aliases	282
Weighted aliases	283
Versions	288
Creating function versions	289
Using versions	290
Granting permissions	290

Tags	292
Permissions required for working with tags	292
Using tags with the console	292
Using tags with the AWS CLI	294
Response streaming	296
Bandwidth limits for response streaming	297
Writing functions	297
Invoking functions	299
Tutorial: Creating a response streaming function with a function URL	300
Invoking functions	305
Invoke a function synchronously	307
Asynchronous invocation	311
Error handling	312
Configuration	313
Retaining records	315
Event source mappings	324
Event source mappings and triggers	324
Batching behavior	325
Provisioned mode	328
Event source mapping API	329
Event source mapping tags	329
Event filtering	334
Understanding event filtering basics	335
Handling records that don't meet filter criteria	337
Filter rule syntax	338
Attaching filter criteria to an event source mapping (console)	339
Attaching filter criteria to an event source mapping (AWS CLI)	340
Attaching filter criteria to an event source mapping (AWS SAM)	342
Encryption of filter criteria	342
Using filters with different AWS services	348
Testing in console	350
Invoking functions with test events	350
Creating private test events	351
Creating shareable test events	351
Deleting shareable test event schemas	353
Function states	354

Function states while updating	355
Retries	357
Recursive loop detection	359
Understanding recursive loop detection	359
Supported AWS services and SDKs	361
Recursive loop notifications	363
Responding to recursive loop detection notifications	364
Allowing a Lambda function to run in a recursive loop	365
Supported regions for Lambda recursive loop detection	367
Function URLs	369
Creating a function URL (console)	370
Creating a function URL (AWS CLI)	372
Adding a function URL to a CloudFormation template	373
Cross-origin resource sharing (CORS)	374
Throttling function URLs	376
Deactivating function URLs	376
Deleting function URLs	376
Access control	377
Invoking function URLs	385
Monitoring function URLs	397
Function URLs vs Amazon API Gateway	398
Tutorial: Creating a webhook endpoint	404
Function scaling	418
Understanding and visualizing concurrency	418
Calculating concurrency for a function	423
Understanding reserved concurrency and provisioned concurrency	424
Reserved concurrency	425
Provisioned concurrency	427
How Lambda allocates provisioned concurrency	431
Comparing reserved concurrency and provisioned concurrency	432
Understanding concurrency and requests per second	433
Concurrency quotas	434
Configuring reserved concurrency	437
Configuring reserved concurrency	438
Accurately estimating required reserved concurrency for a function	439
Configuring provisioned concurrency	441

Configuring provisioned concurrency	442
Accurately estimating required provisioned concurrency for a function	444
Optimizing function code when using provisioned concurrency	445
Using environment variables to view and control provisioned concurrency behavior	445
Understanding logging and billing behavior with provisioned concurrency	446
Using Application Auto Scaling to automate provisioned concurrency management	447
Scaling behavior	451
Concurrency scaling rate	451
Monitoring concurrency	453
General concurrency metrics	453
Provisioned concurrency metrics	453
Working with the <code>ClaimedAccountConcurrency</code> metric	456
Building with Node.js	459
Node.js initialization	461
Designating a function handler as an ES module	461
Runtime-included SDK versions	462
Using keep-alive	462
CA certificate loading	462
Handler	464
Node.js handler basics	464
Naming	465
Using <code>async/await</code>	466
Using callbacks	468
Code best practices for Node.js Lambda functions	471
Deploy .zip file archives	473
Runtime dependencies in Node.js	473
Creating a .zip deployment package with no dependencies	474
Creating a .zip deployment package with dependencies	474
Creating a Node.js layer for your dependencies	475
Dependency search path and runtime-included libraries	476
Creating and updating Node.js Lambda functions using .zip files	477
Deploy container images	484
AWS base images for Node.js	485
Using an AWS base image	486
Using a non-AWS base image	492
Layers	502

Prerequisites	502
Node.js layer compatibility with the Lambda runtime environment	503
Layer paths for Node.js runtimes	503
Packaging the layer content	504
Creating the layer	506
Adding the layer to your function	506
Context	510
Logging	512
Creating a function that returns logs	512
Using Lambda advanced logging controls with Node.js	514
Viewing logs in the Lambda console	520
Viewing logs in the CloudWatch console	520
Viewing logs using the AWS Command Line Interface (AWS CLI)	521
Deleting logs	524
Tracing	525
Using ADOT to instrument your Node.js functions	526
Using the X-Ray SDK to instrument your Node.js functions	526
Activating tracing with the Lambda console	527
Activating tracing with the Lambda API	528
Activating tracing with AWS CloudFormation	528
Interpreting an X-Ray trace	529
Storing runtime dependencies in a layer (X-Ray SDK)	531
Building with TypeScript	533
Development environment	534
Handler	536
Typescript handler basics	536
Using async/await	537
Using callbacks	538
Using types for the event object	539
Code best practices for Typescript Lambda functions	541
Deploy .zip file archives	543
Using AWS SAM	543
Using the AWS CDK	545
Using the AWS CLI and esbuild	548
Deploy container images	551
Using a Node.js base image to build and package TypeScript function code	551

Layers	559
Prerequisites	559
Node.js layer compatibility with the Lambda runtime environment	560
Layer paths for Node.js runtimes	560
Packaging the layer content	561
Creating the layer	563
Adding the layer to your function	563
Context	567
Logging	569
Tools and libraries	569
Using Powertools for AWS Lambda (TypeScript) and AWS SAM for structured logging	570
Using Powertools for AWS Lambda (TypeScript) and the AWS CDK for structured logging	572
Viewing logs in the Lambda console	576
Viewing logs in the CloudWatch console	576
Tracing	578
Using Powertools for AWS Lambda (TypeScript) and AWS SAM for tracing	579
Using Powertools for AWS Lambda (TypeScript) and the AWS CDK for tracing	581
Interpreting an X-Ray trace	585
Building with Python	586
Runtime-included SDK versions	587
Experimental features in Python 3.13	588
Response format	588
Graceful shutdown for extensions	588
Handler	590
Naming	590
How it works	591
Returning a value	591
Examples	592
Code best practices for Python Lambda functions	594
Deploy .zip file archives	597
Runtime dependencies in Python	597
Creating a .zip deployment package with no dependencies	598
Creating a .zip deployment package with dependencies	598
Dependency search path and runtime-included libraries	601
Using <code>__pycache__</code> folders	603

Creating .zip deployment packages with native libraries	603
Creating and updating Python Lambda functions using .zip files	604
Deploy container images	612
AWS base images for Python	613
Using an AWS base image	614
Using a non-AWS base image	621
Layers	631
Prerequisites	631
Python layer compatibility with Amazon Linux	632
Layer paths for Python runtimes	633
Packaging the layer content	633
Creating the layer	635
Adding the layer to your function	635
Working with manylinux wheel distributions	638
Context	642
Logging	644
Printing to the log	644
Using a logging library	645
Using Lambda advanced logging controls with Python	647
Viewing logs in Lambda console	651
Viewing logs in CloudWatch console	652
Viewing logs with AWS CLI	652
Deleting logs	655
Tools and libraries	655
Using Powertools for AWS Lambda (Python) and AWS SAM for structured logging	656
Using Powertools for AWS Lambda (Python) and AWS CDK for structured logging	660
Testing	667
Testing your serverless applications	668
Tracing	670
Using Powertools for AWS Lambda (Python) and AWS SAM for tracing	671
Using Powertools for AWS Lambda (Python) and the AWS CDK for tracing	673
Using ADOT to instrument your Python functions	678
Using the X-Ray SDK to instrument your Python functions	679
Activating tracing with the Lambda console	680
Activating tracing with the Lambda API	680
Activating tracing with AWS CloudFormation	680

Interpreting an X-Ray trace	681
Storing runtime dependencies in a layer (X-Ray SDK)	684
Building with Ruby	686
Runtime-included SDK versions	687
Enabling Yet Another Ruby JIT (YJIT)	688
Handler	689
Ruby handler basics	689
Code best practices for Ruby Lambda functions	690
Deploy .zip file archives	693
Dependencies in Ruby	693
Creating a .zip deployment package with no dependencies	694
Creating a .zip deployment package with dependencies	694
Creating a Ruby layer for your dependencies	696
Creating .zip deployment packages with native libraries	696
Creating and updating Ruby Lambda functions using .zip files	698
Deploy container images	705
AWS base images for Ruby	706
Using an AWS base image	706
Using a non-AWS base image	713
Layers	723
Prerequisites	723
Ruby layer compatibility with the Lambda runtime environment	724
Layer paths for Ruby runtimes	724
Packaging the layer content	725
Creating the layer	727
Adding the layer to your function	727
Context	730
Logging	731
Creating a function that returns logs	731
Viewing logs in the Lambda console	732
Viewing logs in the CloudWatch console	733
Viewing logs using the AWS Command Line Interface (AWS CLI)	733
Deleting logs	736
Working with the Ruby logger library	736
Tracing	738
Enabling active tracing with the Lambda API	743

Enabling active tracing with AWS CloudFormation	744
Storing runtime dependencies in a layer	744
Building with Java	746
Handler	749
Example handler: Java 17 runtimes	749
Example handler: Java 11 runtimes and below	751
Initialization code	752
Choosing input and output types	753
Handler interfaces	754
Code best practices for Java Lambda functions	756
Sample handler code	758
Deploy .zip file archives	760
Prerequisites	760
Tools and libraries	760
Building a deployment package with Gradle	762
Creating a Java layer for your dependencies	763
Building a deployment package with Maven	764
Uploading a deployment package with the Lambda console	766
Uploading a deployment package with the AWS CLI	768
Uploading a deployment package with AWS SAM	769
Deploy container images	772
AWS base images for Java	773
Using an AWS base image	774
Using a non-AWS base image	783
Layers	794
Prerequisites	794
Java layer compatibility with Amazon Linux	795
Layer paths for Java runtimes	795
Packaging the layer content	796
Creating the layer	798
Adding the layer to your function	798
Custom serialization	803
When to use custom serialization	803
Implementing custom serialization	804
Testing custom serialization	805
Custom startup behavior	806

Understanding the JAVA_TOOL_OPTIONS environment variable	806
Context	809
Context in sample applications	811
Logging	813
Creating a function that returns logs	813
Using Lambda advanced logging controls with Java	815
Implementing advanced logging with Log4j2 and SLF4J	818
Tools and libraries	821
Using Powertools for AWS Lambda (Java) and AWS SAM for structured logging	822
Viewing logs in the Lambda console	826
Viewing logs in the CloudWatch console	826
Viewing logs using the AWS Command Line Interface (AWS CLI)	827
Deleting logs	830
Sample logging code	830
Tracing	832
Using Powertools for AWS Lambda (Java) and AWS SAM for tracing	833
Using Powertools for AWS Lambda (Java) and the AWS CDK for tracing	835
Using ADOT to instrument your Java functions	847
Using the X-Ray SDK to instrument your Java functions	847
Activating tracing with the Lambda console	848
Activating tracing with the Lambda API	848
Activating tracing with AWS CloudFormation	849
Interpreting an X-Ray trace	849
Storing runtime dependencies in a layer (X-Ray SDK)	852
X-Ray tracing in sample applications (X-Ray SDK)	853
Sample apps	855
Building with Go	857
Go runtime support	857
Tools and libraries	858
Handler	859
Setting up your Go handler project	859
Example Go Lambda function code	860
Handler naming conventions	863
Defining and accessing the input event object	863
Accessing and using the Lambda context object	864
Valid handler signatures for Go handlers	865

Using the AWS SDK for Go v2 in your handler	866
Accessing environment variables	867
Using global state	867
Code best practices for Go Lambda functions	868
Context	870
Supported variables, methods, and properties in the context object	870
Accessing invoke context information	871
Using the context in AWS SDK client initializations and calls	873
Deploy .zip file archives	874
Creating a .zip file on macOS and Linux	874
Creating a .zip file on Windows	876
Creating and updating Go Lambda functions using .zip files	879
Deploy container images	886
AWS base images for deploying Go functions	886
Go runtime interface client	887
Using an AWS OS-only base image	887
Using a non-AWS base image	894
Layers	903
Logging	904
Creating a function that returns logs	904
Viewing logs in the Lambda console	906
Viewing logs in the CloudWatch console	906
Viewing logs using the AWS Command Line Interface (AWS CLI)	906
Deleting logs	910
Tracing	911
Using ADOT to instrument your Go functions	912
Using the X-Ray SDK to instrument your Go functions	912
Activating tracing with the Lambda console	912
Activating tracing with the Lambda API	913
Activating tracing with AWS CloudFormation	913
Interpreting an X-Ray trace	914
Building with C#	917
Development environment	917
Installing the .NET project templates	917
Installing and updating the CLI tools	917
Handler	919

.NET execution models for Lambda	920
Class library handlers	920
Executable assembly handlers	921
Serialization in Lambda functions	922
Simplify function code with the Lambda Annotations framework	924
Lambda function handler restrictions	927
Code best practices for C# Lambda functions	927
Deployment package	930
NET Lambda Global CLI	931
AWS SAM	937
AWS CDK	940
ASP.NET	944
Deploy container images	949
AWS base images for .NET	950
Using an AWS base image	950
Using a non-AWS base image	953
Native AOT compilation	957
Lambda runtime	957
Prerequisites	958
Getting started	958
Serialization	961
Trimming	962
Troubleshooting	963
Context	964
Logging	966
Creating a function that returns logs	966
Using Lambda advanced logging controls with .NET	967
Tools and libraries	974
Using Powertools for AWS Lambda (.NET) and AWS SAM for structured logging	975
Viewing logs in the Lambda console	978
Viewing logs in the CloudWatch console	978
Viewing logs using the AWS Command Line Interface (AWS CLI)	978
Deleting logs	982
Tracing	983
Using Powertools for AWS Lambda (.NET) and AWS SAM for tracing	984
Using the X-Ray SDK to instrument your .NET functions	987

Activating tracing with the Lambda console	988
Activating tracing with the Lambda API	989
Activating tracing with AWS CloudFormation	989
Interpreting an X-Ray trace	990
Testing	993
Testing your serverless applications	994
Building with PowerShell	997
Development Environment	998
Deployment package	999
Creating a Lambda function	999
Handler	1001
Returning data	1002
Context	1003
Logging	1004
Creating a function that returns logs	1004
Viewing logs in the Lambda console	1006
Viewing logs in the CloudWatch console	1006
Viewing logs using the AWS Command Line Interface (AWS CLI)	1006
Deleting logs	1010
Building with Rust	1011
Handler	1013
Rust handler basics	1013
Using shared state	1014
Code best practices for Rust Lambda functions	1015
Context	1018
Accessing invoke context information	1018
HTTP events	1020
Deploy .zip file archives	1023
Prerequisites	1023
Building the function	1023
Deploying the function	1024
Invoking the function	1026
Logging	1027
Creating a function that writes logs	1027
Implementing advanced logging with the Tracing crate	1027
Best practices	1030

Function code	1030
Function configuration	1031
Function scalability	1033
Metrics and alarms	1033
Working with streams	1034
Security best practices	1035
Testing serverless functions	1036
Targeted business outcomes	1037
What to test	1037
How to test serverless	1038
Testing techniques	1039
Testing in the cloud	1039
Testing with mocks	1042
Testing with emulation	1043
Best practices	1044
Prioritize testing in the cloud	1044
Structure your code for testability	1044
Accelerate development feedback loops	1045
Focus on integration tests	1045
Create isolated test environments	1046
Use mocks for isolated business logic	1047
Use emulators sparingly	1047
Challenges testing locally	1048
Example: Lambda function creates an S3 bucket	1048
Example: Lambda function processes messages from an Amazon SQS queue	1049
FAQ	1049
Next steps and resources	1050
Lambda SnapStart	1052
Use cases	1053
Supported features and limitations	1053
Supported Regions	1054
Compatibility considerations	1054
Pricing	1055
Activating SnapStart	1057
Activating SnapStart (console)	1057
Activating SnapStart (AWS CLI)	1058

Activating SnapStart (API)	1060
Function states	1061
Updating a snapshot	1061
Using SnapStart with AWS SDKs	1061
Using SnapStart with AWS CloudFormation, AWS SAM, and AWS CDK	1062
Deleting snapshots	1062
Handling uniqueness	1063
Avoid saving state	1063
Use CSPRNGs	1065
Scanning tool (Java)	1068
Runtime hooks	1069
Java	1069
Python	1073
.NET	1075
Monitoring	1078
CloudWatch logs	1078
AWS X-Ray	1079
Telemetry API	1079
API Gateway and function URL metrics	1080
Security model	1081
Best practices	1082
Performance tuning	1082
Networking best practices	1086
Troubleshooting	1088
SnapStartNotReadyException	1088
SnapStartTimeoutException	1088
500 Internal Service Error	1089
401 Unauthorized	1089
UnknownHostException (Java)	1089
Snapshot creation failures	1090
Snapshot creation latency	1090
Integrating other services	1091
Creating a trigger	1091
Services list	1092
Apache Kafka	1094
Example event	1095

Configure event source	1096
Process messages	1105
Event filtering	1115
On-failure destinations	1120
Troubleshooting	1127
API Gateway	1130
Choosing an API type	1131
Adding an endpoint to your Lambda function	1132
Proxy integration	1132
Event format	1133
Response format	1133
Permissions	1134
Sample application	1136
Tutorial	1136
Errors	1158
API Gateway vs function URLs	1160
Infrastructure Composer	1164
Exporting a Lambda function to Infrastructure Composer	1165
Other resources	1167
CloudFormation	1168
Amazon DocumentDB	1171
Example Amazon DocumentDB event	1172
Prerequisites and permissions	1173
Configure network security	1174
Creating an Amazon DocumentDB event source mapping (console)	1177
Creating an Amazon DocumentDB event source mapping (SDK or CLI)	1179
Polling and stream starting positions	1182
Monitoring your Amazon DocumentDB event source	1182
Tutorial	1183
DynamoDB	1222
Polling and batching streams	1222
Polling and stream starting positions	1223
Simultaneous readers	1224
Example event	1224
Create mapping	1226
Batch item failures	1228

Error handling	1241
Stateful processing	1247
Parameters	1252
Event filtering	1254
Tutorial	1262
EC2	1279
Granting permissions to EventBridge (CloudWatch Events)	1279
Elastic Load Balancing (Application Load Balancer)	1281
Invoke using an EventBridge Scheduler	1283
Set up the execution role	1283
Create a schedule	1283
Related resources	1288
IoT	1289
Kinesis Data Streams	1291
Polling and batching streams	1291
Example event	1293
Create mapping	1294
Batch item failures	1300
Error handling	1314
Stateful processing	1320
Parameters	1324
Event filtering	1327
Tutorial	1331
Kubernetes	1348
AWS Controllers for Kubernetes (ACK)	1348
Crossplane	1348
MQ	1350
Understanding the Lambda consumer group for Amazon MQ	1352
Configure event source	1356
Parameters	1362
Event filtering	1363
Troubleshoot	1369
MSK	1371
Example event	1372
Configure event source	1373
Process messages	1385

Event filtering	1397
On-failure destinations	1402
Tutorial	1409
RDS	1430
Configuring your function to work with RDS resources	1430
Connecting to an Amazon RDS database in a Lambda function	1433
Processing event notifications from Amazon RDS	1452
Complete Lambda and Amazon RDS tutorial	1453
S3	1454
Tutorial: Use an S3 trigger	1455
Tutorial: Use an Amazon S3 trigger to create thumbnails	1482
SQS	1512
Understanding polling and batching behavior for Amazon SQS event source mappings ..	1512
Example standard queue message event	1513
Example FIFO queue message event	1515
Create mapping	1516
Scaling behavior	1519
Error handling	1521
Parameters	1534
Event filtering	1535
Tutorial	1540
SQS cross-account tutorial	1560
S3 Batch	1567
Invoking Lambda functions from Amazon S3 batch operations	1568
SNS	1570
Adding an Amazon SNS topic trigger for a Lambda function using the console	1570
Manually adding an Amazon SNS topic trigger for a Lambda function	1571
Sample SNS event shape	1572
Tutorial	1573
Lambda permissions	1594
Execution role (permissions for functions to access other resources)	1596
Creating an execution role in the IAM console	1596
Creating and managing roles with the AWS CLI	1597
Grant least privilege access to your Lambda execution role	1599
Update execution role	1599
AWS managed policies	1601

Source function ARN	1604
Access permissions (permissions for other entities to access your functions)	1608
Identity-based policies	1608
Resource-based policies	1614
Attribute-based access control	1623
Resources and Conditions	1630
Security, governance, and compliance	1636
Data protection	1637
Encryption in transit	1638
Encryption at rest	1638
Identity and Access Management	1643
Audience	1644
Authenticating with identities	1644
Managing access using policies	1648
How AWS Lambda works with IAM	1650
Identity-based policy examples	1657
AWS managed policies	1660
Troubleshooting	1665
Governance	1667
Proactive controls with Guard	1669
Proactive controls with AWS Config	1673
Detective controls with AWS Config	1680
Code signing	1684
Code scanning	1687
Observability	1692
Compliance validation	1699
Resilience	1699
Infrastructure security	1700
Securing workloads with public endpoints	1701
Authentication and authorization	1701
Protecting API endpoints	1701
Code signing	1703
Signature validation	1703
Configuring code signing with the Lambda API	1704
Create configuration	1705
Update configuration	1706

Permissions	1707
Code signing configuration tags	1708
Monitoring functions	1712
Pricing	1712
Function metrics	1713
View function metrics	1713
Metric types	1714
Function logs	1722
Required IAM permissions	1722
Pricing	1723
Configure function logs	1723
View function logs	1737
CloudTrail logs	1751
Lambda data events in CloudTrail	1752
Lambda management events in CloudTrail	1754
Using CloudTrail to troubleshoot disabled Lambda event sources	1756
Lambda event examples	1757
AWS X-Ray	1759
Understanding X-Ray traces	1760
Execution role permissions	1764
The AWS X-Ray daemon	1765
Enabling active tracing with the Lambda API	1765
Enabling active tracing with AWS CloudFormation	1765
Function insights	1767
How it works	1767
Pricing	1768
Supported runtimes	1768
Enabling Lambda Insights in the console	1768
Enabling Lambda Insights programmatically	1768
Using the Lambda Insights dashboard	1769
Detecting function anomalies	1770
Troubleshooting a function	1772
What's next?	1774
View application metrics	1775
Application Signals	1777
How Application Signals integrates with Lambda	1777

Pricing	1778
Supported runtimes	1778
Enabling Application Signals in the Lambda console	1778
Using the Application Signals dashboard	1779
Lambda layers	1781
How to use layers	1783
Layers and layer versions	1783
Packaging layers	1784
Layer paths for each Lambda runtime	1784
Creating and deleting layers	1788
Creating a layer	1788
Deleting a layer version	1790
Adding layers	1791
Accessing layer content from your function	1793
Finding layer information	1793
Layers with AWS CloudFormation	1796
Layers with AWS SAM	1797
Lambda extensions	1798
Execution environment	1799
Impact on performance and resources	1800
Permissions	1800
Configuring extensions	1801
Configuring extensions (.zip file archive)	1801
Using extensions in container images	1801
Next steps	1802
Extensions partners	1803
AWS managed extensions	1804
Extensions API	1805
Lambda execution environment lifecycle	1806
Extensions API reference	1815
Telemetry API	1821
Creating extensions using the Telemetry API	1822
Registering your extension	1824
Creating a telemetry listener	1824
Specifying a destination protocol	1826
Configuring memory usage and buffering	1827

Sending a subscription request to the Telemetry API	1828
Inbound Telemetry API messages	1829
API reference	1833
Event schema reference	1837
Converting events to OTel Spans	1858
Logs API	1864
Troubleshooting	1877
Configuration	1877
Memory configurations	1878
CPU-bound configurations	1878
Timeouts	1878
Memory leakage between invocations	1879
Asynchronous results returned to a later invocation	1882
Deployment	1886
General: Permission is denied / Cannot load such file	1887
General: Error occurs when calling the UpdateFunctionCode	1888
Amazon S3: Error Code PermanentRedirect.	1888
General: Cannot find, cannot load, unable to import, class not found, no such file or directory	1889
General: Undefined method handler	1889
General: Lambda code storage limit exceeded	1890
Lambda: Layer conversion failed	1890
Lambda: InvalidParameterValueException or RequestEntityTooLargeException	1891
Lambda: InvalidParameterValueException	1891
Lambda: Concurrency and memory quotas	1892
Invocation	1892
Lambda: Function times out during Init phase (Sandbox.Timedout)	1893
IAM: lambda:InvokeFunction not authorized	1894
Lambda: Couldn't find valid bootstrap (Runtime.InvalidEntrypoint)	1894
Lambda: Operation cannot be performed ResourceConflictException	1894
Lambda: Function is stuck in Pending	1895
Lambda: One function is using all concurrency	1895
General: Cannot invoke function with other accounts or services	1895
General: Function invocation is looping	1895
Lambda: Alias routing with provisioned concurrency	1896
Lambda: Cold starts with provisioned concurrency	1896

Lambda: Cold starts with new versions	1897
EFS: Function could not mount the EFS file system	1897
EFS: Function could not connect to the EFS file system	1897
EFS: Function could not mount the EFS file system due to timeout	1898
Lambda: Lambda detected an IO process that was taking too long	1898
Execution	1898
Lambda: Execution takes too long	1899
Lambda: Unexpected event payload	1899
Lambda: Unexpectedly large payload sizes	1900
Lambda: JSON encoding and decoding errors	1901
Lambda: Logs or traces don't appear	1901
Lambda: Not all of my function's logs appear	1902
Lambda: The function returns before execution finishes	1903
Lambda: Running an unintended function version or alias	1903
Lambda: Detecting infinite loops	1904
General: Downstream service unavailability	1905
AWS SDK: Versions and updates	1905
Python: Libraries load incorrectly	1906
Java: Your function takes longer to process events after updating to Java 17 from Java 11	1907
Event source mapping	1907
Identifying and managing throttling	1907
Errors in the processing function	1909
Identifying and handling backpressure	1911
Networking	1912
VPC: Function loses internet access or times out	1912
VPC: Function needs access to AWS services without using the internet	1913
VPC: Elastic network interface limit reached	1913
EC2: Elastic network interface with type of "lambda"	1913
DNS: Fail to connect to hosts with UNKNOWNHOSTEXCEPTION	1913
Sample applications	1915
Working with AWS SDKs	1918
Code examples	1920
Basics	1932
Hello Lambda	1933
Learn the basics	1942

Actions	2057
Scenarios	2173
Automatically confirm known users with a Lambda function	2174
Automatically migrate known users with a Lambda function	2214
Create a REST API to track COVID-19 data	2238
Create a lending library REST API	2239
Create a messenger application	2240
Create a serverless application to manage photos	2241
Create a websocket chat application	2245
Create an application to analyze customer feedback	2245
Invoke a Lambda function from a browser	2252
Transform data with S3 Object Lambda	2253
Use API Gateway to invoke a Lambda function	2253
Use Step Functions to invoke Lambda functions	2255
Use scheduled events to invoke a Lambda function	2256
Write custom activity data with a Lambda function after Amazon Cognito user authentication	2258
Serverless examples	2280
Connecting to an Amazon RDS database in a Lambda function	2281
Invoke a Lambda function from a Kinesis trigger	2300
Invoke a Lambda function from a DynamoDB trigger	2310
Invoke a Lambda function from a Amazon DocumentDB trigger	2320
Invoke a Lambda function from an Amazon MSK trigger	2332
Invoke a Lambda function from an Amazon S3 trigger	2341
Invoke a Lambda function from an Amazon SNS trigger	2353
Invoke a Lambda function from an Amazon SQS trigger	2362
Reporting batch item failures for Lambda functions with a Kinesis trigger	2371
Reporting batch item failures for Lambda functions with a DynamoDB trigger	2384
Reporting batch item failures for Lambda functions with an Amazon SQS trigger	2396
AWS community contributions	2405
Build and test a serverless application	2405
Lambda quotas	2408
Compute and storage	2410
Function configuration, deployment, and execution	2411
Lambda API requests	2413
Other services	2414

Document history	2415
Earlier updates	2438

What is AWS Lambda?

You can use AWS Lambda to run code without provisioning or managing servers.

Lambda runs your code on a high-availability compute infrastructure and performs all of the administration of the compute resources, including server and operating system maintenance, capacity provisioning and automatic scaling, and logging. With Lambda, all you need to do is supply your code in one of the language runtimes that Lambda supports.

You organize your code into Lambda functions. The Lambda service runs your function only when needed and scales automatically. You only pay for the compute time that you consume—there is no charge when your code is not running. For more information, see [AWS Lambda Pricing](#).

Tip

To learn how to build **serverless solutions**, check out the [Serverless Developer Guide](#).

When to use Lambda

Lambda is an ideal compute service for application scenarios that need to scale up rapidly, and scale down to zero when not in demand. For example, you can use Lambda for:

- **File processing:** Use Amazon Simple Storage Service (Amazon S3) to trigger Lambda data processing in real time after an upload.
- **Stream processing:** Use Lambda and Amazon Kinesis to process real-time streaming data for application activity tracking, transaction order processing, clickstream analysis, data cleansing, log filtering, indexing, social media analysis, Internet of Things (IoT) device data telemetry, and metering.
- **Web applications:** Combine Lambda with other AWS services to build powerful web applications that automatically scale up and down and run in a highly available configuration across multiple data centers.
- **IoT backends:** Build serverless backends using Lambda to handle web, mobile, IoT, and third-party API requests.
- **Mobile backends:** Build backends using Lambda and Amazon API Gateway to authenticate and process API requests. Use AWS Amplify to easily integrate with your iOS, Android, Web, and React Native frontends.

When using Lambda, you are responsible only for your code. Lambda manages the compute fleet that offers a balance of memory, CPU, network, and other resources to run your code. Because Lambda manages these resources, you cannot log in to compute instances or customize the operating system on provided runtimes. Lambda performs operational and administrative activities on your behalf, including managing capacity, monitoring, and logging your Lambda functions.

Key features

The following key features help you develop Lambda applications that are scalable, secure, and easily extensible:

[Environment variables](#)

Use environment variables to adjust your function's behavior without updating code.

[Versions](#)

Manage the deployment of your functions with versions, so that, for example, a new function can be used for beta testing without affecting users of the stable production version.

[Container images](#)

Create a container image for a Lambda function by using an AWS provided base image or an alternative base image so that you can reuse your existing container tooling or deploy larger workloads that rely on sizable dependencies, such as machine learning.

[Lambda layers](#)

Package libraries and other dependencies to reduce the size of deployment archives and makes it faster to deploy your code.

[Lambda extensions](#)

Augment your Lambda functions with tools for monitoring, observability, security, and governance.

[Function URLs](#)

Add a dedicated HTTP(S) endpoint to your Lambda function.

[Response streaming](#)

Configure your Lambda function URLs to stream response payloads back to clients from Node.js functions, to improve time to first byte (TTFB) performance or to return larger payloads.

Concurrency and scaling controls

Apply fine-grained control over the scaling and responsiveness of your production applications.

Code signing

Verify that only approved developers publish unaltered, trusted code in your Lambda functions

Private networking

Create a private network for resources such as databases, cache instances, or internal services.

File system

Configure a function to mount an Amazon Elastic File System (Amazon EFS) to a local directory, so that your function code can access and modify shared resources safely and at high concurrency.

Lambda SnapStart

Lambda SnapStart can provide as low as sub-second startup performance, typically with no changes to your function code.

Create your first Lambda function

To get started with Lambda, use the Lambda console to create a function. In a few minutes, you can create and deploy a function and test it in the console.

As you carry out the tutorial, you'll learn some fundamental Lambda concepts, like how to pass arguments to your function using the Lambda *event object*. You'll also learn how to return log outputs from your function, and how to view your function's invocation logs in Amazon CloudWatch Logs.

To keep things simple, you create your function using either the Python or Node.js runtime. With these interpreted languages, you can edit function code directly in the console's built-in code editor. With compiled languages like Java and C#, you must create a deployment package on your local build machine and upload it to Lambda. To learn about deploying functions to Lambda using other runtimes, see the links in the [the section called "Next steps"](#) section.

Tip

To learn how to build **serverless solutions**, check out the [Serverless Developer Guide](#).

Prerequisites

Sign up for an AWS account

If you do not have an AWS account, complete the following steps to create one.

To sign up for an AWS account

1. Open <https://portal.aws.amazon.com/billing/signup>.
2. Follow the online instructions.

Part of the sign-up procedure involves receiving a phone call and entering a verification code on the phone keypad.

When you sign up for an AWS account, an *AWS account root user* is created. The root user has access to all AWS services and resources in the account. As a security best practice, assign administrative access to a user, and use only the root user to perform [tasks that require root user access](#).

AWS sends you a confirmation email after the sign-up process is complete. At any time, you can view your current account activity and manage your account by going to <https://aws.amazon.com/> and choosing **My Account**.

Create a user with administrative access

After you sign up for an AWS account, secure your AWS account root user, enable AWS IAM Identity Center, and create an administrative user so that you don't use the root user for everyday tasks.

Secure your AWS account root user

1. Sign in to the [AWS Management Console](#) as the account owner by choosing **Root user** and entering your AWS account email address. On the next page, enter your password.

For help signing in by using root user, see [Signing in as the root user](#) in the *AWS Sign-In User Guide*.

2. Turn on multi-factor authentication (MFA) for your root user.

For instructions, see [Enable a virtual MFA device for your AWS account root user \(console\)](#) in the *IAM User Guide*.

Create a user with administrative access

1. Enable IAM Identity Center.

For instructions, see [Enabling AWS IAM Identity Center](#) in the *AWS IAM Identity Center User Guide*.

2. In IAM Identity Center, grant administrative access to a user.

For a tutorial about using the IAM Identity Center directory as your identity source, see [Configure user access with the default IAM Identity Center directory](#) in the *AWS IAM Identity Center User Guide*.

Sign in as the user with administrative access

- To sign in with your IAM Identity Center user, use the sign-in URL that was sent to your email address when you created the IAM Identity Center user.

For help signing in using an IAM Identity Center user, see [Signing in to the AWS access portal](#) in the *AWS Sign-In User Guide*.

Assign access to additional users

1. In IAM Identity Center, create a permission set that follows the best practice of applying least-privilege permissions.

For instructions, see [Create a permission set](#) in the *AWS IAM Identity Center User Guide*.

2. Assign users to a group, and then assign single sign-on access to the group.

For instructions, see [Add groups](#) in the *AWS IAM Identity Center User Guide*.

Create a Lambda function with the console

In this example, your function takes a JSON object containing two integer values labeled "length" and "width". The function multiplies these values to calculate an area and returns this as a JSON string.

Your function also prints the calculated area, along with the name of its CloudWatch log group. Later in the tutorial, you'll learn to use [CloudWatch Logs](#) to view records of your functions' invocation.

To create a Hello world Lambda function with the console

1. Open the [Functions page](#) of the Lambda console.
2. Choose **Create function**.
3. Select **Author from scratch**.
4. In the **Basic information** pane, for **Function name**, enter **myLambdaFunction**.
5. For **Runtime**, choose either **Node.js 22.x** or **Python 3.13**.
6. Leave **architecture** set to **x86_64**, and then choose **Create function**.

In addition to a simple function that returns the message Hello from Lambda!, Lambda also creates an [execution role](#) for your function. An execution role is an AWS Identity and Access Management (IAM) role that grants a Lambda function permission to access AWS services and

resources. For your function, the role that Lambda creates grants basic permissions to write to CloudWatch Logs.

Use the console's built-in code editor to replace the Hello world code that Lambda created with your own function code.

Node.js

To modify the code in the console

1. Choose the **Code** tab.

In the console's built-in code editor, you should see the function code that Lambda created. If you don't see the **index.mjs** tab in the code editor, select **index.mjs** in the file explorer as shown on the following diagram.

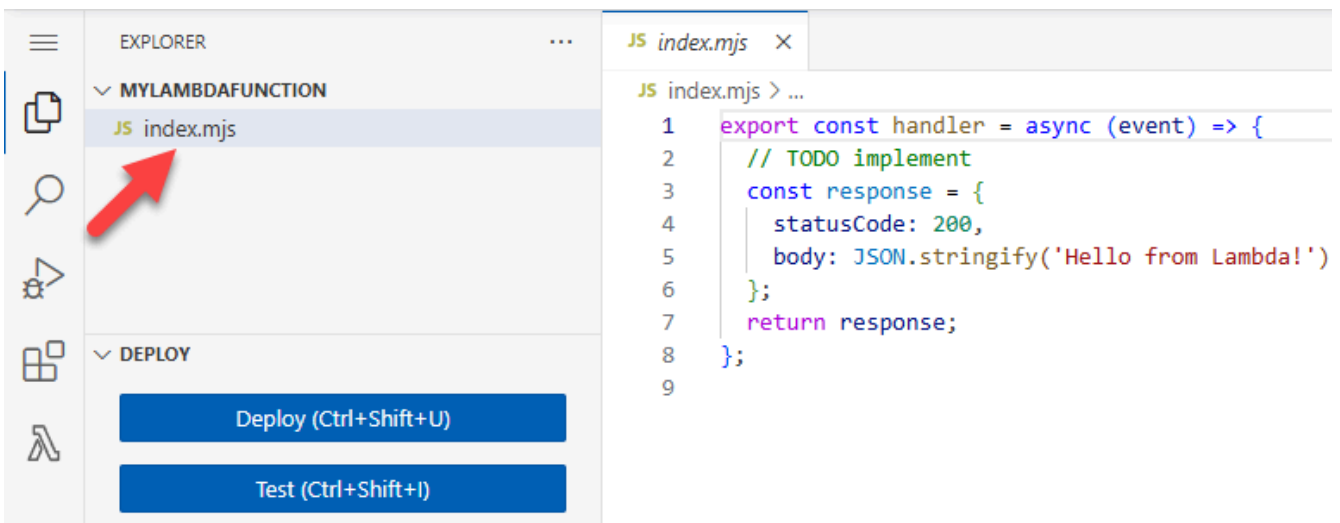

2. Paste the following code into the **index.mjs** tab, replacing the code that Lambda created.

```
export const handler = async (event, context) => {

  const length = event.length;
  const width = event.width;
  let area = calculateArea(length, width);
  console.log(`The area is ${area}`);

  console.log('CloudWatch log group: ', context.logGroupName);

  let data = {
    "area": area,
  };
};
```

```
    return JSON.stringify(data);

    function calculateArea(length, width) {
        return length * width;
    }
};
```

3. In the **DEPLOY** section, choose **Deploy** to update your function's code:

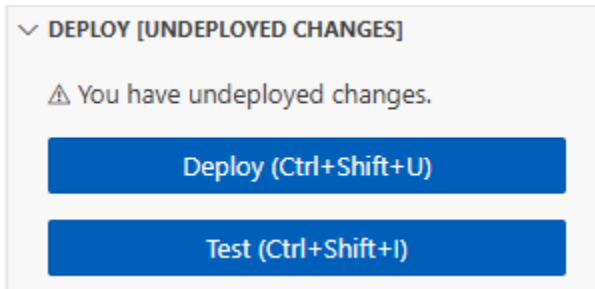

Understanding your function code

Before you move to the next step, let's take a moment to look at the function code and understand some key Lambda concepts.

- The Lambda handler:

Your Lambda function contains a Node.js function named `handler`. A Lambda function in Node.js can contain more than one Node.js function, but the *handler* function is always the entry point to your code. When your function is invoked, Lambda runs this method.

When you created your Hello world function using the console, Lambda automatically set the name of the handler method for your function to `handler`. Be sure not to edit the name of this Node.js function. If you do, Lambda won't be able to run your code when you invoke your function.

To learn more about the Lambda handler in Node.js, see [the section called "Handler"](#).

- The Lambda event object:

The function `handler` takes two arguments, `event` and `context`. An *event* in Lambda is a JSON formatted document that contains data for your function to process.

If your function is invoked by another AWS service, the event object contains information about the event that caused the invocation. For example, if your function is invoked when

an object is uploaded to an Amazon Simple Storage Service (Amazon S3) bucket, the event contains the name of the bucket and the object key.

In this example, you'll create an event in the console by entering a JSON formatted document with two key-value pairs.

- The Lambda context object:

The second argument that your function takes is `context`. Lambda passes the *context object* to your function automatically. The context object contains information about the function invocation and execution environment.

You can use the context object to output information about your function's invocation for monitoring purposes. In this example, your function uses the `logGroupName` parameter to output the name of its CloudWatch log group.

To learn more about the Lambda context object in Node.js, see [the section called "Context"](#).

- Logging in Lambda:

With Node.js, you can use console methods like `console.log` and `console.error` to send information to your function's log. The example code uses `console.log` statements to output the calculated area and the name of the function's CloudWatch Logs group. You can also use any logging library that writes to `stdout` or `stderr`.

To learn more, see [the section called "Logging"](#). To learn about logging in other runtimes, see the 'Building with' pages for the runtimes you're interested in.

Python

To modify the code in the console

1. Choose the **Code** tab.

In the console's built-in code editor, you should see the function code that Lambda created. If you don't see the `lambda_function.py` tab in the code editor, select `lambda_function.py` in the file explorer as shown on the following diagram.

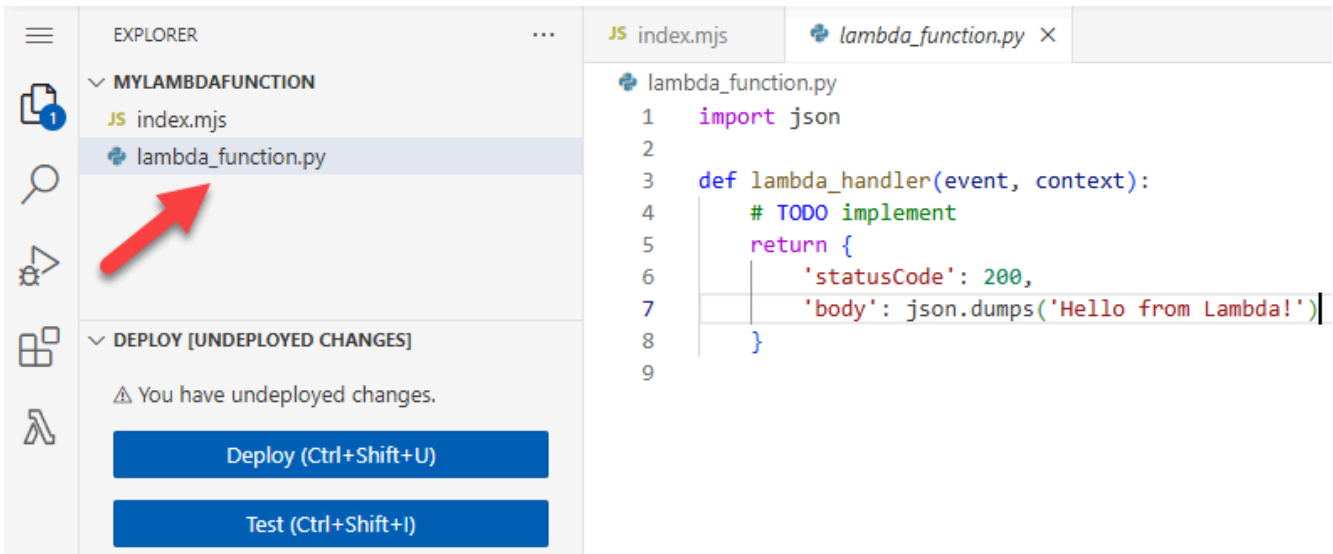

2. Paste the following code into the **lambda_function.py** tab, replacing the code that Lambda created.

```

import json
import logging

logger = logging.getLogger()
logger.setLevel(logging.INFO)

def lambda_handler(event, context):

    # Get the length and width parameters from the event object. The
    # runtime converts the event object to a Python dictionary
    length = event['length']
    width = event['width']

    area = calculate_area(length, width)
    print(f"The area is {area}")

    logger.info(f"CloudWatch logs group: {context.log_group_name}")

    # return the calculated area as a JSON string
    data = {"area": area}
    return json.dumps(data)

def calculate_area(length, width):
    return length*width

```

3. In the **DEPLOY** section, choose **Deploy** to update your function's code:

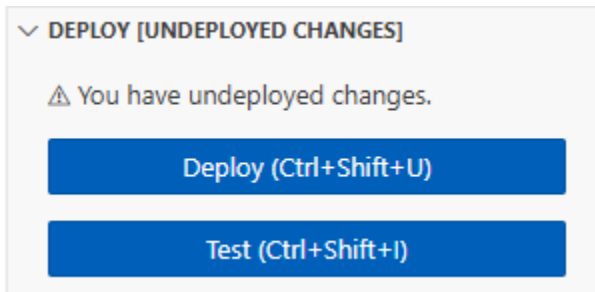

Understanding your function code

Before you move to the next step, let's take a moment to look at the function code and understand some key Lambda concepts.

- The Lambda handler:

Your Lambda function contains a Python function named `lambda_handler`. A Lambda function in Python can contain more than one Python function, but the *handler* function is always the entry point to your code. When your function is invoked, Lambda runs this method.

When you created your Hello world function using the console, Lambda automatically set the name of the handler method for your function to `lambda_handler`. Be sure not to edit the name of this Python function. If you do, Lambda won't be able to run your code when you invoke your function.

To learn more about the Lambda handler in Python, see [the section called "Handler"](#).

- The Lambda event object:

The function `lambda_handler` takes two arguments, `event` and `context`. An *event* in Lambda is a JSON formatted document that contains data for your function to process.

If your function is invoked by another AWS service, the event object contains information about the event that caused the invocation. For example, if your function is invoked when an object is uploaded to an Amazon Simple Storage Service (Amazon S3) bucket, the event contains the name of the bucket and the object key.

In this example, you'll create an event in the console by entering a JSON formatted document with two key-value pairs.

- The Lambda context object:

The second argument that your function takes is `context`. Lambda passes the *context object* to your function automatically. The context object contains information about the function invocation and execution environment.

You can use the context object to output information about your function's invocation for monitoring purposes. In this example, your function uses the `log_group_name` parameter to output the name of its CloudWatch log group.

To learn more about the Lambda context object in Python, see [the section called "Context"](#).

- Logging in Lambda:

With Python, you can use either a `print` statement or a Python logging library to send information to your function's log. To illustrate the difference in what's captured, the example code uses both methods. In a production application, we recommend that you use a logging library.

To learn more, see [the section called "Logging"](#). To learn about logging in other runtimes, see the 'Building with' pages for the runtimes you're interested in.

Invoke the Lambda function using the console code editor

To invoke your function using the Lambda console code editor, create a test event to send to your function. The event is a JSON formatted document containing two key-value pairs with the keys "length" and "width".

To create the test event

1. In the **TEST EVENTS** section of the console code editor, choose **Create test event**.

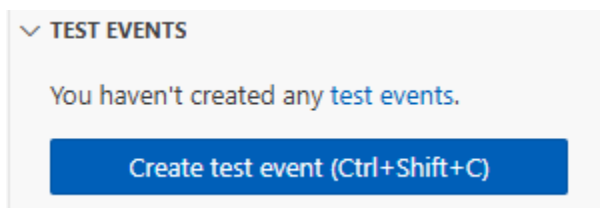

2. For **Event Name**, enter **myTestEvent**.
3. In the **Event JSON** section, replace the default JSON with the following:

```
{
```

```
"length": 6,  
"width": 7  
}
```

4. Choose **Save**.

To test your function and view invocation records

In the **TEST EVENTS** section of the console code editor, choose the run icon next to your test event:

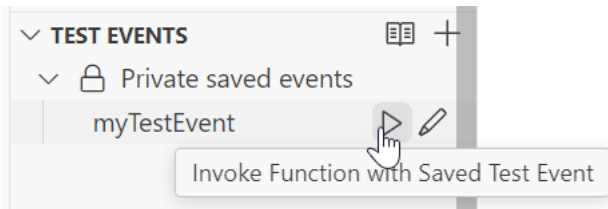

When your function finishes running, the response and function logs are displayed in the **OUTPUT** tab. You should see results similar to the following:

Node.js

```
Status: Succeeded  
Test Event Name: myTestEvent  
  
Response  
"{\"area\":42}"  
  
Function Logs  
START RequestId: 5c012b0a-18f7-4805-b2f6-40912935034a Version: $LATEST  
2024-08-31T23:39:45.313Z 5c012b0a-18f7-4805-b2f6-40912935034a INFO The area is 42  
2024-08-31T23:39:45.331Z 5c012b0a-18f7-4805-b2f6-40912935034a INFO CloudWatch log  
group: /aws/lambda/myLambdaFunction  
END RequestId: 5c012b0a-18f7-4805-b2f6-40912935034a  
REPORT RequestId: 5c012b0a-18f7-4805-b2f6-40912935034a Duration: 20.67 ms Billed  
Duration: 21 ms Memory Size: 128 MB Max Memory Used: 66 MB Init Duration: 163.87 ms  
  
Request ID  
5c012b0a-18f7-4805-b2f6-40912935034a
```

Python

```
Status: Succeeded  
Test Event Name: myTestEvent
```

Response

```
"{\\"area\\": 42}"
```

Function Logs

```
START RequestId: 2d0b1579-46fb-4bf7-a6e1-8e08840eae5b Version: $LATEST
```

```
The area is 42
```

```
[INFO] 2024-08-31T23:43:26.428Z 2d0b1579-46fb-4bf7-a6e1-8e08840eae5b CloudWatch logs
group: /aws/lambda/myLambdaFunction
```

```
END RequestId: 2d0b1579-46fb-4bf7-a6e1-8e08840eae5b
```

```
REPORT RequestId: 2d0b1579-46fb-4bf7-a6e1-8e08840eae5b Duration: 1.42 ms Billed
Duration: 2 ms Memory Size: 128 MB Max Memory Used: 39 MB Init Duration: 123.74 ms
```

Request ID

```
2d0b1579-46fb-4bf7-a6e1-8e08840eae5b
```

When you invoke your function outside of the Lambda console, you must use CloudWatch Logs to view your function's execution results.

To view your function's invocation records in CloudWatch Logs

1. Open the [Log groups](#) page of the CloudWatch console.
2. Choose the log group for your function (`/aws/lambda/myLambdaFunction`). This is the log group name that your function printed to the console.
3. Scroll down and choose the **Log stream** for the function invocations you want to look at.

<input type="checkbox"/>	Log stream	Last event time
<input checked="" type="checkbox"/>	2024/04/30/[\$LATEST]e0fa	2024-04-30 17:24:16 (UTC)
<input type="checkbox"/>	2024/04/19/[\$LATEST]e9a	2024-04-19 20:59:06 (UTC)
<input type="checkbox"/>	2024/02/22/[\$LATEST]cf0	2024-02-22 18:38:41 (UTC)
<input type="checkbox"/>	2024/02/21/[1]d132c4d	2024-02-21 21:37:01 (UTC)
<input type="checkbox"/>	2024/02/21/[1]5ad	2024-02-21 21:37:01 (UTC)

You should see output similar to the following:

Node.js

```
INIT_START Runtime Version: nodejs:22.v13    Runtime Version ARN:
arn:aws:lambda:us-
west-2::runtime:e3aaabf6b92ef8755eaae2f4bfdcb7eb8c4536a5e044900570a42bdba7b869d9
START RequestId: aba6c0fc-cf99-49d7-a77d-26d805dacd20 Version: $LATEST
2024-08-23T22:04:15.809Z    5c012b0a-18f7-4805-b2f6-40912935034a  INFO The area
is 42
2024-08-23T22:04:15.810Z    aba6c0fc-cf99-49d7-a77d-26d805dacd20  INFO
CloudWatch log group: /aws/lambda/myLambdaFunction
END RequestId: aba6c0fc-cf99-49d7-a77d-26d805dacd20
REPORT RequestId: aba6c0fc-cf99-49d7-a77d-26d805dacd20    Duration: 17.77 ms
Billed Duration: 18 ms    Memory Size: 128 MB    Max Memory Used: 67 MB    Init
Duration: 178.85 ms
```

Python

```
INIT_START Runtime Version: python:3.13.v16    Runtime Version ARN:
arn:aws:lambda:us-
west-2::runtime:ca202755c87b9ec2b58856efb7374b4f7b655a0ea3deb1d5acc9aee9e297b072
START RequestId: 9d4096ee-acb3-4c25-be10-8a210f0a9d8e Version: $LATEST
The area is 42
[INFO] 2024-09-01T00:05:22.464Z 9315ab6b-354a-486e-884a-2fb2972b7d84 CloudWatch
logs group: /aws/lambda/myLambdaFunction
END RequestId: 9d4096ee-acb3-4c25-be10-8a210f0a9d8e
REPORT RequestId: 9d4096ee-acb3-4c25-be10-8a210f0a9d8e    Duration: 1.15 ms
Billed Duration: 2 ms    Memory Size: 128 MB    Max Memory Used: 40 MB
```

Clean up

When you're finished working with the example function, delete it. You can also delete the log group that stores the function's logs, and the [execution role](#) that the console created.

To delete the Lambda function

1. Open the [Functions page](#) of the Lambda console.
2. Select the function that you created.
3. Choose **Actions, Delete**.
4. Type **confirm** in the text input field and choose **Delete**.

To delete the log group

1. Open the [Log groups](#) page of the CloudWatch console.
2. Select the function's log group (`/aws/lambda/myLambdaFunction`).
3. Choose **Actions, Delete log group(s)**.
4. In the **Delete log group(s)** dialog box, choose **Delete**.

To delete the execution role

1. Open the [Roles page](#) of the AWS Identity and Access Management (IAM) console.
2. Select the function's execution role (for example, `myLambdaFunction-role-31exxmpl`).
3. Choose **Delete**.
4. In the **Delete role** dialog box, enter the role name, and then choose **Delete**.

Additional resources and next steps

Now that you've created and tested a simple Lambda function using the console, take these next steps:

- Learn to add dependencies to your function and deploy it using a .zip deployment package. Choose your preferred language from the following links.

Node.js

[the section called "Deploy .zip file archives"](#)

Typescript

[the section called "Deploy .zip file archives"](#)

Python

[the section called "Deploy .zip file archives"](#)

Ruby

[the section called "Deploy .zip file archives"](#)

Java

[the section called "Deploy .zip file archives"](#)

Go

[the section called “Deploy .zip file archives”](#)

C#

[the section called “Deployment package”](#)

- To learn how to invoke a Lambda function using another AWS service, see [Tutorial: Using an Amazon S3 trigger to invoke a Lambda function](#).
- Choose one of the following tutorials for more complex examples of using Lambda with other AWS services.
 - [Tutorial: Using Lambda with API Gateway](#): Create an Amazon API Gateway REST API that invokes a Lambda function.
 - [Using a Lambda function to access an Amazon RDS database](#): Use a Lambda function to write data to an Amazon Relational Database Service (Amazon RDS) database through RDS Proxy.
 - [Using an Amazon S3 trigger to create thumbnail images](#): Use a Lambda function to create a thumbnail every time an image file is uploaded to an Amazon S3 bucket.

Key Lambda concepts

This chapter describes key concepts in Lambda:

- [Basic Lambda concepts](#) explains basics such as functions, triggers, events, runtimes, and deployment packages.
- [Programming model](#) explains how Lambda interacts with your code.
- [Execution environment](#) explains the environment Lambda uses to run your code.
- [Event-driven architectures](#) describes the most commonly used design paradigm for serverless applications built using Lambda functions.
- [Application design](#) explains various design best practices for Lambda-based applications.
- [Frequently asked questions](#) is a curated list of common FAQs about Lambda.

Understanding basic Lambda concepts

Because Lambda is a serverless, event-driven compute service, it uses a different programming paradigm to traditional web applications. If you're new to Lambda or serverless development, the following sections describe some key foundational concepts that will help you get started on your learning path. As well as an explanation of each concept, the sections also contain links to tutorials, detailed documentation, and other resources you can use to broaden your understanding on each topic.

On this page, you'll learn about the following:

- **Lambda functions** - the basic building blocks of Lambda you use to build applications
- **Lambda runtimes** - the language-specific environments that your functions run in
- **Triggers and event source mappings** - ways for other AWS services to invoke your functions in response to specific events
- **The event object** - a JSON object containing event data for your function to process
- **Lambda permissions** - the way you control which other AWS services your functions can interact with and who can access your functions

Tip

If you want to start by understanding serverless development more generally, see [Understanding the difference between traditional and serverless development](#) in the *AWS Serverless Developer Guide*.

Lambda functions

In Lambda, *functions* are the fundamental building blocks you use to create applications. A Lambda function is a piece of code that runs in response to events, such as a user clicking a button on a website or a file being uploaded to an Amazon Simple Storage Service (Amazon S3) bucket. You can think of a function as a kind of self-contained program with the following properties.

- A function has one specific job or purpose
- They run only when needed in response to specific events
- They automatically stop running when finished

When a function runs in response to an event, Lambda runs the function's *handler* function. Data about the event that caused the function to run is passed directly to the handler. While the code in a Lambda function can contain more than one method or function, Lambda functions can only have one handler.

To create a Lambda function, you bundle your function code and its dependencies in a *deployment package*. Lambda supports two types of deployment package, [.zip file archives](#) and [container images](#).

To get a better understanding of Lambda functions, we recommend you start by completing the [Create your first function](#) tutorial, if you haven't done so already. This tutorial provides more detail about the handler function and how to pass data in and out of your function. It also provides an introduction to creating function logs.

Lambda execution environment and runtimes

Lambda functions run inside a secure, isolated [execution environment](#) which Lambda manages for you. This execution environment manages the processes and resources that are needed to run your function. When a function is first invoked, Lambda creates a new execution environment for the function to run in. After the function has finished running, Lambda doesn't stop the execution environment right away; if the function is invoked again, Lambda can re-use the existing execution environment.

The Lambda execution environment also contains a *runtime*, a language-specific environment that relays event information and responses between Lambda and your function. Lambda provides a number of [managed runtimes](#) for the most popular programming languages, or you can create your own.

For managed runtimes, Lambda automatically applies security updates and patches to functions using the runtime.

Triggers and event source mappings

Although you can invoke a Lambda function manually using the AWS Command Line Interface (AWS CLI) or by using the Lambda API, it's more usual in a production application for your function to be invoked by another AWS service in response to a particular event. For example, you might want a function to run whenever an item is added to an Amazon DynamoDB table.

To configure a function to run in response to a specific event, you add a *trigger*. When you create a trigger, other AWS services can invoke your function directly by pushing an [event object](#) to Lambda

whenever a particular event occurs. A function can have multiple triggers, each of which invokes your function independently.

Some types of stream and queue service, such as Amazon Kinesis or Amazon Simple Queue Service (Amazon SQS), can't directly invoke Lambda using a trigger. For these services, you need to create an [event source mapping](#) instead. Event source mappings are a special type of Lambda resource that continuously polls a stream or queue to check for new events. For example, an event source mapping might poll an Amazon SQS queue to check whether new messages have been added. Lambda batches new messages into a single payload until a limit that you configure is reached, and then invokes your function with a single event object containing all the records in the batch.

The easiest way to create a trigger or event source mapping is by using the Lambda console. Although the underlying resources that Lambda creates and the way that your function is invoked are different, the process for creating a trigger or event source mapping in the console uses the same method.

To see an example of a trigger in action, start by carrying out the [Using an Amazon S3 trigger to invoke a Lambda function](#) tutorial, or for a general overview of using triggers and instructions on creating a trigger using the Lambda console, see [Integrating other services](#).

The event object

Lambda is an event-driven compute service. This means that your code runs in response to events generated by external producers. Event data is passed to your function as a JSON-formatted document, which the runtime converts to an object for your code to process. For example, in Python, the runtime converts the JSON document to a Python dictionary or list and passes this to the function as the event input argument.

When the event is generated by another AWS service, the format of the event depends on the service that generates it. For example, an event Amazon S3 includes the name of the bucket that triggered your function and information about objects in that bucket. To learn more about the format of the events generated by different AWS services, refer to the relevant chapters in [Integrating other services](#).

You can also invoke a Lambda function directly by using the Lambda console, [AWS CLI](#), or one of the [AWS Software Development Kits \(SDKs\)](#). When you invoke a function directly, you determine the format and contents of the JSON event. For example, suppose you have a Lambda function that writes weather data to a database. You might define the following JSON format for your

event. As with events generated by other AWS services, the Lambda runtime converts this JSON to an object before passing it to your function's handler.

Example custom Lambda event

```
{
  "Location": "SEA",
  "WeatherData": {
    "TemperaturesF": {
      "MinTempF": 22,
      "MaxTempF": 78
    },
    "PressuresHPa": {
      "MinPressureHPa": 1015,
      "MaxPressureHPa": 1027
    }
  }
}
```

Because the Lambda runtime converts the event to an object, you can easily assign values in the event to variables without having to deserialize the JSON. The following example code snippets show how to assign the minimum temperature value from the previous example event to a variable `MinTemp` using the Python and Node.js runtimes. In both cases, the event object is passed to your function's handler function as an argument named `event`.

Example Python code snippet

```
MinTemp = event['WeatherData']['TemperaturesF']['MinTempF']
```

Example Node.js code snippet

```
let MinTemp = event.WeatherData.TemperaturesF.MinTempF;
```

For an example of invoking a Lambda function with a custom event, see [Create your first function](#).

Lambda permissions

For Lambda, there are two main types of [permissions](#) that you need to configure:

- Permissions that your function needs to access other AWS services
- Permissions that other users and AWS services need to access your function

The following sections describe both of these permission types and discuss best practices for applying least-privilege permissions.

Permissions for functions to access other AWS resources

Lambda functions often need to access other AWS resources and perform actions on them. For example, a function might read items from a DynamoDB table, store an object in an S3 bucket, or write to an Amazon SQS queue. To give functions the permissions they need to perform these actions, you use an [execution role](#).

A Lambda execution role is a special kind of AWS Identity and Access Management (IAM) [role](#), an identity you create in your account that has specific permissions associated with it defined in a *policy*.

Every Lambda function must have an execution role, and a single role can be used by more than one function. When a function is invoked, Lambda assumes the function's execution role and is granted permission to take the actions defined in the role's policy.

When you create a function in the Lambda console, Lambda automatically creates an execution role for your function. The role's policy gives your function basic permissions to write log outputs to Amazon CloudWatch Logs. To give your function permission to perform actions on other AWS resources, you need to edit the role to add the extra permissions. The easiest way to add permissions is to use an AWS [managed policy](#). Managed policies are created and administered by AWS and provide permissions for many common use cases. For example, if your function performs CRUD operations on a DynamoDB table, you can add the [AmazonDynamoDBFullAccess](#) policy to your role.

Permissions for other users and resources to access your function

To grant other AWS service permission to access your Lambda function, you use a [resource-based policy](#). In IAM, resource-based policies are attached to a resource (in this case, your Lambda function) and define who can access the resource and what actions they are allowed to take.

For another AWS service to invoke your function through a trigger, your function's resource-based policy must grant that service permission to use the `lambda:InvokeFunction` action. If you create the trigger using the console, Lambda automatically adds this permission for you.

To grant permission to other AWS users to access your function, you can define this in your function's resource-based policy in exactly the same way as for another AWS service or resource. You can also use an [identity-based policy](#) that's associated with the user.

Best practices for Lambda permissions

When you set permissions using IAM policies, [security best practice](#) is to grant only the permissions required to perform a task. This is known as the principle of *least privilege*. To get started granting permissions for your function, you might choose to use an AWS managed policy. Managed policies can be the quickest and easiest way to grant permissions to perform a task, but they might also include other permissions you don't need. As you move from early development through test and production, we recommend you reduce permissions to only those needed by defining your own [customer-managed policies](#).

The same principle applies when granting permissions to access your function using a resource-based policy. For example, if you want to give permission to Amazon S3 to invoke your function, best practice is to limit access to individual buckets, or buckets in particular AWS accounts, rather than giving blanket permissions to the S3 service.

Understanding the Lambda programming model

Lambda provides a programming model that is common to all of the runtimes. The programming model defines the interface between your code and the Lambda system. You tell Lambda the entry point to your function by defining a *handler* in the function configuration. The runtime passes in objects to the handler that contain the invocation *event* and the *context*, such as the function name and request ID.

When the handler finishes processing the first event, the runtime sends it another. The function's class stays in memory, so clients and variables that are declared outside of the handler method in *initialization code* can be reused. To save processing time on subsequent events, create reusable resources like AWS SDK clients during initialization. Once initialized, each instance of your function can process thousands of requests.

Your function also has access to local storage in the `/tmp` directory, a transient cache that can be used for multiple invocations. For more information, see [Understanding the Lambda execution environment lifecycle](#).

When [AWS X-Ray tracing](#) is enabled, the runtime records separate subsegments for initialization and execution.

The runtime captures logging output from your function and sends it to Amazon CloudWatch Logs. In addition to logging your function's output, the runtime also logs entries when function invocation starts and ends. This includes a report log with the request ID, billed duration, initialization duration, and other details. If your function throws an error, the runtime returns that error to the invoker.

Note

Logging is subject to [CloudWatch Logs quotas](#). Log data can be lost due to throttling or, in some cases, when an instance of your function is stopped.

Lambda scales your function by running additional instances of it as demand increases, and by stopping instances as demand decreases. This model leads to variations in application architecture, such as:

- Unless noted otherwise, incoming requests might be processed out of order or concurrently.

- Do not rely on instances of your function being long lived, instead store your application's state elsewhere.
- Use local storage and class-level objects to increase performance, but keep to a minimum the size of your deployment package and the amount of data that you transfer onto the execution environment.

For a hands-on introduction to the programming model in your preferred programming language, see the following chapters.

- [Building Lambda functions with Node.js](#)
- [Building Lambda functions with Python](#)
- [Building Lambda functions with Ruby](#)
- [Building Lambda functions with Java](#)
- [Building Lambda functions with Go](#)
- [Building Lambda functions with C#](#)
- [Building Lambda functions with PowerShell](#)

Understanding the Lambda execution environment lifecycle

Lambda invokes your function in an execution environment, which provides a secure and isolated runtime environment. The execution environment manages the resources required to run your function. The execution environment also provides lifecycle support for the function's runtime and any [external extensions](#) associated with your function.

The function's runtime communicates with Lambda using the [Runtime API](#). Extensions communicate with Lambda using the [Extensions API](#). Extensions can also receive log messages and other telemetry from the function by using the [Telemetry API](#).

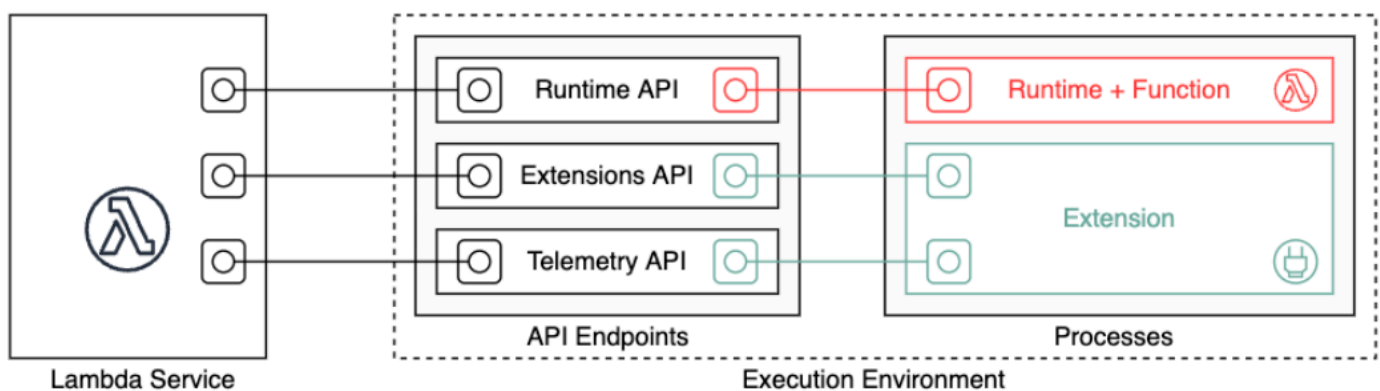

When you create your Lambda function, you specify configuration information, such as the amount of memory available and the maximum execution time allowed for your function. Lambda uses this information to set up the execution environment.

The function's runtime and each external extension are processes that run within the execution environment. Permissions, resources, credentials, and environment variables are shared between the function and the extensions.

Topics

- [Lambda execution environment lifecycle](#)
- [Cold starts and latency](#)
- [Reducing cold starts with Provisioned Concurrency](#)
- [Optimizing static initialization](#)

Lambda execution environment lifecycle

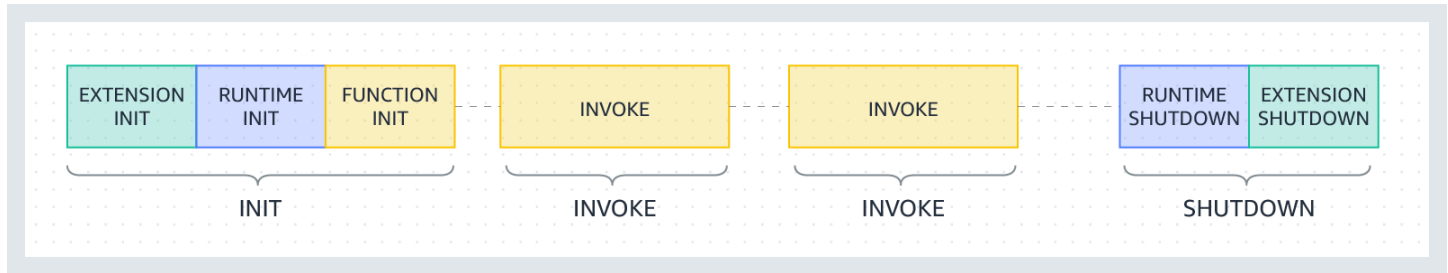

Each phase starts with an event that Lambda sends to the runtime and to all registered extensions. The runtime and each extension indicate completion by sending a Next API request. Lambda freezes the execution environment when the runtime and each extension have completed and there are no pending events.

Topics

- [Init phase](#)
- [Failures during the Init phase](#)
- [Restore phase \(Lambda SnapStart only\)](#)
- [Invoke phase](#)
- [Failures during the invoke phase](#)
- [Shutdown phase](#)

Init phase

In the Init phase, Lambda performs three tasks:

- Start all extensions (Extension init)
- Bootstrap the runtime (Runtime init)
- Run the function's static code (Function init)
- Run any before-checkpoint [runtime hooks](#) (Lambda SnapStart only)

The Init phase ends when the runtime and all extensions signal that they are ready by sending a Next API request. The Init phase is limited to 10 seconds. If all three tasks do not complete within 10 seconds, Lambda retries the Init phase at the time of the first function invocation with the configured function timeout.

When [Lambda SnapStart](#) is activated, the `Init` phase happens when you publish a function version. Lambda saves a snapshot of the memory and disk state of the initialized execution environment, persists the encrypted snapshot, and caches it for low-latency access. If you have a before-checkpoint [runtime hook](#), then the code runs at the end of `Init` phase.

Note

The 10-second timeout doesn't apply to functions that are using provisioned concurrency or SnapStart. For provisioned concurrency and SnapStart functions, your initialization code can run for up to 15 minutes. The time limit is 130 seconds or the configured function timeout (maximum 900 seconds), whichever is higher.

When you use [provisioned concurrency](#), Lambda initializes the execution environment when you configure the PC settings for a function. Lambda also ensures that initialized execution environments are always available in advance of invocations. You may see gaps between your function's invocation and initialization phases. Depending on your function's runtime and memory configuration, you may also see variable latency on the first invocation on an initialized execution environment.

For functions using on-demand concurrency, Lambda may occasionally initialize execution environments ahead of invocation requests. When this happens, you may also observe a time gap between your function's initialization and invocation phases. We recommend you to not take a dependency on this behavior.

Failures during the `Init` phase

If a function crashes or times out during the `Init` phase, Lambda emits error information in the `INIT_REPORT` log.

Example — `INIT_REPORT` log for timeout

```
INIT_REPORT Init Duration: 1236.04 ms Phase: init Status: timeout
```

Example — `INIT_REPORT` log for extension failure

```
INIT_REPORT Init Duration: 1236.04 ms Phase: init Status: error Error Type:  
Extension.Crash
```

If the `Init` phase is successful, Lambda doesn't emit the `INIT_REPORT` log unless [SnapStart](#) or [provisioned concurrency](#) is enabled. SnapStart and provisioned concurrency functions always emit `INIT_REPORT`. For more information, see [Monitoring for Lambda SnapStart](#).

Restore phase (Lambda SnapStart only)

When you first invoke a [SnapStart](#) function and as the function scales up, Lambda resumes new execution environments from the persisted snapshot instead of initializing the function from scratch. If you have an `afterRestore()` [runtime hook](#), the code runs at the end of the Restore phase. You are charged for the duration of `afterRestore()` runtime hooks. The runtime (JVM) must load and `afterRestore()` runtime hooks must complete within the timeout limit (10 seconds). Otherwise, you'll get a `SnapStartTimeoutException`. When the Restore phase completes, Lambda invokes the function handler (the [Invoke phase](#)).

Failures during the Restore phase

If the Restore phase fails, Lambda emits error information in the `RESTORE_REPORT` log.

Example — `RESTORE_REPORT` log for timeout

```
RESTORE_REPORT Restore Duration: 1236.04 ms Status: timeout
```

Example — `RESTORE_REPORT` log for runtime hook failure

```
RESTORE_REPORT Restore Duration: 1236.04 ms Status: error Error Type: Runtime.ExitError
```

For more information about the `RESTORE_REPORT` log, see [Monitoring for Lambda SnapStart](#).

Invoke phase

When a Lambda function is invoked in response to a Next API request, Lambda sends an `Invoke` event to the runtime and to each extension.

The function's timeout setting limits the duration of the entire `Invoke` phase. For example, if you set the function timeout as 360 seconds, the function and all extensions need to complete within 360 seconds. Note that there is no independent post-`invoke` phase. The duration is the sum of all invocation time (runtime + extensions) and is not calculated until the function and all extensions have finished executing.

The `invoke` phase ends after the runtime and all extensions signal that they are done by sending a Next API request.

Failures during the invoke phase

If the Lambda function crashes or times out during the Invoke phase, Lambda resets the execution environment. The following diagram illustrates Lambda execution environment behavior when there's an invoke failure:

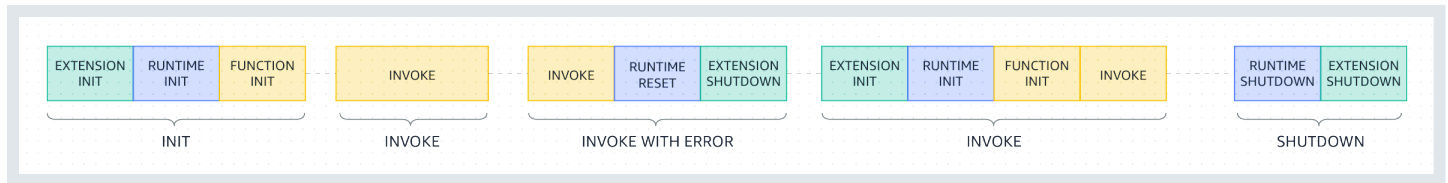

In the previous diagram:

- The first phase is the **INIT** phase, which runs without errors.
- The second phase is the **INVOKE** phase, which runs without errors.
- At some point, suppose your function runs into an invoke failure (such as a function timeout or runtime error). The third phase, labeled **INVOKE WITH ERROR**, illustrates this scenario. When this happens, the Lambda service performs a reset. The reset behaves like a Shutdown event. First, Lambda shuts down the runtime, then sends a Shutdown event to each registered external extension. The event includes the reason for the shutdown. If this environment is used for a new invocation, Lambda re-initializes the extension and runtime together with the next invocation.

Note that the Lambda reset does not clear the `/tmp` directory content prior to the next init phase. This behavior is consistent with the regular shutdown phase.

Note

AWS is currently implementing changes to the Lambda service. Due to these changes, you may see minor differences between the structure and content of system log messages and trace segments emitted by different Lambda functions in your AWS account.

If your function's system log configuration is set to plain text, this change affects the log messages captured in CloudWatch Logs when your function experiences an invoke failure. The following examples show log outputs in both old and new formats.

These changes will be implemented during the coming weeks, and all functions in all AWS Regions except the China and GovCloud regions will transition to use the new-format log messages and trace segments.

Example CloudWatch Logs log output (runtime or extension crash) - old style

```
START RequestId: c3252230-c73d-49f6-8844-968c01d1e2e1 Version: $LATEST
RequestId: c3252230-c73d-49f6-8844-968c01d1e2e1 Error: Runtime exited without
providing a reason
Runtime.ExitError
END RequestId: c3252230-c73d-49f6-8844-968c01d1e2e1
REPORT RequestId: c3252230-c73d-49f6-8844-968c01d1e2e1 Duration: 933.59 ms Billed
Duration: 934 ms Memory Size: 128 MB Max Memory Used: 9 MB
```

Example CloudWatch Logs log output (function timeout) - old style

```
START RequestId: b70435cc-261c-4438-b9b6-efe4c8f04b21 Version: $LATEST
2024-03-04T17:22:38.033Z b70435cc-261c-4438-b9b6-efe4c8f04b21 Task timed out after
3.00 seconds
END RequestId: b70435cc-261c-4438-b9b6-efe4c8f04b21
REPORT RequestId: b70435cc-261c-4438-b9b6-efe4c8f04b21 Duration: 3004.92 ms Billed
Duration: 3000 ms Memory Size: 128 MB Max Memory Used: 33 MB Init Duration: 111.23
ms
```

The new format for CloudWatch logs includes an additional statusfield in the REPORT line. In the case of a runtime or extension crash, the REPORT line also includes a field `ErrorType`.

Example CloudWatch Logs log output (runtime or extension crash) - new style

```
START RequestId: 5b866fb1-7154-4af6-8078-6ef6ca4c2ddd Version: $LATEST
END RequestId: 5b866fb1-7154-4af6-8078-6ef6ca4c2ddd
REPORT RequestId: 5b866fb1-7154-4af6-8078-6ef6ca4c2ddd Duration: 133.61 ms Billed
Duration: 133 ms Memory Size: 128 MB Max Memory Used: 31 MB Init Duration: 80.00
ms Status: error Error Type: Runtime.ExitError
```

Example CloudWatch Logs log output (function timeout) - new style

```
START RequestId: 527cb862-4f5e-49a9-9ae4-a7edc90f0fda Version: $LATEST
END RequestId: 527cb862-4f5e-49a9-9ae4-a7edc90f0fda
REPORT RequestId: 527cb862-4f5e-49a9-9ae4-a7edc90f0fda Duration: 3016.78 ms Billed
Duration: 3016 ms Memory Size: 128 MB Max Memory Used: 31 MB Init Duration: 84.00
ms Status: timeout
```

- The fourth phase represents the **INVOKE** phase immediately following an invoke failure. Here, Lambda initializes the environment again by re-running the **INIT** phase. This is called a *suppressed init*. When suppressed inits occur, Lambda doesn't explicitly report an additional **INIT** phase in CloudWatch Logs. Instead, you may notice that the duration in the **REPORT** line includes an additional **INIT** duration + the **INVOKE** duration. For example, suppose you see the following logs in CloudWatch:

```
2022-12-20T01:00:00.000-08:00 START RequestId: XXX Version: $LATEST
2022-12-20T01:00:02.500-08:00 END RequestId: XXX
2022-12-20T01:00:02.500-08:00 REPORT RequestId: XXX Duration: 3022.91 ms
Billed Duration: 3000 ms Memory Size: 512 MB Max Memory Used: 157 MB
```

In this example, the difference between the **REPORT** and **START** timestamps is 2.5 seconds. This doesn't match the reported duration of 3022.91 milliseconds, because it doesn't take into account the extra **INIT** (suppressed init) that Lambda performed. In this example, you can infer that the actual **INVOKE** phase took 2.5 seconds.

For more insight into this behavior, you can use the [Accessing real-time telemetry data for extensions using the Telemetry API](#). The Telemetry API emits **INIT_START**, **INIT_RUNTIME_DONE**, and **INIT_REPORT** events with `phase=invoke` whenever suppressed inits occur in between invoke phases.

- The fifth phase represents the **SHUTDOWN** phase, which runs without errors.

Shutdown phase

When Lambda is about to shut down the runtime, it sends a Shutdown event to each registered external extension. Extensions can use this time for final cleanup tasks. The Shutdown event is a response to a Next API request.

Duration: The entire Shutdown phase is capped at 2 seconds. If the runtime or any extension does not respond, Lambda terminates it via a signal (SIGKILL).

After the function and all extensions have completed, Lambda maintains the execution environment for some time in anticipation of another function invocation. However, Lambda terminates execution environments every few hours to allow for runtime updates and maintenance—even for functions that are invoked continuously. You should not assume that the execution environment will persist indefinitely. For more information, see [Implement statelessness in functions](#).

When the function is invoked again, Lambda thaws the environment for reuse. Reusing the execution environment has the following implications:

- Objects declared outside of the function's handler method remain initialized, providing additional optimization when the function is invoked again. For example, if your Lambda function establishes a database connection, instead of reestablishing the connection, the original connection is used in subsequent invocations. We recommend adding logic in your code to check if a connection exists before creating a new one.
- Each execution environment provides between 512 MB and 10,240 MB, in 1-MB increments, of disk space in the `/tmp` directory. The directory content remains when the execution environment is frozen, providing a transient cache that can be used for multiple invocations. You can add extra code to check if the cache has the data that you stored. For more information on deployment size limits, see [Lambda quotas](#).
- Background processes or callbacks that were initiated by your Lambda function and did not complete when the function ended resume if Lambda reuses the execution environment. Make sure that any background processes or callbacks in your code are complete before the code exits.

Cold starts and latency

When Lambda receives a request to run a function via the Lambda API, the service first prepares an execution environment. During this initialization phase, the service downloads your code, starts the environment, and runs any initialization code outside of the main handler. Finally, Lambda runs the handler code.

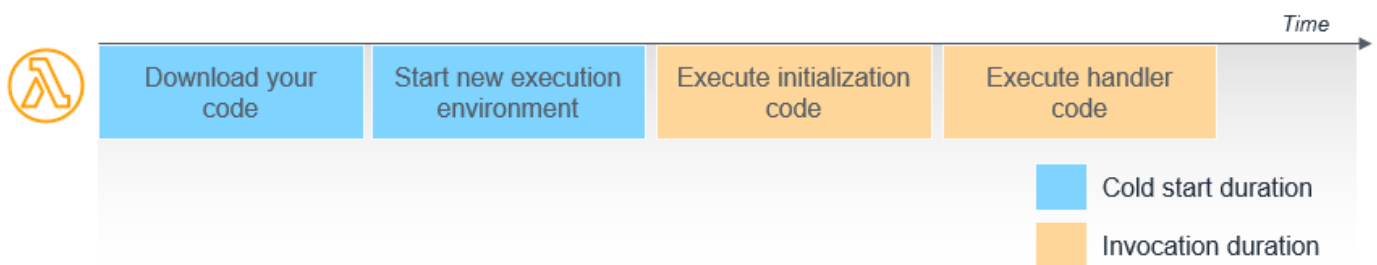

In this diagram, the first two steps of downloading the code and setting up the environment are frequently referred to as a “cold start”. You are not charged for this time, but it does add latency to your overall invocation duration.

After the invocation completes, the execution environment is frozen. To improve resource management and performance, Lambda retains the execution environment for a period of

time. During this time, if another request arrives for the same function, Lambda can reuse the environment. This second request typically finishes more quickly, since the execution environment is already fully set up. This is called a “warm start”.

Cold starts typically occur in under 1% of invocations. The duration of a cold start varies from under 100 ms to over 1 second. In general, cold starts are typically more common in development and test functions than production workloads. This is because development and test functions are usually invoked less frequently.

Reducing cold starts with Provisioned Concurrency

If you need predictable function start times for your workload, [provisioned concurrency](#) is the recommended solution to ensure the lowest possible latency. This feature pre-initializes execution environments, reducing cold starts.

For example, a function with a provisioned concurrency of 6 has 6 execution environments pre-warmed.

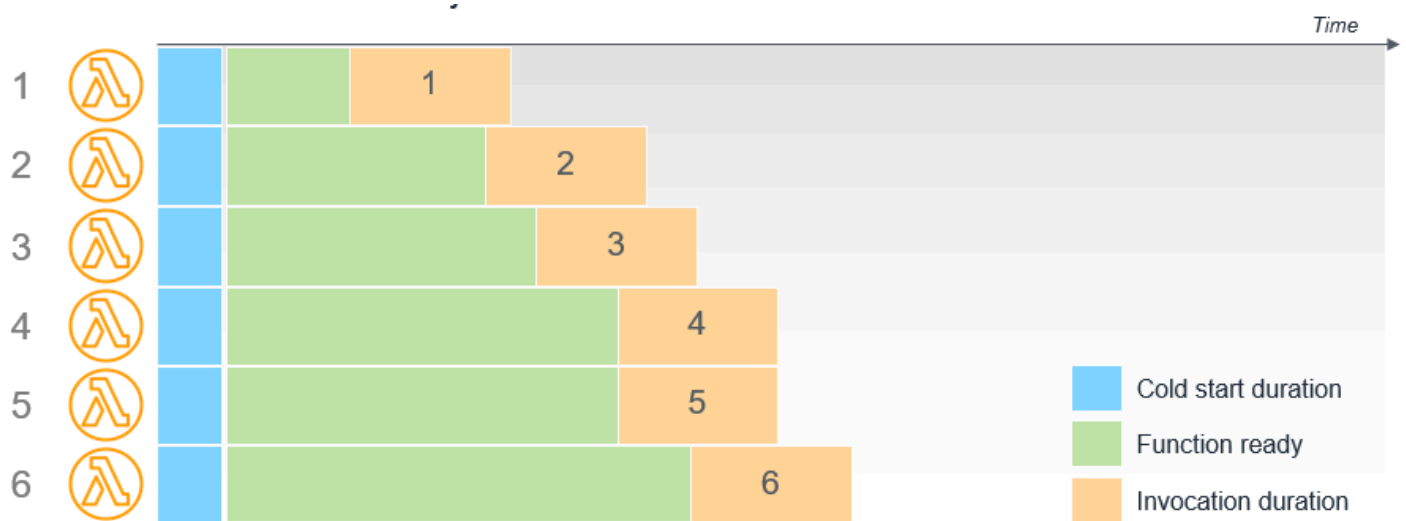

Optimizing static initialization

Static initialization happens before the handler code starts running in a function. This is the initialization code that you provide, that is outside of the main handler. This code is often used to import libraries and dependencies, set up configurations, and initialize connections to other services.

The following Python example shows importing, and configuring modules, and creating the Amazon S3 client during the initialization phase, before the `lambda_handler` function runs during `invoke`.

```
import os
import json
import cv2
import logging
import boto3

s3 = boto3.client('s3')
logger = logging.getLogger()
logger.setLevel(logging.INFO)

def lambda_handler(event, context):

    # Handler logic...
```

The largest contributor of latency before function execution comes from initialization code. This code runs when a new execution environment is created for the first time. The initialization code is not run again if an invocation uses a warm execution environment. Factors that affect initialization code latency include:

- The size of the function package, in terms of imported libraries and dependencies, and Lambda layers.
- The amount of code and initialization work.
- The performance of libraries and other services in setting up connections and other resources.

There are a number of steps that developers can take to optimize static initialization latency. If a function has many objects and connections, you may be able to rearchitect a single function into multiple, specialized functions. These are individually smaller and each have less initialization code.

It's important that functions only import the libraries and dependencies that they need. For example, if you only use Amazon DynamoDB in the AWS SDK, you can require an individual service instead of the entire SDK. Compare the following three examples:

```
// Instead of const AWS = require('aws-sdk'), use:
const DynamoDB = require('aws-sdk/clients/dynamodb')
```

```
// Instead of const AWSXRay = require('aws-xray-sdk'), use:  
const AWSXRay = require('aws-xray-sdk-core')  
  
// Instead of const AWS = AWSXRay.captureAWS(require('aws-sdk')), use:  
const dynamodb = new DynamoDB.DocumentClient()  
AWSXRay.captureAWSClient(dynamodb.service)
```

Static initialization is also often the best place to open database connections to allow a function to reuse connections over multiple invocations to the same execution environment. However, you may have large numbers of objects that are only used in certain execution paths in your function. In this case, you can lazily load variables in the global scope to reduce the static initialization duration.

Avoid global variables for context-specific information. If your function has a global variable that is used only for the lifetime of a single invocation and is reset for the next invocation, use a variable scope that is local to the handler. Not only does this prevent global variable leaks across invocations, it also improves the static initialization performance.

Understanding events and event-driven architectures

Some AWS services can directly invoke your Lambda functions. These services push events to your Lambda function. These *events* that trigger a Lambda function can be almost anything, from an HTTP request through API Gateway, a schedule managed by an EventBridge rule, an AWS IoT event, or an Amazon S3 event. When passed to your function, events are data structured in JSON format. The JSON structure varies depending on the service that generates it and the event type.

When a function is triggered by an event, this is called an *invocation*. While Lambda function invocations can last up to 15 minutes, Lambda is best-suited for short invocations that last one second or less. This is particularly true of *event-driven architectures*. In an event-driven architecture, each Lambda function is treated as a microservice, responsible for performing a narrow set of specific instructions.

Topics

- [Benefits of event-driven architectures](#)
- [Trade-offs of event-driven architectures](#)
- [Anti-patterns in Lambda-based event-driven applications](#)

Benefits of event-driven architectures

Replacing polling and webhooks with events

Many traditional architectures use polling and webhook mechanisms to communicate state between different components. Polling can be highly inefficient for fetching updates since there is a lag between new data becoming available and synchronization with downstream services. Webhooks are not always supported by other microservices that you want to integrate with. They may also require custom authorization and authentication configurations. In both cases, these integration methods are challenging to scale on-demand without additional work by development teams.

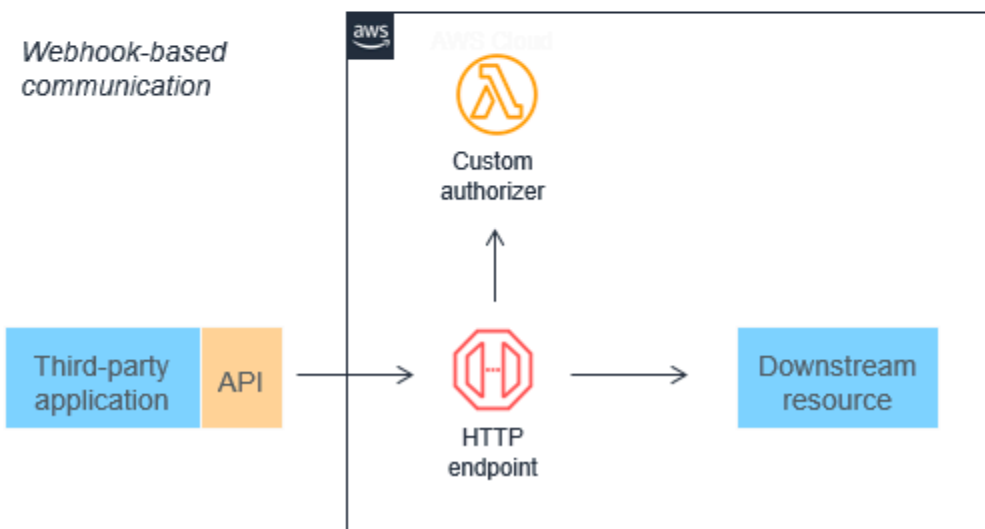
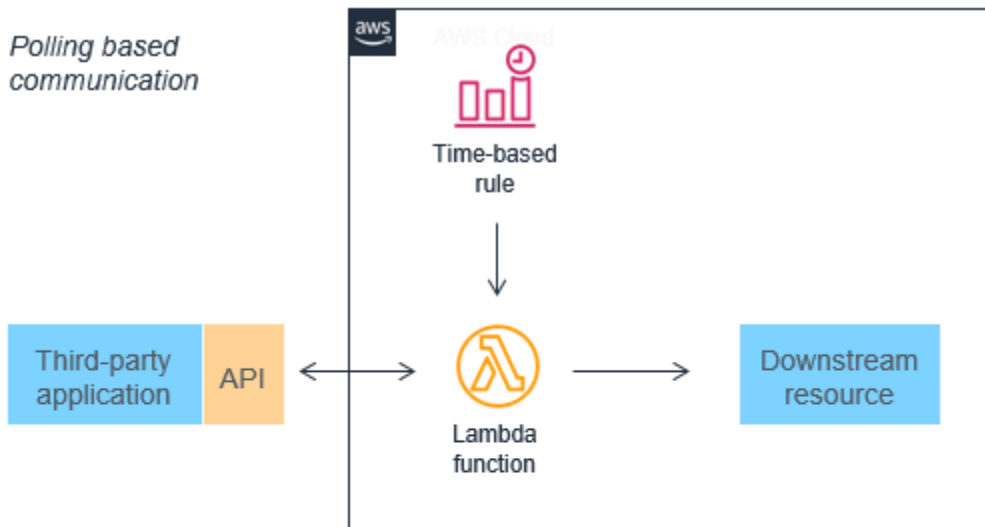

Both of these mechanisms can be replaced by events, which can be filtered, routed, and pushed downstream to consuming microservices. This approach can result in less bandwidth consumption, CPU utilization, and potentially lower cost. These architectures can also reduce complexity, since each functional unit is smaller and there is often less code.

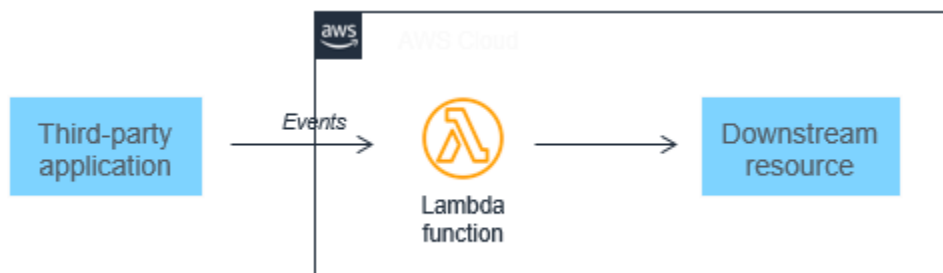

Event-driven architectures can also make it easier to design near-real-time systems, helping organizations move away from batch-based processing. Events are generated at the time when state in the application changes, so the custom code of a microservice should be designed to handle the processing of a single event. Since scaling is handled by the Lambda service, this architecture can handle significant increases in traffic without changing custom code. As events scale up, so does the compute layer that processes events.

Reducing complexity

Microservices enable developers and architects to decompose complex workflows. For example, an ecommerce monolith may be broken down into order acceptance and payment processes with separate inventory, fulfillment and accounting services. What may be complex to manage and orchestrate in a monolith becomes a series of decoupled services that communicate asynchronously with events.

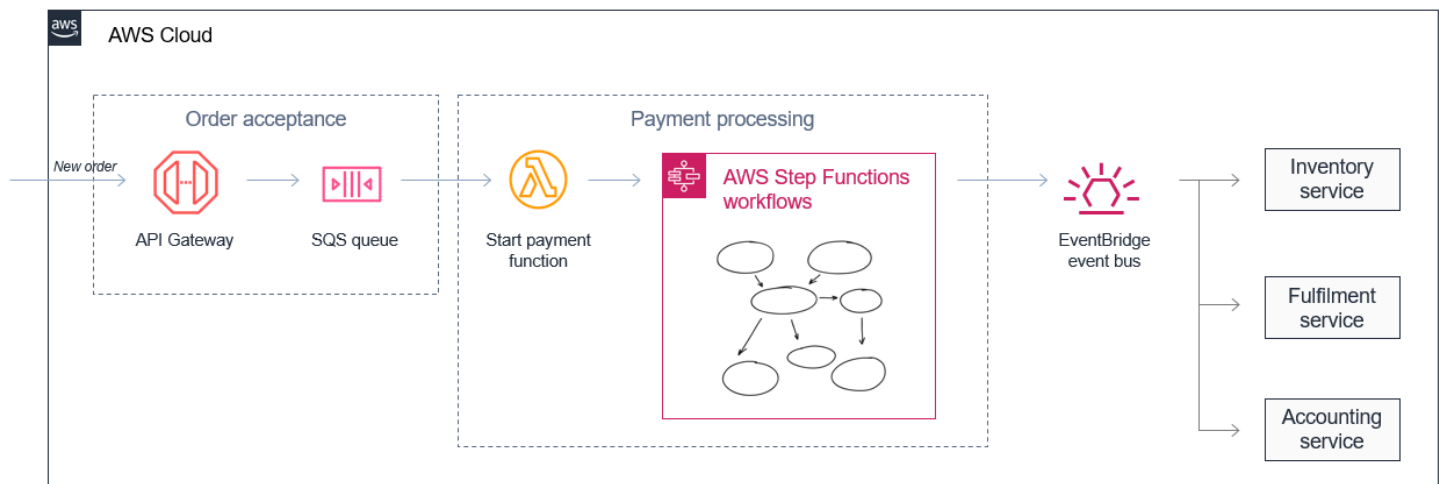

This approach also makes it possible to assemble services that process data at different rates. In this case, an order acceptance microservice can store high volumes of incoming orders by buffering the messages in an SQS queue.

A payment processing service, which is typically slower due to the complexity of handling payments, can take a steady stream of messages from the SQS queue. It can orchestrate complex retry and error handling logic using AWS Step Functions, and coordinate active payment workflows for hundreds of thousands of orders.

Improving scalability and extensibility

Microservices generate events that are typically published to messaging services like Amazon SNS and Amazon SQS. These behave like an elastic buffer between microservices and help handle

scaling when traffic increases. Services like Amazon EventBridge can then filter and route messages depending upon the content of the event, as defined in rules. As a result, event-based applications can be more scalable and offer greater redundancy than monolithic applications.

This system is also highly extensible, allowing other teams to extend features and add functionality without impacting the order processing and payment processing microservices. By publishing events using EventBridge, this application integrates with existing systems, such as the inventory microservice, but also enables any future application to integrate as an event consumer. Producers of events have no knowledge of event consumers, which can help simplify the microservice logic.

Trade-offs of event-driven architectures

Variable latency

Unlike monolithic applications, which may process everything within the same memory space on a single device, event-driven applications communicate across networks. This design introduces variable latency. While it's possible to engineer applications to minimize latency, monolithic applications can almost always be optimized for lower latency at the expense of scalability and availability.

Workloads that require consistent low-latency performance, such as high-frequency trading applications in banks or sub-millisecond robotics automation in warehouses, are not good candidates for event-driven architecture.

Eventual consistency

An event represents a change in state, and with many events flowing through different services in an architecture at any given point of time, such workloads are often [eventually consistent](#). This makes it more complex to process transactions, handle duplicates, or determine the exact overall state of a system.

Some workloads contain a combination of requirements that are eventually consistent (for example, total orders in the current hour) or strongly consistent (for example, current inventory). For workloads needing strong data consistency, there are architecture patterns to support this. For example:

- DynamoDB can provide [strongly consistent reads](#), sometimes at a higher latency, consuming a greater throughput than the default mode. DynamoDB can also [support transactions](#) to help maintain data consistency.

- You can use Amazon RDS for features needing [ACID properties](#), though relational databases are generally less scalable than NoSQL databases like DynamoDB. [Amazon RDS Proxy](#) can help manage connection pooling and scaling from ephemeral consumers like Lambda functions.

Event-based architectures are usually designed around individual events instead of large batches of data. Generally, workflows are designed to manage the steps of an individual event or execution flow instead of operating on multiple events simultaneously. In serverless, real-time event processing is preferred over batch processing: batches should be replaced with many smaller incremental updates. While this can make workloads more available and scalable, it also makes it more challenging for events to have awareness of other events.

Returning values to callers

In many cases, event-based applications are asynchronous. This means that caller services do not wait for requests from other services before continuing with other work. This is a fundamental characteristic of event-driven architectures that enables scalability and flexibility. This means that passing return values or the result of a workflow is more complex than in synchronous execution flows.

Most Lambda invocations in production systems are [asynchronous](#), responding to events from services like Amazon S3 or Amazon SQS. In these cases, the success or failure of processing an event is often more important than returning a value. Features such as [dead letter queues](#) (DLQs) in Lambda are provided to ensure you can identify and retry failed events, without needing to notify the caller.

Debugging across services and functions

Debugging event-driven systems is also different compared to a monolithic application. With different systems and services passing events, it's not possible to record and reproduce the exact state of multiple services when errors occur. Since each service and function invocation has separate log files, it can be more complicated to determine what happened to a specific event that caused an error.

There are three important requirements for building a successful debugging approach in event-driven systems. First, a robust logging system is critical, and this is provided across AWS services and embedded in Lambda functions by Amazon CloudWatch. Second, in these systems, it's important to ensure that every event has a transaction identifier that is logged at each step throughout a transaction, to help when searching for logs.

Finally, it's highly recommended to automate the parsing and analysis of logs by using a debugging and monitoring service like AWS X-Ray. This can consume logs across multiple Lambda invocations and services, making it much easier to pinpoint the root cause of issues. See [Troubleshooting walkthrough](#) for in-depth coverage of using X-Ray for troubleshooting.

Anti-patterns in Lambda-based event-driven applications

When building event-driven architectures with Lambda, be careful of anti-patterns that are technically functional, but may be suboptimal from an architecture and cost perspective. This section provides general guidance about these anti-patterns, but is not prescriptive.

The Lambda monolith

In many applications migrated from traditional servers, such as Amazon EC2 instances or Elastic Beanstalk applications, developers “lift and shift” existing code. Frequently, this results in a single Lambda function that contains all of the application logic that is triggered for all events. For a basic web application, a monolithic Lambda function would handle all API Gateway routes and integrate with all necessary downstream resources.

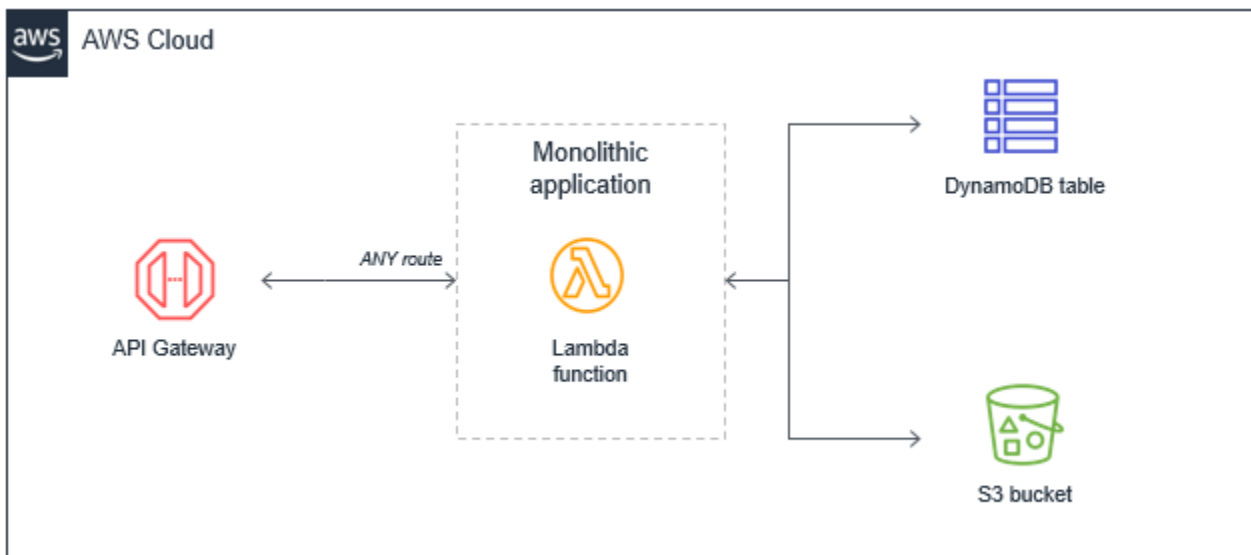

This approach has several drawbacks:

- **Package size** – The Lambda function may be much larger because it contains all possible code for all paths, which makes it slower for the Lambda service to run.
- **Hard to enforce least privilege** – The function's [execution role](#) must allow permissions to all resources needed for all paths, making the permissions very broad. This is a security concern. Many paths in the functional monolith do not need all the permissions that have been granted.

- **Harder to upgrade** – In a production system, any upgrades to the single function are more risky and could break the entire application. Upgrading a single path in the Lambda function is an upgrade to the entire function.
- **Harder to maintain** – It's more difficult to have multiple developers working on the service since it's a monolithic code repository. It also increases the cognitive burden on developers and makes it harder to create appropriate test coverage for code.
- **Harder to reuse code** – It's harder to separate reusable libraries from monoliths, making code reuse more difficult. As you develop and support more projects, this can make it harder to support the code and scale your team's velocity.
- **Harder to test** – As the lines of code increase, it becomes harder to unit test all the possible combinations of inputs and entry points in the code base. It's generally easier to implement unit testing for smaller services with less code.

The preferred alternative is to decompose the monolithic Lambda function into individual microservices, mapping a single Lambda function to a single, well-defined task. In this simple web application with a few API endpoints, the resulting microservice-based architecture can be based upon the API Gateway routes.

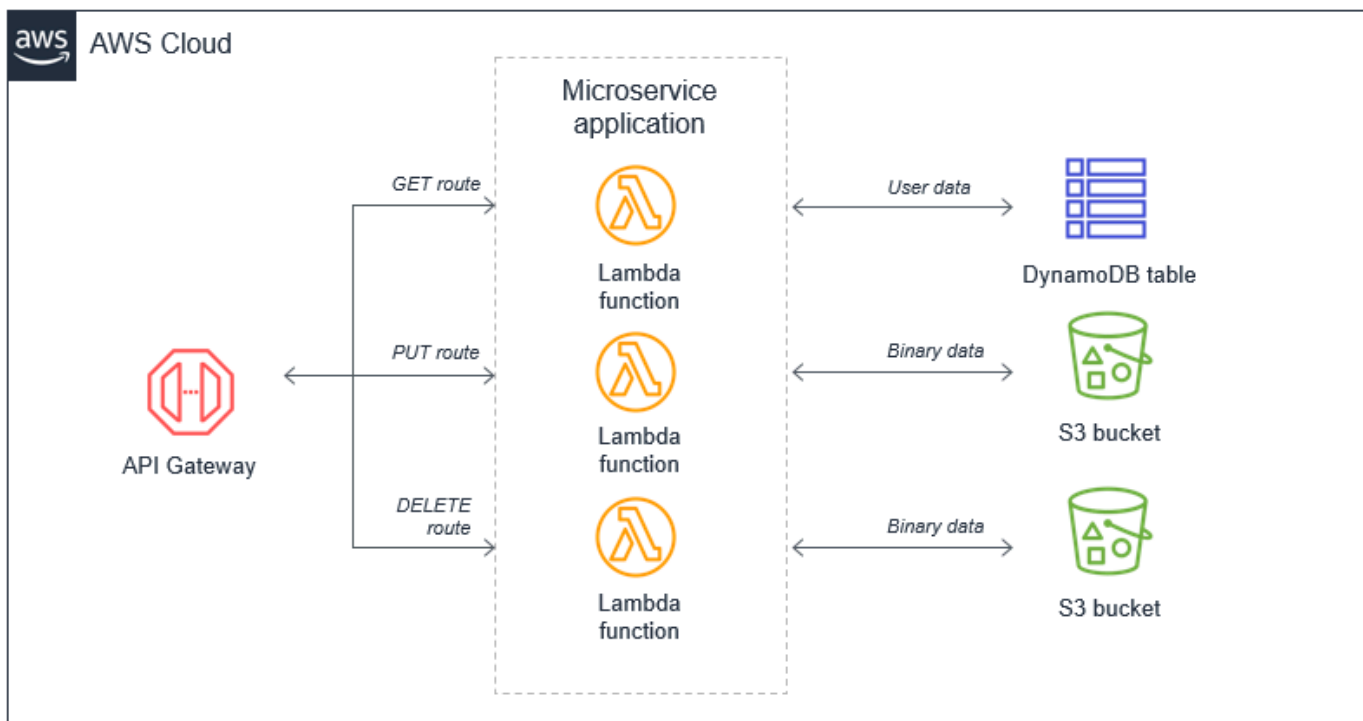

Recursive patterns that cause run-away Lambda functions

AWS services generate events that invoke Lambda functions, and Lambda functions can send messages to AWS services. Generally, the service or resource that invokes a Lambda function should be different to the service or resource that the function outputs to. Failure to manage this can result in infinite loops.

For example, a Lambda function writes an object to an Amazon S3 object, which in turn invokes the same Lambda function via a put event. The invocation causes a second object to be written to the bucket, which invokes the same Lambda function:

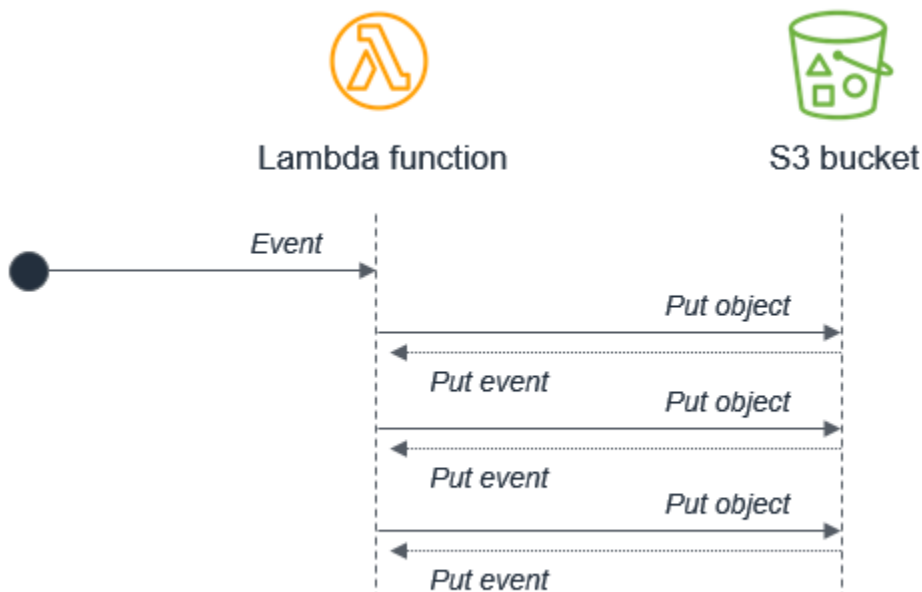

While the potential for infinite loops exists in most programming languages, this anti-pattern has the potential to consume more resources in serverless applications. Both Lambda and Amazon S3 automatically scale based upon traffic, so the loop may cause Lambda to scale to consume all available concurrency and Amazon S3 will continue to write objects and generate more events for Lambda.

This example uses S3, but the risk of recursive loops also exists in Amazon SNS, Amazon SQS, DynamoDB, and other services. You can use [recursive loop detection](#) to find and avoid this anti-pattern.

Lambda functions calling Lambda functions

Functions enable encapsulation and code re-use. Most programming languages support the concept of code synchronously calling functions within a code base. In this case, the caller waits until the function returns a response.

When this happens on a traditional server or virtual instance, the operating system scheduler switches to other available work. Whether the CPU runs at 0% or 100% does not affect the overall cost of the application, since you are paying for the fixed cost of owning and operating a server.

This model often does not adapt well to serverless development. For example, consider a simple ecommerce application consisting of three Lambda functions that process an order:

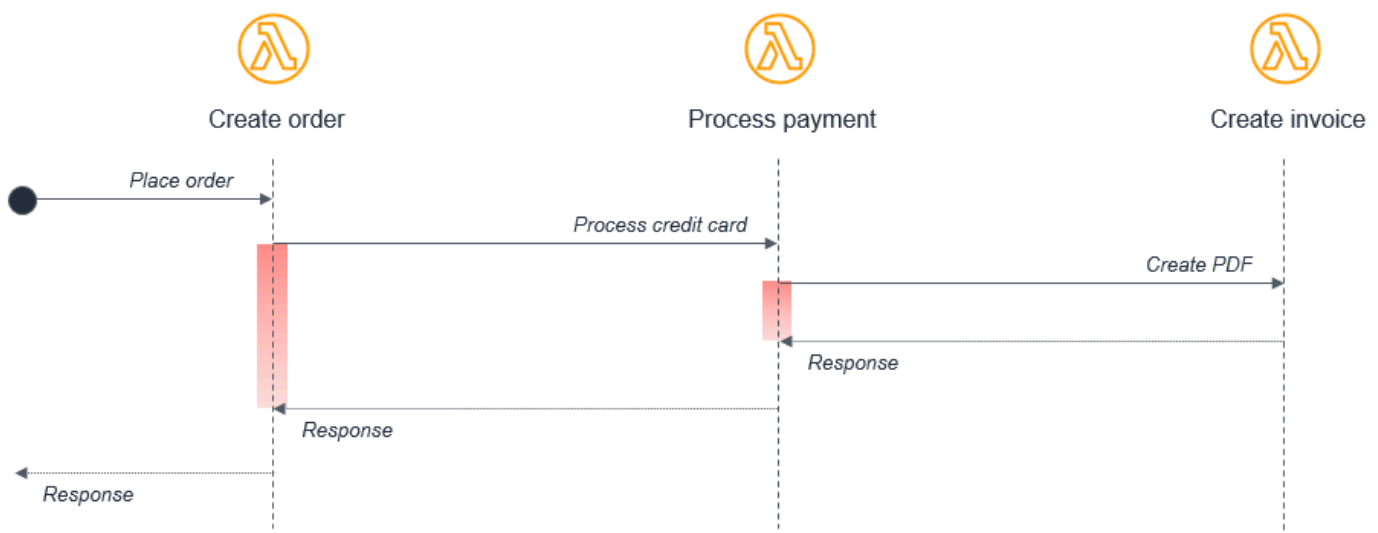

In this case, the *Create order* function calls the *Process payment* function, which in turn calls the *Create invoice* function. While this synchronous flow may work within a single application on a server, it introduces several avoidable problems in a distributed serverless architecture:

- **Cost** – With Lambda, you pay for the duration of an invocation. In this example, while the *Create invoice* functions runs, two other functions are also running in a wait state, shown in red on the diagram.
- **Error handling** – In nested invocations, error handling can become much more complex. For example, an error in *Create invoice* might require the *Process payment* function to reverse the charge, or it may instead retry the *Create invoice* process.
- **Tight coupling** – Processing a payment typically takes longer than creating an invoice. In this model, the availability of the entire workflow is limited by the slowest function.

- **Scaling** – The [concurrency](#) of all three functions must be equal. In a busy system, this uses more concurrency than would otherwise be needed.

In serverless applications, there are two common approaches to avoid this pattern. First, use an Amazon SQS queue between Lambda functions. If a downstream process is slower than an upstream process, the queue durably persists messages and decouples the two functions. In this example, the *Create order* function would publish a message to an SQS queue, and the *Process payment* function consumes messages from the queue.

The second approach is to use AWS Step Functions. For complex processes with multiple types of failure and retry logic, Step Functions can help reduce the amount of custom code needed to orchestrate the workflow. As a result, Step Functions orchestrates the work and robustly handles errors and retries, and the Lambda functions contain only business logic.

Synchronous waiting within a single Lambda function

Within a single Lambda, ensure that any potentially concurrent activities are not scheduled synchronously. For example, a Lambda function might write to an S3 bucket and then write to a DynamoDB table:



In this design, wait times are compounded because the activities are sequential. In cases where the second task depends on the completion of the first task, you can reduce the total waiting time and the cost of execution by have two separate Lambda functions:

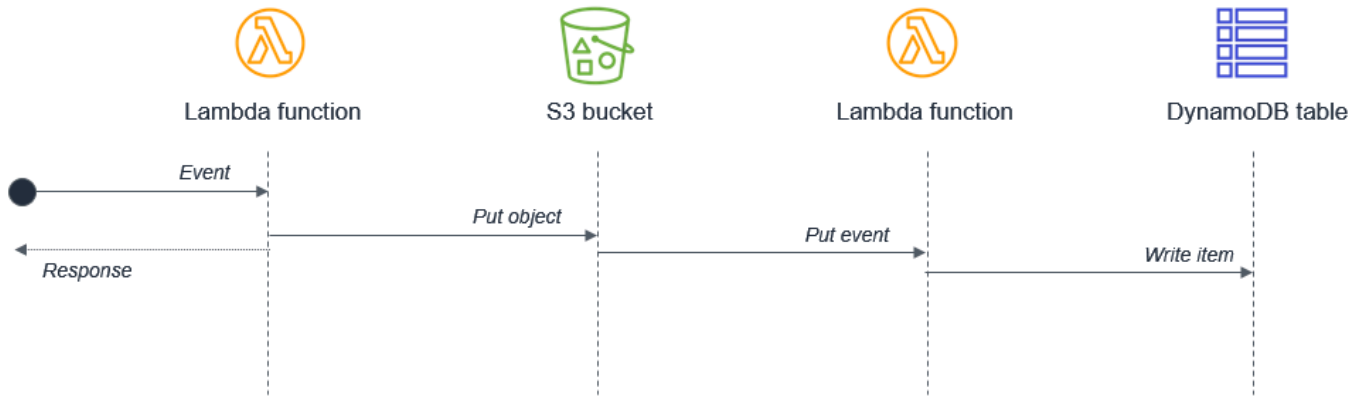

In this design, the first Lambda function responds immediately after putting the object to the Amazon S3 bucket. The S3 service invokes the second Lambda function, which then writes data to the DynamoDB table. This approach minimizes the total wait time in the Lambda function executions.

Lambda-based application design principles

A well-architected event-driven application uses a combination of AWS services and custom code to process and manage requests and data. This chapter focuses on Lambda-specific topics in application design. There are many important considerations for serverless architects when designing applications for busy production systems.

Many of the best practices that apply to software development and distributed systems also apply to serverless application development. The overall goal is to develop workloads that are:

- **Reliable** – offering your end users a high level of availability. AWS serverless services are reliable because they are also designed for failure.
- **Durable** – providing storage options that meet the durability needs of your workload.
- **Secure** – following best practices and using the tools provided to secure access to workloads and limit the blast radius.
- **Performant** – using computing resources efficiently and meeting the performance needs of your end users.
- **Cost-efficient**– designing architectures that avoid unnecessary cost that can scale without overspending, and also be decommissioned without significant overhead.

The following design principles can help you build workloads that meet these goals. Not every principle may apply to every architecture, but they should guide you in general architecture decisions.

Topics

- [Use services instead of custom code](#)
- [Understand Lambda abstraction levels](#)
- [Implement statelessness in functions](#)
- [Minimize coupling](#)
- [Build for on-demand data instead of batches](#)
- [Consider AWS Step Functions for orchestration](#)
- [Implement idempotency](#)
- [Use multiple AWS accounts for managing quotas](#)

Use services instead of custom code

Serverless applications usually comprise several AWS services, integrated with custom code run in Lambda functions. While Lambda can be integrated with most AWS services, the services most commonly used in serverless applications are:

Category	AWS service
Compute	AWS Lambda
Data storage	Amazon S3 Amazon DynamoDB Amazon RDS
API	Amazon API Gateway
Application integration	Amazon EventBridge Amazon SNS Amazon SQS
Orchestration	AWS Step Functions
Streaming data and analytics	Amazon Data Firehose

There are many well-established, common patterns in distributed architectures that you can build yourself or implement using AWS services. For most customers, there is little commercial value in investing time to develop these patterns from scratch. When your application needs one of these patterns, use the corresponding AWS service:

Pattern	AWS service
Queue	Amazon SQS
Event bus	Amazon EventBridge

Pattern	AWS service
Publish/subscribe (fan-out)	Amazon SNS
Orchestration	AWS Step Functions
API	Amazon API Gateway
Event streams	Amazon Kinesis

These services are designed to integrate with Lambda and you can use infrastructure as code (IaC) to create and discard resources in the services. You can use any of these services via the [AWS SDK](#) without needing to install applications or configure servers. Becoming proficient with using these services via code in your Lambda functions is an important step to producing well-designed serverless applications.

Understand Lambda abstraction levels

The Lambda service limits your access to the underlying operating systems, hypervisors, and hardware running your Lambda functions. The service continuously improves and changes infrastructure to add features, reduce cost and make the service more performant. Your code should assume no knowledge of how Lambda is architected and assume no hardware affinity.

Similarly, Lambda's integration with is managed by AWS with only a small number of configuration options exposed to you. For example, when API Gateway and Lambda interact, there is no concept of load balancing since it is entirely managed by the services. You also have no direct control over which [Availability Zones](#) the services use when invoking functions at any point in time, or how Lambda determines when to scale up or down the number of execution environments.

This abstraction allows you to focus on the integration aspects of your application, the flow of data, and the business logic where your workload provides value to your end users. Allowing the services to manage the underlying mechanics helps you develop applications more quickly with less custom code to maintain.

Implement statelessness in functions

When building Lambda functions, you should assume that the environment exists only for a single invocation. The function should initialize any required state when it is first started. For example,

your function may require fetching data from a DynamoDB table. It should commit any permanent data changes to a durable store such as Amazon S3, DynamoDB, or Amazon SQS before exiting. It should not rely on any existing data structures or temporary files, or any internal state that would be managed by multiple invocations.

To initialize database connections and libraries, or load state, you can take advantage of [static initialization](#). Since execution environments are reused where possible to improve performance, you can amortize the time taken to initialize these resources over multiple invocations. However, you should not store any variables or data used in the function within this global scope.

Minimize coupling

Most architectures should prefer many, shorter functions over fewer, larger ones. The purpose of each function should be to handle the event passed into the function, with no knowledge or expectations of the overall workflow or volume of transactions. This makes the function agnostic to the source of the event with minimal coupling to other services.

Any global-scope constants that change infrequently should be implemented as environment variables to allow updates without deployments. Any secrets or sensitive information should be stored in [AWS Systems Manager Parameter Store](#) or [AWS Secrets Manager](#) and loaded by the function. Since these resources are account-specific, this allows you to create build pipelines across multiple accounts. The pipelines load the appropriate secrets per environment, without exposing these to developers or requiring any code changes.

Build for on-demand data instead of batches

Many traditional systems are designed to run periodically and process batches of transactions that have built up over time. For example, a banking application may run every hour to process ATM transactions into central ledgers. In Lambda-based applications, the custom processing should be triggered by every event, allowing the service to scale up concurrency as needed, to provide near-real time processing of transactions.

While you can run [cron](#) tasks in serverless applications [by using scheduled expressions](#) for rules in Amazon EventBridge, these should be used sparingly or as a last-resort. In any scheduled task that processes a batch, there is the potential for the volume of transactions to grow beyond what can be processed within the 15-minute Lambda duration limit. If the limitations of external systems force you to use a scheduler, you should generally schedule for the shortest reasonable recurring time period.

For example, it's not best practice to use a batch process that triggers a Lambda function to fetch a list of new Amazon S3 objects. This is because the service may receive more new objects in between batches than can be processed within a 15-minute Lambda function.

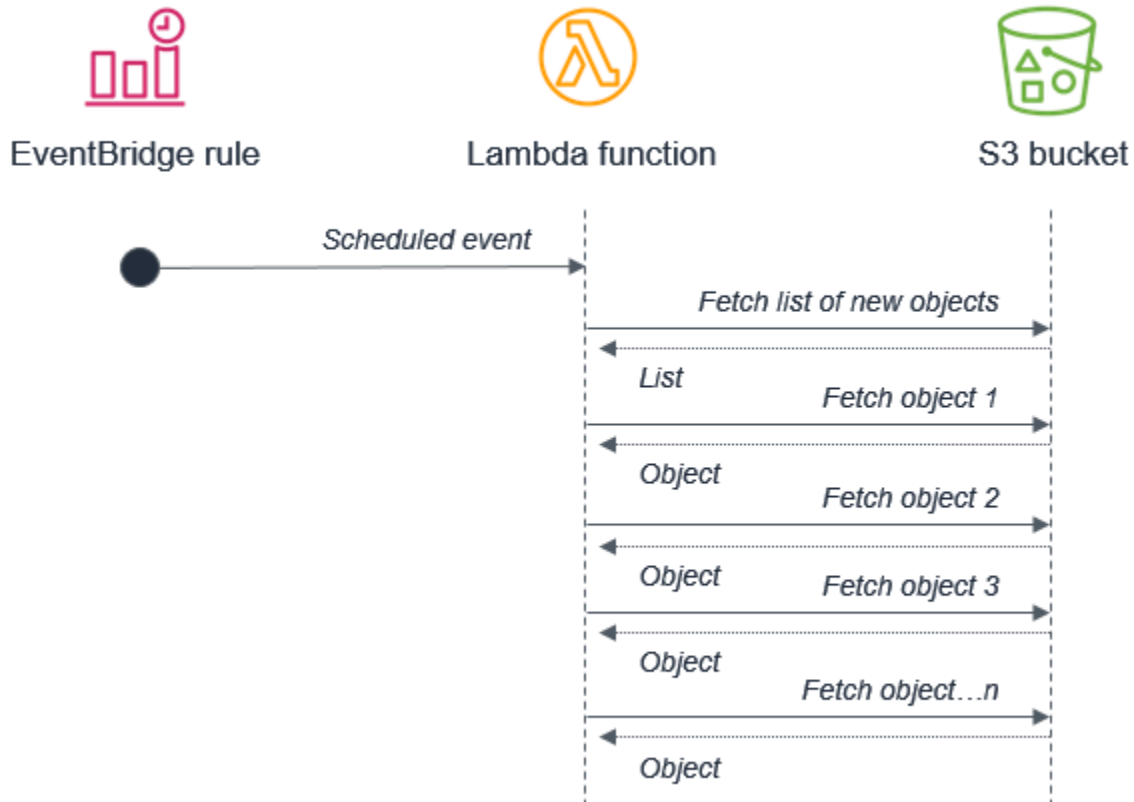

Instead, Amazon S3 should invoke the Lambda function each time a new object is put into the bucket. This approach is significantly more scalable and works in near-real time.



Consider AWS Step Functions for orchestration

Workflows that involve branching logic, different types of failure models, and retry logic typically use an orchestrator to keep track of the state of the overall execution. Avoid using Lambda functions for this purpose, since it results in tight coupling and complex code handling routing.

With [AWS Step Functions](#), you use state machines to manage orchestration. This extracts the error handling, routing, and branching logic from your code, replacing it with state machines declared using JSON. Apart from making workflows more robust and observable, it allows you to add versioning to workflows and make the state machine a codified resource that you can add to a code repository.

It's common for simpler workflows in Lambda functions to become more complex over time. When operating a production serverless application, it's important to identify when this is happening, so you can migrate this logic to a state machine.

Implement idempotency

AWS serverless services, including Lambda, are fault-tolerant and designed to handle failures. For example, if a service invokes a Lambda function and there is a service disruption, Lambda invokes your function in a different Availability Zone. If your function throws an error, Lambda retries the invocation.

Since the same event may be received more than once, functions should be designed to be [idempotent](#). This means that receiving the same event multiple times does not change the result beyond the first time the event was received.

You can implement idempotency in Lambda functions by using a DynamoDB table to track recently processed identifiers to determine if the transaction has already been handled previously. The DynamoDB table usually implements a [Time To Live \(TTL\)](#) value to expire items to limit the storage space used.

Use multiple AWS accounts for managing quotas

Many [service quotas](#) in AWS are set at the account level. This means that as you add more workloads, you can quickly exhaust your limits.

An effective way to solve this issue is to use multiple AWS accounts, dedicating each workload to its own account. This prevents quotas from being shared with other workloads or non-production resources.

In addition, by using [AWS Organizations](#), you can centrally manage the billing, compliance, and security of these accounts. You can attach policies to groups of accounts to avoid custom scripts and manual processes.

One common approach is to provide each developer with an AWS account, and then use separate accounts for a beta deployment stage and production:

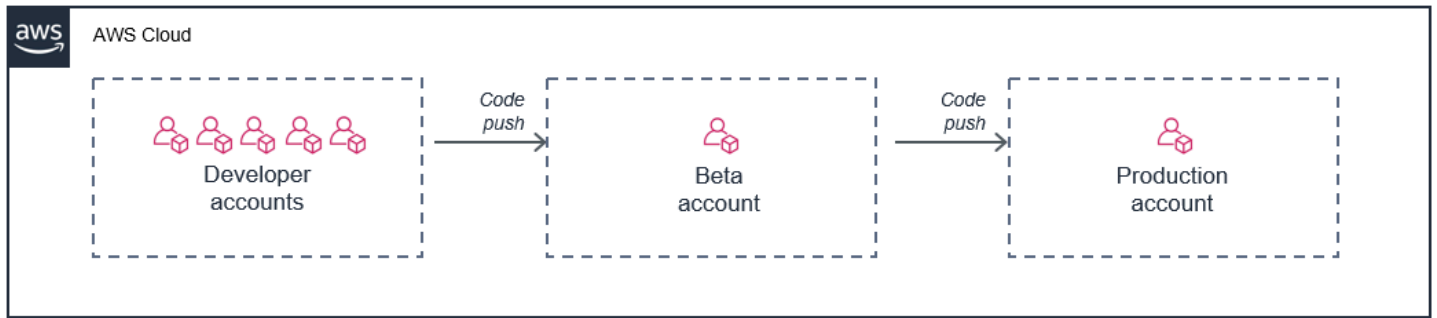

In this model, each developer has their own set of limits for the account, so their usage does not impact your production environment. This approach also allows developers to test Lambda functions locally on their development machines against live cloud resources in their individual accounts.

Frequently asked questions about Lambda

In many cases, separating functionality into different functions can provide better performance and also make an application more maintainable and scalable. However, Lambda “monoliths” may be a useful stepping stone in migrating an existing application.

How much functionality should a single Lambda function contain?

The function should perform a single task in the flow of data across AWS services in your microservice. However, if the functional task is too small, this may incur additional latency in the application and overhead in managing large numbers of functions. The exact scope of a function is determined by the use case.

Can Lambda-based applications work in multiple Regions?

Yes, many serverless services provide replication and support for multiple Regions, including DynamoDB and Amazon S3. Lambda functions can be deployed in multiple Regions as part of a deployment pipeline, and API Gateway can be configured to support this configuration. See this [example architecture](#) that shows how this can be achieved.

Can Lambda functions run on a timed schedule?

Yes, you can use scheduled expressions for rules in EventBridge to trigger a Lambda function. This format uses cron syntax and can be set with a one-minute granularity. See [this tutorial](#) for an example.

How can a Lambda function retain state between invocations?

In many cases, a DynamoDB table is an ideal way to retain since it provides low-latency data access and can scale with the Lambda service. You can also store data in [Amazon EFS for Lambda](#) if you are using this service, and this provides low-latency access to file system storage.

What types of workloads are suited to event-driven architectures?

Event-driven architectures communicate across different systems using networks, which introduce variable latency. For workloads that require very low latency, such as real-time trading systems, this design may not be the best choice. However, for highly scalable and available workloads, or those with unpredictable traffic patterns, event-driven architectures can provide an effective way to meet these demands.

Why does the Lambda service have a 15-minute limit for functions?

Lambda functions exist to process events and most events are processed very quickly – typically, under 1 second for the majority of production invocations. The duration of a function is determined by the time taken to process one event. While there are some compute-intensive workloads that can take several minutes, very few require 15 minutes to complete.

If you find that you need a longer duration, ensure that your function code is processing single events, performing single tasks, and using the best practices outlined in this document. In many cases, functions can be redesigned to process single events and reduce the amount of time needed to process.

Why is a function with reserved concurrency not scaling to meet incoming traffic?

Reserved concurrency for a Lambda function also acts as a maximum capacity value. Raising the soft limit on total concurrency does not affect this behavior. If you need a function with reserved concurrency to process more traffic, you can update the reserved concurrency value, which increases the maximum throughput of your function.

Why is a function with provisioned concurrency still experiencing cold starts?

You can measure cold starts as Lambda scales up by adding X-Ray monitoring to your function. A function using provisioned concurrency does not exhibit cold start behavior since the execution environment is prepared ahead of invocation. However, provisioned concurrency must be applied to a [specific version or alias](#) of a function, not the \$LATEST version. In cases where you continue to see cold start behavior, ensure that you are invoking the version of alias with provisioned concurrency configured.

What is the best runtime to use for my Lambda function?

Lambda is agnostic to your choice of runtime. For simple functions, interpreted languages like Python and Node.js offer the fastest performance. For functions with more complex computation, compiled languages like Java are often slower to initialize but run quickly in the Lambda handler. Choice of runtime is also influenced by developer preference and language familiarity.

How do I make sure that the SDK version doesn't change?

The embedded SDKs may change without notice as AWS releases new services and features. You can lock a version of the SDK by [creating a Lambda layer](#) with the specific version needed. The function then always uses the version in the layer, even if the version embedded in the service changes.

How can I test that a Lambda-based application can scale to meet the expected traffic?

To ensure that your application scales as expected, use load testing in your development process to simulate the expected level of traffic.

Which workloads are suitable for provisioned concurrency?

Provisioned concurrency is designed to make functions available with double-digit millisecond response times. Generally, interactive workloads benefit the most from the feature. Those are applications with users initiating requests, such as web and mobile applications, and are the most sensitive to latency. Asynchronous workloads, such as data processing pipelines, are often less latency sensitive and so do not usually need provisioned concurrency.

Why is my Lambda function not logging any output?

If a Lambda function is not logging to CloudWatch, first ensure that the function is being invoked by the caller. Check the logs of the calling service and any CloudWatch metrics that indicate an event has triggered the function. Next, check the CloudWatch Logs for the function. All Lambda functions log three lines, even if there is no other explicit logging in the custom code of the function:

▶	Timestamp	Message
		No older events at this moment. Retry
▶	2020-11-10T13:57:42.469-05:00	START RequestId: f6deb796-0eee-43a1-92c2-41aa94e71c11 Version: \$LATEST
▶	2020-11-10T13:57:42.471-05:00	END RequestId: f6deb796-0eee-43a1-92c2-41aa94e71c11
▶	2020-11-10T13:57:42.471-05:00	REPORT RequestId: f6deb796-0eee-43a1-92c2-41aa94e71c11 Duration: 1.93 ms

If there is no logging appearing in CloudWatch despite the function being invoked, check the permissions of the function. The IAM role must include logging permissions, or the function cannot write logs to the service. You can attach the [AWSLambdaBasicExecutionRole](#) policy to your function's execution role to grant these permissions.

Example serverless apps

The following examples provide function code and infrastructure as code (IaC) templates to quickly create and deploy serverless apps that implement some common Lambda use cases. The examples also include code examples and instructions to test the apps after you deploy them.

For each of the example apps, we provide instructions to either create and configure resources manually using the AWS Management Console, or to use the AWS Serverless Application Model to deploy the resources using IaC. Follow the console instructions to learn more about configuring the individual AWS resources for each app, or use AWS SAM to quickly deploy resources as you would in a production environment.

You can use the provided examples as a basis for your own serverless applications by modifying the provided function code and templates for your own use case.

We're continuing to create new examples, so check back again to find more serverless apps for common Lambda use cases.

Example apps

- [Example serverless file-processing app](#)

Create a serverless app to automatically perform a file-processing task when an object is uploaded to an Amazon S3 bucket. In this example, when a PDF file is uploaded, the app encrypts the file and saves it to another S3 bucket.

- [Example scheduled cron task app](#)

Create an app to perform a scheduled task using a cron schedule. In this example, the app performs maintenance on an Amazon DynamoDB table by deleting entries more than 12 months old.

Create a serverless file-processing app

One of the most common use cases for Lambda is to perform file processing tasks. For example, you might use a Lambda function to automatically create PDF files from HTML files or images, or to create thumbnails when a user uploads an image.

In this example, you create an app which automatically encrypts PDF files when they are uploaded to an Amazon Simple Storage Service (Amazon S3) bucket. To implement this app, you create the following resources:

- An S3 bucket for users to upload PDF files to
- A Lambda function in Python which reads the uploaded file and creates an encrypted, password-protected version of it
- A second S3 bucket for Lambda to save the encrypted file in

You also create an AWS Identity and Access Management (IAM) policy to give your Lambda function permission to perform read and write operations on your S3 buckets.

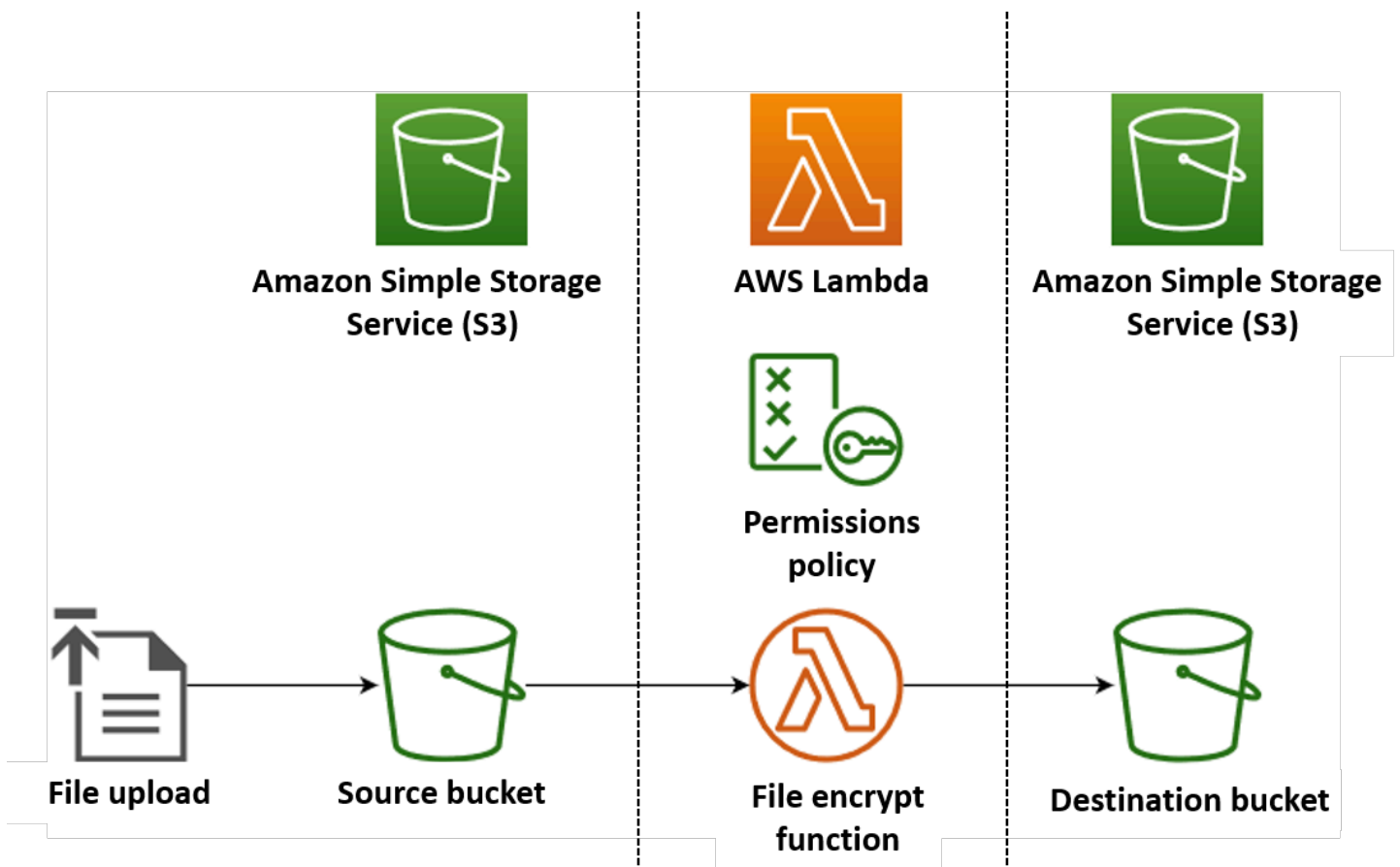

Tip

If you're brand new to Lambda, we recommend that you start with the tutorial [Create your first function](#) before creating this example app.

You can deploy your app manually by creating and configuring resources with the AWS Management Console or the AWS Command Line Interface (AWS CLI). You can also deploy the app by using the AWS Serverless Application Model (AWS SAM). AWS SAM is an infrastructure as code (IaC) tool. With IaC, you don't create resources manually, but define them in code and then deploy them automatically.

If you want to learn more about using Lambda with IaC before deploying this example app, see [Infrastructure as code \(IaC\)](#).

Create the Lambda function source code files

Create the following files in your project directory:

- `lambda_function.py` - the Python function code for the Lambda function that performs the file encryption
- `requirements.txt` - a manifest file defining the dependencies that your Python function code requires

Expand the following sections to view the code and to learn more about the role of each file. To create the files on your local machine, either copy and paste the code below, or download the files from the [aws-lambda-developer-guide GitHub repo](#).

Python function code

Copy and paste the following code into a file named `lambda_function.py`.

```
from pypdf import PdfReader, PdfWriter
import uuid
import os
from urllib.parse import unquote_plus
import boto3

# Create the S3 client to download and upload objects from S3
s3_client = boto3.client('s3')
```

```
def lambda_handler(event, context):
    # Iterate over the S3 event object and get the key for all uploaded files
    for record in event['Records']:
        bucket = record['s3']['bucket']['name']
        key = unquote_plus(record['s3']['object']['key']) # Decode the S3 object key to
        # remove any URL-encoded characters
        download_path = f'/tmp/{uuid.uuid4()}.pdf' # Create a path in the Lambda tmp
        # directory to save the file to
        upload_path = f'/tmp/converted-{uuid.uuid4()}.pdf' # Create another path to
        # save the encrypted file to

        # If the file is a PDF, encrypt it and upload it to the destination S3 bucket
        # if key.lower().endswith('.pdf'):
        s3_client.download_file(bucket, key, download_path)
        encrypt_pdf(download_path, upload_path)
        encrypted_key = add_encrypted_suffix(key)
        s3_client.upload_file(upload_path, f'{bucket}-encrypted', encrypted_key)

# Define the function to encrypt the PDF file with a password
def encrypt_pdf(file_path, encrypted_file_path):
    reader = PdfReader(file_path)
    writer = PdfWriter()

    for page in reader.pages:
        writer.add_page(page)

    # Add a password to the new PDF
    writer.encrypt("my-secret-password")

    # Save the new PDF to a file
    with open(encrypted_file_path, "wb") as file:
        writer.write(file)

# Define a function to add a suffix to the original filename after encryption
def add_encrypted_suffix(original_key):
    filename, extension = original_key.rsplit('.', 1)
    return f'{filename}_encrypted.{extension}'
```

Note

In this example code, a password for the encrypted file (`my-secret-password`) is hardcoded into the function code. In a production application, don't include sensitive

information like passwords in your function code. Use AWS Secrets Manager to securely store sensitive parameters.

The python function code contains three functions - the [handler function](#) that Lambda runs when your function is invoked, and two separate function named `add_encrypted_suffix` and `encrypt_pdf` that the handler calls to perform the PDF encryption.

When your function is invoked by Amazon S3, Lambda passes a JSON formatted *event* argument to the function that contains details about the event that caused the invocation. In this case, the information includes name of the S3 bucket and the object keys for the uploaded files. To learn more about the format of event object for Amazon S3, see [the section called "S3"](#).

Your function then uses the AWS SDK for Python (Boto3) to download the PDF files specified in the event object to its local temporary storage directory, before encrypting them using the [pypdf](#) library.

Finally, the function uses the Boto3 SDK to store the encrypted file in your S3 destination bucket.

requirements.txt manifest file

Copy and paste the following code into a file named `requirements.txt`.

```
boto3
pypdf
```

For this example, your function code has only two dependencies that aren't part of the standard Python library - the SDK for Python (Boto3) and the `pypdf` package the function uses to perform the PDF encryption.

Note

A version of the SDK for Python (Boto3) is included as part of the Lambda runtime, so your code would run without adding Boto3 to your function's deployment package. However, to maintain full control of your function's dependencies and avoid possible issues with version misalignment, best practice for Python is to include all function dependencies in your function's deployment package. See [the section called "Runtime dependencies in Python"](#) to learn more.

Deploy the app

You can create and deploy the resources for this example app either manually or by using AWS SAM. In a production environment, we recommend that you use an IaC tool like AWS SAM to quickly and repeatably deploy whole serverless applications without using manual processes.

Deploy the resources manually

To deploy your app manually:

- Create source and destination Amazon S3 buckets
- Create a Lambda function that encrypts a PDF file and saves the encrypted version to an S3 bucket
- Configure a Lambda trigger that invokes your function when objects are uploaded to your source bucket

Before you begin, make sure that [Python](#) is installed on your build machine.

Create two S3 buckets

First create two S3 buckets. The first bucket is the source bucket you will upload your PDF files to. The second bucket is used by Lambda to save the encrypted file when you invoke your function.

Console

To create the S3 buckets (console)

1. Open the [Buckets](#) page of the Amazon S3 console.
2. Choose **Create bucket**.
3. Under **General configuration**, do the following:
 - a. For **Bucket name**, enter a globally unique name that meets the Amazon S3 [bucket naming rules](#). Bucket names can contain only lower case letters, numbers, dots (.), and hyphens (-).
 - b. For **AWS Region**, choose the [AWS Region](#) closest to your geographical location. Later in the deployment process, you must create your Lambda function in the same AWS Region, so make a note of the region you chose.
4. Leave all other options set to their default values and choose **Create bucket**.

- Repeat steps 1 to 4 to create your destination bucket. For **Bucket name**, enter **amzn-s3-demo-bucket-encrypted**, where **amzn-s3-demo-bucket** is the name of the source bucket you just created.

AWS CLI

Before you begin, make sure that the [AWS CLI is installed](#) on your build machine.

To create the Amazon S3 buckets (AWS CLI)

- Run the following CLI command to create your source bucket. The name you choose for your bucket must be globally unique and follow the Amazon S3 [bucket naming rules](#). Names can only contain lower case letters, numbers, dots (.), and hyphens (-). For `region` and `LocationConstraint`, choose the [AWS Region](#) closest to your geographical location.

```
aws s3api create-bucket --bucket amzn-s3-demo-bucket --region us-east-2 \  
--create-bucket-configuration LocationConstraint=us-east-2
```

Later in the tutorial, you must create your Lambda function in the same AWS Region as your source bucket, so make a note of the region you chose.

- Run the following command to create your destination bucket. For the bucket name, you must use **amzn-s3-demo-bucket-encrypted**, where **amzn-s3-demo-bucket** is the name of the source bucket you created in step 1. For `region` and `LocationConstraint`, choose the same AWS Region you used to create your source bucket.

```
aws s3api create-bucket --bucket amzn-s3-demo-bucket-encrypted --region us-east-2 \  
--create-bucket-configuration LocationConstraint=us-east-2
```

Create an execution role (AWS CLI only)

An execution role is an IAM role that grants a Lambda function permission to access AWS services and resources. When you create a function using the Lambda console, Lambda automatically creates an execution role. You only need to create a role manually if you choose to deploy the app using the AWS CLI. To give your function read and write access to Amazon S3, you attach the [AWS managed policy](#) `AmazonS3FullAccess`.

Console

This step is only required if you choose to deploy your app using the AWS CLI.

AWS CLI

To create an execution role and attach the AmazonS3FullAccess managed policy (AWS CLI)

1. Save the following JSON in a file named `trust-policy.json`. This trust policy allows Lambda to use the role's permissions by giving the service principal `lambda.amazonaws.com` permission to call the AWS Security Token Service (AWS STS) `AssumeRole` action.

```
{
  "Version": "2012-10-17",
  "Statement": [
    {
      "Effect": "Allow",
      "Principal": {
        "Service": "lambda.amazonaws.com"
      },
      "Action": "sts:AssumeRole"
    }
  ]
}
```

2. From the directory you saved the JSON trust policy document in, run the following CLI command to create the execution role.

```
aws iam create-role --role-name LambdaS3Role --assume-role-policy-document
file://trust-policy.json
```

3. To attach the AmazonS3FullAccess managed policy, run the following CLI command.

```
aws iam attach-role-policy --role-name LambdaS3Role --policy-arn
arn:aws:iam::aws:policy/AmazonS3FullAccess
```

Create the function deployment package

To create your function, you create a *deployment package* containing your function code and its dependencies. For this application, your function code uses a separate library for the PDF encryption.

To create the deployment package

1. Navigate to the project directory containing the `lambda_function.py` and `requirements.txt` files you created or downloaded from GitHub earlier and create a new directory named `package`.
2. Install the dependencies specified in the `requirements.txt` file in your package directory by running the following command.

```
pip install -r requirements.txt --target ./package/
```

3. Create a `.zip` file containing your application code and its dependencies. In Linux or MacOS, run the following commands from your command line interface.

```
cd package
zip -r ../lambda_function.zip .
cd ..
zip lambda_function.zip lambda_function.py
```

In Windows, use your preferred zip tool to create the `lambda_function.zip` file. Make sure that your `lambda_function.py` file and the folders containing your dependencies are all at the root of the `.zip` file.

You can also create your deployment package using a Python virtual environment. See [Working with .zip file archives for Python Lambda functions](#)

Create the Lambda function

You now use the deployment package you created in the previous step to deploy your Lambda function.

Console

To create the function (console)

To create your Lambda function using the console, you first create a basic function containing some 'Hello world' code. You then replace this code with your own function code by uploading the.zip file you created in the previous step.

To ensure that your function doesn't time out when encrypting large PDF files, you configure the function's memory and timeout settings. You also set the function's log format to JSON. Configuring JSON formatted logs is necessary when using the provided test script so it can read the function's invocation status from CloudWatch Logs to confirm successful invocation.

1. Open the [Functions page](#) of the Lambda console.
2. Make sure you're working in the same AWS Region you created your S3 bucket in. You can change your region using the drop-down list at the top of the screen.

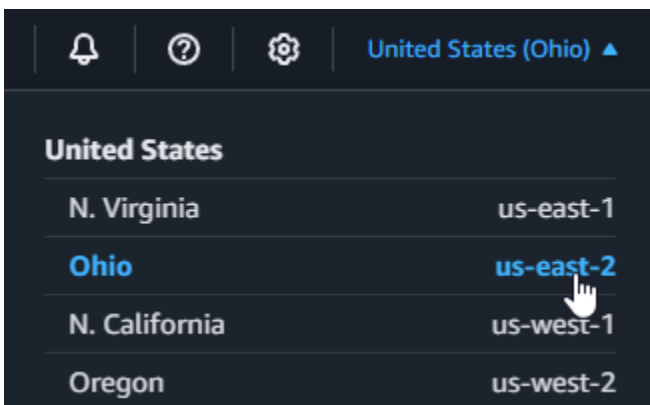

3. Choose **Create function**.
4. Choose **Author from scratch**.
5. Under **Basic information**, do the following:
 - a. For **Function name**, enter **EncryptPDF**.
 - b. For **Runtime** choose **Python 3.12**.
 - c. For **Architecture**, choose **x86_64**.
6. Choose **Create function**.

To upload the function code (console)

1. In the **Code source** pane, choose **Upload from**.

2. Choose **.zip file**.
3. Choose **Upload**.
4. In the file selector, select your .zip file and choose **Open**.
5. Choose **Save**.

To configure the function memory and timeout (console)

1. Select the **Configuration** tab for your function.
2. In the **General configuration** pane, choose **Edit**.
3. Set **Memory** to 256 MB and **Timeout** to 15 seconds.
4. Choose **Save**.

To configure the log format (console)

1. Select the **Configuration** tab for your function.
2. Select **Monitoring and operations tools**.
3. In the **Logging configuration** pane, choose **Edit**.
4. For **Logging configuration**, select **JSON**.
5. Choose **Save**.

AWS CLI

To create the function (AWS CLI)

- Run the following command from the directory containing your `lambda_function.zip` file. For the `region` parameter, replace `us-east-2` with the region you created your S3 buckets in.

```
aws lambda create-function --function-name EncryptPDF \  
--zip-file fileb://lambda_function.zip --handler lambda_function.lambda_handler \  
\   
--runtime python3.12 --timeout 15 --memory-size 256 \  
--role arn:aws:iam::123456789012:role/LambdaS3Role --region us-east-2 \  
--logging-config LogFormat=JSON
```

Configure an Amazon S3 trigger to invoke the function

For your Lambda function to run when you upload a file to your source bucket, you need to configure a trigger for your function. You can configure the Amazon S3 trigger using either the console or the AWS CLI.

Important

This procedure configures the S3 bucket to invoke your function every time that an object is created in the bucket. Be sure to configure this only on the source bucket. If your Lambda function creates objects in the same bucket that invokes it, your function can be [invoked continuously in a loop](#). This can result in un expected charges being billed to your AWS account.

Console

To configure the Amazon S3 trigger (console)

1. Open the [Functions page](#) of the Lambda console and choose your function (EncryptPDF).
2. Choose **Add trigger**.
3. Select **S3**.
4. Under **Bucket**, select your source bucket.
5. Under **Event types**, select **All object create events**.
6. Under **Recursive invocation**, select the check box to acknowledge that using the same S3 bucket for input and output is not recommended. You can learn more about recursive invocation patterns in Lambda by reading [Recursive patterns that cause run-away Lambda functions](#) in Serverless Land.
7. Choose **Add**.

When you create a trigger using the Lambda console, Lambda automatically creates a [resource based policy](#) to give the service you select permission to invoke your function.

AWS CLI

To configure the Amazon S3 trigger (AWS CLI)

1. Add a [resource based policy](#) to your function that allows your Amazon S3 source bucket to invoke your function when you add a file. A resource-based policy statement gives other AWS services permission to invoke your function. To give Amazon S3 permission to invoke your function, run the following CLI command. Be sure to replace the source-account parameter with your own AWS account ID and to use your own source bucket name.

```
aws lambda add-permission --function-name EncryptPDF \  
--principal s3.amazonaws.com --statement-id s3invoke --action \  
"lambda:InvokeFunction" \  
--source-arn arn:aws:s3:::amzn-s3-demo-bucket \  
--source-account 123456789012
```

The policy you define with this command allows Amazon S3 to invoke your function only when an action takes place on your source bucket.

Note

Although S3 bucket names are globally unique, when using resource-based policies it is best practice to specify that the bucket must belong to your account. This is because if you delete a bucket, it is possible for another AWS account to create a bucket with the same Amazon Resource Name (ARN).

2. Save the following JSON in a file named `notification.json`. When applied to your source bucket, this JSON configures the bucket to send a notification to your Lambda function every time a new object is added. Replace the AWS account number and AWS Region in the Lambda function ARN with your own account number and region.

```
{  
  "LambdaFunctionConfigurations": [  
    {  
      "Id": "EncryptPDFEventConfiguration",  
      "LambdaFunctionArn": "arn:aws:lambda:us-  
east-2:123456789012:function:EncryptPDF",  
      "Events": [ "s3:ObjectCreated:Put" ]  
    }  
  ]  
}
```

```
}
```

3. Run the following CLI command to apply the notification settings in the JSON file you created to your source bucket. Replace `amzn-s3-demo-bucket` with the name of your own source bucket.

```
aws s3api put-bucket-notification-configuration --bucket amzn-s3-demo-bucket \  
--notification-configuration file://notification.json
```

To learn more about the `put-bucket-notification-configuration` command and the `notification-configuration` option, see [put-bucket-notification-configuration](#) in the *AWS CLI Command Reference*.

Deploy the resources using AWS SAM

Before you begin, make sure that [Docker](#) and [the latest version of the AWS SAM CLI](#) are installed on your build machine.

1. In your project directory, copy and paste the following code into a file named `template.yaml`. Replace the placeholder bucket names:
 - For the source bucket, replace `amzn-s3-demo-bucket` with any name that complies with the [S3 bucket naming rules](#).
 - For the destination bucket, replace `amzn-s3-demo-bucket-encrypted` with `<source-bucket-name>-encrypted`, where `<source-bucket>` is the name you chose for your source bucket.

```
AWSTemplateFormatVersion: '2010-09-09'  
Transform: AWS::Serverless-2016-10-31  
  
Resources:  
  EncryptPDFFunction:  
    Type: AWS::Serverless::Function  
    Properties:  
      FunctionName: EncryptPDF  
      Architectures: [x86_64]  
      CodeUri: ./  
      Handler: lambda_function.lambda_handler  
      Runtime: python3.12
```

```
Timeout: 15
MemorySize: 256
LoggingConfig:
  LogFormat: JSON
Policies:
  - AmazonS3FullAccess
Events:
  S3Event:
    Type: S3
    Properties:
      Bucket: !Ref PDFSourceBucket
      Events: s3:ObjectCreated:*

PDFSourceBucket:
  Type: AWS::S3::Bucket
  Properties:
    BucketName: amzn-s3-demo-bucket

EncryptedPDFBucket:
  Type: AWS::S3::Bucket
  Properties:
    BucketName: amzn-s3-demo-bucket-encrypted
```

The AWS SAM template defines the resources you create for your app. In this example, the template defines a Lambda function using the `AWS::Serverless::Function` type and two S3 buckets using the `AWS::S3::Bucket` type. The bucket names specified in the template are placeholders. Before you deploy the app using AWS SAM, you need to edit the template to rename the buckets with globally unique names that meet the [S3 bucket naming rules](#). This step is explained further in [the section called “Deploy the resources using AWS SAM”](#).

The definition of the Lambda function resource configures a trigger for the function using the `S3Event` event property. This trigger causes your function to be invoked whenever an object is created in your source bucket.

The function definition also specifies an AWS Identity and Access Management (IAM) policy to be attached to the function's [execution role](#). The [AWS managed policy](#) `AmazonS3FullAccess` gives your function the permissions it needs to read and write objects to Amazon S3.

2. Run the following command from the directory in which you saved your `template.yaml`, `lambda_function.py`, and `requirements.txt` files.

```
sam build --use-container
```

This command gathers the build artifacts for your application and places them in the proper format and location to deploy them. Specifying the `--use-container` option builds your function inside a Lambda-like Docker container. We use it here so you don't need to have Python 3.12 installed on your local machine for the build to work.

During the build process, AWS SAM looks for the Lambda function code in the location you specified with the `CodeUri` property in the template. In this case, we specified the current directory as the location (`./`).

If a `requirements.txt` file is present, AWS SAM uses it to gather the specified dependencies. By default, AWS SAM creates a `.zip` deployment package with your function code and dependencies. You can also choose to deploy your function as a container image using the [PackageType](#) property.

3. To deploy your application and create the Lambda and Amazon S3 resources specified in your AWS SAM template, run the following command.

```
sam deploy --guided
```

Using the `--guided` flag means that AWS SAM will show you prompts to guide you through the deployment process. For this deployment, accept the default options by pressing Enter.

During the deployment process, AWS SAM creates the following resources in your AWS account:

- An AWS CloudFormation [stack](#) named `sam-app`
- A Lambda function with the name `EncryptPDF`
- Two S3 buckets with the names you chose when you edited the `template.yaml` AWS SAM template file
- An IAM execution role for your function with the name format `sam-app-EncryptPDFFunctionRole-2qGaapHFWOQ8`

When AWS SAM finishes creating your resources, you should see the following message:

```
Successfully created/updated stack - sam-app in us-east-2
```

Test the app

To test your app, upload a PDF file to your source bucket, and confirm that Lambda creates an encrypted version of the file in your destination bucket. In this example, you can either test this manually using the console or the AWS CLI, or by using the provided test script.

For production applications, you can use traditional test methods and techniques, such as unit testing, to confirm the correct functioning of your Lambda function code. Best practice is also to conduct tests like those in the provided test script which perform integration testing with real, cloud-based resources. Integration testing in the cloud confirms that your infrastructure has been correctly deployed and that events flow between different services as expected. To learn more, see [Testing serverless functions](#).

Testing the app manually

You can test your function manually by adding a PDF file to your Amazon S3 source bucket. When you add your file to the source bucket, your Lambda function should be automatically invoked and should store an encrypted version of the file in your target bucket.

Console

To test your app by uploading a file (console)

1. To upload a PDF file to your S3 bucket, do the following:
 - a. Open the [Buckets](#) page of the Amazon S3 console and choose your source bucket.
 - b. Choose **Upload**.
 - c. Choose **Add files** and use the file selector to choose the PDF file you want to upload.
 - d. Choose **Open**, then choose **Upload**.
2. Verify that Lambda has saved an encrypted version of your PDF file in your target bucket by doing the following:
 - a. Navigate back to the [Buckets](#) page of the Amazon S3 console and choose your destination bucket.
 - b. In the **Objects** pane, you should now see a file with name format `filename_encrypted.pdf` (where `filename.pdf` was the name of the file you uploaded to your source bucket). To download your encrypted PDF, select the file, then choose **Download**.

- c. Confirm that you can open the downloaded file with the password your Lambda function protected it with (`my-secret-password`).

AWS CLI

To test your app by uploading a file (AWS CLI)

1. From the directory containing the PDF file you want to upload, run the following CLI command. Replace the `--bucket` parameter with the name of your source bucket. For the `--key` and `--body` parameters, use the filename of your test file.

```
aws s3api put-object --bucket amzn-s3-demo-bucket --key test.pdf --body ./test.pdf
```

2. Verify that your function has created an encrypted version of your file and saved it to your target S3 bucket. Run the following CLI command, replacing `amzn-s3-demo-bucket-encrypted` with the name of your own destination bucket.

```
aws s3api list-objects-v2 --bucket amzn-s3-demo-bucket-encrypted
```

If your function runs successfully, you'll see output similar to the following. Your target bucket should contain a file with the name format `<your_test_file>_encrypted.pdf`, where `<your_test_file>` is the name of the file you uploaded.

```
{
  "Contents": [
    {
      "Key": "test_encrypted.pdf",
      "LastModified": "2023-06-07T00:15:50+00:00",
      "ETag": "\"7781a43e765a8301713f533d70968a1e\"",
      "Size": 2763,
      "StorageClass": "STANDARD"
    }
  ]
}
```

3. To download the file that Lambda saved in your destination bucket, run the following CLI command. Replace the `--bucket` parameter with the name of your destination bucket.

For the `--key` parameter, use the filename `<your_test_file>_encrypted.pdf`, where `<your_test_file>` is the name of the the test file you uploaded.

```
aws s3api get-object --bucket amzn-s3-demo-bucket-encrypted --  
key test_encrypted.pdf my_encrypted_file.pdf
```

This command downloads the file to your current directory and saves it as `my_encrypted_file.pdf`.

4. Confirm the you can open the downloaded file with the password your Lambda function protected it with (`my-secret-password`).

Testing the app with the automated script

Create the following files in your project directory:

- `test_pdf_encrypt.py` - a test script you can use to automatically test your application
- `pytest.ini` - a configuration file for the the test script

Expand the following sections to view the code and to learn more about the role of each file.

Automated test script

Copy and paste the following code into a file named `test_pdf_encrypt.py`. Be sure to replace the placeholder bucket names:

- In the `test_source_bucket_available` function, replace `amzn-s3-demo-bucket` with the name of your source bucket.
- In the `test_encrypted_file_in_bucket` function, replace `amzn-s3-demo-bucket-encrypted` with `source-bucket-encrypted`, where `source-bucket>` is the name of your source bucket.
- In the `cleanup` function, replace `amzn-s3-demo-bucket` with the name of your source bucket, and replace `amzn-s3-demo-bucket-encrypted` with the name of your destination bucket.

```
import boto3  
import json  
import pytest  
import time
```

```
import os

@pytest.fixture
def lambda_client():
    return boto3.client('lambda')

@pytest.fixture
def s3_client():
    return boto3.client('s3')

@pytest.fixture
def logs_client():
    return boto3.client('logs')

@pytest.fixture(scope='session')
def cleanup():
    # Create a new S3 client for cleanup
    s3_client = boto3.client('s3')

    yield

    # Cleanup code will be executed after all tests have finished

    # Delete test.pdf from the source bucket
    source_bucket = 'amzn-s3-demo-bucket'
    source_file_key = 'test.pdf'
    s3_client.delete_object(Bucket=source_bucket, Key=source_file_key)
    print(f"\nDeleted {source_file_key} from {source_bucket}")

    # Delete test_encrypted.pdf from the destination bucket
    destination_bucket = 'amzn-s3-demo-bucket-encrypted'
    destination_file_key = 'test_encrypted.pdf'
    s3_client.delete_object(Bucket=destination_bucket, Key=destination_file_key)
    print(f"Deleted {destination_file_key} from {destination_bucket}")

@pytest.mark.order(1)
def test_source_bucket_available(s3_client):
    s3_bucket_name = 'amzn-s3-demo-bucket'
    file_name = 'test.pdf'
    file_path = os.path.join(os.path.dirname(__file__), file_name)

    file_uploaded = False
    try:
        s3_client.upload_file(file_path, s3_bucket_name, file_name)
```

```
        file_uploaded = True
    except:
        print("Error: couldn't upload file")

    assert file_uploaded, "Could not upload file to S3 bucket"

@pytest.mark.order(2)
def test_lambda_invoked(logs_client):

    # Wait for a few seconds to make sure the logs are available
    time.sleep(5)

    # Get the latest log stream for the specified log group
    log_streams = logs_client.describe_log_streams(
        logGroupName='/aws/lambda/EncryptPDF',
        orderBy='LastEventTime',
        descending=True,
        limit=1
    )

    latest_log_stream_name = log_streams['logStreams'][0]['logStreamName']

    # Retrieve the log events from the latest log stream
    log_events = logs_client.get_log_events(
        logGroupName='/aws/lambda/EncryptPDF',
        logStreamName=latest_log_stream_name
    )

    success_found = False
    for event in log_events['events']:
        message = json.loads(event['message'])
        status = message.get('record', {}).get('status')
        if status == 'success':
            success_found = True
            break

    assert success_found, "Lambda function execution did not report 'success' status in logs."

@pytest.mark.order(3)
def test_encrypted_file_in_bucket(s3_client):
    # Specify the destination S3 bucket and the expected converted file key
```

```
destination_bucket = 'amzn-s3-demo-bucket-encrypted'
converted_file_key = 'test_encrypted.pdf'

try:
    # Attempt to retrieve the metadata of the converted file from the destination
    S3 bucket
    s3_client.head_object(Bucket=destination_bucket, Key=converted_file_key)
except s3_client.exceptions.ClientError as e:
    # If the file is not found, the test will fail
    pytest.fail(f"Converted file '{converted_file_key}' not found in the
    destination bucket: {str(e)}")

def test_cleanup(cleanup):
    # This test uses the cleanup fixture and will be executed last
    pass
```

The automated test script executes three test functions to confirm correct operation of your app:

- The test `test_source_bucket_available` confirms that your source bucket has been successfully created by uploading a test PDF file to the bucket.
- The test `test_lambda_invoked` interrogates the latest CloudWatch Logs log stream for your function to confirm that when you uploaded the test file, your Lambda function ran and reported success.
- The test `test_encrypted_file_in_bucket` confirms that your destination bucket contains the encrypted `test_encrypted.pdf` file.

After all these tests have run, the script runs an additional cleanup step to delete the `test.pdf` and `test_encrypted.pdf` files from both your source and destination buckets.

As with the AWS SAM template, the bucket names specified in this file are placeholders. Before running the test, you need to edit this file with your app's real bucket names. This step is explained further in [the section called “Testing the app with the automated script”](#)

Test script configuration file

Copy and paste the following code into a file named `pytest.ini`.

```
[pytest]
markers =
    order: specify test execution order
```

This is needed to specify the order in which the tests in the `test_pdf_encrypt.py` script run.

To run the tests do the following:

1. Ensure that the `pytest` module is installed in your local environment. You can install `pytest` by running the following command:

```
pip install pytest
```

2. Save a PDF file named `test.pdf` in the directory containing the `test_pdf_encrypt.py` and `pytest.ini` files.
3. Open a terminal or shell program and run the following command from the directory containing the test files.

```
pytest -s -v
```

When the test completes, you should see output like the following:

```
===== test session starts
=====
platform linux -- Python 3.12.2, pytest-7.2.2, pluggy-1.0.0 -- /usr/bin/python3
cachedir: .pytest_cache
hypothesis profile 'default' -> database=DirectoryBasedExampleDatabase('/home/pdf_encrypt_app/.hypothesis/examples')
Test order randomisation NOT enabled. Enable with --random-order or --random-order-bucket=<bucket_type>
rootdir: /home/pdf_encrypt_app, configfile: pytest.ini
plugins: anyio-3.7.1, hypothesis-6.70.0, localserver-0.7.1, random-order-1.1.0
collected 4 items

test_pdf_encrypt.py::test_source_bucket_available PASSED
test_pdf_encrypt.py::test_lambda_invoked PASSED
test_pdf_encrypt.py::test_encrypted_file_in_bucket PASSED
test_pdf_encrypt.py::test_cleanup PASSED
Deleted test.pdf from amzn-s3-demo-bucket
Deleted test_encrypted.pdf from amzn-s3-demo-bucket-encrypted

===== 4 passed in 7.32s
=====
```

Next steps

Now you've created this example app, you can use the provided code as a basis to create other types of file-processing application. Modify the code in the `lambda_function.py` file to implement the file-processing logic for your use case.

Many typical file-processing use cases involve image processing. When using Python, the most popular image-processing libraries like [pillow](#) typically contain C or C++ components. In order to ensure that your function's deployment package is compatible with the Lambda execution environment, it's important to use the correct source distribution binary.

When deploying your resources with AWS SAM, you need to take some extra steps to include the right source distribution in your deployment package. Because AWS SAM won't install dependencies for a different platform than your build machine, specifying the correct source distribution (.whl file) in your `requirements.txt` file won't work if your build machine uses an operating system or architecture that's different from the Lambda execution environment. Instead, you should do one of the following:

- Use the `--use-container` option when running `sam build`. When you specify this option, AWS SAM downloads a container base image that's compatible with the Lambda execution environment and builds your function's deployment package in a Docker container using that image. To learn more, see [Building a Lambda function inside of a provided container](#).
- Build your function's .zip deployment package yourself using the correct source distribution binary and save the .zip file in the directory you specify as the `CodeUri` in the AWS SAM template. To learn more about building .zip deployment packages for Python using binary distributions, see [the section called "Creating a .zip deployment package with dependencies"](#) and [the section called "Creating .zip deployment packages with native libraries"](#).

Create an app to perform scheduled database maintenance

You can use AWS Lambda to replace scheduled processes such as automated system backups, file conversions, and maintenance tasks. In this example, you create a serverless application that performs regular scheduled maintenance on a DynamoDB table by deleting old entries. The app uses EventBridge Scheduler to invoke a Lambda function on a cron schedule. When invoked, the function queries the table for items older than one year, and deletes them. The function logs each deleted item in CloudWatch Logs.

To implement this example, first create a DynamoDB table and populate it with some test data for your function to query. Then, create a Python Lambda function with an EventBridge Scheduler trigger and an IAM execution role that gives the function permission to read, and delete, items from your table.

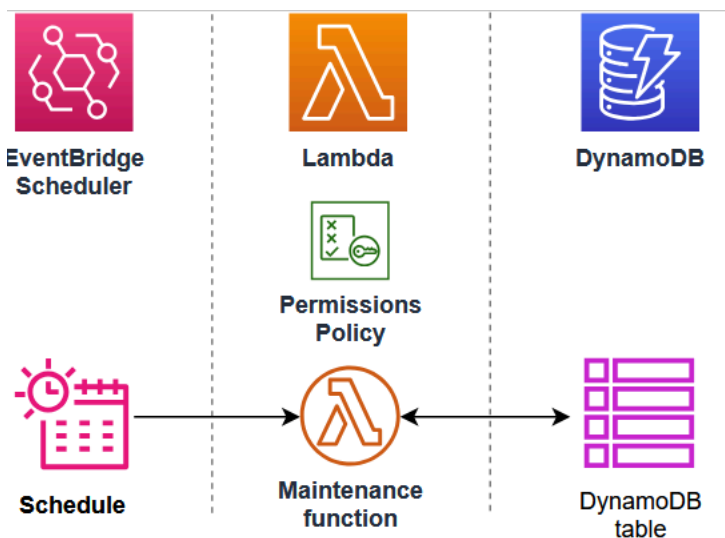

Tip

If you're new to Lambda, we recommend that you complete the tutorial [Create your first function](#) before creating this example app.

You can deploy your app manually by creating and configuring resources with the AWS Management Console. You can also deploy the app by using the AWS Serverless Application Model (AWS SAM). AWS SAM is an infrastructure as code (IaC) tool. With IaC, you don't create resources manually, but define them in code and then deploy them automatically.

If you want to learn more about using Lambda with IaC before deploying this example app, see [Infrastructure as code \(IaC\)](#).

Prerequisites

Before you can create the example app, make sure you have the required command line tools and programs installed.

- **Python**

To populate the DynamoDB table you create to test your app, this example uses a Python script and a CSV file to write data into the table. Make sure you have Python version 3.8 or later installed on your machine.

- **AWS SAM CLI**

If you want to create the DynamoDB table and deploy the example app using AWS SAM, you need to install the AWS SAM CLI. Follow the [installation instructions](#) in the *AWS SAM User Guide*.

- **AWS CLI**

To use the provided Python script to populate your test table, you need to have installed and configured the AWS CLI. This is because the script uses the AWS SDK for Python (Boto3), which needs access to your AWS Identity and Access Management (IAM) credentials. You also need the AWS CLI installed to deploy resources using AWS SAM. Install the CLI by following the [installation instructions](#) in the *AWS Command Line Interface User Guide*.

- **Docker**

To deploy the app using AWS SAM, Docker must also be installed on your build machine. Follow the instructions in [Install Docker Engine](#) on the Docker documentation website.

Downloading the example app files

To create the example database and the scheduled-maintenance app, you need to create the following files in your project directory:

Example database files

- `template.yaml` - an AWS SAM template you can use to create the DynamoDB table
- `sample_data.csv` - a CSV file containing sample data to load into your table

- `load_sample_data.py` - a Python script that writes the data in the CSV file into the table

Scheduled-maintenance app files

- `lambda_function.py` - the Python function code for the Lambda function that performs the database maintenance
- `requirements.txt` - a manifest file defining the dependencies that your Python function code requires
- `template.yaml` - an AWS SAM template you can use to deploy the app

Test file

- `test_app.py` - a Python script that scans the table and confirms successful operation of your function by outputting all records older than one year

Expand the following sections to view the code and to learn more about the role of each file in creating and testing your app. To create the files on your local machine, copy and paste the code below.

AWS SAM template (example DynamoDB table)

Copy and paste the following code into a file named `template.yaml`.

```
AWSTemplateFormatVersion: '2010-09-09'
Transform: AWS::Serverless-2016-10-31
Description: SAM Template for DynamoDB Table with Order_number as Partition Key and
  Date as Sort Key

Resources:
  MyDynamoDBTable:
    Type: AWS::DynamoDB::Table
    DeletionPolicy: Retain
    UpdateReplacePolicy: Retain
    Properties:
      TableName: MyOrderTable
      BillingMode: PAY_PER_REQUEST
      AttributeDefinitions:
        - AttributeName: Order_number
          AttributeType: S
        - AttributeName: Date
```

```
    AttributeType: S
  KeySchema:
    - AttributeName: Order_number
      KeyType: HASH
    - AttributeName: Date
      KeyType: RANGE
  SSESpecification:
    SSEEnabled: true
  GlobalSecondaryIndexes:
    - IndexName: Date-index
      KeySchema:
        - AttributeName: Date
          KeyType: HASH
      Projection:
        ProjectionType: ALL
  PointInTimeRecoverySpecification:
    PointInTimeRecoveryEnabled: true
```

Outputs:

```
  TableName:
    Description: DynamoDB Table Name
    Value: !Ref MyDynamoDBTable
  TableArn:
    Description: DynamoDB Table ARN
    Value: !GetAtt MyDynamoDBTable.Arn
```

Note

AWS SAM templates use a standard naming convention of `template.yaml`. In this example, you have two template files - one to create the example database and another to create the app itself. Save them in separate sub-directories in your project folder.

This AWS SAM template defines the DynamoDB table resource you create to test your app. The table uses a primary key of `Order_number` with a sort key of `Date`. In order for your Lambda function to find items directly by date, we also define a [Global Secondary Index](#) named `Date-index`.

To learn more about creating and configuring a DynamoDB table using the `AWS::DynamoDB::Table` resource, see [AWS::DynamoDB::Table](#) in the *AWS CloudFormation User Guide*.

Sample database data file

Copy and paste the following code into a file named `sample_data.csv`.

```
Date,Order_number,CustomerName,ProductID,Quantity,TotalAmount
2023-09-01,ORD001,Alejandro Rosalez,PROD123,2,199.98
2023-09-01,ORD002,Akua Mansa,PROD456,1,49.99
2023-09-02,ORD003,Ana Carolina Silva,PROD789,3,149.97
2023-09-03,ORD004,Arnav Desai,PROD123,1,99.99
2023-10-01,ORD005,Carlos Salazar,PROD456,2,99.98
2023-10-02,ORD006,Diego Ramirez,PROD789,1,49.99
2023-10-03,ORD007,Efua Owusu,PROD123,4,399.96
2023-10-04,ORD008,John Stiles,PROD456,2,99.98
2023-10-05,ORD009,Jorge Souza,PROD789,3,149.97
2023-10-06,ORD010,Kwaku Mensah,PROD123,1,99.99
2023-11-01,ORD011,Li Juan,PROD456,5,249.95
2023-11-02,ORD012,Marcia Oliveria,PROD789,2,99.98
2023-11-03,ORD013,Maria Garcia,PROD123,3,299.97
2023-11-04,ORD014,Martha Rivera,PROD456,1,49.99
2023-11-05,ORD015,Mary Major,PROD789,4,199.96
2023-12-01,ORD016,Mateo Jackson,PROD123,2,199.99
2023-12-02,ORD017,Nikki Wolf,PROD456,3,149.97
2023-12-03,ORD018,Pat Candella,PROD789,1,49.99
2023-12-04,ORD019,Paulo Santos,PROD123,5,499.95
2023-12-05,ORD020,Richard Roe,PROD456,2,99.98
2024-01-01,ORD021,Saanvi Sarkar,PROD789,3,149.97
2024-01-02,ORD022,Shirley Rodriguez,PROD123,1,99.99
2024-01-03,ORD023,Sofia Martinez,PROD456,4,199.96
2024-01-04,ORD024,Terry Whitlock,PROD789,2,99.98
2024-01-05,ORD025,Wang Xiulan,PROD123,3,299.97
```

This file contains some example test data to populate your DynamoDB table with in a standard comma-separated values (CSV) format.

Python script to load sample data

Copy and paste the following code into a file named `load_sample_data.py`.

```
import boto3
import csv
from decimal import Decimal

# Initialize the DynamoDB client
```

```
dynamodb = boto3.resource('dynamodb')
table = dynamodb.Table('MyOrderTable')
print("DDB client initialized.")

def load_data_from_csv(filename):
    with open(filename, 'r') as file:
        csv_reader = csv.DictReader(file)
        for row in csv_reader:
            item = {
                'Order_number': row['Order_number'],
                'Date': row['Date'],
                'CustomerName': row['CustomerName'],
                'ProductID': row['ProductID'],
                'Quantity': int(row['Quantity']),
                'TotalAmount': Decimal(str(row['TotalAmount']))
            }
            table.put_item(Item=item)
            print(f"Added item: {item['Order_number']} - {item['Date']}")

if __name__ == "__main__":
    load_data_from_csv('sample_data.csv')
    print("Data loading completed.")
```

This Python script first uses the AWS SDK for Python (Boto3) to create a connection to your DynamoDB table. It then iterates over each row in the example-data CSV file, creates an item from that row, and writes the item to the DynamoDB table using the boto3 SDK.

Python function code

Copy and paste the following code into a file named `lambda_function.py`.

```
import boto3
from datetime import datetime, timedelta
from boto3.dynamodb.conditions import Key, Attr
import logging

logger = logging.getLogger()
logger.setLevel("INFO")

def lambda_handler(event, context):
    # Initialize the DynamoDB client
    dynamodb = boto3.resource('dynamodb')
```

```
# Specify the table name
table_name = 'MyOrderTable'
table = dynamodb.Table(table_name)

# Get today's date
today = datetime.now()

# Calculate the date one year ago
one_year_ago = (today - timedelta(days=365)).strftime('%Y-%m-%d')

# Scan the table using a global secondary index
response = table.scan(
    IndexName='Date-index',
    FilterExpression='#date < :one_year_ago',
    ExpressionAttributeNames={
        '#date': 'Date'
    },
    ExpressionAttributeValues={
        ':one_year_ago': one_year_ago
    }
)

# Delete old items
with table.batch_writer() as batch:
    for item in response['Items']:
        Order_number = item['Order_number']
        batch.delete_item(
            Key={
                'Order_number': Order_number,
                'Date': item['Date']
            }
        )
        logger.info(f'deleted order number {Order_number}')

# Check if there are more items to scan
while 'LastEvaluatedKey' in response:
    response = table.scan(
        IndexName='DateIndex',
        FilterExpression='#date < :one_year_ago',
        ExpressionAttributeNames={
            '#date': 'Date'
        },
        ExpressionAttributeValues={
            ':one_year_ago': one_year_ago
```



```
        },
        ExclusiveStartKey=response['LastEvaluatedKey']
    )

    # Delete old items
    with table.batch_writer() as batch:
        for item in response['Items']:
            batch.delete_item(
                Key={
                    'Order_number': item['Order_number'],
                    'Date': item['Date']
                }
            )

    return {
        'statusCode': 200,
        'body': 'Cleanup completed successfully'
    }
```

The Python function code contains the [handler function](#) (`lambda_handler`) that Lambda runs when your function is invoked.

When the function is invoked by EventBridge Scheduler, it uses the AWS SDK for Python (Boto3) to create a connection to the DynamoDB table on which the scheduled maintenance task is to be performed. It then uses the Python `datetime` library to calculate the date one year ago, before scanning the table for items older than this and deleting them.

Note that responses from DynamoDB query and scan operations are limited to a maximum of 1 MB in size. If the response is larger than 1 MB, DynamoDB paginates the data and returns a `LastEvaluatedKey` element in the response. To ensure that our function processes all the records in the table, we check for the presence of this key and continue performing table scans from the last evaluated position until the whole table has been scanned.

requirements.txt manifest file

Copy and paste the following code into a file named `requirements.txt`.

```
boto3
```

For this example, your function code has only one dependency that isn't part of the standard Python library - the SDK for Python (Boto3) that the function uses to scan and delete items from the DynamoDB table.

Note

A version of the SDK for Python (Boto3) is included as part of the Lambda runtime, so your code would run without adding Boto3 to your function's deployment package. However, to maintain full control of your function's dependencies and avoid possible issues with version misalignment, best practice for Python is to include all function dependencies in your function's deployment package. See [the section called “Runtime dependencies in Python”](#) to learn more.

AWS SAM template (scheduled-maintenance app)

Copy and paste the following code into a file named `template.yaml`.

```
AWSTemplateFormatVersion: '2010-09-09'
Transform: AWS::Serverless-2016-10-31
Description: SAM Template for Lambda function and EventBridge Scheduler rule

Resources:
  MyLambdaFunction:
    Type: AWS::Serverless::Function
    Properties:
      FunctionName: ScheduledDBMaintenance
      CodeUri: ./
      Handler: lambda_function.lambda_handler
      Runtime: python3.11
      Architectures:
        - x86_64
      Events:
        ScheduleEvent:
          Type: ScheduleV2
          Properties:
            ScheduleExpression: cron(0 3 1 * ? *)
            Description: Run on the first day of every month at 03:00 AM
    Policies:
      - CloudWatchLogsFullAccess
      - Statement:
          - Effect: Allow
            Action:
              - dynamodb:Scan
              - dynamodb:BatchWriteItem
```

```

    Resource: !Sub 'arn:aws:dynamodb:${AWS::Region}:${AWS::AccountId}:table/
MyOrderTable'

LambdaLogGroup:
  Type: AWS::Logs::LogGroup
  Properties:
    LogGroupName: !Sub /aws/lambda/${MyLambdaFunction}
    RetentionInDays: 30

Outputs:
  LambdaFunctionName:
    Description: Lambda Function Name
    Value: !Ref MyLambdaFunction
  LambdaFunctionArn:
    Description: Lambda Function ARN
    Value: !GetAtt MyLambdaFunction.Arn

```

Note

AWS SAM templates use a standard naming convention of `template.yaml`. In this example, you have two template files - one to create the example database and another to create the app itself. Save them in separate sub-directories in your project folder.

This AWS SAM template defines the resources for your app. We define the Lambda function using the `AWS::Serverless::Function` resource. The EventBridge Scheduler schedule and the trigger to invoke the Lambda function are created by using the `Events` property of this resource using a type of `ScheduleV2`. To learn more about defining EventBridge Scheduler schedules in AWS SAM templates, see [ScheduleV2](#) in the *AWS Serverless Application Model Developer Guide*.

In addition to the Lambda function and the EventBridge Scheduler schedule, we also define a CloudWatch log group for your function to send records of deleted items to.

Test script

Copy and paste the following code into a file named `test_app.py`.

```

import boto3
from datetime import datetime, timedelta
import json

# Initialize the DynamoDB client

```

```
dynamodb = boto3.resource('dynamodb')

# Specify your table name
table_name = 'YourTableName'
table = dynamodb.Table(table_name)

# Get the current date
current_date = datetime.now()

# Calculate the date one year ago
one_year_ago = current_date - timedelta(days=365)

# Convert the date to string format (assuming the date in DynamoDB is stored as a
string)
one_year_ago_str = one_year_ago.strftime('%Y-%m-%d')

# Scan the table
response = table.scan(
    FilterExpression='#date < :one_year_ago',
    ExpressionAttributeNames={
        '#date': 'Date'
    },
    ExpressionAttributeValues={
        ':one_year_ago': one_year_ago_str
    }
)

# Process the results
old_records = response['Items']

# Continue scanning if we have more items (pagination)
while 'LastEvaluatedKey' in response:
    response = table.scan(
        FilterExpression='#date < :one_year_ago',
        ExpressionAttributeNames={
            '#date': 'Date'
        },
        ExpressionAttributeValues={
            ':one_year_ago': one_year_ago_str
        },
        ExclusiveStartKey=response['LastEvaluatedKey']
    )
    old_records.extend(response['Items'])
```

```
for record in old_records:
    print(json.dumps(record))

# The total number of old records should be zero.
print(f"Total number of old records: {len(old_records)}")
```

This test script uses the AWS SDK for Python (Boto3) to create a connection to your DynamoDB table and scan for items older than one year. To confirm if the Lambda function has run successfully, at the end of the test, the function prints the number of records older than one year still in the table. If the Lambda function was successful, the number of old records in the table should be zero.

Creating and populating the example DynamoDB table

To test your scheduled-maintenance app, you first create a DynamoDB table and populate it with some sample data. You can create the table either manually using the AWS Management Console or by using AWS SAM. We recommend that you use AWS SAM to quickly create and configure the table using a few AWS CLI commands.

Console

To create the DynamoDB table

1. Open the [Tables](#) page of the DynamoDB console.
2. Choose **Create table**.
3. Create the table by doing the following:
 - a. Under **Table details**, for **Table name**, enter **MyOrderTable**.
 - b. For **Partition key**, enter **Order_number** and leave the type as **String**.
 - c. For **Sort key**, enter **Date** and leave the type as **String**.
 - d. Leave **Table settings** set to **Default settings** and choose **Create table**.
4. When your table has finished creating and its **Status** shows as **Active**, create a global secondary index (GSI) by doing the following. Your app will use this GSI to search for items directly by date to determine what to delete.
 - a. Choose **MyOrderTable** from the list of tables.
 - b. Choose the **Indexes** tab.
 - c. Under **Global secondary indexes**, choose **Create index**.

- d. Under **Index details**, enter **Date** for the **Partition key** and leave the **Data type** set to **String**.
- e. For **Index name**, enter **Date-index**.
- f. Leave all other parameters set to their default values, scroll to the bottom of the page, and choose **Create index**.

AWS SAM

To create the DynamoDB table

1. Navigate to the folder you saved the `template.yaml` file for the DynamoDB table in. Note that this example uses two `template.yaml` files. Make sure they are saved in separate sub-folders and that you are in the correct folder containing the template to create your DynamoDB table.
2. Run the following command.

```
sam build
```

This command gathers the build artifacts for the resources you want to deploy and places them in the proper format and location to deploy them.

3. To create the DynamoDB resource specified in the `template.yaml` file, run the following command.

```
sam deploy --guided
```

Using the `--guided` flag means that AWS SAM will show you prompts to guide you through the deployment process. For this deployment, enter a `Stack` name of **cron-app-test-db**, and accept the defaults for all other options by using `Enter`.

When AWS SAM has finished creating the DynamoDB resource, you should see the following message.

```
Successfully created/updated stack - cron-app-test-db in us-west-2
```

4. You can additionally confirm that the DynamoDB table has been created by opening the [Tables](#) page of the DynamoDB console. You should see a table named `MyOrderTable`.

After you've created your table, you next add some sample data to test your app. The CSV file `sample_data.csv` you downloaded earlier contains a number of example entries comprised of order numbers, dates, and customer and order information. Use the provided python script `load_sample_data.py` to add this data to your table.

To add the sample data to the table

1. Navigate to the directory containing the `sample_data.csv` and `load_sample_data.py` files. If these files are in separate directories, move them so they're saved in the same location.
2. Create a Python virtual environment to run the script in by running the following command. We recommend that you use a virtual environment because in a following step you'll need to install the AWS SDK for Python (Boto3).

```
python -m venv venv
```

3. Activate the virtual environment by running the following command.

```
source venv/bin/activate
```

4. Install the SDK for Python (Boto3) in your virtual environment by running the following command. The script uses this library to connect to your DynamoDB table and add the items.

```
pip install boto3
```

5. Run the script to populate the table by running the following command.

```
python load_sample_data.py
```

If the script runs successfully, it should print each item to the console as it loads it and report Data loading completed.

6. Deactivate the virtual environment by running the following command.

```
deactivate
```

7. You can verify that the data has been loaded to your DynamoDB table by doing the following:
 - a. Open the [Explore items](#) page of the DynamoDB console and select your table (MyOrderTable).

- b. In the **Items returned** pane, you should see the 25 items from the CSV file that the script added to the table.

Creating the scheduled-maintenance app

You can create and deploy the resources for this example app step by step using the AWS Management Console or by using AWS SAM. In a production environment, we recommend that you use an Infrastructure-as-Code (IaC) tool like AWS SAM to repeatably deploy serverless applications without using manual processes.

For this example, follow the console instructions to learn how to configure each AWS resource separately, or follow the AWS SAM instructions to quickly deploy the app using AWS CLI commands.

Console

To create the function using the AWS Management Console

First, create a function containing basic starter code. You then replace this code with your own function code by either copying and pasting the code directly in the Lambda code editor, or by uploading your code as a .zip package. For this task, we recommend simply copying and pasting the code.

1. Open the [Functions page](#) of the Lambda console.
2. Choose **Create function**.
3. Choose **Author from scratch**.
4. Under **Basic information**, do the following:
 - a. For **Function name**, enter **ScheduledDBMaintenance**.
 - b. For **Runtime** choose the latest Python version.
 - c. For **Architecture**, choose **x86_64**.
5. Choose **Create function**.
6. After your function is created, you can configure your function with the provided function code.
 - a. In the **Code source** pane, replace the Hello world code that Lambda created with the Python function code from the `lambda_function.py` file that you saved earlier.

- b. In the **DEPLOY** section, choose **Deploy** to update your function's code:

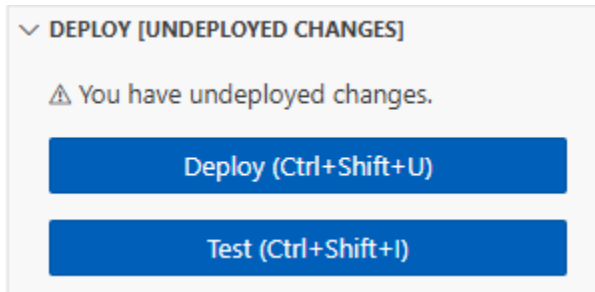

To configure the function memory and timeout (console)

1. Select the **Configuration** tab for your function.
2. In the **General configuration** pane, choose **Edit**.
3. Set **Memory** to 256 MB and **Timeout** to 15 seconds. If you are processing a large table with many records, for example in the case of a production environment, you might consider setting **Timeout** to a larger number. This gives your function more time to scan, and clean the database.
4. Choose **Save**.

To configure the log format (console)

You can configure Lambda functions to output logs in either unstructured text or JSON format. We recommend that you use JSON format for logs to make it easier to search and filter log data. To learn more about Lambda log configuration options, see [the section called "Configure function logs"](#).

1. Select the **Configuration** tab for your function.
2. Select **Monitoring and operations tools**.
3. In the **Logging configuration** pane, choose **Edit**.
4. For **Logging configuration**, select **JSON**.
5. Choose **Save**.

To set Up IAM permissions

To give your function the permissions it needs to read and delete DynamoDB items, you need to add a policy to your function's [execution role](#) defining the necessary permissions.

1. Open the **Configuration** tab, then choose **Permissions** from the left navigation bar.
2. Choose the role name under **Execution role**.
3. In the IAM console, choose **Add permissions**, then **Create inline policy**.
4. Use the JSON editor and enter the following policy:

```
{
  "Version": "2012-10-17",
  "Statement": [
    {
      "Effect": "Allow",
      "Action": [
        "dynamodb:Scan",
        "dynamodb>DeleteItem",
        "dynamodb:BatchWriteItem"
      ],
      "Resource": "arn:aws:dynamodb:*:*:table/MyOrderTable"
    }
  ]
}
```

5. Name the policy **DynamoDBCleanupPolicy**, then create it.

To set up EventBridge Scheduler as a trigger (console)

1. Open the [EventBridge console](#).
2. In the left navigation pane, choose **Schedulers** under the **Scheduler** section.
3. Choose **Create schedule**.
4. Configure the schedule by doing the following:
 - a. Under **Schedule name**, enter a name for your schedule (for example, **DynamoDBCleanupSchedule**).
 - b. Under **Schedule pattern**, choose **Recurring schedule**.
 - c. For **Schedule type** leave the default as **Cron-based schedule**, then enter the following schedule details:
 - **Minutes: 0**
 - **Hours: 3**
 - **Day of month: 1**

- **Month:** *
- **Day of the week:** ?
- **Year:** *

When evaluated, this cron expression runs on the first day of every month at 03:00 AM.

- d. For **Flexible time window**, select **Off**.
5. Choose **Next**.
 6. Configure the trigger for your Lambda function by doing the following:
 - a. In the **Target detail** pane, leave **Target API** set to **Templated targets**, then select **AWS Lambda Invoke**.
 - b. Under **Invoke**, select your Lambda function (ScheduledDBMaintenance) from the dropdown list.
 - c. Leave the **Payload** empty and choose **Next**.
 - d. Scroll down to **Permissions** and select **Create a new role for this schedule**. When you create a new EventBridge Scheduler schedule using the console, EventBridge Scheduler creates a new policy with the required permissions the schedule needs to invoke your function. For more information about managing your schedule permissions, see [Cron-based schedules](#) in the *EventBridge Scheduler User Guide*.
 - e. Choose **Next**.
 7. Review your settings and choose **Create schedule** to complete creation of the schedule and Lambda trigger.

AWS SAM

To deploy the app using AWS SAM

1. Navigate to the folder you saved the `template.yaml` file for the app in. Note that this example uses two `template.yaml` files. Make sure they are saved in separate sub-folders and that you are in the correct folder containing the template to create the app.
2. Copy the `lambda_function.py` and `requirements.txt` files you downloaded earlier to the same folder. The code location specified in the AWS SAM template is `./`, meaning the current location. AWS SAM will search in this folder for the Lambda function code when you try to deploy the app.

3. Run the following command.

```
sam build --use-container
```

This command gathers the build artifacts for the resources you want to deploy and places them in the proper format and location to deploy them. Specifying the `--use-container` option builds your function inside a Lambda-like Docker container. We use it here so you don't need to have Python 3.12 installed on your local machine for the build to work.

4. To create the Lambda and EventBridge Scheduler resources specified in the `template.yaml` file, run the following command.

```
sam deploy --guided
```

Using the `--guided` flag means that AWS SAM will show you prompts to guide you through the deployment process. For this deployment, enter a Stack name of **cron-maintenance-app**, and accept the defaults for all other options by using Enter.

When AWS SAM has finished creating the Lambda and EventBridge Scheduler resources, you should see the following message.

```
Successfully created/updated stack - cron-maintenance-app in us-west-2
```

5. You can additionally confirm that the Lambda function has been created by opening the [Functions](#) page of the Lambda console. You should see a function named `ScheduledDBMaintenance`.

Testing the app

To test that your schedule correctly triggers your function, and that your function correctly cleans records from the database, you can temporarily modify your schedule to run once at a specific time. You can then run `sam deploy` again to reset your recurrence schedule to run once a month.

To run the application using the AWS Management Console

1. Navigate back to the EventBridge Scheduler console page.
2. Choose your schedule, then choose **Edit**.
3. In the **Schedule pattern** section, under **Recurrence**, choose **One-time schedule**.

4. Set your invocation time to a few minutes from now, review your settings, then choose **Save**.

After the schedule runs and invokes its target, you run the `test_app.py` script to verify that your function successfully removed all old records from the DynamoDB table.

To verify that old records are deleted using a Python script

1. In your command line window, navigate to the folder where you saved `test_app.py`.
2. Run the script.

```
python test_app.py
```

If successful, you will see the following output.

```
Total number of old records: 0
```

Next steps

You can now modify the EventBridge Scheduler schedule to meet your particular application requirements. EventBridge Scheduler supports the following schedule expressions: cron, rate, and one-time schedules.

For more information about EventBridge Scheduler schedule expressions, see [Schedule types](#) in the *EventBridge Scheduler User Guide*.

Using Lambda with infrastructure as code (IaC)

Lambda functions rarely run in isolation. Instead, they often form part of a serverless application with other resources such as databases, queues, and storage. With [infrastructure as code \(IaC\)](#), you can automate your deployment processes to quickly and repeatably deploy and update whole serverless applications involving many separate AWS resources. This approach speeds up your development cycle, makes configuration management easier, and ensures that your resources are deployed the same way every time.

IaC tools for Lambda

AWS CloudFormation

CloudFormation is the foundational IaC service from AWS. You can use [YAML or JSON templates](#) to model and provision your entire AWS infrastructure, including Lambda functions. CloudFormation handles the complexities of creating, updating, and deleting your AWS resources.

AWS Serverless Application Model (AWS SAM)

AWS SAM is an open-source framework built on top of CloudFormation. It provides a simplified syntax for defining serverless applications. Use [AWS SAM templates](#) to quickly provision Lambda functions, APIs, databases, and event sources with just a few lines of YAML.

AWS Cloud Development Kit (AWS CDK)

The CDK is a code-first approach to IaC. You can define your Lambda-based architecture using TypeScript, JavaScript, Python, Java, C#/.Net, or Go. Choose your preferred language and use programming elements like parameters, conditionals, loops, composition, and inheritance to define the desired outcome of your infrastructure. The CDK then generates the underlying CloudFormation templates for deployment. For an example of how to use Lambda with CDK, see [Deploying Lambda functions with the AWS CDK](#).

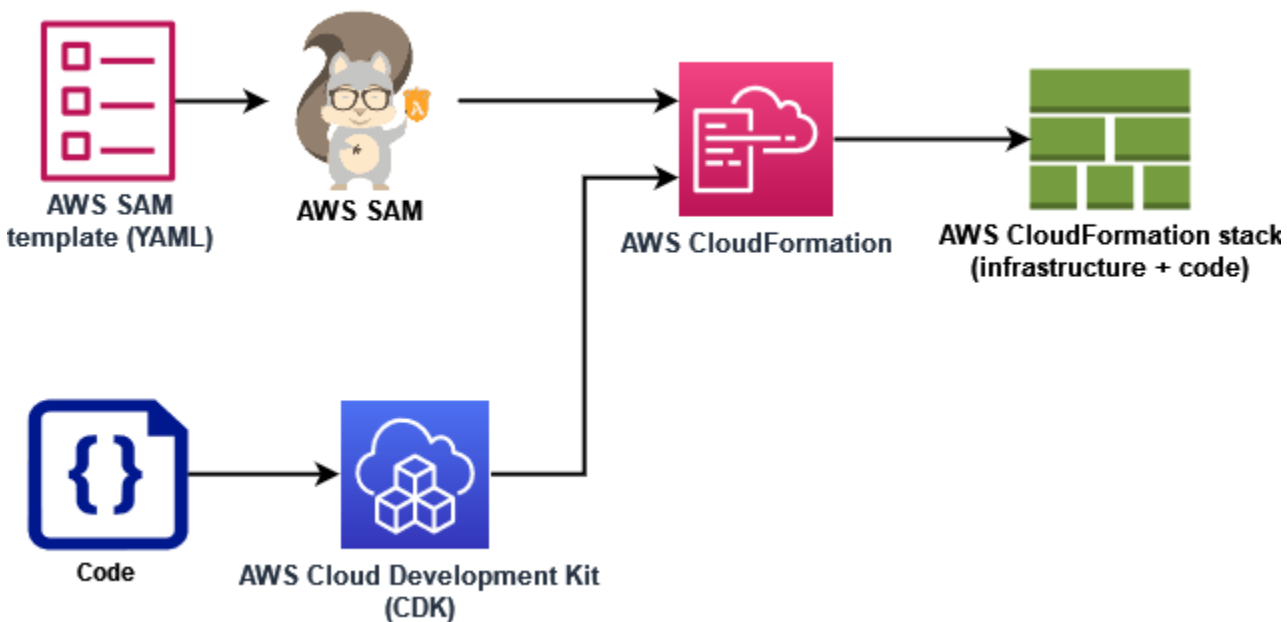

AWS also provides a service called AWS Infrastructure Composer to develop IaC templates using a simple graphical interface. With Infrastructure Composer, you design an application architecture by dragging, grouping, and connecting AWS services in a visual canvas. Infrastructure Composer then creates an AWS SAM template or an AWS CloudFormation template from your design that you can use to deploy your application.

In the [the section called “Getting started with IaC for Lambda”](#) section below, you use Infrastructure Composer to develop a template for a serverless application based on an existing Lambda function.

Getting started with IaC for Lambda

In this tutorial, you can get started using IaC with Lambda by creating an AWS SAM template from an existing Lambda function and then building out a serverless application in Infrastructure Composer by adding other AWS resources.

As you carry out this tutorial, you’ll learn some fundamental concepts, like how AWS resources are specified in AWS SAM. You’ll also learn how to use Infrastructure Composer to build a serverless application you can deploy using AWS SAM or AWS CloudFormation.

To complete this tutorial, you’ll carry out the following steps:

- Create an example Lambda function
- Use the Lambda console to view the AWS SAM template for the function

- Export your function's configuration to AWS Infrastructure Composer and design a simple serverless application based on your function's configuration
- Save an updated AWS SAM template you can use as a basis to deploy your serverless application

Prerequisites

In this tutorial, you use Infrastructure Composer's [local sync](#) feature to save your template and code files to your local build machine. To use this feature, you need a browser that supports the File System Access API, which allows web applications to read, write, and save files in your local file system . We recommend using either Google Chrome or Microsoft Edge. For more information about the File System Access API, see [What is the File System Access API?](#)

Create a Lambda function

In this first step, you create a Lambda function you can use to complete the rest of the tutorial. To keep things simple, you use the Lambda console to create a basic 'Hello world' function using the Python 3.11 runtime.

To create a 'Hello world' Lambda function using the console

1. Open the [Lambda console](#).
2. Choose **Create function**.
3. Leave **Author from scratch** selected, and under **Basic information**, enter **LambdaIaCDemo** for **Function name**.
4. For **Runtime**, select **Python 3.11**.
5. Choose **Create function**.

View the AWS SAM template for your function

Before you export your function configuration to Infrastructure Composer, use the Lambda console to view your function's current configuration as an AWS SAM template. By following the steps in this section, you'll learn about the anatomy of an AWS SAM template and how to define resources like Lambda functions to start specifying a serverless application.

To view the AWS SAM template for your function

1. Open the [Functions page](#) of the Lambda console.

2. Choose the function you just created (LambdaIaCDemo).
3. In the **Function overview** pane, choose **Template**.

In place of the diagram representing your function's configuration, you'll see an AWS SAM template for your function. The template should look like the following.

```
# This AWS SAM template has been generated from your function's
# configuration. If your function has one or more triggers, note
# that the AWS resources associated with these triggers aren't fully
# specified in this template and include placeholder values. Open this template
# in AWS Application Composer or your favorite IDE and modify
# it to specify a serverless application with other AWS resources.
AWSTemplateFormatVersion: '2010-09-09'
Transform: AWS::Serverless-2016-10-31
Description: An AWS Serverless Specification template describing your function.
Resources:
  LambdaIaCDemo:
    Type: AWS::Serverless::Function
    Properties:
      CodeUri: .
      Description: ''
      MemorySize: 128
      Timeout: 3
      Handler: lambda_function.lambda_handler
      Runtime: python3.11
      Architectures:
        - x86_64
      EventInvokeConfig:
        MaximumEventAgeInSeconds: 21600
        MaximumRetryAttempts: 2
      EphemeralStorage:
        Size: 512
      RuntimeManagementConfig:
        UpdateRuntimeOn: Auto
      SnapStart:
        ApplyOn: None
      PackageType: Zip
      Policies:
        Statement:
          - Effect: Allow
            Action:
              - logs:CreateLogGroup
            Resource: arn:aws:logs:us-east-1:123456789012:*
```

```
- Effect: Allow
  Action:
    - logs:CreateLogStream
    - logs:PutLogEvents
  Resource:
    - >-
      arn:aws:logs:us-east-1:123456789012:log-group:/aws/lambda/
LambdaIaCDemo:*
```

Let's take a moment to look at the YAML template for your function and understand some key concepts.

The template starts with the declaration `Transform: AWS::Serverless-2016-10-31`. This declaration is required because behind the scenes, AWS SAM templates are deployed through AWS CloudFormation. Using the `Transform` statement identifies the template as an AWS SAM template file.

Following the `Transform` declaration comes the `Resources` section. This is where the AWS resources you want to deploy with your AWS SAM template are defined. AWS SAM templates can contain a combination of AWS SAM resources and AWS CloudFormation resources. This is because during deployment, AWS SAM templates expand to AWS CloudFormation templates, so any valid AWS CloudFormation syntax can be added to an AWS SAM template.

At the moment, there is just one resource defined in the `Resources` section of the template, your Lambda function `LambdaIaCDemo`. To add a Lambda function to an AWS SAM template, you use the `AWS::Serverless::Function` resource type. The `Properties` of a Lambda function resource define the function's runtime, function handler, and other configuration options. The path to your function's source code that AWS SAM should use to deploy the function is also defined here. To learn more about Lambda function resources in AWS SAM, see [AWS::Serverless::Function](#) in the *AWS SAM Developer Guide*.

As well as the function properties and configurations, the template also specifies an AWS Identity and Access Management (IAM) policy for your function. This policy gives your function permission to write logs to Amazon CloudWatch Logs. When you create a function in the Lambda console, Lambda automatically attaches this policy to your function. To learn more about specifying an IAM policy for a function in an AWS SAM template, see the `policies` property on the [AWS::Serverless::Function](#) page of the *AWS SAM Developer Guide*.

To learn more about the structure of AWS SAM templates, see [AWS SAM template anatomy](#).

Use AWS Infrastructure Composer to design a serverless application

To start building out a simple serverless application using your function's AWS SAM template as a starting point, you export your function configuration to Infrastructure Composer and activate Infrastructure Composer's local sync mode. Local sync automatically saves your function's code and your AWS SAM template to your local build machine and keeps your saved template synced as you add other AWS resources in Infrastructure Composer.

To export your function to Infrastructure Composer

1. In the **Function Overview** pane, choose **Export to Application Composer**.

To export your function's configuration and code to Infrastructure Composer, Lambda creates an Amazon S3 bucket in your account to temporarily store this data.

2. In the dialog box, choose **Confirm and create project** to accept the default name for this bucket and export your function's configuration and code to Infrastructure Composer.
3. (Optional) To choose another name for the Amazon S3 bucket that Lambda creates, enter a new name and choose **Confirm and create project**. Amazon S3 bucket names must be globally unique and follow the [bucket naming rules](#).

Selecting **Confirm and create project** opens the Infrastructure Composer console. On the *canvas*, you'll see your Lambda function.

4. From the **Menu** dropdown, choose **Activate local sync**.
5. In the dialog box that opens, choose **Select folder** and select a folder on your local build machine.
6. Choose **Activate** to activate local sync.

To export your function to Infrastructure Composer, you need permission to use certain API actions. If you're unable to export your function, see [the section called "Required permissions"](#) and make sure you have the permissions you need.

Note

Standard [Amazon S3 pricing](#) applies for the bucket Lambda creates when you export a function to Infrastructure Composer. The objects that Lambda puts into the bucket are automatically deleted after 10 days, but Lambda doesn't delete the bucket itself.

To avoid additional charges being added to your AWS account, follow the instructions in [Deleting a bucket](#) after you have exported your function to Infrastructure Composer. For more information about the Amazon S3 bucket Lambda creates, see [the section called “Infrastructure Composer”](#).

To design your serverless application in Infrastructure Composer

After activating local sync, changes you make in Infrastructure Composer will be reflected in the AWS SAM template saved on your local build machine. You can now drag and drop additional AWS resources onto the Infrastructure Composer canvas to build out your application. In this example, you add an Amazon SQS simple queue as a trigger for your Lambda function and a DynamoDB table for the function to write data to.

1. Add an Amazon SQS trigger to your Lambda function by doing the following:
 - a. In the search field in the **Resources** palette, enter **SQS**.
 - b. Drag the **SQS Queue** resource onto your canvas and position it to the left of your Lambda function.
 - c. Choose **Details**, and for **Logical ID** enter **LambdaIaCQueue**.
 - d. Choose **Save**.
 - e. Connect your Amazon SQS and Lambda resources by clicking on the **Subscription** port on the SQS queue card and dragging it to the left hand port on the Lambda function card. The appearance of a line between the two resources indicates a successful connection. Infrastructure Composer also displays a message at the bottom of the canvas indicating that the two resources are successfully connected.
2. Add an Amazon DynamoDB table for your Lambda function to write data to by doing the following:
 - a. In the search field in the **Resources** palette, enter **DynamoDB**.
 - b. Drag the **DynamoDB Table** resource onto your canvas and position it to the right of your Lambda function.
 - c. Choose **Details**, and for **Logical ID** enter **LambdaIaCTable**.
 - d. Choose **Save**.
 - e. Connect the DynamoDB table to your Lambda function by clicking on the right hand port of the Lambda function card and dragging it to the left hand port on the DynamoDB card.

Now that you've added these extra resources, let's take a look at the updated AWS SAM template Infrastructure Composer has created.

To view your updated AWS SAM template

- On the Infrastructure Composer canvas, choose **Template** to switch from the canvas view to the template view.

Your AWS SAM template should now contain the following additional resources and properties:

- An Amazon SQS queue with the identifier `LambdaIaCQueue`

```
LambdaIaCQueue:
  Type: AWS::SQS::Queue
  Properties:
    MessageRetentionPeriod: 345600
```

When you add an Amazon SQS queue using Infrastructure Composer, Infrastructure Composer sets the `MessageRetentionPeriod` property. You can also set the `FifoQueue` property by selecting **Details** on the SQS Queue card and checking or unchecking **Fifo queue**.

To set other properties for your queue, you can manually edit the template to add them. To learn more about the `AWS::SQS::Queue` resource and its available properties, see [AWS::SQS::Queue](#) in the *AWS CloudFormation User Guide*.

- An `Events` property in your Lambda function definition that specifies the Amazon SQS queue as a trigger for the function

```
Events:
  LambdaIaCQueue:
    Type: SQS
    Properties:
      Queue: !GetAtt LambdaIaCQueue.Arn
      BatchSize: 1
```

The `Events` property consists of an event type and a set of properties that depend on the type. To learn about the different AWS services you can configure to trigger a Lambda function and the properties you can set, see [EventSource](#) in the *AWS SAM Developer Guide*.

- A DynamoDB table with the identifier `LambdaIaCTable`

```

LambdaIaCTable:
  Type: AWS::DynamoDB::Table
  Properties:
    AttributeDefinitions:
      - AttributeName: id
        AttributeType: S
    BillingMode: PAY_PER_REQUEST
    KeySchema:
      - AttributeName: id
        KeyType: HASH
    StreamSpecification:
      StreamViewType: NEW_AND_OLD_IMAGES

```

When you add a DynamoDB table using Infrastructure Composer, you can set your table's keys by choosing **Details** on the DynamoDB table card and editing the key values. Infrastructure Composer also sets default values for a number of other properties including `BillingMode` and `StreamViewType`.

To learn more about these properties and other properties you can add to your AWS SAM template, see [AWS::DynamoDB::Table](#) in the *AWS CloudFormation User Guide*.

- A new IAM policy that gives your function permission to perform CRUD operations on the DynamoDB table you added.

```

Policies:
  ...
  - DynamoDBCrudPolicy:
      TableName: !Ref LambdaIaCTable

```

The complete final AWS SAM template should look like the following.

```

AWSTemplateFormatVersion: '2010-09-09'
Transform: AWS::Serverless-2016-10-31
Description: An AWS Serverless Specification template describing your function.
Resources:
  LambdaIaCDemo:
    Type: AWS::Serverless::Function
    Properties:
      CodeUri: .
      Description: ''

```

```

MemorySize: 128
Timeout: 3
Handler: lambda_function.lambda_handler
Runtime: python3.11
Architectures:
  - x86_64
EventInvokeConfig:
  MaximumEventAgeInSeconds: 21600
  MaximumRetryAttempts: 2
EphemeralStorage:
  Size: 512
RuntimeManagementConfig:
  UpdateRuntimeOn: Auto
SnapStart:
  ApplyOn: None
PackageType: Zip
Policies:
  - Statement:
    - Effect: Allow
      Action:
        - logs:CreateLogGroup
      Resource: arn:aws:logs:us-east-1:594035263019:*
    - Effect: Allow
      Action:
        - logs:CreateLogStream
        - logs:PutLogEvents
      Resource:
        - arn:aws:logs:us-east-1:594035263019:log-group:/aws/lambda/
LambdaIaCDemo:*
  - DynamoDBCrudPolicy:
      TableName: !Ref LambdaIaCTable
Events:
  LambdaIaCQueue:
    Type: SQS
    Properties:
      Queue: !GetAtt LambdaIaCQueue.Arn
      BatchSize: 1
Environment:
  Variables:
    LAMBDAIACTABLE_TABLE_NAME: !Ref LambdaIaCTable
    LAMBDAIACTABLE_TABLE_ARN: !GetAtt LambdaIaCTable.Arn
LambdaIaCQueue:
  Type: AWS::SQS::Queue
  Properties:

```

```
    MessageRetentionPeriod: 345600
LambdaIaCTable:
  Type: AWS::DynamoDB::Table
  Properties:
    AttributeDefinitions:
      - AttributeName: id
        AttributeType: S
    BillingMode: PAY_PER_REQUEST
    KeySchema:
      - AttributeName: id
        KeyType: HASH
    StreamSpecification:
      StreamViewType: NEW_AND_OLD_IMAGES
```

Deploy your serverless application using AWS SAM (optional)

If you want to use AWS SAM to deploy a serverless application using the template you just created in Infrastructure Composer, you first need to install the AWS SAM CLI. To do this, follow the instructions in [Installing the AWS SAM CLI](#).

Before you deploy your application, you also need to update the function code that Infrastructure Composer saved along with your template. At the moment, the `lambda_function.py` file that Infrastructure Composer saved contains only the basic 'Hello world' code that Lambda provided when you created the function.

To update your function code, copy the following code and paste it into the `lambda_function.py` file Infrastructure Composer saved to your local build machine. You specified the directory for Infrastructure Composer to save this file to when you activated Local Sync mode.

This code accepts a key value pair in a message from the Amazon SQS queue you created in Infrastructure Composer. If both the key and value are strings, the code then uses them to write an item to the DynamoDB table defined in your template.

Updated Python function code

```
import boto3
import os
import json

# define the DynamoDB table that Lambda will connect to
```



```
tablename = os.environ['LAMBDAIACTABLE_TABLE_NAME']

# create the DynamoDB resource
dynamo = boto3.client('dynamodb')

def lambda_handler(event, context):
    # get the message out of the SQS event
    message = event['Records'][0]['body']
    data = json.loads(message)
    # write event data to DDB table
    if check_message_format(data):
        key = next(iter(data))
        value = data[key]
        dynamo.put_item(
            TableName=tablename,
            Item={
                'id': {'S': key},
                'Value': {'S': value}
            }
        )
    else:
        raise ValueError("Input data not in the correct format")

# check that the event object contains a single key value
# pair that can be written to the database
def check_message_format(message):
    if len(message) != 1:
        return False

    key, value = next(iter(message.items()))

    if not (isinstance(key, str) and isinstance(value, str)):
        return False

    else:
        return True
```

To deploy your serverless application

To deploy your application using the AWS SAM CLI, carry out the following steps. For your function to build and deploy correctly, Python version 3.11 must be installed on your build machine and on your PATH.

1. Run the following command from the directory in which Infrastructure Composer saved your `template.yaml` and `lambda_function.py` files.

```
sam build
```

This command gathers the build artifacts for your application and places them in the proper format and location to deploy them.

2. To deploy your application and create the Lambda, Amazon SQS, and DynamoDB resources specified in your AWS SAM template, run the following command.

```
sam deploy --guided
```

Using the `--guided` flag means that AWS SAM will show you prompts to guide you through the deployment process. For this deployment, accept the default options by pressing Enter.

During the deployment process, AWS SAM creates the following resources in your AWS account:

- An AWS CloudFormation [stack](#) named `sam-app`
- A Lambda function with the name format `sam-app-LambdaIaCDemo-99VXPpYQVv1M`
- An Amazon SQS queue with the name format `sam-app-LambdaIaCQueue-xL87VeKsGiIo`
- A DynamoDB table with the name format `sam-app-LambdaIaCTable-CN0S66C0VLNV`

AWS SAM also creates the necessary IAM roles and policies so that your Lambda function can read messages from the Amazon SQS queue and perform CRUD operations on the DynamoDB table.

Testing your deployed application (optional)

To confirm that your serverless application deployed correctly, send a message to your Amazon SQS queue containing a key value pair and check that Lambda writes an item into your DynamoDB table using these values.

To test your serverless application

1. Open the [Queues](#) page of the Amazon SQS console and select the queue that AWS SAM created from your template. The name has the format `sam-app-LambdaIaCQueue-xL87VeKsGiIo`.

2. Choose **Send and receive messages** and paste the following JSON into the **Message body** in the **Send message** section.

```
{
  "myKey": "myValue"
}
```

3. Choose **Send message**.

Sending your message to the queue causes Lambda to invoke your function through the event source mapping defined in your AWS SAM template. To confirm that Lambda has invoked your function as expected, confirm that an item has been added to your DynamoDB table.

4. Open the [Tables](#) page of the DynamoDB console and select your table. The name has the format sam-app-LambdaIaCTable-*CN0S66C0VLNV*.
5. Choose **Explore table items**. In the **Items returned** pane, you should see an item with the **id** myKey and the **Value** myValue.

Deploying Lambda functions with the AWS CDK

The AWS Cloud Development Kit (AWS CDK) is an infrastructure as code (IaC) framework that you can use to define AWS cloud infrastructure by using a programming language of your choosing. To define your own cloud infrastructure, you first write an app (in one of the CDK's supported languages) that contains one or more stacks. Then, you synthesize it to an AWS CloudFormation template and deploy your resources to your AWS account. Follow the steps in this topic to deploy a Lambda function that returns an event from an Amazon API Gateway endpoint.

The AWS Construct Library, included with the CDK, provides modules that you can use to model the resources that AWS services provide. For popular services, the library provides curated constructs with smart defaults and best practices. You can use the [aws_lambda](#) module to define your function and supporting resources with just a few lines of code.

Prerequisites

Before starting this tutorial, install the AWS CDK by running the following command.

```
npm install -g aws-cdk
```

Step 1: Set up your AWS CDK project

Create a directory for your new AWS CDK app and initialize the project.

JavaScript

```
mkdir hello-lambda
cd hello-lambda
cdk init --language javascript
```

TypeScript

```
mkdir hello-lambda
cd hello-lambda
cdk init --language typescript
```

Python

```
mkdir hello-lambda
cd hello-lambda
cdk init --language python
```

After the project starts, activate the project's virtual environment and install the baseline dependencies for AWS CDK.

```
source .venv/bin/activate
python -m pip install -r requirements.txt
```

Java

```
mkdir hello-lambda
cd hello-lambda
cdk init --language java
```

Import this Maven project to your Java integrated development environment (IDE). For example, in Eclipse, choose **File, Import, Maven, Existing Maven Projects**.

C#

```
mkdir hello-lambda
```

```
cd hello-lambda
cdk init --language csharp
```

Note

The AWS CDK application template uses the name of the project directory to generate names for source files and classes. In this example, the directory is named `hello-lambda`. If you use a different project directory name, your app won't match these instructions.

AWS CDK v2 includes stable constructs for all AWS services in a single package that's called `aws-cdk-lib`. This package is installed as a dependency when you initialize the project. When working with certain programming languages, the package is installed when you build the project for the first time.

Step 2: Define the AWS CDK stack

A CDK *stack* is a collection of one or more constructs, which define AWS resources. Each CDK stack represents an AWS CloudFormation stack in your CDK app.

To define your CDK, stack follow the instructions for your preferred programming language. This stack defines the following:

- The function's logical name: `MyFunction`
- The location of the function code, specified in the `code` property. For more information, see [Handler code](#) in the *AWS Cloud Development Kit (AWS CDK) API Reference*.
- The REST API's logical name: `HelloApi`
- The API Gateway endpoint's logical name: `ApiGwEndpoint`

Note that all of the CDK stacks in this tutorial use the Node.js [runtime](#) for the Lambda function. You can use different programming languages for the CDK stack and the Lambda function to leverage the strengths of each language. For example, you can use TypeScript for the CDK stack to leverage the benefits of static typing for your infrastructure code. You can use JavaScript for the Lambda function to take advantage of the flexibility and rapid development of a dynamically typed language.

JavaScript

Open the `lib/hello-lambda-stack.js` file and replace the contents with the following.

```
const { Stack } = require('aws-cdk-lib');
const lambda = require('aws-cdk-lib/aws-lambda');
const apigw = require('aws-cdk-lib/aws-apigateway');

class HelloLambdaStack extends Stack {
  /**
   *
   * @param {Construct} scope
   * @param {string} id
   * @param {StackProps=} props
   */
  constructor(scope, id, props) {
    super(scope, id, props);
    const fn = new lambda.Function(this, 'MyFunction', {
      code: lambda.Code.fromAsset('lib/lambda-handler'),
      runtime: lambda.Runtime.NODEJS_LATEST,
      handler: 'index.handler'
    });

    const endpoint = new apigw.LambdaRestApi(this, 'MyEndpoint', {
      handler: fn,
      restApiName: "HelloApi"
    });
  }
}

module.exports = { HelloLambdaStack }
```

TypeScript

Open the `lib/hello-lambda-stack.ts` file and replace the contents with the following.

```
import * as cdk from 'aws-cdk-lib';
import { Construct } from 'constructs';
import * as apigw from "aws-cdk-lib/aws-apigateway";
import * as lambda from "aws-cdk-lib/aws-lambda";
import * as path from 'node:path';
```

```
export class HelloLambdaStack extends cdk.Stack {
  constructor(scope: Construct, id: string, props?: cdk.StackProps){
    super(scope, id, props)
    const fn = new lambda.Function(this, 'MyFunction', {
      runtime: lambda.Runtime.NODEJS_LATEST,
      handler: 'index.handler',
      code: lambda.Code.fromAsset(path.join(__dirname, 'lambda-handler')),
    });

    const endpoint = new apigw.LambdaRestApi(this, `ApiGwEndpoint`, {
      handler: fn,
      restApiName: `HelloApi`,
    });

  }
}
```

Python

Open the `/hello-lambda/hello_lambda/hello_lambda_stack.py` file and replace the contents with the following.

```
from aws_cdk import (
    Stack,
    aws_apigateway as apigw,
    aws_lambda as _lambda
)
from constructs import Construct

class HelloLambdaStack(Stack):

    def __init__(self, scope: Construct, construct_id: str, **kwargs) -> None:
        super().__init__(scope, construct_id, **kwargs)

        fn = _lambda.Function(
            self,
            "MyFunction",
            runtime=_lambda.Runtime.NODEJS_LATEST,
            handler="index.handler",
            code=_lambda.Code.from_asset("lib/lambda-handler")
        )

        endpoint = apigw.LambdaRestApi(
```

```
        self,
        "ApiGwEndpoint",
        handler=fn,
        rest_api_name="HelloApi"
    )
```

Java

Open the `/hello-lambda/src/main/java/com/myorg/HelloLambdaStack.java` file and replace the contents with the following.

```
package com.myorg;

import software.constructs.Construct;
import software.amazon.awscdk.Stack;
import software.amazon.awscdk.StackProps;
import software.amazon.awscdk.services.apigateway.LambdaRestApi;
import software.amazon.awscdk.services.lambda.Function;

public class HelloLambdaStack extends Stack {
    public HelloLambdaStack(final Construct scope, final String id) {
        this(scope, id, null);
    }

    public HelloLambdaStack(final Construct scope, final String id, final StackProps
props) {
        super(scope, id, props);

        Function hello = Function.Builder.create(this, "MyFunction")

            .runtime(software.amazon.awscdk.services.lambda.Runtime.NODEJS_LATEST)

            .code(software.amazon.awscdk.services.lambda.Code.fromAsset("lib/lambda-handler"))
                .handler("index.handler")
                .build();

        LambdaRestApi api = LambdaRestApi.Builder.create(this, "ApiGwEndpoint")
            .restApiName("HelloApi")
            .handler(hello)
            .build();
    }
}
```

C#

Open the `src/HelloLambda/HelloLambdaStack.cs` file and replace the contents with the following.

```
using Amazon.CDK;
using Amazon.CDK.AWS.APIGateway;
using Amazon.CDK.AWS.Lambda;
using Constructs;

namespace HelloLambda
{
    public class HelloLambdaStack : Stack
    {
        internal HelloLambdaStack(Construct scope, string id, IStackProps props =
null) : base(scope, id, props)
        {
            var fn = new Function(this, "MyFunction", new FunctionProps
            {
                Runtime = Runtime.NODEJS_LATEST,
                Code = Code.FromAsset("lib/lambda-handler"),
                Handler = "index.handler"
            });

            var api = new LambdaRestApi(this, "ApiGwEndpoint", new
LambdaRestApiProps
            {
                Handler = fn
            });
        }
    }
}
```

Step 3: Create the Lambda function code

1. From the root of your project (`hello-lambda`), create the `/lib/lambda-handler` directory for the Lambda function code. This directory is specified in the `code` property of your AWS CDK stack.

2. Create a new file called `index.js` in the `/lib/lambda-handler` directory. Paste the following code into the file. The function extracts specific properties from the API request and returns them as a JSON response.

```
exports.handler = async (event) => {
  // Extract specific properties from the event object
  const { resource, path, httpMethod, headers, queryStringParameters, body } =
    event;
  const response = {
    resource,
    path,
    httpMethod,
    headers,
    queryStringParameters,
    body,
  };
  return {
    body: JSON.stringify(response, null, 2),
    statusCode: 200,
  };
};
```

Step 4: Deploy the AWS CDK stack

1. From the root of your project, run the [cdk synth](#) command:

```
cdk synth
```

This command synthesizes an AWS CloudFormation template from your CDK stack. The template is an approximately 400-line YAML file, similar to the following.

Note

If you get the following error, make sure that you are in the root of your project directory.

```
--app is required either in command-line, in cdk.json or in ~/.cdk.json
```

Example AWS CloudFormation template

```
Resources:
  MyFunctionServiceRole3C357FF2:
    Type: AWS::IAM::Role
    Properties:
      AssumeRolePolicyDocument:
        Statement:
          - Action: sts:AssumeRole
            Effect: Allow
            Principal:
              Service: lambda.amazonaws.com
        Version: "2012-10-17"
      ManagedPolicyArns:
        - Fn::Join:
            - ""
            - - "arn:"
              - Ref: AWS::Partition
              - :iam::aws:policy/service-role/AWSLambdaBasicExecutionRole
      Metadata:
        aws:cdk:path: HelloLambdaStack/MyFunction/ServiceRole/Resource
  MyFunction1BAA52E7:
    Type: AWS::Lambda::Function
    Properties:
      Code:
        S3Bucket:
          Fn::Sub: cdk-hnb659fds-assets-${AWS::AccountId}-${AWS::Region}
        S3Key:
          ab111111cd32708dc4b83e81a21c296d607ff2cdef00f1d7f48338782f9213901.zip
      Handler: index.handler
      Role:
        Fn::GetAtt:
          - MyFunctionServiceRole3C357FF2
          - Arn
      Runtime: nodejs20.x
      ...
```

2. Run the [cdk deploy](#) command:

```
cdk deploy
```

Wait while your resources are created. The final output includes the URL for your API Gateway endpoint. Example:

Outputs:

```
HelloLambdaStack.ApiGwEndpoint77F417B1 = https://abcd1234.execute-api.us-east-1.amazonaws.com/prod/
```

Step 5: Test the function

To invoke the Lambda function, copy the API Gateway endpoint and paste it into a web browser or run a `curl` command:

```
curl -s https://abcd1234.execute-api.us-east-1.amazonaws.com/prod/
```

The response is a JSON representation of selected properties from the original event object, which contains information about the request made to the API Gateway endpoint. Example:

```
{
  "resource": "/",
  "path": "/",
  "httpMethod": "GET",
  "headers": {
    "Accept": "text/html,application/xhtml+xml,application/xml;q=0.9,image/avif,image/webp,image/apng,*/*;q=0.8,application/signed-exchange;v=b3;q=0.7",
    "Accept-Encoding": "gzip, deflate, br, zstd",
    "Accept-Language": "en-US,en;q=0.9",
    "CloudFront-Forwarded-Proto": "https",
    "CloudFront-Is-Desktop-Viewer": "true",
    "CloudFront-Is-Mobile-Viewer": "false",
    "CloudFront-Is-SmartTV-Viewer": "false",
    "CloudFront-Is-Tablet-Viewer": "false",
    "CloudFront-Viewer-ASN": "16509",
    "CloudFront-Viewer-Country": "US",
    "Host": "abcd1234.execute-api.us-east-1.amazonaws.com",
    ...
  }
}
```

Step 6: Clean up your resources

The API Gateway endpoint is publicly accessible. To prevent unexpected charges, run the [cdk destroy](#) command to delete the stack and all associated resources.

```
cdk destroy
```

Next steps

For information about writing AWS CDK apps in your language of choice, see the following:

TypeScript

[Working with the AWS CDK in TypeScript](#)

JavaScript

[Working with the AWS CDK in JavaScript](#)

Python

[Working with the AWS CDK in Python](#)

Java

[Working with the AWS CDK in Java](#)

C#

[Working with the AWS CDK in C#](#)

Go

[Working with the AWS CDK in Go](#)

Lambda runtimes

Lambda supports multiple languages through the use of *runtimes*. A runtime provides a language-specific environment that relays invocation events, context information, and responses between Lambda and the function. You can use runtimes that Lambda provides, or build your own.

Each major programming language release has a separate runtime, with a unique *runtime identifier*, such as `nodejs22.x` or `python3.13`. To configure a function to use a new major language version, you need to change the runtime identifier. Since AWS Lambda cannot guarantee backward compatibility between major versions, this is a customer-driven operation.

For a [function defined as a container image](#), you choose a runtime and the Linux distribution when you create the container image. To change the runtime, you create a new container image.

When you use a .zip file archive for the deployment package, you choose a runtime when you create the function. To change the runtime, you can [update your function's configuration](#). The runtime is paired with one of the Amazon Linux distributions. The underlying execution environment provides additional libraries and [environment variables](#) that you can access from your function code.

Lambda invokes your function in an [execution environment](#). The execution environment provides a secure and isolated runtime environment that manages the resources required to run your function. Lambda re-uses the execution environment from a previous invocation if one is available, or it can create a new execution environment.

To use other languages in Lambda, such as [Go](#) or [Rust](#), use an [OS-only runtime](#). The Lambda execution environment provides a [runtime interface](#) for getting invocation events and sending responses. You can deploy other languages by implementing a [custom runtime](#) alongside your function code, or in a [layer](#).

Supported runtimes

The following table lists the supported Lambda runtimes and projected deprecation dates. After a runtime is deprecated, you're still able to create and update functions for a limited period. For more information, see [the section called "Runtime use after deprecation"](#). The table provides the currently forecasted dates for runtime deprecation. These dates are provided for planning purposes and are subject to change.

Name	Identifier	Operating system	Deprecation date	Block function create	Block function update
Node.js 22	nodejs22.x	Amazon Linux 2023	Not scheduled	Not scheduled	Not scheduled
Node.js 20	nodejs20.x	Amazon Linux 2023	Not scheduled	Not scheduled	Not scheduled
Node.js 18	nodejs18.x	Amazon Linux 2	Jul 31, 2025	Sep 1, 2025	Oct 1, 2025
Python 3.13	python3.13	Amazon Linux 2023	Not scheduled	Not scheduled	Not scheduled
Python 3.12	python3.12	Amazon Linux 2023	Not scheduled	Not scheduled	Not scheduled
Python 3.11	python3.11	Amazon Linux 2	Not scheduled	Not scheduled	Not scheduled
Python 3.10	python3.10	Amazon Linux 2	Not scheduled	Not scheduled	Not scheduled
Python 3.9	python3.9	Amazon Linux 2	Not scheduled	Not scheduled	Not scheduled
Java 21	java21	Amazon Linux 2023	Not scheduled	Not scheduled	Not scheduled
Java 17	java17	Amazon Linux 2	Not scheduled	Not scheduled	Not scheduled
Java 11	java11	Amazon Linux 2	Not scheduled	Not scheduled	Not scheduled
Java 8	java8.a12	Amazon Linux 2	Not scheduled	Not scheduled	Not scheduled

Name	Identifier	Operating system	Deprecation date	Block function create	Block function update
.NET 8	dotnet8	Amazon Linux 2023	Not scheduled	Not scheduled	Not scheduled
Ruby 3.3	ruby3.3	Amazon Linux 2023	Not scheduled	Not scheduled	Not scheduled
Ruby 3.2	ruby3.2	Amazon Linux 2	Not scheduled	Not scheduled	Not scheduled
OS-only Runtime	provided.al2023	Amazon Linux 2023	Not scheduled	Not scheduled	Not scheduled
OS-only Runtime	provided.al2	Amazon Linux 2	Not scheduled	Not scheduled	Not scheduled

Note

For new regions, Lambda will not support runtimes that are set to be deprecated within the next 6 months.

Lambda keeps managed runtimes and their corresponding container base images up to date with patches and support for minor version releases. For more information see [Lambda runtime updates](#).

Importantly, Lambda also provides [AWS SDKs](#) for supported runtimes. SDKs enable you to programmatically interact with AWS services using familiar code constructs. SDK versions change frequently as AWS adds new features and services, and Lambda periodically updates the bundled SDKs. In these cases, SDK version changes typically do not impact the functionality or performance. To lock an SDK version and make it immutable, you can [create a Lambda layer](#) with a specific version of an SDK and include this in your deployment package. Additionally, packaging a function as a container image also locks the SDK version in the image.

Lambda continues to support the Go programming language after deprecation of the Go 1.x runtime. For more information, see [Migrating AWS Lambda functions from the Go1.x runtime to the custom runtime on Amazon Linux 2](#) on the *AWS Compute Blog*.

All supported Lambda runtimes support both x86_64 and arm64 architectures.

New runtime releases

Lambda provides managed runtimes for new language versions only when the release reaches the long-term support (LTS) phase of the language's release cycle. For example, for the [Node.js release cycle](#), when the release reaches the Active LTS phase.

Before the release reaches the long-term support phase, it remains in development and can still be subject to breaking changes. Lambda applies runtime updates automatically by default, so breaking changes to a runtime version could stop your functions from working as expected.

Lambda doesn't provide managed runtimes for language versions which aren't scheduled for LTS release.

The following list shows the target launch month for upcoming Lambda runtimes. These dates are indicative only and subject to change.

- **Ruby 3.4** - March 2025
- **Java 25** - October 2025
- **Python 3.14** - November 2025
- **Node.js 24** - November 2025
- **.NET 10** - December 2025

Runtime deprecation policy

[Lambda runtimes](#) for .zip file archives are built around a combination of operating system, programming language, and software libraries that are subject to maintenance and security updates. Lambda's standard deprecation policy is to deprecate a runtime when any major component of the runtime reaches the end of community long-term support (LTS) and security updates are no longer available. Most usually, this is the language runtime, though in some cases, a runtime can be deprecated because the operating system (OS) reaches end of LTS.

After a runtime is deprecated, AWS may no longer apply security patches or updates to that runtime, and functions using that runtime are no longer eligible for technical support. Such deprecated runtimes are provided 'as-is', without any warranties, and may contain bugs, errors, defects, or other vulnerabilities.

To learn more about managing runtime upgrades and deprecation, see the following sections and [Managing AWS Lambda runtime upgrades](#) on the *AWS Compute Blog*.

Important

Lambda occasionally delays deprecation of a Lambda runtime for a limited period beyond the end of support date of the language version that the runtime supports. During this period, Lambda only applies security patches to the runtime OS. Lambda doesn't apply security patches to programming language runtimes after they reach their end of support date.

Shared responsibility model

Lambda is responsible for curating and publishing security updates for all supported managed runtimes and container base images. By default, Lambda will apply these updates automatically to functions using managed runtimes. Where the default automatic runtime update setting has been changed, see the [runtime management controls shared responsibility model](#). For functions deployed using container images, you're responsible for rebuilding your function's container image from the latest base image and redeploying the container image.

When a runtime is deprecated, Lambda's responsibility for updating the managed runtime and container base images ceases. You are responsible for upgrading your functions to use a supported runtime or base image.

In all cases, you are responsible for applying updates to your function code, including its dependencies. Your responsibilities under the shared responsibility model are summarized in the following table.

Runtime lifecycle phase	Lambda's responsibilities	Your responsibilities
Supported managed runtime	Provide regular runtime updates with security patches and other updates.	Update your function code, including dependencies, to

Runtime lifecycle phase	Lambda's responsibilities	Your responsibilities
	Apply runtime updates automatically by default (see the section called "Runtime update modes" for non-default behaviors).	address any security vulnerabilities.
Supported container image	Provide regular updates to container base image with security patches and other updates.	<p>Update your function code, including dependencies, to address any security vulnerabilities.</p> <p>Regularly re-build and re-deploy your container image using the latest base image.</p>
Managed runtime approaching deprecation	<p>Notify customers prior to runtime deprecation via documentation, AWS Health Dashboard, email, and Trusted Advisor.</p> <p>Responsibility for runtime updates ends at deprecation.</p>	<p>Monitor Lambda documentation, AWS Health Dashboard, email, or Trusted Advisor for runtime deprecation information.</p> <p>Upgrade functions to a supported runtime before the previous runtime is deprecated.</p>
Container image approaching deprecation	<p>Deprecation notifications are not available for functions using container images.</p> <p>Responsibility for container base image updates ends at deprecation.</p>	Be aware of deprecation schedules and upgrade functions to a supported base image before the previous image is deprecated.

Runtime use after deprecation

After a runtime is deprecated, AWS may no longer apply security patches or updates to that runtime, and functions using that runtime are no longer eligible for technical support. Such deprecated runtimes are provided 'as-is', without any warranties, and may contain bugs, errors, defects, or other vulnerabilities. Functions that use a deprecated runtime may also experience degraded performance or other issues, such as a certificate expiry, that can cause them to stop working properly.

For at least 30 days after a runtime is deprecated, you're still able to create new Lambda functions using that runtime. Starting from 30 days after deprecation, Lambda begins blocking the creation of new functions.

For at least 60 days after a runtime is deprecated, you're still able to update function code and configuration for existing functions. Starting from 60 days after deprecation, Lambda begins blocking the update of function code and configuration for existing functions.

Note

For some runtimes, AWS is delaying the block-function-create and block-function-update dates beyond the usual 30 and 60 days after deprecation. AWS has made this change in response to customer feedback to give you more time to upgrade your functions. Refer to the tables in [the section called "Supported runtimes"](#) and [the section called "Deprecated runtimes"](#) to see the dates for your runtime.

You can update a function to use a newer supported runtime indefinitely after a runtime is deprecated. You should test that your function works with the new runtime before applying the runtime change in production environments, since you will not be able to revert to the deprecated runtime once the 60-day period has passed. We recommend using function [versions](#) and [aliases](#) to enable safe deployment with rollback.

Note that the exact length of time for which you can continue to create and update functions isn't fixed. This period can vary for each deprecation and for different AWS Regions. Nominal dates for the blocking of function creates and updates are provided in the Supported Runtimes table in the first section of this page. Lambda will not start blocking function creates or updates before the dates given in this table.

You can continue to invoke your functions indefinitely after the runtime is deprecated. However, AWS strongly recommends that you migrate functions to a supported runtime so that your functions continue to receive security patches and remain eligible for technical support.

Receiving runtime deprecation notifications

When a runtime approaches its deprecation date, Lambda sends you an email alert if any functions in your AWS account use that runtime. Notifications are also displayed in the AWS Health Dashboard and in AWS Trusted Advisor.

- Receiving email notifications:

Lambda sends you an email alert at least **180 days** before a runtime is deprecated. This email lists the **LATEST** versions of all functions using the runtime. To see a full list of affected function versions, use Trusted Advisor or see [the section called “Get data about functions by runtime”](#).

Lambda sends email notification to your AWS account's primary account contact. For information about viewing or updating the email addresses in your account, see [Updating contact information](#) in the *AWS General Reference*.

- Receiving notifications through the AWS Health Dashboard:

The AWS Health Dashboard displays a notification at least **180 days** before a runtime is deprecated. Notifications appear on the **Your account health** page under [Other notifications](#). The **Affected resources** tab of the notification lists the **LATEST** versions of all functions using the runtime.

Note

To see a full and up-to-date list of affected function versions, use Trusted Advisor or see [the section called “Get data about functions by runtime”](#).

AWS Health Dashboard notifications expire 90 days after the affected runtime is deprecated.

- Using AWS Trusted Advisor

Trusted Advisor displays a notification **180 days** before a runtime is deprecated. Notifications appear on the [Security](#) page. A list of your affected functions is displayed under **AWS Lambda**

Functions Using Deprecated Runtimes. This list of functions shows both \$LATEST and published versions and updates automatically to reflect your functions' current status.

You can turn on weekly email notifications from Trusted Advisor in the [Preferences](#) page of the Trusted Advisor console.

Deprecated runtimes

The following runtimes have reached end of support:

Name	Identifier	Operating system	Deprecation date	Block function create	Block function update
.NET 6	dotnet6	Amazon Linux 2	Dec 20, 2024	Feb 28, 2025	Mar 31, 2025
Python 3.8	python3.8	Amazon Linux 2	Oct 14, 2024	Feb 28, 2025	Mar 31, 2025
Node.js 16	nodejs16.x	Amazon Linux 2	Jun 12, 2024	Feb 28, 2025	Mar 31, 2025
.NET 7 (container only)	dotnet7	Amazon Linux 2	May 14, 2024	N/A	N/A
Java 8	java8	Amazon Linux	Jan 8, 2024	Feb 8, 2024	Feb 28, 2025
Go 1.x	go1.x	Amazon Linux	Jan 8, 2024	Feb 8, 2024	Feb 28, 2025
OS-only Runtime	provided	Amazon Linux	Jan 8, 2024	Feb 8, 2024	Feb 28, 2025
Ruby 2.7	ruby2.7	Amazon Linux 2	Dec 7, 2023	Jan 9, 2024	Feb 28, 2025

Name	Identifier	Operating system	Deprecation date	Block function create	Block function update
Node.js 14	nodejs14.x	Amazon Linux 2	Dec 4, 2023	Jan 9, 2024	Feb 28, 2025
Python 3.7	python3.7	Amazon Linux	Dec 4, 2023	Jan 9, 2024	Feb 28, 2025
.NET Core 3.1	dotnetcore3.1	Amazon Linux 2	Apr 3, 2023	Apr 3, 2023	May 3, 2023
Node.js 12	nodejs12.x	Amazon Linux 2	Mar 31, 2023	Mar 31, 2023	Apr 30, 2023
Python 3.6	python3.6	Amazon Linux	Jul 18, 2022	Jul 18, 2022	Aug 29, 2022
.NET 5 (container only)	dotnet5.0	Amazon Linux 2	May 10, 2022	N/A	N/A
.NET Core 2.1	dotnetcore2.1	Amazon Linux	Jan 5, 2022	Jan 5, 2022	Apr 13, 2022
Node.js 10	nodejs10.x	Amazon Linux 2	Jul 30, 2021	Jul 30, 2021	Feb 14, 2022
Ruby 2.5	ruby2.5	Amazon Linux	Jul 30, 2021	Jul 30, 2021	Mar 31, 2022
Python 2.7	python2.7	Amazon Linux	Jul 15, 2021	Jul 15, 2021	May 30, 2022
Node.js 8.10	nodejs8.10	Amazon Linux	Mar 6, 2020	N/A	Mar 6, 2020

Name	Identifier	Operating system	Deprecation date	Block function create	Block function update
Node.js 4.3	nodejs4.3	Amazon Linux	Mar 5, 2020	N/A	Mar 5, 2020
Node.js 4.3 edge	nodejs4.3-edge	Amazon Linux	Mar 5, 2020	N/A	Apr 30, 2019
Node.js 6.10	nodejs6.10	Amazon Linux	Aug 12, 2019	Aug 12, 2019	N/A
.NET Core 1.0	dotnetcore1.0	Amazon Linux	Jun 27, 2019	N/A	Jul 30, 2019
.NET Core 2.0	dotnetcore2.0	Amazon Linux	May 30, 2019	N/A	May 30, 2019
Node.js 0.10	nodejs	Amazon Linux	N/A	N/A	Oct 31, 2016

In almost all cases, the end-of-life date of a language version or operating system is known well in advance. The following links give end-of-life schedules for each language that Lambda supports as a managed runtime.

Language and framework support policies

- **Node.js** – github.com
- **Python** – devguide.python.org
- **Ruby** – www.ruby-lang.org
- **Java** – www.oracle.com and [Corretto FAQs](#)
- **Go** – golang.org
- **.NET** – dotnet.microsoft.com

Understanding how Lambda manages runtime version updates

Lambda keeps each managed runtime up to date with security updates, bug fixes, new features, performance enhancements, and support for minor version releases. These runtime updates are published as *runtime versions*. Lambda applies runtime updates to functions by migrating the function from an earlier runtime version to a new runtime version.

By default, for functions using managed runtimes, Lambda applies runtime updates automatically. With automatic runtime updates, Lambda takes on the operational burden of patching the runtime versions. For most customers, automatic updates are the right choice. You can change this default behavior by [configuring runtime management settings](#).

Lambda also publishes each new runtime version as a container image. To update runtime versions for container-based functions, you must [create a new container image](#) from the updated base image and redeploy your function.

Each runtime version is associated with a version number and an ARN (Amazon Resource Name). Runtime version numbers use a numbering scheme that Lambda defines, independent of the version numbers that the programming language uses. Runtime version numbers are not always sequential. For example, version 42 might be followed by version 45. The runtime version ARN is a unique identifier for each runtime version. You can view the ARN of your function's current runtime version in the Lambda console, or the [INIT_START line of your function logs](#).

Runtime versions should not be confused with runtime identifiers. Each runtime has a unique **runtime identifier**, such as `python3.13` or `nodejs22.x`. These correspond to each major programming language release. Runtime versions describe the patch version of an individual runtime.

Note

The ARN for the same runtime version number can vary between AWS Regions and CPU architectures.

Topics

- [Runtime update modes](#)
- [Two-phase runtime version rollout](#)

- [Configuring Lambda runtime management settings](#)
- [Rolling back a Lambda runtime version](#)
- [Identifying Lambda runtime version changes](#)
- [Understanding the shared responsibility model for Lambda runtime management](#)
- [Controlling Lambda runtime update permissions for high-compliance applications](#)

Runtime update modes

Lambda strives to provide runtime updates that are backward compatible with existing functions. However, as with software patching, there are rare cases in which a runtime update can negatively impact an existing function. For example, security patches can expose an underlying issue with an existing function that depends on the previous, insecure behavior. Lambda runtime management controls help reduce the risk of impact to your workloads in the rare event of a runtime version incompatibility. For each [function version](#) (\$LATEST or published version), you can choose one of the following runtime update modes:

- **Auto (default)** – Automatically update to the most recent and secure runtime version using [Two-phase runtime version rollout](#). We recommend this mode for most customers so that you always benefit from runtime updates.
- **Function update** – Update to the most recent and secure runtime version when you update your function. When you update your function, Lambda updates the runtime of your function to the most recent and secure runtime version. This approach synchronizes runtime updates with function deployments, giving you control over when Lambda applies runtime updates. With this mode, you can detect and mitigate rare runtime update incompatibilities early. When using this mode, you must regularly update your functions to keep their runtime up to date.
- **Manual** – Manually update your runtime version. You specify a runtime version in your function configuration. The function uses this runtime version indefinitely. In the rare case in which a new runtime version is incompatible with an existing function, you can use this mode to roll back your function to an earlier runtime version. We recommend against using **Manual** mode to try to achieve runtime consistency across deployments. For more information, see [Rolling back a Lambda runtime version](#).

Responsibility for applying runtime updates to your functions varies according to which runtime update mode you choose. For more information, see [Understanding the shared responsibility model for Lambda runtime management](#).

Two-phase runtime version rollout

Lambda introduces new runtime versions in the following order:

1. In the first phase, Lambda applies the new runtime version whenever you create or update a function. A function gets updated when you call the [UpdateFunctionCode](#) or [UpdateFunctionConfiguration](#) API operations.
2. In the second phase, Lambda updates any function that uses the **Auto** runtime update mode and that hasn't already been updated to the new runtime version.

The overall duration of the rollout process varies according to multiple factors, including the severity of any security patches included in the runtime update.

If you're actively developing and deploying your functions, you will most likely pick up new runtime versions during the first phase. This synchronizes runtime updates with function updates. In the rare event that the latest runtime version negatively impacts your application, this approach lets you take prompt corrective action. Functions that aren't in active development still receive the operational benefit of automatic runtime updates during the second phase.

This approach doesn't affect functions set to **Function update** or **Manual** mode. Functions using **Function update** mode receive the latest runtime updates only when you create or update them. Functions using **Manual** mode don't receive runtime updates.

Lambda publishes new runtime versions in a gradual, rolling fashion across AWS Regions. If your functions are set to **Auto** or **Function update** modes, it's possible that functions deployed at the same time to different Regions, or at different times in the same Region, will pick up different runtime versions. Customers who require guaranteed runtime version consistency across their environments should [use container images to deploy their Lambda functions](#). The **Manual** mode is designed as a temporary mitigation to enable runtime version rollback in the rare event that a runtime version is incompatible with your function.

Configuring Lambda runtime management settings

You can configure runtime management settings using the Lambda console or the AWS Command Line Interface (AWS CLI).

Note

You can configure runtime management settings separately for each [function version](#).

To configure how Lambda updates your runtime version (console)

1. Open the [Functions page](#) of the Lambda console.
2. Choose the name of a function.
3. On the **Code** tab, under **Runtime settings**, choose **Edit runtime management configuration**.
4. Under **Runtime management configuration**, choose one of the following:
 - To have your function update to the latest runtime version automatically, choose **Auto**.
 - To have your function update to the latest runtime version when you change the function, choose **Function update**.
 - To have your function update to the latest runtime version only when you change the runtime version ARN, choose **Manual**. You can find the runtime version ARN under **Runtime management configuration**. You can also find the ARN in the INIT_START line of your function logs.

For more information about these options, see [Runtime update modes](#).

5. Choose **Save**.

To configure how Lambda updates your runtime version (AWS CLI)

To configure runtime management for a function, run the [put-runtime-management-config](#) AWS CLI command. When using Manual mode, you must also provide the runtime version ARN.

```
aws lambda put-runtime-management-config \  
  --function-name my-function \  
  --update-runtime-on Manual \  
  --runtime-version-arn arn:aws:lambda:us-  
east-2::runtime:8eeff65f6809a3ce81507fe733fe09b835899b99481ba22fd75b5a7338290ec1
```

You should see output similar to the following:

```
{
```

```
"UpdateRuntimeOn": "Manual",
"FunctionArn": "arn:aws:lambda:us-east-2:111122223333:function:my-function",
"RuntimeVersionArn": "arn:aws:lambda:us-
east-2::runtime:8eeff65f6809a3ce81507fe733fe09b835899b99481ba22fd75b5a7338290ec1"
}
```

Rolling back a Lambda runtime version

In the rare event that a new runtime version is incompatible with your existing function, you can roll back its runtime version to an earlier one. This keeps your application working and minimizes disruption, providing time to remedy the incompatibility before returning to the latest runtime version.

Lambda doesn't impose a time limit on how long you can use any particular runtime version. However, we strongly recommend updating to the latest runtime version as soon as possible to benefit from the latest security patches, performance improvements, and features. Lambda provides the option to roll back to an earlier runtime version only as a temporary mitigation in the rare event of a runtime update compatibility issue. Functions using an earlier runtime version for an extended period may eventually experience degraded performance or issues, such as a certificate expiry, which can cause them to stop working properly.

You can roll back a runtime version in the following ways:

- [Using the Manual runtime update mode](#)
- [Using published function versions](#)

For more information, see [Introducing AWS Lambda runtime management controls](#) on the AWS Compute Blog.

Roll back a runtime version using Manual runtime update mode

If you're using the **Auto** runtime version update mode, or you're using the `$LATEST` runtime version, you can roll back your runtime version using the **Manual** mode. For the [function version](#) you want to roll back, change the runtime version update mode to **Manual** and specify the ARN of the previous runtime version. For more information about finding the ARN of the previous runtime version, see [Identifying Lambda runtime version changes](#).

Note

If the `$LATEST` version of your function is configured to use **Manual** mode, then you can't change the CPU architecture or runtime version that your function uses. To make these changes, you must change to **Auto** or **Function update** mode.

Roll back a runtime version using published function versions

Published [function versions](#) are an immutable snapshot of the `$LATEST` function code and configuration at the time that you created them. In **Auto** mode, Lambda automatically updates the runtime version of published function versions during phase two of the runtime version rollout. In **Function update** mode, Lambda doesn't update the runtime version of published function versions.

Published function versions using **Function update** mode therefore create a static snapshot of the function code, configuration, and runtime version. By using **Function update** mode with function versions, you can synchronize runtime updates with your deployments. You can also coordinate rollback of code, configuration, and runtime versions by redirecting traffic to an earlier published function version. You can integrate this approach into your continuous integration and continuous delivery (CI/CD) for fully automatic rollback in the rare event of runtime update incompatibility. When using this approach, you must update your function regularly and publish new function versions to pick up the latest runtime updates. For more information, see [Understanding the shared responsibility model for Lambda runtime management](#).

Identifying Lambda runtime version changes

The [runtime version number](#) and ARN are logged in the `INIT_START` log line, which Lambda emits to CloudWatch Logs each time that it creates a new [execution environment](#). Because the execution environment uses the same runtime version for all function invocations, Lambda emits the `INIT_START` log line only when Lambda executes the init phase. Lambda doesn't emit this log line for each function invocation. Lambda emits the log line to CloudWatch Logs, but it is not visible in the console.

Note

Runtime version numbers are not always sequential. For example, version 42 might be followed by version 45.

Example Example INIT_START log line

```
INIT_START Runtime Version: python:3.13.v14    Runtime Version ARN: arn:aws:lambda:eu-south-1::runtime:7b620fc2e66107a1046b140b9d320295811af3ad5d4c6a011fad1fa65127e9e6I
```

Rather than working directly with the logs, you can use [Amazon CloudWatch Contributor Insights](#) to identify transitions between runtime versions. The following rule counts the distinct runtime versions from each INIT_START log line. To use the rule, replace the example log group name `/aws/lambda/*` with the appropriate prefix for your function or group of functions.

```
{
  "Schema": {
    "Name": "CloudWatchLogRule",
    "Version": 1
  },
  "AggregateOn": "Count",
  "Contribution": {
    "Filters": [
      {
        "Match": "eventType",
        "In": [
          "INIT_START"
        ]
      }
    ],
    "Keys": [
      "runtimeVersion",
      "runtimeVersionArn"
    ]
  },
  "LogFormat": "CLF",
  "LogGroupNames": [
    "/aws/lambda/*"
  ],
  "Fields": {
    "1": "eventType",
    "4": "runtimeVersion",
    "8": "runtimeVersionArn"
  }
}
```

The following CloudWatch Contributor Insights report shows an example of a runtime version transition as captured by the preceding rule. The orange line shows execution environment initialization for the earlier runtime version (**python:3.13.v12**), and the blue line shows execution environment initialization for the new runtime version (**python:3.13.v14**).

Top 2 of 2 unique contributors

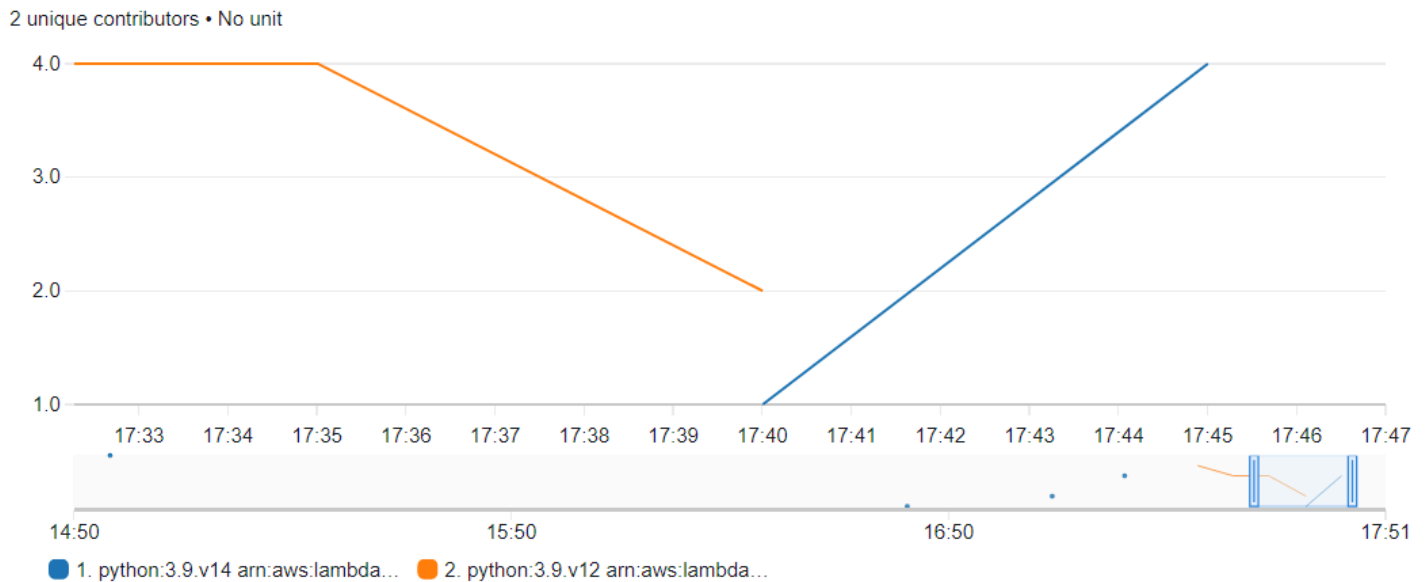

Understanding the shared responsibility model for Lambda runtime management

Lambda is responsible for curating and publishing security updates for all supported managed runtimes and container images. Responsibility for updating existing functions to use the latest runtime version varies depending on which runtime update mode you use.

Lambda is responsible for applying runtime updates to all functions configured to use the **Auto** runtime update mode.

For functions configured with the **Function update** runtime update mode, you're responsible for regularly updating your function. Lambda is responsible for applying runtime updates when you make those updates. If you don't update your function, then Lambda doesn't update the runtime. If you don't regularly update your function, then we strongly recommend configuring it for automatic runtime updates so that it continues to receive security updates.

For functions configured to use the **Manual** runtime update mode, you're responsible for updating your function to use the latest runtime version. We strongly recommend that you use this mode only to roll back the runtime version as a temporary mitigation in the rare event of runtime update

incompatibility. We also recommend that you change to **Auto** mode as quickly as possible to minimize the time in which your functions aren't patched.

If you're [using container images to deploy your functions](#), then Lambda is responsible for publishing updated base images. In this case, you're responsible for rebuilding your function's container image from the latest base image and redeploying the container image.

This is summarized in the following table:

Deployment mode	Lambda's responsibility	Customer's responsibility
Managed runtime, Auto mode	<p>Publish new runtime versions containing the latest patches.</p> <p>Apply runtime patches to existing functions.</p>	Roll back to a previous runtime version in the rare event of a runtime update compatibility issue.
Managed runtime, Function update mode	Publish new runtime versions containing the latest patches.	<p>Update functions regularly to pick up the latest runtime version.</p> <p>Switch a function to Auto mode when you're not regularly updating the function.</p> <p>Roll back to a previous runtime version in the rare event of a runtime update compatibility issue.</p>
Managed runtime, Manual mode	Publish new runtime versions containing the latest patches.	<p>Use this mode only for temporary runtime rollback in the rare event of a runtime update compatibility issue.</p> <p>Switch functions to Auto or Function update mode and the latest runtime version as soon as possible.</p>
Container image	Publish new container images containing the latest patches.	Redeploy functions regularly using the latest container base image to pick up the latest patches.

For more information about shared responsibility with AWS, see [Shared Responsibility Model](#).

Controlling Lambda runtime update permissions for high-compliance applications

To meet patching requirements, Lambda customers typically rely on automatic runtime updates. If your application is subject to strict patching freshness requirements, you may want to limit use of earlier runtime versions. You can restrict Lambda's runtime management controls by using AWS Identity and Access Management (IAM) to deny users in your AWS account access to the [PutRuntimeManagementConfig](#) API operation. This operation is used to choose the runtime update mode for a function. Denying access to this operation causes all functions to default to the **Auto** mode. You can apply this restriction across your organization by using a [service control policies \(SCP\)](#). If you must roll back a function to an earlier runtime version, you can grant a policy exception on a case-by-case basis.

Retrieve data about Lambda functions that use a deprecated runtime

When a Lambda runtime is approaching deprecation, Lambda alerts you through email and provides notifications in the AWS Health Dashboard and Trusted Advisor. These emails and notifications list the `$LATEST` versions of functions using the runtime. To list all of your function versions that use a particular runtime, you can use the AWS Command Line Interface (AWS CLI) or one of the AWS SDKs.

If you have a large number of functions which use a runtime that is due to be deprecated, you can also use the AWS CLI or AWS SDKs to help you prioritize updates to your most commonly invoked functions.

Refer to the following sections to learn how to use the AWS CLI and AWS SDKs to gather data about functions that use a particular runtime.

Listing function versions that use a particular runtime

To use the AWS CLI to list all of your function versions that use a particular runtime, run the following command. Replace `RUNTIME_IDENTIFIER` with the name of the runtime that's being deprecated and choose your own AWS Region. To list only `$LATEST` function versions, omit `--function-version ALL` from the command.

```
aws lambda list-functions --function-version ALL --region us-east-1 --output text --query "Functions[?Runtime=='RUNTIME_IDENTIFIER'].FunctionArn"
```

Tip

The example command lists functions in the `us-east-1` region for a particular AWS account. You'll need to repeat this command for each region in which your account has functions and for each of your AWS accounts.

You can also list functions that use a particular runtime using one of the AWS SDKs. The following example code uses the V3 AWS SDK for JavaScript and the AWS SDK for Python (Boto3) to return a list of the function ARNs for functions using a particular runtime. The example code also returns the CloudWatch log group for each of the listed functions. You can use this log group to find the

last invocation date for the function. See the following section [the section called "Identifying most commonly and most recently invoked functions"](#) for more information.

Node.js

Example JavaScript code to list functions using a particular runtime

```
import { LambdaClient, ListFunctionsCommand } from "@aws-sdk/client-lambda";
const lambdaClient = new LambdaClient();

const command = new ListFunctionsCommand({
  FunctionVersion: "ALL",
  MaxItems: 50
});
const response = await lambdaClient.send(command);

for (const f of response.Functions){
  if (f.Runtime == '<your_runtime>'){ // Use the runtime id, e.g. 'nodejs18.x' or
  'python3.9'
    console.log(f.FunctionArn);
    // get the CloudWatch log group of the function to
    // use later for finding the last invocation date
    console.log(f.LoggingConfig.LogGroup);
  }
}
// If your account has more functions than the specified
// MaxItems, use the returned pagination token in the
// next request with the 'Marker' parameter
if ('NextMarker' in response){
  let paginationToken = response.NextMarker;
}
```

Python

Example Python code to list functions using a particular runtime

```
import boto3
from botocore.exceptions import ClientError

def list_lambda_functions(target_runtime):

    lambda_client = boto3.client('lambda')
```

```
response = lambda_client.list_functions(
    FunctionVersion='ALL',
    MaxItems=50
)
if not response['Functions']:
    print("No Lambda functions found")
else:
    for function in response['Functions']:
        if function['PackageType']=='Zip' and function['Runtime'] ==
target_runtime:
            print(function['FunctionArn'])
            # Print the CloudWatch log group of the function
            # to use later for finding last invocation date
            print(function['LoggingConfig']['LogGroup'])

    if 'NextMarker' in response:
        pagination_token = response['NextMarker']

if __name__ == "__main__":
    # Replace python3.12 with the appropriate runtime ID for your Lambda functions
    list_lambda_functions('python3.12')
```

To learn more about using an AWS SDK to list your functions using the [ListFunctions](#) action, see the [SDK documentation](#) for your preferred programming language.

You can also use the AWS Config Advanced queries feature to list all your functions that use an affected runtime. This query only returns function \$LATEST versions, but you can aggregate queries to list function across all regions and multiple AWS accounts with a single command. To learn more, see [Querying the Current Configuration State of AWS Auto Scaling Resources](#) in the *AWS Config Developer Guide*.

Identifying most commonly and most recently invoked functions

If your AWS account contains functions that use a runtime that's due to be deprecated, you might want to prioritize updating functions that are frequently invoked or functions that have been invoked recently.

If you have only a few functions, you can use the CloudWatch Logs console to gather this information by looking at your functions' log streams. See [View log data sent to CloudWatch Logs](#) for more information.

To see the number of recent function invocations, you can also use the CloudWatch metrics information shown in the Lambda console. To view this information, do the following:

1. Open the [Functions page](#) of the Lambda console.
2. Select the function you want to see invocation statistics for.
3. Choose the **Monitor** tab.
4. Set the time period you wish to view statistics for using the date range picker. Recent invocations are displayed in the **Invocations** pane.

For accounts with larger numbers of functions, it can be more efficient to gather this data programmatically using the AWS CLI or one of the AWS SDKs using the [DescribeLogStreams](#) and [GetMetricStatistics](#) API actions.

The following examples provide code snippets using the V3 AWS SDK for JavaScript and the AWS SDK for Python (Boto3) to identify the last invoke date for a particular function and to determine the number of invocations for a particular function in the last 14 days.

Node.js

Example JavaScript code to find last invocation time for a function

```
import { CloudWatchLogsClient, DescribeLogStreamsCommand } from "@aws-sdk/client-cloudwatch-logs";
const cloudWatchLogsClient = new CloudWatchLogsClient();
const command = new DescribeLogStreamsCommand({
  logGroupName: '<your_log_group_name>',
  orderBy: 'LastEventTime',
  descending: true,
  limit: 1
});
try {
  const response = await cloudWatchLogsClient.send(command);
  const lastEventTimestamp = response.logStreams.length > 0 ?
    response.logStreams[0].lastEventTimestamp : null;
  // Convert the UNIX timestamp to a human-readable format for display
  const date = new Date(lastEventTimestamp).toLocaleDateString();
  const time = new Date(lastEventTimestamp).toLocaleTimeString();
  console.log(`${date} ${time}`);
} catch (e){
  console.error('Log group not found.')
```

```
}
```

Python

Example Python code to find last invocation time for a function

```
import boto3
from datetime import datetime

cloudwatch_logs_client = boto3.client('logs')

response = cloudwatch_logs_client.describe_log_streams(
    logGroupName='<your_log_group_name>',
    orderBy='LastEventTime',
    descending=True,
    limit=1
)

try:
    if len(response['logStreams']) > 0:
        last_event_timestamp = response['logStreams'][0]['lastEventTimestamp']
        print(datetime.fromtimestamp(last_event_timestamp/1000)) # Convert timestamp
        from ms to seconds
    else:
        last_event_timestamp = None
except:
    print('Log group not found')
```

Tip

You can find your function's log group name using the [ListFunctions](#) API operation. See the code in [the section called "Listing function versions that use a particular runtime"](#) for an example of how to do this.

Node.js

Example JavaScript code to find number of invocations in last 14 days

```
import { CloudWatchClient, GetMetricStatisticsCommand } from "@aws-sdk/client-cloudwatch";
```

```

const cloudWatchClient = new CloudWatchClient();
const command = new GetMetricStatisticsCommand({
  Namespace: 'AWS/Lambda',
  MetricName: 'Invocations',
  StartTime: new Date(Date.now()-86400*1000*14), // 14 days ago
  EndTime: new Date(Date.now()),
  Period: 86400 * 14, // 14 days.
  Statistics: ['Sum'],
  Dimensions: [{
    Name: 'FunctionName',
    Value: '<your_function_name>'
  }]
});
const response = await cloudWatchClient.send(command);
const invokesInLast14Days = response.Datapoints.length > 0 ?
  response.Datapoints[0].Sum : 0;

console.log('Number of invocations: ' + invokesInLast14Days);

```

Python

Example Python code to find number of invocations in last 14 days

```

import boto3
from datetime import datetime, timedelta

cloudwatch_client = boto3.client('cloudwatch')

response = cloudwatch_client.get_metric_statistics(
    Namespace='AWS/Lambda',
    MetricName='Invocations',
    Dimensions=[
        {
            'Name': 'FunctionName',
            'Value': '<your_function_name>'
        },
    ],
    StartTime=datetime.now() - timedelta(days=14),
    EndTime=datetime.now(),
    Period=86400 * 14, # 14 days
    Statistics=[
        'Sum'
    ]
)

```



```
)  
  
if len(response['Datapoints']) > 0:  
    invokes_in_last_14_days = int(response['Datapoints'][0]['Sum'])  
else:  
    invokes_in_last_14_days = 0  
  
print(f'Number of invocations: {invokes_in_last_14_days}')
```

Modifying the runtime environment

You can use [internal extensions](#) to modify the runtime process. Internal extensions are not separate processes—they run as part of the runtime process.

Lambda provides language-specific [environment variables](#) that you can set to add options and tools to the runtime. Lambda also provides [wrapper scripts](#), which allow Lambda to delegate the runtime startup to your script. You can create a wrapper script to customize the runtime startup behavior.

Language-specific environment variables

Lambda supports configuration-only ways to enable code to be pre-loaded during function initialization through the following language-specific environment variables:

- `JAVA_TOOL_OPTIONS` – On Java, Lambda supports this environment variable to set additional command-line variables in Lambda. This environment variable allows you to specify the initialization of tools, specifically the launching of native or Java programming language agents using the `agentlib` or `javaagent` options. For more information, see [JAVA_TOOL_OPTIONS environment variable](#).
- `NODE_OPTIONS` – Available in [Node.js runtimes](#).
- `DOTNET_STARTUP_HOOKS` – On .NET Core 3.1 and above, this environment variable specifies a path to an assembly (dll) that Lambda can use.

Using language-specific environment variables is the preferred way to set startup properties.

Wrapper scripts

You can create a *wrapper script* to customize the runtime startup behavior of your Lambda function. A wrapper script enables you to set configuration parameters that cannot be set through language-specific environment variables.

Note

Invocations may fail if the wrapper script does not successfully start the runtime process.

Wrapper scripts are supported on all native [Lambda runtimes](#). Wrapper scripts are not supported on [OS-only runtimes](#) (the provided runtime family).

When you use a wrapper script for your function, Lambda starts the runtime using your script. Lambda sends to your script the path to the interpreter and all of the original arguments for the standard runtime startup. Your script can extend or transform the startup behavior of the program. For example, the script can inject and alter arguments, set environment variables, or capture metrics, errors, and other diagnostic information.

You specify the script by setting the value of the `AWS_LAMBDA_EXEC_WRAPPER` environment variable as the file system path of an executable binary or script.

Example: Create and use a wrapper script as a Lambda layer

In the following example, you create a wrapper script to start the Python interpreter with the `-X importtime` option. When you run the function, Lambda generates a log entry to show the duration of the import time for each import.

To create and use a wrapper script as a layer

1. Create a directory for the layer:

```
mkdir -p python-wrapper-layer/bin
cd python-wrapper-layer/bin
```

2. In the `bin` directory, paste the following code into a new file named `importtime_wrapper`. This is the wrapper script.

```
#!/bin/bash

# the path to the interpreter and all of the originally intended arguments
args=("$@")

# the extra options to pass to the interpreter
extra_args=(-X "importtime")

# insert the extra options
args=("${args[@]:0:$#-1}" "${extra_args[@]}" "${args[@]: -1}")

# start the runtime with the extra options
exec "${args[@]}"
```

3. Give the script executable permissions:

```
chmod +x importtime_wrapper
```

4. Create a .zip file for the layer:

```
cd ..  
zip -r ../python-wrapper-layer.zip .
```

5. Confirm that your .zip file has the following directory structure:

```
python-wrapper-layer.zip  
# bin  
  # importtime_wrapper
```

6. [Create a layer](#) using the .zip package.

7. Create a function using the Lambda console.

- a. Open the [Lambda console](#).
- b. Choose **Create function**.
- c. Enter a **Function name**.
- d. For **Runtime**, choose the **Latest supported** Python runtime.
- e. Choose **Create function**.

8. Add the layer to your function.

- a. Choose your function, and then choose the **Code** tab if it's not already selected.
- b. Scroll down to the **Layers** section, and then choose **Add a layer**.
- c. For **Layer source**, select **Custom layers**, and then choose your layer from the **Custom layers** dropdown list.
- d. For **Version**, choose **1**.
- e. Choose **Add**.

9. Add the wrapper environment variable.

- a. Choose the **Configuration** tab, then choose **Environment variables**.
- b. Under **Environment variables**, choose **Edit**.
- c. Choose **Add environment variable**.
- d. For **Key**, enter `AWS_LAMBDA_EXEC_WRAPPER`.

- e. For **Value**, enter `/opt/bin/importtime_wrapper` (`/opt/` + your `.zip` layer's folder structure).
 - f. Choose **Save**.
10. Test the wrapper script.
- a. Choose the **Test** tab.
 - b. Under **Test event**, choose **Test**. You don't need to create a test event—the default event will work.
 - c. Scroll down to **Log output**. Because your wrapper script started the Python interpreter with the `-X importtime` option, the logs show the time required for each import. For example:

```
532 |          collections
import time:      63 |          63 |          _functools
import time:    1053 |         3646 |          functools
import time:    2163 |         7499 |          enum
import time:     100 |          100 |          _sre
import time:     446 |          446 |          re._constants
import time:     691 |         1136 |          re._parser
import time:     378 |          378 |          re._casefix
import time:     670 |         2283 |          re._compiler
import time:     416 |          416 |          copyreg
```

Using the Lambda runtime API for custom runtimes

AWS Lambda provides an HTTP API for [custom runtimes](#) to receive invocation events from Lambda and send response data back within the Lambda [execution environment](#). This section contains the API reference for the Lambda runtime API.

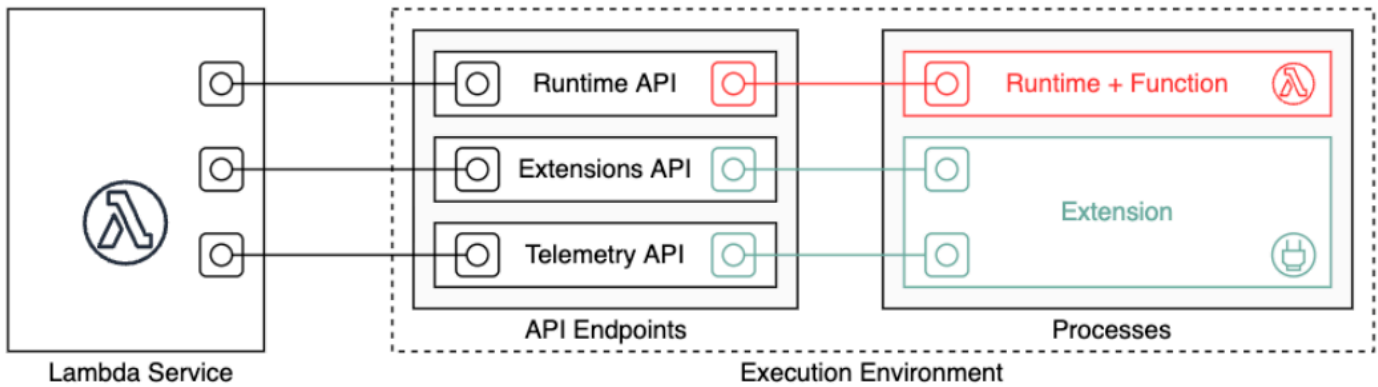

The OpenAPI specification for the runtime API version **2018-06-01** is available in [runtime-api.zip](#)

To create an API request URL, runtimes get the API endpoint from the `AWS_LAMBDA_RUNTIME_API` environment variable, add the API version, and add the desired resource path.

Example Request

```
curl "http://${AWS_LAMBDA_RUNTIME_API}/2018-06-01/runtime/invocation/next"
```

API methods

- [Next invocation](#)
- [Invocation response](#)
- [Initialization error](#)
- [Invocation error](#)

Next invocation

Path – `/runtime/invocation/next`

Method – `GET`

The runtime sends this message to Lambda to request an invocation event. The response body contains the payload from the invocation, which is a JSON document that contains event data from the function trigger. The response headers contain additional data about the invocation.

Response headers

- `Lambda-Runtime-Aws-Request-Id` – The request ID, which identifies the request that triggered the function invocation.

For example, `8476a536-e9f4-11e8-9739-2dfe598c3fcd`.

- `Lambda-Runtime-Deadline-Ms` – The date that the function times out in Unix time milliseconds.

For example, `1542409706888`.

- `Lambda-Runtime-Invoked-Function-Arn` – The ARN of the Lambda function, version, or alias that's specified in the invocation.

For example, `arn:aws:lambda:us-east-2:123456789012:function:custom-runtime`.

- `Lambda-Runtime-Trace-Id` – The [AWS X-Ray tracing header](#).

For example, `Root=1-5bef4de7-ad49b0e87f6ef6c87fc2e700;Parent=9a9197af755a6419;Sampled=1`.

- `Lambda-Runtime-Client-Context` – For invocations from the AWS Mobile SDK, data about the client application and device.
- `Lambda-Runtime-Cognito-Identity` – For invocations from the AWS Mobile SDK, data about the Amazon Cognito identity provider.

Do not set a timeout on the GET request as the response may be delayed. Between when Lambda bootstraps the runtime and when the runtime has an event to return, the runtime process may be frozen for several seconds.

The request ID tracks the invocation within Lambda. Use it to specify the invocation when you send the response.

The tracing header contains the trace ID, parent ID, and sampling decision. If the request is sampled, the request was sampled by Lambda or an upstream service. The runtime should set the `_X_AMZN_TRACE_ID` with the value of the header. The X-Ray SDK reads this to get the IDs and determine whether to trace the request.

Invocation response

Path – /runtime/invocation/*AwsRequestId*/response

Method – POST

After the function has run to completion, the runtime sends an invocation response to Lambda. For synchronous invocations, Lambda sends the response to the client.

Example success request

```
REQUEST_ID=156cb537-e2d4-11e8-9b34-d36013741fb9
curl "http://${AWS_LAMBDA_RUNTIME_API}/2018-06-01/runtime/invocation/$REQUEST_ID/
response" -d "SUCCESS"
```

Initialization error

If the function returns an error or the runtime encounters an error during initialization, the runtime uses this method to report the error to Lambda.

Path – /runtime/init/error

Method – POST

Headers

Lambda-Runtime-Function-Error-Type – Error type that the runtime encountered. Required: no.

This header consists of a string value. Lambda accepts any string, but we recommend a format of `<category.reason>`. For example:

- Runtime.NoSuchHandler
- Runtime.APIKeyNotFound
- Runtime.ConfigInvalid
- Runtime.UnknownReason

Body parameters

ErrorRequest – Information about the error. Required: no.

This field is a JSON object with the following structure:

```
{
  errorMessage: string (text description of the error),
  errorType: string,
  stackTrace: array of strings
}
```

Note that Lambda accepts any value for `errorType`.

The following example shows a Lambda function error message in which the function could not parse the event data provided in the invocation.

Example Function error

```
{
  "errorMessage" : "Error parsing event data.",
  "errorType" : "InvalidEventDataException",
  "stackTrace": [ ]
}
```

Response body parameters

- **StatusResponse** – String. Status information, sent with 202 response codes.
- **ErrorResponse** – Additional error information, sent with the error response codes. **ErrorResponse** contains an error type and an error message.

Response codes

- 202 – Accepted
- 403 – Forbidden
- 500 – Container error. Non-recoverable state. Runtime should exit promptly.

Example initialization error request

```
ERROR="{\"errorMessage\" : \"Failed to load function.\", \"errorType\" :  
  \"InvalidFunctionException\"}"
```

```
curl "http://${AWS_LAMBDA_RUNTIME_API}/2018-06-01/runtime/init/error" -d "$ERROR" --  
header "Lambda-Runtime-Function-Error-Type: Unhandled"
```

Invocation error

If the function returns an error or the runtime encounters an error, the runtime uses this method to report the error to Lambda.

Path – `/runtime/invoke/AwsRequestId/error`

Method – **POST**

Headers

Lambda-Runtime-Function-Error-Type – Error type that the runtime encountered. Required: no.

This header consists of a string value. Lambda accepts any string, but we recommend a format of `<category.reason>`. For example:

- `Runtime.NoSuchHandler`
- `Runtime.APIKeyNotFound`
- `Runtime.ConfigInvalid`
- `Runtime.UnknownReason`

Body parameters

ErrorRequest – Information about the error. Required: no.

This field is a JSON object with the following structure:

```
{  
  errorMessage: string (text description of the error),  
  errorType: string,  
  stackTrace: array of strings  
}
```

Note that Lambda accepts any value for `errorType`.

The following example shows a Lambda function error message in which the function could not parse the event data provided in the invocation.

Example Function error

```
{
  "errorMessage" : "Error parsing event data.",
  "errorType" : "InvalidEventDataException",
  "stackTrace": [ ]
}
```

Response body parameters

- `StatusResponse` – String. Status information, sent with 202 response codes.
- `ErrorResponse` – Additional error information, sent with the error response codes. `ErrorResponse` contains an error type and an error message.

Response codes

- 202 – Accepted
- 400 – Bad Request
- 403 – Forbidden
- 500 – Container error. Non-recoverable state. Runtime should exit promptly.

Example error request

```
REQUEST_ID=156cb537-e2d4-11e8-9b34-d36013741fb9
ERROR="{\"errorMessage\" : \"Error parsing event data.\", \"errorType\" :
  \"InvalidEventDataException\"}"
curl "http://${AWS_LAMBDA_RUNTIME_API}/2018-06-01/runtime/invocation/$REQUEST_ID/error"
-d "$ERROR" --header "Lambda-Runtime-Function-Error-Type: Unhandled"
```

When to use Lambda's OS-only runtimes

Lambda provides [managed runtimes](#) for Java, Python, Node.js, .NET, and Ruby. To create Lambda functions in a programming language that is not available as a managed runtime, use an OS-only runtime (the provided runtime family). There are three primary use cases for OS-only runtimes:

- **Native ahead-of-time (AOT) compilation:** Languages such as Go, Rust, and C++ compile natively to an executable binary, which doesn't require a dedicated language runtime. These languages only need an OS environment in which the compiled binary can run. You can also use Lambda OS-only runtimes to deploy binaries compiled with .NET Native AOT and Java GraalVM Native.

You must include a runtime interface client in your binary. The runtime interface client calls the [Using the Lambda runtime API for custom runtimes](#) to retrieve function invocations and then calls your function handler. Lambda provides runtime interface clients for [Go](#), [.NET Native AOT](#), [C++](#), and [Rust](#) (experimental).

You must compile your binary for a Linux environment and for the same instruction set architecture that you plan to use for the function (x86_64 or arm64).

- **Third-party runtimes:** You can run Lambda functions using off-the-shelf runtimes such as [Bref](#) for PHP or the [Swift AWS Lambda Runtime](#) for Swift.
- **Custom runtimes:** You can build your own runtime for a language or language version that Lambda doesn't provide a managed runtime for, such as Node.js 19. For more information, see [Building a custom runtime for AWS Lambda](#). This is the least common use case for OS-only runtimes.

Lambda supports the following OS-only runtimes:

Name	Identifier	Operating system	Deprecation date	Block function create	Block function update
OS-only Runtime	provided.a12023	Amazon Linux 2023	Not scheduled	Not scheduled	Not scheduled
OS-only Runtime	provided.a12	Amazon Linux 2	Not scheduled	Not scheduled	Not scheduled

The Amazon Linux 2023 (provided.al2023) runtime provides several advantages over Amazon Linux 2, including a smaller deployment footprint and updated versions of libraries such as glibc.

The provided.al2023 runtime uses dnf as the package manager instead of yum, which is the default package manager in Amazon Linux 2. For more information about the differences between provided.al2023 and provided.al2, see [Introducing the Amazon Linux 2023 runtime for AWS Lambda](#) on the AWS Compute Blog.

Building a custom runtime for AWS Lambda

You can implement an AWS Lambda runtime in any programming language. A runtime is a program that runs a Lambda function's handler method when the function is invoked. You can include the runtime in your function's deployment package or distribute it in a [layer](#). When you create the Lambda function, choose an [OS-only runtime](#) (the provided runtime family).

Note

Creating a custom runtime is an advanced use case. If you're looking for information about compiling to a native binary or using a third-party off-the-shelf runtime, see [When to use Lambda's OS-only runtimes](#).

For a walkthrough of the custom runtime deployment process, see [Tutorial: Building a custom runtime](#). You can also explore a custom runtime implemented in C++ at [awslabs/aws-lambda-cpp](#) on GitHub.

Topics

- [Requirements](#)
- [Implementing response streaming in a custom runtime](#)

Requirements

Custom runtimes must complete certain initialization and processing tasks. A runtime runs the function's setup code, reads the handler name from an environment variable, and reads invocation events from the Lambda runtime API. The runtime passes the event data to the function handler, and posts the response from the handler back to Lambda.

Initialization tasks

The initialization tasks run once [per instance of the function](#) to prepare the environment to handle invocations.

- **Retrieve settings** – Read environment variables to get details about the function and environment.
 - `_HANDLER` – The location to the handler, from the function's configuration. The standard format is *file.method*, where *file* is the name of the file without an extension, and *method* is the name of a method or function that's defined in the file.
 - `LAMBDA_TASK_ROOT` – The directory that contains the function code.
 - `AWS_LAMBDA_RUNTIME_API` – The host and port of the runtime API.

For a full list of available variables, see [Defined runtime environment variables](#).

- **Initialize the function** – Load the handler file and run any global or static code that it contains. Functions should create static resources like SDK clients and database connections once, and reuse them for multiple invocations.
- **Handle errors** – If an error occurs, call the [initialization error](#) API and exit immediately.

Initialization counts towards billed execution time and timeout. When an execution triggers the initialization of a new instance of your function, you can see the initialization time in the logs and [AWS X-Ray trace](#).

Example log

```
REPORT RequestId: f8ac1208... Init Duration: 48.26 ms   Duration: 237.17 ms   Billed
Duration: 300 ms   Memory Size: 128 MB   Max Memory Used: 26 MB
```

Processing tasks

While it runs, a runtime uses the [Lambda runtime interface](#) to manage incoming events and report errors. After completing initialization tasks, the runtime processes incoming events in a loop. In your runtime code, perform the following steps in order.

- **Get an event** – Call the [next invocation](#) API to get the next event. The response body contains the event data. Response headers contain the request ID and other information.

- **Propagate the tracing header** – Get the X-Ray tracing header from the `Lambda-Runtime-Trace-Id` header in the API response. Set the `_X_AMZN_TRACE_ID` environment variable locally with the same value. The X-Ray SDK uses this value to connect trace data between services.
- **Create a context object** – Create an object with context information from environment variables and headers in the API response.
- **Invoke the function handler** – Pass the event and context object to the handler.
- **Handle the response** – Call the [invocation response](#) API to post the response from the handler.
- **Handle errors** – If an error occurs, call the [invocation error](#) API.
- **Cleanup** – Release unused resources, send data to other services, or perform additional tasks before getting the next event.

Entrypoint

A custom runtime's entry point is an executable file named `bootstrap`. The `bootstrap` file can be the runtime, or it can invoke another file that creates the runtime. If the root of your deployment package doesn't contain a file named `bootstrap`, Lambda looks for the file in the function's layers. If the `bootstrap` file doesn't exist or isn't executable, your function returns a `Runtime.InvalidEntrypoint` error upon invocation.

Here's an example `bootstrap` file that uses a bundled version of Node.js to run a JavaScript runtime in a separate file named `runtime.js`.

Example bootstrap

```
#!/bin/sh
cd $LAMBDA_TASK_ROOT
./node-v11.1.0-linux-x64/bin/node runtime.js
```

Implementing response streaming in a custom runtime

For [response streaming functions](#), the response and error endpoints have slightly modified behavior that lets the runtime stream partial responses to the client and return payloads in chunks. For more information about the specific behavior, see the following:

- `/runtime/invocation/AwsRequestId/response` – Propagates the `Content-Type` header from the runtime to send to the client. Lambda returns the response payload in chunks via

HTTP/1.1 chunked transfer encoding. The response stream can be a maximum size of 20 MiB. To stream the response to Lambda, the runtime must:

- Set the `Lambda-Runtime-Function-Response-Mode` HTTP header to `streaming`.
- Set the `Transfer-Encoding` header to `chunked`.
- Write the response conforming to the HTTP/1.1 chunked transfer encoding specification.
- Close the underlying connection after it has successfully written the response.
- `/runtime/invocation/AwsRequestId/error` – The runtime can use this endpoint to report function or runtime errors to Lambda, which also accepts the `Transfer-Encoding` header. This endpoint can only be called before the runtime begins sending an invocation response.
- Report midstream errors using error trailers in `/runtime/invocation/AwsRequestId/` response – To report errors that occur after the runtime starts writing the invocation response, the runtime can optionally attach HTTP trailing headers named `Lambda-Runtime-Function-Error-Type` and `Lambda-Runtime-Function-Error-Body`. Lambda treats this as a successful response and forwards the error metadata that the runtime provides to the client.

Note

To attach trailing headers, the runtime must set the `Trailer` header value at the beginning of the HTTP request. This is a requirement of the HTTP/1.1 chunked transfer encoding specification.

- `Lambda-Runtime-Function-Error-Type` – The error type that the runtime encountered. This header consists of a string value. Lambda accepts any string, but we recommend a format of `<category.reason>`. For example, `Runtime.APIKeyNotFound`.
- `Lambda-Runtime-Function-Error-Body` – Base64-encoded information about the error.

Tutorial: Building a custom runtime

In this tutorial, you create a Lambda function with a custom runtime. You start by including the runtime in the function's deployment package. Then you migrate it to a layer that you manage independently from the function. Finally, you share the runtime layer with the world by updating its resource-based permissions policy.

Prerequisites

This tutorial assumes that you have some knowledge of basic Lambda operations and the Lambda console. If you haven't already, follow the instructions in [Create a Lambda function with the console](#) to create your first Lambda function.

To complete the following steps, you need the [AWS CLI version 2](#). Commands and the expected output are listed in separate blocks:

```
aws --version
```

You should see the following output:

```
aws-cli/2.13.27 Python/3.11.6 Linux/4.14.328-248.540.amzn2.x86_64 exe/x86_64.amzn.2
```

For long commands, an escape character (\) is used to split a command over multiple lines.

On Linux and macOS, use your preferred shell and package manager.

Note

In Windows, some Bash CLI commands that you commonly use with Lambda (such as `zip`) are not supported by the operating system's built-in terminals. To get a Windows-integrated version of Ubuntu and Bash, [install the Windows Subsystem for Linux](#). Example CLI commands in this guide use Linux formatting. Commands which include inline JSON documents must be reformatted if you are using the Windows CLI.

You need an IAM role to create a Lambda function. The role needs permission to send logs to CloudWatch Logs and access the AWS services that your function uses. If you don't have a role for function development, create one now.

To create an execution role

1. Open the [roles page](#) in the IAM console.
2. Choose **Create role**.
3. Create a role with the following properties.
 - **Trusted entity – Lambda**.

- **Permissions – `AWSLambdaBasicExecutionRole`.**
- **Role name – `lambda-role`.**

The `AWSLambdaBasicExecutionRole` policy has the permissions that the function needs to write logs to CloudWatch Logs.

Create a function

Create a Lambda function with a custom runtime. This example includes two files: a runtime bootstrap file and a function handler. Both are implemented in Bash.

1. Create a directory for the project, and then switch to that directory.

```
mkdir runtime-tutorial
cd runtime-tutorial
```

2. Create a new file called `bootstrap`. This is the custom runtime.

Example bootstrap

```
#!/bin/sh

set -euo pipefail

# Initialization - load function handler
source $LAMBDA_TASK_ROOT/"$(echo $_HANDLER | cut -d. -f1).sh"

# Processing
while true
do
    HEADERS="$(mktemp)"
    # Get an event. The HTTP request will block until one is received
    EVENT_DATA=$(curl -s -LD "$HEADERS" "http://
${AWS_LAMBDA_RUNTIME_API}/2018-06-01/runtime/invocation/next")

    # Extract request ID by scraping response headers received above
    REQUEST_ID=$(grep -Fi Lambda-Request-Id "$HEADERS" | tr -d
'[:space:]' | cut -d: -f2)

    # Run the handler function from the script
```

```

RESPONSE=$(($(echo "$_HANDLER" | cut -d. -f2) "$EVENT_DATA"))

# Send the response
curl "http://${AWS_LAMBDA_RUNTIME_API}/2018-06-01/runtime/invocation/$REQUEST_ID/
response" -d "$RESPONSE"
done

```

The runtime loads a function script from the deployment package. It uses two variables to locate the script. `LAMBDA_TASK_ROOT` tells it where the package was extracted, and `_HANDLER` includes the name of the script.

After the runtime loads the function script, it uses the runtime API to retrieve an invocation event from Lambda, passes the event to the handler, and posts the response back to Lambda. To get the request ID, the runtime saves the headers from the API response to a temporary file, and reads the `Lambda-RunTime-Aws-Request-Id` header from the file.

Note

Runtimes have additional responsibilities, including error handling, and providing context information to the handler. For details, see [Requirements](#).

3. Create a script for the function. The following example script defines a handler function that takes event data, logs it to `stderr`, and returns it.

Example `function.sh`

```

function handler () {
    EVENT_DATA=$1
    echo "$EVENT_DATA" 1>&2;
    RESPONSE="Echoing request: '$EVENT_DATA'"

    echo $RESPONSE
}

```

The `runtime-tutorial` directory should now look like this:

```

runtime-tutorial
# bootstrap
# function.sh

```

4. Make the files executable and add them to a .zip file archive. This is the deployment package.

```
chmod 755 function.sh bootstrap
zip function.zip function.sh bootstrap
```

5. Create a function named bash-runtime. For --role, enter the ARN of your Lambda [execution role](#).

```
aws lambda create-function --function-name bash-runtime \
--zip-file fileb://function.zip --handler function.handler --runtime
provided.al2023 \
--role arn:aws:iam::123456789012:role/lambda-role
```

6. Invoke the function.

```
aws lambda invoke --function-name bash-runtime --payload '{"text":"Hello"}'
response.txt --cli-binary-format raw-in-base64-out
```

The **cli-binary-format** option is required if you're using AWS CLI version 2. To make this the default setting, run `aws configure set cli-binary-format raw-in-base64-out`. For more information, see [AWS CLI supported global command line options](#) in the *AWS Command Line Interface User Guide for Version 2*.

You should see a response like this:

```
{
  "StatusCode": 200,
  "ExecutedVersion": "$LATEST"
}
```

7. Verify the response.

```
cat response.txt
```

You should see a response like this:

```
Echoing request: '{"text":"Hello"}'
```

Create a layer

To separate the runtime code from the function code, create a layer that only contains the runtime. Layers let you develop your function's dependencies independently, and can reduce storage usage when you use the same layer with multiple functions. For more information, see [Managing Lambda dependencies with layers](#).

1. Create a .zip file that contains the bootstrap file.

```
zip runtime.zip bootstrap
```

2. Create a layer with the [publish-layer-version](#) command.

```
aws lambda publish-layer-version --layer-name bash-runtime --zip-file fileb://runtime.zip
```

This creates the first version of the layer.

Update the function

To use the runtime layer in the function, configure the function to use the layer, and remove the runtime code from the function.

1. Update the function configuration to pull in the layer.

```
aws lambda update-function-configuration --function-name bash-runtime \
--layers arn:aws:lambda:us-east-1:123456789012:layer:bash-runtime:1
```

This adds the runtime to the function in the /opt directory. To ensure that Lambda uses the runtime in the layer, you must remove the bootstrap from the function's deployment package, as shown in the next two steps.

2. Create a .zip file that contains the function code.

```
zip function-only.zip function.sh
```

3. Update the function code to only include the handler script.

```
aws lambda update-function-code --function-name bash-runtime --zip-file fileb://  
function-only.zip
```

4. Invoke the function to confirm that it works with the runtime layer.

```
aws lambda invoke --function-name bash-runtime --payload '{"text":"Hello"}'  
response.txt --cli-binary-format raw-in-base64-out
```

The **cli-binary-format** option is required if you're using AWS CLI version 2. To make this the default setting, run `aws configure set cli-binary-format raw-in-base64-out`. For more information, see [AWS CLI supported global command line options](#) in the *AWS Command Line Interface User Guide for Version 2*.

You should see a response like this:

```
{  
  "StatusCode": 200,  
  "ExecutedVersion": "$LATEST"  
}
```

5. Verify the response.

```
cat response.txt
```

You should see a response like this:

```
Echoing request: '{"text":"Hello"}'
```

Update the runtime

1. To log information about the execution environment, update the runtime script to output environment variables.

Example bootstrap

```
#!/bin/sh  
  
set -euo pipefail
```

```

# Configure runtime to output environment variables
echo "## Environment variables:"
env

# Load function handler
source $LAMBDA_TASK_ROOT/"$(echo $_HANDLER | cut -d. -f1).sh"

# Processing
while true
do
  HEADERS="$(mktemp)"
  # Get an event. The HTTP request will block until one is received
  EVENT_DATA=$(curl -sS -LD "$HEADERS" "http://
${AWS_LAMBDA_RUNTIME_API}/2018-06-01/runtime/invocation/next")

  # Extract request ID by scraping response headers received above
  REQUEST_ID=$(grep -Fi Lambda-Request-Id "$HEADERS" | tr -d
'[:space:]' | cut -d: -f2)

  # Run the handler function from the script
  RESPONSE=$(echo "$_HANDLER" | cut -d. -f2) "$EVENT_DATA")

  # Send the response
  curl "http://${AWS_LAMBDA_RUNTIME_API}/2018-06-01/runtime/invocation/$REQUEST_ID/
response" -d "$RESPONSE"
done

```

2. Create a .zip file that contains the new version of the bootstrap file.

```
zip runtime.zip bootstrap
```

3. Create a new version of the bash-runtime layer.

```
aws lambda publish-layer-version --layer-name bash-runtime --zip-file fileb://
runtime.zip
```

4. Configure the function to use the new version of the layer.

```
aws lambda update-function-configuration --function-name bash-runtime \
--layers arn:aws:lambda:us-east-1:123456789012:layer:bash-runtime:2
```

Share the layer

To share a layer with another AWS account, add a cross-account permissions statement to the layer's [resource-based policy](#). Run the [add-layer-version-permission](#) command and specify the account ID as the `principal`. In each statement, you can grant permission to a single account, all accounts, or an organization in [AWS Organizations](#).

The following example grants account 111122223333 access to version 2 of the `bash-runtime` layer.

```
aws lambda add-layer-version-permission \  
  --layer-name bash-runtime \  
  --version-number 2 \  
  --statement-id xaccount \  
  --action lambda:GetLayerVersion \  
  --principal 111122223333 \  
  --output text
```

You should see output similar to the following:

```
{"Sid":"xaccount","Effect":"Allow","Principal":  
{"AWS":"arn:aws:iam::111122223333:root"},"Action":"lambda:GetLayerVersion","Resource":"arn:aws:  
east-1:123456789012:layer:bash-runtime:2"}
```

Permissions apply only to a single layer version. Repeat the process each time that you create a new layer version.

Clean up

Delete each version of the layer.

```
aws lambda delete-layer-version --layer-name bash-runtime --version-number 1  
aws lambda delete-layer-version --layer-name bash-runtime --version-number 2
```

Because the function holds a reference to version 2 of the layer, it still exists in Lambda. The function continues to work, but functions can no longer be configured to use the deleted version. If you modify the list of layers on the function, you must specify a new version or omit the deleted layer.

Delete the function with the [delete-function](#) command.

```
aws lambda delete-function --function-name bash-runtime
```

Configuring AWS Lambda functions

Learn how to configure the core capabilities and options for your Lambda function using the Lambda API or console.

[Memory](#)

Learn how and when to increase function memory.

[Ephemeral storage](#)

Learn how and when to increase your function's temporary storage capacity.

[Timeout](#)

Learn how and when to increase your function's timeout value.

[Environment variables](#)

You can make your function code portable and keep secrets out of your code by storing them in your function's configuration by using environment variables.

[Outbound networking](#)

You can use your Lambda function with AWS resources in an Amazon VPC. Connecting your function to a VPC lets you access resources in a private subnet such as relational databases and caches.

[Inbound networking](#)

You can use an interface VPC endpoint to invoke your Lambda functions without crossing the public internet.

[File system](#)

You can use your Lambda function to mount a Amazon EFS to a local directory. A file system allows your function code to access and modify shared resources safely and at high concurrency.

[Aliases](#)

You can configure your clients to invoke a specific Lambda function version by using an alias, instead of updating the client.

[Versions](#)

By publishing a version of your function, you can store your code and configuration as a separate resource that cannot be changed.

Tags

Use tags to enable attribute-based access control (ABAC), to organize your Lambda functions, and to filter and generate reports on your functions using the AWS Cost Explorer or AWS Billing and Cost Management services.

Response streaming

You can configure your Lambda function URLs to stream response payloads back to clients. Response streaming can benefit latency sensitive applications by improving time to first byte (TTFB) performance. This is because you can send partial responses back to the client as they become available. Additionally, you can use response streaming to build functions that return larger payloads.

Deploying Lambda functions as .zip file archives

When you create a Lambda function, you package your function code into a deployment package. Lambda supports two types of deployment packages: container images and .zip file archives. The workflow to create a function depends on the deployment package type. To configure a function defined as a container image, see [the section called “Container images”](#).

You can use the Lambda console and the Lambda API to create a function defined with a .zip file archive. You can also upload an updated .zip file to change the function code.

Note

You cannot change the [deployment package type](#) (.zip or container image) for an existing function. For example, you cannot convert a container image function to use a .zip file archive. You must create a new function.

Topics

- [Creating the function](#)
- [Using the console code editor](#)
- [Updating function code](#)
- [Changing the runtime](#)
- [Changing the architecture](#)
- [Using the Lambda API](#)
- [Downloading your function code](#)
- [AWS CloudFormation](#)
- [Encrypting Lambda .zip deployment packages](#)

Creating the function

When you create a function defined with a .zip file archive, you choose a code template, the language version, and the execution role for the function. You add your function code after Lambda creates the function.

To create the function

1. Open the [Functions page](#) of the Lambda console.
2. Choose **Create function**.
3. Choose **Author from scratch** or **Use a blueprint** to create your function.
4. Under **Basic information**, do the following:
 - a. For **Function name**, enter the function name. Function names are limited to 64 characters in length.
 - b. For **Runtime**, choose the language version to use for your function.
 - c. (Optional) For **Architecture**, choose the instruction set architecture to use for your function. The default architecture is x86_64. When you build the deployment package for your function, make sure that it is compatible with this [instruction set architecture](#).
5. (Optional) Under **Permissions**, expand **Change default execution role**. You can create a new **Execution role** or use an existing role.
6. (Optional) Expand **Advanced settings**. You can choose a **Code signing configuration** for the function. You can also configure an (Amazon VPC) for the function to access.
7. Choose **Create function**.

Lambda creates the new function. You can now use the console to add the function code and configure other function parameters and features. For code deployment instructions, see the handler page for the runtime your function uses.

Node.js

[Deploy Node.js Lambda functions with .zip file archives](#)

Python

[Working with .zip file archives for Python Lambda functions](#)

Ruby

[Deploy Ruby Lambda functions with .zip file archives](#)

Java

[Deploy Java Lambda functions with .zip or JAR file archives](#)

Go

[Deploy Go Lambda functions with .zip file archives](#)

C#

[Build and deploy C# Lambda functions with .zip file archives](#)

PowerShell

[Deploy PowerShell Lambda functions with .zip file archives](#)

Using the console code editor

The console creates a Lambda function with a single source file. For scripting languages, you can edit this file and add more files using the built-in code editor. To save your changes, choose **Save**. Then, to run your code, choose **Test**.

When you save your function code, the Lambda console creates a .zip file archive deployment package. When you develop your function code outside of the console (using an IDE) you need to [create a deployment package](#) to upload your code to the Lambda function.

Updating function code

For scripting languages (Node.js, Python, and Ruby), you can edit your function code in the embedded code editor. If the code is larger than 3MB, or if you need to add libraries, or for languages that the editor doesn't support (Java, Go, C#), you must upload your function code as a .zip archive. If the .zip file archive is smaller than 50 MB, you can upload the .zip file archive from your local machine. If the file is larger than 50 MB, upload the file to the function from an Amazon S3 bucket.

To upload function code as a .zip archive

1. Open the [Functions page](#) of the Lambda console.
2. Choose the function to update and choose the **Code** tab.
3. Under **Code source**, choose **Upload from**.
4. Choose **.zip file**, and then choose **Upload**.
 - In the file chooser, select the new image version, choose **Open**, and then choose **Save**.

5. (Alternative to step 4) Choose **Amazon S3 location**.

- In the text box, enter the S3 link URL of the .zip file archive, then choose **Save**.

Changing the runtime

If you update the function configuration to use a new runtime, you may need to update the function code to be compatible with the new runtime. If you update the function configuration to use a different runtime, you **must** provide new function code that is compatible with the runtime and architecture. For instructions on how to create a deployment package for the function code, see the handler page for the runtime that the function uses.

The Node.js 20, Python 3.12, Java 21, .NET 8, Ruby 3.3, and later base images are based on the Amazon Linux 2023 minimal container image. Earlier base images use Amazon Linux 2. AL2023 provides several advantages over Amazon Linux 2, including a smaller deployment footprint and updated versions of libraries such as `glibc`. For more information, see [Introducing the Amazon Linux 2023 runtime for AWS Lambda](#) on the AWS Compute Blog.

To change the runtime

1. Open the [Functions page](#) of the Lambda console.
2. Choose the function to update and choose the **Code** tab.
3. Scroll down to the **Runtime settings** section, which is under the code editor.
4. Choose **Edit**.
 - a. For **Runtime**, select the runtime identifier.
 - b. For **Handler**, specify file name and handler for your function.
 - c. For **Architecture**, choose the instruction set architecture to use for your function.
5. Choose **Save**.

Changing the architecture

Before you can change the instruction set architecture, you need to ensure that your function's code is compatible with the target architecture.

If you use Node.js, Python, or Ruby and you edit your function code in the embedded editor, the existing code may run without modification.

However, if you provide your function code using a .zip file archive deployment package, you must prepare a new .zip file archive that is compiled and built correctly for the target runtime and instruction-set architecture. For instructions, see the handler page for your function runtime.

To change the instruction set architecture

1. Open the [Functions page](#) of the Lambda console.
2. Choose the function to update and choose the **Code** tab.
3. Under **Runtime settings**, choose **Edit**.
4. For **Architecture**, choose the instruction set architecture to use for your function.
5. Choose **Save**.

Using the Lambda API

To create and configure a function that uses a .zip file archive, use the following API operations:

- [CreateFunction](#)
- [UpdateFunctionCode](#)
- [UpdateFunctionConfiguration](#)

Downloading your function code

You can download the current unpublished (\$LATEST) version of your function code .zip via the Lambda console. To do this, first ensure that you have the following IAM permissions:

- iam:GetPolicy
- iam:GetPolicyVersion
- iam:GetRole
- iam:GetRolePolicy
- iam:ListAttachedRolePolicies
- iam:ListRolePolicies
- iam:ListRoles

To download the function code .zip

1. Open the [Functions page](#) of the Lambda console.
2. Choose the function you want to download the function code .zip for.
3. In the **Function overview**, choose the **Download** button, then choose **Download function code .zip**.
 - Alternatively, choose **Download AWS SAM file** to generate and download a SAM template based on your function's configuration. You can also choose **Download both** to download both the .zip and the SAM template.

AWS CloudFormation

You can use AWS CloudFormation to create a Lambda function that uses a .zip file archive. In your AWS CloudFormation template, the `AWS::Lambda::Function` resource specifies the Lambda function. For descriptions of the properties in the `AWS::Lambda::Function` resource, see [AWS::Lambda::Function](#) in the *AWS CloudFormation User Guide*.

In the `AWS::Lambda::Function` resource, set the following properties to create a function defined as a .zip file archive:

- `AWS::Lambda::Function`
 - `PackageType` – Set to `Zip`.
 - `Code` – Enter the Amazon S3 bucket name and .zip file name in the `S3Bucket` and `S3Key` fields. For Node.js or Python, you can provide inline source code of your Lambda function.
 - `Runtime` – Set the runtime value.
 - `Architecture` – Set the architecture value to `arm64` to use the AWS Graviton2 processor. By default, the architecture value is `x86_64`.

Encrypting Lambda .zip deployment packages

Lambda always provides server-side encryption at rest for .zip deployment packages and function configuration details with an AWS KMS key. By default, Lambda uses an [AWS owned key](#). If this default behavior suits your workflow, you don't need to set up anything else. AWS doesn't charge you to use this key.

If you prefer, you can provide an AWS KMS customer managed key instead. You might do this to have control over rotation of the KMS key or to meet the requirements of your organization for managing KMS keys. When you use a customer managed key, only users in your account with access to the KMS key can view or manage the function's code or configuration.

Customer managed keys incur standard AWS KMS charges. For more information, see [AWS Key Management Service pricing](#).

Create a customer managed key

You can create a symmetric customer managed key by using the AWS Management Console, or the AWS KMS APIs.

To create a symmetric customer managed key

Follow the steps for [Creating symmetric encryption Creating symmetric KMS keys](#) in the *AWS Key Management Service Developer Guide*.

Permissions

Key policy

[Key policies](#) control access to your customer managed key. Every customer managed key must have exactly one key policy, which contains statements that determine who can use the key and how they can use it. For more information, see [How to change a key policy](#) in the *AWS Key Management Service Developer Guide*.

When you use a customer managed key to encrypt a .zip deployment package, Lambda doesn't add a [grant](#) to the key. Instead, your AWS KMS key policy must allow Lambda to call the following AWS KMS API operations on your behalf:

- [kms:GenerateDataKey](#)
- [kms:Decrypt](#)

The following example key policy allows all Lambda functions in account 111122223333 to call the required AWS KMS operations for the specified customer managed key:

Example AWS KMS key policy

```
{
```

```

"Version": "2012-10-17",
"Statement": [
  {
    "Effect": "Allow",
    "Principal": {
      "Service": "lambda.amazonaws.com"
    },
    "Action": [
      "kms:GenerateDataKey",
      "kms:Decrypt"
    ],
    "Resource": "arn:aws:kms:us-east-1:111122223333:key/key-id",
    "Condition": {
      "StringLike": {
        "kms:EncryptionContext:aws:lambda:FunctionArn": "arn:aws:lambda:us-
east-1:111122223333:function:*"
      }
    }
  }
]
}

```

For more information about [troubleshooting key access](#), see the *AWS Key Management Service Developer Guide*.

Principal permissions

When you use a customer managed key to encrypt a .zip deployment package, only [principals](#) with access to that key can access the .zip deployment package. For example, principals who don't have access to the customer managed key can't download the .zip package using the presigned S3 URL that's included in the [GetFunction](#) response. An `AccessDeniedException` is returned in the Code section of the response.

Example AWS KMS `AccessDeniedException`

```

{
  "Code": {
    "RepositoryType": "S3",
    "Error": {
      "ErrorCode": "AccessDeniedException",
      "Message": "KMS access is denied. Check your KMS permissions. KMS
Exception: AccessDeniedException KMS Message: User: arn:aws:sts::111122223333:assumed-
role/LambdaTestRole/session is not authorized to perform: kms:Decrypt on resource:

```

```
arn:aws:kms:us-east-1:111122223333:key/key-id with an explicit deny in a resource-
based policy"
    },
    "SourceKMSKeyArn": "arn:aws:kms:us-east-1:111122223333:key/key-id"
  },
  ...
```

For more information about permissions for AWS KMS keys, see [Authentication and access control for AWS KMS](#).

Using a customer managed key for your .zip deployment package

Use the following API parameters to configure customer managed keys for .zip deployment packages:

- [SourceKMSKeyArn](#): Encrypts the source .zip deployment package (the file that you upload).
- [KMSKeyArn](#): Encrypts [environment variables](#) and [Lambda SnapStart](#) snapshots.

When `SourceKMSKeyArn` and `KMSKeyArn` are both specified, Lambda uses the `KMSKeyArn` key to encrypt the unzipped version of the package that Lambda uses to invoke the function. When `SourceKMSKeyArn` is specified but `KMSKeyArn` is not, Lambda uses an [AWS managed key](#) to encrypt the unzipped version of the package.

Lambda console

To add customer managed key encryption when you create a function

1. Open the [Functions page](#) of the Lambda console.
2. Choose **Create function**.
3. Choose **Author from scratch** or **Container image**.
4. Under **Basic information**, do the following:
 - a. For **Function name**, enter the function name.
 - b. For **Runtime**, choose the language version to use for your function.
5. Expand **Advanced settings**, and then select **Enable encryption with an AWS KMS customer managed key**.
6. Choose a customer managed key.
7. Choose **Create function**.

To remove customer managed key encryption, or to use a different key, you must upload the .zip deployment package again.

To add customer managed key encryption to an existing function

1. Open the [Functions page](#) of the Lambda console.
2. Choose the name of a function.
3. In the **Code source** pane, choose **Upload from**.
4. Choose **.zip file** or **Amazon S3 location**.

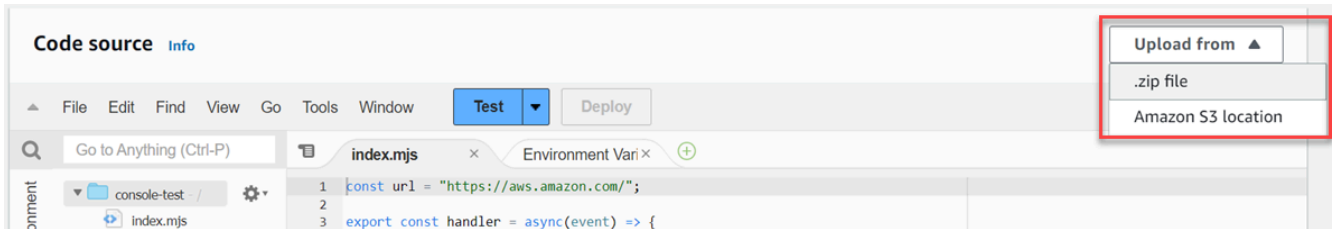

5. Upload the file or enter the Amazon S3 location.
6. Choose **Enable encryption with an AWS KMS customer managed key**.
7. Choose a customer managed key.
8. Choose **Save**.

AWS CLI

To add customer managed key encryption when you create a function

In the following [create-function](#) example:

- `--zip-file`: Specifies the local path to the .zip deployment package.
- `--source-kms-key-arn`: Specifies the customer managed key to encrypt the zipped version of the deployment package.
- `--kms-key-arn`: Specifies the customer managed key to encrypt the environment variables and the unzipped version of the deployment package.

```
aws lambda create-function \
  --function-name myFunction \
  --runtime nodejs22.x \
  --handler index.handler \
  --role arn:aws:iam::111122223333:role/service-role/my-lambda-role \
```

```
--zip-file fileb://myFunction.zip \  
--source-kms-key-arn arn:aws:kms:us-east-1:111122223333:key/key-id \  
--kms-key-arn arn:aws:kms:us-east-1:111122223333:key/key2-id
```

In the following [create-function](#) example:

- `--code`: Specifies the location of .zip file in an Amazon S3 bucket. You only need to use the `S3ObjectVersion` parameter for versioned objects.
- `--source-kms-key-arn`: Specifies the customer managed key to encrypt the zipped version of the deployment package.
- `--kms-key-arn`: Specifies the customer managed key to encrypt the environment variables and the unzipped version of the deployment package.

```
aws lambda create-function \  
  --function-name myFunction \  
  --runtime nodejs22.x --handler index.handler \  
  --role arn:aws:iam::111122223333:role/service-role/my-lambda-role \  
  --code S3Bucket=amzn-s3-demo-  
bucket,S3Key=myFileName.zip,S3ObjectVersion=myObjectVersion \  
  --source-kms-key-arn arn:aws:kms:us-east-1:111122223333:key/key-id \  
  --kms-key-arn arn:aws:kms:us-east-1:111122223333:key/key2-id
```

To add customer managed key encryption to an existing function

In the following [update-function-code](#) example:

- `--zip-file`: Specifies the local path to the .zip deployment package.
- `--source-kms-key-arn`: Specifies the customer managed key to encrypt the zipped version of the deployment package. Lambda uses an AWS owned key to encrypt the unzipped package for function invocations. If you want to use a customer managed key to encrypt the unzipped version of the package, run the [update-function-configuration](#) command with the `--kms-key-arn` option.

```
aws lambda update-function-code \  
  --function-name myFunction \  
  --zip-file fileb://myFunction.zip \  
  --source-kms-key-arn arn:aws:kms:us-east-1:111122223333:key/key-id
```

In the following [update-function-code](#) example:

- `--s3-bucket`: Specifies the location of the .zip file in an Amazon S3 bucket.
- `--s3-key`: Specifies the Amazon S3 key of the deployment package.
- `--s3-object-version`: For versioned objects, the version of the deployment package object to use.
- `--source-kms-key-arn`: Specifies the customer managed key to encrypt the zipped version of the deployment package. Lambda uses an AWS owned key to encrypt the unzipped package for function invocations. If you want to use a customer managed key to encrypt the unzipped version of the package, run the [update-function-configuration](#) command with the `--kms-key-arn` option.

```
aws lambda update-function-code \  
  --function-name myFunction \  
  --s3-bucket amzn-s3-demo-bucket \  
  --s3-key myFileName.zip \  
  --s3-object-version myObject Version \  
  --source-kms-key-arn arn:aws:kms:us-east-1:111122223333:key/key-id
```

To remove customer managed key encryption from an existing function

In the following [update-function-code](#) example, `--zip-file` specifies the local path to the .zip deployment package. When you run this command without the `--source-kms-key-arn` option, Lambda uses an AWS owned key to encrypt the zipped version of the deployment package.

```
aws lambda update-function-code \  
  --function-name myFunction \  
  --zip-file fileb://myFunction.zip
```

Create a Lambda function using a container image

Your AWS Lambda function's code consists of scripts or compiled programs and their dependencies. You use a *deployment package* to deploy your function code to Lambda. Lambda supports two types of deployment packages: container images and .zip file archives.

There are three ways to build a container image for a Lambda function:

- [Using an AWS base image for Lambda](#)

The [AWS base images](#) are preloaded with a language runtime, a runtime interface client to manage the interaction between Lambda and your function code, and a runtime interface emulator for local testing.

- [Using an AWS OS-only base image](#)

[AWS OS-only base images](#) contain an Amazon Linux distribution and the [runtime interface emulator](#). These images are commonly used to create container images for compiled languages, such as [Go](#) and [Rust](#), and for a language or language version that Lambda doesn't provide a base image for, such as Node.js 19. You can also use OS-only base images to implement a [custom runtime](#). To make the image compatible with Lambda, you must include a [runtime interface client](#) for your language in the image.

- [Using a non-AWS base image](#)

You can use an alternative base image from another container registry, such as Alpine Linux or Debian. You can also use a custom image created by your organization. To make the image compatible with Lambda, you must include a [runtime interface client](#) for your language in the image.

 **Tip**

To reduce the time it takes for Lambda container functions to become active, see [Use multi-stage builds](#) in the Docker documentation. To build efficient container images, follow the [Best practices for writing Dockerfiles](#).

To create a Lambda function from a container image, build your image locally and upload it to an Amazon Elastic Container Registry (Amazon ECR) repository. Then, specify the repository URI when you create the function. The Amazon ECR repository must be in the same AWS Region as the

Lambda function. You can create a function using an image in a different AWS account, as long as the image is in the same Region as the Lambda function. For more information, see [Amazon ECR cross-account permissions](#).

 **Note**

Lambda does not support Amazon ECR FIPS endpoints for container images. If your repository URI includes `ecr-fips`, you are using a FIPS endpoint. Example: `111122223333.dkr.ecr-fips.us-east-1.amazonaws.com`.

This page explains the base image types and requirements for creating Lambda-compatible container images.

 **Note**

You cannot change the [deployment package type](#) (.zip or container image) for an existing function. For example, you cannot convert a container image function to use a .zip file archive. You must create a new function.

Topics

- [Requirements](#)
- [Using an AWS base image for Lambda](#)
- [Using an AWS OS-only base image](#)
- [Using a non-AWS base image](#)
- [Runtime interface clients](#)
- [Amazon ECR permissions](#)
- [Function lifecycle](#)

Requirements

Install the [AWS CLI version 2](#) and the [Docker CLI](#). Additionally, note the following requirements:

- The container image must implement the [Using the Lambda runtime API for custom runtimes](#). The AWS open-source [runtime interface clients](#) implement the API. You can add a runtime interface client to your preferred base image to make it compatible with Lambda.
- The container image must be able to run on a read-only file system. Your function code can access a writable `/tmp` directory with between 512 MB and 10,240 MB, in 1-MB increments, of storage.
- The default Lambda user must be able to read all the files required to run your function code. Lambda follows security best practices by defining a default Linux user with least-privileged permissions. This means that you don't need to specify a `USER` in your Dockerfile. Verify that your application code does not rely on files that other Linux users are restricted from running.
- Lambda supports only Linux-based container images.
- Lambda provides multi-architecture base images. However, the image you build for your function must target only one of the architectures. Lambda does not support functions that use multi-architecture container images.

Using an AWS base image for Lambda

You can use one of the [AWS base images](#) for Lambda to build the container image for your function code. The base images are preloaded with a language runtime and other components required to run a container image on Lambda. You add your function code and dependencies to the base image and then package it as a container image.

AWS periodically provides updates to the AWS base images for Lambda. If your Dockerfile includes the image name in the `FROM` property, your Docker client pulls the latest version of the image from the [Amazon ECR repository](#). To use the updated base image, you must rebuild your container image and [update the function code](#).

The Node.js 20, Python 3.12, Java 21, .NET 8, Ruby 3.3, and later base images are based on the [Amazon Linux 2023 minimal container image](#). Earlier base images use Amazon Linux 2. AL2023 provides several advantages over Amazon Linux 2, including a smaller deployment footprint and updated versions of libraries such as `glibc`.

AL2023-based images use `microdnf` (symlinked as `dnf`) as the package manager instead of `yum`, which is the default package manager in Amazon Linux 2. `microdnf` is a standalone implementation of `dnf`. For a list of packages that are included in AL2023-based images, refer to the **Minimal Container** columns in [Comparing packages installed on Amazon Linux 2023 Container](#)

[Images](#). For more information about the differences between AL2023 and Amazon Linux 2, see [Introducing the Amazon Linux 2023 runtime for AWS Lambda](#) on the AWS Compute Blog.

Note

To run AL2023-based images locally, including with AWS Serverless Application Model (AWS SAM), you must use Docker version 20.10.10 or later.

To build a container image using an AWS base image, choose the instructions for your preferred language:

- [Node.js](#)
- [TypeScript](#) (uses a Node.js base image)
- [Python](#)
- [Java](#)
- [Go](#)
- [.NET](#)
- [Ruby](#)

Using an AWS OS-only base image

[AWS OS-only base images](#) contain an Amazon Linux distribution and the [runtime interface emulator](#). These images are commonly used to create container images for compiled languages, such as [Go](#) and [Rust](#), and for a language or language version that Lambda doesn't provide a base image for, such as Node.js 19. You can also use OS-only base images to implement a [custom runtime](#). To make the image compatible with Lambda, you must include a [runtime interface client](#) for your language in the image.

Tags	Runtime	Operating system	Dockerfile	Deprecation
al2023	OS-only Runtime	Amazon Linux 2023	Dockerfile for OS-only Runtime on GitHub	Not scheduled

Tags	Runtime	Operating system	Dockerfile	Deprecation
al2	OS-only Runtime	Amazon Linux 2	Dockerfile for OS-only Runtime on GitHub	Not scheduled

Amazon Elastic Container Registry Public Gallery: gallery.ecr.aws/lambda/provided

Using a non-AWS base image

Lambda supports any image that conforms to one of the following image manifest formats:

- Docker image manifest V2, schema 2 (used with Docker version 1.10 and newer)
- Open Container Initiative (OCI) Specifications (v1.0.0 and up)

Lambda supports a maximum uncompressed image size of 10 GB, including all layers.

Note

To make the image compatible with Lambda, you must include a [runtime interface client](#) for your language in the image.

Runtime interface clients

If you use an [OS-only base image](#) or an alternative base image, you must include a runtime interface client in your image. The runtime interface client must extend the [Using the Lambda runtime API for custom runtimes](#), which manages the interaction between Lambda and your function code. AWS provides open-source runtime interface clients for the following languages:

- [Node.js](#)
- [Python](#)
- [Java](#)
- [.NET](#)
- [Go](#)
- [Ruby](#)

- [Rust](#) – The [Rust runtime client](#) is an experimental package. It is subject to change and intended only for evaluation purposes.

If you're using a language that doesn't have an AWS-provided runtime interface client, you must create your own.

Amazon ECR permissions

Before you create a Lambda function from a container image, you must build the image locally and upload it to an Amazon ECR repository. When you create the function, specify the Amazon ECR repository URI.

Make sure that the permissions for the user or role that creates the function includes `GetRepositoryPolicy` and `SetRepositoryPolicy`.

For example, use the IAM console to create a role with the following policy:

```
{
  "Version": "2012-10-17",
  "Statement": [
    {
      "Sid": "VisualEditor0",
      "Effect": "Allow",
      "Action": [
        "ecr:SetRepositoryPolicy",
        "ecr:GetRepositoryPolicy"
      ],
      "Resource": "arn:aws:ecr:us-east-1:111122223333:repository/hello-world"
    }
  ]
}
```

Amazon ECR repository policies

For a function in the same account as the container image in Amazon ECR, you can add `ecr:BatchGetImage` and `ecr:GetDownloadUrlForLayer` permissions to your Amazon ECR repository policy. The following example shows the minimum policy:

```
{
  "Sid": "LambdaECRImageRetrievalPolicy",
  "Effect": "Allow",
```

```
"Principal": {
  "Service": "lambda.amazonaws.com"
},
"Action": [
  "ecr:BatchGetImage",
  "ecr:GetDownloadUrlForLayer"
]
}
```

For more information about Amazon ECR repository permissions, see [Private repository policies](#) in the *Amazon Elastic Container Registry User Guide*.

If the Amazon ECR repository does not include these permissions, Lambda adds `ecr:BatchGetImage` and `ecr:GetDownloadUrlForLayer` to the container image repository permissions. Lambda can add these permissions only if the principal calling Lambda has `ecr:getRepositoryPolicy` and `ecr:setRepositoryPolicy` permissions.

To view or edit your Amazon ECR repository permissions, follow the directions in [Setting a private repository policy statement](#) in the *Amazon Elastic Container Registry User Guide*.

Amazon ECR cross-account permissions

A different account in the same region can create a function that uses a container image owned by your account. In the following example, your [Amazon ECR repository permissions policy](#) needs the following statements to grant access to account number 123456789012.

- **CrossAccountPermission** – Allows account 123456789012 to create and update Lambda functions that use images from this ECR repository.
- **LambdaECRImageCrossAccountRetrievalPolicy** – Lambda will eventually set a function's state to inactive if it is not invoked for an extended period. This statement is required so that Lambda can retrieve the container image for optimization and caching on behalf of the function owned by 123456789012.

Example — Add cross-account permission to your repository

```
{
  "Version": "2012-10-17",
  "Statement": [
    {
      "Sid": "CrossAccountPermission",
      "Effect": "Allow",
```

```

    "Action": [
      "ecr:BatchGetImage",
      "ecr:GetDownloadUrlForLayer"
    ],
    "Principal": {
      "AWS": "arn:aws:iam::123456789012:root"
    }
  },
  {
    "Sid": "LambdaECRImageCrossAccountRetrievalPolicy",
    "Effect": "Allow",
    "Action": [
      "ecr:BatchGetImage",
      "ecr:GetDownloadUrlForLayer"
    ],
    "Principal": {
      "Service": "lambda.amazonaws.com"
    },
    "Condition": {
      "StringLike": {
        "aws:sourceARN": "arn:aws:lambda:us-east-1:123456789012:function:*"
      }
    }
  }
]
}

```

To give access to multiple accounts, you add the account IDs to the Principal list in the `CrossAccountPermission` policy and to the Condition evaluation list in the `LambdaECRImageCrossAccountRetrievalPolicy`.

If you are working with multiple accounts in an AWS Organization, we recommend that you enumerate each account ID in the ECR permissions policy. This approach aligns with the AWS security best practice of setting narrow permissions in IAM policies.

In addition to Lambda permissions, the user or role that creates the function must also have `BatchGetImage` and `GetDownloadUrlForLayer` permissions.

Function lifecycle

After you upload a new or updated container image, Lambda optimizes the image before the function can process invocations. The optimization process can take a few seconds. The function

remains in the `Pending` state until the process completes, when the state transitions to `Active`. You can't invoke the function until it reaches the `Active` state.

If a function is not invoked for multiple weeks, Lambda reclaims its optimized version, and the function transitions to the `Inactive` state. To reactivate the function, you must invoke it. Lambda rejects the first invocation and the function enters the `Pending` state until Lambda re-optimizes the image. The function then returns to the `Active` state.

Lambda periodically fetches the associated container image from the Amazon ECR repository. If the corresponding container image no longer exists on Amazon ECR or permissions are revoked, the function enters the `Failed` state, and Lambda returns a failure for any function invocations.

You can use the Lambda API to get information about a function's state. For more information, see [Lambda function states](#).

Configure Lambda function memory

Lambda allocates CPU power in proportion to the amount of memory configured. *Memory* is the amount of memory available to your Lambda function at runtime. You can increase or decrease the memory and CPU power allocated to your function using the **Memory** setting. You can configure memory between 128 MB and 10,240 MB in 1-MB increments. At 1,769 MB, a function has the equivalent of one vCPU (one vCPU-second of credits per second).

This page describes how and when to update the memory setting for a Lambda function.

Sections

- [Determining the appropriate memory setting for a Lambda function](#)
- [Configuring function memory \(console\)](#)
- [Configuring function memory \(AWS CLI\)](#)
- [Configuring function memory \(AWS SAM\)](#)
- [Accepting function memory recommendations \(console\)](#)

Determining the appropriate memory setting for a Lambda function

Memory is the principal lever for controlling the performance of a function. The default setting, 128 MB, is the lowest possible setting. We recommend that you only use 128 MB for simple Lambda functions, such as those that transform and route events to other AWS services. A higher memory allocation can improve performance for functions that use imported libraries, [Lambda layers](#), Amazon Simple Storage Service (Amazon S3) or Amazon Elastic File System (Amazon EFS). Adding more memory proportionally increases the amount of CPU, increasing the overall computational power available. If a function is CPU, network or memory-bound, then increasing the memory setting can dramatically improve its performance.

To find the right memory configuration, monitor your functions with Amazon CloudWatch and set alarms if memory consumption is approaching the configured maximums. This can help identify memory-bound functions. For CPU-bound and IO-bound functions, monitoring the duration can also provide insight. In these cases, increasing the memory can help resolve the compute or network bottlenecks.

You can also consider using the open source [AWS Lambda Power Tuning](#) tool. This tool uses AWS Step Functions to run multiple concurrent versions of a Lambda function at different

memory allocations and measure the performance. The input function runs in your AWS account, performing live HTTP calls and SDK interaction, to measure likely performance in a live production scenario. You can also implement a CI/CD process to use this tool to automatically measure the performance of new functions that you deploy.

Configuring function memory (console)

You can configure the memory of your function in the Lambda console.

To update the memory of a function

1. Open the [Functions page](#) of the Lambda console.
2. Choose a function.
3. Choose the **Configuration** tab and then choose **General configuration**.

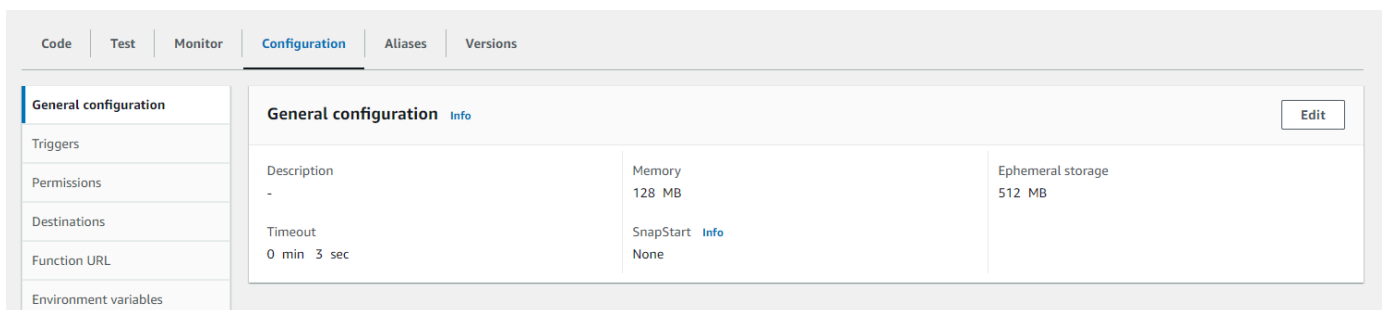

4. Under **General configuration**, choose **Edit**.
5. For **Memory**, set a value from 128 MB to 10,240 MB.
6. Choose **Save**.

Configuring function memory (AWS CLI)

You can use the [update-function-configuration](#) command to configure the memory of your function.

Example

```
aws lambda update-function-configuration \  
  --function-name my-function \  
  --memory-size 1024
```

Configuring function memory (AWS SAM)

You can use the [AWS Serverless Application Model](#) to configure memory for your function. Update the [MemorySize](#) property in your `template.yaml` file and then run [sam deploy](#).

Example `template.yaml`

```
AWS::CloudFormation::Template
AWSTemplateFormatVersion: '2010-09-09'
Transform: AWS::Serverless-2016-10-31
Description: An AWS Serverless Application Model template describing your function.
Resources:
  my-function:
    Type: AWS::Serverless::Function
    Properties:
      CodeUri: .
      Description: ''
      MemorySize: 1024
      # Other function properties...
```

Accepting function memory recommendations (console)

If you have administrator permissions in AWS Identity and Access Management (IAM), you can opt in to receive Lambda function memory setting recommendations from AWS Compute Optimizer. For instructions on opting in to memory recommendations for your account or organization, see [Opting in your account](#) in the *AWS Compute Optimizer User Guide*.

Note

Compute Optimizer supports only functions that use `x86_64` architecture.

When you've opted in and your [Lambda function meets Compute Optimizer requirements](#), you can view and accept function memory recommendations from Compute Optimizer in the Lambda console in **General configuration**.

Configure ephemeral storage for Lambda functions

Lambda provides ephemeral storage for functions in the `/tmp` directory. This storage is temporary and unique to each execution environment. You can control the amount of ephemeral storage allocated to your function using the **Ephemeral storage** setting. You can configure ephemeral storage between 512 MB and 10,240 MB, in 1-MB increments. All data stored in `/tmp` is encrypted at rest with a key managed by AWS.

This page describes common use cases and how to update the ephemeral storage for a Lambda function.

Sections

- [Common use cases for increased ephemeral storage](#)
- [Configuring ephemeral storage \(console\)](#)
- [Configuring ephemeral storage \(AWS CLI\)](#)
- [Configuring ephemeral storage \(AWS SAM\)](#)

Common use cases for increased ephemeral storage

Here are several common use cases that benefit from increased ephemeral storage:

- **Extract-transform-load (ETL) jobs:** Increase ephemeral storage when your code performs intermediate computation or downloads other resources to complete processing. More temporary space enables more complex ETL jobs to run in Lambda functions.
- **Machine learning (ML) inference:** Many inference tasks rely on large reference data files, including libraries and models. With more ephemeral storage, you can download larger models from Amazon Simple Storage Service (Amazon S3) to `/tmp` and use them in your processing.
- **Data processing:** For workloads that download objects from Amazon S3 in response to S3 events, more `/tmp` space makes it possible to handle larger objects without using in-memory processing. Workloads that create PDFs or process media also benefit from more ephemeral storage.
- **Graphics processing:** Image processing is a common use case for Lambda-based applications. For workloads that process large TIFF files or satellite images, more ephemeral storage makes it easier to use libraries and perform the computation in Lambda.

Configuring ephemeral storage (console)

You can configure ephemeral storage in the Lambda console.

To modify ephemeral storage for a function

1. Open the [Functions page](#) of the Lambda console.
2. Choose a function.
3. Choose the **Configuration** tab and then choose **General configuration**.

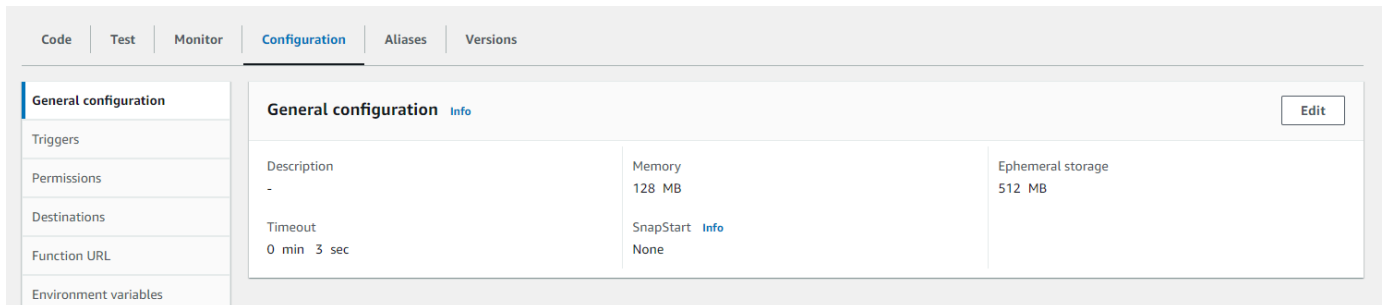

4. Under **General configuration**, choose **Edit**.
5. For **Ephemeral storage**, set a value between 512 MB and 10,240 MB, in 1-MB increments.
6. Choose **Save**.

Configuring ephemeral storage (AWS CLI)

You can use the [update-function-configuration](#) command to configure ephemeral storage.

Example

```
aws lambda update-function-configuration \  
  --function-name my-function \  
  --ephemeral-storage '{"Size": 1024}'
```

Configuring ephemeral storage (AWS SAM)

You can use the [AWS Serverless Application Model](#) to configure ephemeral storage for your function. Update the [EphemeralStorage](#) property in your `template.yaml` file and then run [sam deploy](#).

Example template.yaml

```
AWSTemplateFormatVersion: '2010-09-09'
Transform: AWS::Serverless-2016-10-31
Description: An AWS Serverless Application Model template describing your function.
Resources:
  my-function:
    Type: AWS::Serverless::Function
    Properties:
      CodeUri: .
      Description: ''
      MemorySize: 128
      Timeout: 120
      Handler: index.handler
      Runtime: nodejs22.x
      Architectures:
        - x86_64
      EphemeralStorage:
        Size: 10240
      # Other function properties...
```

Selecting and configuring an instruction set architecture for your Lambda function

The *instruction set architecture* of a Lambda function determines the type of computer processor that Lambda uses to run the function. Lambda provides a choice of instruction set architectures:

- arm64 – 64-bit ARM architecture, for the AWS Graviton2 processor.
- x86_64 – 64-bit x86 architecture, for x86-based processors.

Note

The arm64 architecture is available in most AWS Regions. For more information, see [AWS Lambda Pricing](#). In the memory prices table, choose the **Arm Price** tab, and then open the **Region** dropdown list to see which AWS Regions support arm64 with Lambda.

For an example of how to create a function with arm64 architecture, see [AWS Lambda Functions Powered by AWS Graviton2 Processor](#).

Topics

- [Advantages of using arm64 architecture](#)
- [Requirements for migration to arm64 architecture](#)
- [Function code compatibility with arm64 architecture](#)
- [How to migrate to arm64 architecture](#)
- [Configuring the instruction set architecture](#)

Advantages of using arm64 architecture

Lambda functions that use arm64 architecture (AWS Graviton2 processor) can achieve significantly better price and performance than the equivalent function running on x86_64 architecture. Consider using arm64 for compute-intensive applications such as high-performance computing, video encoding, and simulation workloads.

The Graviton2 CPU uses the Neoverse N1 core and supports Armv8.2 (including CRC and crypto extensions) plus several other architectural extensions.

Graviton2 reduces memory read time by providing a larger L2 cache per vCPU, which improves the latency performance of web and mobile backends, microservices, and data processing systems. Graviton2 also provides improved encryption performance and supports instruction sets that improve the latency of CPU-based machine learning inference.

For more information about AWS Graviton2, see [AWS Graviton Processor](#).

Requirements for migration to arm64 architecture

When you select a Lambda function to migrate to arm64 architecture, to ensure a smooth migration, make sure that your function meets the following requirements:

- The deployment package contains only open-source components and source code that you control, so that you can make any necessary updates for the migration.
- If the function code includes third-party dependencies, each library or package provides an arm64 version.

Function code compatibility with arm64 architecture

Your Lambda function code must be compatible with the instruction set architecture of the function. Before you migrate a function to arm64 architecture, note the following points about the current function code:

- If you added your function code using the embedded code editor, your code probably runs on either architecture without modification.
- If you uploaded your function code, you must upload new code that is compatible with your target architecture.
- If your function uses layers, you must [check each layer](#) to ensure that it is compatible with the new architecture. If a layer is not compatible, edit the function to replace the current layer version with a compatible layer version.
- If your function uses Lambda extensions, you must check each extension to ensure that it is compatible with the new architecture.
- If your function uses a container image deployment package type, you must create a new container image that is compatible with the architecture of the function.

How to migrate to arm64 architecture

To migrate a Lambda function to the arm64 architecture, we recommend following these steps:

1. Build the list of dependencies for your application or workload. Common dependencies include:
 - All the libraries and packages that the function uses.
 - The tools that you use to build, deploy, and test the function, such as compilers, test suites, continuous integration and continuous delivery (CI/CD) pipelines, provisioning tools, and scripts.
 - The Lambda extensions and third-party tools that you use to monitor the function in production.
2. For each of the dependencies, check the version, and then check whether arm64 versions are available.
3. Build an environment to migrate your application.
4. Bootstrap the application.
5. Test and debug the application.
6. Test the performance of the arm64 function. Compare the performance with the x86_64 version.
7. Update your infrastructure pipeline to support arm64 Lambda functions.
8. Stage your deployment to production.

For example, use [alias routing configuration](#) to split traffic between the x86 and arm64 versions of the function, and compare the performance and latency.

For more information about how to create a code environment for arm64 architecture, including language-specific information for Java, Go, .NET, and Python, see the [Getting started with AWS Graviton](#) GitHub repository.

Configuring the instruction set architecture

You can configure the instruction set architecture for new and existing Lambda functions using the Lambda console, AWS SDKs, AWS Command Line Interface (AWS CLI), or AWS CloudFormation. Follow these steps to change the instruction set architecture for an existing Lambda function from the console.

1. Open the [Functions page](#) of the Lambda console.
2. Choose the name of the function that you want to configure the instruction set architecture for.

3. On the main **Code** tab, for the **Runtime settings** section, choose **Edit**.
4. Under **Architecture**, choose the instruction set architecture you want your function to use.
5. Choose **Save**.

Configure Lambda function timeout

Lambda runs your code for a set amount of time before timing out. *Timeout* is the maximum amount of time in seconds that a Lambda function can run. The default value for this setting is 3 seconds, but you can adjust this in increments of 1 second up to a maximum value of 900 seconds (15 minutes).

This page describes how and when to update the timeout setting for a Lambda function.

Sections

- [Determining the appropriate timeout value for a Lambda function](#)
- [Configuring timeout \(console\)](#)
- [Configuring timeout \(AWS CLI\)](#)
- [Configuring timeout \(AWS SAM\)](#)

Determining the appropriate timeout value for a Lambda function

If the timeout value is close to the average duration of a function, there is a higher risk that the function will time out unexpectedly. The duration of a function can vary based on the amount of data transfer and processing, and the latency of any services the function interacts with. Some common causes of timeout include:

- Downloads from Amazon Simple Storage Service (Amazon S3) are larger or take longer than average.
- A function makes a request to another service, which takes longer to respond.
- The parameters provided to a function require more computational complexity in the function, which causes the invocation to take longer.

When testing your application, ensure that your tests accurately reflect the size and quantity of data and realistic parameter values. Tests often use small samples for convenience, but you should use datasets at the upper bounds of what is reasonably expected for your workload.

Configuring timeout (console)

You can configure function timeout in the Lambda console.

To modify the timeout for a function

1. Open the [Functions page](#) of the Lambda console.
2. Choose a function.
3. Choose the **Configuration** tab and then choose **General configuration**.

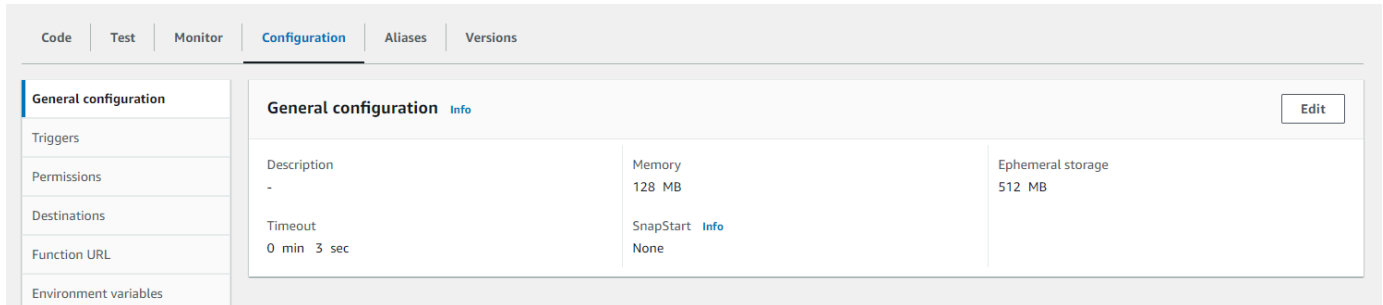

4. Under **General configuration**, choose **Edit**.
5. For **Timeout**, set a value between 1 and 900 seconds (15 minutes).
6. Choose **Save**.

Configuring timeout (AWS CLI)

You can use the [update-function-configuration](#) command to configure the timeout value, in seconds. The following example command increases the function timeout to 120 seconds (2 minutes).

Example

```
aws lambda update-function-configuration \
  --function-name my-function \
  --timeout 120
```

Configuring timeout (AWS SAM)

You can use the [AWS Serverless Application Model](#) to configure the timeout value for your function. Update the [Timeout](#) property in your `template.yaml` file and then run [sam deploy](#).

Example `template.yaml`

```
AWSTemplateFormatVersion: '2010-09-09'
Transform: AWS::Serverless-2016-10-31
```

Description: An AWS Serverless Application Model template describing your function.

Resources:

my-function:

Type: AWS::Serverless::Function

Properties:

CodeUri: .

Description: ''

MemorySize: 128

Timeout: *120*

Other function properties...

Create Lambda environment variables

You can use environment variables to adjust your function's behavior without updating code. An environment variable is a pair of strings that is stored in a function's version-specific configuration. The Lambda runtime makes environment variables available to your code and sets additional environment variables that contain information about the function and invocation request.

Note

To increase security, we recommend that you use AWS Secrets Manager instead of environment variables to store database credentials and other sensitive information like API keys or authorization tokens. For more information, see [Create and manage secrets with AWS Secrets Manager](#).

Environment variables are not evaluated before the function invocation. Any value you define is considered a literal string and not expanded. Perform the variable evaluation in your function code.

You can configure environment variables in Lambda using the Lambda console, the AWS Command Line Interface (AWS CLI), AWS Serverless Application Model (AWS SAM), or using an AWS SDK.

Console

You define environment variables on the unpublished version of your function. When you publish a version, the environment variables are locked for that version along with other [version-specific configuration settings](#).

You create an environment variable for your function by defining a key and a value. Your function uses the name of the key to retrieve the value of the environment variable.

To set environment variables in the Lambda console

1. Open the [Functions page](#) of the Lambda console.
2. Choose a function.
3. Choose the **Configuration** tab, then choose **Environment variables**.
4. Under **Environment variables**, choose **Edit**.
5. Choose **Add environment variable**.
6. Enter a key and value.

Requirements

- Keys start with a letter and are at least two characters.
- Keys only contain letters, numbers, and the underscore character (`_`).
- Keys aren't [reserved by Lambda](#).
- The total size of all environment variables doesn't exceed 4 KB.

7. Choose **Save**.

To generate a list of environment variables in the console code editor

You can generate a list of environment variables in the Lambda code editor. This is a quick way to reference your environment variables while you code.

1. Choose the **Code** tab.
2. Scroll down to the **ENVIRONMENT VARIABLES** section of the code editor. Existing environment variables are listed here:



3. To create new environment variables, choose the plus sign

(**+**

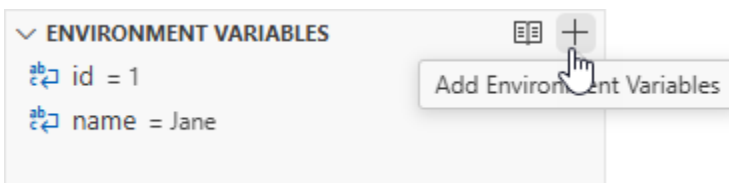

):

Environment variables remain encrypted when listed in the console code editor. If you enabled encryption helpers for encryption in transit, then those settings remain unchanged. For more information, see [Securing Lambda environment variables](#).

The environment variables list is read-only and is available only on the Lambda console. This file is not included when you download the function's .zip file archive, and you can't add environment variables by uploading this file.

AWS CLI

The following example sets two environment variables on a function named `my-function`.

```
aws lambda update-function-configuration \  
  --function-name my-function \  
  --environment "Variables={BUCKET=amzn-s3-demo-bucket,KEY=file.txt}"
```

When you apply environment variables with the `update-function-configuration` command, the entire contents of the `Variables` structure is replaced. To retain existing environment variables when you add a new one, include all existing values in your request.

To get the current configuration, use the `get-function-configuration` command.

```
aws lambda get-function-configuration \  
  --function-name my-function
```

You should see the following output:

```
{  
  "FunctionName": "my-function",  
  "FunctionArn": "arn:aws:lambda:us-east-2:111122223333:function:my-function",  
  "Runtime": "nodejs22.x",  
  "Role": "arn:aws:iam::111122223333:role/lambda-role",  
  "Environment": {  
    "Variables": {  
      "BUCKET": "amzn-s3-demo-bucket",  
      "KEY": "file.txt"  
    }  
  },  
  "RevisionId": "0894d3c1-2a3d-4d48-bf7f-abade99f3c15",  
  ...  
}
```

You can pass the revision ID from the output of `get-function-configuration` as a parameter to `update-function-configuration`. This ensures that the values don't change between when you read the configuration and when you update it.

To configure a function's encryption key, set the `KMSKeyARN` option.

```
aws lambda update-function-configuration \  
  --function-name my-function \  
  --kmskeyarn arn:aws:kms:us-east-2:111122223333:key/12345678-9012-3456-7890-123456789012
```



```
--function-name my-function \  
--kms-key-arn arn:aws:kms:us-east-2:111122223333:key/055efbb4-xmpl-4336-  
ba9c-538c7d31f599
```

AWS SAM

You can use the [AWS Serverless Application Model](#) to configure environment variables for your function. Update the [Environment](#) and [Variables](#) properties in your `template.yaml` file and then run [sam deploy](#).

Example `template.yaml`

```
AWSTemplateFormatVersion: '2010-09-09'  
Transform: AWS::Serverless-2016-10-31  
Description: An AWS Serverless Application Model template describing your function.  
Resources:  
  my-function:  
    Type: AWS::Serverless::Function  
    Properties:  
      CodeUri: .  
      Description: ''  
      MemorySize: 128  
      Timeout: 120  
      Handler: index.handler  
      Runtime: nodejs18.x  
      Architectures:  
        - x86_64  
      EphemeralStorage:  
        Size: 10240  
      Environment:  
        Variables:  
          BUCKET: amzn-s3-demo-bucket  
          KEY: file.txt  
      # Other function properties...
```

AWS SDKs

To manage environment variables using an AWS SDK, use the following API operations.

- [UpdateFunctionConfiguration](#)
- [GetFunctionConfiguration](#)
- [CreateFunction](#)

To learn more, refer to the [AWS SDK documentation](#) for your preferred programming language.

Defined runtime environment variables

Lambda [runtimes](#) set several environment variables during initialization. Most of the environment variables provide information about the function or runtime. The keys for these environment variables are *reserved* and cannot be set in your function configuration.

Reserved environment variables

- `_HANDLER` – The handler location configured on the function.
- `_X_AMZN_TRACE_ID` – The [X-Ray tracing header](#). This environment variable changes with each invocation.
 - This environment variable is not defined for OS-only runtimes (the `provided` runtime family). You can set `_X_AMZN_TRACE_ID` for custom runtimes using the `Lambda-Runtime-Trace-Id` response header from the [Next invocation](#).
 - For Java runtime versions 17 and later, this environment variable is not used. Instead, Lambda stores tracing information in the `com.amazonaws.xray.traceHeader` system property.
- `AWS_DEFAULT_REGION` – The default AWS Region where the Lambda function is executed.
- `AWS_REGION` – The AWS Region where the Lambda function is executed. If defined, this value overrides the `AWS_DEFAULT_REGION`.
 - For more information about using the AWS Region environment variables with AWS SDKs, see [AWS Region](#) in the *AWS SDKs and Tools Reference Guide*.
- `AWS_EXECUTION_ENV` – The [runtime identifier](#), prefixed by `AWS_Lambda_` (for example, `AWS_Lambda_java8`). This environment variable is not defined for OS-only runtimes (the `provided` runtime family).
- `AWS_LAMBDA_FUNCTION_NAME` – The name of the function.
- `AWS_LAMBDA_FUNCTION_MEMORY_SIZE` – The amount of memory available to the function in MB.
- `AWS_LAMBDA_FUNCTION_VERSION` – The version of the function being executed.
- `AWS_LAMBDA_INITIALIZATION_TYPE` – The initialization type of the function, which is `on-demand`, `provisioned-concurrency`, or `snap-start`. For information, see [Configuring provisioned concurrency](#) or [Improving startup performance with Lambda SnapStart](#).

- `AWS_LAMBDA_LOG_GROUP_NAME`, `AWS_LAMBDA_LOG_STREAM_NAME` – The name of the Amazon CloudWatch Logs group and stream for the function. The `AWS_LAMBDA_LOG_GROUP_NAME` and `AWS_LAMBDA_LOG_STREAM_NAME` [environment variables](#) are not available in Lambda SnapStart functions.
- `AWS_ACCESS_KEY`, `AWS_ACCESS_KEY_ID`, `AWS_SECRET_ACCESS_KEY`, `AWS_SESSION_TOKEN` – The access keys obtained from the function's [execution role](#).
- `AWS_LAMBDA_RUNTIME_API` – ([Custom runtime](#)) The host and port of the [runtime API](#).
- `LAMBDA_TASK_ROOT` – The path to your Lambda function code.
- `LAMBDA_RUNTIME_DIR` – The path to runtime libraries.

The following additional environment variables aren't reserved and can be extended in your function configuration.

Unreserved environment variables

- `LANG` – The locale of the runtime (`en_US.UTF-8`).
- `PATH` – The execution path (`/usr/local/bin:/usr/bin:/bin:/opt/bin`).
- `LD_LIBRARY_PATH` – The system library path (`/var/lang/lib:/lib64:/usr/lib64:$LAMBDA_RUNTIME_DIR:$LAMBDA_RUNTIME_DIR/lib:$LAMBDA_TASK_ROOT:$LAMBDA_TASK_ROOT/lib:/opt/lib`).
- `NODE_PATH` – ([Node.js](#)) The Node.js library path (`/opt/nodejs/node12/node_modules:/opt/nodejs/node_modules:$LAMBDA_RUNTIME_DIR/node_modules`).
- `PYTHONPATH` – ([Python](#)) The Python library path (`$LAMBDA_RUNTIME_DIR`).
- `GEM_PATH` – ([Ruby](#)) The Ruby library path (`$LAMBDA_TASK_ROOT/vendor/bundle/ruby/3.3.0:/opt/ruby/gems/3.3.0`).
- `AWS_XRAY_CONTEXT_MISSING` – For X-Ray tracing, Lambda sets this to `LOG_ERROR` to avoid throwing runtime errors from the X-Ray SDK.
- `AWS_XRAY_DAEMON_ADDRESS` – For X-Ray tracing, the IP address and port of the X-Ray daemon.
- `AWS_LAMBDA_DOTNET_PREJIT` – ([.NET](#)) Set this variable to enable or disable .NET specific runtime optimizations. Values include `always`, `never`, and `provisioned-concurrency`. For more information, see [Configuring provisioned concurrency for a function](#).
- `TZ` – The environment's time zone (`:UTC`). The execution environment uses NTP to synchronize the system clock.

The sample values shown reflect the latest runtimes. The presence of specific variables or their values can vary on earlier runtimes.

Example scenario for environment variables

You can use environment variables to customize function behavior in your test environment and production environment. For example, you can create two functions with the same code but different configurations. One function connects to a test database, and the other connects to a production database. In this situation, you use environment variables to pass the hostname and other connection details for the database to the function.

The following example shows how to define the database host and database name as environment variables.

ENVIRONMENT	DEVELOPMENT	Remove
databaseHost	lambdadb	Remove
databaseName	rd1owwlydynnm5.cuovuayfg087	Remove
<i>Key</i>	<i>Value</i>	Remove

If you want your test environment to generate more debug information than the production environment, you could set an environment variable to configure your test environment to use more verbose logging or more detailed tracing.

Securing Lambda environment variables

For securing your environment variables, you can use server-side encryption to protect your data at rest and client-side encryption to protect your data in transit.

Note

To increase database security, we recommend that you use AWS Secrets Manager instead of environment variables to store database credentials. For more information, see [Using AWS Lambda with Amazon RDS](#).

Security at rest

Lambda always provides server-side encryption at rest with an AWS KMS key. By default, Lambda uses an AWS managed key. If this default behavior suits your workflow, you don't need to set up anything else. Lambda creates the AWS managed key in your account and manages the permissions for you. AWS doesn't charge you to use this key.

If you prefer, you can provide an AWS KMS customer managed key instead. You might do this to have control over rotation of the KMS key or to meet the requirements of your organization for managing KMS keys. When you use a customer managed key, only users in your account with access to the KMS key can view or manage environment variables on the function.

Customer managed keys incur standard AWS KMS charges. For more information, see [AWS Key Management Service pricing](#).

Security in transit

For additional security, you can enable helpers for encryption in transit, which ensures that your environment variables are encrypted client-side for protection in transit.

To configure encryption for your environment variables

1. Use the AWS Key Management Service (AWS KMS) to create any customer managed keys for Lambda to use for server-side and client-side encryption. For more information, see [Creating keys](#) in the *AWS Key Management Service Developer Guide*.
2. Using the Lambda console, navigate to the **Edit environment variables** page.
 - a. Open the [Functions page](#) of the Lambda console.
 - b. Choose a function.
 - c. Choose **Configuration**, then choose **Environment variables** from the left navigation bar.
 - d. In the **Environment variables** section, choose **Edit**.
 - e. Expand **Encryption configuration**.
3. (Optional) Enable console encryption helpers to use client-side encryption to protect your data in transit.
 - a. Under **Encryption in transit**, choose **Enable helpers for encryption in transit**.
 - b. For each environment variable that you want to enable console encryption helpers for, choose **Encrypt** next to the environment variable.
 - c. Under AWS KMS key to encrypt in transit, choose a customer managed key that you created at the beginning of this procedure.

- d. Choose **Execution role policy** and copy the policy. This policy grants permission to your function's execution role to decrypt the environment variables.

Save this policy to use in the last step of this procedure.
 - e. Add code to your function that decrypts the environment variables. To see an example, choose **Decrypt secrets snippet**.
4. (Optional) Specify your customer managed key for encryption at rest.
 - a. Choose **Use a customer master key**.
 - b. Choose a customer managed key that you created at the beginning of this procedure.
 5. Choose **Save**.
 6. Set up permissions.

If you're using a customer managed key with server-side encryption, grant permissions to any users or roles that you want to be able to view or manage environment variables on the function. For more information, see [Managing permissions to your server-side encryption KMS key](#).

If you're enabling client-side encryption for security in transit, your function needs permission to call the `kms:Decrypt` API operation. Add the policy that you saved previously in this procedure to the function's [execution role](#).

Managing permissions to your server-side encryption KMS key

No AWS KMS permissions are required for your user or the function's execution role to use the default encryption key. To use a customer managed key, you need permission to use the key. Lambda uses your permissions to create a grant on the key. This allows Lambda to use it for encryption.

- `kms:ListAliases` – To view keys in the Lambda console.
- `kms:CreateGrant`, `kms:Encrypt` – To configure a customer managed key on a function.
- `kms:Decrypt` – To view and manage environment variables that are encrypted with a customer managed key.

You can get these permissions from your AWS account or from a key's resource-based permissions policy. `ListAliases` is provided by the [managed policies for Lambda](#). Key policies grant the remaining permissions to users in the **Key users** group.

Users without `Decrypt` permissions can still manage functions, but they can't view environment variables or manage them in the Lambda console. To prevent a user from viewing environment variables, add a statement to the user's permissions that denies access to the default key, a customer managed key, or all keys.

Example IAM policy – Deny access by key ARN

```
{
  "Version": "2012-10-17",
  "Statement": [
    {
      "Sid": "VisualEditor0",
      "Effect": "Deny",
      "Action": [
        "kms:Decrypt"
      ],
      "Resource": "arn:aws:kms:us-east-2:111122223333:key/3be10e2d-xmpl-4be4-
bc9d-0405a71945cc"
    }
  ]
}
```

For details on managing key permissions, see [Key policies in AWS KMS](#) in the *AWS Key Management Service Developer Guide*.

Retrieving Lambda environment variables

To retrieve environment variables in your function code, use the standard method for your programming language.

Node.js

```
let region = process.env.AWS_REGION
```

Python

```
import os
```

```
region = os.environ['AWS_REGION']
```

Note

In some cases, you may need to use the following format:

```
region = os.environ.get('AWS_REGION')
```

Ruby

```
region = ENV["AWS_REGION"]
```

Java

```
String region = System.getenv("AWS_REGION");
```

Go

```
var region = os.Getenv("AWS_REGION")
```

C#

```
string region = Environment.GetEnvironmentVariable("AWS_REGION");
```

PowerShell

```
$region = $env:AWS_REGION
```

Lambda stores environment variables securely by encrypting them at rest. You can [configure Lambda to use a different encryption key](#), encrypt environment variable values on the client side, or set environment variables in an AWS CloudFormation template with AWS Secrets Manager.

Giving Lambda functions access to resources in an Amazon VPC

With Amazon Virtual Private Cloud (Amazon VPC), you can create private networks in your AWS account to host resources such as Amazon Elastic Compute Cloud (Amazon EC2) instances, Amazon Relational Database Service (Amazon RDS) instances, and Amazon ElastiCache instances. You can give your Lambda function access to resources hosted in an Amazon VPC by attaching your function to the VPC through the private subnets that contain the resources. Follow the instructions in the following sections to attach a Lambda function to an Amazon VPC using the Lambda console, the AWS Command Line Interface (AWS CLI), or AWS SAM.

Note

Every Lambda function runs inside a VPC that is owned and managed by the Lambda service. These VPCs are maintained automatically by Lambda and are not visible to customers. Configuring your function to access other AWS resources in an Amazon VPC has no effect on the Lambda-managed VPC your function runs inside.

Sections

- [Required IAM permissions](#)
- [Attaching Lambda functions to an Amazon VPC in your AWS account](#)
- [Internet access when attached to a VPC](#)
- [IPv6 support](#)
- [Best practices for using Lambda with Amazon VPCs](#)
- [Understanding Hyperplane Elastic Network Interfaces \(ENIs\)](#)
- [Using IAM condition keys for VPC settings](#)
- [VPC tutorials](#)

Required IAM permissions

To attach a Lambda function to an Amazon VPC in your AWS account, Lambda needs permissions to create and manage the network interfaces it uses to give your function access to the resources in the VPC.

The network interfaces that Lambda creates are known as Hyperplane Elastic Network Interfaces, or Hyperplane ENIs. To learn more about these network interfaces, see [the section called “Understanding Hyperplane Elastic Network Interfaces \(ENIs\)”](#).

You can give your function the permissions it needs by attaching the AWS [managed policy **AWSLambdaVPCLambdaAccessExecutionRole**](#) to your function's execution role. When you create a new function in the Lambda console and attach it to a VPC, Lambda automatically adds this permissions policy for you.

If you prefer to create your own IAM permissions policy, make sure to add all of the following permissions:

- **ec2:CreateNetworkInterface**
- **ec2:DescribeNetworkInterfaces** – This action only works if it's allowed on all resources ("Resource": "*").
- **ec2:DescribeSubnets**
- **ec2>DeleteNetworkInterface** – If you don't specify a resource ID for **DeleteNetworkInterface** in the execution role, your function may not be able to access the VPC. Either specify a unique resource ID, or include all resource IDs, for example, "Resource": "arn:aws:ec2:us-west-2:123456789012:*/*".
- **ec2:AssignPrivateIpAddresses**
- **ec2:UnassignPrivateIpAddresses**

Note that your function's role only needs these permissions to create the network interfaces, not to invoke your function. You can still invoke your function successfully when it's attached to an Amazon VPC, even if you remove these permissions from your function's execution role.

To attach your function to a VPC, Lambda also needs to verify network resources using your IAM user role. Ensure that your user role has the following IAM permissions:

- **ec2:DescribeSecurityGroups**
- **ec2:DescribeSubnets**
- **ec2:DescribeVpcs**
- **ec2:getSecurityGroupForVpc**

Note

The Amazon EC2 permissions that you grant to your function's execution role are used by the Lambda service to attach your function to a VPC. However, you're also implicitly granting these permissions to your function's code. This means that your function code is able to make these Amazon EC2 API calls. For advice on following security best practices, see [the section called "Security best practices"](#).

Attaching Lambda functions to an Amazon VPC in your AWS account

Attach your function to an Amazon VPC in your AWS account by using the Lambda console, the AWS CLI or AWS SAM. If you're using the AWS CLI or AWS SAM, or attaching an existing function to a VPC using the Lambda console, make sure that your function's execution role has the necessary permissions listed in the previous section.

Lambda functions can't connect directly to a VPC with [dedicated instance tenancy](#). To connect to resources in a dedicated VPC, [peer it to a second VPC with default tenancy](#).

Lambda console

To attach a function to an Amazon VPC when you create it

1. Open the [Functions page](#) of the Lambda console and choose **Create function**.
2. Under **Basic information**, for **Function name**, enter a name for your function.
3. Configure VPC settings for the function by doing the following:
 - a. Expand **Advanced settings**.
 - b. Select **Enable VPC**, and then select the VPC you want to attach the function to.
 - c. (Optional) To allow [outbound IPv6 traffic](#), select **Allow IPv6 traffic for dual-stack subnets**.
 - d. Choose the subnets and security groups to create the network interface for. If you selected **Allow IPv6 traffic for dual-stack subnets**, all selected subnets must have an IPv4 CIDR block and an IPv6 CIDR block.

Note

To access private resources, connect your function to private subnets. If your function needs internet access, see [the section called “Internet access for VPC functions”](#). Connecting a function to a public subnet doesn't give it internet access or a public IP address.

4. Choose **Create function**.

To attach an existing function to an Amazon VPC

1. Open the [Functions page](#) of the Lambda console and select your function.
2. Choose the **Configuration** tab, then choose **VPC**.
3. Choose **Edit**.
4. Under **VPC**, select the Amazon VPC you want to attach your function to.
5. (Optional) To allow [outbound IPv6 traffic](#), select **Allow IPv6 traffic for dual-stack subnets**.
6. Choose the subnets and security groups to create the network interface for. If you selected **Allow IPv6 traffic for dual-stack subnets**, all selected subnets must have an IPv4 CIDR block and an IPv6 CIDR block.

Note

To access private resources, connect your function to private subnets. If your function needs internet access, see [the section called “Internet access for VPC functions”](#). Connecting a function to a public subnet doesn't give it internet access or a public IP address.

7. Choose **Save**.

AWS CLI**To attach a function to an Amazon VPC when you create it**

- To create a Lambda function and attach it to a VPC, run the following CLI create-function command.

```
aws lambda create-function --function-name my-function \  
--runtime nodejs22.x --handler index.js --zip-file fileb://function.zip \  
--role arn:aws:iam::123456789012:role/lambda-role \  
--vpc-config  
  Ipv6AllowedForDualStack=true,SubnetIds=subnet-071f712345678e7c8,subnet-07fd123456788a03
```

Specify your own subnets and security groups and set `Ipv6AllowedForDualStack` to `true` or `false` according to your use case.

To attach an existing function to an Amazon VPC

- To attach an existing function to a VPC, run the following CLI `update-function-configuration` command.

```
aws lambda update-function-configuration --function-name my-function \  
--vpc-config Ipv6AllowedForDualStack=true,  
  SubnetIds=subnet-071f712345678e7c8,subnet-07fd123456788a036,SecurityGroupIds=sg-0859123
```

To unattach your function from a VPC

- To unattach your function from a VPC, run the following `update-function-configurationCLI` command with an empty list of VPC subnets and security groups.

```
aws lambda update-function-configuration --function-name my-function \  
--vpc-config SubnetIds=[],SecurityGroupIds=[]
```

AWS SAM

To attach your function to a VPC

- To attach a Lambda function to an Amazon VPC, add the `VpcConfig` property to your function definition as shown in the following example template. For more information about this property, see [AWS::Lambda::Function VpcConfig](#) in the *AWS CloudFormation User Guide* (the AWS SAM `VpcConfig` property is passed directly to the `VpcConfig` property of an AWS CloudFormation `AWS::Lambda::Function` resource).

```
AWSTemplateFormatVersion: '2010-09-09'  
Transform: AWS::Serverless-2016-10-31
```

Resources:**MyFunction:**

```
Type: AWS::Serverless::Function
```

Properties:

```
CodeUri: ./lambda_function/
```

```
Handler: lambda_function.handler
```

```
Runtime: python3.12
```

VpcConfig:

```
SecurityGroupIds:
```

- !Ref MySecurityGroup

```
SubnetIds:
```

- !Ref MySubnet1

- !Ref MySubnet2

Policies:

- AWSLambdaVPCLambdaAccessExecutionRole

MySecurityGroup:

```
Type: AWS::EC2::SecurityGroup
```

Properties:

```
GroupDescription: Security group for Lambda function
```

```
VpcId: !Ref MyVPC
```

MySubnet1:

```
Type: AWS::EC2::Subnet
```

Properties:

```
VpcId: !Ref MyVPC
```

```
CidrBlock: 10.0.1.0/24
```

MySubnet2:

```
Type: AWS::EC2::Subnet
```

Properties:

```
VpcId: !Ref MyVPC
```

```
CidrBlock: 10.0.2.0/24
```

MyVPC:

```
Type: AWS::EC2::VPC
```

Properties:

```
CidrBlock: 10.0.0.0/16
```

For more information about configuring your VPC in AWS SAM, see [AWS::EC2::VPC](#) in the *AWS CloudFormation User Guide*.

Internet access when attached to a VPC

By default, Lambda functions have access to the public internet. When you attach your function to a VPC, it can only access resources available within that VPC. To give your function access to the internet, you also need to configure the VPC to have internet access. To learn more, see [the section called “Internet access for VPC functions”](#).

IPv6 support

Your function can connect to resources in dual-stack VPC subnets over IPv6. This option is turned off by default. To allow outbound IPv6 traffic, use the console or the `--vpc-config Ipv6AllowedForDualStack=true` option with the [create-function](#) or [update-function-configuration](#) command.

Note

To allow outbound IPv6 traffic in a VPC, all of the subnets that are connected to the function must be dual-stack subnets. Lambda doesn't support outbound IPv6 connections for IPv6-only subnets in a VPC, outbound IPv6 connections for functions that are not connected to a VPC, or inbound IPv6 connections using VPC endpoints (AWS PrivateLink).

You can update your function code to explicitly connect to subnet resources over IPv6. The following Python example opens a socket and connects to an IPv6 server.

Example — Connect to IPv6 server

```
def connect_to_server(event, context):
    server_address = event['host']
    server_port = event['port']
    message = event['message']
    run_connect_to_server(server_address, server_port, message)

def run_connect_to_server(server_address, server_port, message):
    sock = socket.socket(socket.AF_INET6, socket.SOCK_STREAM, 0)
```

```
try:
    # Send data
    sock.connect((server_address, int(server_port), 0, 0))
    sock.sendall(message.encode())
    BUFF_SIZE = 4096
    data = b''
    while True:
        segment = sock.recv(BUFF_SIZE)
        data += segment
        # Either 0 or end of data
        if len(segment) < BUFF_SIZE:
            break
    return data
finally:
    sock.close()
```

Best practices for using Lambda with Amazon VPCs

To ensure that your Lambda VPC configuration meets best practice guidelines, follow the advice in the following sections.

Security best practices

To attach your Lambda function to a VPC, you need to give your function's execution role a number of Amazon EC2 permissions. These permissions are required to create the network interfaces your function uses to access the resources in the VPC. However, these permissions are also implicitly granted to your function's code. This means that your function code has permission to make these Amazon EC2 API calls.

To follow the principle of least-privilege access, add a deny policy like the following example to your function's execution role. This policy prevents your function from making calls to the Amazon EC2 APIs that the Lambda service uses to attach your function to a VPC.

```
{
  "Version": "2012-10-17",
  "Statement": [
    {
      "Effect": "Deny",
      "Action": [
        "ec2:CreateNetworkInterface",
        "ec2>DeleteNetworkInterface",
```



```
        "ec2:DescribeNetworkInterfaces",
        "ec2:DescribeSubnets",
        "ec2:DetachNetworkInterface",
        "ec2:AssignPrivateIpAddresses",
        "ec2:UnassignPrivateIpAddresses"
    ],
    "Resource": [ "*" ],
    "Condition": {
        "ArnEquals": {
            "lambda:SourceFunctionArn": [
                "arn:aws:lambda:us-west-2:123456789012:function:my_function"
            ]
        }
    }
}
]
```

AWS provides [security groups](#) and [network Access Control Lists \(ACLs\)](#) to increase security in your VPC. Security groups control inbound and outbound traffic for your resources, and network ACLs control inbound and outbound traffic for your subnets. Security groups provide enough access control for most subnets. You can use network ACLs if you want an additional layer of security for your VPC. For general guidelines on security best practices when using Amazon VPCs, see [Security best practices for your VPC](#) in the *Amazon Virtual Private Cloud User Guide*.

Performance best practices

When you attach your function to a VPC, Lambda checks to see if there is an available network resource (Hyperplane ENI) it can use to connect to. Hyperplane ENIs are associated with a particular combination of security groups and VPC subnets. If you've already attached one function to a VPC, specifying the same subnets and security groups when you attach another function means that Lambda can share the network resources and avoid the need to create a new Hyperplane ENI. For more information about Hyperplane ENIs and their lifecycle, see [the section called "Understanding Hyperplane Elastic Network Interfaces \(ENIs\)"](#).

Understanding Hyperplane Elastic Network Interfaces (ENIs)

A Hyperplane ENI is a managed resource that acts as a network interface between your Lambda function and the resources you want your function to connect to. The Lambda service creates and manages these ENIs automatically when you attach your function to a VPC.

Hyperplane ENIs are not directly visible to you, and you don't need to configure or manage them. However, knowing how they work can help you to understand your function's behavior when you attach it to a VPC.

The first time you attach a function to a VPC using a particular subnet and security group combination, Lambda creates a Hyperplane ENI. Other functions in your account that use the same subnet and security group combination can also use this ENI. Wherever possible, Lambda reuses existing ENIs to optimize resource utilization and minimize the creation of new ENIs. Each Hyperplane ENI supports up to 65,000 connections/ports. If the number of connections exceeds this limit, Lambda scales the number of ENIs automatically based on network traffic and concurrency requirements.

For new functions, while Lambda is creating a Hyperplane ENI, your function remains in the Pending state and you can't invoke it. Your function transitions to the Active state only when the Hyperplane ENI is ready, which can take several minutes. For existing functions, you can't perform additional operations that target the function, such as creating versions or updating the function's code, but you can continue to invoke previous versions of the function.

Note

As part of managing the ENI lifecycle, Lambda may delete and recreate ENIs to load balance network traffic across ENIs or to address issues found in ENI health-checks. Additionally, if a Lambda function remains idle for 30 days, Lambda reclaims any unused Hyperplane ENIs and sets the function state to idle. The next invocation attempt will fail, and the function re-enters the Pending state until Lambda completes the creation or allocation of a Hyperplane ENI.

We recommend that your design doesn't rely on the persistence of ENIs.

Using IAM condition keys for VPC settings

You can use Lambda-specific condition keys for VPC settings to provide additional permission controls for your Lambda functions. For example, you can require that all functions in your organization are connected to a VPC. You can also specify the subnets and security groups that the function's users can and can't use.

Lambda supports the following condition keys in IAM policies:

- **lambda:VpcIds** – Allow or deny one or more VPCs.

- **lambda:SubnetIds** – Allow or deny one or more subnets.
- **lambda:SecurityGroupIds** – Allow or deny one or more security groups.

The Lambda API operations [CreateFunction](#) and [UpdateFunctionConfiguration](#) support these condition keys. For more information about using condition keys in IAM policies, see [IAM JSON Policy Elements: Condition](#) in the *IAM User Guide*.

Tip

If your function already includes a VPC configuration from a previous API request, you can send an `UpdateFunctionConfiguration` request without the VPC configuration.

Example policies with condition keys for VPC settings

The following examples demonstrate how to use condition keys for VPC settings. After you create a policy statement with the desired restrictions, append the policy statement for the target user or role.

Ensure that users deploy only VPC-connected functions

To ensure that all users deploy only VPC-connected functions, you can deny function create and update operations that don't include a valid VPC ID.

Note that VPC ID is not an input parameter to the `CreateFunction` or `UpdateFunctionConfiguration` request. Lambda retrieves the VPC ID value based on the subnet and security group parameters.

```
{
  "Version": "2012-10-17",
  "Statement": [
    {
      "Sid": "EnforceVPCFunction",
      "Action": [
        "lambda:CreateFunction",
        "lambda:UpdateFunctionConfiguration"
      ],
      "Effect": "Deny",
      "Resource": "*",
      "Condition": {
```

```
    "Null": {
      "lambda:VpcIds": "true"
    }
  }
}
]
```

Deny users access to specific VPCs, subnets, or security groups

To deny users access to specific VPCs, use `StringEquals` to check the value of the `lambda:VpcIds` condition. The following example denies users access to `vpc-1` and `vpc-2`.

```
{
  "Version": "2012-10-17",
  "Statement": [
    {
      "Sid": "EnforceOutOfVPC",
      "Action": [
        "lambda:CreateFunction",
        "lambda:UpdateFunctionConfiguration"
      ],
      "Effect": "Deny",
      "Resource": "*",
      "Condition": {
        "StringEquals": {
          "lambda:VpcIds": ["vpc-1", "vpc-2"]
        }
      }
    }
  ]
}
```

To deny users access to specific subnets, use `StringEquals` to check the value of the `lambda:SubnetIds` condition. The following example denies users access to `subnet-1` and `subnet-2`.

```
{
  "Sid": "EnforceOutOfSubnet",
  "Action": [
    "lambda:CreateFunction",
    "lambda:UpdateFunctionConfiguration"
  ]
}
```

```

    ],
    "Effect": "Deny",
    "Resource": "*",
    "Condition": {
      "ForAnyValue:StringEquals": {
        "lambda:SubnetIds": ["subnet-1", "subnet-2"]
      }
    }
  }
}

```

To deny users access to specific security groups, use `StringEquals` to check the value of the `lambda:SecurityGroupIds` condition. The following example denies users access to `sg-1` and `sg-2`.

```

{
  "Sid": "EnforceOutOfSecurityGroups",
  "Action": [
    "lambda:CreateFunction",
    "lambda:UpdateFunctionConfiguration"
  ],
  "Effect": "Deny",
  "Resource": "*",
  "Condition": {
    "ForAnyValue:StringEquals": {
      "lambda:SecurityGroupIds": ["sg-1", "sg-2"]
    }
  }
}
]
}

```

Allow users to create and update functions with specific VPC settings

To allow users to access specific VPCs, use `StringEquals` to check the value of the `lambda:VpcIds` condition. The following example allows users to access `vpc-1` and `vpc-2`.

```

{
  "Version": "2012-10-17",
  "Statement": [
    {

```

```

    "Sid": "EnforceStayInSpecificVpc",
    "Action": [
        "lambda:CreateFunction",
        "lambda:UpdateFunctionConfiguration"
    ],
    "Effect": "Allow",
    "Resource": "*",
    "Condition": {
        "StringEquals": {
            "lambda:VpcIds": ["vpc-1", "vpc-2"]
        }
    }
}

```

To allow users to access specific subnets, use `StringEquals` to check the value of the `lambda:SubnetIds` condition. The following example allows users to access subnet-1 and subnet-2.

```

{
    "Sid": "EnforceStayInSpecificSubnets",
    "Action": [
        "lambda:CreateFunction",
        "lambda:UpdateFunctionConfiguration"
    ],
    "Effect": "Allow",
    "Resource": "*",
    "Condition": {
        "ForAllValues:StringEquals": {
            "lambda:SubnetIds": ["subnet-1", "subnet-2"]
        }
    }
}

```

To allow users to access specific security groups, use `StringEquals` to check the value of the `lambda:SecurityGroupIds` condition. The following example allows users to access sg-1 and sg-2.

```

{
    "Sid": "EnforceStayInSpecificSecurityGroup",
    "Action": [

```

```
        "lambda:CreateFunction",
        "lambda:UpdateFunctionConfiguration"
    ],
    "Effect": "Allow",
    "Resource": "*",
    "Condition": {
        "ForAllValues:StringEquals": {
            "lambda:SecurityGroupIds": ["sg-1", "sg-2"]
        }
    }
}
]
```

VPC tutorials

In the following tutorials, you connect a Lambda function to resources in your VPC.

- [Tutorial: Using a Lambda function to access Amazon RDS in an Amazon VPC](#)
- [Tutorial: Configuring a Lambda function to access Amazon ElastiCache in an Amazon VPC](#)

Giving Lambda functions access to a resource in an Amazon VPC in another account

You can give your AWS Lambda function access to a resource in a Amazon VPC in Amazon Virtual Private Cloud managed by another account, without exposing either VPC to the internet. This access pattern allows you to share data with other organizations using AWS. Using this access pattern, you can share data between VPCs with a greater level of security and performance than over the internet. Configure your Lambda function to use a Amazon VPC peering connection to access these resources.

Warning

When you allow access between accounts or VPCs, check that your plan meets the security requirements of the respective organizations that manage these accounts. Following the instructions in this document will affect the security posture of your resources.

In this tutorial, you connect two accounts together with a peering connection using IPv4. You configure a Lambda function that is not already connected to a Amazon VPC. You configure DNS resolution to connect your function to resources that do not provide static IPs. To adapt these instructions to other peering scenarios, consult the [VPC Peering Guide](#).

Prerequisites

To give a Lambda function access to a resource in another account, you must have:

- A Lambda function, configured to authenticate with and then read from your resource.
- A resource in another account, such as an Amazon RDS cluster, available through Amazon VPC.
- Credentials for your Lambda function's account and your resource's account. If you are not authorized to use your resource's account, contact an authorized user to prepare that account.
- Permission to create and update a VPC (and supporting Amazon VPC resources) to associate with your Lambda function.
- Permission to update the execution role and VPC configuration for your Lambda function.
- Permission to create a VPC peering connection in your Lambda function's account.
- Permission to accept a VPC peering connection in your resource's account.

- Permission to update the configuration of your resource's VPC (and supporting Amazon VPC resources).
- Permission to invoke your Lambda function.

Create an Amazon VPC in your function's account

Create an Amazon VPC, subnets, route tables, and a security group in your Lambda function's account.

To create a VPC, subnets, and other VPC resources using the console

1. Open the Amazon VPC Console at <https://console.aws.amazon.com/vpc/>.
2. On the dashboard, choose **Create VPC**.
3. For **IPv4 CIDR block**, provide a private CIDR block. Your CIDR block must not overlap with blocks used in your resource's VPC. Don't pick a block your resources' VPC uses to assign IPs to resources or a block already defined in the route tables in your resources VPC. For more information about defining appropriate CIDR blocks, see [VPC CIDR blocks](#).
4. Choose **Customize AZs**.
5. Select the same AZs as your resource.
6. For **Number of public subnets**, choose **0**.
7. For **VPC endpoints**, choose **None**.
8. Choose **Create VPC**.

Grant VPC permissions to your function's execution role

Attach [AWSLambdaVPCAccessExecutionRole](#) to your function's execution role to allow it to connect to VPCs.

To grant VPC permissions to your function's execution role

1. Open the [Functions page](#) of the Lambda console.
2. Choose the name of your function.
3. Choose **Configuration**.
4. Choose **Permissions**.

5. Under **Role name**, choose the execution role.
6. In the **Permissions policies** section, choose **Add permissions**.
7. In the dropdown list, choose **Attach policies**.
8. In the search box, enter `AWSLambdaVPCAccessExecutionRole`.
9. To the left of the policy name, choose the checkbox.
10. Choose **Add permissions**.

To attach your function to your Amazon VPC

1. Open the [Functions page](#) of the Lambda console.
2. Choose the name of your function.
3. Choose the **Configuration** tab, then choose **VPC**.
4. Choose **Edit**.
5. Under **VPC**, select your VPC
6. Under **Subnets**, choose your subnets.
7. Under **Security groups**, choose the default security group for your VPC.
8. Choose **Save**.

Create a VPC peering connection request

Create a VPC peering connection request from your function's VPC (the requester VPC) to your resource's VPC (the acceptor VPC).

To request a VPC peering connection from your function's VPC

1. Open the <https://console.aws.amazon.com/vpc/>.
2. In the navigation pane, choose **Peering connections**.
3. Choose **Create peering connection**.
4. For **VPC ID (Requester)**, select your function's VPC.
5. For **Account ID**, enter the ID of your resource's account.
6. For **VPC ID (Acceptor)**, enter your resource's VPC.

Prepare your resource's account

To create your peering connection and prepare your resource's VPC to use the connection, log in to your resource's account with a role that holds the permissions listed in the prerequisites. The steps to log in may be different based on how the account is secured. For more information about how to sign in to an AWS account, see the [AWS Sign-in User Guide](#). In your resource's account, perform the following procedures.

To accept the VPC peering connection request

1. Open the <https://console.aws.amazon.com/vpc/>.
2. In the navigation pane, choose **Peering connections**.
3. Select the pending VPC peering connection (the status is pending-acceptance).
4. Choose **Actions**
5. From the dropdown list, choose **Accept request**.
6. When prompted for confirmation, choose **Accept request**.
7. Choose **Modify my route tables now** to add a route to the main route table for your VPC so that you can send and receive traffic across the peering connection.

Inspect the route tables for the resource's VPC. The route generated by Amazon VPC might not establish connectivity, based on how your resource's VPC is set up. Check for conflicts between the new route and existing configuration for the VPC. For more information about troubleshooting, see [Troubleshoot a VPC peering connection](#) in the *Amazon Virtual Private Cloud VPC Peering Guide*.

To update the security group for your resource

1. Open the <https://console.aws.amazon.com/vpc/>.
2. In the navigation pane, choose **Security groups**.
3. Select the security group for your resource.
4. Choose **Actions**.
5. From the dropdown list, choose **Edit inbound rules**.
6. Choose **Add rule**.
7. For **Source** enter your function's account ID and security group ID, separated by a forward slash (for example, 111122223333/sg-1a2b3c4d).
8. Choose **Edit outbound rules**.

9. Check whether outbound traffic is restricted. Default VPC settings allow all outbound traffic. If outbound traffic is restricted, continue to the next step.
10. Choose **Add rule**.
11. For **Destination** enter your function's account ID and security group ID, separated by a forward slash (for example, 111122223333/sg-1a2b3c4d).
12. Choose **Save rules**.

To enable DNS resolution for your peering connection

1. Open the <https://console.aws.amazon.com/vpc/>.
2. In the navigation pane, choose **Peering connections**.
3. Select your peering connection.
4. Choose **Actions**.
5. Choose **Edit DNS settings**.
6. Below **Accepter DNS resolution**, select **Allow requester VPC to resolve DNS of accepter VPC hosts to private IP**.
7. Choose **Save changes**.

Update VPC configuration in your function's account

Log in to your function's account, then update the VPC configuration.

To add a route for your VPC peering connection

1. Open the <https://console.aws.amazon.com/vpc/>.
2. In the navigation pane, choose **Route tables**.
3. Select the check box next to the name of the route table for the subnet you associated with your function.
4. Choose **Actions**.
5. Choose **Edit routes**.
6. Choose **Add route**.
7. For **Destination**, enter the CIDR block for your resource's VPC.
8. For **Target**, select your VPC peering connection.
9. Choose **Save changes**.

For more information about considerations you may encounter while updating your route tables, consult [Update your route tables for a VPC peering connection](#).

To update the security group for your Lambda function

1. Open the <https://console.aws.amazon.com/vpc/>.
2. In the navigation pane, choose **Security groups**.
3. Choose **Actions**.
4. Choose **Edit inbound rules**.
5. Choose **Add rule**.
6. For **Source** enter your resource's account ID and security group ID, separated by a forward slash (for example, 111122223333/sg-1a2b3c4d).
7. Choose **Save rules**.

To enable DNS resolution for your peering connection

1. Open the <https://console.aws.amazon.com/vpc/>.
2. In the navigation pane, choose **Peering connections**.
3. Select your peering connection.
4. Choose **Actions**.
5. Choose **Edit DNS settings**.
6. Below **Requester DNS resolution**, select **Allow accepter VPC to resolve DNS of requester VPC hosts to private IP**.
7. Choose **Save changes**.

Test your function

To create a test event and inspect your function's output

1. In the **Code source** pane, choose **Test**.
2. Select **Create new event**.
3. In the **Event JSON** panel, replace the default values with an input appropriate for your Lambda function.
4. Choose **Invoke**.

5. In the **Execution results** tab, confirm that **Response** contains your expected output.

Additionally, you can check your function's logs to verify the logs are as you expect.

To view your function's invocation records in CloudWatch Logs

1. Choose the **Monitor** tab.
2. Choose **View CloudWatch logs**.
3. In the **Log streams** tab, choose the log stream for your function's invocation.
4. Confirm your logs are as you expect.

Enable internet access for VPC-connected Lambda functions

By default, Lambda functions run in a Lambda-managed VPC that has internet access. To access resources in a VPC in your account, you can add a VPC configuration to a function. This restricts the function to resources within that VPC, unless the VPC has internet access. This page explains how to provide internet access to VPC-connected Lambda functions.

I don't have a VPC yet

Create the VPC

The **Create VPC workflow** creates all VPC resources required for a Lambda function to access the public internet from a private subnet, including subnets, NAT gateway, internet gateway, and route table entries.

To create the VPC

1. Open the Amazon VPC console at <https://console.aws.amazon.com/vpc/>.
2. On the dashboard, choose **Create VPC**.
3. For **Resources to create**, choose **VPC and more**.
4. **Configure the VPC**
 - a. For **Name tag auto-generation**, enter a name for the VPC.
 - b. For **IPv4 CIDR block**, you can keep the default suggestion, or alternatively you can enter the CIDR block required by your application or network.
 - c. If your application communicates by using IPv6 addresses, choose **IPv6 CIDR block, Amazon-provided IPv6 CIDR block**.
5. **Configure the subnets**
 - a. For **Number of Availability Zones**, choose **2**. We recommend at least two AZs for high availability.
 - b. For **Number of public subnets**, choose **2**.
 - c. For **Number of private subnets**, choose **2**.
 - d. You can keep the default CIDR block for the public subnet, or alternatively you can expand **Customize subnet CIDR blocks** and enter a CIDR block. For more information, see [Subnet CIDR blocks](#).
6. For **NAT gateways**, choose **1 per AZ** to improve resiliency.

7. For **Egress only internet gateway**, choose **Yes** if you opted to include an IPv6 CIDR block.
8. For **VPC endpoints**, keep the default (**S3 Gateway**). There is no cost for this option. For more information, see [Types of VPC endpoints for Amazon S3](#).
9. For **DNS options**, keep the default settings.
10. Choose **Create VPC**.

Configure the Lambda function

To configure a VPC when you create a function

1. Open the [Functions page](#) of the Lambda console.
2. Choose **Create function**.
3. Under **Basic information**, for **Function name**, enter a name for your function.
4. Expand **Advanced settings**.
5. Select **Enable VPC**, and then choose a VPC.
6. (Optional) To allow [outbound IPv6 traffic](#), select **Allow IPv6 traffic for dual-stack subnets**.
7. For **Subnets**, select all private subnets. The private subnets can access the internet through the NAT gateway. Connecting a function to a public subnet doesn't give it internet access.

Note

If you selected **Allow IPv6 traffic for dual-stack subnets**, all selected subnets must have an IPv4 CIDR block and an IPv6 CIDR block.

8. For **Security groups**, select a security group that allows outbound traffic.
9. Choose **Create function**.

Lambda automatically creates an execution role with the [AWSLambdaVPCAccessExecutionRole](#) AWS managed policy. The permissions in this policy are required only to create elastic network interfaces for the VPC configuration, not to invoke your function. To apply least-privilege permissions, you can remove the **AWSLambdaVPCAccessExecutionRole** policy from your execution role after you create the function and VPC configuration. For more information, see [Required IAM permissions](#).

To configure a VPC for an existing function

To add a VPC configuration to an existing function, the function's execution role must have [permission to create and manage elastic network interfaces](#). The [AWSLambdaVPCAccessExecutionRole](#) AWS managed policy includes the required permissions. To apply least-privilege permissions, you can remove the **AWSLambdaVPCAccessExecutionRole** policy from your execution role after you create the VPC configuration.

1. Open the [Functions page](#) of the Lambda console.
2. Choose a function.
3. Choose the **Configuration** tab, and then choose **VPC**.
4. Under **VPC**, choose **Edit**.
5. Select the VPC.
6. (Optional) To allow [outbound IPv6 traffic](#), select **Allow IPv6 traffic for dual-stack subnets**.
7. For **Subnets**, select all private subnets. The private subnets can access the internet through the NAT gateway. Connecting a function to a public subnet doesn't give it internet access.

Note

If you selected **Allow IPv6 traffic for dual-stack subnets**, all selected subnets must have an IPv4 CIDR block and an IPv6 CIDR block.

8. For **Security groups**, select a security group that allows outbound traffic.
9. Choose **Save**.

Test the function

Use the following sample code to confirm that your VPC-connected function can reach the public internet. If successful, the code returns a 200 status code. If unsuccessful, the function times out.

Node.js

1. In the **Code source** pane on the Lambda console, paste the following code into the **index.mjs** file. The function makes an HTTP GET request to a public endpoint and returns the HTTP response code to test if the function has access to the public internet.

Code source [Info](#)

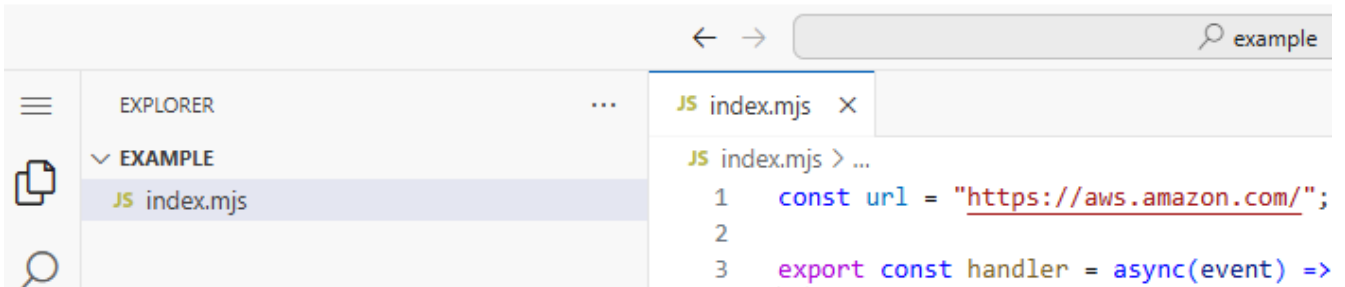

Example — HTTP request with async/await

```
const url = "https://aws.amazon.com/";

export const handler = async(event) => {
  try {
    // fetch is available with Node.js 18 and later runtimes
    const res = await fetch(url);
    console.info("status", res.status);
    return res.status;
  }
  catch (e) {
    console.error(e);
    return 500;
  }
};
```

2. In the **DEPLOY** section, choose **Deploy** to update your function's code:

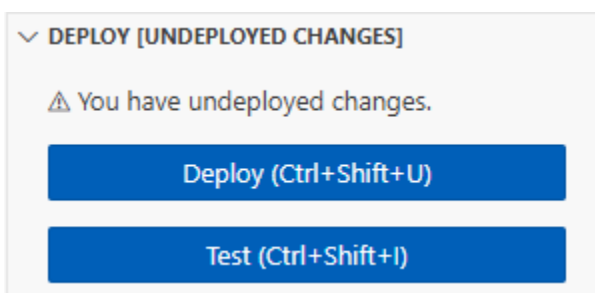

3. Choose the **Test** tab.

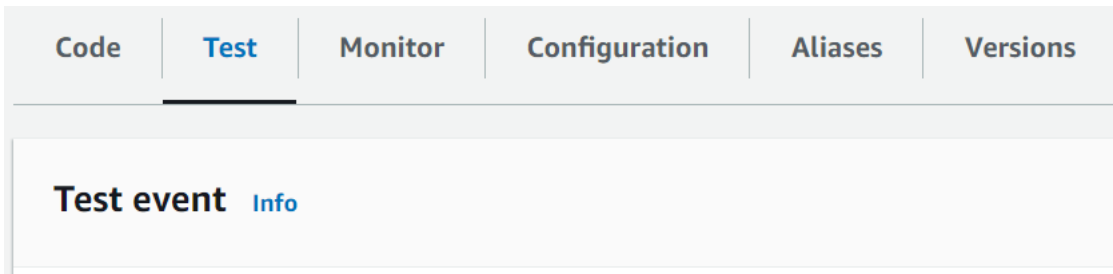

4. Choose **Test**.
5. The function returns a 200 status code. This means that the function has outbound internet access.

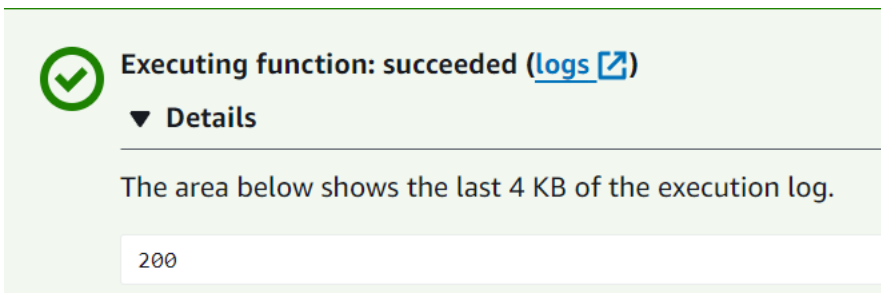

If the function can't reach the public internet, you get an error message like this:

```
{
  "errorMessage": "2024-04-11T17:22:20.857Z abe12jlc-640a-8157-0249-9be825c2y110
  Task timed out after 3.01 seconds"
}
```

Python

1. In the **Code source** pane on the Lambda console, paste the following code into the **lambda_function.py** file. The function makes an HTTP GET request to a public endpoint and returns the HTTP response code to test if the function has access to the public internet.

Code source [Info](#)

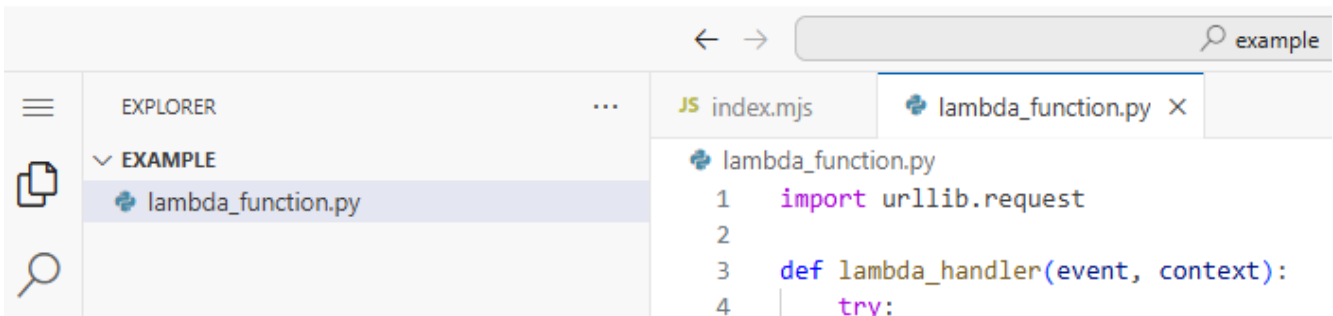

```

import urllib.request

def lambda_handler(event, context):
    try:
        response = urllib.request.urlopen('https://aws.amazon.com')
        status_code = response.getcode()
        print('Response Code:', status_code)
        return status_code
    except Exception as e:
        print('Error:', e)
        raise e

```

- In the **DEPLOY** section, choose **Deploy** to update your function's code:

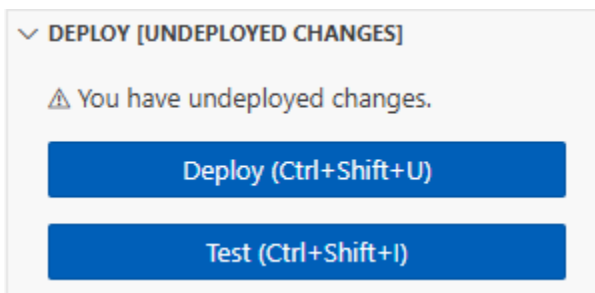

- Choose the **Test** tab.

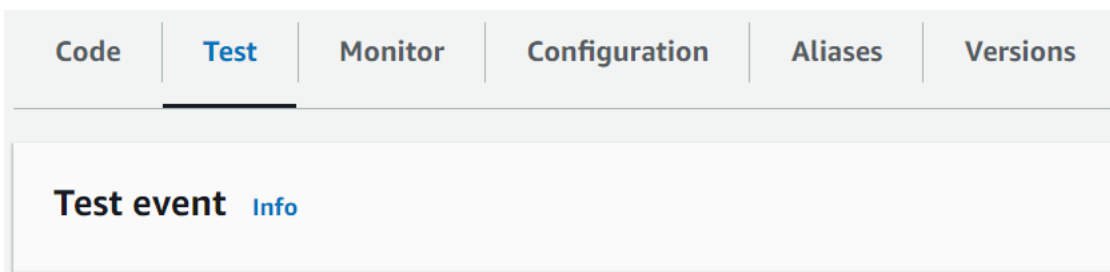

- Choose **Test**.

- The function returns a 200 status code. This means that the function has outbound internet access.

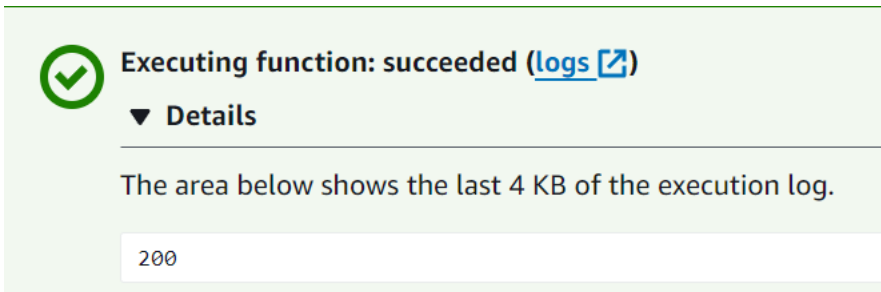

If the function can't reach the public internet, you get an error message like this:

```
{
  "errorMessage": "2024-04-11T17:22:20.857Z abe12jlc-640a-8157-0249-9be825c2y110
  Task timed out after 3.01 seconds"
}
```

I already have a VPC

If you already have a VPC but you need to configure public internet access for a Lambda function, follow these steps. This procedure assumes that your VPC has at least two subnets. If you don't have two subnets, see [Create a subnet](#) in the *Amazon VPC User Guide*.

Verify the route table configuration

- Open the Amazon VPC console at <https://console.aws.amazon.com/vpc/>.
- Choose the **VPC ID**.

The screenshot shows the "Your VPCs (3) Info" section of the Amazon VPC console. It features a search bar and a table with columns for Name, VPC ID, and State. Two VPCs are listed: one with a hyphen as a name and VPC ID "vpc-2", and another named "lambda-test-vpc" with VPC ID "vpc-0". Both are in an "Available" state.

<input type="checkbox"/>	Name	VPC ID	State
<input type="checkbox"/>	-	vpc-2	Available
<input type="checkbox"/>	lambda-test-vpc	vpc-0	Available

- Scroll down to the **Resource map** section. Note the route table mappings. Open each route table that is mapped to a subnet.

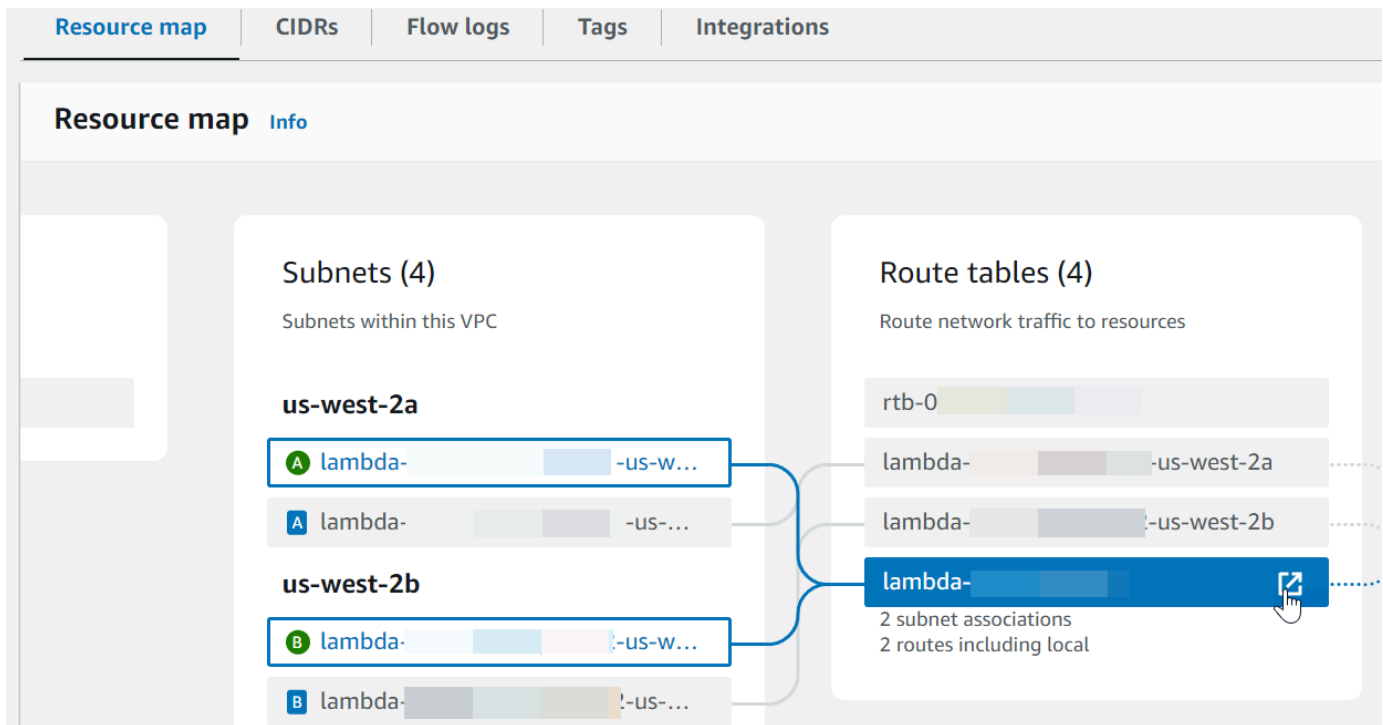

4. Scroll down to the **Routes** tab. Review the routes to determine if one of the following is true. Each of these requirements must be satisfied by a separate route table.
 - Internet-bound traffic ($0.0.0.0/0$ for IPv4, $::/0$ for IPv6) is routed to an internet gateway (`igw-xxxxxxxxxx`). This means that the subnet associated with the route table is a public subnet.

Note

If your subnet doesn't have an IPv6 CIDR block, you will only see the IPv4 route ($0.0.0.0/0$).

Example public subnet route table

Routes	Subnet associations	Edge associations	Route propagation	Tags
Routes (4)				
<input type="text" value="Filter routes"/>				
Destination	Target	Status		
::/0	igw-0	Active		
::/56	local	Active		
0.0.0.0/0	igw-0	Active		
/16	local	Active		

- Internet-bound traffic for IPv4 ($0.0.0.0/0$) is routed to a NAT gateway (`nat-xxxxxxxxxx`) that is associated with a public subnet. This means that the subnet is a private subnet that can access the internet through the NAT gateway.

Note

If your subnet has an IPv6 CIDR block, the route table must also route internet-bound IPv6 traffic ($::/0$) to an egress-only internet gateway (`eigw-xxxxxxxxxx`). If your subnet doesn't have an IPv6 CIDR block, you will only see the IPv4 route ($0.0.0.0/0$).

Example private subnet route table

Routes	Subnet associations	Edge associations	Route propagation	Tags
Routes (4)				
<input type="text" value="Filter routes"/>				
Destination	Target	Status		
::/0	eigw-0	Active		
::/56	local	Active		
0.0.0.0/0	nat-0	Active		
/16	local	Active		

- Repeat the previous step until you have reviewed each route table associated with a subnet in your VPC and confirmed that you have a route table with an internet gateway and a route table with a NAT gateway.

If you don't have two route tables, one with a route to an internet gateway and one with a route to a NAT gateway, follow these steps to create the missing resources and route table entries.

Create a route table

Follow these steps to create a route table and associate it with a subnet.

To create a custom route table using the Amazon VPC console

- Open the Amazon VPC console at <https://console.aws.amazon.com/vpc/>.
- In the navigation pane, choose **Route tables**.
- Choose **Create route table**.
- (Optional) For **Name**, enter a name for your route table.
- For **VPC**, choose your VPC.
- (Optional) To add a tag, choose **Add new tag** and enter the tag key and tag value.
- Choose **Create route table**.

8. On the **Subnet associations** tab, choose **Edit subnet associations**.

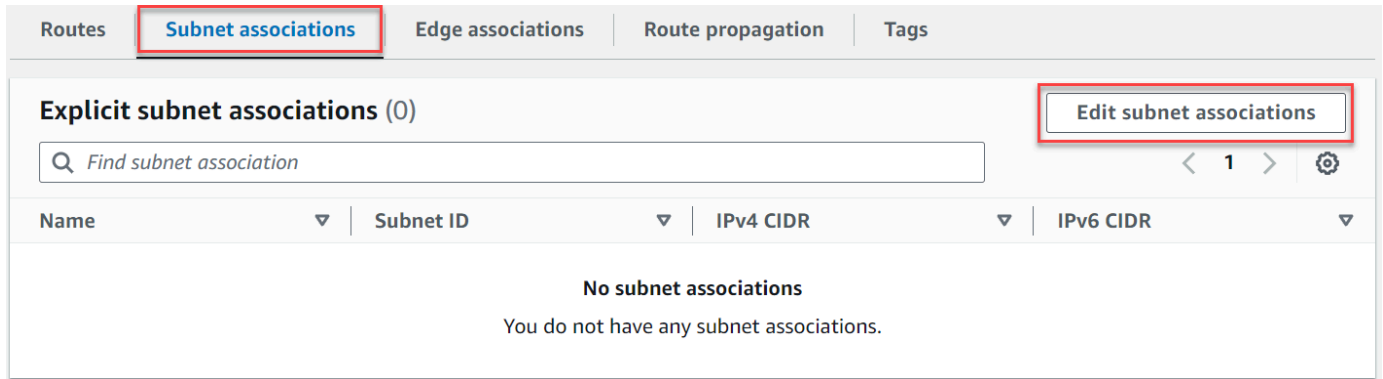

9. Select the check box for the subnet to associate with the route table.

10. Choose **Save associations**.

Create an internet gateway

Follow these steps to create an internet gateway, attach it to your VPC, and add it to your public subnet's route table.

To create an internet gateway

1. Open the Amazon VPC console at <https://console.aws.amazon.com/vpc/>.
2. In the navigation pane, choose **Internet gateways**.
3. Choose **Create internet gateway**.
4. (Optional) Enter a name for your internet gateway.
5. (Optional) To add a tag, choose **Add new tag** and enter the tag key and value.
6. Choose **Create internet gateway**.
7. Choose **Attach to a VPC** from the banner at the top of the screen, select an available VPC, and then choose **Attach internet gateway**.

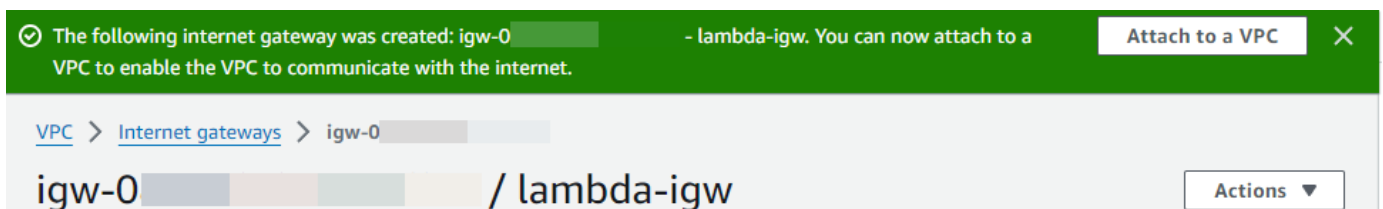

8. Choose the **VPC ID**.

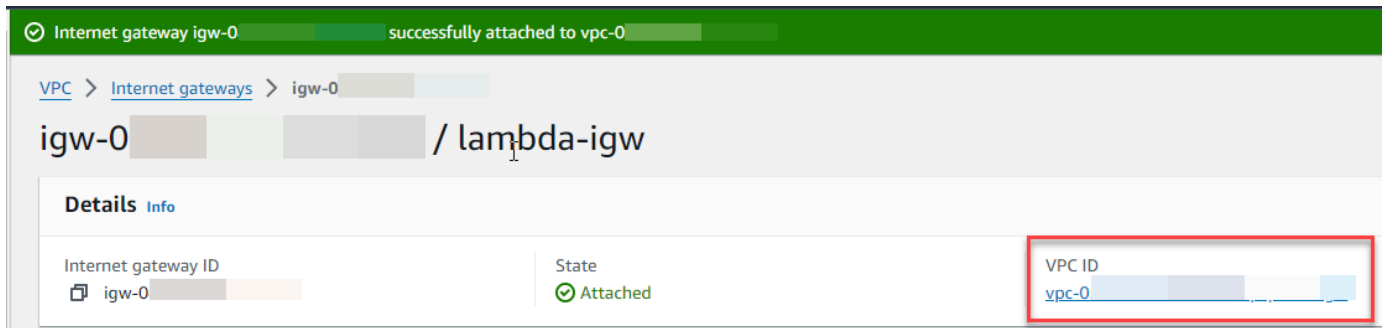

9. Choose the **VPC ID** again to open the VPC details page.

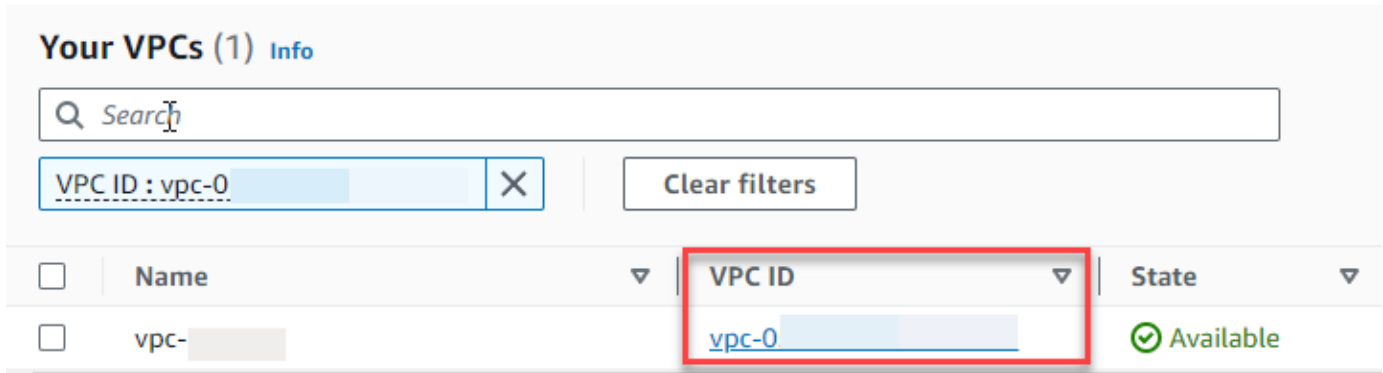

10. Scroll down to the **Resource map** section and then choose a subnet. The subnet details are displayed in a new tab.

The screenshot shows the AWS Resource map interface. At the top, there are navigation tabs: Resource map (selected), CIDRs, Flow logs, Tags, and Integrations. Below the tabs, the 'Resource map' section is active, with an 'Info' link. On the left, a 'VPC' card is visible with a 'Show details' link and the text 'Your AWS virtual network'. On the right, a 'Subnets (4)' card is shown, listing subnets within the VPC. The subnets are grouped by availability zone: 'us-west-2a' and 'us-west-2b'. Under 'us-west-2a', there are two subnets, the first of which is highlighted in blue and has a mouse cursor pointing to its 'Route table' link. Under 'us-west-2b', there are two subnets, the first of which is highlighted in green.

11. Choose the link under **Route table**.

The screenshot shows the AWS Subnet details page. The breadcrumb navigation is 'VPC > Subnets > subnet-'. The main heading is 'subnet-'. Below the heading, there is a 'Details' section. The details are organized into three columns. The first column contains: Subnet ID (subnet-), Available IPv4 addresses (4090), and Network border group (us-west-2). The second column contains: Subnet ARN (arn:aws:ec2:us-west-), IPv6 CIDR (-), and VPC. The third column contains: State (Available), Availability Zone (us-west-2b), and Route table (rtb-). The 'Route table' link is highlighted with a red box.

12. Choose the **Route table ID** to open the route table details page.

Route tables (1) Info

Find resources by attribute or tag

Route table ID : rtb-0 X Clear filters

<input type="checkbox"/>	Name	Route table ID
<input type="checkbox"/>	-	rtb-0

13. Under **Routes**, choose **Edit routes**.

Routes (1) Both Edit routes

Filter routes

Destination	Target	Status
10.0.0.0/24	local	Active

14. Choose **Add route**, and then enter `0.0.0.0/0` in the **Destination** box.

Edit routes

Destination	Target	Status
10.0.0.0/24	local	Active
0.0.0.0/0	local	-
0.0.0.0/8		
0.0.0.0/16		

15. For **Target**, select **Internet gateway**, and then choose the internet gateway that you created earlier. If your subnet has an IPv6 CIDR block, you must also add a route for `:::/0` to the same internet gateway.

Edit routes

Destination	Target
10.0.0.0/24	local
<input type="text" value="0.0.0.0/0"/>	<input type="text" value="local"/>
<input type="button" value="Add route"/>	<ul style="list-style-type: none"> Carrier Gateway Core Network Egress Only Internet Gateway Gateway Load Balancer Endpoint Instance Internet Gateway

16. Choose **Save changes**.

Create a NAT gateway

Follow these steps to create a NAT gateway, associate it with a public subnet, and then add it to your private subnet's route table.

To create a NAT gateway and associate it with a public subnet

1. In the navigation pane, choose **NAT gateways**.
2. Choose **Create NAT gateway**.
3. (Optional) Enter a name for your NAT gateway.
4. For **Subnet**, select a public subnet in your VPC. (A public subnet is a subnet that has a direct route to an internet gateway in its route table.)

Note

NAT gateways are associated with a public subnet, but the route table entry is in the private subnet.

5. For **Elastic IP allocation ID**, select an elastic IP address or choose **Allocate Elastic IP**.
6. Choose **Create NAT gateway**.

To add a route to the NAT gateway in the private subnet's route table

1. In the navigation pane, choose **Subnets**.
2. Select a private subnet in your VPC. (A private subnet is a subnet that doesn't have a route to an internet gateway in its route table.)
3. Choose the link under **Route table**.

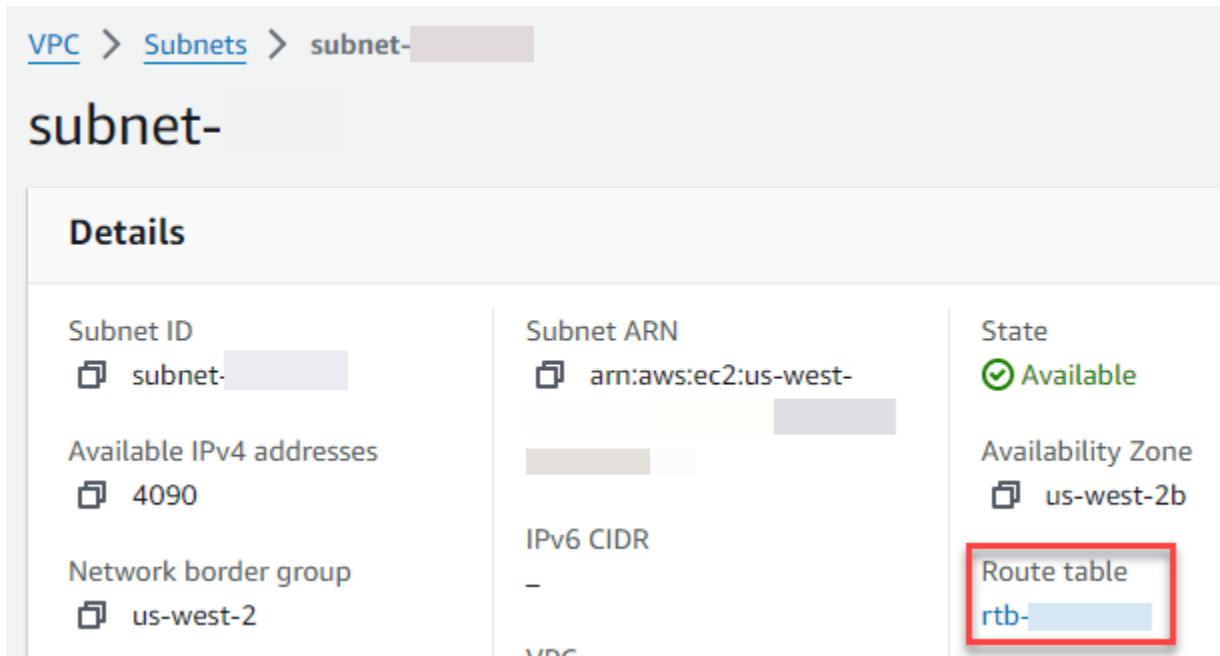

4. Choose the **Route table ID** to open the route table details page.

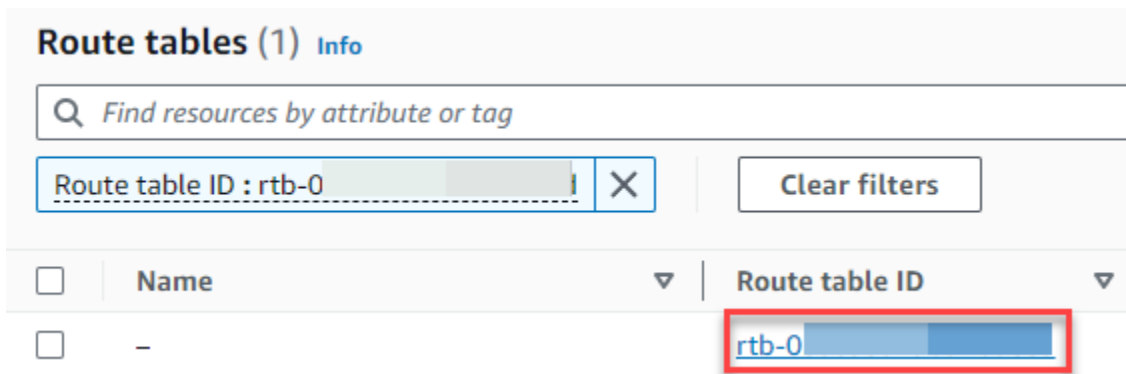

5. Scroll down and choose the **Routes** tab, then choose **Edit routes**

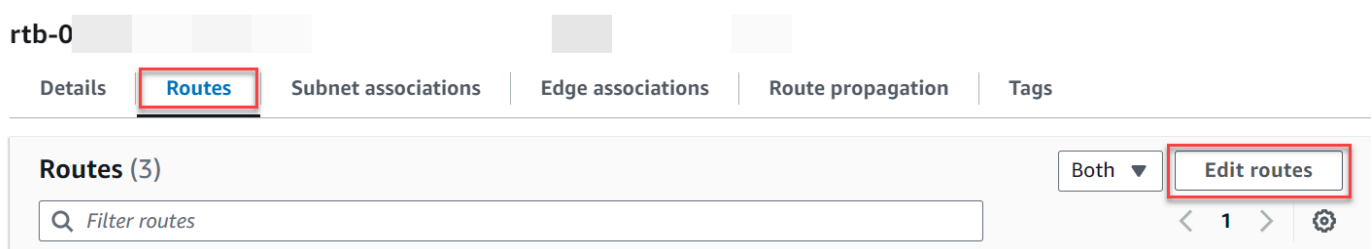

6. Choose **Add route**, and then enter `0.0.0.0/0` in the **Destination** box.

Destination	Target	Status
10.0.0.0/24	local	Active
0.0.0.0/0		-
0.0.0.0/8		
0.0.0.0/16		

7. For **Target**, select **NAT gateway**, and then choose the NAT gateway that you created earlier.

VPC > Route tables > rtb- > Edit routes

Edit routes

Destination	Target
/16	local
0.0.0.0/0	local
	Carrier Gateway
	Core Network
	Egress Only Internet Gateway
	Gateway Load Balancer Endpoint
	Instance
	Internet Gateway
	local
	NAT Gateway
	Network Interface

8. Choose **Save changes**.

Create an egress-only internet gateway (IPv6 only)

Follow these steps to create an egress-only internet gateway and add it to your private subnet's route table.

To create an egress-only internet gateway

1. In the navigation pane, choose **Egress-only internet gateways**.
2. Choose **Create egress only internet gateway**.
3. (Optional) Enter a name.
4. Select the VPC in which to create the egress-only internet gateway.
5. Choose **Create egress only internet gateway**.
6. Choose the link under **Attached VPC ID**.

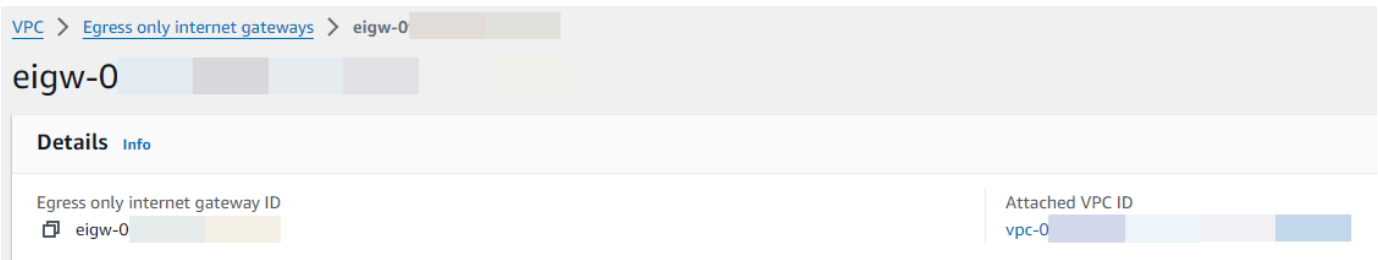

7. Choose the link under **VPC ID** to open the VPC details page.
8. Scroll down to the **Resource map** section and then choose a private subnet. (A private subnet is a subnet that doesn't have a route to an internet gateway in its route table.) The subnet details are displayed in a new tab.

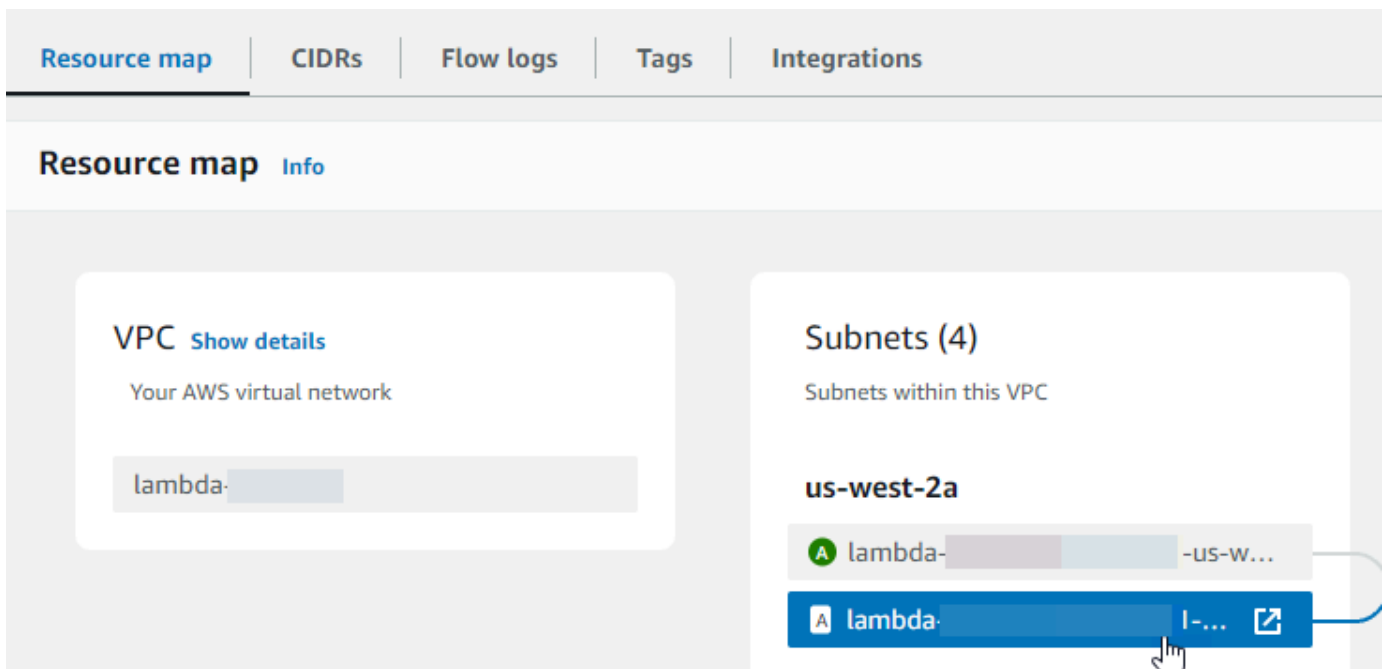

9. Choose the link under **Route table**.

subnet-0 **-subnet-private1-us-west-2a**

Details

Subnet ID ☞ subnet- [redacted]	Subnet ARN ☞ arn:aws:ec2:us-west- [redacted]	State ✔ Available
Available IPv4 addresses ☞ 4090	IPv6 CIDR ☞ [redacted] :/64	Availability Zone ☞ us-west-2a
Network border group ☞ us-west-2	VPC vpc-0 [redacted]	Route table rtb-0 [redacted] west-2a
Default subnet No	Auto-assign public IPv4 address	Auto-assign IPv6 address

10. Choose the **Route table ID** to open the route table details page.

Route tables (1) Info

Find resources by attribute or tag

Route table ID : rtb-0 X Clear filters

<input type="checkbox"/>	Name	Route table ID
<input type="checkbox"/>	-	rtb-0

11. Under **Routes**, choose **Edit routes**.

Routes (1) Both Edit routes

Filter routes

Destination	Target	Status
10.0.0.0/24	local	✔ Active

12. Choose **Add route**, and then enter `::/0` in the **Destination** box.

Edit routes

Destination	Target	Status
10.0.0.0/24	local	✔ Active
0.0.0.0/0	local	-
0.0.0.0/8	-	-
0.0.0.0/16	-	-

- For **Target**, select **Egress Only Internet Gateway**, and then choose the gateway that you created earlier.

Edit routes

Destination	Target	Status
::/56	local	Active
10.0.0.0/16	local	Active
0.0.0.0/0	NAT Gateway	Active
::/0	Egress Only Internet Gateway	Active

- Choose **Save changes**.

Configure the Lambda function

To configure a VPC when you create a function

- Open the [Functions page](#) of the Lambda console.
- Choose **Create function**.
- Under **Basic information**, for **Function name**, enter a name for your function.
- Expand **Advanced settings**.
- Select **Enable VPC**, and then choose a VPC.
- (Optional) To allow [outbound IPv6 traffic](#), select **Allow IPv6 traffic for dual-stack subnets**.
- For **Subnets**, select all private subnets. The private subnets can access the internet through the NAT gateway. Connecting a function to a public subnet doesn't give it internet access.

Note

If you selected **Allow IPv6 traffic for dual-stack subnets**, all selected subnets must have an IPv4 CIDR block and an IPv6 CIDR block.

- For **Security groups**, select a security group that allows outbound traffic.
- Choose **Create function**.

Lambda automatically creates an execution role with the [AWSLambdaVPCAccessExecutionRole](#) AWS managed policy. The permissions in this policy are required only to create elastic network interfaces for the VPC configuration, not to invoke your function. To apply least-privilege permissions, you can remove the **AWSLambdaVPCAccessExecutionRole** policy from your execution role after you create the function and VPC configuration. For more information, see [Required IAM permissions](#).

To configure a VPC for an existing function

To add a VPC configuration to an existing function, the function's execution role must have [permission to create and manage elastic network interfaces](#). The [AWSLambdaVPCAccessExecutionRole](#) AWS managed policy includes the required permissions. To apply least-privilege permissions, you can remove the **AWSLambdaVPCAccessExecutionRole** policy from your execution role after you create the VPC configuration.

1. Open the [Functions page](#) of the Lambda console.
2. Choose a function.
3. Choose the **Configuration** tab, and then choose **VPC**.
4. Under **VPC**, choose **Edit**.
5. Select the VPC.
6. (Optional) To allow [outbound IPv6 traffic](#), select **Allow IPv6 traffic for dual-stack subnets**.
7. For **Subnets**, select all private subnets. The private subnets can access the internet through the NAT gateway. Connecting a function to a public subnet doesn't give it internet access.

Note

If you selected **Allow IPv6 traffic for dual-stack subnets**, all selected subnets must have an IPv4 CIDR block and an IPv6 CIDR block.

8. For **Security groups**, select a security group that allows outbound traffic.
9. Choose **Save**.

Test the function

Use the following sample code to confirm that your VPC-connected function can reach the public internet. If successful, the code returns a 200 status code. If unsuccessful, the function times out.

Node.js

1. In the **Code source** pane on the Lambda console, paste the following code into the **index.mjs** file. The function makes an HTTP GET request to a public endpoint and returns the HTTP response code to test if the function has access to the public internet.

Code source [Info](#)

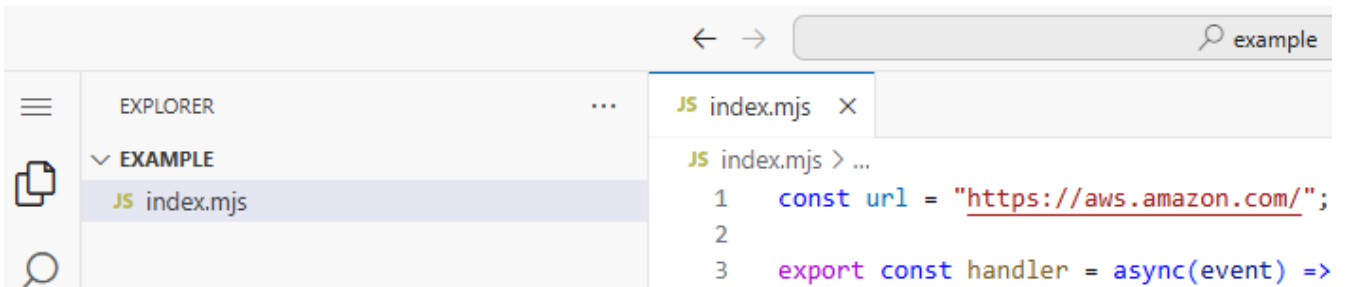

Example — HTTP request with async/await

```
const url = "https://aws.amazon.com/";

export const handler = async(event) => {
  try {
    // fetch is available with Node.js 18 and later runtimes
    const res = await fetch(url);
    console.info("status", res.status);
    return res.status;
  }
  catch (e) {
    console.error(e);
    return 500;
  }
};
```

2. In the **DEPLOY** section, choose **Deploy** to update your function's code:

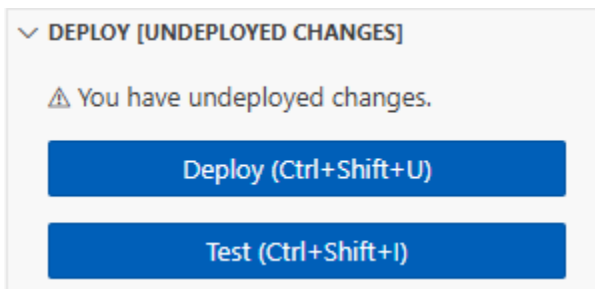

3. Choose the **Test** tab.

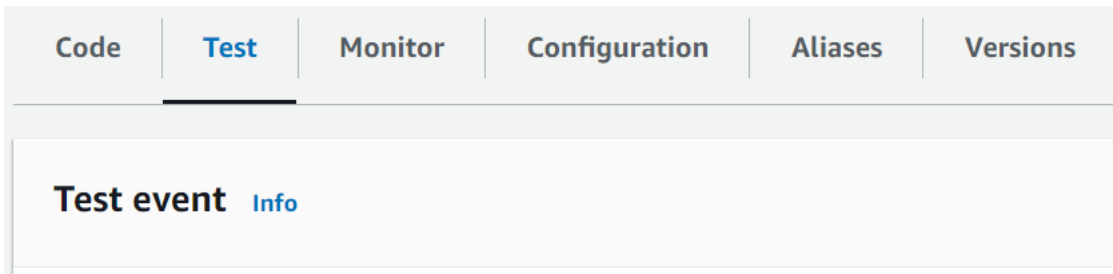

4. Choose **Test**.
5. The function returns a `200` status code. This means that the function has outbound internet access.

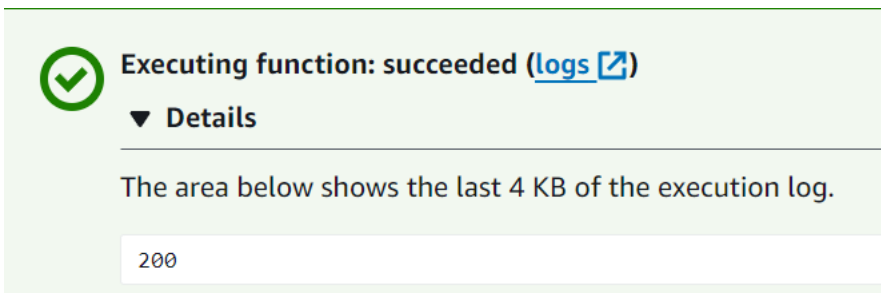

If the function can't reach the public internet, you get an error message like this:

```
{
  "errorMessage": "2024-04-11T17:22:20.857Z abe12jlc-640a-8157-0249-9be825c2y110
Task timed out after 3.01 seconds"
}
```

Python

1. In the **Code source** pane on the Lambda console, paste the following code into the **lambda_function.py** file. The function makes an HTTP GET request to a public endpoint and returns the HTTP response code to test if the function has access to the public internet.

Code source [Info](#)

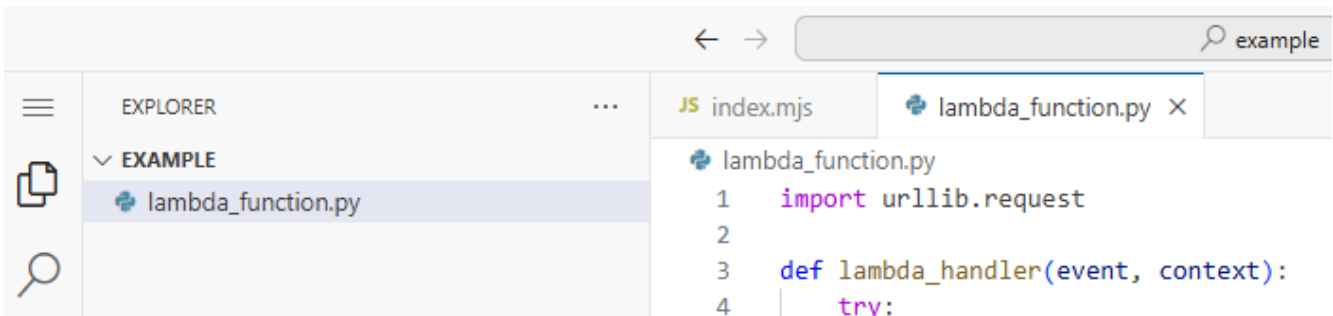

```

import urllib.request

def lambda_handler(event, context):
    try:
        response = urllib.request.urlopen('https://aws.amazon.com')
        status_code = response.getcode()
        print('Response Code:', status_code)
        return status_code
    except Exception as e:
        print('Error:', e)
        raise e

```

- In the **DEPLOY** section, choose **Deploy** to update your function's code:

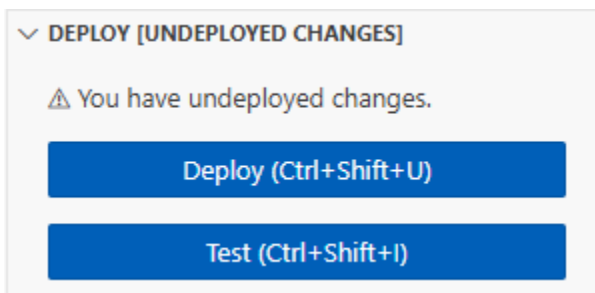

- Choose the **Test** tab.

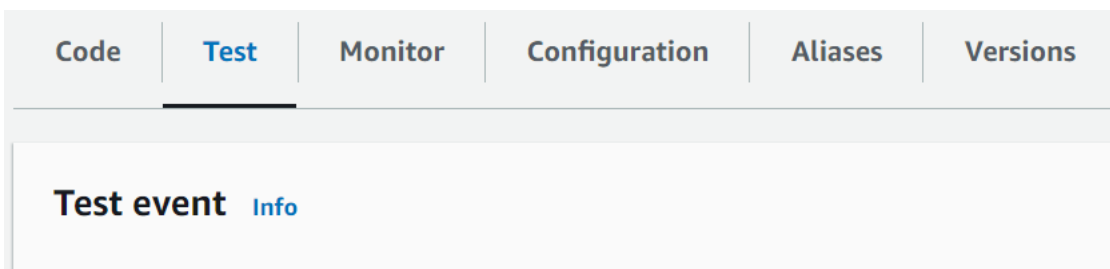

- Choose **Test**.

5. The function returns a `200` status code. This means that the function has outbound internet access.

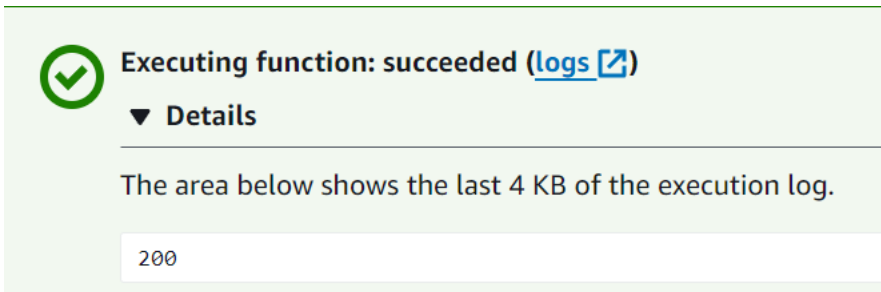

The screenshot shows a green checkmark icon next to the text "Executing function: succeeded (logs [↗](#))". Below this is a "Details" section with a downward arrow. The text "The area below shows the last 4 KB of the execution log." is displayed above a white box containing the status code "200".

If the function can't reach the public internet, you get an error message like this:

```
{
  "errorMessage": "2024-04-11T17:22:20.857Z abe12jlc-640a-8157-0249-9be825c2y110
Task timed out after 3.01 seconds"
}
```

Connecting inbound interface VPC endpoints for Lambda

If you use Amazon Virtual Private Cloud (Amazon VPC) to host your AWS resources, you can establish a connection between your VPC and Lambda. You can use this connection to invoke your Lambda function without crossing the public internet.

To establish a private connection between your VPC and Lambda, create an [interface VPC endpoint](#). Interface endpoints are powered by [AWS PrivateLink](#), which enables you to privately access Lambda APIs without an internet gateway, NAT device, VPN connection, or AWS Direct Connect connection. Instances in your VPC don't need public IP addresses to communicate with Lambda APIs. Traffic between your VPC and Lambda does not leave the AWS network.

Each interface endpoint is represented by one or more [elastic network interfaces](#) in your subnets. A network interface provides a private IP address that serves as an entry point for traffic to Lambda.

Sections

- [Considerations for Lambda interface endpoints](#)
- [Creating an interface endpoint for Lambda](#)
- [Creating an interface endpoint policy for Lambda](#)

Considerations for Lambda interface endpoints

Before you set up an interface endpoint for Lambda, be sure to review [Interface endpoint properties and limitations](#) in the *Amazon VPC User Guide*.

You can call any of the Lambda API operations from your VPC. For example, you can invoke the Lambda function by calling the Invoke API from within your VPC. For the full list of Lambda APIs, see [Actions](#) in the Lambda API reference.

use1-az3 is a limited capacity Region for Lambda VPC functions. You shouldn't use subnets in this availability zone with your Lambda functions because this can result in reduced zonal redundancy in the event of an outage.

Keep-alive for persistent connections

Lambda purges idle connections over time, so you must use a keep-alive directive to maintain persistent connections. Attempting to reuse an idle connection when invoking a function results in a connection error. To maintain your persistent connection, use the keep-alive directive associated

with your runtime. For an example, see [Reusing Connections with Keep-Alive in Node.js](#) in the *AWS SDK for JavaScript Developer Guide*.

Billing Considerations

There is no additional cost to access a Lambda function through an interface endpoint. For more Lambda pricing information, see [AWS Lambda Pricing](#).

Standard pricing for AWS PrivateLink applies to interface endpoints for Lambda. Your AWS account is billed for every hour an interface endpoint is provisioned in each Availability Zone and for data processed through the interface endpoint. For more interface endpoint pricing information, see [AWS PrivateLink pricing](#).

VPC Peering Considerations

You can connect other VPCs to the VPC with interface endpoints using [VPC peering](#). VPC peering is a networking connection between two VPCs. You can establish a VPC peering connection between your own two VPCs, or with a VPC in another AWS account. The VPCs can also be in two different AWS Regions.

Traffic between peered VPCs stays on the AWS network and does not traverse the public internet. Once VPCs are peered, resources like Amazon Elastic Compute Cloud (Amazon EC2) instances, Amazon Relational Database Service (Amazon RDS) instances, or VPC-enabled Lambda functions in both VPCs can access the Lambda API through interface endpoints created in the one of the VPCs.

Creating an interface endpoint for Lambda

You can create an interface endpoint for Lambda using either the Amazon VPC console or the AWS Command Line Interface (AWS CLI). For more information, see [Creating an interface endpoint](#) in the *Amazon VPC User Guide*.

To create an interface endpoint for Lambda (console)

1. Open the [Endpoints page](#) of the Amazon VPC console.
2. Choose **Create Endpoint**.
3. For **Service category**, verify that **AWS services** is selected.
4. For **Service Name**, choose **com.amazonaws.*region*.lambda**. Verify that the **Type** is **Interface**.
5. Choose a VPC and subnets.

6. To enable private DNS for the interface endpoint, select the **Enable DNS Name** check box. We recommend that you enable private DNS names for your VPC endpoints for AWS services. This ensures that requests that use the public service endpoints, such as requests made through an AWS SDK, resolve to your VPC endpoint.
7. For **Security group**, choose one or more security groups.
8. Choose **Create endpoint**.

To use the private DNS option, you must set the `enableDnsHostnames` and `enableDnsSupport` attributes of your VPC. For more information, see [Viewing and updating DNS support for your VPC](#) in the *Amazon VPC User Guide*. If you enable private DNS for the interface endpoint, you can make API requests to Lambda using its default DNS name for the Region, for example, `lambda.us-east-1.amazonaws.com`. For more service endpoints, see [Service endpoints and quotas](#) in the *AWS General Reference*.

For more information, see [Accessing a service through an interface endpoint](#) in the *Amazon VPC User Guide*.

For information about creating and configuring an endpoint using AWS CloudFormation, see the [AWS::EC2::VPCEndpoint](#) resource in the *AWS CloudFormation User Guide*.

To create an interface endpoint for Lambda (AWS CLI)

Use the [create-vpc-endpoint](#) command and specify the VPC ID, VPC endpoint type (interface), service name, subnets that will use the endpoint, and security groups to associate with the endpoint's network interfaces. For example:

```
aws ec2 create-vpc-endpoint
  --vpc-id vpc-ec43eb89
  --vpc-endpoint-type Interface
  --service-name com.amazonaws.us-east-1.lambda
  --subnet-id subnet-abababab
  --security-group-id sg-1a2b3c4d
```

Creating an interface endpoint policy for Lambda

To control who can use your interface endpoint and which Lambda functions the user can access, you can attach an endpoint policy to your endpoint. The policy specifies the following information:

- The principal that can perform actions.

- The actions that the principal can perform.
- The resources on which the principal can perform actions.

For more information, see [Controlling access to services with VPC endpoints](#) in the *Amazon VPC User Guide*.

Example: Interface endpoint policy for Lambda actions

The following is an example of an endpoint policy for Lambda. When attached to an endpoint, this policy allows user `MyUser` to invoke the function `my-function`.

Note

You need to include both the qualified and the unqualified function ARN in the resource.

```
{
  "Statement": [
    {
      "Principal": {
        "AWS": "arn:aws:iam::111122223333:user/MyUser"
      },
      "Effect": "Allow",
      "Action": [
        "lambda:InvokeFunction"
      ],
      "Resource": [
        "arn:aws:lambda:us-east-2:123456789012:function:my-function",
        "arn:aws:lambda:us-east-2:123456789012:function:my-function:*"
      ]
    }
  ]
}
```

Configuring file system access for Lambda functions

You can configure a function to mount an Amazon Elastic File System (Amazon EFS) file system to a local directory. With Amazon EFS, your function code can access and modify shared resources safely and at high concurrency.

Sections

- [Execution role and user permissions](#)
- [Configuring a file system and access point](#)
- [Connecting to a file system \(console\)](#)

Execution role and user permissions

If the file system doesn't have a user-configured AWS Identity and Access Management (IAM) policy, EFS uses a default policy that grants full access to any client that can connect to the file system using a file system mount target. If the file system has a user-configured IAM policy, your function's execution role must have the correct `elasticfilesystem` permissions.

Execution role permissions

- **`elasticfilesystem:ClientMount`**
- **`elasticfilesystem:ClientWrite` (not required for read-only connections)**

These permissions are included in the **`AmazonElasticFileSystemClientReadWriteAccess`** managed policy. Additionally, your execution role must have the [permissions required to connect to the file system's VPC](#).

When you configure a file system, Lambda uses your permissions to verify mount targets. To configure a function to connect to a file system, your user needs the following permissions:

User permissions

- **`elasticfilesystem:DescribeMountTargets`**

Configuring a file system and access point

Create a file system in Amazon EFS with a mount target in every Availability Zone that your function connects to. For performance and resilience, use at least two Availability Zones. For example, in a simple configuration you could have a VPC with two private subnets in separate Availability Zones. The function connects to both subnets and a mount target is available in each. Ensure that NFS traffic (port 2049) is allowed by the security groups used by the function and mount targets.

Note

When you create a file system, you choose a performance mode that can't be changed later. **General purpose** mode has lower latency, and **Max I/O** mode supports a higher maximum throughput and IOPS. For help choosing, see [Amazon EFS performance](#) in the *Amazon Elastic File System User Guide*.

An access point connects each instance of the function to the right mount target for the Availability Zone it connects to. For best performance, create an access point with a non-root path, and limit the number of files that you create in each directory. The following example creates a directory named `my-function` on the file system and sets the owner ID to 1001 with standard directory permissions (755).

Example access point configuration

- **Name** – `files`
- **User ID** – `1001`
- **Group ID** – `1001`
- **Path** – `/my-function`
- **Permissions** – `755`
- **Owner user ID** – `1001`
- **Group user ID** – `1001`

When a function uses the access point, it is given user ID 1001 and has full access to the directory.

For more information, see the following topics in the *Amazon Elastic File System User Guide*:

- [Creating resources for Amazon EFS](#)
- [Working with users, groups, and permissions](#)

Connecting to a file system (console)

A function connects to a file system over the local network in a VPC. The subnets that your function connects to can be the same subnets that contain mount points for your file system, or subnets in the same Availability Zone that can route NFS traffic (port 2049) to the file system.

Note

If your function is not already connected to a VPC, see [Giving Lambda functions access to resources in an Amazon VPC](#).

To configure file system access

1. Open the [Functions page](#) of the Lambda console.
2. Choose a function.
3. Choose **Configuration** and then choose **File systems**.
4. Under **File system**, choose **Add file system**.
5. Configure the following properties:
 - **EFS file system** – The access point for a file system in the same VPC.
 - **Local mount path** – The location where the file system is mounted on the Lambda function, starting with `/mnt/`.

Pricing

Amazon EFS charges for storage and throughput, with rates that vary by storage class. For details, see [Amazon EFS pricing](#).

Lambda charges for data transfer between VPCs. This only applies if your function's VPC is peered to another VPC with a file system. The rates are the same as for Amazon EC2 data transfer between VPCs in the same Region. For details, see [Lambda pricing](#).

Create an alias for a Lambda function

You can create aliases for your Lambda function. A Lambda alias is a pointer to a function version that you can update. The function's users can access the function version using the alias Amazon Resource Name (ARN). When you deploy a new version, you can update the alias to use the new version, or split traffic between two versions.

Console

To create an alias using the console

1. Open the [Functions page](#) of the Lambda console.
2. Choose a function.
3. Choose **Aliases** and then choose **Create alias**.
4. On the **Create alias** page, do the following:
 - a. Enter a **Name** for the alias.
 - b. (Optional) Enter a **Description** for the alias.
 - c. For **Version**, choose a function version that you want the alias to point to.
 - d. (Optional) To configure routing on the alias, expand **Weighted alias**. For more information, see [Implement Lambda canary deployments using a weighted alias](#).
 - e. Choose **Save**.

AWS CLI

To create an alias using the AWS Command Line Interface (AWS CLI), use the [create-alias](#) command.

```
aws lambda create-alias \  
  --function-name my-function \  
  --name alias-name \  
  --function-version version-number \  
  --description " "
```

To change an alias to point a new version of the function, use the [update-alias](#) command.

```
aws lambda update-alias \  
  --function-name my-function \  
  --function-version version-number \  
  --alias-name alias-name
```

```
--name alias-name \  
--function-version version-number
```

To delete an alias, use the [delete-alias](#) command.

```
aws lambda delete-alias \  
--function-name my-function \  
--name alias-name
```

The AWS CLI commands in the preceding steps correspond to the following Lambda API operations:

- [CreateAlias](#)
- [UpdateAlias](#)
- [DeleteAlias](#)

Using Lambda aliases in event sources and permissions policies

Each alias has a unique ARN. An alias can point only to a function version, not to another alias. You can update an alias to point to a new version of the function.

Event sources such as Amazon Simple Storage Service (Amazon S3) invoke your Lambda function. These event sources maintain a mapping that identifies the function to invoke when events occur. If you specify a Lambda function alias in the mapping configuration, you don't need to update the mapping when the function version changes. For more information, see [How Lambda processes records from stream and queue-based event sources](#).

In a resource policy, you can grant permissions for event sources to use your Lambda function. If you specify an alias ARN in the policy, you don't need to update the policy when the function version changes.

Resource policies

You can use a [resource-based policy](#) to give a service, resource, or account access to your function. The scope of that permission depends on whether you apply it to an alias, a version, or the entire function. For example, if you use an alias name (such as `helloworld:PROD`), the permission allows you to invoke the `helloworld` function using the alias ARN (`helloworld:PROD`).

If you attempt to invoke the function without an alias or a specific version, then you get a permission error. This permission error still occurs even if you attempt to directly invoke the function version associated with the alias.

For example, the following AWS CLI command grants Amazon S3 permissions to invoke the `PROD` alias of the `helloworld` function when Amazon S3 is acting on behalf of `amzn-s3-demo-bucket`.

```
aws lambda add-permission \  
  --function-name helloworld \  
  --qualifier PROD \  
  --statement-id 1 \  
  --principal s3.amazonaws.com \  
  --action lambda:InvokeFunction \  
  --source-arn arn:aws:s3:::amzn-s3-demo-bucket \  
  --source-account 123456789012
```

For more information about using resource names in policies, see [Fine-tuning the Resources and Conditions sections of policies](#).

Implement Lambda canary deployments using a weighted alias

You can use a weighted alias to split traffic between two different [versions](#) of the same function. With this approach, you can test new versions of your functions with a small percentage of traffic and quickly roll back if necessary. This is known as a [canary deployment](#). Canary deployments differ from blue/green deployments by exposing the new version to only a portion of requests rather than switching all traffic at once.

You can point an alias to a maximum of two Lambda function versions. The versions must meet the following criteria:

- Both versions must have the same [execution role](#).
- Both versions must have the same [dead-letter queue](#) configuration, or no dead-letter queue configuration.
- Both versions must be published. The alias cannot point to \$LATEST.

Note

Lambda uses a simple probabilistic model to distribute the traffic between the two function versions. At low traffic levels, you might see a high variance between the configured and actual percentage of traffic on each version. If your function uses provisioned concurrency, you can avoid [spillover invocations](#) by configuring a higher number of provisioned concurrency instances during the time that alias routing is active.

Create a weighted alias

Console

To configure routing on an alias using the console

Note

Verify that the function has at least two published versions. To create additional versions, follow the instructions in [Creating function versions](#).

1. Open the [Functions page](#) of the Lambda console.

2. Choose a function.
3. Choose **Aliases** and then choose **Create alias**.
4. On the **Create alias** page, do the following:
 - a. Enter a **Name** for the alias.
 - b. (Optional) Enter a **Description** for the alias.
 - c. For **Version**, choose the first function version that you want the alias to point to.
 - d. Expand **Weighted alias**.
 - e. For **Additional version**, choose the second function version that you want the alias to point to.
 - f. For **Weight (%)**, enter a weight value for the function. *Weight* is the percentage of traffic that is assigned to that version when the alias is invoked. The first version receives the residual weight. For example, if you specify 10 percent to **Additional version**, the first version is assigned 90 percent automatically.
 - g. Choose **Save**.

AWS CLI

Use the [create-alias](#) and [update-alias](#) AWS CLI commands to configure the traffic weights between two function versions. When you create or update the alias, you specify the traffic weight in the `routing-config` parameter.

The following example creates a Lambda function alias named **routing-alias** that points to version 1 of the function. Version 2 of the function receives 3 percent of the traffic. The remaining 97 percent of traffic is routed to version 1.

```
aws lambda create-alias \  
  --name routing-alias \  
  --function-name my-function \  
  --function-version 1 \  
  --routing-config AdditionalVersionWeights={"2":0.03}
```

Use the `update-alias` command to increase the percentage of incoming traffic to version 2. In the following example, you increase the traffic to 5 percent.

```
aws lambda update-alias \  
  --name routing-alias \  
  --routing-config AdditionalVersionWeights={"2":0.05}
```

```
--function-name my-function \  
--routing-config AdditionalVersionWeights={"2"]=0.05}
```

To route all traffic to version 2, use the `update-alias` command to change the `function-version` property to point the alias to version 2. The command also resets the routing configuration.

```
aws lambda update-alias \  
  --name routing-alias \  
  --function-name my-function \  
  --function-version 2 \  
  --routing-config AdditionalVersionWeights={}
```

The AWS CLI commands in the preceding steps correspond to the following Lambda API operations:

- [CreateAlias](#)
- [UpdateAlias](#)

Determining which version was invoked

When you configure traffic weights between two function versions, there are two ways to determine the Lambda function version that has been invoked:

- **CloudWatch Logs** – Lambda automatically emits a START log entry that contains the invoked version ID for every function invocation. Example:

```
START RequestId: 1dh194d3759ed-4v8b-a7b4-1e541f60235f Version: 2
```

For alias invocations, Lambda uses the `ExecutedVersion` dimension to filter the metric data by the invoked version. For more information, see [Viewing metrics for Lambda functions](#).

- **Response payload (synchronous invocations)** – Responses to synchronous function invocations include an `x-amz-executed-version` header to indicate which function version has been invoked.

Create a rolling deployment with weighted aliases

Use AWS CodeDeploy and AWS Serverless Application Model (AWS SAM) to create a rolling deployment that automatically detects changes to your function code, deploys a new version of

your function, and gradually increase the amount of traffic flowing to the new version. The amount of traffic and rate of increase are parameters that you can configure.

In a rolling deployment, AWS SAM performs these tasks:

- Configures your Lambda function and creates an alias. The weighted alias routing configuration is the underlying capability that implements the rolling deployment.
- Creates a CodeDeploy application and deployment group. The deployment group manages the rolling deployment and the rollback, if needed.
- Detects when you create a new version of your Lambda function.
- Triggers CodeDeploy to start the deployment of the new version.

Example AWS SAM template

The following example shows an [AWS SAM template](#) for a simple rolling deployment.

```
AWSTemplateFormatVersion : '2010-09-09'
Transform: AWS::Serverless-2016-10-31
Description: A sample SAM template for deploying Lambda functions

Resources:
# Details about the myDateTimeFunction Lambda function
  myDateTimeFunction:
    Type: AWS::Serverless::Function
    Properties:
      Handler: myDateTimeFunction.handler
      Runtime: nodejs18.x
# Creates an alias named "live" for the function, and automatically publishes when you
  update the function.
    AutoPublishAlias: live
    DeploymentPreference:
# Specifies the deployment configuration
      Type: Linear10PercentEvery2Minutes
```

This template defines a Lambda function named `myDateTimeFunction` with the following properties.

AutoPublishAlias

The `AutoPublishAlias` property creates an alias named `live`. In addition, the AWS SAM framework automatically detects when you save new code for the function. The framework then publishes a new function version and updates the `live` alias to point to the new version.

DeploymentPreference

The `DeploymentPreference` property determines the rate at which the CodeDeploy application shifts traffic from the original version of the Lambda function to the new version. The value `Linear10PercentEvery2Minutes` shifts an additional ten percent of the traffic to the new version every two minutes.

For a list of the predefined deployment configurations, see [Deployment configurations](#).

For more information on how to create rolling deployments with CodeDeploy and AWS SAM, see the following:

- [Tutorial: Deploy an updated Lambda function with CodeDeploy and the AWS Serverless Application Model](#)
- [Deploying serverless applications gradually with AWS SAM](#)

Manage Lambda function versions

You can use versions to manage the deployment of your functions. For example, you can publish a new version of a function for beta testing without affecting users of the stable production version. Lambda creates a new version of your function each time that you publish the function. The new version is a copy of the unpublished version of the function. The unpublished version is named `$LATEST`.

Importantly, any time you deploy your function code, you overwrite the current code in `$LATEST`. To save the current iteration of `$LATEST`, create a new function version. If `$LATEST` is identical to a previously published version, you won't be able to create a new version until you deploy changes to `$LATEST`. These changes can include updating the code, or modifying the function configuration settings.

After you publish a function version, its code, runtime, architecture, memory, layers, and most other configuration settings are immutable. This means that you can't change these settings without publishing a new version from `$LATEST`. You can configure the following items for a published function version:

- [Triggers](#)
- [Destinations](#)
- [Provisioned concurrency](#)
- [Asynchronous invocation](#)
- [Database connections and proxies](#)

Note

When using [runtime management controls](#) with **Auto** mode, the runtime version used by the function version is updated automatically. When using **Function update** or **Manual** mode, the runtime version is not updated. For more information, see [the section called "Runtime version updates"](#).

Sections

- [Creating function versions](#)
- [Using versions](#)

- [Granting permissions](#)

Creating function versions

You can change the function code and settings only on the unpublished version of a function. When you publish a version, Lambda locks the code and most of the settings to maintain a consistent experience for users of that version.

You can create a function version using the Lambda console.

To create a new function version

1. Open the [Functions page](#) of the Lambda console.
2. Choose a function and then choose the **Versions** tab.
3. On the versions configuration page, choose **Publish new version**.
4. (Optional) Enter a version description.
5. Choose **Publish**.

Alternatively, you can publish a version of a function using the [PublishVersion](#) API operation.

The following AWS CLI command publishes a new version of a function. The response returns configuration information about the new version, including the version number and the function ARN with the version suffix.

```
aws lambda publish-version --function-name my-function
```

You should see the following output:

```
{
  "FunctionName": "my-function",
  "FunctionArn": "arn:aws:lambda:us-east-2:123456789012:function:my-function:1",
  "Version": "1",
  "Role": "arn:aws:iam::123456789012:role/lambda-role",
  "Handler": "function.handler",
  "Runtime": "nodejs22.x",
  ...
}
```

Note

Lambda assigns monotonically increasing sequence numbers for versioning. Lambda never reuses version numbers, even after you delete and recreate a function.

Using versions

You can reference your Lambda function using either a qualified ARN or an unqualified ARN.

- **Qualified ARN** – The function ARN with a version suffix. The following example refers to version 42 of the `helloworld` function.

```
arn:aws:lambda:aws-region:acct-id:function:helloworld:42
```

- **Unqualified ARN** – The function ARN without a version suffix.

```
arn:aws:lambda:aws-region:acct-id:function:helloworld
```

You can use a qualified or an unqualified ARN in all relevant API operations. However, you can't use an unqualified ARN to create an alias.

If you decide not to publish function versions, you can invoke the function using either the qualified or unqualified ARN in your [event source mapping](#). When you invoke a function using an unqualified ARN, Lambda implicitly invokes `$LATEST`.

Lambda publishes a new function version only if the code has never been published, or if the code has changed from the last published version. If there is no change, the function version remains at the last published version.

The qualified ARN for each Lambda function version is unique. After you publish a version, you can't change the ARN or the function code.

Granting permissions

You can use a [resource-based policy](#) or an [identity-based policy](#) to grant access to your function. The scope of the permission depends on whether you apply the policy to a function or to one version of a function. For more information about function resource names in policies, see [Fine-tuning the Resources and Conditions sections of policies](#).

You can simplify the management of event sources and AWS Identity and Access Management (IAM) policies by using function aliases. For more information, see [Create an alias for a Lambda function](#).

Using tags on Lambda functions

You can tag functions to organize and manage your resources. Tags are free-form key-value pairs associated with your resources that are supported across AWS services. For more information about use cases for tags, see [Common tagging strategies](#) in the *Tagging AWS Resources and Tag Editor Guide*.

Tags apply at the function level, not to versions or aliases. Tags are not part of the version-specific configuration that AWS Lambda creates a snapshot of when you publish a version. You can use the Lambda API to view and update tags. You can also view and update tags while managing a specific function in the Lambda console.

Sections

- [Permissions required for working with tags](#)
- [Using tags with the Lambda console](#)
- [Using tags with the AWS CLI](#)

Permissions required for working with tags

To allow an AWS Identity and Access Management (IAM) identity (user, group, or role) to read or set tags on a resource, grant it the corresponding permissions:

- **lambda:ListTags**—When a resource has tags, grant this permission to anyone who needs to call `ListTags` on it. For tagged functions, this permission is also necessary for `GetFunction`.
- **lambda:TagResource**—Grant this permission to anyone who needs to call `TagResource` or perform a tag on create.

Optionally, consider granting the **lambda:UntagResource** permission as well to allow `UntagResource` calls to the resource.

For more information, see [Identity-based IAM policies for Lambda](#).

Using tags with the Lambda console

You can use the Lambda console to create functions that have tags, add tags to existing functions, and filter functions by tags that you add.

To add tags when you create a function

1. Open the [Functions page](#) of the Lambda console.
2. Choose **Create function**.
3. Choose **Author from scratch** or **Container image**.
4. Under **Basic information**, set up your function. For more information about configuring functions, see [Configuring functions](#).
5. Expand **Advanced settings**, and then select **Enable tags**.
6. Choose **Add new tag**, and then enter a **Key** and an optional **Value**. To add more tags, repeat this step.
7. Choose **Create function**.

To add tags to an existing function

1. Open the [Functions page](#) of the Lambda console.
2. Choose the name of a function.
3. Choose **Configuration**, and then choose **Tags**.
4. Under **Tags**, choose **Manage tags**.
5. Choose **Add new tag**, and then enter a **Key** and an optional **Value**. To add more tags, repeat this step.
6. Choose **Save**.

To filter functions with tags

1. Open the [Functions page](#) of the Lambda console.
2. Choose the search box to see a list of function properties and tag keys.
3. Choose a tag key to see a list of values that are in use in the current AWS Region.
4. Select **Use: "tag-name"** to see all functions tagged with this key, or choose an **Operator** to further filter by value.
5. Select your tag value to filter by a combination of tag key and value.

The search bar also supports searching for tag keys. Enter tag to see only a list of tag keys, or enter the name of a key to find it in the list.

Using tags with the AWS CLI

You can add and remove tags on existing Lambda resources, including functions, with the Lambda API. You can also add tags when creating a function, which allows you to keep a resource tagged through its entire lifecycle.

Updating tags with the Lambda tag APIs

You can add and remove tags for supported Lambda resources through the [TagResource](#) and [UntagResource](#) API operations.

You can call these operations using the AWS CLI. To add tags to an existing resource, use the `tag-resource` command. This example adds two tags, one with the key `Department` and one with the key `CostCenter`.

```
aws lambda tag-resource \  
--resource arn:aws:lambda:us-east-2:123456789012:resource-type:my-resource \  
--tags Department=Marketing, CostCenter=1234ABCD
```

To remove tags, use the `untag-resource` command. This example removes the tag with the key `Department`.

```
aws lambda untag-resource --resource arn:aws:lambda:us-east-1:123456789012:resource-  
type:resource-identifier \  
--tag-keys Department
```

Adding tags when creating a function

To create a new Lambda function with tags, use the [CreateFunction](#) API operation. Specify the `Tags` parameter. You can call this operation with the `create-function` CLI command and the `--tags` option. Before using the `tags` parameter with `CreateFunction`, ensure that your role has permission to tag resources alongside the usual permissions needed for this operation. For more information about permissions for tagging, see [the section called "Permissions required for working with tags"](#). This example adds two tags, one with the key `Department` and one with the key `CostCenter`.

```
aws lambda create-function --function-name my-function  
--handler index.js --runtime nodejs22.x \  
--role arn:aws:iam::123456789012:role/lambda-role \  
--tags Department=Marketing, CostCenter=1234ABCD
```

```
--tags Department=Marketing, CostCenter=1234ABCD
```

Viewing tags on a function

To view the tags that are applied to a specific Lambda resource, use the `ListTags` API operation. For more information, see [ListTags](#).

You can call this operation with the `list-tags` AWS CLI command by providing an ARN (Amazon Resource Name).

```
aws lambda list-tags --resource arn:aws:lambda:us-east-1:123456789012:resource-type:resource-identifier
```

You can view the tags that are applied to a specific resource with the [GetFunction](#) API operation. Comparable functionality is not available for other resource types.

You can call this operation with the `get-function` CLI command:

```
aws lambda get-function --function-name my-function
```

Filtering resources by tag

You can use the AWS Resource Groups Tagging API [GetResources](#) API operation to filter your resources by tags. The `GetResources` operation receives up to 10 filters, with each filter containing a tag key and up to 10 tag values. You provide `GetResources` with a `ResourceType` to filter by specific resource types.

You can call this operation using the `get-resources` AWS CLI command. For examples of using `get-resources`, see [get-resources](#) in the *AWS CLI Command Reference*.

Response streaming for Lambda functions

You can configure your Lambda function URLs to stream response payloads back to clients. Response streaming can benefit latency sensitive applications by improving time to first byte (TTFB) performance. This is because you can send partial responses back to the client as they become available. Additionally, you can use response streaming to build functions that return larger payloads. Response stream payloads have a soft limit of 20 MB as compared to the 6 MB limit for buffered responses. Streaming a response also means that your function doesn't need to fit the entire response in memory. For very large responses, this can reduce the amount of memory you need to configure for your function.

The speed at which Lambda streams your responses depends on the response size. The streaming rate for the first 6MB of your function's response is uncapped. For responses larger than 6MB, the remainder of the response is subject to a bandwidth cap. For more information on streaming bandwidth, see [Bandwidth limits for response streaming](#).

Streaming responses incurs a cost. For more information, see [AWS Lambda Pricing](#).

Lambda supports response streaming on Node.js managed runtimes. For other languages, you can [use a custom runtime with a custom Runtime API integration](#) to stream responses or use the [Lambda Web Adapter](#). You can stream responses through [Lambda function URLs](#), the AWS SDK, or using the Lambda [InvokeWithResponseStream](#) API.

Note

When testing your function through the Lambda console, you'll always see responses as buffered.

Topics

- [Bandwidth limits for response streaming](#)
- [Writing response streaming-enabled Lambda functions](#)
- [Invoking a response streaming enabled function using Lambda function URLs](#)
- [Tutorial: Creating a response streaming Lambda function with a function URL](#)

Bandwidth limits for response streaming

The first 6MB of your function's response payload has uncapped bandwidth. After this initial burst, Lambda streams your response at a maximum rate of 2MBps. If your function responses never exceed 6MB, then this bandwidth limit never applies.

Note

Bandwidth limits only apply to your function's response payload, and not to network access by your function.

The rate of uncapped bandwidth varies depending on a number of factors, including your function's processing speed. You can normally expect a rate higher than 2MBps for the first 6MB of your function's response. If your function is streaming a response to a destination outside of AWS, the streaming rate also depends on the speed of the external internet connection.

Writing response streaming-enabled Lambda functions

Writing the handler for response streaming functions is different than typical handler patterns. When writing streaming functions, be sure to do the following:

- Wrap your function with the `awsLambda.streamifyResponse()` decorator that the native Node.js runtimes provide.
- End the stream gracefully to ensure that all data processing is complete.

Configuring a handler function to stream responses

To indicate to the runtime that Lambda should stream your function's responses, you must wrap your function with the `streamifyResponse()` decorator. This tells the runtime to use the proper logic path for streaming responses and enables the function to stream responses.

The `streamifyResponse()` decorator accepts a function that accepts the following parameters:

- `event` – Provides information about the function URL's invocation event, such as the HTTP method, query parameters, and the request body.
- `responseStream` – Provides a writable stream.

- `context` – Provides methods and properties with information about the invocation, function, and execution environment.

The `responseStream` object is a [Node.js writableStream](#). As with any such stream, you should use the `pipeline()` method.

Example response streaming-enabled handler

```
const pipeline = require("util").promisify(require("stream").pipeline);
const { Readable } = require('stream');

exports.echo = awslambda.streamifyResponse(async (event, responseStream, _context) => {
  // As an example, convert event to a readable stream.
  const requestStream = Readable.from(Buffer.from(JSON.stringify(event)));

  await pipeline(requestStream, responseStream);
});
```

While `responseStream` offers the `write()` method to write to the stream, we recommend that you use [`pipeline\(\)`](#) wherever possible. Using `pipeline()` ensures that the writable stream is not overwhelmed by a faster readable stream.

Ending the stream

Make sure that you properly end the stream before the handler returns. The `pipeline()` method handles this automatically.

For other use cases, call the `responseStream.end()` method to properly end a stream. This method signals that no more data should be written to the stream. This method isn't required if you write to the stream with `pipeline()` or `pipe()`.

Example Example ending a stream with `pipeline()`

```
const pipeline = require("util").promisify(require("stream").pipeline);

exports.handler = awslambda.streamifyResponse(async (event, responseStream, _context)
=> {
  await pipeline(requestStream, responseStream);
});
```

Example Example ending a stream without pipeline()

```
exports.handler = awslambda.streamifyResponse(async (event, responseStream, _context)
=> {
  responseStream.write("Hello ");
  responseStream.write("world ");
  responseStream.write("from ");
  responseStream.write("Lambda!");
  responseStream.end();
});
```

Invoking a response streaming enabled function using Lambda function URLs

Note

You must invoke your function using a function URL to stream the responses.

You can invoke response streaming enabled functions by changing the invoke mode of your function's URL. The invoke mode determines which API operation Lambda uses to invoke your function. The available invoke modes are:

- **BUFFERED** – This is the default option. Lambda invokes your function using the Invoke API operation. Invocation results are available when the payload is complete. The maximum payload size is 6 MB.
- **RESPONSE_STREAM** – Enables your function to stream payload results as they become available. Lambda invokes your function using the InvokeWithResponseStream API operation. The maximum response payload size is 20 MB. However, you can [request a quota increase](#).

You can still invoke your function without response streaming by directly calling the Invoke API operation. However, Lambda streams all response payloads for invocations that come through the function's URL until you change the invoke mode to BUFFERED.

Console

To set the invoke mode of a function URL (console)

1. Open the [Functions page](#) of the Lambda console.

2. Choose the name of the function that you want to set the invoke mode for.
3. Choose the **Configuration** tab, and then choose **Function URL**.
4. Choose **Edit**, then choose **Additional settings**.
5. Under **Invoke mode**, choose your desired invoke mode.
6. Choose **Save**.

AWS CLI

To set the invoke mode of a function's URL (AWS CLI)

```
aws lambda update-function-url-config \  
  --function-name my-function \  
  --invoke-mode RESPONSE_STREAM
```

AWS CloudFormation

To set the invoke mode of a function's URL (AWS CloudFormation)

```
MyFunctionUrl:  
  Type: AWS::Lambda::Url  
  Properties:  
    AuthType: AWS_IAM  
    InvokeMode: RESPONSE_STREAM
```

For more information about configuring function URLs, see [Lambda function URLs](#).

Tutorial: Creating a response streaming Lambda function with a function URL

In this tutorial, you create a Lambda function defined as a .zip file archive with a function URL endpoint that returns a response stream. For more information about configuring function URLs, see [Function URLs](#).

Prerequisites

This tutorial assumes that you have some knowledge of basic Lambda operations and the Lambda console. If you haven't already, follow the instructions in [Create a Lambda function with the console](#) to create your first Lambda function.

To complete the following steps, you need the [AWS CLI version 2](#). Commands and the expected output are listed in separate blocks:

```
aws --version
```

You should see the following output:

```
aws-cli/2.13.27 Python/3.11.6 Linux/4.14.328-248.540.amzn2.x86_64 exe/x86_64.amzn.2
```

For long commands, an escape character (\) is used to split a command over multiple lines.

On Linux and macOS, use your preferred shell and package manager.

Note

In Windows, some Bash CLI commands that you commonly use with Lambda (such as `zip`) are not supported by the operating system's built-in terminals. To get a Windows-integrated version of Ubuntu and Bash, [install the Windows Subsystem for Linux](#). Example CLI commands in this guide use Linux formatting. Commands which include inline JSON documents must be reformatted if you are using the Windows CLI.

Create an execution role

Create the [execution role](#) that gives your Lambda function permission to access AWS resources.

To create an execution role

1. Open the [Roles page](#) of the AWS Identity and Access Management (IAM) console.
2. Choose **Create role**.
3. Create a role with the following properties:
 - **Trusted entity type** – **AWS service**
 - **Use case** – **Lambda**
 - **Permissions** – **AWSLambdaBasicExecutionRole**
 - **Role name** – **response-streaming-role**

The **AWSLambdaBasicExecutionRole** policy has the permissions that the function needs to write logs to Amazon CloudWatch Logs. After you create the role, note down the its Amazon Resource Name (ARN). You'll need it in the next step.

Create a response streaming function (AWS CLI)

Create a response streaming Lambda function with a function URL endpoint using the AWS Command Line Interface (AWS CLI).

To create a function that can stream responses

1. Copy the following code example into a file named `index.mjs`.

```
import util from 'util';
import stream from 'stream';
const { Readable } = stream;
const pipeline = util.promisify(stream.pipeline);

/* global awslambda */
export const handler = awslambda.streamifyResponse(async (event, responseStream,
  _context) => {
  const requestStream = Readable.from(Buffer.from(JSON.stringify(event)));
  await pipeline(requestStream, responseStream);
});
```

2. Create a deployment package.

```
zip function.zip index.mjs
```

3. Create a Lambda function with the `create-function` command. Replace the value of `--role` with the role ARN from the previous step.

```
aws lambda create-function \
  --function-name my-streaming-function \
  --runtime nodejs16.x \
  --zip-file fileb://function.zip \
  --handler index.handler \
  --role arn:aws:iam::123456789012:role/response-streaming-role
```

To create a function URL

1. Add a resource-based policy to your function to allow access to your function URL. Replace the value of `--principal` with your AWS account ID.

```
aws lambda add-permission \  
  --function-name my-streaming-function \  
  --action lambda:InvokeFunctionUrl \  
  --statement-id 12345 \  
  --principal 123456789012 \  
  --function-url-auth-type AWS_IAM \  
  --statement-id url
```

2. Create a URL endpoint for the function with the `create-function-url-config` command.

```
aws lambda create-function-url-config \  
  --function-name my-streaming-function \  
  --auth-type AWS_IAM \  
  --invoke-mode RESPONSE_STREAM
```

Test the function URL endpoint

Test your integration by invoking your function. You can open your function's URL in a browser, or you can use `curl`.

```
curl --request GET "<function_url>" --user "<key:token>" --aws-sigv4 "aws:amz:us-east-1:lambda" --no-buffer
```

Our function URL uses the `IAM_AUTH` authentication type. This means that you need to sign requests with both your AWS access key and secret key. In the previous command, replace `<key:token>` with the AWS access key ID. Enter your AWS secret key when prompted. If you don't have your AWS secret key, you can [use temporary AWS credentials](#) instead.

Clean up your resources

You can now delete the resources that you created for this tutorial, unless you want to retain them. By deleting AWS resources that you're no longer using, you prevent unnecessary charges to your AWS account.

To delete the execution role

1. Open the [Roles page](#) of the IAM console.
2. Select the execution role that you created.
3. Choose **Delete**.
4. Enter the name of the role in the text input field and choose **Delete**.

To delete the Lambda function

1. Open the [Functions page](#) of the Lambda console.
2. Select the function that you created.
3. Choose **Actions, Delete**.
4. Type **confirm** in the text input field and choose **Delete**.

Understanding Lambda function invocation methods

After you deploy your Lambda function, you can invoke it in several ways:

- The [Lambda console](#) – Use the Lambda console to quickly create a test event to invoke your function.
- The [AWS SDK](#) – Use the AWS SDK to programmatically invoke your function.
- The [Invoke](#) API – Use the Lambda Invoke API to directly invoke your function.
- The [AWS Command Line Interface \(AWS CLI\)](#) – Use the `aws lambda invoke` AWS CLI command to directly invoke your function from the command line.
- A [function URL HTTP\(S\) endpoint](#) – Use function URLs to create a dedicated HTTP(S) endpoint that you can use to invoke your function.

All of these methods are *direct* ways to invoke your function. In Lambda, a common use case is to invoke your function based on an event that occurs elsewhere in your application. Some services can invoke a Lambda function with each new event. This is called a [trigger](#). For stream and queue-based services, Lambda invokes the function with batches of records. This is called an [event source mapping](#).

When you invoke a function, you can choose to invoke it synchronously or asynchronously. With [synchronous invocation](#), you wait for the function to process the event and return a response. With [asynchronous invocation](#), Lambda queues the event for processing and returns a response immediately. The [InvocationType request parameter in the Invoke API](#) determines how Lambda invokes your function. A value of `RequestResponse` indicates synchronous invocation, and a value of `Event` indicates asynchronous invocation.

To invoke your function over IPv6, use Lambda's public [dual-stack endpoints](#). Dual-stack endpoints support both IPv4 and IPv6. Lambda dual-stack endpoints use the following syntax:

```
protocol://lambda.us-east-1.api.aws
```

You can also use [Lambda function URLs](#) to invoke functions over IPv6. Function URL endpoints have the following format:

```
https://url-id.lambda-url.us-east-1.on.aws
```

If the function invocation results in an error, for synchronous invocations, view the error message in the response and retry the invocation manually. For asynchronous invocations, Lambda handles retries automatically and can send invocation records to a [destination](#).

Invoke a Lambda function synchronously

When you invoke a function synchronously, Lambda runs the function and waits for a response. When the function completes, Lambda returns the response from the function's code with additional data, such as the version of the function that was invoked. To invoke a function synchronously with the AWS CLI, use the `invoke` command.

```
aws lambda invoke --function-name my-function \  
  --cli-binary-format raw-in-base64-out \  
  --payload '{ "key": "value" }' response.json
```

The `cli-binary-format` option is required if you're using AWS CLI version 2. To make this the default setting, run `aws configure set cli-binary-format raw-in-base64-out`. For more information, see [AWS CLI supported global command line options](#) in the *AWS Command Line Interface User Guide for Version 2*.

You should see the following output:

```
{  
  "ExecutedVersion": "$LATEST",  
  "StatusCode": 200  
}
```

The following diagram shows clients invoking a Lambda function synchronously. Lambda sends the events directly to the function and sends the function's response back to the invoker.



The `payload` is a string that contains an event in JSON format. The name of the file where the AWS CLI writes the response from the function is `response.json`. If the function returns an

object or error, the response body is the object or error in JSON format. If the function exits without error, the response body is `null`.

Note

Lambda does not wait for external extensions to complete before sending the response. External extensions run as independent processes in the execution environment and continue to run after the function invocation is complete. For more information, see [Augment Lambda functions using Lambda extensions](#).

The output from the command, which is displayed in the terminal, includes information from headers in the response from Lambda. This includes the version that processed the event (useful when you use [aliases](#)), and the status code returned by Lambda. If Lambda was able to run the function, the status code is 200, even if the function returned an error.

Note

For functions with a long timeout, your client might be disconnected during synchronous invocation while it waits for a response. Configure your HTTP client, SDK, firewall, proxy, or operating system to allow for long connections with timeout or keep-alive settings.

If Lambda isn't able to run the function, the error is displayed in the output.

```
aws lambda invoke --function-name my-function \  
  --cli-binary-format raw-in-base64-out \  
  --payload value response.json
```

You should see the following output:

```
An error occurred (InvalidRequestContentException) when calling the Invoke operation:  
  Could not parse request body into json: Unrecognized token 'value': was expecting  
  ('true', 'false' or 'null')  
  at [Source: (byte[])"value"; line: 1, column: 11]
```

The AWS CLI is an open-source tool that enables you to interact with AWS services using commands in your command line shell. To complete the steps in this section, you must have the [AWS CLI version 2](#).

You can use the [AWS CLI](#) to retrieve logs for an invocation using the `--log-type` command option. The response contains a `LogResult` field that contains up to 4 KB of base64-encoded logs from the invocation.

Example retrieve a log ID

The following example shows how to retrieve a *log ID* from the `LogResult` field for a function named `my-function`.

```
aws lambda invoke --function-name my-function out --log-type Tail
```

You should see the following output:

```
{
  "StatusCode": 200,
  "LogResult":
  "U1RBULQgUmVxdWVzdElkOiA4N2QwNDRiOC1mMTU0LTExZTgtOGNkYS0yOTc0YzVlNGZiMjEgVmVyc2l1vb...",
  "ExecutedVersion": "$LATEST"
}
```

Example decode the logs

In the same command prompt, use the `base64` utility to decode the logs. The following example shows how to retrieve base64-encoded logs for `my-function`.

```
aws lambda invoke --function-name my-function out --log-type Tail \
--query 'LogResult' --output text --cli-binary-format raw-in-base64-out | base64 --
decode
```

The `cli-binary-format` option is required if you're using AWS CLI version 2. To make this the default setting, run `aws configure set cli-binary-format raw-in-base64-out`. For more information, see [AWS CLI supported global command line options](#) in the *AWS Command Line Interface User Guide for Version 2*.

You should see the following output:

```
START RequestId: 57f231fb-1730-4395-85cb-4f71bd2b87b8 Version: $LATEST
"AWS_SESSION_TOKEN": "AgoJb3JpZ22luX2VjELj...", "_X_AMZN_TRACE_ID": "Root=1-5d02e5ca-
f5792818b6fe8368e5b51d50;Parent=191db58857df8395;Sampled=0\"",ask/lib:/opt/lib",
END RequestId: 57f231fb-1730-4395-85cb-4f71bd2b87b8
```

```
REPORT RequestId: 57f231fb-1730-4395-85cb-4f71bd2b87b8 Duration: 79.67 ms Billed
Duration: 80 ms Memory Size: 128 MB Max Memory Used: 73 MB
```

The base64 utility is available on Linux, macOS, and [Ubuntu on Windows](#). macOS users may need to use `base64 -D`.

For more information about the Invoke API, including a full list of parameters, headers, and errors, see [Invoke](#).

When you invoke a function directly, you can check the response for errors and retry. The AWS CLI and AWS SDK also automatically retry on client timeouts, throttling, and service errors. For more information, see [Understanding retry behavior in Lambda](#).

Invoking a Lambda function asynchronously

Several AWS services, such as Amazon Simple Storage Service (Amazon S3) and Amazon Simple Notification Service (Amazon SNS), invoke functions asynchronously to process events. You can also invoke a Lambda function asynchronously using the AWS Command Line Interface (AWS CLI) or one of the AWS SDKs. When you invoke a function asynchronously, you don't wait for a response from the function code. You hand off the event to Lambda and Lambda handles the rest. You can configure how Lambda handles errors, and can send invocation records to a downstream resource such as Amazon Simple Queue Service (Amazon SQS) or Amazon EventBridge (EventBridge) to chain together components of your application.

The following diagram shows clients invoking a Lambda function asynchronously. Lambda queues the events before sending them to the function.

Asynchronous Invocation

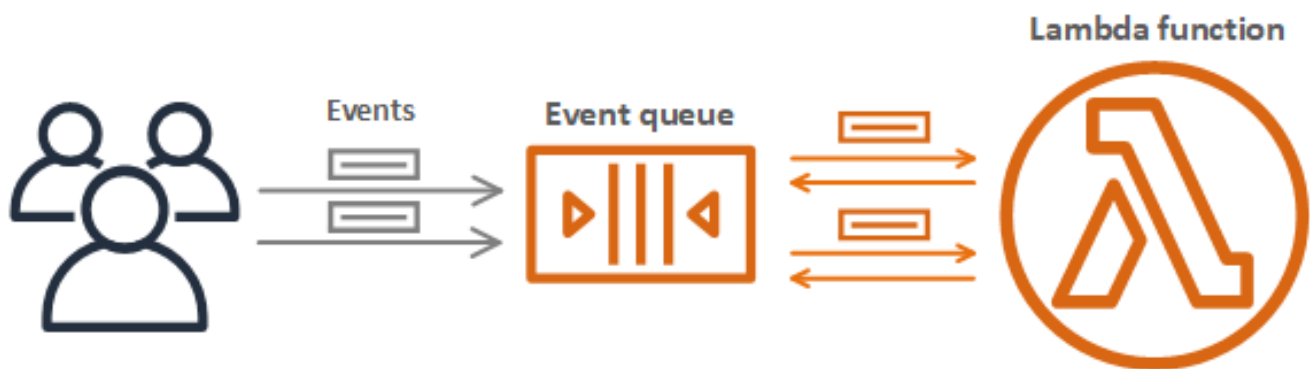

For asynchronous invocation, Lambda places the event in a queue and returns a success response without additional information. A separate process reads events from the queue and sends them to your function.

To invoke a Lambda function asynchronously using the AWS Command Line Interface (AWS CLI) or one of the AWS SDKs, set the [InvocationType](#) parameter to `Event`. The following example shows an AWS CLI command to invoke a function.

```
aws lambda invoke \  
  --function-name my-function \  
  --invocation-type Event \  
  --cli-binary-format raw-in-base64-out \  
  <event>
```

```
--payload '{ "key": "value" }' response.json
```

You should see the following output:

```
{  
  "StatusCode": 202  
}
```

The **cli-binary-format** option is required if you're using AWS CLI version 2. To make this the default setting, run `aws configure set cli-binary-format raw-in-base64-out`. For more information, see [AWS CLI supported global command line options](#) in the *AWS Command Line Interface User Guide for Version 2*.

The output file (`response.json`) doesn't contain any information, but is still created when you run this command. If Lambda isn't able to add the event to the queue, the error message appears in the command output.

How Lambda handles errors and retries with asynchronous invocation

Lambda manages your function's asynchronous event queue and attempts to retry on errors. If the function returns an error, by default Lambda attempts to run it two more times, with a one-minute wait between the first two attempts, and two minutes between the second and third attempts. Function errors include errors returned by the function's code and errors returned by the function's runtime, such as timeouts.

If the function doesn't have enough concurrency available to process all events, additional requests are throttled. For throttling errors (429) and system errors (500-series), Lambda returns the event to the queue and attempts to run the function again for up to 6 hours by default. The retry interval increases exponentially from 1 second after the first attempt to a maximum of 5 minutes. If the queue contains many entries, Lambda increases the retry interval and reduces the rate at which it reads events from the queue.

Even if your function doesn't return an error, it's possible for it to receive the same event from Lambda multiple times because the queue itself is eventually consistent. If the function can't keep up with incoming events, events might also be deleted from the queue without being sent to the function. Ensure that your function code gracefully handles duplicate events, and that you have enough concurrency available to handle all invocations.

When the queue is very long, new events might age out before Lambda has a chance to send them to your function. When an event expires or fails all processing attempts, Lambda discards it. You can [configure error handling](#) for a function to reduce the number of retries that Lambda performs, or to discard unprocessed events more quickly.

You can also configure Lambda to send an invocation record to another service. See [Capturing records of Lambda asynchronous invocations](#) to learn more.

Configuring error handling settings for Lambda asynchronous invocations

Use the following settings to configure how Lambda handles errors and retries for asynchronous function invocations:

- [MaximumEventAgeInSeconds](#): The maximum amount of time, in seconds, that Lambda keeps an event in the asynchronous event queue before discarding it.
- [MaximumRetryAttempts](#): The maximum number of times that Lambda retries events when the function returns an error.

Use the Lambda console or AWS CLI to configure error handling settings on a function, a version, or an alias.

Console

To configure error handling

1. Open the [Functions page](#) of the Lambda console.
2. Choose a function.
3. Choose **Configuration** and then choose **Asynchronous invocation**.
4. Under **Asynchronous invocation**, choose **Edit**.
5. Configure the following settings.
 - **Maximum age of event** – The maximum amount of time Lambda retains an event in the asynchronous event queue, up to 6 hours.
 - **Retry attempts** – The number of times Lambda retries when the function returns an error, between 0 and 2.
6. Choose **Save**.

AWS CLI

To configure asynchronous invocation with the AWS CLI, use the [put-function-event-invoke-config](#) command. The following example configures a function with a maximum event age of 1 hour and no retries.

```
aws lambda put-function-event-invoke-config \  
  --function-name error \  
  --maximum-event-age-in-seconds 3600 \  
  --maximum-retry-attempts 0
```

The `put-function-event-invoke-config` command overwrites any existing configuration on the function, version, or alias. To configure an option without resetting others, use [update-function-event-invoke-config](#). The following example configures Lambda to send a record to a standard SQS queue named `destination` when an event can't be processed.

```
aws lambda update-function-event-invoke-config \  
  --function-name my-function \  
  --destination-config '{"OnFailure":{"Destination": "arn:aws:sqs:us-east-1:123456789012:destination"}}'
```

You should see the following output:

```
{  
  "LastModified": 1573686021.479,  
  "FunctionArn": "arn:aws:lambda:us-east-1:123456789012:function:my-function:  
$LATEST",  
  "MaximumRetryAttempts": 0,  
  "MaximumEventAgeInSeconds": 3600,  
  "DestinationConfig": {  
    "OnSuccess": {},  
    "OnFailure": {}  
  }  
}
```

When an invocation event exceeds the maximum age or fails all retry attempts, Lambda discards it. To retain a copy of discarded events, configure a failed-event [destination](#).

Capturing records of Lambda asynchronous invocations

Lambda can send records of asynchronous invocations to one of the following AWS services.

- **Amazon SQS** – A standard SQS queue
- **Amazon SNS** – A standard SNS topic
- **Amazon S3** – An Amazon S3 bucket (on failure only)
- **AWS Lambda** – A Lambda function
- **Amazon EventBridge** – An EventBridge event bus

The invocation record contains details about the request and response in JSON format. You can configure separate destinations for events that are processed successfully, and events that fail all processing attempts. Alternatively, you can configure a standard Amazon SQS queue or standard Amazon SNS topic as a dead-letter queue for discarded events. For dead-letter queues, Lambda only sends the content of the event, without details about the response.

If Lambda can't send a record to a destination you have configured, it sends a `DestinationDeliveryFailures` metric to Amazon CloudWatch. This can happen if your configuration includes an unsupported destination type, such as an Amazon SQS FIFO queue or an Amazon SNS FIFO topic. Delivery errors can also occur due to permissions errors and size limits. For more information on Lambda invocation metrics, see [the section called "Invocation metrics"](#).

Note

To prevent a function from triggering, you can set the function's reserved concurrency to zero. When you set reserved concurrency to zero for an asynchronously invoked function, Lambda begins sending new events to the configured [dead-letter queue](#) or the on-failure [event destination](#), without any retries. To process events that were sent while reserved concurrency was set to zero, you must consume the events from the dead-letter queue or the on-failure event destination.

Adding a destination

To retain records of asynchronous invocations, add a destination to your function. You can choose to send either successful or failed invocations to a destination. Each function can have multiple

destinations, so you can configure separate destinations for successful and failed events. Each record sent to the destination is a JSON document with details about the invocation. Like error handling settings, you can configure destinations on a function, function version, or alias.

Tip

You can also retain records of failed invocations for the following event source mapping types: [Amazon Kinesis](#), [Amazon DynamoDB](#), [self-managed Apache Kafka](#), and [Amazon MSK](#).

The following table lists supported destinations for asynchronous invocation records. For Lambda to successfully send records to your chosen destination, ensure that your function's [execution role](#) also contains the relevant permissions. The table also describes how each destination type receives the JSON invocation record.

Destination type	Required permission	Destination-specific JSON format
Amazon SQS queue	sqs:SendMessage	Lambda passes the invocation record as the Message to the destination.
Amazon SNS topic	sns:Publish	Lambda passes the invocation record as the Message to the destination.
Amazon S3 bucket (on failure only)	s3:PutObject s3:ListBucket	<ul style="list-style-type: none"> Lambda stores the invocation record as a JSON object in the destination bucket. The S3 object name uses the following naming convention: <div style="border: 1px solid #ccc; border-radius: 10px; padding: 10px; margin-top: 10px;"> <pre>aws/lambda/async/< function-name>/YYY Y/MM/DD/YYYY-MM-DD</pre> </div>

Destination type	Required permission	Destination-specific JSON format
		<pre>THH.MM.SS-<Random UUID></pre>
Lambda function	lambda:InvokeFunction	Lambda passes the invocation record as the payload to the function.
EventBridge	events:PutEvents	<ul style="list-style-type: none"> • Lambda passes the invocation record as the detail in the PutEvents call. • The value for the source event field is lambda. • The value for the detail-type event field is either "Lambda Function Invocation Result - Success" or "Lambda Function Invocation Result - Failure". • The resource event field contains the function and destination Amazon Resource Names (ARNs). • For other event fields, see Amazon EventBridge events.

 **Note**

For Amazon S3 destinations, if you have enabled encryption on the bucket using a KMS key, your function also needs the [kms:GenerateDataKey](#) permission.

The following steps describe how to configure a destination for a function using the Lambda console and the AWS CLI.

Console

1. Open the [Functions page](#) of the Lambda console.
2. Choose a function.
3. Under **Function overview**, choose **Add destination**.
4. For **Source**, choose **Asynchronous invocation**.
5. For **Condition**, choose from the following options:
 - **On failure** – Send a record when the event fails all processing attempts or exceeds the maximum age.
 - **On success** – Send a record when the function successfully processes an asynchronous invocation.
6. For **Destination type**, choose the type of resource that receives the invocation record.
7. For **Destination**, choose a resource.
8. Choose **Save**.

AWS CLI

To configure a destination using the AWS CLI, run the [update-function-event-invoke-config](#) command. The following example configures Lambda to send a record to a standard SQS queue named `destination` when an event can't be processed.

```
aws lambda update-function-event-invoke-config \  
  --function-name my-function \  
  --destination-config '{"OnFailure":{"Destination": "arn:aws:sqs:us-  
east-1:123456789012:destination"}}'
```

Security best practices for Amazon S3 destinations

Deleting an S3 bucket that's configured as a destination without removing the destination from your function's configuration can create a security risk. If another user knows your destination bucket's name, they can recreate the bucket in their AWS account. Records of failed invocations will be sent to their bucket, potentially exposing data from your function.

⚠ Warning

To ensure that invocation records from your function can't be sent to an S3 bucket in another AWS account, add a condition to your function's execution role that limits `s3:PutObject` permissions to buckets in your account.

The following example shows an IAM policy that limits your function's `s3:PutObject` permissions to buckets in your account. This policy also gives Lambda the `s3:ListBucket` permission it needs to use an S3 bucket as a destination.

```
{
  "Version": "2012-10-17",
  "Statement": [
    {
      "Sid": "S3BucketResourceAccountWrite",
      "Effect": "Allow",
      "Action": [
        "s3:PutObject",
        "s3:ListBucket"
      ],
      "Resource": "arn:aws:s3:::*/*",
      "Condition": {
        "StringEquals": {
          "s3:ResourceAccount": "111122223333"
        }
      }
    }
  ]
}
```

To add a permissions policy to your function's execution role using the AWS Management Console or AWS CLI, refer to the instructions in the following procedures:

Console

To add a permissions policy to a function's execution role (console)

1. Open the [Functions page](#) of the Lambda console.
2. Select the Lambda function whose execution role you want to modify.

3. In the **Configuration** tab, select **Permissions**.
4. In the **Execution role** tab, select your function's **Role name** to open the role's IAM console page.
5. Add a permissions policy to the role by doing the following:
 - a. In the **Permissions policies** pane, choose **Add permissions** and select **Create inline policy**.
 - b. In **Policy editor**, select **JSON**.
 - c. Paste the policy you want to add into the editor (replacing the existing JSON), and then choose **Next**.
 - d. Under **Policy details**, enter a **Policy name**.
 - e. Choose **Create policy**.

AWS CLI

To add a permissions policy to a function's execution role (CLI)

1. Create a JSON policy document with the required permissions and save it in a local directory.
2. Use the IAM `put-role-policy` CLI command to add the permissions to your function's execution role. Run the following command from the directory you saved your JSON policy document in and replace the role name, policy name, and policy document with your own values.

```
aws iam put-role-policy \  
--role-name my_lambda_role \  
--policy-name LambdaS3DestinationPolicy \  
--policy-document file://my_policy.json
```

Example invocation record

When an invocation matches the condition, Lambda sends [a JSON document](#) with details about the invocation to the destination. The following example shows an invocation record for an event that failed three processing attempts due to a function error.

Example

```
{
  "version": "1.0",
  "timestamp": "2019-11-14T18:16:05.568Z",
  "requestContext": {
    "requestId": "e4b46cbf-b738-xmpl-8880-a18cdf61200e",
    "functionArn": "arn:aws:lambda:us-east-1:123456789012:function:my-function:
$LATEST",
    "condition": "RetriesExhausted",
    "approximateInvokeCount": 3
  },
  "requestPayload": {
    "ORDER_IDS": [
      "9e07af03-ce31-4ff3-xmpl-36dce652cb4f",
      "637de236-e7b2-464e-xmpl-baf57f86bb53",
      "a81ddca6-2c35-45c7-xmpl-c3a03a31ed15"
    ]
  },
  "responseContext": {
    "statusCode": 200,
    "executedVersion": "$LATEST",
    "functionError": "Unhandled"
  },
  "responsePayload": {
    "errorMessage": "RequestId: e4b46cbf-b738-xmpl-8880-a18cdf61200e Process exited
before completing request"
  }
}
```

The invocation record contains details about the event, the response, and the reason that the record was sent.

Tracing requests to destinations

You can use AWS X-Ray to see a connected view of each request as it's queued, processed by a Lambda function, and passed to the destination service. When you activate X-Ray tracing for a function or a service that invokes a function, Lambda adds an X-Ray header to the request and passes the header to the destination service. Traces from upstream services are automatically linked to traces from downstream Lambda functions and destination services, creating an end-to-end view of the entire application. For more information about tracing, see [Visualize Lambda function invocations using AWS X-Ray](#).

Adding a dead-letter queue

As an alternative to an [on-failure destination](#), you can configure your function with a dead-letter queue to save discarded events for further processing. A dead-letter queue acts the same as an on-failure destination in that it is used when an event fails all processing attempts or expires without being processed. However, you can only add or remove a dead-letter queue at the function level. Function versions use the same dead-letter queue settings as the unpublished version (\$LATEST). On-failure destinations also support additional targets and include details about the function's response in the invocation record.

To reprocess events in a dead-letter queue, you can set it as an [event source](#) for your Lambda function. Alternatively, you can manually retrieve the events.

You can choose an Amazon SQS standard queue or Amazon SNS standard topic for your dead-letter queue. FIFO queues and Amazon SNS FIFO topics are not supported.

- [Amazon SQS queue](#) – A queue holds failed events until they're retrieved. Choose an Amazon SQS standard queue if you expect a single entity, such as a Lambda function or CloudWatch alarm, to process the failed event. For more information, see [Using Lambda with Amazon SQS](#).
- [Amazon SNS topic](#) – A topic relays failed events to one or more destinations. Choose an Amazon SNS standard topic if you expect multiple entities to act on a failed event. For example, you can configure a topic to send events to an email address, a Lambda function, and/or an HTTP endpoint. For more information, see [Invoking Lambda functions with Amazon SNS notifications](#).

To send events to a queue or topic, your function needs additional permissions. Add a policy with the [required permissions](#) to your function's [execution role](#).

If the target queue or topic is encrypted with a customer managed key, the execution role must also be a user in the key's [resource-based policy](#).

After creating the target and updating your function's execution role, add the dead-letter queue to your function. You can configure multiple functions to send events to the same target.

Console

1. Open the [Functions page](#) of the Lambda console.
2. Choose a function.
3. Choose **Configuration** and then choose **Asynchronous invocation**.

4. Under **Asynchronous invocation**, choose **Edit**.
5. Set **Dead-letter queue service** to **Amazon SQS** or **Amazon SNS**.
6. Choose the target queue or topic.
7. Choose **Save**.

AWS CLI

To configure a dead-letter queue with the AWS CLI, use the [update-function-configuration](#) command.

```
aws lambda update-function-configuration \  
  --function-name my-function \  
  --dead-letter-config TargetArn=arn:aws:sns:us-east-1:123456789012:my-topic
```

Lambda sends the event to the dead-letter queue as-is, with additional information in attributes. You can use this information to identify the error that the function returned, or to correlate the event with logs or an AWS X-Ray trace.

Dead-letter queue message attributes

- **RequestID** (String) – The ID of the invocation request. Request IDs appear in function logs. You can also use the X-Ray SDK to record the request ID on an attribute in the trace. You can then search for traces by request ID in the X-Ray console.
- **ErrorCode** (Number) – The HTTP status code.
- **ErrorMessage** (String) – The first 1 KB of the error message.

If Lambda can't send a message to the dead-letter queue, it deletes the event and emits the [DeadLetterErrors](#) metric. This can happen because of lack of permissions, or if the total size of the message exceeds the limit for the target queue or topic. For example, say that an Amazon SNS notification with a body close to 256 KB in size triggers a function that results in an error. In that case, the event data that Amazon SNS adds, combined with the attributes that Lambda adds, can cause the message to exceed the maximum size allowed in the dead-letter queue.

If you're using Amazon SQS as an event source, configure a dead-letter queue on the Amazon SQS queue itself and not on the Lambda function. For more information, see [Using Lambda with Amazon SQS](#).

How Lambda processes records from stream and queue-based event sources

An *event source mapping* is a Lambda resource that reads items from stream and queue-based services and invokes a function with batches of records. Within an event source mapping, resources called *event pollers* actively poll for new messages and invoke functions. By default, Lambda automatically scales event pollers, but for certain event source types, you can use [provisioned mode](#) to control the minimum and maximum number of event pollers dedicated to your event source mapping.

The following services use event source mappings to invoke Lambda functions:

- [Amazon DocumentDB \(with MongoDB compatibility\) \(Amazon DocumentDB\)](#)
- [Amazon DynamoDB](#)
- [Amazon Kinesis](#)
- [Amazon MQ](#)
- [Amazon Managed Streaming for Apache Kafka \(Amazon MSK\)](#)
- [Self-managed Apache Kafka](#)
- [Amazon Simple Queue Service \(Amazon SQS\)](#)

Warning

Lambda event source mappings process each event at least once, and duplicate processing of records can occur. To avoid potential issues related to duplicate events, we strongly recommend that you make your function code idempotent. To learn more, see [How do I make my Lambda function idempotent](#) in the AWS Knowledge Center.

How event source mappings differ from direct triggers

Some AWS services can directly invoke Lambda functions using *triggers*. These services push events to Lambda, and the function is invoked immediately when the specified event occurs. Triggers are suitable for discrete events and real-time processing. When you [create a trigger using the Lambda console](#), the console interacts with the corresponding AWS service to configure the event notification on that service. The trigger is actually stored and managed by the service that

generates the events, not by Lambda. Here are some examples of services that use triggers to invoke Lambda functions:

- **Amazon Simple Storage Service (Amazon S3):** Invokes a function when an object is created, deleted, or modified in a bucket. For more information, see [Tutorial: Using an Amazon S3 trigger to invoke a Lambda function](#).
- **Amazon Simple Notification Service (Amazon SNS):** Invokes a function when a message is published to an SNS topic. For more information, see [Tutorial: Using AWS Lambda with Amazon Simple Notification Service](#).
- **Amazon API Gateway:** Invokes a function when an API request is made to a specific endpoint. For more information, see [Invoking a Lambda function using an Amazon API Gateway endpoint](#).

Event source mappings are Lambda resources created and managed within the Lambda service. Event source mappings are designed for processing high-volume streaming data or messages from queues. Processing records from a stream or queue in batches is more efficient than processing records individually.

Batching behavior

By default, an event source mapping batches records together into a single payload that Lambda sends to your function. To fine-tune batching behavior, you can configure a batching window ([MaximumBatchingWindowInSeconds](#)) and a batch size ([BatchSize](#)). A batching window is the maximum amount of time to gather records into a single payload. A batch size is the maximum number of records in a single batch. Lambda invokes your function when one of the following three criteria is met:

- **The batching window reaches its maximum value.** Default batching window behavior varies depending on the specific event source.
 - **For Kinesis, DynamoDB, and Amazon SQS event sources:** The default batching window is 0 seconds. This means that Lambda invokes your function as soon as records are available. To set a batching window, configure `MaximumBatchingWindowInSeconds`. You can set this parameter to any value from 0 to 300 seconds in increments of 1 second. If you configure a batching window, the next window begins as soon as the previous function invocation completes.
 - **For Amazon MSK, self-managed Apache Kafka, Amazon MQ, and Amazon DocumentDB event sources:** The default batching window is 500 ms. You can configure

`MaximumBatchingWindowInSeconds` to any value from 0 seconds to 300 seconds in increments of seconds. A batching window begins as soon as the first record arrives.

Note

Because you can only change `MaximumBatchingWindowInSeconds` in increments of seconds, you cannot revert to the 500 ms default batching window after you have changed it. To restore the default batching window, you must create a new event source mapping.

- **The batch size is met.** The minimum batch size is 1. The default and maximum batch size depend on the event source. For details about these values, see the [BatchSize](#) specification for the `CreateEventSourceMapping` API operation.
- **The payload size reaches [6 MB](#).** You cannot modify this limit.

The following diagram illustrates these three conditions. Suppose a batching window begins at $t = 7$ seconds. In the first scenario, the batching window reaches its 40 second maximum at $t = 47$ seconds after accumulating 5 records. In the second scenario, the batch size reaches 10 before the batching window expires, so the batching window ends early. In the third scenario, the maximum payload size is reached before the batching window expires, so the batching window ends early.

Max Batching Window = 40 Seconds
Max Batch Size = 10
Max Batch Size in Bytes = 6 MB

(1) Batching Window Expires

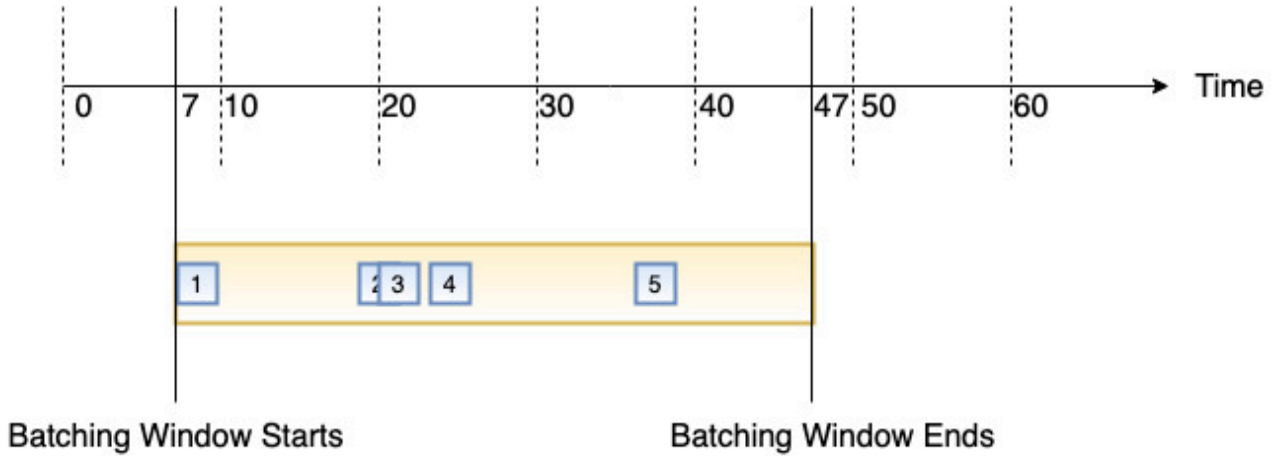

(2) Batching Size is reached

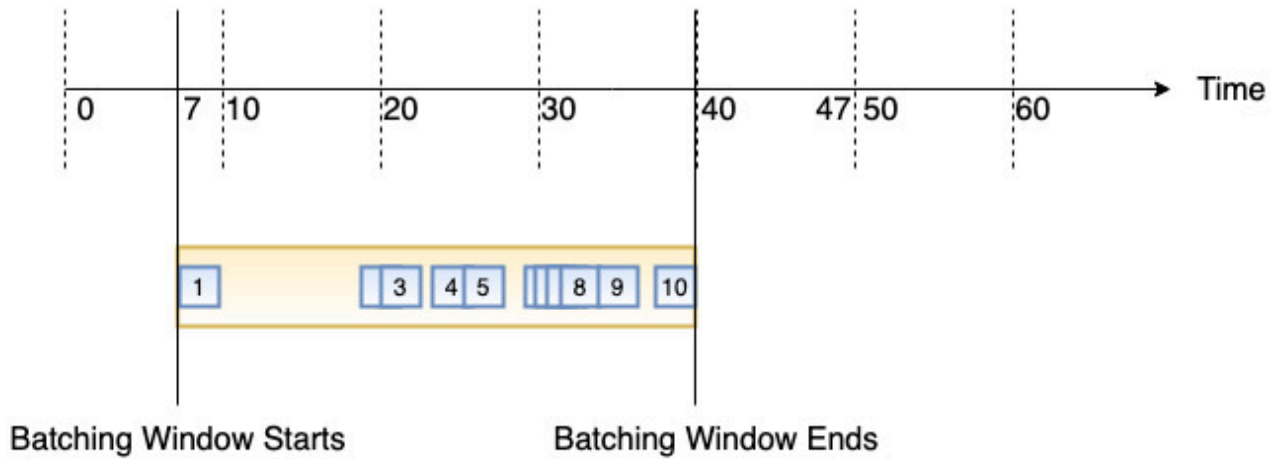

(3) Batch Size in bytes is reached

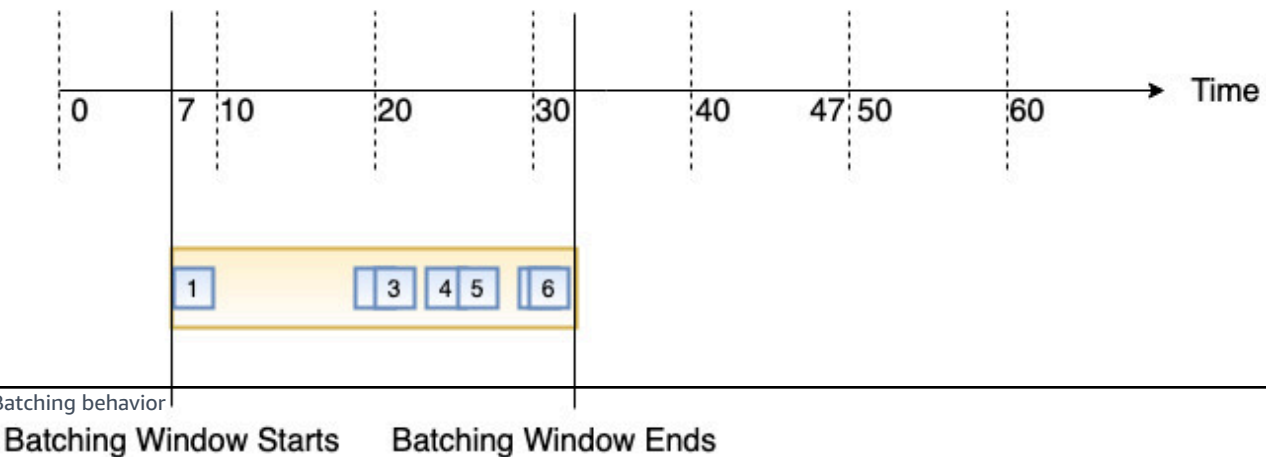

We recommend that you test with different batch and record sizes so that the polling frequency of each event source is tuned to how quickly your function is able to complete its task. The [CreateEventSourceMapping](#) `BatchSize` parameter controls the maximum number of records that can be sent to your function with each invoke. A larger batch size can often more efficiently absorb the invoke overhead across a larger set of records, increasing your throughput.

Lambda doesn't wait for any configured [extensions](#) to complete before sending the next batch for processing. In other words, your extensions may continue to run as Lambda processes the next batch of records. This can cause throttling issues if you breach any of your account's [concurrency](#) settings or limits. To detect whether this is a potential issue, monitor your functions and check whether you're seeing higher [concurrency metrics](#) than expected for your event source mapping. Due to short times in between invokes, Lambda may briefly report higher concurrency usage than the number of shards. This can be true even for Lambda functions without extensions.

By default, if your function returns an error, the event source mapping reprocesses the entire batch until the function succeeds, or the items in the batch expire. To ensure in-order processing, the event source mapping pauses processing for the affected shard until the error is resolved. For stream sources (DynamoDB and Kinesis), you can configure the maximum number of times that Lambda retries when your function returns an error. Service errors or throttles where the batch does not reach your function do not count toward retry attempts. You can also configure the event source mapping to send an invocation record to a [destination](#) when it discards an event batch.

Provisioned mode

Lambda event source mappings use event pollers to poll your event source for new messages. By default, Lambda manages the autoscaling of these pollers depending on message volume. When message traffic increases, Lambda automatically increases the number of event pollers to handle the load, and reduces them when traffic decreases.

In provisioned mode, you can fine-tune the throughput of your event source mapping by defining minimum and maximum limits for the number of provisioned event pollers. Lambda then scales your event source mapping between the minimum and maximum number of event pollers in a responsive manner. These provisioned event pollers are dedicated to your event source mapping, enhancing your ability to handle unpredictable spikes in events.

In Lambda, an event poller is a compute unit capable of handling up to 5 MBps of throughput. For reference, suppose your event source produces an average payload of 1MB, and the average function duration is 1 sec. If the payload doesn't undergo any transformation (such as filtering),

a single poller can support 5 MBps throughput, and 5 concurrent Lambda invocations. Using provisioned mode incurs additional costs. For pricing estimates, see [AWS Lambda pricing](#).

Provisioned mode is supported only for Amazon MSK and self-managed Apache Kafka event sources. While concurrency settings give you control over the scaling of your function, provisioned mode gives you control over the throughput of your event source mapping. To ensure maximum performance, you may need to adjust both settings independently. For details about configuring provisioned mode, see the following sections:

- [Configuring provisioned mode for Amazon MSK event source mappings](#)
- [Configuring provisioned mode for self-managed Apache Kafka event source mappings](#)

After configuring provisioned mode, you can observe the usage of event pollers for your workload by monitoring the `ProvisionedPollers` metric. For more information, see [the section called "Event source mapping metrics"](#).

Event source mapping API

To manage an event source with the [AWS Command Line Interface \(AWS CLI\)](#) or an [AWS SDK](#), you can use the following API operations:

- [CreateEventSourceMapping](#)
- [ListEventSourceMappings](#)
- [GetEventSourceMapping](#)
- [UpdateEventSourceMapping](#)
- [DeleteEventSourceMapping](#)

Using tags on event source mappings

You can tag event source mappings to organize and manage your resources. Tags are free-form key-value pairs associated with your resources that are supported across AWS services. For more information about use cases for tags, see [Common tagging strategies](#) in the *Tagging AWS Resources and Tag Editor Guide*.

Event source mappings are associated with functions, which can have their own tags. Event source mappings do not automatically inherit tags from functions. You can use the AWS Lambda API to

view and update tags. You can also view and update tags while managing a specific event source mapping in the Lambda console.

Permissions required for working with tags

To allow an AWS Identity and Access Management (IAM) identity (user, group, or role) to read or set tags on a resource, grant it the corresponding permissions:

- **lambda:ListTags**—When a resource has tags, grant this permission to anyone who needs to call `ListTags` on it. For tagged functions, this permission is also necessary for `GetFunction`.
- **lambda:TagResource**—Grant this permission to anyone who needs to call `TagResource` or perform a tag on create.

Optionally, consider granting the **lambda:UntagResource** permission as well to allow `UntagResource` calls to the resource.

For more information, see [Identity-based IAM policies for Lambda](#).

Using tags with the Lambda console

You can use the Lambda console to create event source mappings that have tags, add tags to existing event source mappings, and filter event source mappings by tag.

When you add a trigger for supported stream and queue-based services using the Lambda console, Lambda automatically creates an event source mapping. For more information about these event sources, see [the section called “Event source mappings”](#). To create an event source mapping in the console, you will need the following prerequisites:

- A function.
- An event source from an affected service.

You can add the tags as part of the same user interface you use to create or update triggers.

To add a tag when you create a event source mapping

1. Open the [Functions page](#) of the Lambda console.
2. Choose the name of your function.
3. Under **Function overview**, choose **Add trigger**.

4. Under **Trigger configuration**, in the dropdown list, choose the name of the service your event source comes from.
5. Provide the core configuration for your event source. For more information about configuring your event source, consult the section for the related service in [Integrating other services](#).
6. Under **Event source mapping configuration**, choose **Additional settings**.
7. Under **Tags**, choose **Add new tag**
8. In the **Key** field, enter your tag key. For information about tagging restrictions, see [Tag naming limits and requirements](#) in the *Tagging AWS Resources and Tag Editor Guide*.
9. Choose **Add**.

To add tags to an existing event source mapping

1. Open [Event source mappings](#) in the Lambda console.
2. From the resource list, choose the **UUID** for the event source mapping corresponding to your **Function** and **Event source ARN**.
3. From the tab list below the **General configuration pane**, choose **Tags**.
4. Choose **Manage tags**.
5. Choose **Add new tag**.
6. In the **Key** field, enter your tag key. For information about tagging restrictions, see [Tag naming limits and requirements](#) in the *Tagging AWS Resources and Tag Editor Guide*.
7. Choose **Save**.

To filter event source mappings by tag

1. Open [Event source mappings](#) in the Lambda console.
2. Choose the search box.
3. From the dropdown list, select your tag key from below the **Tags** subheading.
4. Select **Use: "tag-name"** to see all event source mappings tagged with this key, or choose an **Operator** to further filter by value.
5. Select your tag value to filter by a combination of tag key and value.

The search box also supports searching for tag keys. Enter the name of a key to find it in the list.

Using tags with the AWS CLI

You can add and remove tags on existing Lambda resources, including event source mappings, with the Lambda API. You can also add tags when creating an event source mapping, which allows you to keep a resource tagged through its entire lifecycle.

Updating tags with the Lambda tag APIs

You can add and remove tags for supported Lambda resources through the [TagResource](#) and [UntagResource](#) API operations.

You can call these operations using the AWS CLI. To add tags to an existing resource, use the `tag-resource` command. This example adds two tags, one with the key *Department* and one with the key *CostCenter*.

```
aws lambda tag-resource \  
--resource arn:aws:lambda:us-east-2:123456789012:resource-type:my-resource \  
--tags Department=Marketing,CostCenter=1234ABCD
```

To remove tags, use the `untag-resource` command. This example removes the tag with the key *Department*.

```
aws lambda untag-resource --resource arn:aws:lambda:us-east-1:123456789012:resource-  
type:resource-identifier \  
--tag-keys Department
```

Adding tags when you create an event source mapping

To create a new Lambda event source mapping with tags, use the [CreateEventSourceMapping](#) API operation. Specify the `Tags` parameter. You can call this operation with the `create-event-source-mapping` AWS CLI command and the `--tags` option. For more information about the CLI command, see [create-event-source-mapping](#) in the *AWS CLI Command Reference*.

Before using the `Tags` parameter with `CreateEventSourceMapping`, ensure that your role has permission to tag resources alongside the usual permissions needed for this operation. For more information about permissions for tagging, see [the section called "Permissions required for working with tags"](#).

Viewing tags with the Lambda tag APIs

To view the tags that are applied to a specific Lambda resource, use the `ListTags` API operation. For more information, see [ListTags](#).

You can call this operation with the `list-tags` AWS CLI command by providing an ARN (Amazon Resource Name).

```
aws lambda list-tags --resource arn:aws:lambda:us-east-1:123456789012:resource-  
type:resource-identifier
```

Filtering resources by tag

You can use the AWS Resource Groups Tagging API [GetResources](#) API operation to filter your resources by tags. The `GetResources` operation receives up to 10 filters, with each filter containing a tag key and up to 10 tag values. You provide `GetResources` with a `ResourceType` to filter by specific resource types.

You can call this operation using the `get-resources` AWS CLI command. For examples of using `get-resources`, see [get-resources](#) in the *AWS CLI Command Reference*.

Control which events Lambda sends to your function

You can use event filtering to control which records from a stream or queue Lambda sends to your function. For example, you can add a filter so that your function only processes Amazon SQS messages containing certain data parameters. Event filtering works only with certain event source mappings. You can add filters to event source mappings for the following AWS services:

- Amazon DynamoDB
- Amazon Kinesis Data Streams
- Amazon MQ
- Amazon Managed Streaming for Apache Kafka (Amazon MSK)
- Self-managed Apache Kafka
- Amazon Simple Queue Service (Amazon SQS)

For specific information about filtering with specific event sources, see [the section called “Using filters with different AWS services”](#). Lambda doesn't support event filtering for Amazon DocumentDB.

By default, you can define up to five different filters for a single event source mapping. Your filters are logically ORed together. If a record from your event source satisfies one or more of your filters, Lambda includes the record in the next event it sends to your function. If none of your filters are satisfied, Lambda discards the record.

Note

If you need to define more than five filters for an event source, you can request a quota increase for up to 10 filters for each event source. If you attempt to add more filters than your current quota permits, Lambda will return an error when you try to create the event source.

Topics

- [Understanding event filtering basics](#)
- [Handling records that don't meet filter criteria](#)
- [Filter rule syntax](#)

- [Attaching filter criteria to an event source mapping \(console\)](#)
- [Attaching filter criteria to an event source mapping \(AWS CLI\)](#)
- [Attaching filter criteria to an event source mapping \(AWS SAM\)](#)
- [Encryption of filter criteria](#)
- [Using filters with different AWS services](#)

Understanding event filtering basics

A filter criteria (`FilterCriteria`) object is a structure that consists of a list of filters (`Filters`). Each filter is a structure that defines an event filtering pattern (`Pattern`). A pattern is a string representation of a JSON filter rule. The structure of a `FilterCriteria` object is as follows.

```
{
  "Filters": [
    {
      "Pattern": "{ \"Metadata1\": [ rule1 ], \"data\": { \"Data1\":
[ rule2 ] } }"
    }
  ]
}
```

For added clarity, here is the value of the filter's `Pattern` expanded in plain JSON.

```
{
  "Metadata1": [ rule1 ],
  "data": {
    "Data1": [ rule2 ]
  }
}
```

Your filter pattern can include metadata properties, data properties, or both. The available metadata parameters and the format of the data parameters vary according to the AWS service which is acting as the event source. For example, suppose your event source mapping receives the following record from an Amazon SQS queue:

```
{
  "messageId": "059f36b4-87a3-44ab-83d2-661975830a7d",
```

```

"receiptHandle": "AQEBwJnKyrHigUMZj6rYigCgxlaS3SLy0a...",
"body": "{\n "City": "Seattle",\n "State": "WA",\n "Temperature": "46"\n}",
"attributes": {
  "ApproximateReceiveCount": "1",
  "SentTimestamp": "1545082649183",
  "SenderId": "AIDAIENQZJOL023YVJ4V0",
  "ApproximateFirstReceiveTimestamp": "1545082649185"
},
"messageAttributes": {},
"md5ofBody": "e4e68fb7bd0e697a0ae8f1bb342846b3",
"eventSource": "aws:sqs",
"eventSourceARN": "arn:aws:sqs:us-east-2:123456789012:my-queue",
"awsRegion": "us-east-2"
}

```

- **Metadata properties** are the fields containing information about the event that created the record. In the example Amazon SQS record, the metadata properties include fields such as `messageID`, `eventSourceArn`, and `awsRegion`.
- **Data properties** are the fields of the record containing the data from your stream or queue. In the Amazon SQS event example, the key for the data field is `body`, and the data properties are the fields `City`, `State`, and `Temperature`.

Different types of event source use different key values for their data fields. To filter on data properties, make sure that you use the correct key in your filter's pattern. For a list of data filtering keys, and to see examples of filter patterns for each supported AWS service, refer to [Using filters with different AWS services](#).

Event filtering can handle multi-level JSON filtering. For example, consider the following fragment of a record from a DynamoDB stream:

```

"dynamodb": {
  "Keys": {
    "ID": {
      "S": "ABCD"
    }
    "Number": {
      "N": "1234"
    }
  },
  ...
}

```

Suppose you want to process only those records where the value of the sort key `Number` is `4567`. In this case, your `FilterCriteria` object would look like this:

```
{
  "Filters": [
    {
      "Pattern": "{ \"dynamodb\": { \"Keys\": { \"Number\": { \"N\": [ \"4567\" ] } } } }"
    }
  ]
}
```

For added clarity, here is the value of the filter's `Pattern` expanded in plain JSON.

```
{
  "dynamodb": {
    "Keys": {
      "Number": {
        "N": [ "4567" ]
      }
    }
  }
}
```

Handling records that don't meet filter criteria

How Lambda handles records that don't meet your filter criteria depends on the event source.

- For **Amazon SQS**, if a message doesn't satisfy your filter criteria, Lambda automatically removes the message from the queue. You don't have to manually delete these messages in Amazon SQS.
- For **Kinesis** and **DynamoDB**, after your filter criteria evaluates a record, the streams iterator advances past this record. If the record doesn't satisfy your filter criteria, you don't have to manually delete the record from your event source. After the retention period, Kinesis and DynamoDB automatically delete these old records. If you want records to be deleted sooner, see [Changing the Data Retention Period](#).
- For **Amazon MSK**, **self-managed Apache Kafka**, and **Amazon MQ** messages, Lambda drops messages that don't match all fields included in the filter. For Amazon MSK and self-managed Apache Kafka, Lambda commits offsets for matched and unmatched messages after successfully invoking the function. For Amazon MQ, Lambda acknowledges matched messages after successfully invoking the function, and acknowledges unmatched messages when filtering them.

Filter rule syntax

For filter rules, Lambda supports the Amazon EventBridge rules and uses the same syntax as EventBridge. For more information, see [Amazon EventBridge event patterns](#) in the *Amazon EventBridge User Guide*.

The following is a summary of all the comparison operators available for Lambda event filtering.

Comparison operator	Example	Rule syntax
Null	UserID is null	"UserID": [null]
Empty	LastName is empty	"LastName": [""]
Equals	Name is "Alice"	"Name": ["Alice"]
Equals (ignore case)	Name is "Alice"	"Name": [{ "equals-ignore-case": "alice" }]
And	Location is "New York" and Day is "Monday"	"Location": ["New York"], "Day": ["Monday"]
Or	PaymentType is "Credit" or "Debit"	"PaymentType": ["Credit", "Debit"]
Or (multiple fields)	Location is "New York", or Day is "Monday".	"\$or": [{ "Location": ["New York"] }, { "Day": ["Monday"] }]
Not	Weather is anything but "Raining"	"Weather": [{ "anything-but": ["Raining"] }]
Numeric (equals)	Price is 100	"Price": [{ "numeric": ["=", 100] }]
Numeric (range)	Price is more than 10, and less than or equal to 20	"Price": [{ "numeric": [">", 10, "<=", 20] }]
Exists	ProductName exists	"ProductName": [{ "exists": true }]

Comparison operator	Example	Rule syntax
Does not exist	ProductName does not exist	"ProductName": [{ "exists": false }]
Begins with	Region is in the US	"Region": [{"prefix": "us-"}]
Ends with	FileName ends with a .png extension.	"FileName": [{ "suffix": ".png" }]

Note

Like EventBridge, for strings, Lambda uses exact character-by-character matching without case-folding or any other string normalization. For numbers, Lambda also uses string representation. For example, 300, 300.0, and 3.0e2 are not considered equal.

Note that the Exists operator only works on leaf nodes in your event source JSON. It doesn't match intermediate nodes. For example, with the following JSON, the filter pattern { "person": { "address": [{ "exists": true }] } } wouldn't find a match because "address" is an intermediate node.

```
{
  "person": {
    "name": "John Doe",
    "age": 30,
    "address": {
      "street": "123 Main St",
      "city": "Anytown",
      "country": "USA"
    }
  }
}
```

Attaching filter criteria to an event source mapping (console)

Follow these steps to create a new event source mapping with filter criteria using the Lambda console.

To create a new event source mapping with filter criteria (console)

1. Open the [Functions page](#) of the Lambda console.
2. Choose the name of a function to create an event source mapping for.
3. Under **Function overview**, choose **Add trigger**.
4. For **Trigger configuration**, choose a trigger type that supports event filtering. For a list of supported services, refer to the list at the beginning of this page.
5. Expand **Additional settings**.
6. Under **Filter criteria**, choose **Add**, and then define and enter your filters. For example, you can enter the following.

```
{ "Metadata" : [ 1, 2 ] }
```

This instructs Lambda to process only the records where field Metadata is equal to 1 or 2. You can continue to select **Add** to add more filters up to the maximum allowed amount.

7. When you have finished adding your filters, choose **Save**.

When you enter filter criteria using the console, you enter only the filter pattern and don't need to provide the Pattern key or escape quotes. In step 6 of the preceding instructions, { "Metadata" : [1, 2] } corresponds to the following FilterCriteria.

```
{
  "Filters": [
    {
      "Pattern": "{ \"Metadata\" : [ 1, 2 ] }"
    }
  ]
}
```

After creating your event source mapping in the console, you can see the formatted FilterCriteria in the trigger details. For more examples of creating event filters using the console, see [Using filters with different AWS services](#).

Attaching filter criteria to an event source mapping (AWS CLI)

Suppose you want an event source mapping to have the following FilterCriteria:

```
{
  "Filters": [
    {
      "Pattern": "{ \"Metadata\" : [ 1, 2 ] }"
    }
  ]
}
```

To create a new event source mapping with these filter criteria using the AWS Command Line Interface (AWS CLI), run the following command.

```
aws lambda create-event-source-mapping \
  --function-name my-function \
  --event-source-arn arn:aws:sqs:us-east-2:123456789012:my-queue \
  --filter-criteria '{"Filters": [{"Pattern": "{ \"Metadata\" : [ 1, 2 ] }"}]}'
```

This [create-event-source-mapping](#) command creates a new Amazon SQS event source mapping for function `my-function` with the specified `FilterCriteria`.

To add these filter criteria to an existing event source mapping, run the following command.

```
aws lambda update-event-source-mapping \
  --uuid "a1b2c3d4-5678-90ab-cdef-11111EXAMPLE" \
  --filter-criteria '{"Filters": [{"Pattern": "{ \"Metadata\" : [ 1, 2 ] }"}]}'
```

Note that to update an event source mapping, you need its UUID. You can get the UUID from a [list-event-source-mappings](#) call. Lambda also returns the UUID in the [create-event-source-mapping](#) CLI response.

To remove filter criteria from an event source, you can run the following [update-event-source-mapping](#) command with an empty `FilterCriteria` object.

```
aws lambda update-event-source-mapping \
  --uuid "a1b2c3d4-5678-90ab-cdef-11111EXAMPLE" \
  --filter-criteria "{}"
```

For more examples of creating event filters using the AWS CLI, see [Using filters with different AWS services](#).

Attaching filter criteria to an event source mapping (AWS SAM)

Suppose you want to configure an event source in AWS SAM to use the following filter criteria:

```
{
  "Filters": [
    {
      "Pattern": "{ \"Metadata\" : [ 1, 2 ] }"
    }
  ]
}
```

To add these filter criteria to your event source mapping, insert the following snippet into the YAML template for your event source.

```
FilterCriteria:
  Filters:
    - Pattern: '{"Metadata": [1, 2]}'
```

For more information on creating and configuring an AWS SAM template for an event source mapping, see the [EventSource](#) section of the AWS SAM Developer Guide. For more examples of creating event filters using AWS SAM templates, see [Using filters with different AWS services](#).

Encryption of filter criteria

By default, Lambda doesn't encrypt your filter criteria object. For use cases where you may include sensitive information in your filter criteria object, you can use your own [KMS key](#) to encrypt it.

After you encrypt your filter criteria object, you can view its plaintext version using a [GetEventSourceMapping](#) API call. You must have `kms:Decrypt` permissions to be able to successfully view the filter criteria in plaintext.

Note

If your filter criteria object is encrypted, Lambda redacts the value of the `FilterCriteria` field in the response of [ListEventSourceMappings](#) calls. Instead, this field displays as `null`. To see the true value of `FilterCriteria`, use the [GetEventSourceMapping](#) API. To view the decrypted value of `FilterCriteria` in the console, ensure that your IAM role contains permissions for [GetEventSourceMapping](#).

You can specify your own KMS key via the console, API/CLI, or AWS CloudFormation.

To encrypt filter criteria with a customer-owned KMS key (console)

1. Open the [Functions page](#) of the Lambda console.
2. Choose **Add trigger**. If you already have an existing trigger, choose the **Configuration** tab, and then choose **Triggers**. Select the existing trigger, and choose **Edit**.
3. Select the checkbox next to **Encrypt with customer managed KMS key**.
4. For **Choose a customer managed KMS encryption key**, select an existing enabled key or create a new key. Depending on the operation, you need some or all of the following permissions: `kms:DescribeKey`, `kms:GenerateDataKey`, and `kms:Decrypt`. Use the KMS key policy to grant these permissions.

If you use your own KMS key, the following API operations must be permitted in the [key policy](#):

- `kms:Decrypt` – Must be granted to the regional Lambda service principal (`lambda.AWS_region.amazonaws.com`). This allows Lambda to decrypt data with this KMS key.
- To prevent a [cross-service confused deputy problem](#), the key policy uses the `aws:SourceArn` global condition key. The correct value of the `aws:SourceArn` key is the ARN of your event source mapping resource, so you can add this to your policy only after you know its ARN. Lambda also forwards the `aws:lambda:FunctionArn` and `aws:lambda:EventSourceArn` keys and their respective values in the [encryption context](#) when making a decryption request to KMS. These values must match the specified conditions in the key policy for the decryption request to succeed. You don't need to include `EventSourceArn` for Self-managed Kafka event sources since they don't have an `EventSourceArn`.
- `kms:Decrypt` – Must also be granted to the principal that intends to use the key to view the plaintext filter criteria in [GetEventSourceMapping](#) or [DeleteEventSourceMapping](#) API calls.
- `kms:DescribeKey` – Provides the customer managed key details to allow the specified principal to use the key.
- `kms:GenerateDataKey` – Provides permissions for Lambda to generate a data key to encrypt the filter criteria, on behalf of the specified principal ([envelope encryption](#)).

You can use AWS CloudTrail to track AWS KMS requests that Lambda makes on your behalf. For sample CloudTrail events, see [???](#).

We also recommend using the [kms:ViaService](#) condition key to limit the use of the KMS key to requests from Lambda only. The value of this key is the regional Lambda service principal (`lambda.AWS_region.amazonaws.com`). The following is a sample key policy that grants all the relevant permissions:

Example AWS KMS key policy

```
{
  "Version": "2012-10-17",
  "Id": "example-key-policy-1",
  "Statement": [
    {
      "Sid": "Allow Lambda to decrypt using the key",
      "Effect": "Allow",
      "Principal": {
        "Service": "lambda.us-east-1.amazonaws.com"
      },
      "Action": [
        "kms:Decrypt"
      ],
      "Resource": "*",
      "Condition": {
        "ArnEquals" : {
          "aws:SourceArn": [
            "arn:aws:lambda:us-east-1:123456789012:event-source-
mapping:<esm_uuid>"
          ]
        },
        "StringEquals": {
          "kms:EncryptionContext:aws:lambda:FunctionArn": "arn:aws:lambda:us-
east-1:123456789012:function:test-function",
          "kms:EncryptionContext:aws:lambda:EventSourceArn": "arn:aws:sqs:us-
east-1:123456789012:test-queue"
        }
      }
    },
    {
      "Sid": "Allow actions by an AWS account on the key",
      "Effect": "Allow",
      "Principal": {
        "AWS": "arn:aws:iam::123456789012:root"
      },
      "Action": "kms:*",

```

```

    "Resource": "*"
  },
  {
    "Sid": "Allow use of the key to specific roles",
    "Effect": "Allow",
    "Principal": {
      "AWS": "arn:aws:iam::123456789012:role/ExampleRole"
    },
    "Action": [
      "kms:Decrypt",
      "kms:DescribeKey",
      "kms:GenerateDataKey"
    ],
    "Resource": "*",
    "Condition": {
      "StringEquals" : {
        "kms:ViaService": "lambda.us-east-1.amazonaws.com"
      }
    }
  }
]
}

```

To use your own KMS key to encrypt filter criteria, you can also use the following [CreateEventSourceMapping](#) AWS CLI command. Specify the KMS key ARN with the `--kms-key-arn` flag.

```

aws lambda create-event-source-mapping --function-name my-function \
  --maximum-batching-window-in-seconds 60 \
  --event-source-arn arn:aws:sqs:us-east-1:123456789012:my-queue \
  --filter-criteria "{\"filters\": [{\"pattern\": \"{\\\"a\\\": [\\\"1\\\", \\\"2\\\"]}\" }]}\" \
  --kms-key-arn arn:aws:kms:us-east-1:123456789012:key/055efbb4-xmpl-4336-
ba9c-538c7d31f599

```

If you have an existing event source mapping, use the [UpdateEventSourceMapping](#) AWS CLI command instead. Specify the KMS key ARN with the `--kms-key-arn` flag.

```

aws lambda update-event-source-mapping --function-name my-function \
  --maximum-batching-window-in-seconds 60 \
  --event-source-arn arn:aws:sqs:us-east-1:123456789012:my-queue \
  --filter-criteria "{\"filters\": [{\"pattern\": \"{\\\"a\\\": [\\\"1\\\", \\\"2\\\"]}\" }]}\" \

```



```
--kms-key-arn arn:aws:kms:us-east-1:123456789012:key/055efbb4-xmpl-4336-
ba9c-538c7d31f599
```

This operation overwrites any KMS key that was previously specified. If you specify the `--kms-key-arn` flag along with an empty argument, Lambda stops using your KMS key to encrypt filter criteria. Instead, Lambda defaults back to using an Amazon-owned key.

To specify your own KMS key in a AWS CloudFormation template, use the `KMSKeyArn` property of the `AWS::Lambda::EventSourceMapping` resource type. For example, you can insert the following snippet into the YAML template for your event source.

```
MyEventSourceMapping:
  Type: AWS::Lambda::EventSourceMapping
  Properties:
    ...
    FilterCriteria:
      Filters:
        - Pattern: '{"a": [1, 2]}'
      KMSKeyArn: "arn:aws:kms:us-east-1:123456789012:key/055efbb4-xmpl-4336-
ba9c-538c7d31f599"
    ...
```

To be able to view your encrypted filter criteria in plaintext in a [GetEventSourceMapping](#) or [DeleteEventSourceMapping](#) API call, you must have `kms:Decrypt` permissions.

Starting August 6, 2024, the `FilterCriteria` field no longer shows up in AWS CloudTrail logs from [CreateEventSourceMapping](#), [UpdateEventSourceMapping](#), and [DeleteEventSourceMapping](#) API calls if your function doesn't use event filtering. If your function does use event filtering, the `FilterCriteria` field shows up as empty (`{}`). You can still view your filter criteria in plaintext in the response of [GetEventSourceMapping](#) API calls if you have `kms:Decrypt` permissions for the correct KMS key.

Sample CloudTrail log entry for Create/Update/DeleteEventSourceMapping calls

In the following AWS CloudTrail sample log entry for a `CreateEventSourceMapping` call, `FilterCriteria` shows up as empty (`{}`) because the function uses event filtering. This is the case even if `FilterCriteria` object contains valid filter criteria that your function is actively using. If the function doesn't use event filtering, CloudTrail won't display the `FilterCriteria` field at all in log entries.

```
{
```

```
"eventVersion": "1.08",
"userIdentity": {
  "type": "AssumedRole",
  "principalId": "AR0A123456789EXAMPLE:user1",
  "arn": "arn:aws:sts::123456789012:assumed-role/Example/example-role",
  "accountId": "123456789012",
  "accessKeyId": "ASIAIOSFODNN7EXAMPLE",
  "sessionContext": {
    "sessionIssuer": {
      "type": "Role",
      "principalId": "AR0A987654321EXAMPLE",
      "arn": "arn:aws:iam::123456789012:role/User1",
      "accountId": "123456789012",
      "userName": "User1"
    },
    "webIdFederationData": {},
    "attributes": {
      "creationDate": "2024-05-09T20:35:01Z",
      "mfaAuthenticated": "false"
    }
  },
  "invokedBy": "AWS Internal"
},
"eventTime": "2024-05-09T21:05:41Z",
"eventSource": "lambda.amazonaws.com",
"eventName": "CreateEventSourceMapping20150331",
"awsRegion": "us-east-2",
"sourceIPAddress": "AWS Internal",
"userAgent": "AWS Internal",
"requestParameters": {
  "eventSourceArn": "arn:aws:sqs:us-east-2:123456789012:example-queue",
  "functionName": "example-function",
  "enabled": true,
  "batchSize": 10,
  "filterCriteria": {},
  "kMSKeyArn": "arn:aws:kms:us-east-2:123456789012:key/a1b2c3d4-5678-90ab-cdef-EXAMPLE11111",
  "scalingConfig": {},
  "maximumBatchingWindowInSeconds": 0,
  "sourceAccessConfigurations": []
},
"responseElements": {
  "uUID": "a1b2c3d4-5678-90ab-cdef-EXAMPLEEaaaaa",
  "batchSize": 10,
```

```

    "maximumBatchingWindowInSeconds": 0,
    "eventSourceArn": "arn:aws:sqs:us-east-2:123456789012:example-queue",
    "filterCriteria": {},
    "kMSKeyArn": "arn:aws:kms:us-east-2:123456789012:key/a1b2c3d4-5678-90ab-cdef-
EXAMPLE11111",
    "functionArn": "arn:aws:lambda:us-east-2:123456789012:function:example-
function",
    "lastModified": "May 9, 2024, 9:05:41 PM",
    "state": "Creating",
    "stateTransitionReason": "USER_INITIATED",
    "functionResponseTypes": [],
    "eventSourceMappingArn": "arn:aws:lambda:us-east-2:123456789012:event-source-
mapping:a1b2c3d4-5678-90ab-cdef-EXAMPLEbbbbbb"
  },
  "requestID": "a1b2c3d4-5678-90ab-cdef-EXAMPLE33333",
  "eventID": "a1b2c3d4-5678-90ab-cdef-EXAMPLE22222",
  "readOnly": false,
  "eventType": "AwsApiCall",
  "managementEvent": true,
  "recipientAccountId": "123456789012",
  "eventCategory": "Management",
  "sessionCredentialFromConsole": "true"
}

```

Using filters with different AWS services

Different types of event source use different key values for their data fields. To filter on data properties, make sure that you use the correct key in your filter's pattern. The following table gives the filtering keys for each supported AWS service.

AWS service	Filtering key
DynamoDB	dynamodb
Kinesis	data
Amazon MQ	data
Amazon MSK	value
Self-managed Apache Kafka	value

AWS service	Filtering key
Amazon SQS	body

The following sections give examples of filter patterns for different types of event sources. They also provide definitions of supported incoming data formats and filter pattern body formats for each supported service.

- [the section called “Event filtering”](#)
- [the section called “Event filtering”](#)
- [the section called “Event filtering”](#)
- [the section called “Event filtering”](#)
- [the section called “Event filtering”](#)
- [the section called “Event filtering”](#)

Testing Lambda functions in the console

You can test your Lambda function in the console by invoking your function with a test event. A *test event* is a JSON input to your function. If your function doesn't require input, the event can be an empty document (`{}`).

When you run a test in the console, Lambda synchronously invokes your function with the test event. The function runtime converts the event JSON into an object and passes it to your code's handler method for processing.

Create a test event

Before you can test in the console, you need to create a private or shareable test event.

Invoking functions with test events

To test a function

1. Open the [Functions page](#) of the Lambda console.
2. Choose the name of the function that you want to test.
3. Choose the **Test** tab.
4. Under **Test event**, choose **Create new event** or **Edit saved event** and then choose the saved event that you want to use.
5. Optionally - choose a **Template** for the event JSON.
6. Choose **Test**.
7. To review the test results, under **Execution result**, expand **Details**.

To invoke your function without saving your test event, choose **Test** before saving. This creates an unsaved test event that Lambda preserves only for the duration of the session.

For the Node.js, Python, and Ruby runtimes, you can also access your existing saved and unsaved test events on the **Code** tab. Use the **TEST EVENTS** section to create, edit, and run tests.

Creating private test events

Private test events are available only to the event creator, and they require no additional permissions to use. You can create and save up to 10 private test events per function.

To create a private test event

1. Open the [Functions page](#) of the Lambda console.
2. Choose the name of the function that you want to test.
3. Choose the **Test** tab.
4. Under **Test event**, do the following:
 - a. Choose a **Template**.
 - b. Enter a **Name** for the test.
 - c. In the text entry box, enter the JSON test event.
 - d. Under **Event sharing settings**, choose **Private**.
5. Choose **Save changes**.

For the Node.js, Python, and Ruby runtimes, you can also create test events on the **Code** tab. Use the **TEST EVENTS** section to create, edit, and run tests.

Creating shareable test events

Shareable test events are test events that you can share with other users in the same AWS account. You can edit other users' shareable test events and invoke your function with them.

Lambda saves shareable test events as schemas in an [Amazon EventBridge \(CloudWatch Events\) schema registry](#) named `lambda-testevent-schemas`. As Lambda utilizes this registry to store and call shareable test events you create, we recommend that you do not edit this registry or create a registry using the `lambda-testevent-schemas` name.

To see, share, and edit shareable test events, you must have permissions for all of the following [EventBridge \(CloudWatch Events\) schema registry API operations](#):

- [schemas.CreateRegistry](#)
- [schemas.CreateSchema](#)
- [schemas.DeleteSchema](#)

- [schemas.DeleteSchemaVersion](#)
- [schemas.DescribeRegistry](#)
- [schemas.DescribeSchema](#)
- [schemas.GetDiscoveredSchema](#)
- [schemas.ListSchemaVersions](#)
- [schemas.UpdateSchema](#)

Note that saving edits made to a shareable test event overwrites that event.

If you cannot create, edit, or see shareable test events, check that your account has the required permissions for these operations. If you have the required permissions but still cannot access shareable test events, check for any [resource-based policies](#) that might limit access to the EventBridge (CloudWatch Events) registry.

To create a shareable test event

1. Open the [Functions page](#) of the Lambda console.
2. Choose the name of the function that you want to test.
3. Choose the **Test** tab.
4. Under **Test event**, do the following:
 - a. Choose a **Template**.
 - b. Enter a **Name** for the test.
 - c. In the text entry box, enter the JSON test event.
 - d. Under **Event sharing settings**, choose **Shareable**.
5. Choose **Save changes**.

Use shareable test events with AWS Serverless Application Model.

You can use AWS SAM to invoke shareable test events. See [sam remote test-event](#) in the [AWS Serverless Application Model Developer Guide](#)

Deleting shareable test event schemas

When you delete shareable test events, Lambda removes them from the `lambda-testevent-schemas` registry. If you remove the last shareable test event from the registry, Lambda deletes the registry.

If you delete the function, Lambda does not delete any associated shareable test event schemas. You must clean up these resources manually from the [EventBridge \(CloudWatch Events\) console](#).

Lambda function states

Lambda includes a state field in the function configuration for all functions to indicate when your function is ready to invoke. State provides information about the current status of the function, including whether you can successfully invoke the function. Function states do not change the behavior of function invocations or how your function runs the code. Function states include:

- **Pending** – After Lambda creates the function, it sets the state to pending. While in pending state, Lambda attempts to create or configure resources for the function, such as VPC or EFS resources. Lambda does not invoke a function during pending state. Any invocations or other API actions that operate on the function will fail.
- **Active** – Your function transitions to active state after Lambda completes resource configuration and provisioning. Functions can only be successfully invoked while active.
- **Failed** – Indicates that resource configuration or provisioning encountered an error.
- **Inactive** – A function becomes inactive when it has been idle long enough for Lambda to reclaim the external resources that were configured for it. When you try to invoke a function that is inactive, the invocation fails and Lambda sets the function to pending state until the function resources are recreated. If Lambda fails to recreate the resources, the function returns to the inactive state. If your function is stuck in the inactive state, refer to the function's `Status Code` and `Status Code Reason` attributes for further troubleshooting. You may need to resolve any errors and redeploy your function to restore it to the active state.

If you are using SDK-based automation workflows or calling Lambda's service APIs directly, ensure that you check a function's state before invocation to verify that it is active. You can do this with the Lambda API action [GetFunction](#), or by configuring a waiter using the [AWS SDK for Java 2.0](#).

```
aws lambda get-function --function-name my-function --query 'Configuration.[State, LastUpdateStatus]'
```

You should see the following output:

```
[  
  "Active",  
  "Successful"  
]
```

The following operations fail while function creation is pending:

- [Invoke](#)
- [UpdateFunctionCode](#)
- [UpdateFunctionConfiguration](#)
- [PublishVersion](#)

Function states while updating

Lambda provides additional context for functions undergoing updates with the `LastUpdateStatus` attribute, which can have the following statuses:

- `InProgress` – An update is happening on an existing function. While a function update is in progress, invocations go to the function's previous code and configuration.
- `Successful` – The update has completed. Once Lambda finishes the update, this stays set until a further update.
- `Failed` – The function update has failed. Lambda aborts the update and the function's previous code and configuration remain available.

Example

The following is the result of `get-function-configuration` on a function undergoing an update.

```
{
  "FunctionName": "my-function",
  "FunctionArn": "arn:aws:lambda:us-east-2:123456789012:function:my-function",
  "Runtime": "nodejs22.x",
  "VpcConfig": {
    "SubnetIds": [
      "subnet-071f712345678e7c8",
      "subnet-07fd123456788a036",
      "subnet-0804f77612345cacf"
    ],
    "SecurityGroupIds": [
      "sg-085912345678492fb"
    ],
    "VpcId": "vpc-08e1234569e011e83"
  },
  "State": "Active",
```

```
"LastUpdateStatus": "InProgress",  
  ...  
}
```

[FunctionConfiguration](#) has two other attributes, `LastUpdateStatusReason` and `LastUpdateStatusReasonCode`, to help troubleshoot issues with updating.

The following operations fail while an asynchronous update is in progress:

- [UpdateFunctionCode](#)
- [UpdateFunctionConfiguration](#)
- [PublishVersion](#)
- [TagResource](#)

Understanding retry behavior in Lambda

When you invoke a function directly, you determine the strategy for handling errors related to your function code. Lambda does not automatically retry these types of errors on your behalf. To retry, you can manually re-invoke your function, send the failed event to a queue for debugging, or ignore the error. Your function's code might have run completely, partially, or not at all. If you retry, ensure that your function's code can handle the same event multiple times without causing duplicate transactions or other unwanted side effects.

When you invoke a function indirectly, you need to be aware of the retry behavior of the invoker and any service that the request encounters along the way. This includes the following scenarios.

- **Asynchronous invocation** – Lambda retries function errors twice. If the function doesn't have enough capacity to handle all incoming requests, events might wait in the queue for hours to be sent to the function. You can configure a dead-letter queue on the function to capture events that weren't successfully processed. For more information, see [Invoking a Lambda function asynchronously](#).
- **Event source mappings** – Event source mappings that read from streams retry the entire batch of items. Repeated errors block processing of the affected shard until the error is resolved or the items expire. To detect stalled shards, you can monitor the [Iterator Age](#) metric.

For event source mappings that read from a queue, you determine the length of time between retries and destination for failed events by configuring the visibility timeout and redrive policy on the source queue. For more information, see [How Lambda processes records from stream and queue-based event sources](#) and the service-specific topics under [Invoking Lambda with events from other AWS services](#).

- **AWS services** – AWS services can invoke your function [synchronously](#) or asynchronously. For synchronous invocation, the service decides whether to retry. For example, Amazon S3 batch operations retries the operation if the Lambda function returns a `TemporaryFailure` response code. Services that proxy requests from an upstream user or client may have a retry strategy or may relay the error response back to the requester. For example, API Gateway always relays the error response back to the requester.

For asynchronous invocation, the retry logic is the same regardless of the invocation source. By default, Lambda retries a failed asynchronous invocation up to two times. For more information, see [How Lambda handles errors and retries with asynchronous invocation](#).

- **Other accounts and clients** – When you grant access to other accounts, you can use [resource-based policies](#) to restrict the services or resources they can configure to invoke your function. To protect your function from being overloaded, consider putting an API layer in front of your function with [Amazon API Gateway](#).

To help you deal with errors in Lambda applications, Lambda integrates with services like Amazon CloudWatch and AWS X-Ray. You can use a combination of logs, metrics, alarms, and tracing to quickly detect and identify issues in your function code, API, or other resources that support your application. For more information, see [Monitoring and troubleshooting Lambda functions](#).

Use Lambda recursive loop detection to prevent infinite loops

When you configure a Lambda function to output to the same service or resource that invokes the function, it's possible to create an infinite recursive loop. For example, a Lambda function might write a message to an Amazon Simple Queue Service (Amazon SQS) queue, which then invokes the same function. This invocation causes the function to write another message to the queue, which in turn invokes the function again.

Unintentional recursive loops can result in unexpected charges being billed to your AWS account. Loops can also cause Lambda to [scale](#) and use all of your account's available concurrency. To help reduce the impact of unintentional loops, Lambda detects certain types of recursive loops shortly after they occur. By default, when Lambda detects a recursive loop, it stops your function being invoked and notifies you. If your design intentionally uses recursive patterns, you can change a function's default configuration to allow it to be invoked recursively. See [the section called "Allowing a Lambda function to run in a recursive loop"](#) for more information.

Sections

- [Understanding recursive loop detection](#)
- [Supported AWS services and SDKs](#)
- [Recursive loop notifications](#)
- [Responding to recursive loop detection notifications](#)
- [Allowing a Lambda function to run in a recursive loop](#)
- [Supported regions for Lambda recursive loop detection](#)

Understanding recursive loop detection

Recursive loop detection in Lambda works by tracking events. Lambda is an event-driven compute service that runs your function code when certain events occur. For example, when an item is added to an Amazon SQS queue or Amazon Simple Notification Service (Amazon SNS) topic. Lambda passes events to your function as JSON objects, which contain information about the change in the system state. When an event causes your function to run, this is called an *invocation*.

To detect recursive loops, Lambda uses [AWS X-Ray](#) tracing headers. When [AWS services that support recursive loop detection](#) send events to Lambda, those events are automatically annotated with metadata. When your Lambda function writes one of these events to another supported AWS

service using a [supported version of an AWS SDK](#), it updates this metadata. The updated metadata includes a count of the number of times that the event has invoked the function.

 **Note**

You don't need to enable X-Ray active tracing for this feature to work. Recursive loop detection is turned on by default for all AWS customers. There is no charge to use the feature.

A *chain of requests* is a sequence of Lambda invocations caused by the same triggering event. For example, imagine that an Amazon SQS queue invokes your Lambda function. Your Lambda function then sends the processed event back to the same Amazon SQS queue, which invokes your function again. In this example, each invocation of your function falls in the same chain of requests.

If your function is invoked approximately 16 times in the same chain of requests, then Lambda automatically stops the next function invocation in that request chain and notifies you. If your function is configured with multiple triggers, then invocations from other triggers aren't affected.

 **Note**

Even when the `maxReceiveCount` setting on the source queue's redrive policy is higher than 16, Lambda recursion protection does not prevent Amazon SQS from retrying the message after a recursive loop is detected and terminated. When Lambda detects a recursive loop and drops subsequent invocations, it returns a `RecursiveInvocationException` to the event source mapping. This increments the `receiveCount` value on the message. Lambda continues to retry the message, and continues to block function invocations, until Amazon SQS determines that the `maxReceiveCount` is exceeded and sends the message to the configured dead-letter queue.

If you have an [on-failure destination](#) or [dead-letter queue](#) configured for your function, then Lambda also sends the event from the stopped invocation to your destination or dead-letter queue. When configuring a destination or dead-letter queue for your function, be sure not to use an Amazon SNS topic or Amazon SQS queue that your function also uses as an event trigger or

event source mapping. If you send events to the same resource that invokes your function, then you can create another recursive loop.

Supported AWS services and SDKs

Lambda can detect only recursive loops that include certain supported AWS services. For recursive loops to be detected, your function must also use one of the supported AWS SDKs.

Supported AWS services

Lambda currently detects recursive loops between your functions, Amazon SQS, Amazon S3, and Amazon SNS. Lambda also detects loops comprised only of Lambda functions, which may invoke each other synchronously or asynchronously. The following diagrams show some examples of loops that Lambda can detect:

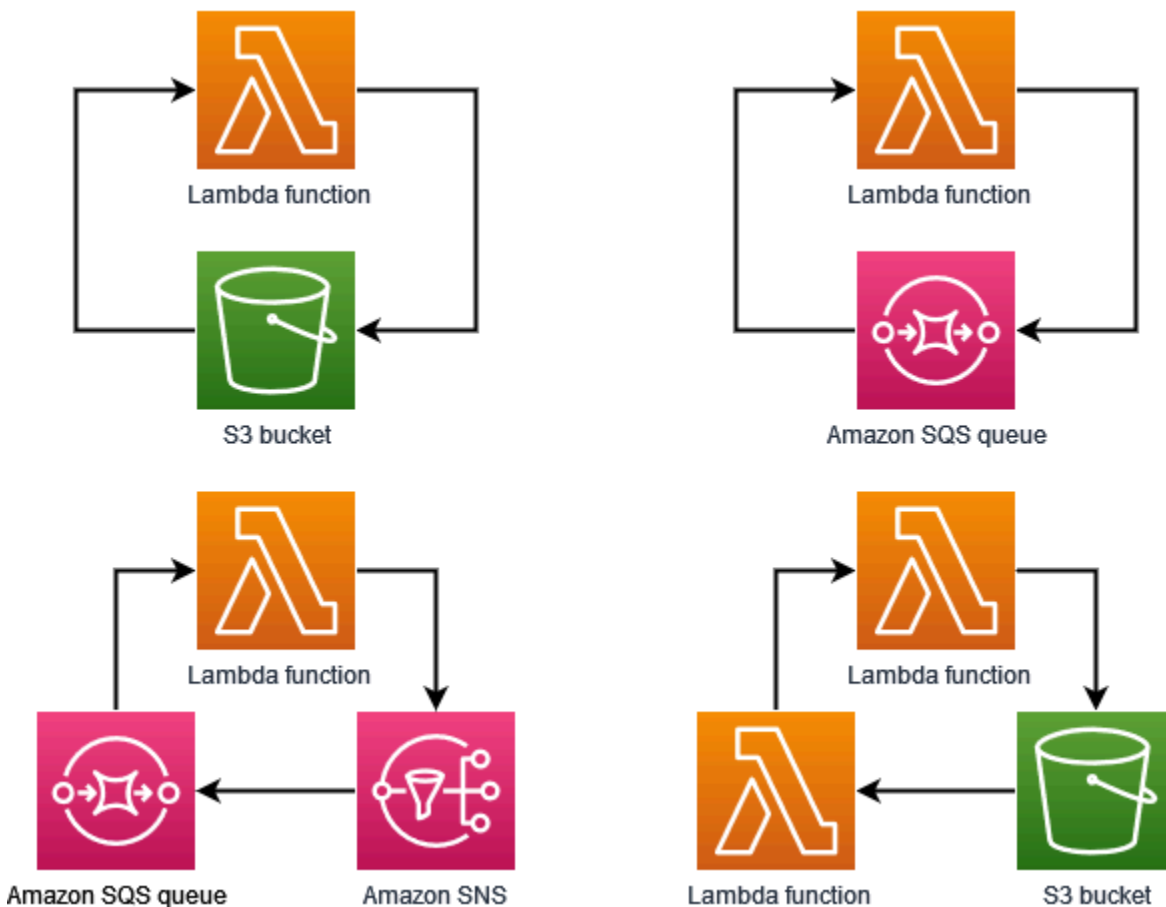

When another AWS service such as Amazon DynamoDB forms part of the loop, Lambda can't currently detect and stop it.

Because Lambda currently detects only recursive loops involving Amazon SQS, Amazon S3, and Amazon SNS, it's still possible that loops involving other AWS services can result in unintended usage of your Lambda functions.

To guard against unexpected charges being billed to your AWS account, we recommend that you configure [Amazon CloudWatch alarms](#) to alert you to unusual usage patterns. For example, you can configure CloudWatch to notify you about spikes in Lambda function concurrency or invocations. You can also configure a [billing alarm](#) to notify you when spending in your account exceeds a threshold that you specify. Or, you can use [AWS Cost Anomaly Detection](#) to alert you to unusual billing patterns.

Supported AWS SDKs

For Lambda to detect recursive loops, your function must use one of the following SDK versions or higher:

Runtime	Minimum required AWS SDK version
Node.js	2.1147.0 (SDK version 2)
	3.105.0 (SDK version 3)
Python	1.24.46 (boto3)
	1.27.46 (botocore)
Java 8 and Java 11	2.17.135
Java 17	2.20.81
Java 21	2.21.24
.NET	3.7.293.0
Ruby	3.134.0
PHP	3.232.0
Go	V2 SDK 1.57.0

Some Lambda runtimes such as Python and Node.js include a version of the AWS SDK. If the SDK version included in your function's runtime is lower than the minimum required, then you can add a supported version of the SDK to your function's deployment package. You can also add a supported SDK version to your function using a [Lambda layer](#). For a list of the SDKs included with each Lambda runtime, see [Lambda runtimes](#).

Recursive loop notifications

When Lambda stops a recursive loop, you receive notifications through the [AWS Health Dashboard](#) and through email. You can also use CloudWatch metrics to monitor the number of recursive invocations that Lambda has stopped.

AWS Health Dashboard notifications

When Lambda stops a recursive invocation, the AWS Health Dashboard displays a notification on the **Your account health** page, under [Open and recent issues](#). Note that it can take up to three hours after Lambda stops a recursive invocation before this notification is displayed. For more information about viewing account events in the AWS Health Dashboard, see [Getting started with your AWS Health Dashboard – Your account health](#) in the *AWS Health User Guide*.

Email alerts

When Lambda first stops a recursive invocation of your function, it sends you an email alert. Lambda sends a maximum of one email every 24 hours for each function in your AWS account. After Lambda sends an email notification, you won't receive any more emails for that function for another 24 hours, even if Lambda stops further recursive invocations of the function. Note that it can take up to three hours after Lambda stops a recursive invocation before you receive this email alert.

Lambda sends recursive loop email alerts to your AWS account's primary account contact and alternate operations contact. For information about viewing or updating the email addresses in your account, see [Updating contact information](#) in the *AWS General Reference*.

Amazon CloudWatch metrics

The [CloudWatch metric](#) `RecursiveInvocationsDropped` records the number of function invocations that Lambda has stopped because your function has been invoked more than approximately 16 times in a single chain of requests. Lambda emits this metric as soon as it stops a recursive invocation. To view this metric, follow the instructions for [Viewing metrics on the CloudWatch console](#) and choose the metric `RecursiveInvocationsDropped`.

Responding to recursive loop detection notifications

When your function is invoked more than approximately 16 times by the same triggering event, Lambda stops the next function invocation for that event to break the recursive loop. To prevent a reoccurrence of a recursive loop that Lambda has broken, do the following:

- Reduce your function's available [concurrency](#) to zero, which throttles all future invocations.
- Remove or disable the trigger or event source mapping that's invoking your function.
- Identify and fix code defects that write events back to the AWS resource that's invoking your function. A common source of defects occurs when you use variables to define a function's event source and target. Check that you're not using the same value for both variables.

Additionally, if the event source for your Lambda function is an Amazon SQS queue, then consider [configuring a dead-letter queue](#) on the source queue.

Note

Make sure that you configure the dead-letter queue on the source queue, not on the Lambda function. The dead-letter queue that you configure on a function is used for the function's [asynchronous invocation queue](#), not for event source queues.

If the event source is an Amazon SNS topic, then consider adding an [on-failure destination](#) for your function.

To reduce your function's available concurrency to zero (console)

1. Open the [Functions page](#) of the Lambda console.
2. Choose the name of your function.
3. Choose **Throttle**.
4. In the **Throttle your function** dialog box, choose **Confirm**.

To remove a trigger or event source mapping for your function (console)

1. Open the [Functions page](#) of the Lambda console.
2. Choose the name of your function.

3. Choose the **Configuration** tab, then choose **Triggers**.
4. Under **Triggers**, select the trigger or event source mapping that you want to delete, then choose **Delete**.
5. In the **Delete triggers** dialog box, choose **Delete**.

To disable an event source mapping for your function (AWS CLI)

1. To find the UUID for the event source mapping that you want to disable, run the AWS Command Line Interface (AWS CLI) [list-event-source-mappings](#) command.

```
aws lambda list-event-source-mappings
```

2. To disable the event source mapping, run the following AWS CLI [update-event-source-mapping](#) command.

```
aws lambda update-event-source-mapping --function-name MyFunction \  
--uuid a1b2c3d4-5678-90ab-cdef-EXAMPLE11111 --no-enabled
```

Allowing a Lambda function to run in a recursive loop

If your design intentionally uses a recursive loop, you can configure a Lambda function to allow it to be invoked recursively. We recommend that you avoid using recursive loops in your design. Implementation errors can lead to recursive invocations using all of your AWS account's available concurrency and to unexpected charges being billed to your account.

Important

If you use recursive loops, treat them with caution. Implement best practice guard rails to minimize the risks of implementation errors. To learn more about best practices for using recursive patterns, see [Recursive patterns that cause run-away Lambda functions](#) in Serverless Land.

You can configure functions to allow recursive loops using the Lambda console, the AWS Command Line Interface (AWS CLI), and the [PutFunctionRecursionConfig](#) API. You can also configure a function's recursive loop detection setting in AWS SAM and AWS CloudFormation.

By default, Lambda detects and terminates recursive loops. Unless your design intentionally uses a recursive loop, we recommend that you don't change your functions' default configuration.

Note that when you configure a function to allow recursive loops, the [CloudWatch metric RecursiveInvocationsDropped](#) isn't emitted.

Console

To allow a function to run in a recursive loop (console)

1. Open the [Functions page](#) of the Lambda console.
2. Choose the name of your function to open the function detail page.
3. Choose the **Configuration** tab, then choose **Concurrency and recursion detection**.
4. Beside **Recursive loop detection**, choose **Edit**.
5. Select **Allow recursive loops**.
6. Choose **Save**.

AWS CLI

You can use the [PutFunctionRecursionConfig](#) API to allow your function to be invoked in a recursive loop. Specify `Allow` for the recursive loop parameter. For example, you can call this API with the `put-function-recursion-config` AWS CLI command:

```
aws lambda put-function-recursion-config --function-name yourFunctionName --recursive-loop Allow
```

You can change your function's configuration back to the default setting so that Lambda terminates recursive loops when it detects them. Edit your function's configuration using the Lambda console or the AWS CLI.

Console

To configure a function so that recursive loops are terminated (console)

1. Open the [Functions page](#) of the Lambda console.
2. Choose the name of your function to open the function detail page.
3. Choose the **Configuration** tab, then choose **Concurrency and recursion detection**.

4. Beside **Recursive loop detection**, choose **Edit**.
5. Select **Terminate recursive loops**.
6. Choose **Save**.

AWS CLI

You can use the [PutFunctionRecursionConfig](#) API to configure your function so that Lambda terminates recursive loops when it detects them. Specify `Terminate` for the recursive loop parameter. For example, you can call this API with the `put-function-recursion-config` AWS CLI command:

```
aws lambda put-function-recursion-config --function-name yourFunctionName --  
recursive-loop Terminate
```

Supported regions for Lambda recursive loop detection

Lambda recursive loop detection is supported in the following AWS Regions.

- US East (N. Virginia)
- US East (Ohio)
- US West (N. California)
- US West (Oregon)
- Africa (Cape Town)
- Asia Pacific (Hong Kong)
- Asia Pacific (Jakarta)
- Asia Pacific (Mumbai)
- Asia Pacific (Osaka)
- Asia Pacific (Seoul)
- Asia Pacific (Singapore)
- Asia Pacific (Sydney)
- Asia Pacific (Tokyo)
- Canada (Central)
- Europe (Frankfurt)

- Europe (Ireland)
- Europe (London)
- Europe (Milan)
- Europe (Paris)
- Europe (Stockholm)
- Middle East (Bahrain)
- South America (Sao Paulo)

Creating and managing Lambda function URLs

A function URL is a dedicated HTTP(S) endpoint for your Lambda function. You can create and configure a function URL through the Lambda console or the Lambda API.

Tip

Lambda offers two ways to invoke your function through an HTTP endpoint: function URLs and Amazon API Gateway. If you're not sure which is the best method for your use case, see [the section called "Function URLs vs Amazon API Gateway"](#).

When you create a function URL, Lambda automatically generates a unique URL endpoint for you. Once you create a function URL, its URL endpoint never changes. Function URL endpoints have the following format:

```
https://<url-id>.lambda-url.<region>.on.aws
```

Note

Function URLs are not supported in the following AWS Regions: Asia Pacific (Hyderabad) (ap-south-2), Asia Pacific (Melbourne) (ap-southeast-4), Asia Pacific (Malaysia) (ap-southeast-5), Canada West (Calgary) (ca-west-1), Europe (Spain) (eu-south-2), Europe (Zurich) (eu-central-2), Israel (Tel Aviv) (il-central-1), and Middle East (UAE) (me-central-1).

Function URLs are dual stack-enabled, supporting IPv4 and IPv6. After you configure a function URL for your function, you can invoke your function through its HTTP(S) endpoint via a web browser, curl, Postman, or any HTTP client.

Note

You can access your function URL through the public Internet only. While Lambda functions do support AWS PrivateLink, function URLs do not.

Lambda function URLs use [resource-based policies](#) for security and access control. Function URLs also support cross-origin resource sharing (CORS) configuration options.

You can apply function URLs to any function alias, or to the \$LATEST unpublished function version. You can't add a function URL to any other function version.

The following section show how to create and manage a function URL using the Lambda console, AWS CLI, and AWS CloudFormation template

Topics

- [Creating a function URL \(console\)](#)
- [Creating a function URL \(AWS CLI\)](#)
- [Adding a function URL to a CloudFormation template](#)
- [Cross-origin resource sharing \(CORS\)](#)
- [Throttling function URLs](#)
- [Deactivating function URLs](#)
- [Deleting function URLs](#)
- [Control access to Lambda function URLs](#)
- [Invoking Lambda function URLs](#)
- [Monitoring Lambda function URLs](#)
- [Select a method to invoke your Lambda function using an HTTP request](#)
- [Tutorial: Creating a webhook endpoint using a Lambda function URL](#)

Creating a function URL (console)

Follow these steps to create a function URL using the console.

To create a function URL for an existing function (console)

1. Open the [Functions page](#) of the Lambda console.
2. Choose the name of the function that you want to create the function URL for.
3. Choose the **Configuration** tab, and then choose **Function URL**.
4. Choose **Create function URL**.

5. For **Auth type**, choose **AWS_IAM** or **NONE**. For more information about function URL authentication, see [Access control](#).
6. (Optional) Select **Configure cross-origin resource sharing (CORS)**, and then configure the CORS settings for your function URL. For more information about CORS, see [Cross-origin resource sharing \(CORS\)](#).
7. Choose **Save**.

This creates a function URL for the \$LATEST unpublished version of your function. The function URL appears in the **Function overview** section of the console.

To create a function URL for an existing alias (console)

1. Open the [Functions page](#) of the Lambda console.
2. Choose the name of the function with the alias that you want to create the function URL for.
3. Choose the **Aliases** tab, and then choose the name of the alias that you want to create the function URL for.
4. Choose the **Configuration** tab, and then choose **Function URL**.
5. Choose **Create function URL**.
6. For **Auth type**, choose **AWS_IAM** or **NONE**. For more information about function URL authentication, see [Access control](#).
7. (Optional) Select **Configure cross-origin resource sharing (CORS)**, and then configure the CORS settings for your function URL. For more information about CORS, see [Cross-origin resource sharing \(CORS\)](#).
8. Choose **Save**.

This creates a function URL for your function alias. The function URL appears in the console's **Function overview** section for your alias.

To create a new function with a function URL (console)

To create a new function with a function URL (console)

1. Open the [Functions page](#) of the Lambda console.
2. Choose **Create function**.
3. Under **Basic information**, do the following:

- a. For **Function name**, enter a name for your function, such as **my-function**.
 - b. For **Runtime**, choose the language runtime that you prefer, such as **Node.js 18.x**.
 - c. For **Architecture**, choose either **x86_64** or **arm64**.
 - d. Expand **Permissions**, then choose whether to create a new execution role or use an existing one.
4. Expand **Advanced settings**, and then select **Function URL**.
 5. For **Auth type**, choose **AWS_IAM** or **NONE**. For more information about function URL authentication, see [Access control](#).
 6. (Optional) Select **Configure cross-origin resource sharing (CORS)**. By selecting this option during function creation, your function URL allows requests from all origins by default. You can edit the CORS settings for your function URL after creating the function. For more information about CORS, see [Cross-origin resource sharing \(CORS\)](#).
 7. Choose **Create function**.

This creates a new function with a function URL for the \$LATEST unpublished version of the function. The function URL appears in the **Function overview** section of the console.

Creating a function URL (AWS CLI)

To create a function URL for an existing Lambda function using the AWS Command Line Interface (AWS CLI), run the following command:

```
aws lambda create-function-url-config \  
  --function-name my-function \  
  --qualifier prod \ // optional  
  --auth-type AWS_IAM  
  --cors-config {AllowOrigins="https://example.com"} // optional
```

This adds a function URL to the **prod** qualifier for the function **my-function**. For more information about these configuration parameters, see [CreateFunctionUrlConfig](#) in the API reference.

Note

To create a function URL via the AWS CLI, the function must already exist.

Adding a function URL to a CloudFormation template

To add an `AWS::Lambda::Url` resource to your AWS CloudFormation template, use the following syntax:

JSON

```
{
  "Type" : "AWS::Lambda::Url",
  "Properties" : {
    "AuthType" : String,
    "Cors" : Cors,
    "Qualifier" : String,
    "TargetFunctionArn" : String
  }
}
```

YAML

```
Type: AWS::Lambda::Url
Properties:
  AuthType: String
  Cors:
    Cors
  Qualifier: String
  TargetFunctionArn: String
```

Parameters

- (Required) `AuthType` – Defines the type of authentication for your function URL. Possible values are either `AWS_IAM` or `NONE`. To restrict access to authenticated users only, set to `AWS_IAM`. To bypass IAM authentication and allow any user to make requests to your function, set to `NONE`.
- (Optional) `Cors` – Defines the [CORS settings](#) for your function URL. To add `Cors` to your `AWS::Lambda::Url` resource in CloudFormation, use the following syntax.

Example `AWS::Lambda::Url.Cors` (JSON)

```
{
  "AllowCredentials" : Boolean,
  "AllowHeaders" : [ String, ... ],
```

```
"AllowMethods" : [ String, ... ],
"AllowOrigins" : [ String, ... ],
"ExposeHeaders" : [ String, ... ],
"MaxAge" : Integer
}
```

Example AWS::Lambda::Url.Cors (YAML)

```
AllowCredentials: Boolean
AllowHeaders:
  - String
AllowMethods:
  - String
AllowOrigins:
  - String
ExposeHeaders:
  - String
MaxAge: Integer
```

- (Optional) `Qualifier` – The alias name.
- (Required) `TargetFunctionArn` – The name or Amazon Resource Name (ARN) of the Lambda function. Valid name formats include the following:
 - **Function name** – `my-function`
 - **Function ARN** – `arn:aws:lambda:us-west-2:123456789012:function:my-function`
 - **Partial ARN** – `123456789012:function:my-function`

Cross-origin resource sharing (CORS)

To define how different origins can access your function URL, use [cross-origin resource sharing \(CORS\)](#). We recommend configuring CORS if you intend to call your function URL from a different domain. Lambda supports the following CORS headers for function URLs.

CORS header	CORS configuration property	Example values
Access-Control-Allow-Origin	<code>AllowOrigins</code>	* (allow all origins) <code>https://www.example.com</code>

CORS header	CORS configuration property	Example values
		http://localhost:60905
<u>Access-Control-Allow-Method</u>	AllowMethods	GET, POST, DELETE, *
<u>Access-Control-Allow-Header</u>	AllowHeaders	Date, Keep-Alive , X-Custom-Header
<u>Access-Control-Expose-Header</u>	ExposeHeaders	Date, Keep-Alive , X-Custom-Header
<u>Access-Control-Allow-Credentials</u>	AllowCredentials	TRUE
<u>Access-Control-Max-Age</u>	MaxAge	5 (default), 300

When you configure CORS for a function URL using the Lambda console or the AWS CLI, Lambda automatically adds the CORS headers to all responses through the function URL. Alternatively, you can manually add CORS headers to your function response. If there are conflicting headers, the expected behavior depends on the type of request:

- For preflight requests such as OPTIONS requests, the configured CORS headers on the function URL take precedence. Lambda returns only these CORS headers in the response.
- For non-preflight requests such as GET or POST requests, Lambda returns both the configured CORS headers on the function URL, as well as the CORS headers returned by the function. This can result in duplicate CORS headers in the response. You may see an error similar to the following: The 'Access-Control-Allow-Origin' header contains multiple values '*', '*', but only one is allowed.

In general, we recommend configuring all CORS settings on the function URL, rather than sending CORS headers manually in the function response.

Throttling function URLs

Throttling limits the rate at which your function processes requests. This is useful in many situations, such as preventing your function from overloading downstream resources, or handling a sudden surge in requests.

You can throttle the rate of requests that your Lambda function processes through a function URL by configuring reserved concurrency. Reserved concurrency limits the number of maximum concurrent invocations for your function. Your function's maximum request rate per second (RPS) is equivalent to 10 times the configured reserved concurrency. For example, if you configure your function with a reserved concurrency of 100, then the maximum RPS is 1,000.

Whenever your function concurrency exceeds the reserved concurrency, your function URL returns an HTTP 429 status code. If your function receives a request that exceeds the 10x RPS maximum based on your configured reserved concurrency, you also receive an HTTP 429 error. For more information about reserved concurrency, see [Configuring reserved concurrency for a function](#).

Deactivating function URLs

In an emergency, you might want to reject all traffic to your function URL. To deactivate your function URL, set the reserved concurrency to zero. This throttles all requests to your function URL, resulting in HTTP 429 status responses. To reactivate your function URL, delete the reserved concurrency configuration, or set the configuration to an amount greater than zero.

Deleting function URLs

When you delete a function URL, you can't recover it. Creating a new function URL will result in a different URL address.

Note

If you delete a function URL with auth type NONE, Lambda doesn't automatically delete the associated resource-based policy. If you want to delete this policy, you must manually do so.

1. Open the [Functions page](#) of the Lambda console.
2. Choose the name of the function.
3. Choose the **Configuration** tab, and then choose **Function URL**.

4. Choose **Delete**.
5. Enter the word *delete* into the field to confirm the deletion.
6. Choose **Delete**.

 **Note**

When you delete a function that has a function URL, Lambda asynchronously deletes the function URL. If you immediately create a new function with the same name in the same account, it is possible that the original function URL will be mapped to the new function instead of deleted.

Control access to Lambda function URLs

You can control access to your Lambda function URLs using the `AuthType` parameter combined with [resource-based policies](#) attached to your specific function. The configuration of these two components determines who can invoke or perform other administrative actions on your function URL.

The `AuthType` parameter determines how Lambda authenticates or authorizes requests to your function URL. When you configure your function URL, you must specify one of the following `AuthType` options:

- `AWS_IAM` – Lambda uses AWS Identity and Access Management (IAM) to authenticate and authorize requests based on the IAM principal's identity policy and the function's resource-based policy. Choose this option if you want only authenticated users and roles to invoke your function via the function URL.
- `NONE` – Lambda doesn't perform any authentication before invoking your function. However, your function's resource-based policy is always in effect and must grant public access before your function URL can receive requests. Choose this option to allow public, unauthenticated access to your function URL.

In addition to `AuthType`, you can also use resource-based policies to grant permissions to other AWS accounts to invoke your function. For more information, see [Viewing resource-based IAM policies in Lambda](#).

For additional insights into security, you can use AWS Identity and Access Management Access Analyzer to get a comprehensive analysis of external access to your function URL. IAM Access Analyzer also monitors for new or updated permissions on your Lambda functions to help you identify permissions that grant public and cross-account access. IAM Access Analyzer is free to use for any AWS customer. To get started with IAM Access Analyzer, see [Using AWS IAM Access Analyzer](#).

This page contains examples of resource-based policies for both auth types, and also how to create these policies using the [AddPermission](#) API operation or the Lambda console. For information on how to invoke your function URL after you've set up permissions, see [Invoking Lambda function URLs](#).

Topics

- [Using the AWS_IAM auth type](#)
- [Using the NONE auth type](#)
- [Governance and access control](#)

Using the AWS_IAM auth type

If you choose the `AWS_IAM` auth type, users who need to invoke your Lambda function URL must have the `lambda:InvokeFunctionUrl` permission. Depending on who makes the invocation request, you may have to grant this permission using a resource-based policy.

If the principal making the request is in the same AWS account as the function URL, then the principal must **either** have `lambda:InvokeFunctionUrl` permissions in their [identity-based policy](#), **or** have permissions granted to them in the function's resource-based policy. In other words, a resource-based policy is optional if the user already has `lambda:InvokeFunctionUrl` permissions in their identity-based policy. Policy evaluation follows the rules outlined in [Determining whether a request is allowed or denied within an account](#).

If the principal making the request is in a different account, then the principal must have **both** an identity-based policy that gives them `lambda:InvokeFunctionUrl` permissions **and** permissions granted to them in a resource-based policy on the function that they are trying to invoke. In these cross-account cases, policy evaluation follows the rules outlined in [Determining whether a cross-account request is allowed](#).

For an example cross-account interaction, the following resource-based policy allows the example role in AWS account 444455556666 to invoke the function URL associated with function my-function:

Example function URL cross-account invoke policy

```
{
  "Version": "2012-10-17",
  "Statement": [
    {
      "Effect": "Allow",
      "Principal": {
        "AWS": "arn:aws:iam::444455556666:role/example"
      },
      "Action": "lambda:InvokeFunctionUrl",
      "Resource": "arn:aws:lambda:us-east-1:123456789012:function:my-function",
      "Condition": {
        "StringEquals": {
          "lambda:FunctionUrlAuthType": "AWS_IAM"
        }
      }
    }
  ]
}
```

You can create this policy statement through the console by following these steps:

To grant URL invocation permissions to another account (console)

1. Open the [Functions page](#) of the Lambda console.
2. Choose the name of the function that you want to grant URL invocation permissions for.
3. Choose the **Configuration** tab, and then choose **Permissions**.
4. Under **Resource-based policy**, choose **Add permissions**.
5. Choose **Function URL**.
6. For **Auth type**, choose **AWS_IAM**.
7. (Optional) For **Statement ID**, enter a statement ID for your policy statement.
8. For **Principal**, enter account ID or the Amazon Resource Name (ARN) of the user or role that you want to grant permissions to. For example: **444455556666**.
9. Choose **Save**.

Alternatively, you can create this policy statement using the following [add-permission](#) AWS Command Line Interface (AWS CLI) command:

```
aws lambda add-permission --function-name my-function \  
  --statement-id example0-cross-account-statement \  
  --action lambda:InvokeFunctionUrl \  
  --principal 444455556666 \  
  --function-url-auth-type AWS_IAM
```

In the previous example, the `lambda:FunctionUrlAuthType` condition key value is `AWS_IAM`. This policy only allows access when your function URL's auth type is also `AWS_IAM`.

Using the NONE auth type

Important

When your function URL auth type is `NONE` and you have a resource-based policy that grants public access, any unauthenticated user with your function URL can invoke your function.

In some cases, you may want your function URL to be public. For example, you might want to serve requests made directly from a web browser. To allow public access to your function URL, choose the `NONE` auth type.

If you choose the `NONE` auth type, Lambda doesn't use IAM to authenticate requests to your function URL. However, users must still have `lambda:InvokeFunctionUrl` permissions in order to successfully invoke your function URL. You can grant `lambda:InvokeFunctionUrl` permissions using the following resource-based policy:

Example function URL invoke policy for all unauthenticated principals

```
{  
  "Version": "2012-10-17",  
  "Statement": [  
    {  
      "Effect": "Allow",  
      "Principal": "*",  
      "Action": "lambda:InvokeFunctionUrl",  
      "Resource": "arn:aws:lambda:us-east-1:123456789012:function:my-function",
```

```
        "Condition": {
            "StringEquals": {
                "lambda:FunctionUrlAuthType": "NONE"
            }
        }
    ]
}
```

Note

When you create a function URL with auth type NONE via the console or AWS Serverless Application Model (AWS SAM), Lambda automatically creates the preceding resource-based policy statement for you. If the policy already exists, or the user or role creating the application doesn't have the appropriate permissions, then Lambda won't create it for you. If you're using the AWS CLI, AWS CloudFormation, or the Lambda API directly, you must add `lambda:InvokeFunctionUrl` permissions yourself. This makes your function public. In addition, if you delete your function URL with auth type NONE, Lambda doesn't automatically delete the associated resource-based policy. If you want to delete this policy, you must manually do so.

In this statement, the `lambda:FunctionUrlAuthType` condition key value is NONE. This policy statement allows access only when your function URL's auth type is also NONE.

If a function's resource-based policy doesn't grant `lambda:invokeFunctionUrl` permissions, then users will get a 403 Forbidden error code when they try to invoke your function URL, even if the function URL uses the NONE auth type.

Governance and access control

In addition to function URL invocation permissions, you can also control access on actions used to configure function URLs. Lambda supports the following IAM policy actions for function URLs:

- `lambda:InvokeFunctionUrl` – Invoke a Lambda function using the function URL.
- `lambda:CreateFunctionUrlConfig` – Create a function URL and set its `AuthType`.
- `lambda:UpdateFunctionUrlConfig` – Update a function URL configuration and its `AuthType`.
- `lambda:GetFunctionUrlConfig` – View the details of a function URL.

- `lambda:ListFunctionUrlConfigs` – List function URL configurations.
- `lambda>DeleteFunctionUrlConfig` – Delete a function URL.

Note

The Lambda console supports adding permissions only for `lambda:InvokeFunctionUrl`. For all other actions, you must add permissions using the Lambda API or AWS CLI.

To allow or deny function URL access to other AWS entities, include these actions in IAM policies. For example, the following policy grants the example role in AWS account 444455556666 permissions to update the function URL for function **my-function** in account 123456789012.

Example cross-account function URL policy

```
{
  "Version": "2012-10-17",
  "Statement": [
    {
      "Effect": "Allow",
      "Principal": {
        "AWS": "arn:aws:iam::444455556666:role/example"
      },
      "Action": "lambda:UpdateFunctionUrlConfig",
      "Resource": "arn:aws:lambda:us-east-2:123456789012:function:my-function"
    }
  ]
}
```

Condition keys

For fine-grained access control over your function URLs, use a condition key. Lambda supports one additional condition key for function URLs: `FunctionUrlAuthType`. The `FunctionUrlAuthType` key defines an enum value describing the auth type that your function URL uses. The value can be either `AWS_IAM` or `NONE`.

You can use this condition key in policies associated with your function. For example, you might want to restrict who can make configuration changes to your function URLs. To deny all `UpdateFunctionUrlConfig` requests to any function with URL auth type `NONE`, you can define the following policy:

Example function URL policy with explicit deny

```
{
  "Version": "2012-10-17",
  "Statement": [
    {
      "Effect": "Deny",
      "Principal": "*",
      "Action": [
        "lambda:UpdateFunctionUrlConfig"
      ],
      "Resource": "arn:aws:lambda:us-east-1:123456789012:function:*",
      "Condition": {
        "StringEquals": {
          "lambda:FunctionUrlAuthType": "NONE"
        }
      }
    }
  ]
}
```

To grant the example role in AWS account 444455556666 permissions to make `CreateFunctionUrlConfig` and `UpdateFunctionUrlConfig` requests on functions with URL auth type `AWS_IAM`, you can define the following policy:

Example function URL policy with explicit allow

```
{
  "Version": "2012-10-17",
  "Statement": [
    {
      "Effect": "Allow",
      "Principal": {
        "AWS": "arn:aws:iam::444455556666:role/example"
      },
      "Action": [
        "lambda:CreateFunctionUrlConfig",
        "lambda:UpdateFunctionUrlConfig"
      ],
      "Resource": "arn:aws:lambda:us-east-1:123456789012:function:*",
      "Condition": {
        "StringEquals": {
          "lambda:FunctionUrlAuthType": "AWS_IAM"
        }
      }
    }
  ]
}
```

```

    }
  }
]
}

```

You can also use this condition key in a [service control policy](#) (SCP). Use SCPs to manage permissions across an entire organization in AWS Organizations. For example, to deny users from creating or updating function URLs that use anything other than the `AWS_IAM` auth type, use the following service control policy:

Example function URL SCP with explicit deny

```

{
  "Version": "2012-10-17",
  "Statement": [
    {
      "Effect": "Deny",
      "Action": [
        "lambda:CreateFunctionUrlConfig",
        "lambda:UpdateFunctionUrlConfig"
      ],
      "Resource": "arn:aws:lambda:*:123456789012:function:*",
      "Condition": {
        "StringNotEquals": {
          "lambda:FunctionUrlAuthType": "AWS_IAM"
        }
      }
    }
  ]
}

```

Invoking Lambda function URLs

A function URL is a dedicated HTTP(S) endpoint for your Lambda function. You can create and configure a function URL through the Lambda console or the Lambda API.

Tip

Lambda offers two ways to invoke your function through an HTTP endpoint: function URLs and Amazon API Gateway. If you're not sure which is the best method for your use case, see [the section called "Function URLs vs Amazon API Gateway"](#).

When you create a function URL, Lambda automatically generates a unique URL endpoint for you. Once you create a function URL, its URL endpoint never changes. Function URL endpoints have the following format:

```
https://<url-id>.lambda-url.<region>.on.aws
```

Note

Function URLs are not supported in the following AWS Regions: Asia Pacific (Hyderabad) (ap-south-2), Asia Pacific (Melbourne) (ap-southeast-4), Asia Pacific (Malaysia) (ap-southeast-5), Canada West (Calgary) (ca-west-1), Europe (Spain) (eu-south-2), Europe (Zurich) (eu-central-2), Israel (Tel Aviv) (il-central-1), and Middle East (UAE) (me-central-1).

Function URLs are dual stack-enabled, supporting IPv4 and IPv6. After configuring your function URL, you can invoke your function through its HTTP(S) endpoint via a web browser, curl, Postman, or any HTTP client. To invoke a function URL, you must have `lambda:InvokeFunctionUrl` permissions. For more information, see [Access control](#).

Topics

- [Function URL invocation basics](#)
- [Request and response payloads](#)

Function URL invocation basics

If your function URL uses the `AWS_IAM` auth type, you must sign each HTTP request using [AWS Signature Version 4 \(SigV4\)](#). Tools such as [awscurl](#), [Postman](#), and [AWS SigV4 Proxy](#) offer built-in ways to sign your requests with SigV4.

If you don't use a tool to sign HTTP requests to your function URL, you must manually sign each request using SigV4. When your function URL receives a request, Lambda also calculates the SigV4 signature. Lambda processes the request only if the signatures match. For instructions on how to manually sign your requests with SigV4, see [Signing AWS requests with Signature Version 4](#) in the *Amazon Web Services General Reference Guide*.

If your function URL uses the `NONE` auth type, you don't have to sign your requests using SigV4. You can invoke your function using a web browser, `curl`, Postman, or any HTTP client.

To test simple GET requests to your function, use a web browser. For example, if your function URL is `https://abcdefg.lambda-url.us-east-1.on.aws`, and it takes in a string parameter message, your request URL could look like this:

```
https://abcdefg.lambda-url.us-east-1.on.aws/?message=HelloWorld
```

To test other HTTP requests, such as a POST request, you can use a tool such as `curl`. For example, if you want to include some JSON data in a POST request to your function URL, you could use the following `curl` command:

```
curl -v 'https://abcdefg.lambda-url.us-east-1.on.aws/?message=HelloWorld' \  
-H 'content-type: application/json' \  
-d '{ "example": "test" }'
```

Request and response payloads

When a client calls your function URL, Lambda maps the request to an event object before passing it to your function. Your function's response is then mapped to an HTTP response that Lambda sends back to the client through the function URL.

The request and response event formats follow the same schema as the [Amazon API Gateway payload format version 2.0](#).

Request payload format

A request payload has the following structure:

```
{
  "version": "2.0",
  "routeKey": "$default",
  "rawPath": "/my/path",
  "rawQueryString": "parameter1=value1&parameter1=value2&parameter2=value",
  "cookies": [
    "cookie1",
    "cookie2"
  ],
  "headers": {
    "header1": "value1",
    "header2": "value1,value2"
  },
  "queryStringParameters": {
    "parameter1": "value1,value2",
    "parameter2": "value"
  },
  "requestContext": {
    "accountId": "123456789012",
    "apiId": "<urlid>",
    "authentication": null,
    "authorizer": {
      "iam": {
        "accessKey": "AKIA...",
        "accountId": "111122223333",
        "callerId": "AIDA...",
        "cognitoIdentity": null,
        "principalOrgId": null,
        "userArn": "arn:aws:iam::111122223333:user/example-user",
        "userId": "AIDA..."
      }
    },
    "domainName": "<url-id>.lambda-url.us-west-2.on.aws",
    "domainPrefix": "<url-id>",
    "http": {
      "method": "POST",
      "path": "/my/path",
      "protocol": "HTTP/1.1",
      "sourceIp": "123.123.123.123",
      "userAgent": "agent"
    },
    "requestId": "id",
    "routeKey": "$default",
```

```

    "stage": "$default",
    "time": "12/Mar/2020:19:03:58 +0000",
    "timeEpoch": 1583348638390
  },
  "body": "Hello from client!",
  "pathParameters": null,
  "isBase64Encoded": false,
  "stageVariables": null
}

```

Parameter	Description	Example
version	The payload format version for this event. Lambda function URLs currently support payload format version 2.0 .	2.0
routeKey	Function URLs don't use this parameter. Lambda sets this to <code>\$default</code> as a placeholder.	<code>\$default</code>
rawPath	The request path. For example, if the request URL is <code>https://{url-id}.lambda-url.{region}.on.aws/example/test/demo</code> , then the raw path value is <code>/example/test/demo</code> .	<code>/example/test/demo</code>
rawQueryString	The raw string containing the request's query string parameters. Supported characters include a-z, A-Z, 0-9, ., _, -, %, &, =, and +.	<code>"?parameter1=value1&parameter2=value2"</code>

Parameter	Description	Example
<code>cookies</code>	An array containing all cookies sent as part of the request.	<code>["Cookie_1=Value_1", "Cookie_2=Value_2"]</code>
<code>headers</code>	The list of request headers, presented as key-value pairs.	<code>{"header1": "value1", "header2": "value2"}</code>
<code>queryStringParameters</code>	The query parameters for the request. For example, if the request URL is <code>https://{url-id}.lambda-url.{region}.on.aws/example?name=Jane</code> , then the <code>queryStringParameters</code> value is a JSON object with a key of <code>name</code> and a value of <code>Jane</code> .	<code>{"name": "Jane"}</code>
<code>requestContext</code>	An object that contains additional information about the request, such as the <code>requestId</code> , the time of the request, and the identity of the caller if authorized via AWS Identity and Access Management (IAM).	
<code>requestContext.accountId</code>	The AWS account ID of the function owner.	<code>"123456789012"</code>
<code>requestContext.apiId</code>	The ID of the function URL.	<code>"33anwqw8fj"</code>
<code>requestContext.authentication</code>	Function URLs don't use this parameter. Lambda sets this to <code>null</code> .	<code>null</code>

Parameter	Description	Example
<code>requestContext.authorizer</code>	An object that contains information about the caller identity, if the function URL uses the <code>AWS_IAM</code> auth type. Otherwise, Lambda sets this to <code>null</code> .	
<code>requestContext.authorizer.iam.accessKey</code>	The access key of the caller identity.	"AKIAIOSFODNN7EXAMPLE"
<code>requestContext.authorizer.iam.accountId</code>	The AWS account ID of the caller identity.	"111122223333"
<code>requestContext.authorizer.iam.callerId</code>	The ID (user ID) of the caller.	"AIDACKCEVSQ6C2EXAMPLE"
<code>requestContext.authorizer.iam.cognitoIdentity</code>	Function URLs don't use this parameter. Lambda sets this to <code>null</code> or excludes this from the JSON.	<code>null</code>
<code>requestContext.authorizer.iam.principalOrgId</code>	The principal org ID associated with the caller identity.	"AIDACKCEVSQORGEEXAMPLE"
<code>requestContext.authorizer.iam.userArn</code>	The user Amazon Resource Name (ARN) of the caller identity.	"arn:aws:iam::111122223333:user/example-user"
<code>requestContext.authorizer.iam.userId</code>	The user ID of the caller identity.	"AIDACOSFODNN7EXAMPLE2"

Parameter	Description	Example
<code>requestContext.domainName</code>	The domain name of the function URL.	"<url-id>.lambda-url.us-west-2.on.aws"
<code>requestContext.domainPrefix</code>	The domain prefix of the function URL.	"<url-id>"
<code>requestContext.http</code>	An object that contains details about the HTTP request.	
<code>requestContext.http.method</code>	The HTTP method used in this request. Valid values include GET, POST, PUT, HEAD, OPTIONS, PATCH, and DELETE.	GET
<code>requestContext.http.path</code>	The request path. For example, if the request URL is <code>https://{url-id}.lambda-url.{region}.on.aws/example/test/demo</code> , then the path value is <code>/example/test/demo</code> .	<code>/example/test/demo</code>
<code>requestContext.http.protocol</code>	The protocol of the request.	HTTP/1.1
<code>requestContext.http.sourceIp</code>	The source IP address of the immediate TCP connection making the request.	123.123.123.123

Parameter	Description	Example
<code>requestContext.http.userAgent</code>	The User-Agent request header value.	Mozilla/5.0 (Macintosh; Intel Mac OS X 10_15_7) Gecko/20100101 Firefox/42.0
<code>requestContext.requestId</code>	The ID of the invocation request. You can use this ID to trace invocation logs related to your function.	e1506fd5-9e7b-434f-bd42-4f8fa224b599
<code>requestContext.routeKey</code>	Function URLs don't use this parameter. Lambda sets this to <code>\$default</code> as a placeholder.	<code>\$default</code>
<code>requestContext.stage</code>	Function URLs don't use this parameter. Lambda sets this to <code>\$default</code> as a placeholder.	<code>\$default</code>
<code>requestContext.time</code>	The timestamp of the request.	"07/Sep/2021:22:50:22 +0000"
<code>requestContext.timeEpoch</code>	The timestamp of the request, in Unix epoch time.	"1631055022677"
<code>body</code>	The body of the request. If the content type of the request is binary, the body is base64-encoded.	{"key1": "value1", "key2": "value2"}
<code>pathParameters</code>	Function URLs don't use this parameter. Lambda sets this to <code>null</code> or excludes this from the JSON.	<code>null</code>

Parameter	Description	Example
isBase64Encoded	TRUE if the body is a binary payload and base64-encoded. FALSE otherwise.	FALSE
stageVariables	Function URLs don't use this parameter. Lambda sets this to null or excludes this from the JSON.	null

Response payload format

When your function returns a response, Lambda parses the response and converts it into an HTTP response. Function response payloads have the following format:

```
{
  "statusCode": 201,
  "headers": {
    "Content-Type": "application/json",
    "My-Custom-Header": "Custom Value"
  },
  "body": "{ \"message\": \"Hello, world!\" }",
  "cookies": [
    "Cookie_1=Value1; Expires=21 Oct 2021 07:48 GMT",
    "Cookie_2=Value2; Max-Age=78000"
  ],
  "isBase64Encoded": false
}
```

Lambda infers the response format for you. If your function returns valid JSON and doesn't return a `statusCode`, Lambda assumes the following:

- `statusCode` is 200.
- `content-type` is `application/json`.
- `body` is the function response.
- `isBase64Encoded` is `false`.

The following examples show how the output of your Lambda function maps to the response payload, and how the response payload maps to the final HTTP response. When the client invokes your function URL, they see the HTTP response.

Example output for a string response

Lambda function output	Interpreted response output	HTTP response (what the client sees)
<pre>"Hello, world!"</pre>	<pre>{ "statusCode": 200, "body": "Hello, world!", "headers": { "content-type": "application/json" }, "isBase64Encoded": false }</pre>	<pre>HTTP/2 200 date: Wed, 08 Sep 2021 18:02:24 GMT content-type: applicati on/json content-length: 15 "Hello, world!"</pre>

Example output for a JSON response

Lambda function output	Interpreted response output	HTTP response (what the client sees)
<pre>{ "message": "Hello, world!" }</pre>	<pre>{ "statusCode": 200, "body": { "message": "Hello, world!" }, "headers": { "content-type": "application/json" }, "isBase64Encoded": false }</pre>	<pre>HTTP/2 200 date: Wed, 08 Sep 2021 18:02:24 GMT content-type: applicati on/json content-length: 34 { "message": "Hello, world!" }</pre>

Lambda function output	Interpreted response output	HTTP response (what the client sees)
	}	

Example output for a custom response

Lambda function output	Interpreted response output	HTTP response (what the client sees)
<pre>{ "statusCode": 201, "headers": { "Content-Type": "application/json", "My-Custom-Header": "Custom Value" }, "body": JSON.stringify({ "message": "Hello, world!" }), "isBase64Encoded": false }</pre>	<pre>{ "statusCode": 201, "headers": { "Content-Type": "application/json", "My-Custom-Header": "Custom Value" }, "body": JSON.stringify({ "message": "Hello, world!" }), "isBase64Encoded": false }</pre>	<pre>HTTP/2 201 date: Wed, 08 Sep 2021 18:02:24 GMT content-type: applicati on/json content-length: 27 my-custom-header: Custom Value { "message": "Hello, world!" }</pre>

Cookies

To return cookies from your function, don't manually add `set-cookie` headers. Instead, include the cookies in your response payload object. Lambda automatically interprets this and adds them as `set-cookie` headers in your HTTP response, as in the following example.

Lambda function output	HTTP response (what the client sees)
<pre>{ "statusCode": 201, "headers": {</pre>	<pre>HTTP/2 201 date: Wed, 08 Sep 2021 18:02:24 GMT content-type: application/json</pre>

Lambda function output

```
    "Content-Type": "application/
json",
    "My-Custom-Header": "Custom
Value"
  },
  "body": JSON.stringify({
    "message": "Hello, world!"
  }),
  "cookies": [
    "Cookie_1=Value1; Expires=21
Oct 2021 07:48 GMT",
    "Cookie_2=Value2; Max-Age=7
8000"
  ],
  "isBase64Encoded": false
}
```

HTTP response (what the client sees)

```
content-length: 27
my-custom-header: Custom Value
set-cookie: Cookie_1=Value2;
Expires=21 Oct 2021 07:48 GMT
set-cookie: Cookie_2=Value2; Max-
Age=78000

{
  "message": "Hello, world!"
}
```

Monitoring Lambda function URLs

You can use AWS CloudTrail and Amazon CloudWatch to monitor your function URLs.

Topics

- [Monitoring function URLs with CloudTrail](#)
- [CloudWatch metrics for function URLs](#)

Monitoring function URLs with CloudTrail

For function URLs, Lambda automatically supports logging the following API operations as events in CloudTrail log files:

- [CreateFunctionUrlConfig](#)
- [UpdateFunctionUrlConfig](#)
- [DeleteFunctionUrlConfig](#)
- [GetFunctionUrlConfig](#)
- [ListFunctionUrlConfigs](#)

Each log entry contains information about the caller identity, when the request was made, and other details. You can see all events within the last 90 days by viewing your CloudTrail **Event history**. To retain records past 90 days, you can create a trail.

By default, CloudTrail doesn't log `InvokeFunctionUrl` requests, which are considered data events. However, you can turn on data event logging in CloudTrail. For more information, see [Logging data events for trails](#) in the *AWS CloudTrail User Guide*.

CloudWatch metrics for function URLs

Lambda sends aggregated metrics about function URL requests to CloudWatch. With these metrics, you can monitor your function URLs, build dashboards, and configure alarms in the CloudWatch console.

Function URLs support the following invocation metrics. We recommend viewing these metrics with the Sum statistic.

- `UrlRequestCount` – The number of requests made to this function URL.

- `Url4xxCount` – The number of requests that returned a 4XX HTTP status code. 4XX series codes indicate client-side errors, such as bad requests.
- `Url5xxCount` – The number of requests that returned a 5XX HTTP status code. 5XX series codes indicate server-side errors, such as function errors and timeouts.

Function URLs also support the following performance metric. We recommend viewing this metric with the Average or Max statistics.

- `UrlRequestLatency` – The time between when the function URL receives a request and when the function URL returns a response.

Each of these invocation and performance metrics supports the following dimensions:

- `FunctionName` – View aggregate metrics for function URLs assigned to a function's `$LATEST` unpublished version, or to any of the function's aliases. For example, `hello-world-function`.
- `Resource` – View metrics for a specific function URL. This is defined by a function name, along with either the function's `$LATEST` unpublished version or one of the function's aliases. For example, `hello-world-function:$LATEST`.
- `ExecutedVersion` – View metrics for a specific function URL based on the executed version. You can use this dimension primarily to track the function URL assigned to the `$LATEST` unpublished version.

Select a method to invoke your Lambda function using an HTTP request

Many common use cases for Lambda involve invoking your function using an HTTP request. For example, you might want to invoke a function directly from a web browser, or to use a tool like [curl](#) or [Postman](#).

The following sections explain what your choices are for invoking Lambda through HTTP and provide information to help you make the right decision for your particular use case.

What are your choices when selecting an HTTP invoke method?

Lambda offers two main methods to invoke a function using an HTTP request - [function URLs](#) and [API Gateway](#). The key differences between these two options are as follows:

- **Lambda function URLs** provide a simple, direct HTTP endpoint for a Lambda function. They are optimized for simplicity and cost-effectiveness and provide the fastest path to expose a Lambda function via HTTP.
- **API Gateway** is a more advanced service for building fully-featured APIs. API Gateway is optimized for building and managing production APIs at scale and provides comprehensive tools for security, monitoring, and traffic management.

Recommendations if you already know your requirements

If you're already clear on your requirements, here are our basic recommendations:

We recommend [function URLs](#) for simple applications or prototyping where you only need basic authentication methods and request/response handling and where you want to keep costs and complexity to a minimum.

[API Gateway](#) is a better choice for production applications at scale or for cases where you need more advanced features like [OpenAPI Description](#) support, a choice of authentication options, custom domain names, or rich request/response handling including throttling, caching, and request/response transformation.

What to consider when selecting a method to invoke your Lambda function

When selecting between function URLs and API Gateway, you need to consider the following factors:

- Your authentication needs, such as whether you require OAuth or Amazon Cognito to authenticate users
- Your scaling requirements and the complexity of the API you want to implement
- Whether you need advanced features such as request validation and request/response formatting
- Your monitoring requirements
- Your cost goals

By understanding these factors, you can select the option that best balances your security, complexity, and cost requirements.

The following information summarizes the main differences between the two options.

Authentication

- **Function URLs** provide basic authentication options through AWS Identity and Access Management (IAM). You can configure your endpoints to be either public (no authentication) or to require IAM authentication. With IAM authentication, you can use standard AWS credentials or IAM roles to control access. While straightforward to set up, this approach provides limited options compared with other authentication methods.
- **API Gateway** provides access to a more comprehensive range of authentication options. As well as IAM authentication, you can use [Lambda authorizers](#) (custom authentication logic), [Amazon Cognito](#) user pools, and OAuth2.0 flows. This flexibility allows you to implement complex authentication schemes, including third-party authentication providers, token-based authentication, and multi-factor authentication.

Request/response handling

- **Function URLs** provide basic HTTP request and response handling. They support standard HTTP methods and include built-in cross-origin resource sharing (CORS) support. While they can handle JSON payloads and query parameters naturally, they don't offer request transformation or validation capabilities. Response handling is similarly straightforward – the client receives the response from your Lambda function exactly as Lambda returns it.
- **API Gateway** provides sophisticated request and response handling capabilities. You can define request validators, transform requests and responses using mapping templates, set up request/response headers, and implement response caching. API Gateway also supports binary payloads and custom domain names and can modify responses before they reach the client. You can set up models for request/response validation and transformation using JSON Schema.

Scaling

- **Function URLs** scale directly with your Lambda function's concurrency limits and handle traffic spikes by scaling your function up to its maximum configured concurrency limit. Once that limit is reached, Lambda responds to additional requests with HTTP 429 responses. There's no built-in queuing mechanism, so handling scaling is entirely dependent on your Lambda function's configuration. By default, Lambda functions have a limit of 1,000 concurrent executions per AWS Region.
- **API Gateway** provides additional scaling capabilities on top of Lambda's own scaling. It includes built-in request queuing and throttling controls, allowing you to manage traffic spikes more

gracefully. API Gateway can handle up to 10,000 requests per second per region by default, with a burst capacity of 5,000 requests per second. It also provides tools to throttle requests at different levels (API, stage, or method) to protect your backend.

Monitoring

- **Function URLs** offer basic monitoring through Amazon CloudWatch metrics, including request count, latency, and error rates. You get access to standard Lambda metrics and logs, which show the raw requests coming into your function. While this provides essential operational visibility, the metrics are focused mainly on function execution.
- **API Gateway** provides comprehensive monitoring capabilities including detailed metrics, logging, and tracing options. You can monitor API calls, latency, error rates, and cache hit/miss rates through CloudWatch. API Gateway also integrates with AWS X-Ray for distributed tracing and provides customizable logging formats.

Cost

- **Function URLs** follow the standard Lambda pricing model – you only pay for function invocations and compute time. There are no additional charges for the URL endpoint itself. This makes it a cost-effective choice for simple APIs or low-traffic applications if you don't need the additional features of API Gateway.
- **API Gateway** offers a [free tier](#) that includes one million API calls received for REST APIs and one million API calls received for HTTP APIs. After this, API Gateway charges for API calls, data transfer, and caching (if enabled). Refer to the API Gateway [pricing page](#) to understand the costs for your own use case.

Other features

- **Function URLs** are designed for simplicity and direct Lambda integration. They support both HTTP and HTTPS endpoints, offer built-in CORS support, and provide dual-stack (IPv4 and IPv6) endpoints. While they lack advanced features, they excel in scenarios where you need a quick, straightforward way to expose Lambda functions via HTTP.
- **API Gateway** includes numerous additional features such as API versioning, stage management, API keys for usage plans, API documentation through Swagger/OpenAPI, WebSocket APIs, private APIs within a VPC, and WAF integration for additional security. It also supports canary

deployments, mock integrations for testing, and integration with other AWS services beyond Lambda.

Select a method to invoke your Lambda function

Now that you've read about the criteria for selecting between Lambda function URLs and API Gateway and the key differences between them, you can select the option that best meets your needs and use the following resources to help you get started using it.

Function URLs

Get started with function URLs with the following resources

- Follow the tutorial [Creating a Lambda function with a function URL](#)
- Learn more about function URLs in the [the section called "Function URLs"](#) chapter of this guide
- Try the in-console guided tutorial **Create a simple web app** by doing the following:
 1. Open the [functions page](#) of the Lambda console.
 2. Open the help panel by choosing the icon in the top right corner of the screen.

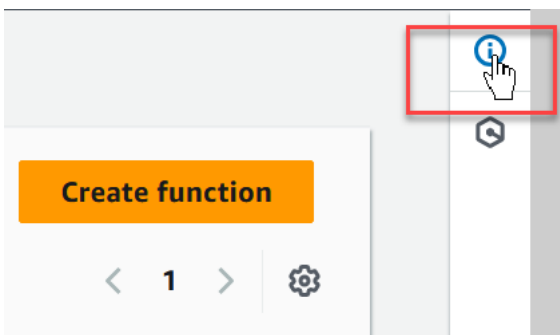

3. Select **Tutorials**.
4. In **Create a simple web app**, choose **Start tutorial**.

API Gateway

Get started with Lambda and API Gateway with the following resources

- Follow the tutorial [Using Lambda with API Gateway](#) to create a REST API integrated with a backend Lambda function.

- Learn more about the different kinds of API offered by API Gateway in the following sections of the *Amazon API Gateway Developer Guide*:
 - [API Gateway REST APIs](#)
 - [API Gateway HTTP APIs](#)
 - [API Gateway WebSocket APIs](#)
- Try one or more of the examples in the [Tutorials and workshops](#) section of the *Amazon API Gateway Developer Guide*.

Tutorial: Creating a webhook endpoint using a Lambda function URL

In this tutorial, you create a Lambda function URL to implement a webhook endpoint. A webhook is a lightweight, event-driven communication that automatically sends data between applications using HTTP. You can use a webhook to receive immediate updates about events happening in another system, such as when a new customer signs up on a website, a payment is processed, or a file is uploaded.

With Lambda, webhooks can be implemented using either Lambda function URLs or API Gateway. Function URLs are a good choice for simple webhooks that don't require features like advanced authorization or request validation.

Tip

If you're not sure which solution is best for your particular use case, see [the section called "Function URLs vs Amazon API Gateway"](#).

Prerequisites

To complete this tutorial, you must have either Python (version 3.8 or later) or Node.js (version 18 or later) installed on your local machine.

To test the endpoint using an HTTP request, the tutorial uses [curl](#), a command line tool you can use to transfer data using various network protocols. Refer to the [curl documentation](#) to learn how to install the tool if you don't already have it.

Create the Lambda function

First create the Lambda function that runs when an HTTP request is sent to your webhook endpoint. In this example, the sending application sends an update whenever a payment is submitted and indicates in the body of the HTTP request whether the payment was successful. The Lambda function parses the request and takes action according to the status of the payment. In this example, the code just prints the order ID for the payment, but in a real application, you might add the order to a database or send a notification.

The function also implements the most common authentication method used for webhooks, hash-based message authentication (HMAC). With this method, both the sending and receiving applications share a secret key. The sending application uses a hashing algorithm to generate a unique signature using this key together with the message content, and includes the signature

in the webhook request as an HTTP header. The receiving application then repeats this step, generating the signature using the secret key, and compares the resulting value with the signature sent in the request header. If the result matches, the request is considered legitimate.

Create the function using the Lambda console with either the Python or Node.js runtime.

Python

Create the Lambda function

1. Open the [Functions page](#) of the Lambda console.
2. Create a basic 'Hello world' function by doing the following:
 - a. Choose **Create function**.
 - b. Select **Author from scratch**.
 - c. For **Function name**, enter **myLambdaWebhook**.
 - d. For **Runtime**, select **python3.13**.
 - e. Choose **Create function**.
3. In the **Code source** pane, replace the existing code by copying and pasting the following:

```
import json
import hmac
import hashlib
import os

def lambda_handler(event, context):

    # Get the webhook secret from environment variables
    webhook_secret = os.environ['WEBHOOK_SECRET']

    # Verify the webhook signature
    if not verify_signature(event, webhook_secret):
        return {
            'statusCode': 401,
            'body': json.dumps({'error': 'Invalid signature'})
        }

    try:
        # Parse the webhook payload
        payload = json.loads(event['body'])
```

```
# Handle different event types
event_type = payload.get('type')

if event_type == 'payment.success':
    # Handle successful payment
    order_id = payload.get('orderId')
    print(f"Processing successful payment for order {order_id}")

    # Add your business logic here
    # For example, update database, send notifications, etc.

elif event_type == 'payment.failed':
    # Handle failed payment
    order_id = payload.get('orderId')
    print(f"Processing failed payment for order {order_id}")

    # Add your business logic here

else:
    print(f"Received unhandled event type: {event_type}")

# Return success response
return {
    'statusCode': 200,
    'body': json.dumps({'received': True})
}

except json.JSONDecodeError:
    return {
        'statusCode': 400,
        'body': json.dumps({'error': 'Invalid JSON payload'})
    }

except Exception as e:
    print(f"Error processing webhook: {e}")
    return {
        'statusCode': 500,
        'body': json.dumps({'error': 'Internal server error'})
    }

def verify_signature(event, webhook_secret):
    """
    Verify the webhook signature using HMAC
    """
    try:
```

```
# Get the signature from headers
signature = event['headers'].get('x-webhook-signature')

if not signature:
    print("Error: Missing webhook signature in headers")
    return False

# Get the raw body (return an empty string if the body key doesn't
exist)
body = event.get('body', '')

# Create HMAC using the secret key
expected_signature = hmac.new(
    webhook_secret.encode('utf-8'),
    body.encode('utf-8'),
    hashlib.sha256
).hexdigest()

# Compare the expected signature with the received signature to
authenticate the message
is_valid = hmac.compare_digest(signature, expected_signature)
if not is_valid:
    print(f"Error: Invalid signature. Received: {signature}, Expected:
{expected_signature}")
    return False

return True
except Exception as e:
    print(f"Error verifying signature: {e}")
    return False
```

4. In the **DEPLOY** section, choose **Deploy** to update your function's code.

Node.js

Create the Lambda function

1. Open the [Functions page](#) of the Lambda console.
2. Create a basic 'Hello world' function by doing the following:
 - a. Choose **Create function**.
 - b. Select **Author from scratch**.

- c. For **Function name**, enter **myLambdaWebhook**.
 - d. For **Runtime**, select **nodejs22.x**.
 - e. Choose **Create function**.
3. In the **Code source** pane, replace the existing code by copying and pasting the following:

```
import crypto from 'crypto';

export const handler = async (event, context) => {
  // Get the webhook secret from environment variables
  const webhookSecret = process.env.WEBHOOK_SECRET;

  // Verify the webhook signature
  if (!verifySignature(event, webhookSecret)) {
    return {
      statusCode: 401,
      body: JSON.stringify({ error: 'Invalid signature' })
    };
  }

  try {
    // Parse the webhook payload
    const payload = JSON.parse(event.body);

    // Handle different event types
    const eventType = payload.type;

    switch (eventType) {
      case 'payment.success': {
        // Handle successful payment
        const orderId = payload.orderId;
        console.log(`Processing successful payment for order
${orderId}`);

        // Add your business logic here
        // For example, update database, send notifications, etc.
        break;
      }

      case 'payment.failed': {
        // Handle failed payment
        const orderId = payload.orderId;
        console.log(`Processing failed payment for order ${orderId}`);
      }
    }
  }
}
```

```
        // Add your business logic here
        break;
    }

    default:
        console.log(`Received unhandled event type: ${eventType}`);
    }

    // Return success response
    return {
        statusCode: 200,
        body: JSON.stringify({ received: true })
    };

} catch (error) {
    if (error instanceof SyntaxError) {
        // Handle JSON parsing errors
        return {
            statusCode: 400,
            body: JSON.stringify({ error: 'Invalid JSON payload' })
        };
    }

    // Handle all other errors
    console.error('Error processing webhook:', error);
    return {
        statusCode: 500,
        body: JSON.stringify({ error: 'Internal server error' })
    };
}

};

// Verify the webhook signature using HMAC

const verifySignature = (event, webhookSecret) => {
    try {
        // Get the signature from headers
        const signature = event.headers['x-webhook-signature'];

        if (!signature) {
            console.log('No signature found in headers:', event.headers);
            return false;
        }
    }
}
```



```
    // Get the raw body (return an empty string if the body key doesn't
    exist)
    const body = event.body || '';

    // Create HMAC using the secret key
    const hmac = crypto.createHmac('sha256', webhookSecret);
    const expectedSignature = hmac.update(body).digest('hex');

    // Compare expected and received signatures
    const isValid = signature === expectedSignature;
    if (!isValid) {
        console.log(`Invalid signature. Received: ${signature}, Expected:
        ${expectedSignature}`);
        return false;
    }

    return true;
} catch (error) {
    console.error('Error during signature verification:', error);
    return false;
}
};
```

4. In the **DEPLOY** section, choose **Deploy** to update your function's code.

Create the secret key

For the Lambda function to authenticate the webhook request, it uses a secret key which it shares with the calling application. In this example, the key is stored in an environment variable. In a production application, we recommend that you use AWS Secrets Manager as a more secure option. To learn more about using Secrets Manager to store secret keys, see [Create an AWS Secrets Manager secret](#) and [Get secrets from AWS Secrets Manager](#) in the *AWS Secrets Manager User Guide*.

Create and store the webhook secret key

1. Generate a long, random string using a cryptographically secure random number generator. You can use the following code snippets in Python or Node.js to generate and print a 32-character secret, or use your own preferred method.

Python

Example code to generate a secret

```
import secrets
webhook_secret = secrets.token_urlsafe(32)
print(webhook_secret)
```

Node.js

Example code to generate a secret (ES module format)

```
import crypto from 'crypto';
let webhookSecret = crypto.randomBytes(32).toString('base64');
console.log(webhookSecret)
```

2. Store your generated string as an environment variable for your function by doing the following:
 - a. In the **Configuration** tab for your function, select **Environment variables**.
 - b. Choose **Edit**.
 - c. Choose **Add environment variable**.
 - d. For **Key**, enter **WEBHOOK_SECRET**, then for **Value**, enter the secret you generated in the previous step.
 - e. Choose **Save**.

You'll need to use this secret again later in the tutorial to test your function, so make a note of it now.

Create the function URL endpoint

Create an endpoint for your webhook using a Lambda function URL. Because you use the auth type of NONE to create an endpoint with public access, anyone with the URL can invoke your function. To learn more about controlling access to function URLs, see [the section called "Access control"](#). If you need more advanced authentication options for your webhook, consider using API Gateway.

Create the function URL endpoint

1. In the **Configuration** tab for your function, select **Function URL**.
2. Choose **Create function URL**.
3. For **Auth type**, select **NONE**.
4. Choose **Save**.

The endpoint for the function URL you just created is displayed in the **Function URL** pane. Copy the endpoint to use later in the tutorial.

Test the function in the console

Before using an HTTP request to invoke your function using the URL endpoint, test it in the console to confirm your code is working as expected.

To verify the function in the console, you first calculate a webhook signature using the secret you generated earlier in the tutorial with the following test JSON payload:

```
{
  "type": "payment.success",
  "orderId": "1234",
  "amount": "99.99"
}
```

Use either of the following Python or Node.js code examples to calculate the webhook signature using your own secret.

Python

Calculate the webhook signature

1. Save the following code as a file named `calculate_signature.py`. Replace the webhook secret in the code with your own value.

```
import secrets
import hmac
import json
import hashlib
```

```
webhook_secret = "ar1bSDCP86n_1H90s0fL_Qb2NAHBIBQ0yGI0X4Zay4M"

body = json.dumps({"type": "payment.success", "orderId": "1234", "amount":
    "99.99"})

signature = hmac.new(
    webhook_secret.encode('utf-8'),
    body.encode('utf-8'),
    hashlib.sha256
).hexdigest()

print(signature)
```

2. Calculate the signature by running the following command from the same directory you saved the code in. Copy the signature the code outputs.

```
python calculate_signature.py
```

Node.js

Calculate the webhook signature

1. Save the following code as a file named `calculate_signature.mjs`. Replace the webhook secret in the code with your own value.

```
import crypto from 'crypto';

const webhookSecret = "ar1bSDCP86n_1H90s0fL_Qb2NAHBIBQ0yGI0X4Zay4M"
const body = "{\"type\": \"payment.success\", \"orderId\": \"1234\", \"amount\": \"99.99\"}";

let hmac = crypto.createHmac('sha256', webhookSecret);
let signature = hmac.update(body).digest('hex');

console.log(signature);
```

2. Calculate the signature by running the following command from the same directory you saved the code in. Copy the signature the code outputs.

```
node calculate_signature.mjs
```

You can now test your function code using a test HTTP request in the console.

Test the function in the console

1. Select the **Code** tab for your function.
2. In the **TEST EVENTS** section, choose **Create new test event**
3. For **Event Name**, enter **myEvent**.
4. Replace the existing JSON by copying and pasting the following into the **Event JSON** pane. Replace the webhook signature with the value you calculated in the previous step.

```
{
  "headers": {
    "Content-Type": "application/json",
    "x-webhook-signature":
      "2d672e7a0423fab740fbc040e801d1241f2df32d2fffd8989617a599486553e2a"
  },
  "body": "{\"type\": \"payment.success\", \"orderId\": \"1234\", \"amount\": \"99.99\"}"
}
```

5. Choose **Save**.
6. Choose **Invoke**.

You should see output similar to the following:

Python

```
Status: Succeeded
Test Event Name: myEvent

Response:
{
  "statusCode": 200,
  "body": "{\"received\": true}"
}

Function Logs:
START RequestId: 50cc0788-d70e-453a-9a22-ceaa210e8ac6 Version: $LATEST
Processing successful payment for order 1234
END RequestId: 50cc0788-d70e-453a-9a22-ceaa210e8ac6
```

```
REPORT RequestId: 50cc0788-d70e-453a-9a22-ceaa210e8ac6 Duration: 1.55 ms Billed
Duration: 2 ms Memory Size: 128 MB Max Memory Used: 36 MB Init Duration: 136.32
ms
```

Node.js

```
Status: Succeeded
Test Event Name: myEvent

Response:
{
  "statusCode": 200,
  "body": "{\"received\":true}"
}

Function Logs:
START RequestId: e54fe6c7-1df9-4f05-a4c4-0f71cacd64f4 Version: $LATEST
2025-01-10T18:05:42.062Z e54fe6c7-1df9-4f05-a4c4-0f71cacd64f4 INFO Processing
successful payment for order 1234
END RequestId: e54fe6c7-1df9-4f05-a4c4-0f71cacd64f4
REPORT RequestId: e54fe6c7-1df9-4f05-a4c4-0f71cacd64f4 Duration: 60.10 ms Billed
Duration: 61 ms Memory Size: 128 MB Max Memory Used: 72 MB Init Duration:
174.46 ms

Request ID: e54fe6c7-1df9-4f05-a4c4-0f71cacd64f4
```

Test the function using an HTTP request

Use the curl command line tool to test your webhook endpoint.

Test the function using HTTP requests

1. In a terminal or shell program, run the following curl command. Replace the URL with the value for your own function URL endpoint and replace the webhook signature with the signature you calculated using your own secret key.

```
curl -X POST https://ryqgmbx5xjzxahif6frvzikpre0bpvpf.lambda-url.us-west-2.on.aws/
\
-H "Content-Type: application/json" \
-H "x-webhook-
signature: d5f52b76ffba65ff60ea73da67bdf1fc5825d4db56b5d3ffa0b64b7cb85ef48b" \
```

```
-d '{"type": "payment.success", "orderId": "1234", "amount": "99.99}"'
```

You should see the following output:

```
{"received": true}
```

2. Inspect the CloudWatch logs for your function to confirm it parsed the payload correctly by doing the following:
 - a. Open the [Logs group](#) page in the Amazon CloudWatch console.
 - b. Select your function's log group (/aws/lambda/myLambdaWebhook).
 - c. Select the most recent log stream.

You should see output similar to the following in your function's logs:

Python

```
Processing successful payment for order 1234
```

Node.js

```
2025-01-10T18:05:42.062Z e54fe6c7-1df9-4f05-a4c4-0f71cacd64f4 INFO  
Processing successful payment for order 1234
```

3. Confirm that your code detects an invalid signature by running the following curl command. Replace the URL with your own function URL endpoint.

```
curl -X POST https://ryqgmbx5xjzxahif6frvzikpre0bpvpf.lambda-url.us-west-2.on.aws/  
\  
-H "Content-Type: application/json" \  
-H "x-webhook-signature: abcdefg" \  
-d '{"type": "payment.success", "orderId": "1234", "amount": "99.99}"'
```

You should see the following output:

```
{"error": "Invalid signature"}
```

Clean up your resources

You can now delete the resources that you created for this tutorial, unless you want to retain them. By deleting AWS resources that you're no longer using, you prevent unnecessary charges to your AWS account.

To delete the Lambda function

1. Open the [Functions page](#) of the Lambda console.
2. Select the function that you created.
3. Choose **Actions, Delete**.
4. Type **confirm** in the text input field and choose **Delete**.

When you created the Lambda function in the console, Lambda also created an [execution role](#) for your function.

To delete the execution role

1. Open the [Roles page](#) of the IAM console.
2. Select the execution role that Lambda created. The role has the name format `myLambdaWebhook-role-<random string>`.
3. Choose **Delete**.
4. Enter the name of the role in the text input field and choose **Delete**.

Understanding Lambda function scaling

Concurrency is the number of in-flight requests that your AWS Lambda function is handling at the same time. For each concurrent request, Lambda provisions a separate instance of your execution environment. As your functions receive more requests, Lambda automatically handles scaling the number of execution environments until you reach your account's concurrency limit. By default, Lambda provides your account with a total concurrency limit of 1,000 concurrent executions across all functions in an AWS Region. To support your specific account needs, you can [request a quota increase](#) and configure function-level concurrency controls so that your critical functions don't experience throttling.

This topic explains concurrency concepts and function scaling in Lambda. By the end of this topic, you'll be able to understand how to calculate concurrency, visualize the two main concurrency control options (reserved and provisioned), estimate appropriate concurrency control settings, and view metrics for further optimization.

Sections

- [Understanding and visualizing concurrency](#)
- [Calculating concurrency for a function](#)
- [Understanding reserved concurrency and provisioned concurrency](#)
- [Understanding concurrency and requests per second](#)
- [Concurrency quotas](#)
- [Configuring reserved concurrency for a function](#)
- [Configuring provisioned concurrency for a function](#)
- [Lambda scaling behavior](#)
- [Monitoring concurrency](#)

Understanding and visualizing concurrency

Lambda invokes your function in a secure and isolated [execution environment](#). To handle a request, Lambda must first initialize an execution environment (the [Init phase](#)), before using it to invoke your function (the [Invoke phase](#)):

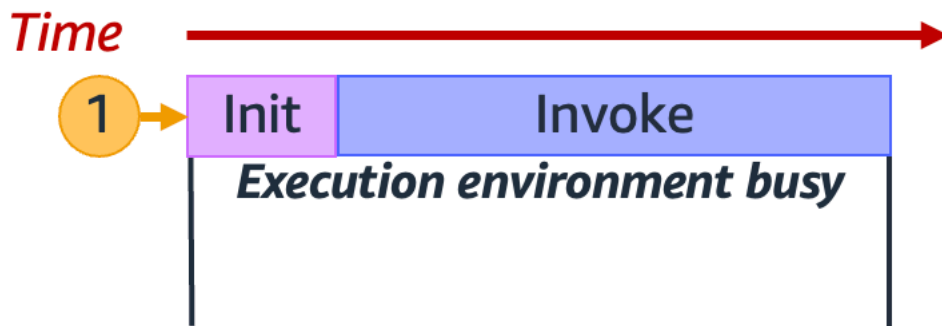
**Note**

Actual Init and Invoke durations can vary depending on many factors, such as the runtime you choose and the Lambda function code. The previous diagram isn't meant to represent the exact proportions of Init and Invoke phase durations.

The previous diagram uses a rectangle to represent a single execution environment. When your function receives its very first request (represented by the yellow circle with label 1), Lambda creates a new execution environment and runs the code outside your main handler during the Init phase. Then, Lambda runs your function's main handler code during the Invoke phase. During this entire process, this execution environment is busy and cannot process other requests.

When Lambda finishes processing the first request, this execution environment can then process additional requests for the same function. For subsequent requests, Lambda doesn't need to re-initialize the environment.

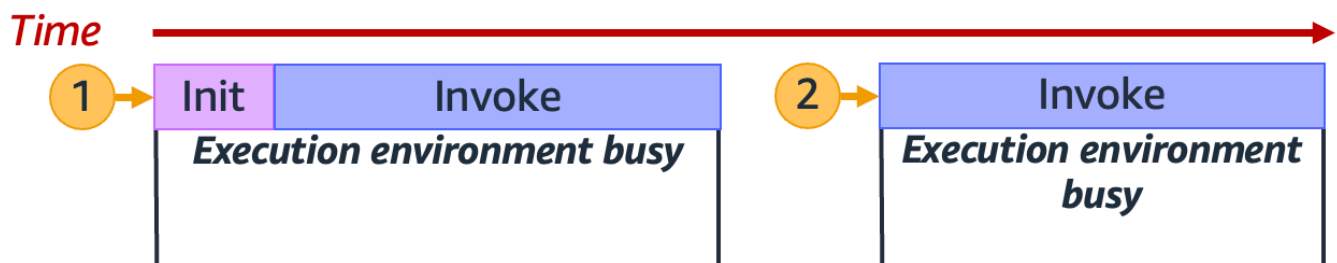

In the previous diagram, Lambda reuses the execution environment to handle the second request (represented by the yellow circle with label 2).

So far, we've focused on just a single instance of your execution environment (that is, a concurrency of 1). In practice, Lambda may need to provision multiple execution environment instances in parallel to handle all incoming requests. When your function receives a new request, one of two things can happen:

- If a pre-initialized execution environment instance is available, Lambda uses it to process the request.
- Otherwise, Lambda creates a new execution environment instance to process the request.

For example, let's explore what happens when your function receives 10 requests:

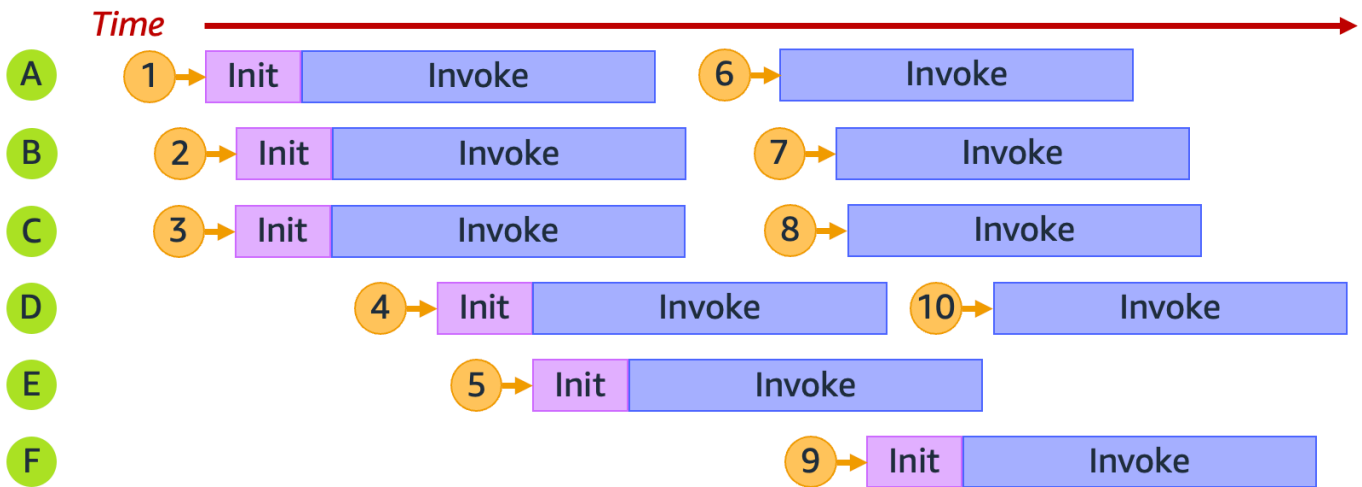

In the previous diagram, each horizontal plane represents a single execution environment instance (labeled from A through F). Here's how Lambda handles each request:

Request	Lambda behavior	Reasoning
1	Provisions new environment A	This is the first request; no execution environment instances are available.
2	Provisions new environment B	Existing execution environment instance A is busy.

Request	Lambda behavior	Reasoning
3	Provisions new environment C	Existing execution environment instances A and B are both busy.
4	Provisions new environment D	Existing execution environment instances A , B , and C are all busy.
5	Provisions new environment E	Existing execution environment instances A , B , C , and D are all busy.
6	Reuses environment A	Execution environment instance A has finished processing request 1 and is now available.
7	Reuses environment B	Execution environment instance B has finished processing request 2 and is now available.
8	Reuses environment C	Execution environment instance C has finished processing request 3 and is now available.
9	Provisions new environment F	Existing execution environment instances A , B , C , D , and E are all busy.
10	Reuses environment D	Execution environment instance D has finished processing request 4 and is now available.

As your function receives more concurrent requests, Lambda scales up the number of execution environment instances in response. The following animation tracks the number of concurrent requests over time:

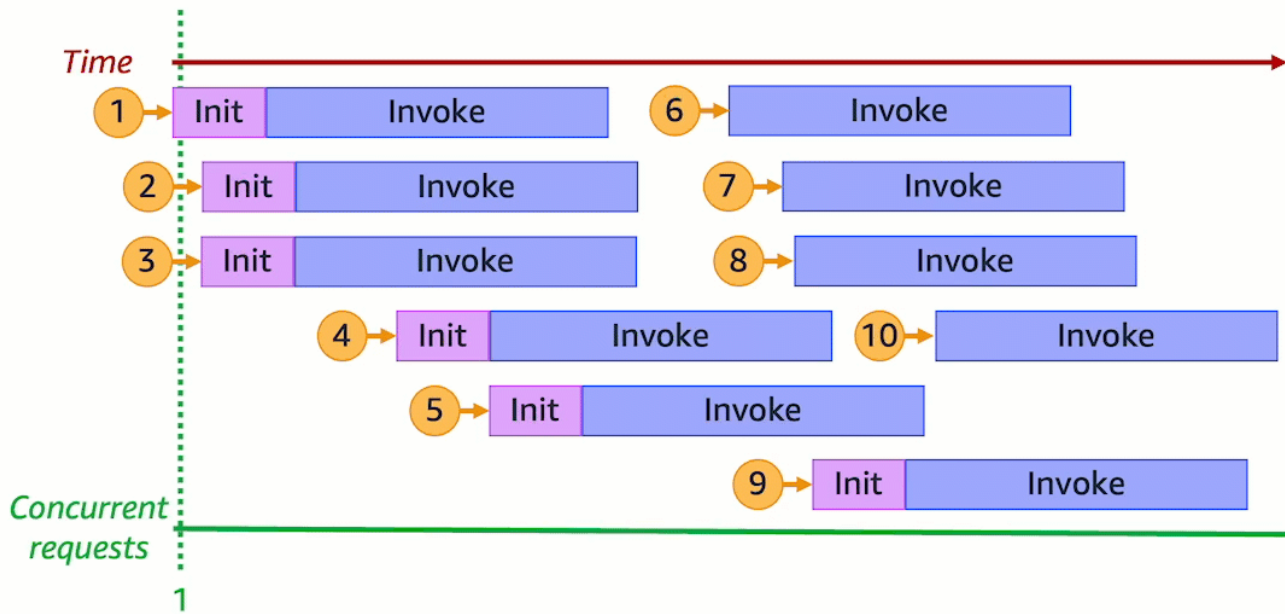

By freezing the previous animation at six distinct points in time, we get the following diagram:

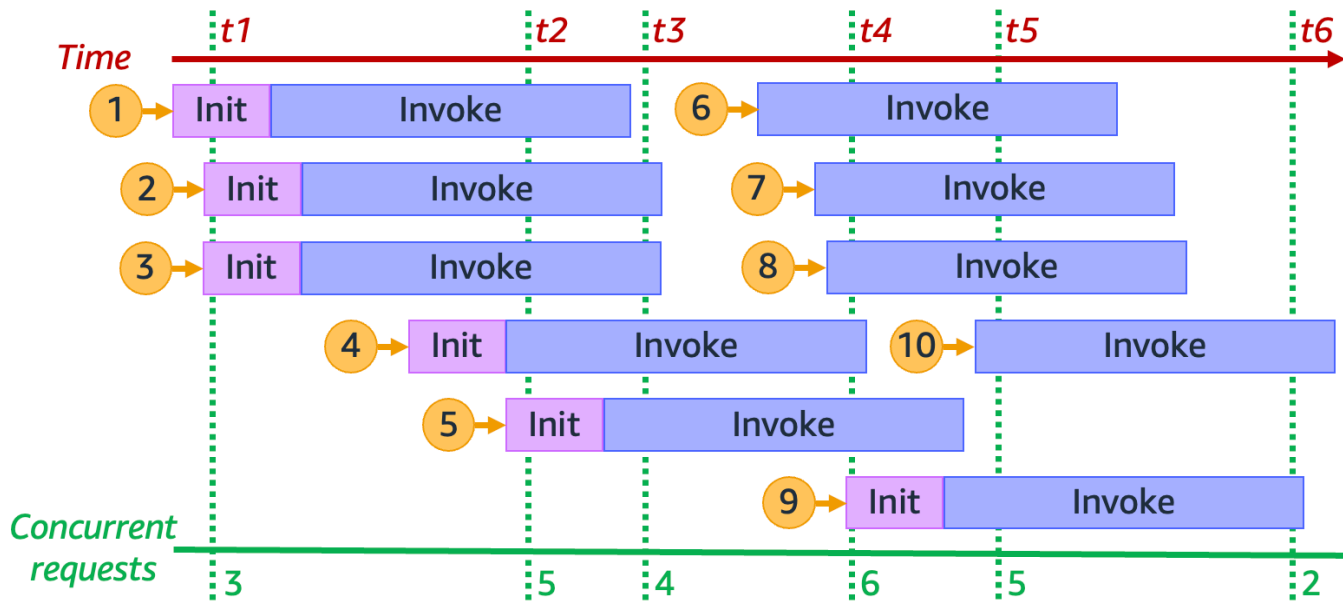

In the previous diagram, we can draw a vertical line at any point in time and count the number of environments that intersect this line. This gives us the number of concurrent requests at that point in time. For example, at time t_1 , there are three active environments serving three concurrent requests. The maximum number of concurrent requests in this simulation occurs at time t_4 , when there are six active environments serving six concurrent requests.

To summarize, your function's concurrency is the number of concurrent requests that it's handling at the same time. In response to an increase in your function's concurrency, Lambda provisions more execution environment instances to meet request demand.

Calculating concurrency for a function

In general, concurrency of a system is the ability to process more than one task simultaneously. In Lambda, concurrency is the number of in-flight requests that your function is handling at the same time. A quick and practical way of measuring concurrency of a Lambda function is to use the following formula:

$$\text{Concurrency} = (\text{average requests per second}) * (\text{average request duration in seconds})$$

Concurrency differs from requests per second. For example, suppose your function receives 100 requests per second on average. If the average request duration is one second, then it's true that the concurrency is also 100:

$$\text{Concurrency} = (100 \text{ requests/second}) * (1 \text{ second/request}) = 100$$

However, if the average request duration is 500 ms, then the concurrency is 50:

$$\text{Concurrency} = (100 \text{ requests/second}) * (0.5 \text{ second/request}) = 50$$

What does a concurrency of 50 mean in practice? If the average request duration is 500 ms, then you can think of an instance of your function as being able to handle two requests per second. Then, it takes 50 instances of your function to handle a load of 100 requests per second. A concurrency of 50 means that Lambda must provision 50 execution environment instances to efficiently handle this workload without any throttling. Here's how to express this in equation form:

$$\text{Concurrency} = (100 \text{ requests/second}) / (2 \text{ requests/second}) = 50$$

If your function receives double the number of requests (200 requests per second), but only requires half the time to process each request (250 ms), then the concurrency is still 50:

$$\text{Concurrency} = (200 \text{ requests/second}) * (0.25 \text{ second/request}) = 50$$

Test your understanding of concurrency

Suppose you have a function that takes, on average, 200 ms to run. During peak load, you observe 5,000 requests per second. What is the concurrency of your function during peak load?

Answer

The average function duration is 200 ms, or 0.2 seconds. Using the concurrency formula, you can plug in the numbers to get a concurrency of 1,000:

$$\text{Concurrency} = (5,000 \text{ requests/second}) * (0.2 \text{ seconds/request}) = 1,000$$

Alternatively, an average function duration of 200 ms means that your function can process 5 requests per second. To handle the 5,000 request per second workload, you need 1,000 execution environment instances. Thus, the concurrency is 1,000:

$$\text{Concurrency} = (5,000 \text{ requests/second}) / (5 \text{ requests/second}) = 1,000$$

Understanding reserved concurrency and provisioned concurrency

By default, your account has a concurrency limit of 1,000 concurrent executions across all functions in a Region. Your functions share this pool of 1,000 concurrency on an on-demand basis. Your functions experiences throttling (that is, they start to drop requests) if you run out of available concurrency.

Some of your functions might be more critical than others. As a result, you might want to configure concurrency settings to ensure that critical functions get the concurrency that they need. There are two types of concurrency controls available: reserved concurrency and provisioned concurrency.

- Use **reserved concurrency** to reserve a portion of your account's concurrency for a function. This is useful if you don't want other functions taking up all the available unreserved concurrency.

- Use **provisioned concurrency** to pre-initialize a number of environment instances for a function. This is useful for reducing cold start latencies.

Reserved concurrency

If you want to guarantee that a certain amount of concurrency is available for your function at any time, use reserved concurrency.

Reserved concurrency is the maximum number of concurrent instances that you want to allocate to your function. When you dedicate reserved concurrency to a function, no other function can use that concurrency. In other words, setting reserved concurrency can impact the concurrency pool that's available to other functions. Functions that don't have reserved concurrency share the remaining pool of unreserved concurrency.

Configuring reserved concurrency counts towards your overall account concurrency limit. There is no charge for configuring reserved concurrency for a function.

To better understand reserved concurrency, consider the following diagram:

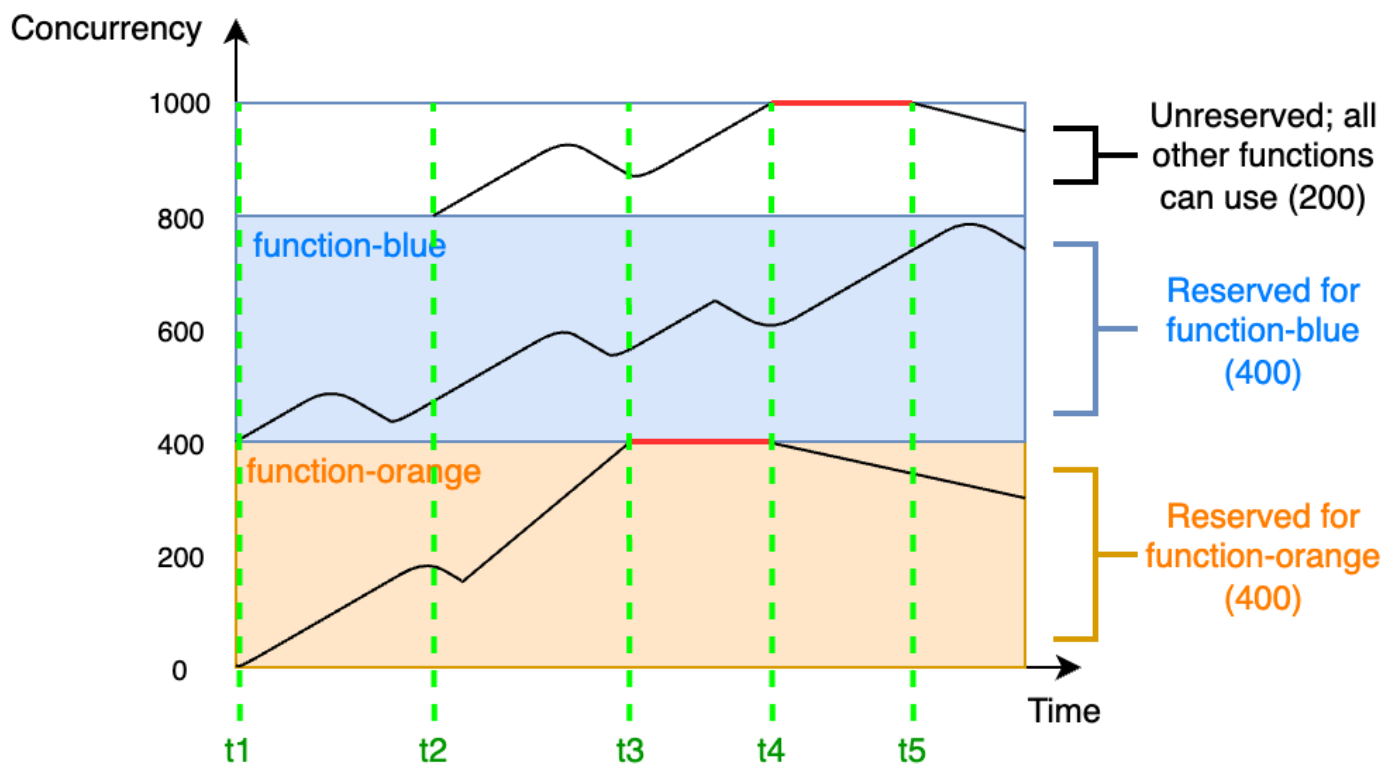

In this diagram, your account concurrency limit for all the functions in this Region is at the default limit of 1,000. Suppose you have two critical functions, `function-blue` and `function-orange`, that routinely expect to get high invocation volumes. You decide to give 400 units of reserved concurrency to `function-blue`, and 400 units of reserved concurrency to `function-orange`. In this example, all other functions in your account must share the remaining 200 units of unreserved concurrency.

The diagram has five points of interest:

- At t_1 , both `function-orange` and `function-blue` begin receiving requests. Each function begins to use up its allocated portion of reserved concurrency units.
- At t_2 , `function-orange` and `function-blue` steadily receive more requests. At the same time, you deploy some other Lambda functions, which begin receiving requests. You don't allocate reserved concurrency to these other functions. They begin using the remaining 200 units of unreserved concurrency.
- At t_3 , `function-orange` hits the max concurrency of 400. Although there is unused concurrency elsewhere in your account, `function-orange` cannot access it. The red line indicates that `function-orange` is experiencing throttling, and Lambda may drop requests.
- At t_4 , `function-orange` starts to receive fewer requests and is no longer throttling. However, your other functions experience a spike in traffic and begin throttling. Although there is unused concurrency elsewhere in your account, these other functions cannot access it. The red line indicates that your other functions are experiencing throttling.
- At t_5 , other functions start to receive fewer requests and are no longer throttling.

From this example, notice that reserving concurrency has the following effects:

- **Your function can scale independently of other functions in your account.** All of your account's functions in the same Region that don't have reserved concurrency share the pool of unreserved concurrency. Without reserved concurrency, other functions can potentially use up all of your available concurrency. This prevents critical functions from scaling up if needed.
- **Your function can't scale out of control.** Reserved concurrency caps your function's maximum concurrency. This means that your function can't use concurrency reserved for other functions, or concurrency from the unreserved pool. You can reserve concurrency to prevent your function from using all the available concurrency in your account, or from overloading downstream resources.

- **You may not be able to use all of your account's available concurrency.** Reserving concurrency counts towards your account concurrency limit, but this also means that other functions cannot use that chunk of reserved concurrency. If your function doesn't use up all of the concurrency that you reserve for it, you're effectively wasting that concurrency. This isn't an issue unless other functions in your account could benefit from the wasted concurrency.

To learn how to manage reserved concurrency settings for your functions, see [Configuring reserved concurrency for a function](#).

Provisioned concurrency

You use reserved concurrency to define the maximum number of execution environments reserved for a Lambda function. However, none of these environments come pre-initialized. As a result, your function invocations may take longer because Lambda must first initialize the new environment before being able to use it to invoke your function. When Lambda has to initialize a new environment in order to carry out an invocation, this is known as a cold start. To mitigate cold starts, you can use provisioned concurrency.

Provisioned concurrency is the number of pre-initialized execution environments that you want to allocate to your function. If you set provisioned concurrency on a function, Lambda initializes that number of execution environments so that they are prepared to respond immediately to function requests.

Note

Using provisioned concurrency incurs additional charges to your account. If you're working with the Java 11 or Java 17 runtimes, you can also use Lambda SnapStart to mitigate cold start issues at no additional cost. SnapStart uses cached snapshots of your execution environment to significantly improve startup performance. You cannot use both SnapStart and provisioned concurrency on the same function version. For more information about SnapStart features, limitations, and supported Regions, see [Improving startup performance with Lambda SnapStart](#).

When using provisioned concurrency, Lambda still recycles execution environments in the background. However, at any given time, Lambda always ensures that the number of pre-initialized environments is equal to the value of your function's provisioned concurrency setting.

This behavior differs from reserved concurrency, where Lambda may completely terminate an environment after a period of inactivity. The following diagram illustrates this by comparing the lifecycle of a single execution environment when you configure your function using reserved concurrency compared to provisioned concurrency.

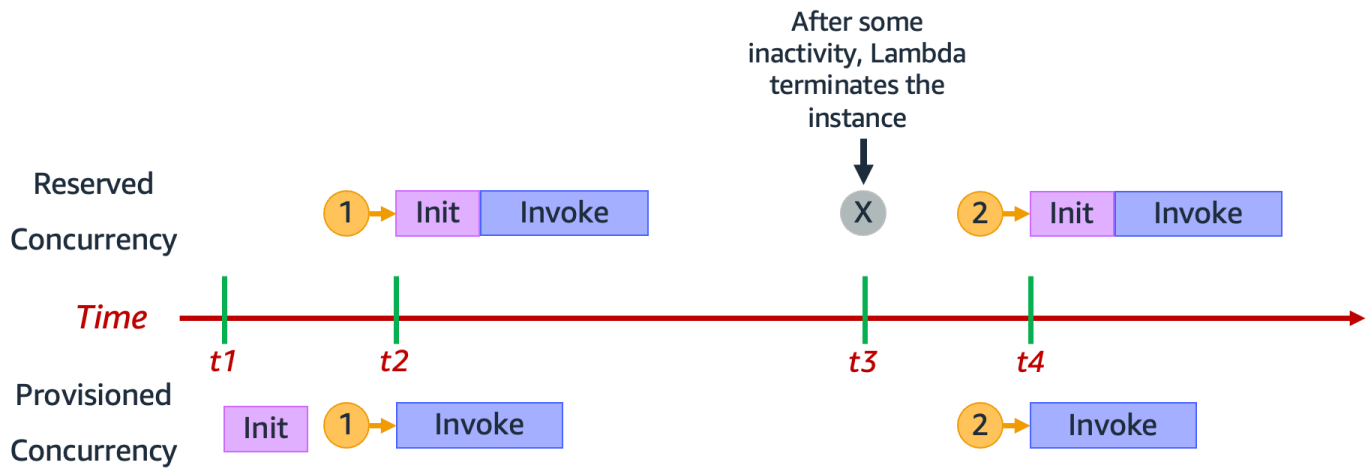

The diagram has four points of interest:

Time	Reserved concurrency	Provisioned concurrency
t1	Nothing happens.	Lambda pre-initializes an execution environment instance.
t2	Request 1 comes in. Lambda must initialize a new execution environment instance.	Request 1 comes in. Lambda uses the pre-initialized environment instance.
t3	After some inactivity, Lambda terminates the active environment instance.	Nothing happens.
t4	Request 2 comes in. Lambda must initialize a new execution environment instance.	Request 2 comes in. Lambda uses the pre-initialized environment instance.

To better understand provisioned concurrency, consider the following diagram:

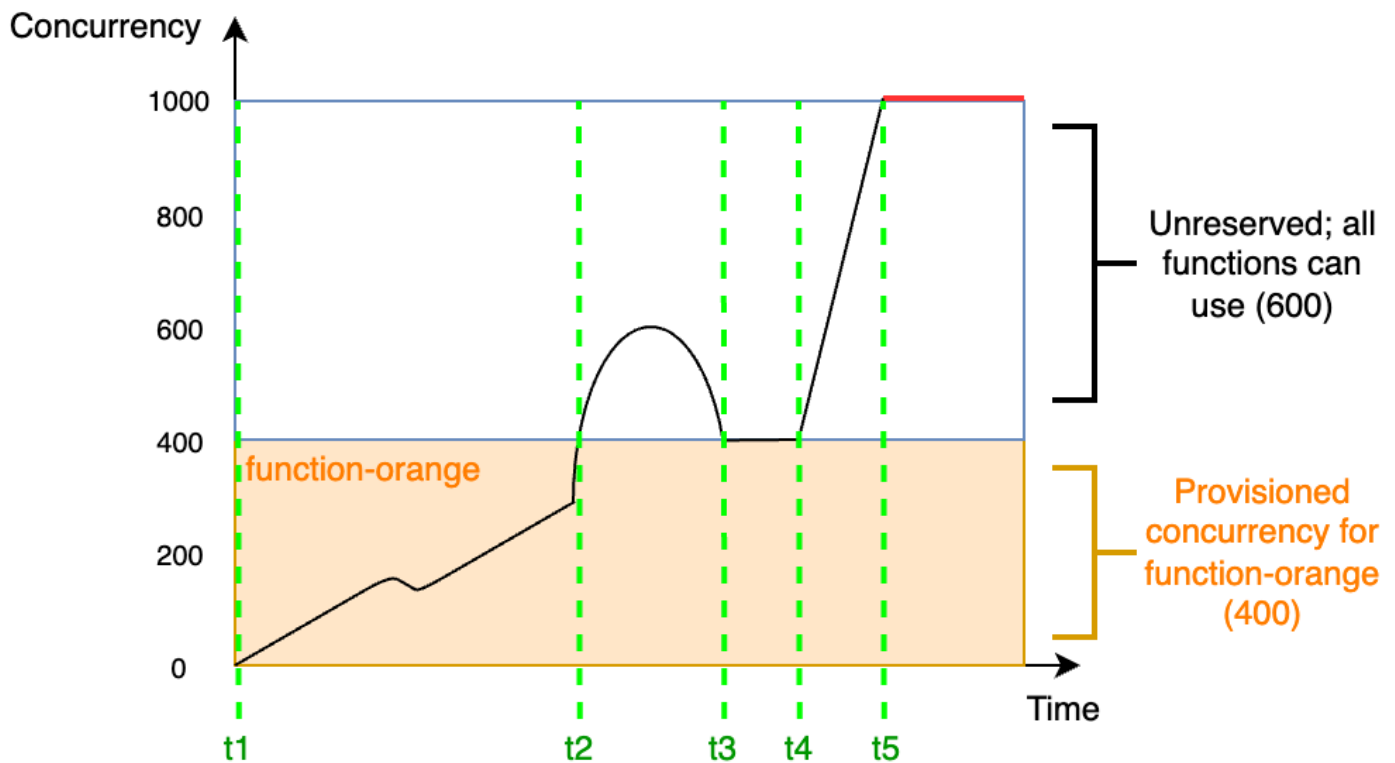

In this diagram, you have an account concurrency limit of 1,000. You decide to give 400 units of provisioned concurrency to `function-orange`. All functions in your account, *including* `function-orange`, can use the remaining 600 units of unreserved concurrency.

The diagram has five points of interest:

- At `t1`, `function-orange` begins receiving requests. Since Lambda has pre-initialized 400 execution environment instances, `function-orange` is ready for immediate invocation.
- At `t2`, `function-orange` reaches 400 concurrent requests. As a result, `function-orange` runs out of provisioned concurrency. However, since there's still unreserved concurrency available, Lambda can use this to handle additional requests to `function-orange` (there's no throttling). Lambda must create new instances to serve these requests, and your function may experience cold start latencies.
- At `t3`, `function-orange` returns to 400 concurrent requests after a brief spike in traffic. Lambda is again able to handle all requests without cold start latencies.

- At t_4 , functions in your account experience a burst in traffic. This burst can come from `function-orange` or any other function in your account. Lambda uses unreserved concurrency to handle these requests.
- At t_5 , functions in your account reach the maximum concurrency limit of 1,000, and experience throttling.

The previous example considered only provisioned concurrency. In practice, you can set both provisioned concurrency and reserved concurrency on a function. You might do this if you had a function that handles a consistent load of invocations on weekdays, but routinely sees spikes of traffic on weekends. In this case, you could use provisioned concurrency to set a baseline amount of environments to handle request during weekdays, and use reserved concurrency to handle the weekend spikes. Consider the following diagram:

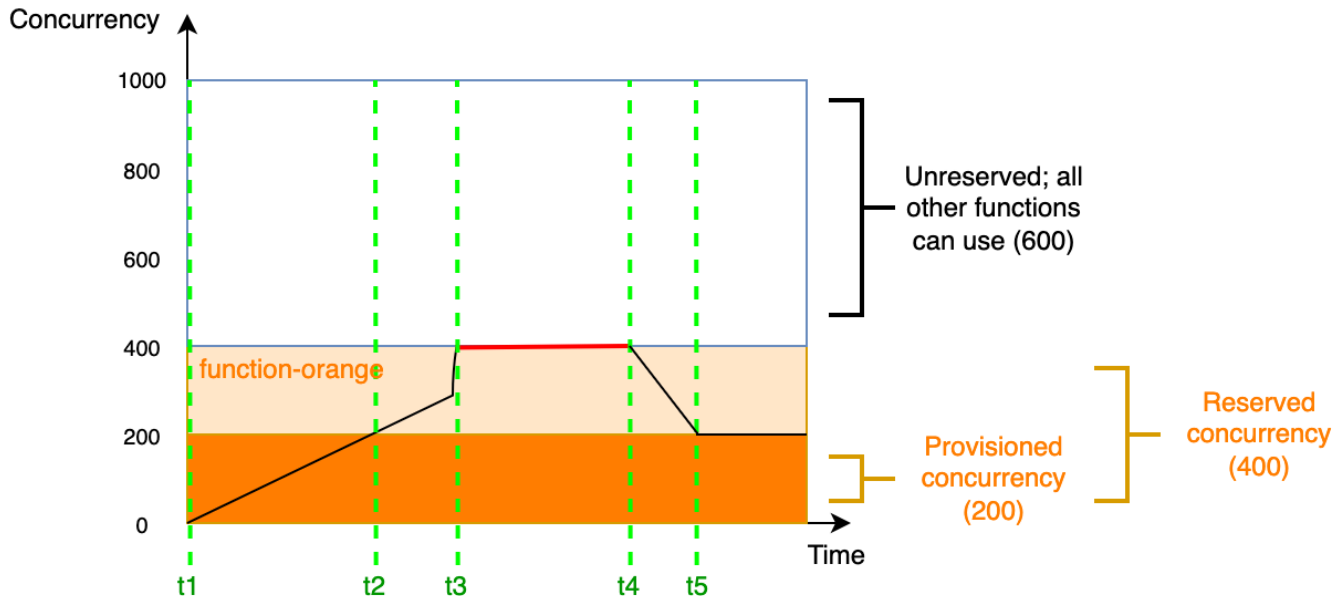

In this diagram, suppose that you configure 200 units of provisioned concurrency and 400 units of reserved concurrency for `function-orange`. Because you configured reserved concurrency, `function-orange` cannot use any of the 600 units of unreserved concurrency.

This diagram has five points of interest:

- At t_1 , `function-orange` begins receiving requests. Since Lambda has pre-initialized 200 execution environment instances, `function-orange` is ready for immediate invocation.

- At t_2 , `function-orange` uses up all its provisioned concurrency. `function-orange` can continue serving requests using reserved concurrency, but these requests may experience cold start latencies.
- At t_3 , `function-orange` reaches 400 concurrent requests. As a result, `function-orange` uses up all its reserved concurrency. Since `function-orange` cannot use unreserved concurrency, requests begin to throttle.
- At t_4 , `function-orange` starts to receive fewer requests, and no longer throttles.
- At t_5 , `function-orange` drops down to 200 concurrent requests, so all requests are again able to use provisioned concurrency (that is, no cold start latencies).

Both reserved concurrency and provisioned concurrency count towards your account concurrency limit and [Regional quotas](#). In other words, allocating reserved and provisioned concurrency can impact the concurrency pool that's available to other functions. Configuring provisioned concurrency incurs charges to your AWS account.

Note

If the amount of provisioned concurrency on a function's versions and aliases adds up to the function's reserved concurrency, then all invocations run on provisioned concurrency. This configuration also has the effect of throttling the unpublished version of the function (\$LATEST), which prevents it from executing. You can't allocate more provisioned concurrency than reserved concurrency for a function.

To manage provisioned concurrency settings for your functions, see [Configuring provisioned concurrency for a function](#). To automate provisioned concurrency scaling based on a schedule or application utilization, see [Using Application Auto Scaling to automate provisioned concurrency management](#).

How Lambda allocates provisioned concurrency

Provisioned concurrency doesn't come online immediately after you configure it. Lambda starts allocating provisioned concurrency after a minute or two of preparation. For each function, Lambda can provision up to 6,000 execution environments every minute, regardless of AWS Region. This is exactly the same as the [concurrency scaling rate](#) for functions.

When you submit a request to allocate provisioned concurrency, you can't access any of those environments until Lambda completely finishes allocating them. For example, if you request 5,000 provisioned concurrency, none of your requests can use provisioned concurrency until Lambda completely finishes allocating the 5,000 execution environments.

Comparing reserved concurrency and provisioned concurrency

The following table summarizes and compares reserved and provisioned concurrency.

Topic	Reserved concurrency	Provisioned concurrency
Definition	Maximum number of execution environment instances for your function.	Set number of pre-provisioned execution environment instances for your function.
Provisioning behavior	Lambda provisions new instances on an on-demand basis.	Lambda pre-provisions instances (that is, before your function starts receiving requests).
Cold start behavior	Cold start latency possible, since Lambda must create new instances on-demand.	Cold start latency not possible, since Lambda doesn't have to create instances on-demand.
Throttling behavior	Function throttled when reserved concurrency limit reached.	If reserved concurrency not set: function uses unreserved concurrency when provisioned concurrency limit reached. If reserved concurrency set: function throttled when reserved concurrency limit reached.
Default behavior if not set	Function uses unreserved concurrency available in your account.	Lambda doesn't pre-provision any instances. Instead, if reserved concurrency not set: function uses unreserved

Topic	Reserved concurrency	Provisioned concurrency
		concurrency available in your account. If reserved concurrency set: function uses reserved concurrency.
Pricing	No additional charge.	Incurs additional charges.

Understanding concurrency and requests per second

As mentioned in the previous section, concurrency differs from requests per second. This is an especially important distinction to make when working with functions that have an average request duration of less than 100 ms.

Across all functions in your account, Lambda enforces a requests per second limit that's equal to 10 times your account concurrency. For example, since the default account concurrency limit is 1,000, functions in your account can handle a maximum of 10,000 requests per second.

For example, consider a function with an average request duration of 50 ms. At 20,000 requests per second, here's the concurrency of this function:

$$\text{Concurrency} = (20,000 \text{ requests/second}) * (0.05 \text{ second/request}) = 1,000$$

Based on this result, you might expect that the account concurrency limit of 1,000 is sufficient to handle this load. However, because of the 10,000 requests per second limit, your function can only handle 10,000 requests per second out of the 20,000 total requests. This function experiences throttling.

The lesson is that you must consider both concurrency and requests per second when configuring concurrency settings for your functions. In this case, you need to request an account concurrency limit increase to 2,000, since this would increase your total requests per second limit to 20,000.

Note

Based on this request per second limit, it's incorrect to say that each Lambda execution environment can handle only a maximum of 10 requests per second. Instead of observing

the load on any individual execution environment, Lambda only considers overall concurrency and overall requests per second when calculating your quotas.

Test your understanding of concurrency (sub-100 ms functions)

Suppose that you have a function that takes, on average, 20 ms to run. During peak load, you observe 30,000 requests per second. What is the concurrency of your function during peak load?

Answer

The average function duration is 20 ms, or 0.02 seconds. Using the concurrency formula, you can plug in the numbers to get a concurrency of 600:

$$\text{Concurrency} = (30,000 \text{ requests/second}) * (0.02 \text{ seconds/request}) = 600$$

By default, the account concurrency limit of 1,000 seems sufficient to handle this load. However, the requests per second limit of 10,000 isn't enough to handle the incoming 30,000 requests per second. To fully accommodate the 30,000 requests, you need to request an account concurrency limit increase to 3,000 or higher.

The requests per second limit applies to all quotas in Lambda that involve concurrency. In other words, it applies to synchronous on-demand functions, functions that use provisioned concurrency, and [concurrency scaling behavior](#). For example, here are a few scenarios where you must carefully consider both your concurrency and request per second limits:

- A function using on-demand concurrency can experience a burst increase of 500 concurrency every 10 seconds, or by 5,000 requests per second every 10 seconds, whichever happens first.
- Suppose you have a function that has a provisioned concurrency allocation of 10. This function spills over into on-demand concurrency after 10 concurrency or 100 requests per second, whichever happens first.

Concurrency quotas

Lambda sets quotas for the total amount of concurrency that you can use across all functions in a Region. These quotas exist on two levels:

- **At the account level**, your functions can have up to 1,000 units of concurrency by default. To increase this limit, see [Requesting a quota increase](#) in the *Service Quotas User Guide*.

- **At the function level**, you can reserve up to 900 units of concurrency across all your functions by default. Regardless of your total account concurrency limit, Lambda always reserves 100 units of concurrency for your functions that don't explicitly reserve concurrency. For example, if you increased your account concurrency limit to 2,000, then you can reserve up to 1,900 units of concurrency at the function level.
- At both the account level and the function level, Lambda also enforces a requests per second limit of equal to 10 times the corresponding concurrency quota. For instance, this applies to account-level concurrency, functions using on-demand concurrency, functions using provisioned concurrency, and [concurrency scaling behavior](#). For more information, see [the section called "Understanding concurrency and requests per second"](#).

To check your current account level concurrency quota, use the AWS Command Line Interface (AWS CLI) to run the following command:

```
aws lambda get-account-settings
```

You should see output that looks like the following:

```
{
  "AccountLimit": {
    "TotalCodeSize": 80530636800,
    "CodeSizeUnzipped": 262144000,
    "CodeSizeZipped": 52428800,
    "ConcurrentExecutions": 1000,
    "UnreservedConcurrentExecutions": 900
  },
  "AccountUsage": {
    "TotalCodeSize": 410759889,
    "FunctionCount": 8
  }
}
```

`ConcurrentExecutions` is your total account-level concurrency quota.

`UnreservedConcurrentExecutions` is the amount of reserved concurrency that you can still allocate to your functions.

As your function receives more requests, Lambda automatically scales up the number of execution environments to handle these requests until your account reaches its concurrency quota. However, to protect against over-scaling in response to sudden bursts of traffic, Lambda limits how fast your

functions can scale. This **concurrency scaling rate** is the maximum rate at which functions in your account can scale in response to increased requests. (That is, how quickly Lambda can create new execution environments.) The concurrency scaling rate differs from the account-level concurrency limit, which is the total amount of concurrency available to your functions.

In each AWS Region, and for each function, your concurrency scaling rate is 1,000 execution environment instances every 10 seconds (or 10,000 requests per second every 10 seconds). In other words, every 10 seconds, Lambda can allocate at most 1,000 additional execution environment instances, or accommodate 10,000 additional requests per second, to each of your functions.

Usually, you don't need to worry about this limitation. Lambda's scaling rate is sufficient for most use cases.

Importantly, the concurrency scaling rate is a function-level limit. This means that each function in your account can scale independently of other functions.

For more information about scaling behavior, see [Lambda scaling behavior](#).

Configuring reserved concurrency for a function

In Lambda, [concurrency](#) is the number of in-flight requests that your function is currently handling. There are two types of concurrency controls available:

- **Reserved concurrency** – This represents the maximum number of concurrent instances allocated to your function. When a function has reserved concurrency, no other function can use that concurrency. Reserved concurrency is useful for ensuring that your most critical functions always have enough concurrency to handle incoming requests. Configuring reserved concurrency for a function incurs no additional charges.
- **Provisioned concurrency** – This is the number of pre-initialized execution environments allocated to your function. These execution environments are ready to respond immediately to incoming function requests. Provisioned concurrency is useful for reducing cold start latencies for functions. Configuring provisioned concurrency incurs additional charges to your AWS account.

This topic details how to manage and configure reserved concurrency. For a conceptual overview of these two types of concurrency controls, see [Reserved concurrency and provisioned concurrency](#). For information on configuring provisioned concurrency, see [the section called “Configuring provisioned concurrency”](#).

Note

Lambda functions linked to an Amazon MQ event source mapping have a default maximum concurrency. For Apache Active MQ, the maximum number of concurrent instances is 5. For Rabbit MQ, the maximum number of concurrent instances is 1. Setting reserved or provisioned concurrency for your function doesn't change these limits. To request an increase in the default maximum concurrency when using Amazon MQ, contact Support.

Sections

- [Configuring reserved concurrency](#)
- [Accurately estimating required reserved concurrency for a function](#)

Configuring reserved concurrency

You can configure reserved concurrency settings for a function using the Lambda console or the Lambda API.

To reserve concurrency for a function (console)

1. Open the [Functions page](#) of the Lambda console.
2. Choose the function you want to reserve concurrency for.
3. Choose **Configuration** and then choose **Concurrency**.
4. Under **Concurrency**, choose **Edit**.
5. Choose **Reserve concurrency**. Enter the amount of concurrency to reserve for the function.
6. Choose **Save**.

You can reserve up to the **Unreserved account concurrency** value minus 100. The remaining 100 units of concurrency are for functions that aren't using reserved concurrency. For example, if your account has a concurrency limit of 1,000, you cannot reserve all 1,000 units of concurrency to a single function.

Edit concurrency

Concurrency

Unreserved account concurrency: 0

Use unreserved account concurrency

Reserve concurrency

 The unreserved account concurrency can't go below 100.

Cancel **Save**

Reserving concurrency for a function impacts the concurrency pool that's available to other functions. For example, if you reserve 100 units of concurrency for `function-a`, other functions in

your account must share the remaining 900 units of concurrency, even if function-a doesn't use all 100 reserved concurrency units.

To intentionally throttle a function, set its reserved concurrency to 0. This stops your function from processing any events until you remove the limit.

To configure reserved concurrency with the Lambda API, use the following API operations.

- [PutFunctionConcurrency](#)
- [GetFunctionConcurrency](#)
- [DeleteFunctionConcurrency](#)

For example, to configure reserved concurrency with the AWS Command Line Interface (CLI), use the `put-function-concurrency` command. The following command reserves 100 concurrency units for a function named `my-function`:

```
aws lambda put-function-concurrency --function-name my-function \  
  --reserved-concurrent-executions 100
```

You should see output that looks like the following:

```
{  
  "ReservedConcurrentExecutions": 100  
}
```

Accurately estimating required reserved concurrency for a function

If your function is currently serving traffic, you can easily view its concurrency metrics using [CloudWatch metrics](#). Specifically, the `ConcurrentExecutions` metric shows you the number of concurrent invocations for each function in your account.

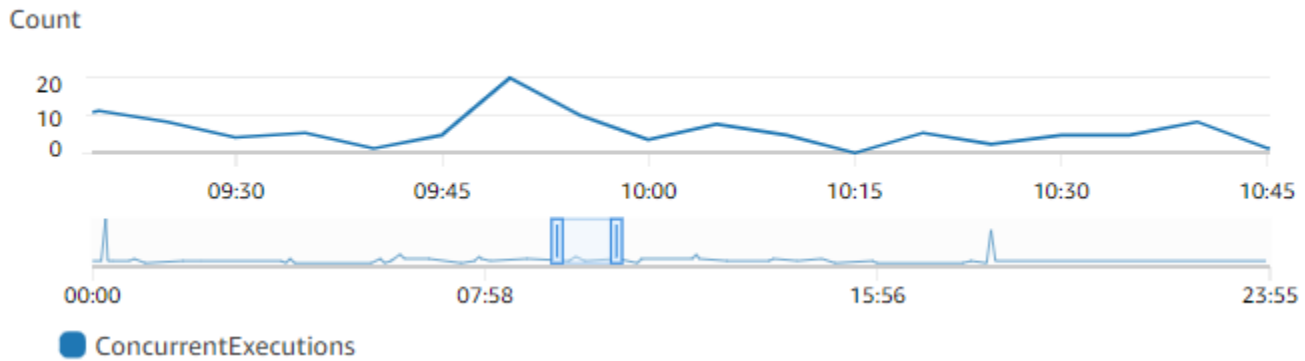

The previous graph suggests that this function serves an average of 5 to 10 concurrent requests at any given time, and peaks at 20 requests on a typical day. Suppose that there are many other functions in your account. **If this function is critical to your application and you don't want to drop any requests**, use a number greater than or equal to 20 as your reserved concurrency setting.

Alternatively, recall that you can also [calculate concurrency](#) using the following formula:

$$\text{Concurrency} = (\text{average requests per second}) * (\text{average request duration in seconds})$$

Multiplying average requests per second with the average request duration in seconds gives you a rough estimate of how much concurrency you need to reserve. You can estimate average requests per second using the `Invocation` metric, and the average request duration in seconds using the `Duration` metric. See [Using CloudWatch metrics with Lambda](#) for more details.

You should also be familiar with your upstream and downstream throughput constraints. While Lambda functions scale seamlessly with load, upstream and downstream dependencies may not have the same throughput capabilities. If you need to limit how high your function can scale, configure reserved concurrency on your function.

Configuring provisioned concurrency for a function

In Lambda, [concurrency](#) is the number of in-flight requests that your function is currently handling. There are two types of concurrency controls available:

- **Reserved concurrency** – This represents the maximum number of concurrent instances allocated to your function. When a function has reserved concurrency, no other function can use that concurrency. Reserved concurrency is useful for ensuring that your most critical functions always have enough concurrency to handle incoming requests. Configuring reserved concurrency for a function incurs no additional charges.
- **Provisioned concurrency** – This is the number of pre-initialized execution environments allocated to your function. These execution environments are ready to respond immediately to incoming function requests. Provisioned concurrency is useful for reducing cold start latencies for functions. Configuring provisioned concurrency incurs additional charges to your AWS account.

This topic details how to manage and configure provisioned concurrency. For a conceptual overview of these two types of concurrency controls, see [Reserved concurrency and provisioned concurrency](#). For more information on configuring reserved concurrency, see [the section called “Configuring reserved concurrency”](#).

Note

Lambda functions linked to an Amazon MQ event source mapping have a default maximum concurrency. For Apache Active MQ, the maximum number of concurrent instances is 5. For Rabbit MQ, the maximum number of concurrent instances is 1. Setting reserved or provisioned concurrency for your function doesn't change these limits. To request an increase in the default maximum concurrency when using Amazon MQ, contact Support.

Sections

- [Configuring provisioned concurrency](#)
- [Accurately estimating required provisioned concurrency for a function](#)
- [Optimizing function code when using provisioned concurrency](#)
- [Using environment variables to view and control provisioned concurrency behavior](#)
- [Understanding logging and billing behavior with provisioned concurrency](#)

- [Using Application Auto Scaling to automate provisioned concurrency management](#)

Configuring provisioned concurrency

You can configure provisioned concurrency settings for a function using the Lambda console or the Lambda API.

To allocate provisioned concurrency for a function (console)

1. Open the [Functions page](#) of the Lambda console.
2. Choose the function you want to allocate provisioned concurrency for.
3. Choose **Configuration** and then choose **Concurrency**.
4. Under **Provisioned concurrency configurations**, choose **Add configuration**.
5. Choose the qualifier type, and alias or version.

Note

You cannot use provisioned concurrency with the `$LATEST` version of any function. If your function has an event source, make sure that event source points to the correct function alias or version. Otherwise, your function won't use provisioned concurrency environments.

6. Enter a number under **Provisioned concurrency**. Lambda provides an estimate of monthly costs.
7. Choose **Save**.

You can configure up to the **Unreserved account concurrency** in your account, minus 100. The remaining 100 units of concurrency are for functions that aren't using reserved concurrency. For example, if your account has a concurrency limit of 1,000, and you haven't assigned any reserved or provisioned concurrency to any of your other functions, you can configure a maximum of 900 provisioned concurrency units for a single function.

Provisioned concurrency

To enable your function to scale without fluctuations in latency, use provisioned concurrency. You can use Application Auto Scaling to automatically adjust provisioned concurrency to maintain a configured target utilization. Provisioned concurrency runs continually and has separate pricing for concurrency and execution duration. [Learn more](#) 

\$0.00 per month in addition to pricing for duration and requests. [Pricing](#) 

 The maximum allowed provisioned concurrency is 900, based on the unreserved concurrency available (1000) minus the minimum unreserved account concurrency (100).

900 available

 Please correct the errors above.

Configuring provisioned concurrency for a function has an impact on the concurrency pool available to other functions. For instance, if you configure 100 units of provisioned concurrency for function-a, other functions in your account must share the remaining 900 units of concurrency. This is true even if function-a doesn't use all 100 units.

It's possible to allocate both reserved concurrency and provisioned concurrency for the same function. In such cases, the provisioned concurrency cannot exceed the reserved concurrency.

This limitation extends to function versions. The maximum provisioned concurrency you can assign to a specific function version is the function's reserved concurrency minus the provisioned concurrency on other function versions.

To configure provisioned concurrency with the Lambda API, use the following API operations.

- [PutProvisionedConcurrencyConfig](#)
- [GetProvisionedConcurrencyConfig](#)
- [ListProvisionedConcurrencyConfigs](#)
- [DeleteProvisionedConcurrencyConfig](#)

For example, to configure provisioned concurrency with the AWS Command Line Interface (CLI), use the `put-provisioned-concurrency-config` command. The following command allocates 100 units of provisioned concurrency for the BLUE alias of a function named `my-function`:

```
aws lambda put-provisioned-concurrency-config --function-name my-function \  
--qualifier BLUE \  

```

```
--provisioned-concurrent-executions 100
```

You should see output that looks like the following:

```
{
  "Requested ProvisionedConcurrentExecutions": 100,
  "Allocated ProvisionedConcurrentExecutions": 0,
  "Status": "IN_PROGRESS",
  "LastModified": "2023-01-21T11:30:00+0000"
}
```

Accurately estimating required provisioned concurrency for a function

You can view any active function's concurrency metrics using [CloudWatch metrics](#). Specifically, the `ConcurrentExecutions` metric shows you the number of concurrent invocations for functions in your account.

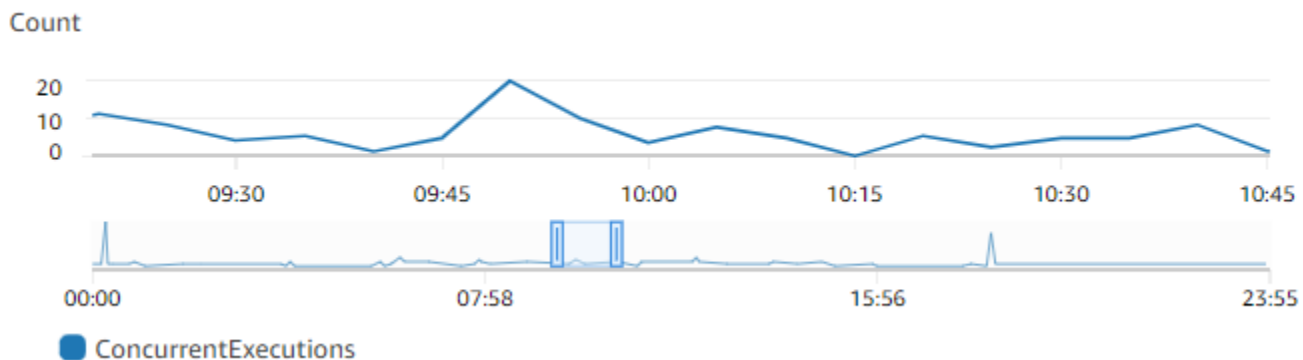

The previous graph suggests that this function serves an average of 5 to 10 concurrent requests at any given time, and peaks at 20 requests. Suppose that there are many other functions in your account. **If this function is critical to your application and you need a low-latency response on every invocation**, configure at least 20 units of provisioned concurrency.

Recall that you can also [calculate concurrency](#) using the following formula:

```
Concurrency = (average requests per second) * (average request duration in seconds)
```

To estimate how much concurrency you need, multiply average requests per second with the average request duration in seconds. You can estimate average requests per second using the `Invocation` metric, and the average request duration in seconds using the `Duration` metric.

When configuring provisioned concurrency, Lambda suggests adding a 10% buffer on top of the amount of concurrency your function typically needs. For example, if your function usually peaks at 200 concurrent requests, set the provisioned concurrency to 220 (200 concurrent requests + 10% = 220 provisioned concurrency).

Optimizing function code when using provisioned concurrency

If you're using provisioned concurrency, consider restructuring your function code to optimize for low latency. For functions using provisioned concurrency, Lambda runs any initialization code, such as loading libraries and instantiating clients, during allocation time. Therefore, it's advisable to move as much initialization outside of the main function handler to avoid impacting latency during actual function invocations. In contrast, initializing libraries or instantiating clients within your main handler code means your function must run this each time it's invoked (this occurs regardless of whether you're using provisioned concurrency).

For on-demand invocations, Lambda may need to rerun your initialization code every time your function experiences a cold start. For such functions, you may choose to defer initialization of a specific capability until your function needs it. For example, consider the following control flow for a Lambda handler:

```
def handler(event, context):
    ...
    if ( some_condition ):
        // Initialize CLIENT_A to perform a task
    else:
        // Do nothing
```

In the previous example, instead of initializing `CLIENT_A` outside of the main handler, the developer initialized it within the `if` statement. By doing this, Lambda runs this code only if `some_condition` is met. If you initialize `CLIENT_A` outside the main handler, Lambda runs that code on every cold start. This can increase overall latency.

Using environment variables to view and control provisioned concurrency behavior

It's possible for your function to use up all of its provisioned concurrency. Lambda uses on-demand instances to handle any excess traffic. To determine the type of initialization Lambda used for a specific environment, check the value of the `AWS_LAMBDA_INITIALIZATION_TYPE` environment

variable. This variable has two possible values: `provisioned-concurrency` or `on-demand`. The value of `AWS_LAMBDA_INITIALIZATION_TYPE` is immutable and remains constant throughout the lifetime of the environment. To check the value of an environment variable in your function code, see [???](#).

If you're using the .NET 8 runtime, you can configure the `AWS_LAMBDA_DOTNET_PREJIT` environment variable to improve the latency for functions, even if they don't use provisioned concurrency. The .NET runtime employs lazy compilation and initialization for each library that your code calls for the first time. As a result, the first invocation of a Lambda function may take longer than subsequent ones. To mitigate this, you can choose one of three values for `AWS_LAMBDA_DOTNET_PREJIT`:

- `ProvisionedConcurrency`: Lambda performs ahead-of-time JIT compilation for all environments using provisioned concurrency. This is the default value.
- `Always`: Lambda performs ahead-of-time JIT compilation for every environment, even if the function doesn't use provisioned concurrency.
- `Never`: Lambda disables ahead-of-time JIT compilation for all environments.

Understanding logging and billing behavior with provisioned concurrency

For provisioned concurrency environments, your function's initialization code runs during allocation, and periodically as Lambda recycles instances of your environment. Lambda bills you for initialization even if the environment instance never processes a request. Provisioned concurrency runs continually and incurs separate billing from initialization and invocation costs. For more details, see [AWS Lambda Pricing](#).

When you configure a Lambda function with provisioned concurrency, Lambda pre-initializes that execution environment so that it's available ahead of invocation requests. Lambda logs the [Init Duration field](#) of the function in a [platform-initReport](#) log event in JSON logging format every time the environment is initialized. To see this log event, configure your [JSON log level](#) to at least INFO. You can also use the [Telemetry API](#) to consume platform events where the Init Duration field is reported.

Using Application Auto Scaling to automate provisioned concurrency management

You can use Application Auto Scaling to manage provisioned concurrency on a schedule or based on utilization. If your function receives predictable traffic patterns, use scheduled scaling. If you want your function to maintain a specific utilization percentage, use a target tracking scaling policy.

Note

If you use Application Auto Scaling to manage your function's provisioned concurrency, ensure that you [configure an initial provisioned concurrency value](#) first. If your function doesn't have an initial provisioned concurrency value, Application Auto Scaling may not handle function scaling properly.

Scheduled scaling

With Application Auto Scaling, you can set your own scaling schedule according to predictable load changes. For more information and examples, see [Scheduled scaling for Application Auto Scaling](#) in the Application Auto Scaling User Guide, and [Scheduling AWS Lambda Provisioned Concurrency for recurring peak usage](#) on the AWS Compute Blog.

Target tracking

With target tracking, Application Auto Scaling creates and manages a set of CloudWatch alarms based on how you define your scaling policy. When these alarms activate, Application Auto Scaling automatically adjusts the amount of environments allocated using provisioned concurrency. Use target tracking for applications that don't have predictable traffic patterns.

To scale provisioned concurrency using target tracking, use the `RegisterScalableTarget` and `PutScalingPolicy` Application Auto Scaling API operations. For example, if you're using the AWS Command Line Interface (CLI), follow these steps:

1. Register a function's alias as a scaling target. The following example registers the BLUE alias of a function named `my-function`:

```
aws application-autoscaling register-scalable-target --service-namespace lambda \
```

```
--resource-id function:my-function:BLUE --min-capacity 1 --max-capacity 100 \  
--scalable-dimension lambda:function:ProvisionedConcurrency
```

2. Apply a scaling policy to the target. The following example configures Application Auto Scaling to adjust the provisioned concurrency configuration for an alias to keep utilization near 70 percent, but you can apply any value between 10% and 90%.

```
aws application-autoscaling put-scaling-policy \  
  --service-namespace lambda \  
  --scalable-dimension lambda:function:ProvisionedConcurrency \  
  --resource-id function:my-function:BLUE \  
  --policy-name my-policy \  
  --policy-type TargetTrackingScaling \  
  --target-tracking-scaling-policy-configuration '{ "TargetValue":  
0.7, "PredefinedMetricSpecification": { "PredefinedMetricType":  
"LambdaProvisionedConcurrencyUtilization" } }'
```

You should see output that looks like this:

```
{  
  "PolicyARN": "arn:aws:autoscaling:us-  
east-2:123456789012:scalingPolicy:12266dbb-1524-xmpl-a64e-9a0a34b996fa:resource/lambda/  
function:my-function:BLUE:policyName/my-policy",  
  "Alarms": [  
    {  
      "AlarmName": "TargetTracking-function:my-function:BLUE-AlarmHigh-aed0e274-  
xmpl-40fe-8cba-2e78f000c0a7",  
      "AlarmARN": "arn:aws:cloudwatch:us-  
east-2:123456789012:alarm:TargetTracking-function:my-function:BLUE-AlarmHigh-aed0e274-  
xmpl-40fe-8cba-2e78f000c0a7"  
    },  
    {  
      "AlarmName": "TargetTracking-function:my-function:BLUE-AlarmLow-7e1a928e-  
xmpl-4d2b-8c01-782321bc6f66",  
      "AlarmARN": "arn:aws:cloudwatch:us-  
east-2:123456789012:alarm:TargetTracking-function:my-function:BLUE-AlarmLow-7e1a928e-  
xmpl-4d2b-8c01-782321bc6f66"  
    }  
  ]  
}
```



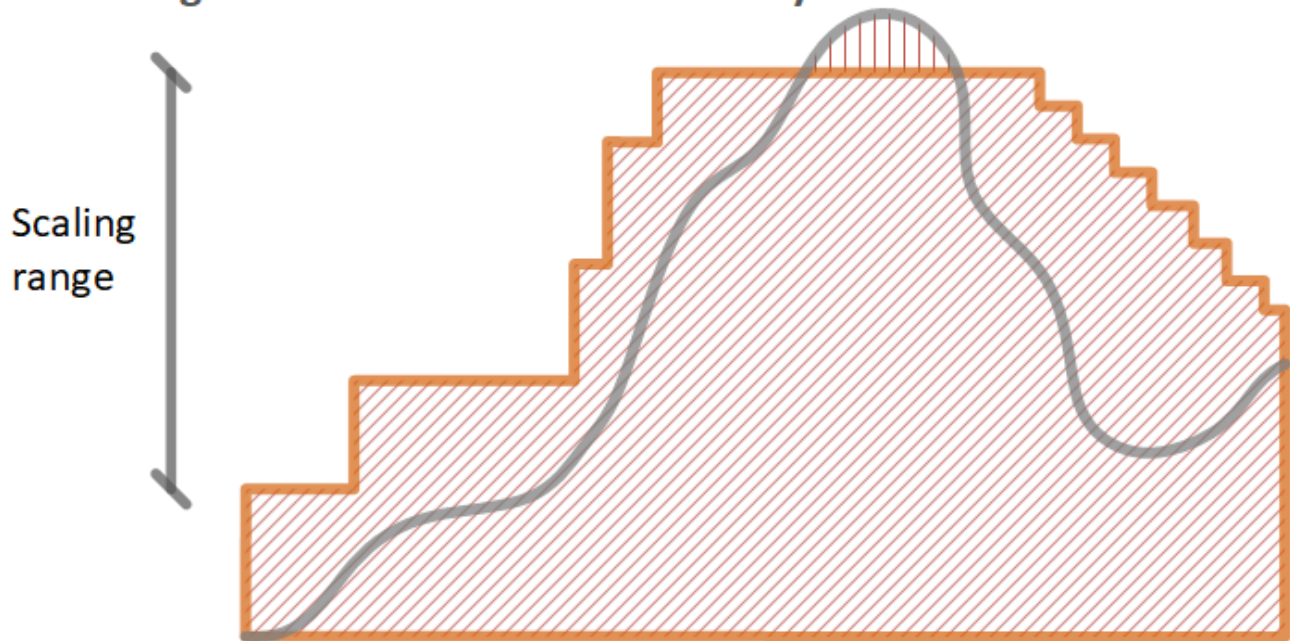

Application Auto Scaling creates two alarms in CloudWatch. The first alarm triggers when the utilization of provisioned concurrency consistently exceeds 70%. When this happens, Application Auto Scaling allocates more provisioned concurrency to reduce utilization. The second alarm triggers when utilization is consistently less than 63% (90 percent of the 70% target). When this happens, Application Auto Scaling reduces the alias's provisioned concurrency.

In the following example, a function scales between a minimum and maximum amount of provisioned concurrency based on utilization.

Autoscaling with Provisioned Concurrency



Legend

-  Function instances
-  Open requests
-  Provisioned concurrency
-  Standard concurrency

When the number of open requests increase, Application Auto Scaling increases provisioned concurrency in large steps until it reaches the configured maximum. After this, the function can continue to scale on standard, unreserved concurrency if you haven't reached your account concurrency limit. When utilization drops and stays low, Application Auto Scaling decreases provisioned concurrency in smaller periodic steps.

Both of the Application Auto Scaling alarms use the average statistic by default. Functions that experience quick bursts of traffic may not trigger these alarms. For example, suppose your Lambda function executes quickly (i.e. 20-100 ms) and your traffic comes in quick bursts. In this case, the number of requests exceeds the allocated provisioned concurrency during the burst. However, Application Auto Scaling requires the burst load to sustain for at least 3 minutes in order to provision additional environments. Additionally, both CloudWatch alarms require 3 data points that hit the target average to activate the auto scaling policy. If your function experiences quick bursts of traffic, using the **Maximum** statistic instead of the **Average** statistic can be more effective at scaling provisioned concurrency to minimize cold starts.

For more information on target tracking scaling policies, see [Target tracking scaling policies for Application Auto Scaling](#).

Lambda scaling behavior

As your function receives more requests, Lambda automatically scales up the number of execution environments to handle these requests until your account reaches its concurrency quota. However, to protect against over-scaling in response to sudden bursts of traffic, Lambda limits how fast your functions can scale. This **concurrency scaling rate** is the maximum rate at which functions in your account can scale in response to increased requests. (That is, how quickly Lambda can create new execution environments.) The concurrency scaling rate differs from the account-level concurrency limit, which is the total amount of concurrency available to your functions.

Concurrency scaling rate

In each AWS Region, and for each function, your concurrency scaling rate is 1,000 execution environment instances every 10 seconds (or 10,000 requests per second every 10 seconds).

In other words, every 10 seconds, Lambda can allocate at most 1,000 additional execution environment instances, or accommodate 10,000 additional requests per second, to each of your functions.

Usually, you don't need to worry about this limitation. Lambda's scaling rate is sufficient for most use cases.

Importantly, the concurrency scaling rate is a function-level limit. This means that each function in your account can scale independently of other functions.

Note

In practice, Lambda makes a best attempt to refill your concurrency scaling rate continuously over time, rather than in one single refill of 1,000 units every 10 seconds.

Lambda doesn't accrue unused portions of your concurrency scaling rate. This means that at any instant in time, your scaling rate is always 1,000 concurrency units at maximum. For example, if you don't use any of your available 1,000 concurrency units in a 10-second interval, you won't accrue 1,000 additional units in the next 10-second interval. Your concurrency scaling rate is still 1,000 in the next 10-second interval.

As long as your function continues to receive increasing numbers of requests, then Lambda scales at the fastest rate available to you, up to your account's concurrency limit. You can limit the

amount of concurrency that individual functions can use by [configuring reserved concurrency](#). If requests come in faster than your function can scale, or if your function is at maximum concurrency, then additional requests fail with a throttling error (429 status code).

Monitoring concurrency

Lambda emits Amazon CloudWatch metrics to help you monitor concurrency for your functions. This topic explains these metrics and how to interpret them.

Sections

- [General concurrency metrics](#)
- [Provisioned concurrency metrics](#)
- [Working with the ClaimedAccountConcurrency metric](#)

General concurrency metrics

Use the following metrics to monitor concurrency for your Lambda functions. The granularity for each metric is 1 minute.

- `ConcurrentExecutions` – The number of active concurrent invocations at a given point in time. Lambda emits this metric for all functions, versions, and aliases. For any function in the Lambda console, Lambda displays the graph for `ConcurrentExecutions` natively in the **Monitoring** tab, under **Metrics**. View this metric using **MAX**.
- `UnreservedConcurrentExecutions` – The number of active concurrent invocations that are using unreserved concurrency. Lambda emits this metric across all functions in a region. View this metric using **MAX**.
- `ClaimedAccountConcurrency` – The amount of concurrency that is unavailable for on-demand invocations. `ClaimedAccountConcurrency` is equal to `UnreservedConcurrentExecutions` plus the amount of allocated concurrency (i.e. the total reserved concurrency plus total provisioned concurrency). If `ClaimedAccountConcurrency` exceeds your account concurrency limit, you can [request a higher account concurrency limit](#). View this metric using **MAX**. For more information, see [Working with the ClaimedAccountConcurrency metric](#).

Provisioned concurrency metrics

Use the following metrics to monitor Lambda functions using provisioned concurrency. The granularity for each metric is 1 minute.

- **ProvisionedConcurrentExecutions** – The number of execution environment instances that are actively processing an invocation on provisioned concurrency. Lambda emits this metric for each function version and alias with provisioned concurrency configured. View this metric using **MAX**.

ProvisionedConcurrentExecutions is not the same as the total number of provisioned concurrency that you allocate. For example, suppose you allocate 100 units of provisioned concurrency to a function version. During any given minute, if at most 50 out of those 100 execution environments were handling invocations simultaneously, then the value of **MAX(ProvisionedConcurrentExecutions)** is 50.

- **ProvisionedConcurrencyInvocations** – The number of times Lambda invokes your function code using provisioned concurrency. Lambda emits this metric for each function version and alias with provisioned concurrency configured. View this metric using **SUM**.

ProvisionedConcurrencyInvocations differs from **ProvisionedConcurrentExecutions** in that **ProvisionedConcurrencyInvocations** counts total number of invocations, while **ProvisionedConcurrentExecutions** counts number of active environments. To understand this distinction, consider the following scenario:



In this example, suppose that you receive 1 invocation per minute, and each invocation takes 2 minutes to complete. Each orange horizontal bar represents a single request. Suppose that you allocate 10 units of provisioned concurrency to this function, such that each request runs on provisioned concurrency.

In between minutes 0 and 1, Request 1 comes in. **At minute 1**, the value for **MAX(ProvisionedConcurrentExecutions)** is 1, since at most 1 execution environment was active during the past minute. The value for **SUM(ProvisionedConcurrencyInvocations)** is also 1, since 1 new request came in during the past minute.

In between minutes 1 and 2, Request 2 comes in, and Request 1 continues to run. **At minute 2**, the value for **MAX(ProvisionedConcurrentExecutions)** is 2, since at most 2 execution environments were active during the past minute. However, the value for **SUM(ProvisionedConcurrencyInvocations)** is 1, since only 1 new request came in during the past minute. This metric behavior continues until the end of the example.

- **ProvisionedConcurrencySpilloverInvocations** – The number of times Lambda invokes your function on standard (reserved or unreserved) concurrency when all provisioned concurrency is in use. Lambda emits this metric for each function version and alias with provisioned concurrency configured. View this metric using **SUM**. The value of **ProvisionedConcurrencyInvocations** + **ProvisionedConcurrencySpilloverInvocations** should be equal to the total number of function invocations (i.e. the **Invocations** metric).

ProvisionedConcurrencyUtilization – The percentage of provisioned concurrency in use (i.e. the value of **ProvisionedConcurrentExecutions** divided by the total amount of provisioned concurrency allocated). Lambda emits this metric for each function version and alias with provisioned concurrency configured. View this metric using **MAX**.

For example, suppose you provision 100 units of provisioned concurrency to a function version. During any given minute, if at most 60 out of those 100 execution environments were handling invocations simultaneously, then the value of **MAX(ProvisionedConcurrentExecutions)** is 60, and the value of **MAX(ProvisionedConcurrencyUtilization)** is 0.6.

A high value for **ProvisionedConcurrencySpilloverInvocations** may indicate that you need to allocate additional provisioned concurrency for your function. Alternatively, you can [configure Application Auto Scaling to handle automatic scaling of provisioned concurrency](#) based on pre-defined thresholds.

Conversely, consistently low values for **ProvisionedConcurrencyUtilization** may indicate that you over-allocated provisioned concurrency for your function.

Working with the ClaimedAccountConcurrency metric

Lambda uses the ClaimedAccountConcurrency metric to determine how much concurrency your account is available for on-demand invocations. Lambda calculates ClaimedAccountConcurrency using the following formula:

$$\text{ClaimedAccountConcurrency} = \text{UnreservedConcurrentExecutions} + (\text{allocated concurrency})$$

UnreservedConcurrentExecutions is the number of active concurrent invocations that are using unreserved concurrency. Allocated concurrency is the sum of the following two parts (substituting RC as "reserved concurrency" and PC as "provisioned concurrency"):

- The total RC across all functions in a Region.
- The total PC across all functions in a Region that use PC, excluding functions that use RC.

Note

You can't allocate more PC than RC for a function. Thus, a function's RC is always greater than or equal to its PC. To calculate the contribution to allocated concurrency for such functions with both PC and RC, Lambda considers only RC, which is the maximum of the two.

Lambda uses the ClaimedAccountConcurrency metric, rather than ConcurrentExecutions, to determine how much concurrency is available for on-demand invocations. While the ConcurrentExecutions metric is useful for tracking the number of active concurrent invocations, it doesn't always reflect your true concurrency availability. This is because Lambda also considers reserved concurrency and provisioned concurrency to determine availability.

To illustrate ClaimedAccountConcurrency, consider a scenario where you configure a lot of reserved concurrency and provisioned concurrency across your functions that go largely unused. In the following example, assume that your account concurrency limit is 1,000, and you have two main functions in your account: function-orange and function-blue. You allocate 600 units of reserved concurrency for function-orange. You allocate 200 units of provisioned concurrency for function-blue. Suppose that over time, you deploy additional functions and observe the following traffic pattern:

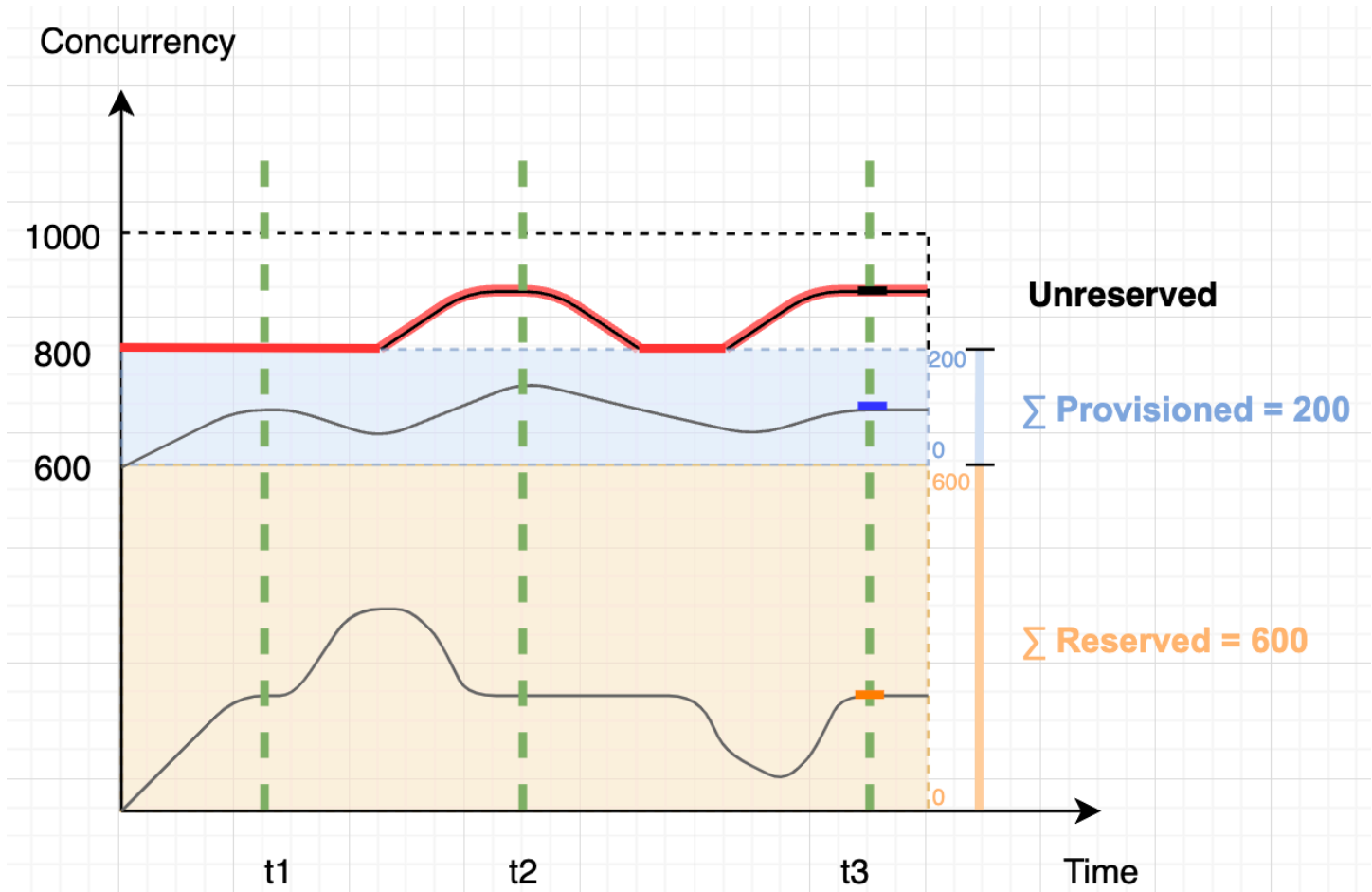

In the previous diagram, the black lines indicate the actual concurrency use over time, and the red line indicates the value of `ClaimedAccountConcurrency` over time. Throughout this scenario, `ClaimedAccountConcurrency` is 800 at minimum, despite low actual concurrency utilization across your functions. This is because you allocated 800 total units of concurrency for function-orange and function-blue. From Lambda's perspective, you have "claimed" this concurrency for use, so you effectively have only 200 units of concurrency remaining for other functions.

For this scenario, allocated concurrency is 800 in the `ClaimedAccountConcurrency` formula. We can then derive the value of `ClaimedAccountConcurrency` at various points in the diagram:

- At t_1 , `ClaimedAccountConcurrency` is 800 ($800 + 0$ `UnreservedConcurrentExecutions`).
- At t_2 , `ClaimedAccountConcurrency` is 900 ($800 + 100$ `UnreservedConcurrentExecutions`).
- At t_3 , `ClaimedAccountConcurrency` is again 900 ($800 + 100$ `UnreservedConcurrentExecutions`).

Setting up the ClaimedAccountConcurrency metric in CloudWatch

Lambda emits the ClaimedAccountConcurrency metric in CloudWatch. Use this metric along with the value of SERVICE_QUOTA(ConcurrentExecutions) to get the percent utilization of concurrency in your account, as shown in the following formula:

$$\text{Utilization} = (\text{ClaimedAccountConcurrency} / \text{SERVICE_QUOTA}(\text{ConcurrentExecutions})) * 100\%$$

The following screenshot illustrates how you can graph this formula in CloudWatch. The green `claim_utilization` line represents the concurrency utilization in this account, which is at around 40%:

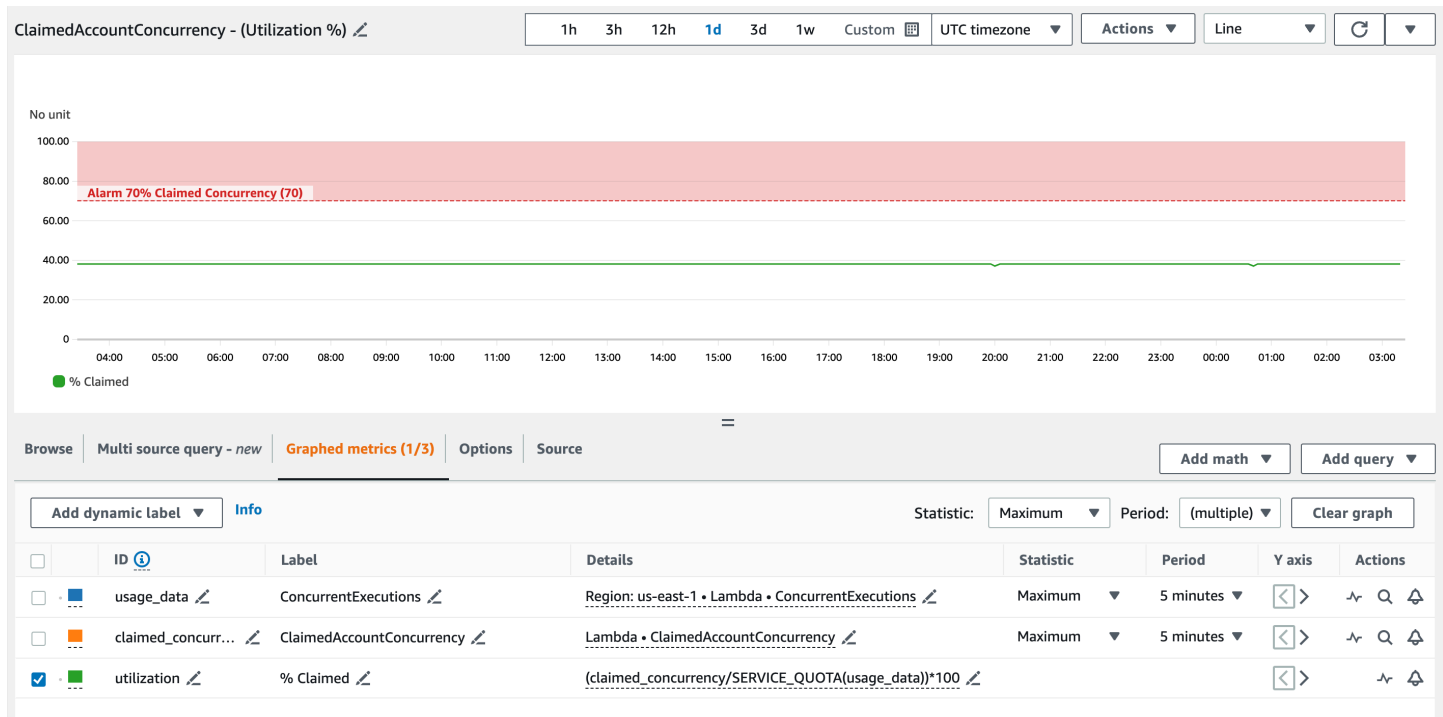

The previous screenshot also includes a CloudWatch alarm that goes into ALARM state when the concurrency utilization exceeds 70%. You can use the ClaimedAccountConcurrency metric along with similar alarms to proactively determine when you might need to request a higher account concurrency limit.

Building Lambda functions with Node.js

You can run JavaScript code with Node.js in AWS Lambda. Lambda provides [runtimes](#) for Node.js that run your code to process events. Your code runs in an environment that includes the AWS SDK for JavaScript, with credentials from an AWS Identity and Access Management (IAM) role that you manage. To learn more about the SDK versions included with the Node.js runtimes, see [the section called “Runtime-included SDK versions”](#).

Lambda supports the following Node.js runtimes.

Name	Identifier	Operating system	Deprecation date	Block function create	Block function update
Node.js 22	nodejs22.x	Amazon Linux 2023	Not scheduled	Not scheduled	Not scheduled
Node.js 20	nodejs20.x	Amazon Linux 2023	Not scheduled	Not scheduled	Not scheduled
Node.js 18	nodejs18.x	Amazon Linux 2	Jul 31, 2025	Sep 1, 2025	Oct 1, 2025

To create a Node.js function

1. Open the [Lambda console](#).
2. Choose **Create function**.
3. Configure the following settings:
 - **Function name:** Enter a name for the function.
 - **Runtime:** Choose **Node.js 22.x**.
4. Choose **Create function**.

The console creates a Lambda function with a single source file named `index.mjs`. You can edit this file and add more files in the built-in code editor. In the **DEPLOY** section, choose **Deploy** to

update your function's code. Then, to run your code, choose **Create test event** in the **TEST EVENTS** section.

The `index.mjs` file exports a function named `handler` that takes an event object and a context object. This is the [handler function](#) that Lambda calls when the function is invoked. The Node.js function runtime gets invocation events from Lambda and passes them to the handler. In the function configuration, the handler value is `index.handler`.

When you save your function code, the Lambda console creates a .zip file archive deployment package. When you develop your function code outside of the console (using an IDE) you need to [create a deployment package](#) to upload your code to the Lambda function.

The function runtime passes a context object to the handler, in addition to the invocation event. The [context object](#) contains additional information about the invocation, the function, and the execution environment. More information is available from environment variables.

Your Lambda function comes with a CloudWatch Logs log group. The function runtime sends details about each invocation to CloudWatch Logs. It relays any [logs that your function outputs](#) during invocation. If your function returns an error, Lambda formats the error and returns it to the invoker.

Topics

- [Node.js initialization](#)
- [Runtime-included SDK versions](#)
- [Using keep-alive for TCP connections](#)
- [CA certificate loading](#)
- [Define Lambda function handler in Node.js](#)
- [Deploy Node.js Lambda functions with .zip file archives](#)
- [Deploy Node.js Lambda functions with container images](#)
- [Working with layers for Node.js Lambda functions](#)
- [Using the Lambda context object to retrieve Node.js function information](#)
- [Log and monitor Node.js Lambda functions](#)
- [Instrumenting Node.js code in AWS Lambda](#)

Node.js initialization

Node.js has a unique event loop model that causes its initialization behavior to be different from other runtimes. Specifically, Node.js uses a non-blocking I/O model that supports asynchronous operations. This model allows Node.js to perform efficiently for most workloads. For example, if a Node.js function makes a network call, that request may be designated as an asynchronous operation and placed into a callback queue. The function may continue to process other operations within the main call stack without getting blocked by waiting for the network call to return. Once the network call is completed, its callback is executed and then removed from the callback queue.

Some initialization tasks may run asynchronously. These asynchronous tasks are not guaranteed to complete execution prior to an invocation. For example, code that makes a network call to fetch a parameter from AWS Parameter Store may not be complete by the time Lambda executes the handler function. As a result, the variable may be null during an invocation. To avoid this, ensure that variables and other asynchronous code are fully initialized before continuing with the rest of the function's core business logic.

Alternatively, you can designate your function code as an ES module, allowing you to use `await` at the top level of the file, outside the scope of your function handler. When you `await` every `Promise`, the asynchronous initialization code completes before handler invocations, maximizing the effectiveness of [provisioned concurrency](#) in reducing cold start latency. For more information and an example, see [Using Node.js ES modules and top-level `await` in AWS Lambda](#).

Designating a function handler as an ES module

By default, Lambda treats files with the `.js` suffix as CommonJS modules. Optionally, you can designate your code as an ES module. You can do this in two ways: specifying the `type` as `module` in the function's `package.json` file, or by using the `.mjs` file name extension. In the first approach, your function code treats all `.js` files as ES modules, while in the second scenario, only the file you specify with `.mjs` is an ES module. You can mix ES modules and CommonJS modules by naming them `.mjs` and `.cjs` respectively, as `.mjs` files are always ES modules and `.cjs` files are always CommonJS modules.

Lambda searches folders in the `NODE_PATH` environment variable when loading ES modules. You can load the AWS SDK that's included in the runtime using ES module `import` statements. You can also load ES modules from [layers](#).

Runtime-included SDK versions

The version of the AWS SDK included in the Node.js runtime depends on the runtime version and your AWS Region. To find the version of the SDK included in the runtime you're using, create a Lambda function with the following code.

Example `index.mjs`

```
import packageJson from '@aws-sdk/client-s3/package.json' with { type: 'json' };

export const handler = async () => ({ version: packageJson.version });
```

This returns a response in the following format:

```
{
  "version": "3.632.0"
}
```

Using keep-alive for TCP connections

The default Node.js HTTP/HTTPS agent creates a new TCP connection for every new request. To avoid the cost of establishing new connections, keep-alive is enabled by default in `nodejs18.x` and later Lambda runtimes. Keep-alive can reduce request times for Lambda functions that make multiple API calls using the SDK.

To disable keep-alive, see [Reusing connections with keep-alive in Node.js](#) in the *AWS SDK for JavaScript 3.x Developer Guide*. For more information about using keep-alive, see [HTTP keep-alive is on by default in modular AWS SDK for JavaScript](#) on the AWS Developer Tools Blog.

CA certificate loading

For Node.js runtime versions up to Node.js 18, Lambda automatically loads Amazon-specific CA (certificate authority) certificates to make it easier for you to create functions that interact with other AWS services. For example, Lambda includes the Amazon RDS certificates necessary for validating the [server identity certificate](#) installed on your Amazon RDS database. This behavior can have a performance impact during cold starts.

Starting with Node.js 20, Lambda no longer loads additional CA certificates by default. The Node.js 20 runtime contains a certificate file with all Amazon CA certificates located at `/var/`

`runtime/ca-cert.pem`. To restore the same behavior from Node.js 18 and earlier runtimes, set the `NODE_EXTRA_CA_CERTS` [environment variable](#) to `/var/runtime/ca-cert.pem`.

For optimal performance, we recommend bundling only the certificates that you need with your deployment package and loading them via the `NODE_EXTRA_CA_CERTS` environment variable. The certificates file should consist of one or more trusted root or intermediate CA certificates in PEM format. For example, for RDS, include the required certificates alongside your code as `certificates/rds.pem`. Then, load the certificates by setting `NODE_EXTRA_CA_CERTS` to `/var/task/certificates/rds.pem`.

Define Lambda function handler in Node.js

The Lambda function *handler* is the method in your function code that processes events. When your function is invoked, Lambda runs the handler method. Your function runs until the handler returns a response, exits, or times out.

Topics

- [Node.js handler basics](#)
- [Naming](#)
- [Using async/await](#)
- [Using callbacks](#)
- [Code best practices for Node.js Lambda functions](#)

Node.js handler basics

The following example function logs the contents of the [event object](#) and returns the location of the logs.

Note

This page shows examples of both CommonJS and ES module handlers. To learn about the difference between these two handler types, see [Designating a function handler as an ES module](#).

ES module handler

Example

```
export const handler = async (event, context) => {
  console.log("EVENT: \n" + JSON.stringify(event, null, 2));
  return context.logStreamName;
};
```

CommonJS module handler

Example

```
exports.handler = async function (event, context) {
  console.log("EVENT: \n" + JSON.stringify(event, null, 2));
  return context.logStreamName;
};
```

When you configure a function, the value of the handler setting is the file name and the name of the exported handler method, separated by a dot. The default in the console and for examples in this guide is `index.handler`. This indicates the `handler` method that's exported from the `index.js` file.

The runtime passes arguments to the handler method. The first argument is the event object, which contains information from the invoker. The invoker passes this information as a JSON-formatted string when it calls [Invoke](#), and the runtime converts it to an object. When an AWS service invokes your function, the event structure [varies by service](#).

The second argument is the [context object](#), which contains information about the invocation, function, and execution environment. In the preceding example, the function gets the name of the [log stream](#) from the context object and returns it to the invoker.

You can also use a callback argument, which is a function that you can call in non-async handlers to send a response. We recommend that you use `async/await` instead of callbacks. `Async/await` provides improved readability, error handling, and efficiency. For more information about the differences between `async/await` and callbacks, see [Using callbacks](#).

Naming

When you configure a function, the value of the handler setting is the file name and the name of the exported handler method, separated by a dot. The default for functions created in the console and for examples in this guide is `index.handler`. This indicates the `handler` method that's exported from the `index.js` or `index.mjs` file.

If you create a function in the console using a different file name or function handler name, you must edit the default handler name.

To change the function handler name (console)

1. Open the [Functions](#) page of the Lambda console and choose your function.
2. Choose the **Code** tab.
3. Scroll down to the **Runtime settings** pane and choose **Edit**.
4. In **Handler**, enter the new name for your function handler.
5. Choose **Save**.

Using async/await

If your code performs an asynchronous task, use the `async/await` pattern to make sure that the handler finishes running. `Async/await` is a concise and readable way to write asynchronous code in Node.js, without the need for nested callbacks or chaining promises. With `async/await`, you can write code that reads like synchronous code, while still being asynchronous and non-blocking.

The `async` keyword marks a function as asynchronous, and the `await` keyword pauses the execution of the function until a `Promise` is resolved.

Note

Make sure to wait for asynchronous events to complete. If the function returns before `async` events are complete, the function might fail or cause unexpected behavior in your application. This can happen when a `forEach` loop contains an `async` event. `forEach` loops expect a synchronous call. For more information, see [Array.prototype.forEach\(\)](#) in the Mozilla documentation.

ES module handler

Example – HTTP request with `async/await`

```
const url = "https://aws.amazon.com/";

export const handler = async(event) => {
  try {
    // fetch is available in Node.js 18 and later runtimes
    const res = await fetch(url);
    console.info("status", res.status);
    return res.status;
  }
}
```

```
    }  
    catch (e) {  
      console.error(e);  
      return 500;  
    }  
  };  
};
```

CommonJS module handler

Example – HTTP request with async/await

```
const https = require("https");  
let url = "https://aws.amazon.com/";  
  
exports.handler = async function (event) {  
  let statusCode;  
  await new Promise(function (resolve, reject) {  
    https.get(url, (res) => {  
      statusCode = res.statusCode;  
      resolve(statusCode);  
    }).on("error", (e) => {  
      reject(Error(e));  
    });  
  });  
  console.log(statusCode);  
  return statusCode;  
};
```

The next example uses `async/await` to list your Amazon Simple Storage Service buckets.

Note

Before using this example, make sure that your function's execution role has Amazon S3 read permissions.

ES module handler

Example – AWS SDK v3 with async/await

This example uses the [AWS SDK for JavaScript v3](#), which is available in `node.js 18.x` and later runtimes.

```
import {S3Client, ListBucketsCommand} from '@aws-sdk/client-s3';
const s3 = new S3Client({region: 'us-east-1'});

export const handler = async(event) => {
  const data = await s3.send(new ListBucketsCommand({}));
  return data.Buckets;
};
```

CommonJS module handler

Example – AWS SDK v3 with async/await

This example uses the [AWS SDK for JavaScript v3](#), which is available in nodejs18.x and later runtimes.

```
const { S3Client, ListBucketsCommand } = require('@aws-sdk/client-s3');
const s3 = new S3Client({ region: 'us-east-1' });

exports.handler = async (event) => {
  const data = await s3.send(new ListBucketsCommand({}));
  return data.Buckets;
};
```

Using callbacks

We recommend that you use [async/await](#) to declare the function handler instead of using callbacks. Async/await is a better choice for several reasons:

- **Readability:** Async/await code is easier to read and understand than callback code, which can quickly become difficult to follow and result in callback hell.
- **Debugging and error handling:** Debugging callback-based code can be difficult. The call stack can become hard to follow and errors can easily be swallowed. With async/await, you can use try/catch blocks to handle errors.
- **Efficiency:** Callbacks often require switching between different parts of the code. Async/await can reduce the number of context switches, resulting in more efficient code.

When you use callbacks in your handler, the function continues to execute until the [event loop](#) is empty or the function times out. The response isn't sent to the invoker until all event loop tasks are

finished. If the function times out, an error is returned instead. You can configure the runtime to send the response immediately by setting [context.callbackWaitsForEmptyEventLoop](#) to false.

The callback function takes two arguments: an `Error` and a response. The response object must be compatible with `JSON.stringify`.

The following example function checks a URL and returns the status code to the invoker.

ES module handler

Example – HTTP request with callback

```
import https from "https";
let url = "https://aws.amazon.com/";

export function handler(event, context, callback) {
  https.get(url, (res) => {
    callback(null, res.statusCode);
  }).on("error", (e) => {
    callback(Error(e));
  });
}
```

CommonJS module handler

Example – HTTP request with callback

```
const https = require("https");
let url = "https://aws.amazon.com/";

exports.handler = function (event, context, callback) {
  https.get(url, (res) => {
    callback(null, res.statusCode);
  }).on("error", (e) => {
    callback(Error(e));
  });
};
```

In the next example, the response from Amazon S3 is returned to the invoker as soon as it's available. The timeout running on the event loop is frozen, and it continues running the next time the function is invoked.

Note

Before using this example, make sure that your function's execution role has Amazon S3 read permissions.

ES module handler

Example – AWS SDK v3 with `callbackWaitsForEmptyEventLoop`

This example uses the [AWS SDK for JavaScript v3](#), which is available in `nodejs18.x` and later runtimes.

```
import AWS from "@aws-sdk/client-s3";
const s3 = new AWS.S3({});

export const handler = function (event, context, callback) {
  context.callbackWaitsForEmptyEventLoop = false;
  s3.listBuckets({}, callback);
  setTimeout(function () {
    console.log("Timeout complete.");
  }, 5000);
};
```

CommonJS module handler

Example – AWS SDK v3 with `callbackWaitsForEmptyEventLoop`

This example uses the [AWS SDK for JavaScript v3](#), which is available in `nodejs18.x` and later runtimes.

```
const AWS = require("@aws-sdk/client-s3");
const s3 = new AWS.S3({});

exports.handler = function (event, context, callback) {
  context.callbackWaitsForEmptyEventLoop = false;
  s3.listBuckets({}, callback);
  setTimeout(function () {
    console.log("Timeout complete.");
  }, 5000);
};
```

```
};
```

Code best practices for Node.js Lambda functions

Adhere to the guidelines in the following list to use best coding practices when building your Lambda functions:

- **Separate the Lambda handler from your core logic.** This allows you to make a more unit-testable function. In Node.js this may look like:

```
exports.myHandler = function(event, context, callback) {
  var foo = event.foo;
  var bar = event.bar;
  var result = MyLambdaFunction (foo, bar);

  callback(null, result);
}

function MyLambdaFunction (foo, bar) {
  // MyLambdaFunction logic here
}
```

- **Control the dependencies in your function's deployment package.** The AWS Lambda execution environment contains a number of libraries. For the Node.js and Python runtimes, these include the AWS SDKs. To enable the latest set of features and security updates, Lambda will periodically update these libraries. These updates may introduce subtle changes to the behavior of your Lambda function. To have full control of the dependencies your function uses, package all of your dependencies with your deployment package.
- **Minimize the complexity of your dependencies.** Prefer simpler frameworks that load quickly on [execution environment](#) startup.
- **Minimize your deployment package size to its runtime necessities.** This will reduce the amount of time that it takes for your deployment package to be downloaded and unpacked ahead of invocation.
- **Take advantage of execution environment reuse to improve the performance of your function.** Initialize SDK clients and database connections outside of the function handler, and cache static assets locally in the `/tmp` directory. Subsequent invocations processed by the same

instance of your function can reuse these resources. This saves cost by reducing function run time.

To avoid potential data leaks across invocations, don't use the execution environment to store user data, events, or other information with security implications. If your function relies on a mutable state that can't be stored in memory within the handler, consider creating a separate function or separate versions of a function for each user.

- **Use a keep-alive directive to maintain persistent connections.** Lambda purges idle connections over time. Attempting to reuse an idle connection when invoking a function will result in a connection error. To maintain your persistent connection, use the keep-alive directive associated with your runtime. For an example, see [Reusing Connections with Keep-Alive in Node.js](#).
- **Use [environment variables](#) to pass operational parameters to your function.** For example, if you are writing to an Amazon S3 bucket, instead of hard-coding the bucket name you are writing to, configure the bucket name as an environment variable.
- **Avoid using recursive invocations** in your Lambda function, where the function invokes itself or initiates a process that may invoke the function again. This could lead to unintended volume of function invocations and escalated costs. If you see an unintended volume of invocations, set the function reserved concurrency to 0 immediately to throttle all invocations to the function, while you update the code.
- **Do not use non-documented, non-public APIs** in your Lambda function code. For AWS Lambda managed runtimes, Lambda periodically applies security and functional updates to Lambda's internal APIs. These internal API updates may be backwards-incompatible, leading to unintended consequences such as invocation failures if your function has a dependency on these non-public APIs. See [the API reference](#) for a list of publicly available APIs.
- **Write idempotent code.** Writing idempotent code for your functions ensures that duplicate events are handled the same way. Your code should properly validate events and gracefully handle duplicate events. For more information, see [How do I make my Lambda function idempotent?](#).

Deploy Node.js Lambda functions with .zip file archives

Your AWS Lambda function's code comprises a .js or .mjs file containing your function's handler code, together with any additional packages and modules your code depends on. To deploy this function code to Lambda, you use a *deployment package*. This package may either be a .zip file archive or a container image. For more information about using container images with Node.js, see [Deploy Node.js Lambda functions with container images](#).

To create your deployment package as .zip file archive, you can use your command-line tool's built-in .zip file archive utility, or any other .zip file utility such as [7zip](#). The examples shown in the following sections assume you're using a command-line zip tool in a Linux or MacOS environment. To use the same commands in Windows, you can [install the Windows Subsystem for Linux](#) to get a Windows-integrated version of Ubuntu and Bash.

Note that Lambda uses POSIX file permissions, so you may need to [set permissions for the deployment package folder](#) before you create the .zip file archive.

Topics

- [Runtime dependencies in Node.js](#)
- [Creating a .zip deployment package with no dependencies](#)
- [Creating a .zip deployment package with dependencies](#)
- [Creating a Node.js layer for your dependencies](#)
- [Dependency search path and runtime-included libraries](#)
- [Creating and updating Node.js Lambda functions using .zip files](#)

Runtime dependencies in Node.js

For Lambda functions that use the Node.js runtime, a dependency can be any Node.js module. The Node.js runtime includes a number of common libraries, as well as a version of the AWS SDK for JavaScript. The nodejs16.x Lambda runtime includes version 2.x of the SDK. Runtime versions nodejs18.x and later include version 3 of the SDK. To use version 2 of the SDK with runtime versions nodejs18.x and later, add the SDK to your .zip file deployment package. If your chosen runtime includes the version of the SDK you are using, you don't need to include the SDK library in your .zip file. To find out which version of the SDK is included in the runtime you're using, see [the section called "Runtime-included SDK versions"](#).

Lambda periodically updates the SDK libraries in the Node.js runtime to include the latest features and security upgrades. Lambda also applies security patches and updates to the other libraries included in the runtime. To have full control of the dependencies in your package, you can add your preferred version of any runtime-included dependency to your deployment package. For example, if you want to use a particular version of the SDK for JavaScript, you can include it in your .zip file as a dependency. For more information on adding runtime-included dependencies to your .zip file, see [Dependency search path and runtime-included libraries](#).

Under the [AWS shared responsibility model](#), you are responsible for the management of any dependencies in your functions' deployment packages. This includes applying updates and security patches. To update dependencies in your function's deployment package, first create a new .zip file and then upload it to Lambda. See [Creating a .zip deployment package with dependencies](#) and [Creating and updating Node.js Lambda functions using .zip files](#) for more information.

Creating a .zip deployment package with no dependencies

If your function code has no dependencies except for libraries included in the Lambda runtime, your .zip file contains only the `index.js` or `index.mjs` file with your function's handler code. Use your preferred zip utility to create a .zip file with your `index.js` or `index.mjs` file at the root. If the file containing your handler code isn't at the root of your .zip file, Lambda won't be able to run your code.

To learn how to deploy your .zip file to create a new Lambda function or update an existing one, see [Creating and updating Node.js Lambda functions using .zip files](#).

Creating a .zip deployment package with dependencies

If your function code depends on packages or modules that aren't included in the Lambda Node.js runtime, you can either add these dependencies to your .zip file with your function code or use a [Lambda layer](#). The instructions in this section show you how to include your dependencies in your .zip deployment package. For instructions on how to include your dependencies in a layer, see [the section called "Creating a Node.js layer for your dependencies"](#).

The following example CLI commands create a .zip file named `my_deployment_package.zip` containing the `index.js` or `index.mjs` file with your function's handler code and its dependencies. In the example, you install dependencies using the npm package manager.

To create the deployment package

1. Navigate to the project directory containing your `index.js` or `index.mjs` source code file. In this example, the directory is named `my_function`.

```
cd my_function
```

2. Install your function's required libraries in the `node_modules` directory using the `npm install` command. In this example you install the AWS X-Ray SDK for Node.js.

```
npm install aws-xray-sdk
```

This creates a folder structure similar to the following:

```
~/my_function
### index.mjs
### node_modules
    ### async
    ### async-listener
    ### atomic-batcher
    ### aws-sdk
    ### aws-xray-sdk
    ### aws-xray-sdk-core
```

You can also add custom modules that you create yourself to your deployment package. Create a directory under `node_modules` with the name of your module and save your custom written packages there.

3. Create a `.zip` file that contains the contents of your project folder at the root. Use the `r` (recursive) option to ensure that zip compresses the subfolders.

```
zip -r my_deployment_package.zip .
```

Creating a Node.js layer for your dependencies

The instructions in this section show you how to include your dependencies in a layer. For instructions on how to include your dependencies in your deployment package, see [the section called "Creating a .zip deployment package with dependencies"](#).

When you add a layer to a function, Lambda loads the layer content into the `/opt` directory of that execution environment. For each Lambda runtime, the `PATH` variable already includes specific folder paths within the `/opt` directory. To ensure that Lambda picks up your layer content, your layer `.zip` file should have its dependencies in the following folder paths:

- `nodejs/node_modules`
- `nodejs/node16/node_modules` (`NODE_PATH`)
- `nodejs/node18/node_modules` (`NODE_PATH`)
- `nodejs/node20/node_modules` (`NODE_PATH`)

For example, your layer `.zip` file structure might look like the following:

```
xray-sdk.zip
# nodejs/node_modules/aws-xray-sdk
```

In addition, Lambda automatically detects any libraries in the `/opt/lib` directory, and any binaries in the `/opt/bin` directory. To ensure that Lambda properly finds your layer content, you can also create a layer with the following structure:

```
custom-layer.zip
# lib
  | lib_1
  | lib_2
# bin
  | bin_1
  | bin_2
```

After you package your layer, see [the section called “Creating and deleting layers”](#) and [the section called “Adding layers”](#) to complete your layer setup.

Dependency search path and runtime-included libraries

The Node.js runtime includes a number of common libraries, as well as a version of the AWS SDK for JavaScript. If you want to use a different version of a runtime-included library, you can do this by bundling it with your function or by adding it as a dependency in your deployment package. For example, you can use a different version of the SDK by adding it to your `.zip` deployment package. You can also include it in a [Lambda layer](#) for your function.

When you use an `import` or `require` statement in your code, the Node.js runtime searches the directories in the `NODE_PATH` path until it finds the module. By default, the first location the runtime searches is the directory into which your `.zip` deployment package is decompressed and mounted (`/var/task`). If you include a version of a runtime-included library in your deployment package, this version will take precedence over the version included in the runtime. Dependencies in your deployment package also have precedence over dependencies in layers.

When you add a dependency to a layer, Lambda extracts this to `/opt/nodejs/nodexx/node_modules` where `nodexx` represents the version of the runtime you are using. In the search path, this directory has precedence over the directory containing the runtime-included libraries (`/var/lang/lib/node_modules`). Libraries in function layers therefore have precedence over versions included in the runtime.

You can see the full search path for your Lambda function by adding the following line of code.

```
console.log(process.env.NODE_PATH)
```

You can also add dependencies in a separate folder inside your `.zip` package. For example, you might add a custom module to a folder in your `.zip` package called `common`. When your `.zip` package is decompressed and mounted, this folder is placed inside the `/var/task` directory. To use a dependency from a folder in your `.zip` deployment package in your code, use an `import { } from` or `const { } = require()` statement, depending on whether you are using CJS or ESM module resolution. For example:

```
import { myModule } from './common'
```

If you bundle your code with `esbuild`, `rollup`, or similar, the dependencies used by your function are bundled together in one or more files. We recommend using this method to vend dependencies whenever possible. Compared to adding dependencies to your deployment package, bundling your code results in improved performance due to the reduction in I/O operations.

Creating and updating Node.js Lambda functions using `.zip` files

After you have created your `.zip` deployment package, you can use it to create a new Lambda function or update an existing one. You can deploy your `.zip` package using the Lambda console, the AWS Command Line Interface, and the Lambda API. You can also create and update Lambda functions using AWS Serverless Application Model (AWS SAM) and AWS CloudFormation.

The maximum size for a .zip deployment package for Lambda is 250 MB (unzipped). Note that this limit applies to the combined size of all the files you upload, including any Lambda layers.

The Lambda runtime needs permission to read the files in your deployment package. In Linux permissions octal notation, Lambda needs 644 permissions for non-executable files (rw-r--r--) and 755 permissions (rwxr-xr-x) for directories and executable files.

In Linux and MacOS, use the `chmod` command to change file permissions on files and directories in your deployment package. For example, to give a non-executable file the correct permissions, run the following command.

```
chmod 644 <filepath>
```

To change file permissions in Windows, see [Set, View, Change, or Remove Permissions on an Object](#) in the Microsoft Windows documentation.

Note

If you don't grant Lambda the permissions it needs to access directories in your deployment package, Lambda sets the permissions for those directories to 755 (rwxr-xr-x).

Creating and updating functions with .zip files using the console

To create a new function, you must first create the function in the console, then upload your .zip archive. To update an existing function, open the page for your function, then follow the same procedure to add your updated .zip file.

If your .zip file is less than 50MB, you can create or update a function by uploading the file directly from your local machine. For .zip files greater than 50MB, you must upload your package to an Amazon S3 bucket first. For instructions on how to upload a file to an Amazon S3 bucket using the AWS Management Console, see [Getting started with Amazon S3](#). To upload files using the AWS CLI, see [Move objects](#) in the *AWS CLI User Guide*.

Note

You cannot change the [deployment package type](#) (.zip or container image) for an existing function. For example, you cannot convert a container image function to use a .zip file archive. You must create a new function.

To create a new function (console)

1. Open the [Functions page](#) of the Lambda console and choose **Create Function**.
2. Choose **Author from scratch**.
3. Under **Basic information**, do the following:
 - a. For **Function name**, enter the name for your function.
 - b. For **Runtime**, select the runtime you want to use.
 - c. (Optional) For **Architecture**, choose the instruction set architecture for your function. The default architecture is x86_64. Ensure that the .zip deployment package for your function is compatible with the instruction set architecture you select.
4. (Optional) Under **Permissions**, expand **Change default execution role**. You can create a new **Execution role** or use an existing one.
5. Choose **Create function**. Lambda creates a basic 'Hello world' function using your chosen runtime.

To upload a .zip archive from your local machine (console)

1. In the [Functions page](#) of the Lambda console, choose the function you want to upload the .zip file for.
2. Select the **Code** tab.
3. In the **Code source** pane, choose **Upload from**.
4. Choose **.zip file**.
5. To upload the .zip file, do the following:
 - a. Select **Upload**, then select your .zip file in the file chooser.
 - b. Choose **Open**.
 - c. Choose **Save**.

To upload a .zip archive from an Amazon S3 bucket (console)

1. In the [Functions page](#) of the Lambda console, choose the function you want to upload a new .zip file for.
2. Select the **Code** tab.
3. In the **Code source** pane, choose **Upload from**.

4. Choose **Amazon S3 location**.
5. Paste the Amazon S3 link URL of your .zip file and choose **Save**.

Updating .zip file functions using the console code editor

For some functions with .zip deployment packages, you can use the Lambda console's built-in code editor to update your function code directly. To use this feature, your function must meet the following criteria:

- Your function must use one of the interpreted language runtimes (Python, Node.js, or Ruby)
- Your function's deployment package must be smaller than 50 MB (unzipped).

Function code for functions with container image deployment packages cannot be edited directly in the console.

To update function code using the console code editor

1. Open the [Functions page](#) of the Lambda console and select your function.
2. Select the **Code** tab.
3. In the **Code source** pane, select your source code file and edit it in the integrated code editor.
4. In the **DEPLOY** section, choose **Deploy** to update your function's code:

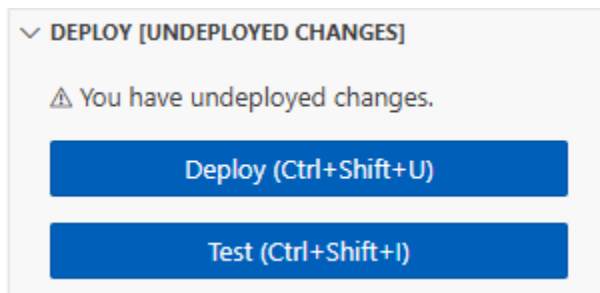

Creating and updating functions with .zip files using the AWS CLI

You can use the [AWS CLI](#) to create a new function or to update an existing one using a .zip file. Use the [create-function](#) and [update-function-code](#) commands to deploy your .zip package. If your .zip file is smaller than 50MB, you can upload the .zip package from a file location on your local build machine. For larger files, you must upload your .zip package from an Amazon S3 bucket. For instructions on how to upload a file to an Amazon S3 bucket using the AWS CLI, see [Move objects](#) in the *AWS CLI User Guide*.

Note

If you upload your .zip file from an Amazon S3 bucket using the AWS CLI, the bucket must be located in the same AWS Region as your function.

To create a new function using a .zip file with the AWS CLI, you must specify the following:

- The name of your function (`--function-name`)
- Your function's runtime (`--runtime`)
- The Amazon Resource Name (ARN) of your function's [execution role](#) (`--role`)
- The name of the handler method in your function code (`--handler`)

You must also specify the location of your .zip file. If your .zip file is located in a folder on your local build machine, use the `--zip-file` option to specify the file path, as shown in the following example command.

```
aws lambda create-function --function-name myFunction \  
--runtime nodejs22.x --handler index.handler \  
--role arn:aws:iam::111122223333:role/service-role/my-lambda-role \  
--zip-file fileb://myFunction.zip
```

To specify the location of .zip file in an Amazon S3 bucket, use the `--code` option as shown in the following example command. You only need to use the `S3ObjectVersion` parameter for versioned objects.

```
aws lambda create-function --function-name myFunction \  
--runtime nodejs22.x --handler index.handler \  
--role arn:aws:iam::111122223333:role/service-role/my-lambda-role \  
--code S3Bucket=amzn-s3-demo-  
bucket,S3Key=myFileName.zip,S3ObjectVersion=myObjectVersion
```

To update an existing function using the CLI, you specify the the name of your function using the `--function-name` parameter. You must also specify the location of the .zip file you want to use to update your function code. If your .zip file is located in a folder on your local build machine, use the `--zip-file` option to specify the file path, as shown in the following example command.

```
aws lambda update-function-code --function-name myFunction \  
--zip-file fileb://myFunction.zip
```



```
--zip-file fileb://myFunction.zip
```

To specify the location of .zip file in an Amazon S3 bucket, use the `--s3-bucket` and `--s3-key` options as shown in the following example command. You only need to use the `--s3-object-version` parameter for versioned objects.

```
aws lambda update-function-code --function-name myFunction \  
--s3-bucket amzn-s3-demo-bucket --s3-key myFileName.zip --s3-object-version myObject  
Version
```

Creating and updating functions with .zip files using the Lambda API

To create and update functions using a .zip file archive, use the following API operations:

- [CreateFunction](#)
- [UpdateFunctionCode](#)

Creating and updating functions with .zip files using AWS SAM

The AWS Serverless Application Model (AWS SAM) is a toolkit that helps streamline the process of building and running serverless applications on AWS. You define the resources for your application in a YAML or JSON template and use the AWS SAM command line interface (AWS SAM CLI) to build, package, and deploy your applications. When you build a Lambda function from an AWS SAM template, AWS SAM automatically creates a .zip deployment package or container image with your function code and any dependencies you specify. To learn more about using AWS SAM to build and deploy Lambda functions, see [Getting started with AWS SAM](#) in the *AWS Serverless Application Model Developer Guide*.

You can also use AWS SAM to create a Lambda function using an existing .zip file archive. To create a Lambda function using AWS SAM, you can save your .zip file in an Amazon S3 bucket or in a local folder on your build machine. For instructions on how to upload a file to an Amazon S3 bucket using the AWS CLI, see [Move objects](#) in the *AWS CLI User Guide*.

In your AWS SAM template, the `AWS::Serverless::Function` resource specifies your Lambda function. In this resource, set the following properties to create a function using a .zip file archive:

- `PackageType` - set to `Zip`
- `CodeUri` - set to the function code's Amazon S3 URI, path to local folder, or [FunctionCode](#) object
- `Runtime` - Set to your chosen runtime

With AWS SAM, if your .zip file is larger than 50MB, you don't need to upload it to an Amazon S3 bucket first. AWS SAM can upload .zip packages up to the maximum allowed size of 250MB (unzipped) from a location on your local build machine.

To learn more about deploying functions using .zip file in AWS SAM, see [AWS::Serverless::Function](#) in the *AWS SAM Developer Guide*.

Creating and updating functions with .zip files using AWS CloudFormation

You can use AWS CloudFormation to create a Lambda function using a .zip file archive. To create a Lambda function from a .zip file, you must first upload your file to an Amazon S3 bucket. For instructions on how to upload a file to an Amazon S3 bucket using the AWS CLI, see [Move objects](#) in the *AWS CLI User Guide*.

In your AWS CloudFormation template, the `AWS::Lambda::Function` resource specifies your Lambda function. In this resource, set the following properties to create a function using a .zip file archive:

- `PackageType` - Set to `Zip`
- `Code` - Enter the Amazon S3 bucket name and the .zip file name in the `S3Bucket` and `S3Key` fields
- `Runtime` - Set to your chosen runtime

The .zip file that AWS CloudFormation generates cannot exceed 4MB. To learn more about deploying functions using .zip file in AWS CloudFormation, see [AWS::Lambda::Function](#) in the *AWS CloudFormation User Guide*.

Deploy Node.js Lambda functions with container images

There are three ways to build a container image for a Node.js Lambda function:

- [Using an AWS base image for Node.js](#)

The [AWS base images](#) are preloaded with a language runtime, a runtime interface client to manage the interaction between Lambda and your function code, and a runtime interface emulator for local testing.

- [Using an AWS OS-only base image](#)

[AWS OS-only base images](#) contain an Amazon Linux distribution and the [runtime interface emulator](#). These images are commonly used to create container images for compiled languages, such as [Go](#) and [Rust](#), and for a language or language version that Lambda doesn't provide a base image for, such as Node.js 19. You can also use OS-only base images to implement a [custom runtime](#). To make the image compatible with Lambda, you must include the [runtime interface client for Node.js](#) in the image.

- [Using a non-AWS base image](#)

You can use an alternative base image from another container registry, such as Alpine Linux or Debian. You can also use a custom image created by your organization. To make the image compatible with Lambda, you must include the [runtime interface client for Node.js](#) in the image.

Tip

To reduce the time it takes for Lambda container functions to become active, see [Use multi-stage builds](#) in the Docker documentation. To build efficient container images, follow the [Best practices for writing Dockerfiles](#).

This page explains how to build, test, and deploy container images for Lambda.

Topics

- [AWS base images for Node.js](#)
- [Using an AWS base image for Node.js](#)
- [Using an alternative base image with the runtime interface client](#)

AWS base images for Node.js

AWS provides the following base images for Node.js:

Tags	Runtime	Operating system	Dockerfile	Deprecation
22	Node.js 22	Amazon Linux 2023	Dockerfile for Node.js 22 on GitHub	Not scheduled
20	Node.js 20	Amazon Linux 2023	Dockerfile for Node.js 20 on GitHub	Not scheduled
18	Node.js 18	Amazon Linux 2	Dockerfile for Node.js 18 on GitHub	Jul 31, 2025

Amazon ECR repository: gallery.ecr.aws/lambda/nodejs

The Node.js 22 and later base images are based on the [Amazon Linux 2023 minimal container image](#). Earlier base images use Amazon Linux 2. AL2023 provides several advantages over Amazon Linux 2, including a smaller deployment footprint and updated versions of libraries such as `glibc`.

AL2023-based images use `microdnf` (symlinked as `dnf`) as the package manager instead of `yum`, which is the default package manager in Amazon Linux 2. `microdnf` is a standalone implementation of `dnf`. For a list of packages that are included in AL2023-based images, refer to the **Minimal Container** columns in [Comparing packages installed on Amazon Linux 2023 Container Images](#). For more information about the differences between AL2023 and Amazon Linux 2, see [Introducing the Amazon Linux 2023 runtime for AWS Lambda](#) on the AWS Compute Blog.

Note

To run AL2023-based images locally, including with AWS Serverless Application Model (AWS SAM), you must use Docker version 20.10.10 or later.

Using an AWS base image for Node.js

Prerequisites

To complete the steps in this section, you must have the following:

- [AWS CLI version 2](#)
- [Docker](#) (minimum version 20.10.10 for Node.js 22 and later base images)
- Node.js

Creating an image from a base image

To create a container image from an AWS base image for Node.js

1. Create a directory for the project, and then switch to that directory.

```
mkdir example
cd example
```

2. Create a new Node.js project with npm. To accept the default options provided in the interactive experience, press Enter.

```
npm init
```

3. Create a new file called `index.js`. You can add the following sample function code to the file for testing, or use your own.

```
exports.handler = async (event) => {
  const response = {
    statusCode: 200,
    body: JSON.stringify('Hello from Lambda!'),
  };
  return response;
};
```

4. If your function depends on libraries other than the AWS SDK for JavaScript, use [npm](#) to add them to your package.
5. Create a new Dockerfile with the following configuration:

- Set the FROM property to the [URI of the base image](#).
- Use the COPY command to copy the function code and runtime dependencies to `{LAMBDA_TASK_ROOT}`, a [Lambda-defined environment variable](#).
- Set the CMD argument to the Lambda function handler.

Note that the example Dockerfile does not include a [USER instruction](#). When you deploy a container image to Lambda, Lambda automatically defines a default Linux user with least-privileged permissions. This is different from standard Docker behavior which defaults to the root user when no USER instruction is provided.

Example Dockerfile

```
FROM public.ecr.aws/lambda/nodejs:22

# Copy function code
COPY index.js ${LAMBDA_TASK_ROOT}

# Set the CMD to your handler (could also be done as a parameter override outside
of the Dockerfile)
CMD [ "index.handler" ]
```

6. Build the Docker image with the [docker build](#) command. The following example names the image `docker-image` and gives it the test [tag](#).

```
docker build --platform linux/amd64 -t docker-image:test .
```

Note

The command specifies the `--platform linux/amd64` option to ensure that your container is compatible with the Lambda execution environment regardless of the architecture of your build machine. If you intend to create a Lambda function using the ARM64 instruction set architecture, be sure to change the command to use the `--platform linux/arm64` option instead.

(Optional) Test the image locally

1. Start the Docker image with the **docker run** command. In this example, `docker-image` is the image name and `test` is the tag.

```
docker run --platform linux/amd64 -p 9000:8080 docker-image:test
```

This command runs the image as a container and creates a local endpoint at `localhost:9000/2015-03-31/functions/function/invocations`.

Note

If you built the Docker image for the ARM64 instruction set architecture, be sure to use the `--platform linux/arm64` option instead of `--platform linux/amd64`.

2. From a new terminal window, post an event to the local endpoint.

Linux/macOS

In Linux and macOS, run the following `curl` command:

```
curl "http://localhost:9000/2015-03-31/functions/function/invocations" -d '{}'
```

This command invokes the function with an empty event and returns a response. If you're using your own function code rather than the sample function code, you might want to invoke the function with a JSON payload. Example:

```
curl "http://localhost:9000/2015-03-31/functions/function/invocations" -d  
'{"payload":"hello world!"}'
```

PowerShell

In PowerShell, run the following `Invoke-WebRequest` command:

```
Invoke-WebRequest -Uri "http://localhost:9000/2015-03-31/functions/function/  
invocations" -Method Post -Body '{}' -ContentType "application/json"
```

This command invokes the function with an empty event and returns a response. If you're using your own function code rather than the sample function code, you might want to invoke the function with a JSON payload. Example:

```
Invoke-WebRequest -Uri "http://localhost:9000/2015-03-31/functions/function/invocations" -Method Post -Body '{"payload":"hello world!"}' -ContentType "application/json"
```

3. Get the container ID.

```
docker ps
```

4. Use the [docker kill](#) command to stop the container. In this command, replace 3766c4ab331c with the container ID from the previous step.

```
docker kill 3766c4ab331c
```

Deploying the image

To upload the image to Amazon ECR and create the Lambda function

1. Run the [get-login-password](#) command to authenticate the Docker CLI to your Amazon ECR registry.
 - Set the `--region` value to the AWS Region where you want to create the Amazon ECR repository.
 - Replace 111122223333 with your AWS account ID.

```
aws ecr get-login-password --region us-east-1 | docker login --username AWS --password-stdin 111122223333.dkr.ecr.us-east-1.amazonaws.com
```

2. Create a repository in Amazon ECR using the [create-repository](#) command.

```
aws ecr create-repository --repository-name hello-world --region us-east-1 --image-scanning-configuration scanOnPush=true --image-tag-mutability MUTABLE
```

Note

The Amazon ECR repository must be in the same AWS Region as the Lambda function.

If successful, you see a response like this:

```
{
  "repository": {
    "repositoryArn": "arn:aws:ecr:us-east-1:111122223333:repository/hello-
world",
    "registryId": "111122223333",
    "repositoryName": "hello-world",
    "repositoryUri": "111122223333.dkr.ecr.us-east-1.amazonaws.com/hello-
world",
    "createdAt": "2023-03-09T10:39:01+00:00",
    "imageTagMutability": "MUTABLE",
    "imageScanningConfiguration": {
      "scanOnPush": true
    },
    "encryptionConfiguration": {
      "encryptionType": "AES256"
    }
  }
}
```

3. Copy the `repositoryUri` from the output in the previous step.
4. Run the [docker tag](#) command to tag your local image into your Amazon ECR repository as the latest version. In this command:
 - `docker-image:test` is the name and [tag](#) of your Docker image. This is the image name and tag that you specified in the `docker build` command.
 - Replace `<ECRrepositoryUri>` with the `repositoryUri` that you copied. Make sure to include `:latest` at the end of the URI.

```
docker tag docker-image:test <ECRrepositoryUri>:latest
```

Example:

```
docker tag docker-image:test 111122223333.dkr.ecr.us-east-1.amazonaws.com/hello-world:latest
```

5. Run the [docker push](#) command to deploy your local image to the Amazon ECR repository. Make sure to include `:latest` at the end of the repository URI.

```
docker push 111122223333.dkr.ecr.us-east-1.amazonaws.com/hello-world:latest
```

6. [Create an execution role](#) for the function, if you don't already have one. You need the Amazon Resource Name (ARN) of the role in the next step.
7. Create the Lambda function. For `ImageUri`, specify the repository URI from earlier. Make sure to include `:latest` at the end of the URI.

```
aws lambda create-function \  
  --function-name hello-world \  
  --package-type Image \  
  --code ImageUri=111122223333.dkr.ecr.us-east-1.amazonaws.com/hello-world:latest \  
  --role arn:aws:iam::111122223333:role/lambda-ex
```

Note

You can create a function using an image in a different AWS account, as long as the image is in the same Region as the Lambda function. For more information, see [Amazon ECR cross-account permissions](#).

8. Invoke the function.

```
aws lambda invoke --function-name hello-world response.json
```

You should see a response like this:

```
{  
  "ExecutedVersion": "$LATEST",  
  "StatusCode": 200  
}
```

9. To see the output of the function, check the `response.json` file.

To update the function code, you must build the image again, upload the new image to the Amazon ECR repository, and then use the [update-function-code](#) command to deploy the image to the Lambda function.

Lambda resolves the image tag to a specific image digest. This means that if you point the image tag that was used to deploy the function to a new image in Amazon ECR, Lambda doesn't automatically update the function to use the new image.

To deploy the new image to the same Lambda function, you must use the [update-function-code](#) command, even if the image tag in Amazon ECR remains the same. In the following example, the `--publish` option creates a new version of the function using the updated container image.

```
aws lambda update-function-code \  
  --function-name hello-world \  
  --image-uri 111122223333.dkr.ecr.us-east-1.amazonaws.com/hello-world:latest \  
  --publish
```

Using an alternative base image with the runtime interface client

If you use an [OS-only base image](#) or an alternative base image, you must include the runtime interface client in your image. The runtime interface client extends the [Using the Lambda runtime API for custom runtimes](#), which manages the interaction between Lambda and your function code.

Install the [Node.js runtime interface client](#) using the npm package manager:

```
npm install aws-lambda-ric
```

You can also download the [Node.js runtime interface client](#) from GitHub.

The following example demonstrates how to build a container image for Node.js using a non-AWS base image. The example Dockerfile uses a `buster` base image. The Dockerfile includes the runtime interface client.

Prerequisites

To complete the steps in this section, you must have the following:

- [AWS CLI version 2](#)
- [Docker](#)

- Node.js

Creating an image from an alternative base image

To create a container image from a non-AWS base image

1. Create a directory for the project, and then switch to that directory.

```
mkdir example
cd example
```

2. Create a new Node.js project with npm. To accept the default options provided in the interactive experience, press Enter.

```
npm init
```

3. Create a new file called `index.js`. You can add the following sample function code to the file for testing, or use your own.

```
exports.handler = async (event) => {
  const response = {
    statusCode: 200,
    body: JSON.stringify('Hello from Lambda!'),
  };
  return response;
};
```

4. Create a new Dockerfile. The following Dockerfile uses a `buster` base image instead of an [AWS base image](#). The Dockerfile includes the [runtime interface client](#), which makes the image compatible with Lambda. The Dockerfile uses a [multi-stage build](#). The first stage creates a build image, which is a standard Node.js environment where the function's dependencies are installed. The second stage creates a slimmer image which includes the function code and its dependencies. This reduces the final image size.

- Set the `FROM` property to the base image identifier.
- Use the `COPY` command to copy the function code and runtime dependencies.
- Set the `ENTRYPOINT` to the module that you want the Docker container to run when it starts. In this case, the module is the runtime interface client.

- Set the CMD argument to the Lambda function handler.

Note that the example Dockerfile does not include a [USER instruction](#). When you deploy a container image to Lambda, Lambda automatically defines a default Linux user with least-privileged permissions. This is different from standard Docker behavior which defaults to the root user when no USER instruction is provided.

Example Dockerfile

```
# Define custom function directory
ARG FUNCTION_DIR="/function"

FROM node:20-buster as build-image

# Include global arg in this stage of the build
ARG FUNCTION_DIR

# Install build dependencies
RUN apt-get update && \
    apt-get install -y \
        g++ \
        make \
        cmake \
        unzip \
        libcurl4-openssl-dev

# Copy function code
RUN mkdir -p ${FUNCTION_DIR}
COPY . ${FUNCTION_DIR}

WORKDIR ${FUNCTION_DIR}

# Install Node.js dependencies
RUN npm install

# Install the runtime interface client
RUN npm install aws-lambda-ric

# Grab a fresh slim copy of the image to reduce the final size
FROM node:20-buster-slim

# Required for Node runtimes which use npm@8.6.0+ because
```

```
# by default npm writes logs under /home/.npm and Lambda fs is read-only
ENV NPM_CONFIG_CACHE=/tmp/.npm

# Include global arg in this stage of the build
ARG FUNCTION_DIR

# Set working directory to function root directory
WORKDIR ${FUNCTION_DIR}

# Copy in the built dependencies
COPY --from=build-image ${FUNCTION_DIR} ${FUNCTION_DIR}

# Set runtime interface client as default command for the container runtime
ENTRYPOINT ["/usr/local/bin/npx", "aws-lambda-ric"]
# Pass the name of the function handler as an argument to the runtime
CMD ["index.handler"]
```

5. Build the Docker image with the [docker build](#) command. The following example names the image `docker-image` and gives it the test [tag](#).

```
docker build --platform linux/amd64 -t docker-image:test .
```

Note

The command specifies the `--platform linux/amd64` option to ensure that your container is compatible with the Lambda execution environment regardless of the architecture of your build machine. If you intend to create a Lambda function using the ARM64 instruction set architecture, be sure to change the command to use the `--platform linux/arm64` option instead.

(Optional) Test the image locally

Use the [runtime interface emulator](#) to locally test the image. You can [build the emulator into your image](#) or use the following procedure to install it on your local machine.

To install and run the runtime interface emulator on your local machine

1. From your project directory, run the following command to download the runtime interface emulator (x86-64 architecture) from GitHub and install it on your local machine.

Linux/macOS

```
mkdir -p ~/.aws-lambda-rie && \  
  curl -Lo ~/.aws-lambda-rie/aws-lambda-rie https://github.com/aws/aws-lambda-  
runtime-interface-emulator/releases/latest/download/aws-lambda-rie && \  
  chmod +x ~/.aws-lambda-rie/aws-lambda-rie
```

To install the arm64 emulator, replace the GitHub repository URL in the previous command with the following:

```
https://github.com/aws/aws-lambda-runtime-interface-emulator/releases/latest/  
download/aws-lambda-rie-arm64
```

PowerShell

```
$dirPath = "$HOME\.aws-lambda-rie"  
if (-not (Test-Path $dirPath)) {  
  New-Item -Path $dirPath -ItemType Directory  
}  
  
$downloadLink = "https://github.com/aws/aws-lambda-runtime-interface-emulator/  
releases/latest/download/aws-lambda-rie"  
$destinationPath = "$HOME\.aws-lambda-rie\aws-lambda-rie"  
Invoke-WebRequest -Uri $downloadLink -OutFile $destinationPath
```

To install the arm64 emulator, replace the `$downloadLink` with the following:

```
https://github.com/aws/aws-lambda-runtime-interface-emulator/releases/latest/  
download/aws-lambda-rie-arm64
```

2. Start the Docker image with the **docker run** command. Note the following:

- `docker-image` is the image name and `test` is the tag.
- `/usr/local/bin/npx aws-lambda-ric index.handler` is the ENTRYPOINT followed by the CMD from your Dockerfile.

Linux/macOS

```
docker run --platform linux/amd64 -d -v ~/.aws-lambda-rie:/aws-lambda -p
9000:8080 \
  --entrypoint /aws-lambda/aws-lambda-rie \
  docker-image:test \
  /usr/local/bin/npx aws-lambda-ric index.handler
```

PowerShell

```
docker run --platform linux/amd64 -d -v "$HOME\.aws-lambda-rie:/aws-lambda" -p
9000:8080 `
  --entrypoint /aws-lambda/aws-lambda-rie `
  docker-image:test `
  /usr/local/bin/npx aws-lambda-ric index.handler
```

This command runs the image as a container and creates a local endpoint at `localhost:9000/2015-03-31/functions/function/invocations`.

Note

If you built the Docker image for the ARM64 instruction set architecture, be sure to use the `--platform linux/arm64` option instead of `--platform linux/amd64`.

3. Post an event to the local endpoint.

Linux/macOS

In Linux and macOS, run the following `curl` command:

```
curl "http://localhost:9000/2015-03-31/functions/function/invocations" -d '{}'
```

This command invokes the function with an empty event and returns a response. If you're using your own function code rather than the sample function code, you might want to invoke the function with a JSON payload. Example:

```
curl "http://localhost:9000/2015-03-31/functions/function/invocations" -d
'{"payload":"hello world!"}'
```

PowerShell

In PowerShell, run the following Invoke-WebRequest command:

```
Invoke-WebRequest -Uri "http://localhost:9000/2015-03-31/functions/function/
invocations" -Method Post -Body '{}' -ContentType "application/json"
```

This command invokes the function with an empty event and returns a response. If you're using your own function code rather than the sample function code, you might want to invoke the function with a JSON payload. Example:

```
Invoke-WebRequest -Uri "http://localhost:9000/2015-03-31/functions/function/
invocations" -Method Post -Body '{"payload":"hello world!"}' -ContentType
"application/json"
```

4. Get the container ID.

```
docker ps
```

5. Use the [docker kill](#) command to stop the container. In this command, replace 3766c4ab331c with the container ID from the previous step.

```
docker kill 3766c4ab331c
```

Deploying the image

To upload the image to Amazon ECR and create the Lambda function

1. Run the [get-login-password](#) command to authenticate the Docker CLI to your Amazon ECR registry.
 - Set the `--region` value to the AWS Region where you want to create the Amazon ECR repository.
 - Replace 111122223333 with your AWS account ID.

```
aws ecr get-login-password --region us-east-1 | docker login --username AWS --password-stdin 111122223333.dkr.ecr.us-east-1.amazonaws.com
```

2. Create a repository in Amazon ECR using the [create-repository](#) command.

```
aws ecr create-repository --repository-name hello-world --region us-east-1 --image-scanning-configuration scanOnPush=true --image-tag-mutability MUTABLE
```

Note

The Amazon ECR repository must be in the same AWS Region as the Lambda function.

If successful, you see a response like this:

```
{
  "repository": {
    "repositoryArn": "arn:aws:ecr:us-east-1:111122223333:repository/hello-world",
    "registryId": "111122223333",
    "repositoryName": "hello-world",
    "repositoryUri": "111122223333.dkr.ecr.us-east-1.amazonaws.com/hello-world",
    "createdAt": "2023-03-09T10:39:01+00:00",
    "imageTagMutability": "MUTABLE",
    "imageScanningConfiguration": {
      "scanOnPush": true
    },
    "encryptionConfiguration": {
      "encryptionType": "AES256"
    }
  }
}
```

3. Copy the `repositoryUri` from the output in the previous step.
4. Run the [docker tag](#) command to tag your local image into your Amazon ECR repository as the latest version. In this command:

- `docker-image:test` is the name and [tag](#) of your Docker image. This is the image name and tag that you specified in the `docker build` command.
- Replace `<ECRrepositoryUri>` with the `repositoryUri` that you copied. Make sure to include `:latest` at the end of the URI.

```
docker tag docker-image:test <ECRrepositoryUri>:latest
```

Example:

```
docker tag docker-image:test 111122223333.dkr.ecr.us-east-1.amazonaws.com/hello-world:latest
```

5. Run the [docker push](#) command to deploy your local image to the Amazon ECR repository. Make sure to include `:latest` at the end of the repository URI.

```
docker push 111122223333.dkr.ecr.us-east-1.amazonaws.com/hello-world:latest
```

6. [Create an execution role](#) for the function, if you don't already have one. You need the Amazon Resource Name (ARN) of the role in the next step.
7. Create the Lambda function. For `ImageUri`, specify the repository URI from earlier. Make sure to include `:latest` at the end of the URI.

```
aws lambda create-function \  
  --function-name hello-world \  
  --package-type Image \  
  --code ImageUri=111122223333.dkr.ecr.us-east-1.amazonaws.com/hello-world:latest \  
  --role arn:aws:iam::111122223333:role/lambda-ex
```

Note

You can create a function using an image in a different AWS account, as long as the image is in the same Region as the Lambda function. For more information, see [Amazon ECR cross-account permissions](#).

8. Invoke the function.

```
aws lambda invoke --function-name hello-world response.json
```

You should see a response like this:

```
{
  "ExecutedVersion": "$LATEST",
  "StatusCode": 200
}
```

9. To see the output of the function, check the `response.json` file.

To update the function code, you must build the image again, upload the new image to the Amazon ECR repository, and then use the [update-function-code](#) command to deploy the image to the Lambda function.

Lambda resolves the image tag to a specific image digest. This means that if you point the image tag that was used to deploy the function to a new image in Amazon ECR, Lambda doesn't automatically update the function to use the new image.

To deploy the new image to the same Lambda function, you must use the [update-function-code](#) command, even if the image tag in Amazon ECR remains the same. In the following example, the `--publish` option creates a new version of the function using the updated container image.

```
aws lambda update-function-code \  
  --function-name hello-world \  
  --image-uri 111122223333.dkr.ecr.us-east-1.amazonaws.com/hello-world:latest \  
  --publish
```

Working with layers for Node.js Lambda functions

A [Lambda layer](#) is a .zip file archive that contains supplementary code or data. Layers usually contain library dependencies, a [custom runtime](#), or configuration files. Creating a layer involves three general steps:

1. Package your layer content. This means creating a .zip file archive that contains the dependencies you want to use in your functions.
2. Create the layer in Lambda.
3. Add the layer to your functions.

This topic contains steps and guidance on how to properly package and create a Node.js Lambda layer with external library dependencies.

Topics

- [Prerequisites](#)
- [Node.js layer compatibility with the Lambda runtime environment](#)
- [Layer paths for Node.js runtimes](#)
- [Packaging the layer content](#)
- [Creating the layer](#)
- [Adding the layer to your function](#)

Prerequisites

To follow the steps in this section, you must have the following:

- [Node.js 20](#) and the [npm](#) package manager. For more information about installing Node.js, see [Installing Node.js via package manager](#) in the Node.js documentation.
- [AWS CLI version 2](#)

Throughout this topic, we reference the [layer-nodejs](#) sample application in the *aws-lambda-developer-guide* GitHub repository. This application contains scripts that download a dependency and package it into a layer. The application also contains corresponding functions that use the dependency from the layer. After creating a layer, you can deploy and invoke the corresponding

function to verify that everything works. This sample application uses the Node.js 20 runtime. If you add additional dependencies to your layer, they must be compatible with Node.js 20.

The `layer-nodejs` sample application will package the [lodash](#) library into a Lambda layer. The `layer` directory contains the scripts to generate the layer. The `function` directory contains a sample function to test that the layer works. This document walks through how to create, package, deploy and test this layer.

Node.js layer compatibility with the Lambda runtime environment

When you package code in a Node.js layer, you specify the Lambda runtime environments that the code is compatible with. To assess code compatibility with a runtime, consider what versions of Node.js, what operating systems, and what instruction set architectures the code is designed for.

Lambda Node.js runtimes specify their Node.js version and operating system. In this document, you will use the Node.js 20 runtime, which is based on AL2023. For more information about runtime versions, see [the section called “Supported runtimes”](#). When you create a Lambda function, you specify the instruction set architecture. In this document, you will use the `arm64` architecture. For more information about architectures in Lambda, see [the section called “Instruction sets \(ARM/x86\)”](#).

When you use code provided in a package, each package maintainer independently defines their compatibility. Most Node.js development is designed to work independently of operating system and instruction set architecture. Additionally, breaking incompatibilities with new Node.js versions are not that common. Expect to spend more of your time assessing compatibility between packages than assessing package compatibility with Node.js version, operating system, or instruction set architecture.

Sometimes Node.js packages include compiled code, which require you to consider operating system and instruction set architecture compatibility. If you do need to assess code compatibility for your packages, you will need to inspect the packages and their documentation. Packages in NPM can specify their compatibility through the `engines`, `os`, and `cpu` fields of their `package.json` manifest file. For more information about `package.json` files, see [package.json](#) in the NPM documentation.

Layer paths for Node.js runtimes

When you add a layer to a function, Lambda loads the layer content into the execution environment. If your layer packages dependencies in specific folder paths, the Node.js execution

environment will recognize the modules, and you can reference the modules from your function code.

To ensure that your modules are picked up, package them into your layer .zip file in one of the following folder paths. These files are stored in /opt, and the folder paths are loaded into the PATH environment variable.

- nodejs/node_modules
- nodejs/nodeX/node_modules

For example, the resulting layer .zip file that you create in this tutorial has the following directory structure:

```
layer_content.zip
# nodejs
  # node20
    # node_modules
      # lodash
      # <other potential dependencies>
      # ...
```

You will put the [lodash](#) library in the nodejs/node20/node_modules directory. This ensures that Lambda can locate the library during function invocations.

Packaging the layer content

In this example, you package the lodash library in a layer .zip file. Complete the following steps to install and package the layer content.

To install and package your layer content

1. Clone the [aws-lambda-developer-guide](#) repository from GitHub, which contains the sample code that you need in the sample-apps/layer-nodejs directory.

```
git clone https://github.com/awsdocs/aws-lambda-developer-guide.git
```

2. Navigate to the layer directory of the layer-nodejs sample app. This directory contains the scripts that you use to create and package the layer properly.

```
cd aws-lambda-developer-guide/sample-apps/layer-nodejs/layer
```

3. Ensure the `package.json` file lists `lodash`. This file defines the dependencies that you want to include in the layer. You can update this file to include any dependencies that you want in your layer.

Note

The `package.json` used in this step is not stored or used with your dependencies after they are uploaded to a Lambda layer. It is only used in the layer packaging process, and does not specify a run command and compatibility as the file would in a Node.js application or published package.

4. Ensure that you have shell permission to run the scripts in the `layer` directory.

```
chmod 744 1-install.sh && chmod 744 2-package.sh
```

5. Run the [1-install.sh](#) script using the following command:

```
./1-install.sh
```

This script runs `npm install`, which reads your `package.json` and downloads the dependencies defined inside of it.

Example 1-install.sh

```
npm install .
```

6. Run the [2-package.sh](#) script using the following command:

```
./2-package.sh
```

This script copies the contents from the `node_modules` directory into a new directory named `nodejs/node20`. It then zips the contents of the `nodejs` directory into a file named `layer_content.zip`. This is the `.zip` file for your layer. You can unzip the file and verify that it contains the correct file structure, as shown in the [the section called “Layer paths for Node.js runtimes”](#) section.

Example 2-package.sh

```
mkdir -p nodejs/node20
cp -r node_modules nodejs/node20/
zip -r layer_content.zip nodejs
```

Creating the layer

Take the `layer_content.zip` file that you generated in the previous section and upload it as a Lambda layer. You can upload a layer using the AWS Management Console or the Lambda API via the AWS Command Line Interface (AWS CLI). When you upload your layer .zip file, in the following [PublishLayerVersion](#) AWS CLI command, specify `nodejs20.x` as the compatible runtime and `arm64` as the compatible architecture.

```
aws lambda publish-layer-version --layer-name nodejs-lodash-layer \
  --zip-file fileb://layer_content.zip \
  --compatible-runtimes nodejs20.x \
  --compatible-architectures "arm64"
```

From the response, note the `LayerVersionArn`, which looks like `arn:aws:lambda:us-east-1:123456789012:layer:nodejs-lodash-layer:1`. You'll need this Amazon Resource Name (ARN) in the next step of this tutorial, when you add the layer to your function.

Adding the layer to your function

Deploy a sample Lambda function that uses the `Lodash` library in its function code, then attach the layer you created. To deploy the function, you need an execution role. For more information, see [the section called "Execution role \(permissions for functions to access other resources\)"](#). If you don't have an existing execution role, follow the steps in the collapsible section. Otherwise, skip to the next section to deploy the function.

(Optional) Create an execution role

To create an execution role

1. Open the [roles page](#) in the IAM console.
2. Choose **Create role**.

3. Create a role with the following properties.
 - **Trusted entity – Lambda.**
 - **Permissions – `AWSLambdaBasicExecutionRole`.**
 - **Role name – `lambda-role`.**

The **`AWSLambdaBasicExecutionRole`** policy has the permissions that the function needs to write logs to CloudWatch Logs.

The sample [function code](#) uses the lodash `_.findLastIndex` method to read through an array of objects. It compares the objects against a criteria to find the index of a match. Then, it returns the index and value of the object in the Lambda response.

```
import _ from "lodash"

export const handler = async (event) => {

  var users = [
    { 'user': 'Carlos', 'active': true },
    { 'user': 'Gil-dong', 'active': false },
    { 'user': 'Pat', 'active': false }
  ];

  let out = _.findLastIndex(users, function(o) { return o.user == 'Pat'; });
  const response = {
    statusCode: 200,
    body: JSON.stringify(out + ", " + users[out].user),
  };
  return response;
};
```

To deploy the Lambda function

1. Navigate to the `function/` directory. If you're currently in the `layer/` directory, then run the following command:

```
cd ../function-js
```

2. Create a `.zip` file deployment package using the following command:

```
zip my_deployment_package.zip index.mjs
```

3. Deploy the function. In the following AWS CLI command, replace the `--role` parameter with your execution role ARN:

```
aws lambda create-function --function-name nodejs_function_with_layer \  
  --runtime nodejs20.x \  
  --architectures "arm64" \  
  --handler index.handler \  
  --role arn:aws:iam::123456789012:role/lambda-role \  
  --zip-file fileb://my_deployment_package.zip
```

4. Attach the layer to your function. In the following AWS CLI command, replace the `--layers` parameter with the layer version ARN that you noted earlier:

```
aws lambda update-function-configuration --function-name nodejs_function_with_layer \  
  --cli-binary-format raw-in-base64-out \  
  --layers "arn:aws:lambda:us-east-1:123456789012:layer:nodejs-lodash-layer:1"
```

5. Invoke your function to verify it works using the following AWS CLI command:

```
aws lambda invoke --function-name nodejs_function_with_layer \  
  --cli-binary-format raw-in-base64-out \  
  --payload '{} response.json
```

You should see output that looks like this:

```
{  
  "StatusCode": 200,  
  "ExecutedVersion": "$LATEST"  
}
```

The output `response.json` file contains details about the response.

(Optional) Clean up your resources

You can now delete the resources that you created for this tutorial, unless you want to retain them. By deleting AWS resources that you're no longer using, you prevent unnecessary charges to your AWS account.

To delete the Lambda layer

1. Open the [Layers page](#) of the Lambda console.
2. Select the layer that you created.
3. Choose **Delete**, then choose **Delete** again.

To delete the Lambda function

1. Open the [Functions page](#) of the Lambda console.
2. Select the function that you created.
3. Choose **Actions, Delete**.
4. Type **confirm** in the text input field and choose **Delete**.

Using the Lambda context object to retrieve Node.js function information

When Lambda runs your function, it passes a context object to the [handler](#). This object provides methods and properties that provide information about the invocation, function, and execution environment.

Context methods

- `getRemainingTimeInMillis()` – Returns the number of milliseconds left before the execution times out.

Context properties

- `functionName` – The name of the Lambda function.
- `functionVersion` – The [version](#) of the function.
- `invokedFunctionArn` – The Amazon Resource Name (ARN) that's used to invoke the function. Indicates if the invoker specified a version number or alias.
- `memoryLimitInMB` – The amount of memory that's allocated for the function.
- `awsRequestId` – The identifier of the invocation request.
- `logGroupName` – The log group for the function.
- `logStreamName` – The log stream for the function instance.
- `identity` – (mobile apps) Information about the Amazon Cognito identity that authorized the request.
 - `cognitoIdentityId` – The authenticated Amazon Cognito identity.
 - `cognitoIdentityPoolId` – The Amazon Cognito identity pool that authorized the invocation.
- `clientContext` – (mobile apps) Client context that's provided to Lambda by the client application.
 - `client.installation_id`
 - `client.app_title`
 - `client.app_version_name`
 - `client.app_version_code`

- `client.app_package_name`
 - `env.platform_version`
 - `env.platform`
 - `env.make`
 - `env.model`
 - `env.locale`
 - Custom – Custom values that are set by the client application.
- `callbackWaitsForEmptyEventLoop` – Set to `false` to send the response right away when the [callback](#) runs, instead of waiting for the Node.js event loop to be empty. If this is `false`, any outstanding events continue to run during the next invocation.

The following example function logs context information and returns the location of the logs.

Example `index.js` file

```
exports.handler = async function(event, context) {
  console.log('Remaining time: ', context.getRemainingTimeInMillis())
  console.log('Function name: ', context.functionName)
  return context.logStreamName
}
```

Log and monitor Node.js Lambda functions

AWS Lambda automatically monitors Lambda functions on your behalf and sends logs to Amazon CloudWatch. Your Lambda function comes with a CloudWatch Logs log group and a log stream for each instance of your function. The Lambda runtime environment sends details about each invocation to the log stream, and relays logs and other output from your function's code. For more information, see [Using CloudWatch Logs with Lambda](#).

This page describes how to produce log output from your Lambda function's code, and access logs using the AWS Command Line Interface, the Lambda console, or the CloudWatch console.

Sections

- [Creating a function that returns logs](#)
- [Using Lambda advanced logging controls with Node.js](#)
- [Viewing logs in the Lambda console](#)
- [Viewing logs in the CloudWatch console](#)
- [Viewing logs using the AWS Command Line Interface \(AWS CLI\)](#)
- [Deleting logs](#)

Creating a function that returns logs

To output logs from your function code, you can use methods on the [console object](#), or any logging library that writes to `stdout` or `stderr`. The following example logs the values of environment variables and the event object.

Note

We recommend that you use techniques such as input validation and output encoding when logging inputs. If you log input data directly, an attacker might be able to use your code to make tampering hard to detect, forge log entries, or bypass log monitors. For more information, see [Improper Output Neutralization for Logs](#) in the *Common Weakness Enumeration*.

Example index.js file – Logging

```
exports.handler = async function(event, context) {
```

```

console.log("ENVIRONMENT VARIABLES\n" + JSON.stringify(process.env, null, 2))
console.info("EVENT\n" + JSON.stringify(event, null, 2))
console.warn("Event not processed.")
return context.logStreamName
}

```

Example log format

```

START RequestId: c793869b-ee49-115b-a5b6-4fd21e8dedac Version: $LATEST
2019-06-07T19:11:20.562Z c793869b-ee49-115b-a5b6-4fd21e8dedac INFO ENVIRONMENT
VARIABLES
{
  "AWS_LAMBDA_FUNCTION_VERSION": "$LATEST",
  "AWS_LAMBDA_LOG_GROUP_NAME": "/aws/lambda/my-function",
  "AWS_LAMBDA_LOG_STREAM_NAME": "2019/06/07/[$LATEST]e6f4a0c4241adcd70c262d34c0bbc85c",
  "AWS_EXECUTION_ENV": "AWS_Lambda_nodejs12.x",
  "AWS_LAMBDA_FUNCTION_NAME": "my-function",
  "PATH": "/var/lang/bin:/usr/local/bin:/usr/bin:/bin:/opt/bin",
  "NODE_PATH": "/opt/nodejs/node10/node_modules:/opt/nodejs/node_modules:/var/runtime/
node_modules",
  ...
}
2019-06-07T19:11:20.563Z c793869b-ee49-115b-a5b6-4fd21e8dedac INFO EVENT
{
  "key": "value"
}
2019-06-07T19:11:20.564Z c793869b-ee49-115b-a5b6-4fd21e8dedac WARN Event not processed.
END RequestId: c793869b-ee49-115b-a5b6-4fd21e8dedac
REPORT RequestId: c793869b-ee49-115b-a5b6-4fd21e8dedac Duration: 128.83 ms Billed
Duration: 200 ms Memory Size: 128 MB Max Memory Used: 74 MB Init Duration: 166.62 ms
XRAY TraceId: 1-5d9d007f-0a8c7fd02xmpl480aed55ef0 SegmentId: 3d752xmpl1bbe37e Sampled:
true

```

The Node.js runtime logs the START, END, and REPORT lines for each invocation. It adds a timestamp, request ID, and log level to each entry logged by the function. The report line provides the following details.

REPORT line data fields

- **RequestId** – The unique request ID for the invocation.
- **Duration** – The amount of time that your function's handler method spent processing the event.
- **Billed Duration** – The amount of time billed for the invocation.

- **Memory Size** – The amount of memory allocated to the function.
- **Max Memory Used** – The amount of memory used by the function. When invocations share an execution environment, Lambda reports the maximum memory used across all invocations. This behavior might result in a higher than expected reported value.
- **Init Duration** – For the first request served, the amount of time it took the runtime to load the function and run code outside of the handler method.
- **XRAY TraceId** – For traced requests, the [AWS X-Ray trace ID](#).
- **SegmentId** – For traced requests, the X-Ray segment ID.
- **Sampled** – For traced requests, the sampling result.

You can view logs in the Lambda console, in the CloudWatch Logs console, or from the command line.

Using Lambda advanced logging controls with Node.js

To give you more control over how your functions' logs are captured, processed, and consumed, you can configure the following logging options for supported Node.js runtimes:

- **Log format** - select between plain text and structured JSON format for your function's logs
- **Log level** - for logs in JSON format, choose the detail level of the logs Lambda sends to Amazon CloudWatch, such as ERROR, DEBUG, or INFO
- **Log group** - choose the CloudWatch log group your function sends logs to

For more information about these logging options, and instructions on how to configure your function to use them, see [the section called "Configure function logs"](#).

To use the log format and log level options with your Node.js Lambda functions, see the guidance in the following sections.

Using structured JSON logs with Node.js

If you select JSON for your function's log format, Lambda will send logs output using the console methods of `console.trace`, `console.debug`, `console.log`, `console.info`, `console.error`, and `console.warn` to CloudWatch as structured JSON. Each JSON log object contains at least four key value pairs with the following keys:

- `"timestamp"` - the time the log message was generated

- "level" - the log level assigned to the message
- "message" - the contents of the log message
- "requestId" - the unique request ID for the function invocation

Depending on the logging method that your function uses, this JSON object may also contain additional key pairs. For example, if your function uses `console` methods to log error objects using multiple arguments, the JSON object will contain extra key value pairs with the keys `errorMessage`, `errorType`, and `stackTrace`.

If your code already uses another logging library, such as Powertools for AWS Lambda, to produce JSON structured logs, you don't need to make any changes. Lambda doesn't double-encode any logs that are already JSON encoded, so your function's application logs will continue to be captured as before.

For more information about using the Powertools for AWS Lambda logging package to create JSON structured logs in the Node.js runtime, see [the section called "Logging"](#).

Example JSON formatted log outputs

The following examples shows how various log outputs generated using the `console` methods with single and multiple arguments are captured in CloudWatch Logs when you set your function's log format to JSON.

The first example uses the `console.error` method to output a simple string.

Example Node.js logging code

```
export const handler = async (event) => {
  console.error("This is a warning message");
  ...
}
```

Example JSON log record

```
{
  "timestamp": "2023-11-01T00:21:51.358Z",
  "level": "ERROR",
  "message": "This is a warning message",
  "requestId": "93f25699-2cbf-4976-8f94-336a0aa98c6f"
}
```

You can also output more complex structured log messages using either single or multiple arguments with the `console` methods. In the next example, you use `console.log` to output two key value pairs using a single argument. Note that the "message" field in the JSON object Lambda sends to CloudWatch Logs is not stringified.

Example Node.js logging code

```
export const handler = async (event) => {
  console.log({data: 12.3, flag: false});
  ...
}
```

Example JSON log record

```
{
  "timestamp": "2023-12-08T23:21:04.664Z",
  "level": "INFO",
  "requestId": "405a4537-9226-4216-ac59-64381ec8654a",
  "message": {
    "data": 12.3,
    "flag": false
  }
}
```

In the next example, you again use the `console.log` method to create a log output. This time, the method takes two arguments, a map containing two key value pairs and an identifying string. Note that in this case, because you have supplied two arguments, Lambda stringifies the "message" field.

Example Node.js logging code

```
export const handler = async (event) => {
  console.log('Some object - ', {data: 12.3, flag: false});
  ...
}
```

Example JSON log record

```
{
  "timestamp": "2023-12-08T23:21:04.664Z",
```

```
"level": "INFO",
"requestId": "405a4537-9226-4216-ac59-64381ec8654a",
"message": "Some object - { data: 12.3, flag: false }"
}
```

Lambda assigns outputs generated using `console.log` the log level INFO.

The final example shows how error objects can be output to CloudWatch Logs using the `console` methods. Note that when you log error objects using multiple arguments, Lambda adds the fields `errorMessage`, `errorType`, and `stackTrace` to the log output.

Example Node.js logging code

```
export const handler = async (event) => {
  let e1 = new ReferenceError("some reference error");
  let e2 = new SyntaxError("some syntax error");
  console.log(e1);
  console.log("errors logged - ", e1, e2);
};
```

Example JSON log record

```
{
  "timestamp": "2023-12-08T23:21:04.632Z",
  "level": "INFO",
  "requestId": "405a4537-9226-4216-ac59-64381ec8654a",
  "message": {
    "errorType": "ReferenceError",
    "errorMessage": "some reference error",
    "stackTrace": [
      "ReferenceError: some reference error",
      "    at Runtime.handler (file:///var/task/index.mjs:3:12)",
      "    at Runtime.handleOnceNonStreaming (file:///var/runtime/index.mjs:1173:29)"
    ]
  }
}

{
  "timestamp": "2023-12-08T23:21:04.646Z",
  "level": "INFO",
  "requestId": "405a4537-9226-4216-ac59-64381ec8654a",
```

```
    "message": "errors logged - ReferenceError: some reference error\n    at Runtime.handler (file:///var/task/index.mjs:3:12)\n    at\n    Runtime.handleOnceNonStreaming\n    (file:///var/runtime/index.mjs:1173:29) SyntaxError: some syntax\n    error\n    at Runtime.handler (file:///var/task/index.mjs:4:12)\n    at\n    Runtime.handleOnceNonStreaming\n    (file:///var/runtime/index.mjs:1173:29)",\n    "errorType": "ReferenceError",\n    "errorMessage": "some reference error",\n    "stackTrace": [\n      "ReferenceError: some reference error",\n      "    at Runtime.handler (file:///var/task/index.mjs:3:12)",\n      "    at Runtime.handleOnceNonStreaming (file:///var/runtime/index.mjs:1173:29)" ]\n  }\n}
```

When logging multiple error types, the extra fields `errorMessage`, `errorType`, and `stackTrace` are extracted from the first error type supplied to the `console` method.

Using embedded metric format (EMF) client libraries with structured JSON logs

AWS provides open-sourced client libraries for Node.js which you can use to create [embedded metric format](#) (EMF) logs. If you have existing functions that use these libraries and you change your function's log format to JSON, CloudWatch may no longer recognize the metrics emitted by your code.

If your code currently emits EMF logs directly using `console.log` or by using `Powertools for AWS Lambda` (TypeScript), CloudWatch will also be unable to parse these if you change your function's log format to JSON.

Important

To ensure that your functions' EMF logs continue to be properly parsed by CloudWatch, update your [EMF](#) and [Powertools for AWS Lambda](#) libraries to the latest versions. If switching to the JSON log format, we also recommend that you carry out testing to ensure compatibility with your function's embedded metrics. If your code emits EMF logs directly using `console.log`, change your code to output those metrics directly to `stdout` as shown in the following code example.

Example code emitting embedded metrics to stdout

```
process.stdout.write(JSON.stringify(
  {
    "_aws": {
      "Timestamp": Date.now(),
      "CloudWatchMetrics": [{
        "Namespace": "lambda-function-metrics",
        "Dimensions": [["functionVersion"]],
        "Metrics": [{
          "Name": "time",
          "Unit": "Milliseconds",
          "StorageResolution": 60
        }]
      }]
    },
    "functionVersion": "$LATEST",
    "time": 100,
    "requestId": context.awsRequestId
  }
) + "\n")
```

Using log-level filtering with Node.js

For AWS Lambda to filter your application logs according to their log level, your function must use JSON formatted logs. You can achieve this in two ways:

- Create log outputs using the standard console methods and configure your function to use JSON log formatting. AWS Lambda then filters your log outputs using the "level" key value pair in the JSON object described in [the section called "Using structured JSON logs with Node.js"](#). To learn how to configure your function's log format, see [the section called "Configure function logs"](#).
- Use another logging library or method to create JSON structured logs in your code that include a "level" key value pair defining the level of the log output. For example, you can use Powertools for AWS Lambda to generate JSON structured log outputs from your code. See [the section called "Logging"](#) to learn more about using Powertools with the Node.js runtime.

For Lambda to filter your function's logs, you must also include a "timestamp" key value pair in your JSON log output. The time must be specified in valid [RFC 3339](#) timestamp format. If you don't supply a valid timestamp, Lambda will assign the log the level INFO and add a timestamp for you.

When you configure your function to use log-level filtering, you select the level of logs you want AWS Lambda to send to CloudWatch Logs from the following options:

Log level	Standard usage
TRACE (most detail)	The most fine-grained information used to trace the path of your code's execution
DEBUG	Detailed information for system debugging
INFO	Messages that record the normal operation of your function
WARN	Messages about potential errors that may lead to unexpected behavior if unaddressed
ERROR	Messages about problems that prevent the code from performing as expected
FATAL (least detail)	Messages about serious errors that cause the application to stop functioning

Lambda sends logs of the selected level and lower to CloudWatch. For example, if you configure a log level of WARN, Lambda will send logs corresponding to the WARN, ERROR, and FATAL levels.

Viewing logs in the Lambda console

You can use the Lambda console to view log output after you invoke a Lambda function.

If your code can be tested from the embedded **Code** editor, you will find logs in the **execution results**. When you use the console test feature to invoke a function, you'll find **Log output** in the **Details** section.

Viewing logs in the CloudWatch console

You can use the Amazon CloudWatch console to view logs for all Lambda function invocations.

To view logs on the CloudWatch console

1. Open the [Log groups page](#) on the CloudWatch console.

2. Choose the log group for your function (`/aws/lambda/your-function-name`).
3. Choose a log stream.

Each log stream corresponds to an [instance of your function](#). A log stream appears when you update your Lambda function, and when additional instances are created to handle multiple concurrent invocations. To find logs for a specific invocation, we recommend instrumenting your function with AWS X-Ray. X-Ray records details about the request and the log stream in the trace.

Viewing logs using the AWS Command Line Interface (AWS CLI)

The AWS CLI is an open-source tool that enables you to interact with AWS services using commands in your command line shell. To complete the steps in this section, you must have the [AWS CLI version 2](#).

You can use the [AWS CLI](#) to retrieve logs for an invocation using the `--log-type` command option. The response contains a `LogResult` field that contains up to 4 KB of base64-encoded logs from the invocation.

Example retrieve a log ID

The following example shows how to retrieve a *log ID* from the `LogResult` field for a function named `my-function`.

```
aws lambda invoke --function-name my-function out --log-type Tail
```

You should see the following output:

```
{
  "StatusCode": 200,
  "LogResult":
  "U1RBU1QgUmVxdWVzdElk0iA4N2QwNDRi0C1mMTU0LTExZTgt0GNkYS0y0Tc0YzVlNGZiMjEgVmVyc2lvb...",
  "ExecutedVersion": "$LATEST"
}
```

Example decode the logs

In the same command prompt, use the `base64` utility to decode the logs. The following example shows how to retrieve base64-encoded logs for `my-function`.

```
aws lambda invoke --function-name my-function out --log-type Tail \
--query 'LogResult' --output text --cli-binary-format raw-in-base64-out | base64 --
decode
```

The **cli-binary-format** option is required if you're using AWS CLI version 2. To make this the default setting, run `aws configure set cli-binary-format raw-in-base64-out`. For more information, see [AWS CLI supported global command line options](#) in the *AWS Command Line Interface User Guide for Version 2*.

You should see the following output:

```
START RequestId: 57f231fb-1730-4395-85cb-4f71bd2b87b8 Version: $LATEST
"AWS_SESSION_TOKEN": "AgoJb3JpZ2luX2VjELj...", "_X_AMZN_TRACE_ID": "Root=1-5d02e5ca-
f5792818b6fe8368e5b51d50;Parent=191db58857df8395;Sampled=0\"",ask/lib:/opt/lib",
END RequestId: 57f231fb-1730-4395-85cb-4f71bd2b87b8
REPORT RequestId: 57f231fb-1730-4395-85cb-4f71bd2b87b8 Duration: 79.67 ms Billed
Duration: 80 ms Memory Size: 128 MB Max Memory Used: 73 MB
```

The `base64` utility is available on Linux, macOS, and [Ubuntu on Windows](#). macOS users may need to use `base64 -D`.

Example `get-logs.sh` script

In the same command prompt, use the following script to download the last five log events. The script uses `sed` to remove quotes from the output file, and sleeps for 15 seconds to allow time for the logs to become available. The output includes the response from Lambda and the output from the `get-log-events` command.

Copy the contents of the following code sample and save in your Lambda project directory as `get-logs.sh`.

The **cli-binary-format** option is required if you're using AWS CLI version 2. To make this the default setting, run `aws configure set cli-binary-format raw-in-base64-out`. For more information, see [AWS CLI supported global command line options](#) in the *AWS Command Line Interface User Guide for Version 2*.

```
#!/bin/bash
aws lambda invoke --function-name my-function --cli-binary-format raw-in-base64-out --
payload '{"key": "value"}' out
sed -i'' -e 's/"//g' out
```

```
sleep 15
aws logs get-log-events --log-group-name /aws/lambda/my-function --log-stream-
name stream1 --limit 5
```

Example macOS and Linux (only)

In the same command prompt, macOS and Linux users may need to run the following command to ensure the script is executable.

```
chmod -R 755 get-logs.sh
```

Example retrieve the last five log events

In the same command prompt, run the following script to get the last five log events.

```
./get-logs.sh
```

You should see the following output:

```
{
  "StatusCode": 200,
  "ExecutedVersion": "$LATEST"
}
{
  "events": [
    {
      "timestamp": 1559763003171,
      "message": "START RequestId: 4ce9340a-b765-490f-ad8a-02ab3415e2bf Version:
$LATEST\n",
      "ingestionTime": 1559763003309
    },
    {
      "timestamp": 1559763003173,
      "message": "2019-06-05T19:30:03.173Z\t4ce9340a-b765-490f-ad8a-02ab3415e2bf
\tINFO\tENVIRONMENT VARIABLES\r{\r  \"AWS_LAMBDA_FUNCTION_VERSION\": \"\n$LATEST\n",
\r ...",
      "ingestionTime": 1559763018353
    },
    {
      "timestamp": 1559763003173,
      "message": "2019-06-05T19:30:03.173Z\t4ce9340a-b765-490f-ad8a-02ab3415e2bf
\tINFO\tEVENT\r{\r  \"key\": \"value\"\r}\n",
```

```
        "ingestionTime": 1559763018353
    },
    {
        "timestamp": 1559763003218,
        "message": "END RequestId: 4ce9340a-b765-490f-ad8a-02ab3415e2bf\n",
        "ingestionTime": 1559763018353
    },
    {
        "timestamp": 1559763003218,
        "message": "REPORT RequestId: 4ce9340a-b765-490f-ad8a-02ab3415e2bf\n",
        "ingestionTime": 1559763018353
    }
],
"nextForwardToken": "f/34783877304859518393868359594929986069206639495374241795",
"nextBackwardToken": "b/34783877303811383369537420289090800615709599058929582080"
}
```

Deleting logs

Log groups aren't deleted automatically when you delete a function. To avoid storing logs indefinitely, delete the log group, or [configure a retention period](#) after which logs are deleted automatically.

Instrumenting Node.js code in AWS Lambda

Lambda integrates with AWS X-Ray to help you trace, debug, and optimize Lambda applications. You can use X-Ray to trace a request as it traverses resources in your application, which may include Lambda functions and other AWS services.

To send tracing data to X-Ray, you can use one of two SDK libraries:

- [AWS Distro for OpenTelemetry \(ADOT\)](#) – A secure, production-ready, AWS-supported distribution of the OpenTelemetry (OTel) SDK.
- [AWS X-Ray SDK for Node.js](#) – An SDK for generating and sending trace data to X-Ray.

Each of the SDKs offer ways to send your telemetry data to the X-Ray service. You can then use X-Ray to view, filter, and gain insights into your application's performance metrics to identify issues and opportunities for optimization.

Important

The X-Ray and Powertools for AWS Lambda SDKs are part of a tightly integrated instrumentation solution offered by AWS. The ADOT Lambda Layers are part of an industry-wide standard for tracing instrumentation that collect more data in general, but may not be suited for all use cases. You can implement end-to-end tracing in X-Ray using either solution. To learn more about choosing between them, see [Choosing between the AWS Distro for Open Telemetry and X-Ray SDKs](#).

Sections

- [Using ADOT to instrument your Node.js functions](#)
- [Using the X-Ray SDK to instrument your Node.js functions](#)
- [Activating tracing with the Lambda console](#)
- [Activating tracing with the Lambda API](#)
- [Activating tracing with AWS CloudFormation](#)
- [Interpreting an X-Ray trace](#)
- [Storing runtime dependencies in a layer \(X-Ray SDK\)](#)

Using ADOT to instrument your Node.js functions

ADOT provides fully managed Lambda [layers](#) that package everything you need to collect telemetry data using the OTel SDK. By consuming this layer, you can instrument your Lambda functions without having to modify any function code. You can also configure your layer to do custom initialization of OTel. For more information, see [Custom configuration for the ADOT Collector on Lambda](#) in the ADOT documentation.

For Node.js runtimes, you can add the **AWS managed Lambda layer for ADOT Javascript** to automatically instrument your functions. For detailed instructions on how to add this layer, see [AWS Distro for OpenTelemetry Lambda Support for JavaScript](#) in the ADOT documentation.

Using the X-Ray SDK to instrument your Node.js functions

To record details about calls that your Lambda function makes to other resources in your application, you can also use the AWS X-Ray SDK for Node.js. To get the SDK, add the `aws-xray-sdk-core` package to your application's dependencies.

Example [blank-nodejs/package.json](#)

```
{
  "name": "blank-nodejs",
  "version": "1.0.0",
  "private": true,
  "devDependencies": {
    "jest": "29.7.0"
  },
  "dependencies": {
    "@aws-sdk/client-lambda": "3.345.0",
    "aws-xray-sdk-core": "3.5.3"
  },
  "scripts": {
    "test": "jest"
  }
}
```

To instrument AWS SDK clients in the [AWS SDK for JavaScript v3](#), wrap the client instance with the `captureAWSSv3Client` method.

Example [blank-nodejs/function/index.js](#) – Tracing an AWS SDK client

```
const AWSXRay = require('aws-xray-sdk-core');
const { LambdaClient, GetAccountSettingsCommand } = require('@aws-sdk/client-lambda');

// Create client outside of handler to reuse
const lambda = AWSXRay.captureAWSv3Client(new LambdaClient());

// Handler
exports.handler = async function(event, context) {
  event.Records.forEach(record => {
    ...
  });
}
```

The Lambda runtime sets some environment variables to configure the X-Ray SDK. For example, Lambda sets `AWS_XRAY_CONTEXT_MISSING` to `LOG_ERROR` to avoid throwing runtime errors from the X-Ray SDK. To set a custom context missing strategy, override the environment variable in your function configuration to have no value, and then you can set the context missing strategy programmatically.

Example Example initialization code

```
const AWSXRay = require('aws-xray-sdk-core');

// Configure the context missing strategy to do nothing
AWSXRay.setContextMissingStrategy(() => {});
```

For more information, see [the section called “Environment variables”](#).

After you add the correct dependencies and make the necessary code changes, activate tracing in your function's configuration via the Lambda console or the API.

Activating tracing with the Lambda console

To toggle active tracing on your Lambda function with the console, follow these steps:

To turn on active tracing

1. Open the [Functions page](#) of the Lambda console.
2. Choose a function.
3. Choose **Configuration** and then choose **Monitoring and operations tools**.
4. Choose **Edit**.

5. Under **X-Ray**, toggle on **Active tracing**.
6. Choose **Save**.

Activating tracing with the Lambda API

Configure tracing on your Lambda function with the AWS CLI or AWS SDK, use the following API operations:

- [UpdateFunctionConfiguration](#)
- [GetFunctionConfiguration](#)
- [CreateFunction](#)

The following example AWS CLI command enables active tracing on a function named **my-function**.

```
aws lambda update-function-configuration --function-name my-function \  
--tracing-config Mode=Active
```

Tracing mode is part of the version-specific configuration when you publish a version of your function. You can't change the tracing mode on a published version.

Activating tracing with AWS CloudFormation

To activate tracing on an `AWS::Lambda::Function` resource in an AWS CloudFormation template, use the `TracingConfig` property.

Example [function-inline.yml](#) – Tracing configuration

```
Resources:  
  function:  
    Type: AWS::Lambda::Function  
    Properties:  
      TracingConfig:  
        Mode: Active  
      ...
```

For an AWS Serverless Application Model (AWS SAM) `AWS::Serverless::Function` resource, use the `Tracing` property.

Example [template.yml](#) – Tracing configuration

```
Resources:
  function:
    Type: AWS::Serverless::Function
    Properties:
      Tracing: Active
      ...
```

Interpreting an X-Ray trace

Your function needs permission to upload trace data to X-Ray. When you activate tracing in the Lambda console, Lambda adds the required permissions to your function's [execution role](#). Otherwise, add the [AWSXRayDaemonWriteAccess](#) policy to the execution role.

After you've configured active tracing, you can observe specific requests through your application. The [X-Ray service graph](#) shows information about your application and all its components. The following example shows an application with two functions. The primary function processes events and sometimes returns errors. The second function at the top processes errors that appear in the first's log group and uses the AWS SDK to call X-Ray, Amazon Simple Storage Service (Amazon S3), and Amazon CloudWatch Logs.



X-Ray doesn't trace all requests to your application. X-Ray applies a sampling algorithm to ensure that tracing is efficient, while still providing a representative sample of all requests. The sampling rate is 1 request per second and 5 percent of additional requests. You can't configure the X-Ray sampling rate for your functions.

In X-Ray, a *trace* records information about a request that is processed by one or more *services*. Lambda records 2 segments per trace, which creates two nodes on the service graph. The following image highlights these two nodes:

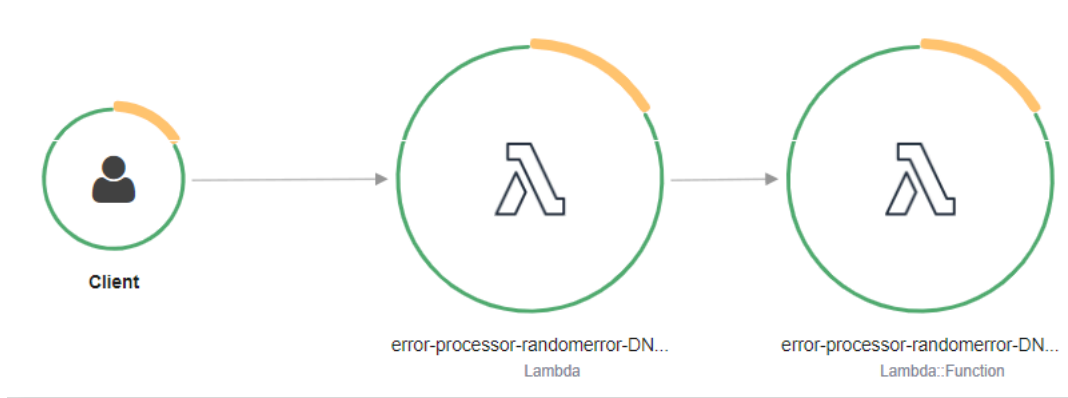

The first node on the left represents the Lambda service, which receives the invocation request. The second node represents your specific Lambda function. The following example shows a trace with these two segments. Both are named **my-function**, but one has an origin of `AWS::Lambda` and the other has an origin of `AWS::Lambda::Function`. If the `AWS::Lambda` segment shows an error, the Lambda service had an issue. If the `AWS::Lambda::Function` segment shows an error, your function had an issue.

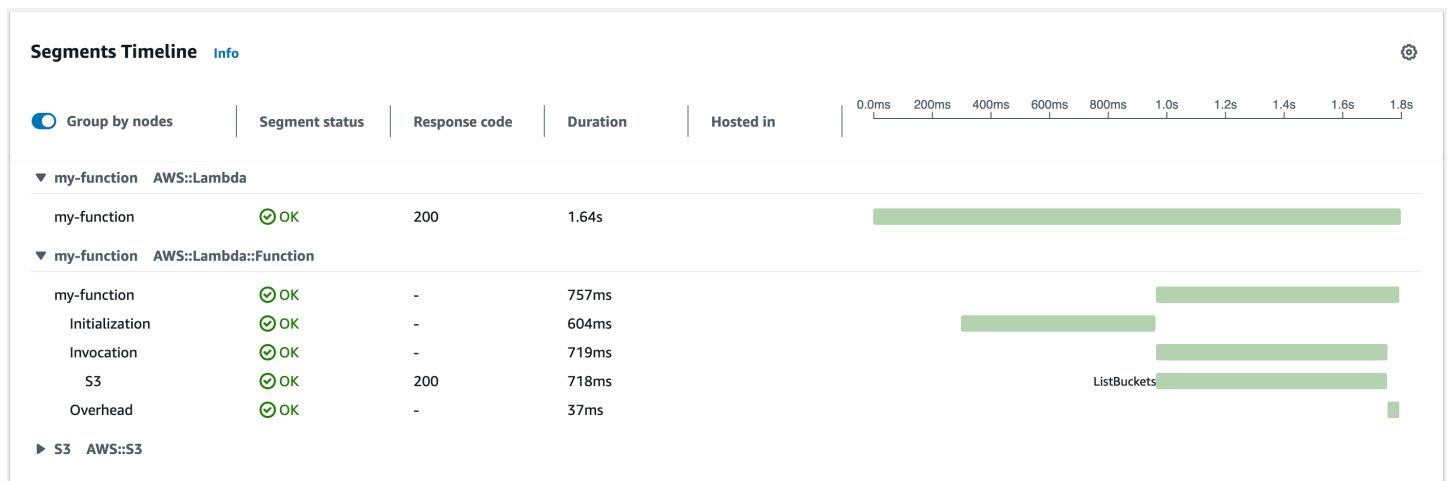

This example expands the `AWS::Lambda::Function` segment to show its three subsegments.

Note

AWS is currently implementing changes to the Lambda service. Due to these changes, you may see minor differences between the structure and content of system log messages and trace segments emitted by different Lambda functions in your AWS account.

The example trace shown here illustrates the old-style function segment. The differences between the old- and new-style segments are described in the following paragraphs. These changes will be implemented during the coming weeks, and all functions in all AWS Regions except the China and GovCloud regions will transition to use the new-format log messages and trace segments.

The old-style function segment contains the following subsegments:

- **Initialization** – Represents time spent loading your function and running [initialization code](#). This subsegment only appears for the first event that each instance of your function processes.
- **Invocation** – Represents the time spent running your handler code.
- **Overhead** – Represents the time the Lambda runtime spends preparing to handle the next event.

The new-style function segment doesn't contain an Invocation subsegment. Instead, customer subsegments are attached directly to the function segment. For more information about the structure of the old- and new-style function segments, see [the section called “Understanding X-Ray traces”](#).

You can also instrument HTTP clients, record SQL queries, and create custom subsegments with annotations and metadata. For more information, see the [AWS X-Ray SDK for Node.js](#) in the *AWS X-Ray Developer Guide*.

Pricing

You can use X-Ray tracing for free each month up to a certain limit as part of the AWS Free Tier. Beyond that threshold, X-Ray charges for trace storage and retrieval. For more information, see [AWS X-Ray pricing](#).

Storing runtime dependencies in a layer (X-Ray SDK)

If you use the X-Ray SDK to instrument AWS SDK clients your function code, your deployment package can become quite large. To avoid uploading runtime dependencies every time you update your function code, package the X-Ray SDK in a [Lambda layer](#).

The following example shows an `AWS::Serverless::LayerVersion` resource that stores the AWS X-Ray SDK for Node.js.

Example [template.yml](#) – Dependencies layer

```
Resources:
  function:
    Type: AWS::Serverless::Function
    Properties:
      CodeUri: function/.
      Tracing: Active
      Layers:
        - !Ref libs
        ...
  libs:
    Type: AWS::Serverless::LayerVersion
    Properties:
      LayerName: blank-nodejs-lib
      Description: Dependencies for the blank sample app.
      ContentUri: lib/.
      CompatibleRuntimes:
        - nodejs20.x
```

With this configuration, you update the library layer only if you change your runtime dependencies. Since the function deployment package contains only your code, this can help reduce upload times.

Creating a layer for dependencies requires build changes to generate the layer archive prior to deployment. For a working example, see the [blank-nodejs](#) sample application.

Building Lambda functions with TypeScript

You can use the Node.js runtime to run TypeScript code in AWS Lambda. Because Node.js doesn't run TypeScript code natively, you must first transpile your TypeScript code into JavaScript. Then, use the JavaScript files to deploy your function code to Lambda. Your code runs in an environment that includes the AWS SDK for JavaScript, with credentials from an AWS Identity and Access Management (IAM) role that you manage. To learn more about the SDK versions included with the Node.js runtimes, see [the section called "Runtime-included SDK versions"](#).

Lambda supports the following Node.js runtimes.

Name	Identifier	Operating system	Deprecation date	Block function create	Block function update
Node.js 22	nodejs22.x	Amazon Linux 2023	Not scheduled	Not scheduled	Not scheduled
Node.js 20	nodejs20.x	Amazon Linux 2023	Not scheduled	Not scheduled	Not scheduled
Node.js 18	nodejs18.x	Amazon Linux 2	Jul 31, 2025	Sep 1, 2025	Oct 1, 2025

Topics

- [Setting up a TypeScript development environment](#)
- [Define Lambda function handler in TypeScript](#)
- [Deploy transpiled TypeScript code in Lambda with .zip file archives](#)
- [Deploy transpiled TypeScript code in Lambda with container images](#)
- [Working with layers for TypeScript Lambda functions](#)
- [Using the Lambda context object to retrieve TypeScript function information](#)
- [Log and monitor TypeScript Lambda functions](#)
- [Tracing TypeScript code in AWS Lambda](#)

Setting up a TypeScript development environment

Use a local integrated development environment (IDE), text editor, or [AWS Cloud9](#) to write your TypeScript function code. You can't create TypeScript code on the Lambda console.

To transpile your TypeScript code, set up a compiler such as [esbuild](#) or Microsoft's TypeScript compiler (tsc), which is bundled with the [TypeScript distribution](#). You can use the [AWS Serverless Application Model \(AWS SAM\)](#) or the [AWS Cloud Development Kit \(AWS CDK\)](#) to simplify building and deploying TypeScript code. Both tools use esbuild to transpile TypeScript code into JavaScript.

When using esbuild, consider the following:

- There are several [TypeScript caveats](#).
- You must configure your TypeScript transpilation settings to match the Node.js runtime that you plan to use. For more information, see [Target](#) in the esbuild documentation. For an example of a **tsconfig.json** file that demonstrates how to target a specific Node.js version supported by Lambda, refer to the [TypeScript GitHub repository](#).
- esbuild doesn't perform type checks. To check types, use the tsc compiler. Run `tsc -noEmit` or add a "noEmit" parameter to your **tsconfig.json** file, as shown in the following example. This configures tsc to not emit JavaScript files. After checking types, use esbuild to convert the TypeScript files into JavaScript.

Example tsconfig.json

```
{
  "compilerOptions": {
    "target": "es2020",
    "strict": true,
    "preserveConstEnums": true,
    "noEmit": true,
    "sourceMap": false,
    "module": "commonjs",
    "moduleResolution": "node",
    "esModuleInterop": true,
    "skipLibCheck": true,
    "forceConsistentCasingInFileNames": true,
    "isolatedModules": true,
  },
  "exclude": ["node_modules", "**/*.test.ts"]
}
```

```
}
```

Define Lambda function handler in TypeScript

The Lambda function *handler* is the method in your function code that processes events. When your function is invoked, Lambda runs the handler method. Your function runs until the handler returns a response, exits, or times out.

Topics

- [Typescript handler basics](#)
- [Using async/await](#)
- [Using callbacks](#)
- [Using types for the event object](#)
- [Code best practices for Typescript Lambda functions](#)

Typescript handler basics

Example TypeScript handler

This example function logs the contents of the event object and returns the location of the logs. Note the following:

- Before using this code in a Lambda function, you must add the [@types/aws-lambda](#) package as a development dependency. This package contains the type definitions for Lambda. When [@types/aws-lambda](#) is installed, the `import ... from 'aws-lambda'` imports the type definitions. It does not import the `aws-lambda` NPM package, which is an unrelated third-party tool. For more information, see [aws-lambda](#) in the DefinitelyTyped GitHub repository.
- The handler in this example is an ES module and must be designated as such in your `package.json` file or by using the `.mjs` file extension. For more information, see see [Designating a function handler as an ES module](#).

```
import { Handler } from 'aws-lambda';

export const handler: Handler = async (event, context) => {
  console.log('EVENT: \n' + JSON.stringify(event, null, 2));
  return context.logStreamName;
};
```

The runtime passes arguments to the handler method. The first argument is the event object, which contains information from the invoker. The invoker passes this information as a JSON-formatted string when it calls [Invoke](#), and the runtime converts it to an object. When an AWS service invokes your function, the event structure [varies by service](#). With TypeScript, we recommend using type annotations for the event object. For more information, see [Using types for the event object](#).

The second argument is the [context object](#), which contains information about the invocation, function, and execution environment. In the preceding example, the function gets the name of the [log stream](#) from the context object and returns it to the invoker.

You can also use a callback argument, which is a function that you can call in non-async handlers to send a response. We recommend that you use `async/await` instead of callbacks. `Async/await` provides improved readability, error handling, and efficiency. For more information about the differences between `async/await` and callbacks, see [Using callbacks](#).

Using `async/await`

If your code performs an asynchronous task, use the `async/await` pattern to make sure that the handler finishes running. `Async/await` is a concise and readable way to write asynchronous code in Node.js, without the need for nested callbacks or chaining promises. With `async/await`, you can write code that reads like synchronous code, while still being asynchronous and non-blocking.

The `async` keyword marks a function as asynchronous, and the `await` keyword pauses the execution of the function until a `Promise` is resolved.

Example TypeScript function – asynchronous

This example uses `fetch`, which is available in the `nodejs18.x` runtime. Note the following:

- Before using this code in a Lambda function, you must add the [@types/aws-lambda](#) package as a development dependency. This package contains the type definitions for Lambda. When `@types/aws-lambda` is installed, the `import` statement (`import ... from 'aws-lambda'`) imports the type definitions. It does not import the `aws-lambda` NPM package, which is an unrelated third-party tool. For more information, see [aws-lambda](#) in the DefinitelyTyped GitHub repository.
- The handler in this example is an ES module and must be designated as such in your `package.json` file or by using the `.mjs` file extension. For more information, see [Designating a function handler as an ES module](#).

```
import { APIGatewayProxyEvent, APIGatewayProxyResult } from 'aws-lambda';
const url = 'https://aws.amazon.com/';
export const lambdaHandler = async (event: APIGatewayProxyEvent):
  Promise<APIGatewayProxyResult> => {
  try {
    // fetch is available with Node.js 18
    const res = await fetch(url);
    return {
      statusCode: res.status,
      body: JSON.stringify({
        message: await res.text(),
      }),
    };
  } catch (err) {
    console.log(err);
    return {
      statusCode: 500,
      body: JSON.stringify({
        message: 'some error happened',
      }),
    };
  }
};
```

Using callbacks

We recommend that you use [async/await](#) to declare the function handler instead of using callbacks. Async/await is a better choice for several reasons:

- **Readability:** Async/await code is easier to read and understand than callback code, which can quickly become difficult to follow and result in callback hell.
- **Debugging and error handling:** Debugging callback-based code can be difficult. The call stack can become hard to follow and errors can easily be swallowed. With async/await, you can use try/catch blocks to handle errors.
- **Efficiency:** Callbacks often require switching between different parts of the code. Async/await can reduce the number of context switches, resulting in more efficient code.

When you use callbacks in your handler, the function continues to execute until the [event loop](#) is empty or the function times out. The response isn't sent to the invoker until all event loop tasks are

finished. If the function times out, an error is returned instead. You can configure the runtime to send the response immediately by setting [context.callbackWaitsForEmptyEventLoop](#) to false.

The callback function takes two arguments: an `Error` and a response. The response object must be compatible with `JSON.stringify`.

Example TypeScript function with callback

This sample function receives an event from Amazon API Gateway, logs the event and context objects, and then returns a response to API Gateway. Note the following:

- Before using this code in a Lambda function, you must add the [@types/aws-lambda](#) package as a development dependency. This package contains the type definitions for Lambda. When `@types/aws-lambda` is installed, the `import` statement (`import ... from 'aws-lambda'`) imports the type definitions. It does not import the `aws-lambda` NPM package, which is an unrelated third-party tool. For more information, see [aws-lambda](#) in the DefinitelyTyped GitHub repository.
- The handler in this example is an ES module and must be designated as such in your `package.json` file or by using the `.mjs` file extension. For more information, see [Designating a function handler as an ES module](#).

```
import { Context, APIGatewayProxyCallback, APIGatewayEvent } from 'aws-lambda';

export const lambdaHandler = (event: APIGatewayEvent, context: Context, callback:
  APIGatewayProxyCallback): void => {
  console.log(`Event: ${JSON.stringify(event, null, 2)}`);
  console.log(`Context: ${JSON.stringify(context, null, 2)}`);
  callback(null, {
    statusCode: 200,
    body: JSON.stringify({
      message: 'hello world',
    }),
  });
};
```

Using types for the event object

We recommend that you don't use the [any](#) type for the handler arguments and return type because you lose the ability to check types. Instead, generate an event using the [sam local generate-](#)

[event](#) AWS Serverless Application Model CLI command, or use an open-source definition from the [@types/aws-lambda package](#).

Generating an event using the `sam local generate-event` command

1. Generate an Amazon Simple Storage Service (Amazon S3) proxy event.

```
sam local generate-event s3 put >> S3PutEvent.json
```

2. Use the [quicktype utility](#) to generate type definitions from the `S3PutEvent.json` file.

```
npm install -g quicktype
quicktype S3PutEvent.json -o S3PutEvent.ts
```

3. Use the generated types in your code.

```
import { S3PutEvent } from './S3PutEvent';

export const lambdaHandler = async (event: S3PutEvent): Promise<void> => {
  event.Records.map((record) => console.log(record.s3.object.key));
};
```

Generating an event using an open-source definition from the `@types/aws-lambda` package

1. Add the [@types/aws-lambda](#) package as a development dependency.

```
npm install -D @types/aws-lambda
```

2. Use the types in your code.

```
import { S3Event } from "aws-lambda";

export const lambdaHandler = async (event: S3Event): Promise<void> => {
  event.Records.map((record) => console.log(record.s3.object.key));
};
```

Code best practices for Typescript Lambda functions

Adhere to the guidelines in the following list to use best coding practices when building your Lambda functions:

- **Separate the Lambda handler from your core logic.** This allows you to make a more unit-testable function. In Node.js this may look like:

```
exports.myHandler = function(event, context, callback) {
  var foo = event.foo;
  var bar = event.bar;
  var result = MyLambdaFunction (foo, bar);

  callback(null, result);
}

function MyLambdaFunction (foo, bar) {
  // MyLambdaFunction logic here
}
```

- **Control the dependencies in your function's deployment package.** The AWS Lambda execution environment contains a number of libraries. For the Node.js and Python runtimes, these include the AWS SDKs. To enable the latest set of features and security updates, Lambda will periodically update these libraries. These updates may introduce subtle changes to the behavior of your Lambda function. To have full control of the dependencies your function uses, package all of your dependencies with your deployment package.
- **Minimize the complexity of your dependencies.** Prefer simpler frameworks that load quickly on [execution environment](#) startup.
- **Minimize your deployment package size to its runtime necessities.** This will reduce the amount of time that it takes for your deployment package to be downloaded and unpacked ahead of invocation.
- **Take advantage of execution environment reuse to improve the performance of your function.** Initialize SDK clients and database connections outside of the function handler, and cache static assets locally in the `/tmp` directory. Subsequent invocations processed by the same instance of your function can reuse these resources. This saves cost by reducing function run time.

To avoid potential data leaks across invocations, don't use the execution environment to store user data, events, or other information with security implications. If your function relies on a mutable state that can't be stored in memory within the handler, consider creating a separate function or separate versions of a function for each user.

- **Use a keep-alive directive to maintain persistent connections.** Lambda purges idle connections over time. Attempting to reuse an idle connection when invoking a function will result in a connection error. To maintain your persistent connection, use the keep-alive directive associated with your runtime. For an example, see [Reusing Connections with Keep-Alive in Node.js](#).
- **Use [environment variables](#) to pass operational parameters to your function.** For example, if you are writing to an Amazon S3 bucket, instead of hard-coding the bucket name you are writing to, configure the bucket name as an environment variable.
- **Avoid using recursive invocations** in your Lambda function, where the function invokes itself or initiates a process that may invoke the function again. This could lead to unintended volume of function invocations and escalated costs. If you see an unintended volume of invocations, set the function reserved concurrency to 0 immediately to throttle all invocations to the function, while you update the code.
- **Do not use non-documented, non-public APIs** in your Lambda function code. For AWS Lambda managed runtimes, Lambda periodically applies security and functional updates to Lambda's internal APIs. These internal API updates may be backwards-incompatible, leading to unintended consequences such as invocation failures if your function has a dependency on these non-public APIs. See [the API reference](#) for a list of publicly available APIs.
- **Write idempotent code.** Writing idempotent code for your functions ensures that duplicate events are handled the same way. Your code should properly validate events and gracefully handle duplicate events. For more information, see [How do I make my Lambda function idempotent?](#).

Deploy transpiled TypeScript code in Lambda with .zip file archives

Before you can deploy TypeScript code to AWS Lambda, you need to transpile it into JavaScript. This page explains three ways to build and deploy TypeScript code to Lambda with .zip file archives:

- [Using AWS Serverless Application Model \(AWS SAM\)](#)
- [Using the AWS Cloud Development Kit \(AWS CDK\)](#)
- [Using the AWS Command Line Interface \(AWS CLI\) and esbuild](#)

AWS SAM and AWS CDK simplify building and deploying TypeScript functions. The [AWS SAM template specification](#) provides a simple and clean syntax to describe the Lambda functions, APIs, permissions, configurations, and events that make up your serverless application. The [AWS CDK](#) lets you build reliable, scalable, cost-effective applications in the cloud with the considerable expressive power of a programming language. The AWS CDK is intended for moderately to highly experienced AWS users. Both the AWS CDK and the AWS SAM use esbuild to transpile TypeScript code into JavaScript.

Using AWS SAM to deploy TypeScript code to Lambda

Follow the steps below to download, build, and deploy a sample Hello World TypeScript application using the AWS SAM. This application implements a basic API backend. It consists of an Amazon API Gateway endpoint and a Lambda function. When you send a GET request to the API Gateway endpoint, the Lambda function is invoked. The function returns a `hello world` message.

Note

AWS SAM uses esbuild to create Node.js Lambda functions from TypeScript code. esbuild support is currently in public preview. During public preview, esbuild support may be subject to backwards incompatible changes.

Prerequisites

To complete the steps in this section, you must have the following:

- [AWS CLI version 2](#)
- [AWS SAM CLI version 1.75 or later](#)
- Node.js 18.x

Deploy a sample AWS SAM application

1. Initialize the application using the Hello World TypeScript template.

```
sam init --app-template hello-world-typescript --name sam-app --package-type Zip --runtime nodejs18.x
```

2. (Optional) The sample application includes configurations for commonly used tools, such as [ESLint](#) for code linting and [Jest](#) for unit testing. To run lint and test commands:

```
cd sam-app/hello-world
npm install
npm run lint
npm run test
```

3. Build the app.

```
cd sam-app
sam build
```

4. Deploy the app.

```
sam deploy --guided
```

5. Follow the on-screen prompts. To accept the default options provided in the interactive experience, respond with Enter.
6. The output shows the endpoint for the REST API. Open the endpoint in a browser to test the function. You should see this response:

```
{"message":"hello world"}
```

7. This is a public API endpoint that is accessible over the internet. We recommend that you delete the endpoint after testing.

```
sam delete
```

Using the AWS CDK to deploy TypeScript code to Lambda

Follow the steps below to build and deploy a sample TypeScript application using the AWS CDK. This application implements a basic API backend. It consists of an API Gateway endpoint and a Lambda function. When you send a GET request to the API Gateway endpoint, the Lambda function is invoked. The function returns a `hello world` message.

Prerequisites

To complete the steps in this section, you must have the following:

- [AWS CLI version 2](#)
- [AWS CDK version 2](#)
- Node.js 18.x
- Either [Docker](#) or [esbuild](#)

Deploy a sample AWS CDK application

1. Create a project directory for your new application.

```
mkdir hello-world
cd hello-world
```

2. Initialize the app.

```
cdk init app --language typescript
```

3. Add the [@types/aws-lambda](#) package as a development dependency. This package contains the type definitions for Lambda.

```
npm install -D @types/aws-lambda
```

4. Open the `lib` directory. You should see a file called `hello-world-stack.ts`. Create two new files in this directory: `hello-world.function.ts` and `hello-world.ts`.
5. Open `hello-world.function.ts` and add the following code to the file. This is the code for the Lambda function.

Note

The import statement imports the type definitions from [@types/aws-lambda](#). It does not import the `aws-lambda` NPM package, which is an unrelated third-party tool. For more information, see [aws-lambda](#) in the DefinitelyTyped GitHub repository.

```
import { Context, APIGatewayProxyResult, APIGatewayEvent } from 'aws-lambda';

export const handler = async (event: APIGatewayEvent, context: Context):
  Promise<APIGatewayProxyResult> => {
  console.log(`Event: ${JSON.stringify(event, null, 2)}`);
  console.log(`Context: ${JSON.stringify(context, null, 2)}`);
  return {
    statusCode: 200,
    body: JSON.stringify({
      message: 'hello world',
    }),
  };
};
```

6. Open **hello-world.ts** and add the following code to the file. This contains the [NodejsFunction construct](#), which creates the Lambda function, and the [LambdaRestApi construct](#), which creates the REST API.

```
import { Construct } from 'constructs';
import { NodejsFunction } from 'aws-cdk-lib/aws-lambda-nodejs';
import { LambdaRestApi } from 'aws-cdk-lib/aws-apigateway';

export class HelloWorld extends Construct {
  constructor(scope: Construct, id: string) {
    super(scope, id);
    const helloFunction = new NodejsFunction(this, 'function');
    new LambdaRestApi(this, 'apigw', {
      handler: helloFunction,
    });
  }
}
```

The `NodejsFunction` construct assumes the following by default:

- Your function handler is called `handler`.
- The `.ts` file that contains the function code (**hello-world.function.ts**) is in the same directory as the `.ts` file that contains the construct (**hello-world.ts**). The construct uses the construct's ID ("hello-world") and the name of the Lambda handler file ("function") to find the function code. For example, if your function code is in a file called **hello-world.my-function.ts**, the **hello-world.ts** file must reference the function code like this:

```
const helloFunction = new NodejsFunction(this, 'my-function');
```

You can change this behavior and configure other esbuild parameters. For more information, see [Configuring esbuild](#) in the AWS CDK API reference.

7. Open **hello-world-stack.ts**. This is the code that defines your [AWS CDK stack](#). Replace the code with the following:

```
import { Stack, StackProps } from 'aws-cdk-lib';
import { Construct } from 'constructs';
import { HelloWorld } from './hello-world';

export class HelloWorldStack extends Stack {
  constructor(scope: Construct, id: string, props?: StackProps) {
    super(scope, id, props);
    new HelloWorld(this, 'hello-world');
  }
}
```

8. from the `hello-world` directory containing your `cdk.json` file, deploy your application.

```
cdk deploy
```

9. The AWS CDK builds and packages the Lambda function using esbuild, and then deploys the function to the Lambda runtime. The output shows the endpoint for the REST API. Open the endpoint in a browser to test the function. You should see this response:

```
{"message":"hello world"}
```

This is a public API endpoint that is accessible over the internet. We recommend that you delete the endpoint after testing.

Using the AWS CLI and esbuild to deploy TypeScript code to Lambda

The following example demonstrates how to transpile and deploy TypeScript code to Lambda using esbuild and the AWS CLI. esbuild produces one JavaScript file with all dependencies. This is the only file that you need to add to the .zip archive.

Prerequisites

To complete the steps in this section, you must have the following:

- [AWS CLI version 2](#)
- Node.js 18.x
- An [execution role](#) for the Lambda function
- For Windows users, a zip file utility such as [7zip](#).

Deploy a sample function

1. On your local machine, create a project directory for your new function.
2. Create a new Node.js project with npm or a package manager of your choice.

```
npm init
```

3. Add the [@types/aws-lambda](#) and [esbuild](#) packages as development dependencies. The [@types/aws-lambda](#) package contains the type definitions for Lambda.

```
npm install -D @types/aws-lambda esbuild
```

4. Create a new file called **index.ts**. Add the following code to the new file. This is the code for the Lambda function. The function returns a `hello world` message. The function doesn't create any API Gateway resources.

Note

The `import` statement imports the type definitions from [@types/aws-lambda](#). It does not import the `aws-lambda` NPM package, which is an unrelated third-party tool. For more information, see [aws-lambda](#) in the DefinitelyTyped GitHub repository.

```
import { Context, APIGatewayProxyResult, APIGatewayEvent } from 'aws-lambda';

export const handler = async (event: APIGatewayEvent, context: Context):
Promise<APIGatewayProxyResult> => {
  console.log(`Event: ${JSON.stringify(event, null, 2)}`);
  console.log(`Context: ${JSON.stringify(context, null, 2)}`);
  return {
    statusCode: 200,
    body: JSON.stringify({
      message: 'hello world',
    }),
  };
};
```

5. Add a build script to the **package.json** file. This configures esbuild to automatically create the .zip deployment package. For more information, see [Build scripts](#) in the esbuild documentation.

Linux and MacOS

```
"scripts": {
  "prebuild": "rm -rf dist",
  "build": "esbuild index.ts --bundle --minify --sourcemap --platform=node --
target=es2020 --outfile=dist/index.js",
  "postbuild": "cd dist && zip -r index.zip index.js*"
},
```

Windows

In this example, the "postbuild" command uses the [7zip](#) utility to create your .zip file. Use your own preferred Windows zip utility and modify the command as necessary.

```
"scripts": {
  "prebuild": "del /q dist",
  "build": "esbuild index.ts --bundle --minify --sourcemap --platform=node --
target=es2020 --outfile=dist/index.js",
  "postbuild": "cd dist && 7z a -tzip index.zip index.js*"
},
```

6. Build the package.

```
npm run build
```

7. Create a Lambda function using the .zip deployment package. Replace the highlighted text with the Amazon Resource Name (ARN) of your [execution role](#).

```
aws lambda create-function --function-name hello-world --runtime "nodejs18.x" --  
role arn:aws:iam::123456789012:role/lambda-ex --zip-file "fileb://dist/index.zip"  
--handler index.handler
```

8. [Run a test event](#) to confirm that the function returns the following response. If you want to invoke this function using API Gateway, [create and configure a REST API](#).

```
{  
  "statusCode": 200,  
  "body": "{\"message\":\"hello world\"}"  
}
```

Deploy transpiled TypeScript code in Lambda with container images

You can deploy your TypeScript code to an AWS Lambda function as a Node.js [container image](#). AWS provides [base images](#) for Node.js to help you build the container image. These base images are preloaded with a language runtime and other components that are required to run the image on Lambda. AWS provides a Dockerfile for each of the base images to help with building your container image.

If you use a community or private enterprise base image, you must [add the Node.js runtime interface client \(RIC\)](#) to the base image to make it compatible with Lambda.

Lambda provides a runtime interface emulator for local testing. The AWS base images for Node.js include the runtime interface emulator. If you use an alternative base image, such as an Alpine Linux or Debian image, you can [build the emulator into your image](#) or [install it on your local machine](#).

Using a Node.js base image to build and package TypeScript function code

Prerequisites

To complete the steps in this section, you must have the following:

- [AWS CLI version 2](#)
- [Docker](#)
- Node.js 22.x

Creating an image from a base image

To create an image from an AWS base image for Lambda

1. On your local machine, create a project directory for your new function.
2. Create a new Node.js project with npm or a package manager of your choice.

```
npm init
```

3. Add the [@types/aws-lambda](#) and [esbuild](#) packages as development dependencies. The [@types/aws-lambda](#) package contains the type definitions for Lambda.

```
npm install -D @types/aws-lambda esbuild
```

4. Add a [build script](#) to the `package.json` file.

```
"scripts": {  
  "build": "esbuild index.ts --bundle --minify --sourcemap --platform=node --  
target=es2020 --outfile=dist/index.js"  
}
```

5. Create a new file called `index.ts`. Add the following sample code to the new file. This is the code for the Lambda function. The function returns a `hello world` message.

Note

The `import` statement imports the type definitions from [@types/aws-lambda](#). It does not import the `aws-lambda` NPM package, which is an unrelated third-party tool. For more information, see [aws-lambda](#) in the DefinitelyTyped GitHub repository.

```
import { Context, APIGatewayProxyResult, APIGatewayEvent } from 'aws-lambda';  
  
export const handler = async (event: APIGatewayEvent, context: Context):  
  Promise<APIGatewayProxyResult> => {  
  console.log(`Event: ${JSON.stringify(event, null, 2)}`);  
  console.log(`Context: ${JSON.stringify(context, null, 2)}`);  
  return {  
    statusCode: 200,  
    body: JSON.stringify({  
      message: 'hello world',  
    }),  
  };  
};
```

6. Create a new Dockerfile with the following configuration:
 - Set the `FROM` property to the URI of the base image.
 - Set the `CMD` argument to specify the Lambda function handler.

The following example Dockerfile uses a multi-stage build. The first step transpiles the TypeScript code into JavaScript. The second step produces a container image that contains only JavaScript files and production dependencies.

Note that the example Dockerfile does not include a [USER instruction](#). When you deploy a container image to Lambda, Lambda automatically defines a default Linux user with least-privileged permissions. This is different from standard Docker behavior which defaults to the root user when no USER instruction is provided.

Example Dockerfile

```
FROM public.ecr.aws/lambda/nodejs:22 as builder
WORKDIR /usr/app
COPY package.json index.ts ./
RUN npm install
RUN npm run build

FROM public.ecr.aws/lambda/nodejs:22
WORKDIR ${LAMBDA_TASK_ROOT}
COPY --from=builder /usr/app/dist/* ./
CMD ["index.handler"]
```

7. Build the Docker image with the [docker build](#) command. The following example names the image `docker-image` and gives it the test [tag](#).

```
docker build --platform linux/amd64 -t docker-image:test .
```

Note

The command specifies the `--platform linux/amd64` option to ensure that your container is compatible with the Lambda execution environment regardless of the architecture of your build machine. If you intend to create a Lambda function using the ARM64 instruction set architecture, be sure to change the command to use the `--platform linux/arm64` option instead.

(Optional) Test the image locally

1. Start the Docker image with the **docker run** command. In this example, `docker-image` is the image name and `test` is the tag.

```
docker run --platform linux/amd64 -p 9000:8080 docker-image:test
```

This command runs the image as a container and creates a local endpoint at `localhost:9000/2015-03-31/functions/function/invocations`.

Note

If you built the Docker image for the ARM64 instruction set architecture, be sure to use the `--platform linux/arm64` option instead of `--platform linux/amd64`.

2. From a new terminal window, post an event to the local endpoint.

Linux/macOS

In Linux and macOS, run the following `curl` command:

```
curl "http://localhost:9000/2015-03-31/functions/function/invocations" -d '{}'
```

This command invokes the function with an empty event and returns a response. If you're using your own function code rather than the sample function code, you might want to invoke the function with a JSON payload. Example:

```
curl "http://localhost:9000/2015-03-31/functions/function/invocations" -d  
'{"payload":"hello world!"}'
```

PowerShell

In PowerShell, run the following `Invoke-WebRequest` command:

```
Invoke-WebRequest -Uri "http://localhost:9000/2015-03-31/functions/function/  
invocations" -Method Post -Body '{}' -ContentType "application/json"
```

This command invokes the function with an empty event and returns a response. If you're using your own function code rather than the sample function code, you might want to invoke the function with a JSON payload. Example:

```
Invoke-WebRequest -Uri "http://localhost:9000/2015-03-31/functions/function/invocations" -Method Post -Body '{"payload":"hello world!"}' -ContentType "application/json"
```

3. Get the container ID.

```
docker ps
```

4. Use the [docker kill](#) command to stop the container. In this command, replace 3766c4ab331c with the container ID from the previous step.

```
docker kill 3766c4ab331c
```

Deploying the image

To upload the image to Amazon ECR and create the Lambda function

1. Run the [get-login-password](#) command to authenticate the Docker CLI to your Amazon ECR registry.
 - Set the `--region` value to the AWS Region where you want to create the Amazon ECR repository.
 - Replace 111122223333 with your AWS account ID.

```
aws ecr get-login-password --region us-east-1 | docker login --username AWS --password-stdin 111122223333.dkr.ecr.us-east-1.amazonaws.com
```

2. Create a repository in Amazon ECR using the [create-repository](#) command.

```
aws ecr create-repository --repository-name hello-world --region us-east-1 --image-scanning-configuration scanOnPush=true --image-tag-mutability MUTABLE
```

Note

The Amazon ECR repository must be in the same AWS Region as the Lambda function.

If successful, you see a response like this:

```
{
  "repository": {
    "repositoryArn": "arn:aws:ecr:us-east-1:111122223333:repository/hello-world",
    "registryId": "111122223333",
    "repositoryName": "hello-world",
    "repositoryUri": "111122223333.dkr.ecr.us-east-1.amazonaws.com/hello-world",
    "createdAt": "2023-03-09T10:39:01+00:00",
    "imageTagMutability": "MUTABLE",
    "imageScanningConfiguration": {
      "scanOnPush": true
    },
    "encryptionConfiguration": {
      "encryptionType": "AES256"
    }
  }
}
```

3. Copy the `repositoryUri` from the output in the previous step.
4. Run the [docker tag](#) command to tag your local image into your Amazon ECR repository as the latest version. In this command:
 - `docker-image:test` is the name and [tag](#) of your Docker image. This is the image name and tag that you specified in the `docker build` command.
 - Replace `<ECRrepositoryUri>` with the `repositoryUri` that you copied. Make sure to include `:latest` at the end of the URI.

```
docker tag docker-image:test <ECRrepositoryUri>:latest
```

Example:

```
docker tag docker-image:test 111122223333.dkr.ecr.us-east-1.amazonaws.com/hello-world:latest
```

5. Run the [docker push](#) command to deploy your local image to the Amazon ECR repository. Make sure to include `:latest` at the end of the repository URI.

```
docker push 111122223333.dkr.ecr.us-east-1.amazonaws.com/hello-world:latest
```

6. [Create an execution role](#) for the function, if you don't already have one. You need the Amazon Resource Name (ARN) of the role in the next step.
7. Create the Lambda function. For `ImageUri`, specify the repository URI from earlier. Make sure to include `:latest` at the end of the URI.

```
aws lambda create-function \  
  --function-name hello-world \  
  --package-type Image \  
  --code ImageUri=111122223333.dkr.ecr.us-east-1.amazonaws.com/hello-world:latest \  
  --role arn:aws:iam::111122223333:role/lambda-ex
```

Note

You can create a function using an image in a different AWS account, as long as the image is in the same Region as the Lambda function. For more information, see [Amazon ECR cross-account permissions](#).

8. Invoke the function.

```
aws lambda invoke --function-name hello-world response.json
```

You should see a response like this:

```
{  
  "ExecutedVersion": "$LATEST",  
  "StatusCode": 200  
}
```

9. To see the output of the function, check the `response.json` file.

To update the function code, you must build the image again, upload the new image to the Amazon ECR repository, and then use the [update-function-code](#) command to deploy the image to the Lambda function.

Lambda resolves the image tag to a specific image digest. This means that if you point the image tag that was used to deploy the function to a new image in Amazon ECR, Lambda doesn't automatically update the function to use the new image.

To deploy the new image to the same Lambda function, you must use the [update-function-code](#) command, even if the image tag in Amazon ECR remains the same. In the following example, the `--publish` option creates a new version of the function using the updated container image.

```
aws lambda update-function-code \  
  --function-name hello-world \  
  --image-uri 111122223333.dkr.ecr.us-east-1.amazonaws.com/hello-world:latest \  
  --publish
```

Working with layers for TypeScript Lambda functions

A [Lambda layer](#) is a .zip file archive that contains supplementary code or data. Layers usually contain library dependencies, a [custom runtime](#), or configuration files. Creating a layer involves three general steps:

1. Package your layer content. This means creating a .zip file archive that contains the dependencies you want to use in your functions.
2. Create the layer in Lambda.
3. Add the layer to your functions.

This topic contains steps and guidance on how to properly package and create a Node.js Lambda layer with external library dependencies. Additionally, this topic explains how use your layer with a function written in TypeScript.

Prerequisites

To follow the steps in this section, you must have the following:

- [Node.js 20](#) and the [npm](#) package manager. For more information about installing Node.js, see [Installing Node.js via package manager](#) in the Node.js documentation.
- [AWS CLI version 2](#)

Throughout this topic, we reference the [layer-nodejs](#) sample application in the *aws-lambda-developer-guide* GitHub repository. This application contains scripts that will package the [lodash](#) library into a Lambda layer. The `layer` directory contains the scripts to generate the layer. The application also contains a TypeScript sample function in the `function-ts` directory that uses the dependency from the layer. After creating a layer, you can transpile, deploy and invoke the corresponding function to verify that everything works. This document walks through how to create, package, deploy and test this layer using the TypeScript sample function.

This sample application uses the Node.js 20 runtime. If you add additional dependencies to your layer, they must be compatible with Node.js 20.

Node.js layer compatibility with the Lambda runtime environment

When you package code in a Node.js layer, you specify the Lambda runtime environments that the code is compatible with. To assess code compatibility with a runtime, consider what versions of Node.js, what operating systems, and what instruction set architectures the code is designed for.

Lambda Node.js runtimes specify their Node.js version and operating system. In this document, you will use the Node.js 20 runtime, which is based on AL2023. For more information about runtime versions, see [the section called “Supported runtimes”](#). When you create a Lambda function, you specify the instruction set architecture. In this document, you will use the `arm64` architecture. For more information about architectures in Lambda, see [the section called “Instruction sets \(ARM/x86\)”](#).

When you use code provided in a package, each package maintainer independently defines their compatibility. Most Node.js development is designed to work independently of operating system and instruction set architecture. Additionally, breaking incompatibilities with new Node.js versions are not that common. Expect to spend more of your time assessing compatibility between packages than assessing package compatibility with Node.js version, operating system, or instruction set architecture.

Sometimes Node.js packages include compiled code, which require you to consider operating system and instruction set architecture compatibility. If you do need to assess code compatibility for your packages, you will need to inspect the packages and their documentation. Packages in NPM can specify their compatibility through the `engines`, `os`, and `cpu` fields of their `package.json` manifest file. For more information about `package.json` files, see [package.json](#) in the NPM documentation.

Layer paths for Node.js runtimes

When you add a layer to a function, Lambda loads the layer content into the execution environment. If your layer packages dependencies in specific folder paths, the Node.js execution environment will recognize the modules, and you can reference the modules from your function code.

To ensure that your modules are picked up, package them into your layer `.zip` file in one of the following folder paths. These files are stored in `/opt`, and the folder paths are loaded into the `PATH` environment variable.

- `nodejs/node_modules`

- `nodejs/nodeX/node_modules`

For example, the resulting layer .zip file that you create in this tutorial has the following directory structure:

```
layer_content.zip
# nodejs
  # node20
    # node_modules
      # lodash
      # <other potential dependencies>
      # ...
```

You will put the [lodash](#) library in the `nodejs/node20/node_modules` directory. This ensures that Lambda can locate the library during function invocations.

Packaging the layer content

In this example, you package the `lodash` library in a layer .zip file. Complete the following steps to install and package the layer content.

To install and package your layer content

1. Clone the [aws-lambda-developer-guide](#) repository from GitHub, which contains the sample code that you need in the `sample-apps/layer-nodejs` directory.

```
git clone https://github.com/awsdocs/aws-lambda-developer-guide.git
```

2. Navigate to the `layer` directory of the `layer-nodejs` sample app. This directory contains the scripts that you use to create and package the layer properly.

```
cd aws-lambda-developer-guide/sample-apps/layer-nodejs/layer
```

3. Ensure the `package.json` file lists `lodash`. This file defines the dependencies that you want to include in the layer. You can update this file to include any dependencies that you want in your layer.

Note

The `package.json` used in this step is not stored or used with your dependencies after they are uploaded to a Lambda layer. It is only used in the layer packaging process, and does not specify a run command and compatibility as the file would in a Node.js application or published package.

4. Ensure that you have shell permission to run the scripts in the `layer` directory.

```
chmod 744 1-install.sh && chmod 744 2-package.sh
```

5. Run the [1-install.sh](#) script using the following command:

```
./1-install.sh
```

This script runs `npm install`, which reads your `package.json` and downloads the dependencies defined inside of it.

Example 1-install.sh

```
npm install .
```

6. Run the [2-package.sh](#) script using the following command:

```
./2-package.sh
```

This script copies the contents from the `node_modules` directory into a new directory named `nodejs/node20`. It then zips the contents of the `nodejs` directory into a file named `layer_content.zip`. This is the `.zip` file for your layer. You can unzip the file and verify that it contains the correct file structure, as shown in the [the section called “Layer paths for Node.js runtimes”](#) section.

Example 2-package.sh

```
mkdir -p nodejs/node20
cp -r node_modules nodejs/node20/
zip -r layer_content.zip nodejs
```

Creating the layer

Take the `layer_content.zip` file that you generated in the previous section and upload it as a Lambda layer. You can upload a layer using the AWS Management Console or the Lambda API via the AWS Command Line Interface (AWS CLI). When you upload your layer .zip file, in the following [PublishLayerVersion](#) AWS CLI command, specify `nodejs20.x` as the compatible runtime and `arm64` as the compatible architecture.

```
aws lambda publish-layer-version --layer-name nodejs-lodash-layer \  
  --zip-file fileb://layer_content.zip \  
  --compatible-runtimes nodejs20.x \  
  --compatible-architectures "arm64"
```

From the response, note the `LayerVersionArn`, which looks like `arn:aws:lambda:us-east-1:123456789012:layer:nodejs-lodash-layer:1`. You'll need this Amazon Resource Name (ARN) in the next step of this tutorial, when you add the layer to your function.

Adding the layer to your function

Deploy a sample Lambda function that uses the `Lodash` library in its function code, then attach the layer you created. To create a Lambda function using function code written in TypeScript, you must transpile the TypeScript to JavaScript for use by the Node.js runtime. For more information about this process, see [the section called "Handler"](#). For better compatibility, use `tsc` to transpile your TypeScript module when you distribute your dependencies with layers. If you bundle your dependencies, consider using `esbuild`. For more information about bundling with `esbuild`, see [the section called "Deploy .zip file archives"](#).

To deploy the function, you need an execution role. For more information, see [the section called "Execution role \(permissions for functions to access other resources\)"](#). If you don't have an existing execution role, follow the steps in the collapsible section. Otherwise, skip to the next section to deploy the function.

(Optional) Create an execution role

To create an execution role

1. Open the [roles page](#) in the IAM console.
2. Choose **Create role**.
3. Create a role with the following properties.

- **Trusted entity – Lambda.**
- **Permissions – `AWSLambdaBasicExecutionRole`.**
- **Role name – `lambda-role`.**

The `AWSLambdaBasicExecutionRole` policy has the permissions that the function needs to write logs to CloudWatch Logs.

The sample [function code](#) uses the lodash `_.findLastIndex` method to read through an array of objects. It compares the objects against a criteria to find the index of a match. Then, it returns the index and value of the object in the Lambda response.

```
import { Handler } from 'aws-lambda';
import * as _ from 'lodash';

type User = {
  user: string;
  active: boolean;
}

type UserResult = {
  statusCode: number;
  body: string;
}

const users: User[] = [
  { 'user': 'Carlos', 'active': true },
  { 'user': 'Gil-dong', 'active': false },
  { 'user': 'Pat', 'active': false }
];

export const handler: Handler<any, UserResult> = async (): Promise<UserResult> => {

  let out = _.findLastIndex(users, (user: User) => { return user.user == 'Pat'; });
  const response = {
    statusCode: 200,
    body: JSON.stringify(out + ", " + users[out].user),
  };
  return response;
};
```

To deploy the Lambda function

1. Navigate to the `function-ts/` directory of the `layer-nodejs` sample application. If you're currently in the `layer/` directory of the `layer-nodejs` sample application, then run the following command:

```
cd ../function-ts
```

2. Install the development dependencies listed in the `package.json` using the following command:

```
npm install
```

3. Run the build task defined in the `package.json` to transpile and package your function code into a `.zip` file. Use the following command:

```
npm run build
```

4. Deploy the function. In the following AWS CLI command, replace the `--role` parameter with your execution role ARN:

```
aws lambda create-function --function-name nodejs_function_with_layer \  
  --runtime nodejs20.x \  
  --architectures "arm64" \  
  --handler index.handler \  
  --role arn:aws:iam::123456789012:role/lambda-role \  
  --zip-file fileb://dist/index.zip
```

5. Attach the layer to your function. In the following AWS CLI command, replace the `--layers` parameter with the layer version ARN that you noted earlier:

```
aws lambda update-function-configuration --function-name nodejs_function_with_layer \  
  --cli-binary-format raw-in-base64-out \  
  --layers "arn:aws:lambda:us-east-1:123456789012:layer:nodejs-lodash-layer:1"
```

6. Invoke your function to verify it works using the following AWS CLI command:

```
aws lambda invoke --function-name nodejs_function_with_layer \  
  --cli-binary-format raw-in-base64-out \  
  --payload '{} response.json
```

You should see output that looks like this:

```
{
  "StatusCode": 200,
  "ExecutedVersion": "$LATEST"
}
```

The output response .json file contains details about the response.

(Optional) Clean up your resources

You can now delete the resources that you created for this tutorial, unless you want to retain them. By deleting AWS resources that you're no longer using, you prevent unnecessary charges to your AWS account.

To delete the Lambda layer

1. Open the [Layers page](#) of the Lambda console.
2. Select the layer that you created.
3. Choose **Delete**, then choose **Delete** again.

To delete the Lambda function

1. Open the [Functions page](#) of the Lambda console.
2. Select the function that you created.
3. Choose **Actions, Delete**.
4. Type **confirm** in the text input field and choose **Delete**.

Using the Lambda context object to retrieve TypeScript function information

When Lambda runs your function, it passes a context object to the [handler](#). This object provides methods and properties that provide information about the invocation, function, and execution environment.

Context methods

- `getRemainingTimeInMillis()` – Returns the number of milliseconds left before the execution times out.

Context properties

- `functionName` – The name of the Lambda function.
- `functionVersion` – The [version](#) of the function.
- `invokedFunctionArn` – The Amazon Resource Name (ARN) that's used to invoke the function. Indicates if the invoker specified a version number or alias.
- `memoryLimitInMB` – The amount of memory that's allocated for the function.
- `awsRequestId` – The identifier of the invocation request.
- `logGroupName` – The log group for the function.
- `logStreamName` – The log stream for the function instance.
- `identity` – (mobile apps) Information about the Amazon Cognito identity that authorized the request.
 - `cognitoIdentityId` – The authenticated Amazon Cognito identity.
 - `cognitoIdentityPoolId` – The Amazon Cognito identity pool that authorized the invocation.
- `clientContext` – (mobile apps) Client context that's provided to Lambda by the client application.
 - `client.installation_id`
 - `client.app_title`
 - `client.app_version_name`
 - `client.app_version_code`

- `client.app_package_name`
 - `env.platform_version`
 - `env.platform`
 - `env.make`
 - `env.model`
 - `env.locale`
 - Custom – Custom values that are set by the client application.
- `callbackWaitsForEmptyEventLoop` – Set to `false` to send the response right away when the [callback](#) runs, instead of waiting for the Node.js event loop to be empty. If this is `false`, any outstanding events continue to run during the next invocation.

You can use the [@types/aws-lambda](#) npm package to work with the context object.

Example `index.ts` file

The following example function logs context information and returns the location of the logs.

Note

Before using this code in a Lambda function, you must add the [@types/aws-lambda](#) package as a development dependency. This package contains the type definitions for Lambda. When `@types/aws-lambda` is installed, the `import` statement (`import ... from 'aws-lambda'`) imports the type definitions. It does not import the `aws-lambda` NPM package, which is an unrelated third-party tool. For more information, see [aws-lambda](#) in the DefinitelyTyped GitHub repository.

```
import { Context } from 'aws-lambda';
export const lambdaHandler = async (event: string, context: Context): Promise<string>
=> {
  console.log('Remaining time: ', context.getRemainingTimeInMillis());
  console.log('Function name: ', context.functionName);
  return context.logStreamName;
};
```

Log and monitor TypeScript Lambda functions

AWS Lambda automatically monitors Lambda functions and sends log entries to Amazon CloudWatch. Your Lambda function comes with a CloudWatch Logs log group and a log stream for each instance of your function. The Lambda runtime environment sends details about each invocation and other output from your function's code to the log stream. For more information about CloudWatch Logs, see [Using CloudWatch Logs with Lambda](#).

To output logs from your function code, you can use methods on the [console object](#). For more detailed logging, you can use any logging library that writes to `stdout` or `stderr`.

Sections

- [Using logging tools and libraries](#)
- [Using Powertools for AWS Lambda \(TypeScript\) and AWS SAM for structured logging](#)
- [Using Powertools for AWS Lambda \(TypeScript\) and the AWS CDK for structured logging](#)
- [Viewing logs in the Lambda console](#)
- [Viewing logs in the CloudWatch console](#)

Using logging tools and libraries

[Powertools for AWS Lambda \(TypeScript\)](#) is a developer toolkit to implement Serverless best practices and increase developer velocity. The [Logger utility](#) provides a Lambda optimized logger which includes additional information about function context across all your functions with output structured as JSON. Use this utility to do the following:

- Capture key fields from the Lambda context, cold start and structures logging output as JSON
- Log Lambda invocation events when instructed (disabled by default)
- Print all the logs only for a percentage of invocations via log sampling (disabled by default)
- Append additional keys to structured log at any point in time
- Use a custom log formatter (Bring Your Own Formatter) to output logs in a structure compatible with your organization's Logging RFC

Using Powertools for AWS Lambda (TypeScript) and AWS SAM for structured logging

Follow the steps below to download, build, and deploy a sample Hello World TypeScript application with integrated [Powertools for AWS Lambda \(TypeScript\)](#) modules using the AWS SAM. This application implements a basic API backend and uses Powertools for emitting logs, metrics, and traces. It consists of an Amazon API Gateway endpoint and a Lambda function. When you send a GET request to the API Gateway endpoint, the Lambda function invokes, sends logs and metrics using Embedded Metric Format to CloudWatch, and sends traces to AWS X-Ray. The function returns a `hello world` message.

Prerequisites

To complete the steps in this section, you must have the following:

- Node.js 18.x or later
- [AWS CLI version 2](#)
- [AWS SAM CLI version 1.75 or later](#). If you have an older version of the AWS SAM CLI, see [Upgrading the AWS SAM CLI](#).

Deploy a sample AWS SAM application

1. Initialize the application using the Hello World TypeScript template.

```
sam init --app-template hello-world-powertools-typescript --name sam-app --package-type Zip --runtime nodejs18.x
```

2. Build the app.

```
cd sam-app && sam build
```

3. Deploy the app.

```
sam deploy --guided
```

4. Follow the on-screen prompts. To accept the default options provided in the interactive experience, press Enter.

Note

For **HelloWorldFunction** may not have authorization defined, **Is this okay?**, make sure to enter `y`.

5. Get the URL of the deployed application:

```
aws cloudformation describe-stacks --stack-name sam-app --query
  'Stacks[0].Outputs[?OutputKey=='HelloWorldApi'].OutputValue' --output text
```

6. Invoke the API endpoint:

```
curl <URL_FROM_PREVIOUS_STEP>
```

If successful, you'll see this response:

```
{"message":"hello world"}
```

7. To get the logs for the function, run [sam logs](#). For more information, see [Working with logs](#) in the *AWS Serverless Application Model Developer Guide*.

```
sam logs --stack-name sam-app
```

The log output looks like this:

```
2023/01/31/[$LATEST]4d53e8d279824834a1ccd35511a4949c 2022-08-31T09:33:10.552000
  START RequestId: 70693159-7e94-4102-a2af-98a6343fb8fb Version: $LATEST
2023/01/31/[$LATEST]4d53e8d279824834a1ccd35511a4949c 2022-08-31T09:33:10.594000
  2022-08-31T09:33:10.557Z 70693159-7e94-4102-a2af-98a6343fb8fb
  INFO {"_aws":{"Timestamp":1661938390556,"CloudWatchMetrics":
[{"Namespace":"sam-app","Dimensions":[["service"]],"Metrics":
[{"Name":"ColdStart","Unit":"Count"}]}]},"service":"helloWorld","ColdStart":1}
2023/01/31/[$LATEST]4d53e8d279824834a1ccd35511a4949c 2022-08-31T09:33:10.595000
  2022-08-31T09:33:10.595Z 70693159-7e94-4102-a2af-98a6343fb8fb INFO
  {"level":"INFO","message":"This is an INFO log - sending HTTP 200 - hello world
  response","service":"helloWorld","timestamp":"2022-08-31T09:33:10.594Z"}
2023/01/31/[$LATEST]4d53e8d279824834a1ccd35511a4949c 2022-08-31T09:33:10.655000
  2022-08-31T09:33:10.655Z 70693159-7e94-4102-a2af-98a6343fb8fb INFO
  {"_aws":{"Timestamp":1661938390655,"CloudWatchMetrics":[{"Namespace":"sam-
  app","Dimensions":[["service"]],"Metrics":[]}]},"service":"helloWorld"}
```

```

2023/01/31/[$LATEST]4d53e8d279824834a1ccd35511a4949c 2022-08-31T09:33:10.754000 END
  RequestId: 70693159-7e94-4102-a2af-98a6343fb8fb
2023/01/31/[$LATEST]4d53e8d279824834a1ccd35511a4949c 2022-08-31T09:33:10.754000
  REPORT RequestId: 70693159-7e94-4102-a2af-98a6343fb8fb Duration: 201.55 ms Billed
  Duration: 202 ms Memory Size: 128 MB Max Memory Used: 66 MB Init Duration: 252.42
  ms
XRAY TraceId: 1-630f2ad5-1de22b6d29a658a466e7ecf5 SegmentId: 567c116658fbf11a
  Sampled: true

```

8. This is a public API endpoint that is accessible over the internet. We recommend that you delete the endpoint after testing.

```
sam delete
```

Managing log retention

Log groups aren't deleted automatically when you delete a function. To avoid storing logs indefinitely, delete the log group, or configure a retention period after which CloudWatch automatically deletes the logs. To set up log retention, add the following to your AWS SAM template:

```

Resources:
  HelloWorldFunction:
    Type: AWS::Serverless::Function
    Properties:
      # Omitting other properties

  LogGroup:
    Type: AWS::Logs::LogGroup
    Properties:
      LogGroupName: !Sub "/aws/lambda/${HelloWorldFunction}"
      RetentionInDays: 7

```

Using Powertools for AWS Lambda (TypeScript) and the AWS CDK for structured logging

Follow the steps below to download, build, and deploy a sample Hello World TypeScript application with integrated [Powertools for AWS Lambda \(TypeScript\)](#) modules using the AWS CDK. This application implements a basic API backend and uses Powertools for emitting logs, metrics, and traces. It consists of an Amazon API Gateway endpoint and a Lambda function. When you send

a GET request to the API Gateway endpoint, the Lambda function invokes, sends logs and metrics using Embedded Metric Format to CloudWatch, and sends traces to AWS X-Ray. The function returns a `hello world` message.

Prerequisites

To complete the steps in this section, you must have the following:

- Node.js 18.x or later
- [AWS CLI version 2](#)
- [AWS CDK version 2](#)
- [AWS SAM CLI version 1.75 or later](#). If you have an older version of the AWS SAM CLI, see [Upgrading the AWS SAM CLI](#).

Deploy a sample AWS CDK application

1. Create a project directory for your new application.

```
mkdir hello-world
cd hello-world
```

2. Initialize the app.

```
cdk init app --language typescript
```

3. Add the [@types/aws-lambda](#) package as a development dependency.

```
npm install -D @types/aws-lambda
```

4. Install the Powertools [Logger utility](#).

```
npm install @aws-lambda-powertools/logger
```

5. Open the `lib` directory. You should see a file called `hello-world-stack.ts`. Create new two new files in this directory: `hello-world.function.ts` and `hello-world.ts`.
6. Open `hello-world.function.ts` and add the following code to the file. This is the code for the Lambda function.

```
import { APIGatewayEvent, APIGatewayProxyResult, Context } from 'aws-lambda';
```

```
import { Logger } from '@aws-lambda-powertools/logger';
const logger = new Logger();

export const handler = async (event: APIGatewayEvent, context: Context):
  Promise<APIGatewayProxyResult> => {
  logger.info('This is an INFO log - sending HTTP 200 - hello world response');
  return {
    statusCode: 200,
    body: JSON.stringify({
      message: 'hello world',
    }),
  };
};
```

7. Open **hello-world.ts** and add the following code to the file. This contains the [NodejsFunction construct](#), which creates the Lambda function, configures environment variables for Powertools, and sets log retention to one week. It also includes the [LambdaRestApi construct](#), which creates the REST API.

```
import { Construct } from 'constructs';
import { NodejsFunction } from 'aws-cdk-lib/aws-lambda-nodejs';
import { LambdaRestApi } from 'aws-cdk-lib/aws-apigateway';
import { RetentionDays } from 'aws-cdk-lib/aws-logs';
import { CfnOutput } from 'aws-cdk-lib';

export class HelloWorld extends Construct {
  constructor(scope: Construct, id: string) {
    super(scope, id);
    const helloFunction = new NodejsFunction(this, 'function', {
      environment: {
        Powertools_SERVICE_NAME: 'helloWorld',
        LOG_LEVEL: 'INFO',
      },
      logRetention: RetentionDays.ONE_WEEK,
    });
    const api = new LambdaRestApi(this, 'apigw', {
      handler: helloFunction,
    });
    new CfnOutput(this, 'apiUrl', {
      exportName: 'apiUrl',
      value: api.url,
    });
  }
}
```

```
}
```

8. Open **hello-world-stack.ts**. This is the code that defines your [AWS CDK stack](#). Replace the code with the following:

```
import { Stack, StackProps } from 'aws-cdk-lib';
import { Construct } from 'constructs';
import { HelloWorld } from './hello-world';

export class HelloWorldStack extends Stack {
  constructor(scope: Construct, id: string, props?: StackProps) {
    super(scope, id, props);
    new HelloWorld(this, 'hello-world');
  }
}
```

9. Go back to the project directory.

```
cd hello-world
```

10. Deploy your application.

```
cdk deploy
```

11. Get the URL of the deployed application:

```
aws cloudformation describe-stacks --stack-name HelloWorldStack --query
  'Stacks[0].Outputs[?ExportName==`apiUrl`].OutputValue' --output text
```

12. Invoke the API endpoint:

```
curl <URL_FROM_PREVIOUS_STEP>
```

If successful, you'll see this response:

```
{"message":"hello world"}
```

13. To get the logs for the function, run [sam logs](#). For more information, see [Working with logs](#) in the *AWS Serverless Application Model Developer Guide*.

```
sam logs --stack-name HelloWorldStack
```

The log output looks like this:

```
2023/01/31/[$LATEST]2ca67f180dcd4d3e88b5d68576740c8e 2022-08-31T14:48:37.047000
  START RequestId: 19ad1007-ff67-40ce-9afe-0af0a9eb512c Version: $LATEST
2023/01/31/[$LATEST]2ca67f180dcd4d3e88b5d68576740c8e 2022-08-31T14:48:37.050000 {
  "level": "INFO",
  "message": "This is an INFO log - sending HTTP 200 - hello world response",
  "service": "helloWorld",
  "timestamp": "2022-08-31T14:48:37.048Z",
  "xray_trace_id": "1-630f74c4-2b080cf77680a04f2362bcf2"
}
2023/01/31/[$LATEST]2ca67f180dcd4d3e88b5d68576740c8e 2022-08-31T14:48:37.082000 END
  RequestId: 19ad1007-ff67-40ce-9afe-0af0a9eb512c
2023/01/31/[$LATEST]2ca67f180dcd4d3e88b5d68576740c8e 2022-08-31T14:48:37.082000
  REPORT RequestId: 19ad1007-ff67-40ce-9afe-0af0a9eb512c Duration: 34.60 ms Billed
  Duration: 35 ms Memory Size: 128 MB Max Memory Used: 57 MB Init Duration: 173.48
  ms
```

14. This is a public API endpoint that is accessible over the internet. We recommend that you delete the endpoint after testing.

```
cdk destroy
```

Viewing logs in the Lambda console

You can use the Lambda console to view log output after you invoke a Lambda function.

If your code can be tested from the embedded **Code** editor, you will find logs in the **execution results**. When you use the console test feature to invoke a function, you'll find **Log output** in the **Details** section.

Viewing logs in the CloudWatch console

You can use the Amazon CloudWatch console to view logs for all Lambda function invocations.

To view logs on the CloudWatch console

1. Open the [Log groups page](#) on the CloudWatch console.
2. Choose the log group for your function (`/aws/lambda/your-function-name`).

3. Choose a log stream.

Each log stream corresponds to an [instance of your function](#). A log stream appears when you update your Lambda function, and when additional instances are created to handle multiple concurrent invocations. To find logs for a specific invocation, we recommend instrumenting your function with AWS X-Ray. X-Ray records details about the request and the log stream in the trace.

Tracing TypeScript code in AWS Lambda

Lambda integrates with AWS X-Ray to help you trace, debug, and optimize Lambda applications. You can use X-Ray to trace a request as it traverses resources in your application, which may include Lambda functions and other AWS services.

To send tracing data to X-Ray, you can use one of three SDK libraries:

- [AWS Distro for OpenTelemetry \(ADOT\)](#) – A secure, production-ready, AWS-supported distribution of the OpenTelemetry (OTel) SDK.
- [AWS X-Ray SDK for Node.js](#) – An SDK for generating and sending trace data to X-Ray.
- [Powertools for AWS Lambda \(TypeScript\)](#) – A developer toolkit to implement Serverless best practices and increase developer velocity.

Each of the SDKs offer ways to send your telemetry data to the X-Ray service. You can then use X-Ray to view, filter, and gain insights into your application's performance metrics to identify issues and opportunities for optimization.

Important

The X-Ray and Powertools for AWS Lambda SDKs are part of a tightly integrated instrumentation solution offered by AWS. The ADOT Lambda Layers are part of an industry-wide standard for tracing instrumentation that collect more data in general, but may not be suited for all use cases. You can implement end-to-end tracing in X-Ray using either solution. To learn more about choosing between them, see [Choosing between the AWS Distro for Open Telemetry and X-Ray SDKs](#).

Sections

- [Using Powertools for AWS Lambda \(TypeScript\) and AWS SAM for tracing](#)
- [Using Powertools for AWS Lambda \(TypeScript\) and the AWS CDK for tracing](#)
- [Interpreting an X-Ray trace](#)

Using Powertools for AWS Lambda (TypeScript) and AWS SAM for tracing

Follow the steps below to download, build, and deploy a sample Hello World TypeScript application with integrated [Powertools for AWS Lambda \(TypeScript\)](#) modules using the AWS SAM. This application implements a basic API backend and uses Powertools for emitting logs, metrics, and traces. It consists of an Amazon API Gateway endpoint and a Lambda function. When you send a GET request to the API Gateway endpoint, the Lambda function invokes, sends logs and metrics using Embedded Metric Format to CloudWatch, and sends traces to AWS X-Ray. The function returns a `hello world` message.

Prerequisites

To complete the steps in this section, you must have the following:

- Node.js 18.x or later
- [AWS CLI version 2](#)
- [AWS SAM CLI version 1.75 or later](#). If you have an older version of the AWS SAM CLI, see [Upgrading the AWS SAM CLI](#).

Deploy a sample AWS SAM application

1. Initialize the application using the Hello World TypeScript template.

```
sam init --app-template hello-world-powertools-typescript --name sam-app --package-type Zip --runtime nodejs18.x --no-tracing
```

2. Build the app.

```
cd sam-app && sam build
```

3. Deploy the app.

```
sam deploy --guided
```

4. Follow the on-screen prompts. To accept the default options provided in the interactive experience, press Enter.

Note

For **HelloWorldFunction** may not have authorization defined, Is this okay?, make sure to enter y.

5. Get the URL of the deployed application:

```
aws cloudformation describe-stacks --stack-name sam-app --query  
'Stacks[0].Outputs[?OutputKey=`HelloWorldApi`].OutputValue' --output text
```

6. Invoke the API endpoint:

```
curl <URL_FROM_PREVIOUS_STEP>
```

If successful, you'll see this response:

```
{"message":"hello world"}
```

7. To get the traces for the function, run [sam traces](#).

```
sam traces
```

The trace output looks like this:

```
XRay Event [revision 1] at (2023-01-31T11:29:40.527000) with id  
(1-11a2222-111a222222cb33de3b95daf9) and duration (0.483s)  
- 0.425s - sam-app/Prod [HTTP: 200]  
- 0.422s - Lambda [HTTP: 200]  
- 0.406s - sam-app-HelloWorldFunction-XYZv11a1bcde [HTTP: 200]  
- 0.172s - sam-app-HelloWorldFunction-XYZv11a1bcde  
- 0.179s - Initialization  
- 0.112s - Invocation  
- 0.052s - ## app.lambdaHandler  
- 0.001s - ### MySubSegment  
- 0.059s - Overhead
```

8. This is a public API endpoint that is accessible over the internet. We recommend that you delete the endpoint after testing.

```
sam delete
```

X-Ray doesn't trace all requests to your application. X-Ray applies a sampling algorithm to ensure that tracing is efficient, while still providing a representative sample of all requests. The sampling rate is 1 request per second and 5 percent of additional requests. You can't configure the X-Ray sampling rate for your functions.

Using Powertools for AWS Lambda (TypeScript) and the AWS CDK for tracing

Follow the steps below to download, build, and deploy a sample Hello World TypeScript application with integrated [Powertools for AWS Lambda \(TypeScript\)](#) modules using the AWS CDK. This application implements a basic API backend and uses Powertools for emitting logs, metrics, and traces. It consists of an Amazon API Gateway endpoint and a Lambda function. When you send a GET request to the API Gateway endpoint, the Lambda function invokes, sends logs and metrics using Embedded Metric Format to CloudWatch, and sends traces to AWS X-Ray. The function returns a `hello world` message.

Prerequisites

To complete the steps in this section, you must have the following:

- Node.js 18.x or later
- [AWS CLI version 2](#)
- [AWS CDK version 2](#)
- [AWS SAM CLI version 1.75 or later](#). If you have an older version of the AWS SAM CLI, see [Upgrading the AWS SAM CLI](#).

Deploy a sample AWS Cloud Development Kit (AWS CDK) application

1. Create a project directory for your new application.

```
mkdir hello-world  
cd hello-world
```

2. Initialize the app.

```
cdk init app --language typescript
```

3. Add the [@types/aws-lambda](#) package as a development dependency.

```
npm install -D @types/aws-lambda
```

4. Install the Powertools [Tracer utility](#).

```
npm install @aws-lambda-powertools/tracer
```

5. Open the **lib** directory. You should see a file called **hello-world-stack.ts**. Create new two new files in this directory: **hello-world.function.ts** and **hello-world.ts**.
6. Open **hello-world.function.ts** and add the following code to the file. This is the code for the Lambda function.

```
import { APIGatewayEvent, APIGatewayProxyResult, Context } from 'aws-lambda';
import { Tracer } from '@aws-lambda-powertools/tracer';
const tracer = new Tracer();

export const handler = async (event: APIGatewayEvent, context: Context):
Promise<APIGatewayProxyResult> => {
  // Get facade segment created by Lambda
  const segment = tracer.getSegment();

  // Create subsegment for the function and set it as active
  const handlerSegment = segment.addNewSubsegment(`## ${process.env._HANDLER}`);
  tracer.setSegment(handlerSegment);

  // Annotate the subsegment with the cold start and serviceName
  tracer.annotateColdStart();
  tracer.addServiceNameAnnotation();

  // Add annotation for the awsRequestId
  tracer.putAnnotation('awsRequestId', context.awsRequestId);
  // Create another subsegment and set it as active
  const subsegment = handlerSegment.addNewSubsegment('### MySubSegment');
  tracer.setSegment(subsegment);
  let response: APIGatewayProxyResult = {
    statusCode: 200,
    body: JSON.stringify({
      message: 'hello world',
```

```

    }),
  };
  // Close subsegments (the Lambda one is closed automatically)
  subsegment.close(); // (### MySubSegment)
  handlerSegment.close(); // (## index.handler)

  // Set the facade segment as active again (the one created by Lambda)
  tracer.setSegment(segment);
  return response;
};

```

7. Open **hello-world.ts** and add the following code to the file. This contains the [NodejsFunction construct](#), which creates the Lambda function, configures environment variables for Powertools, and sets log retention to one week. It also includes the [LambdaRestApi construct](#), which creates the REST API.

```

import { Construct } from 'constructs';
import { NodejsFunction } from 'aws-cdk-lib/aws-lambda-nodejs';
import { LambdaRestApi } from 'aws-cdk-lib/aws-apigateway';
import { CfnOutput } from 'aws-cdk-lib';
import { Tracing } from 'aws-cdk-lib/aws-lambda';

export class HelloWorld extends Construct {
  constructor(scope: Construct, id: string) {
    super(scope, id);
    const helloFunction = new NodejsFunction(this, 'function', {
      environment: {
        POWERTOOLS_SERVICE_NAME: 'helloWorld',
      },
      tracing: Tracing.ACTIVE,
    });
    const api = new LambdaRestApi(this, 'apigw', {
      handler: helloFunction,
    });
    new CfnOutput(this, 'apiUrl', {
      exportName: 'apiUrl',
      value: api.url,
    });
  }
}

```

8. Open **hello-world-stack.ts**. This is the code that defines your [AWS CDK stack](#). Replace the code with the following:

```
import { Stack, StackProps } from 'aws-cdk-lib';
import { Construct } from 'constructs';
import { HelloWorld } from './hello-world';

export class HelloWorldStack extends Stack {
  constructor(scope: Construct, id: string, props?: StackProps) {
    super(scope, id, props);
    new HelloWorld(this, 'hello-world');
  }
}
```

9. Deploy your application.

```
cd ..
cdk deploy
```

10. Get the URL of the deployed application:

```
aws cloudformation describe-stacks --stack-name HelloWorldStack --query
  'Stacks[0].Outputs[?ExportName==`apiUrl`].OutputValue' --output text
```

11. Invoke the API endpoint:

```
curl <URL_FROM_PREVIOUS_STEP>
```

If successful, you'll see this response:

```
{"message":"hello world"}
```

12. To get the traces for the function, run [sam traces](#).

```
sam traces
```

The trace output looks like this:

```
XRay Event [revision 1] at (2023-01-31T11:50:06.997000) with id
(1-11a2222-111a22222cb33de3b95daf9) and duration (0.449s)
- 0.350s - HelloWorldStack-helloworldfunction111A2BCD-Xyzv11a1bcde [HTTP: 200]
- 0.157s - HelloWorldStack-helloworldfunction111A2BCD-Xyzv11a1bcde
- 0.169s - Initialization
```

```

- 0.058s - Invocation
- 0.055s - ## index.handler
  - 0.000s - ### MySubSegment
- 0.099s - Overhead

```

13. This is a public API endpoint that is accessible over the internet. We recommend that you delete the endpoint after testing.

```
cdk destroy
```

Interpreting an X-Ray trace

After you've configured active tracing, you can observe specific requests through your application. The [X-Ray trace map](#) provides information about your application and all its components. The following example shows a trace from the sample application:

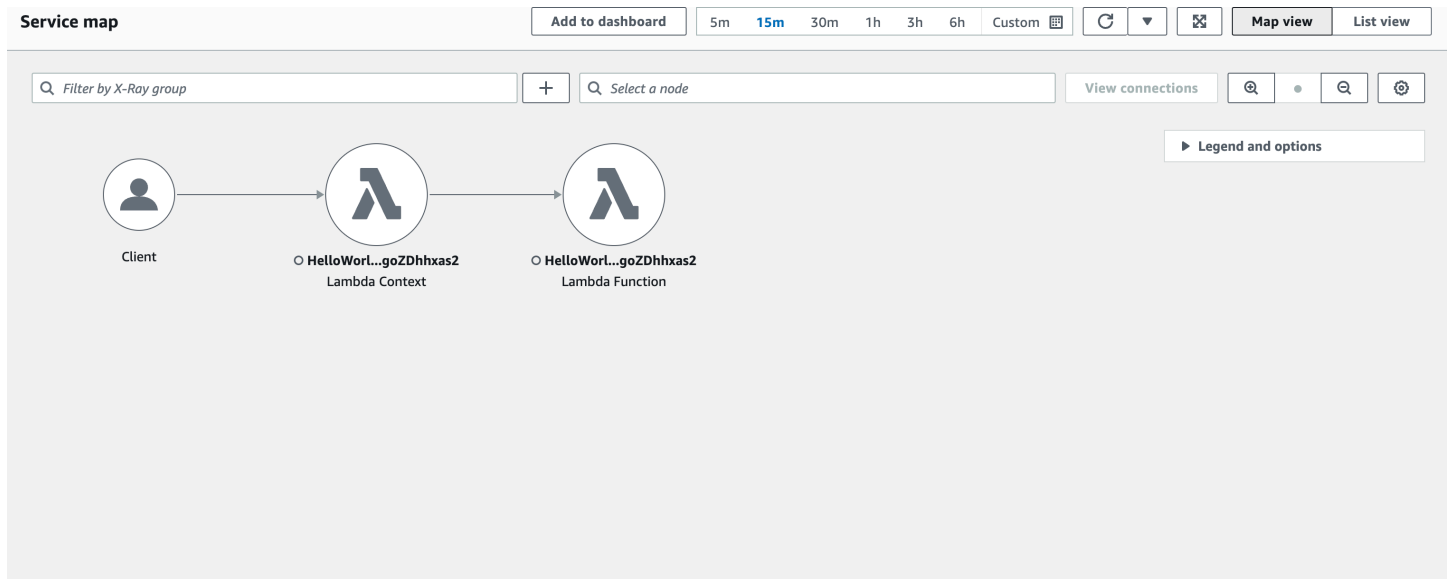

Building Lambda functions with Python

You can run Python code in AWS Lambda. Lambda provides [runtimes](#) for Python that run your code to process events. Your code runs in an environment that includes the SDK for Python (Boto3), with credentials from an AWS Identity and Access Management (IAM) role that you manage. To learn more about the SDK versions included with the Python runtimes, see [the section called “Runtime-included SDK versions”](#).

Lambda supports the following Python runtimes.

Name	Identifier	Operating system	Deprecation date	Block function create	Block function update
Python 3.13	python3.13	Amazon Linux 2023	Not scheduled	Not scheduled	Not scheduled
Python 3.12	python3.12	Amazon Linux 2023	Not scheduled	Not scheduled	Not scheduled
Python 3.11	python3.11	Amazon Linux 2	Not scheduled	Not scheduled	Not scheduled
Python 3.10	python3.10	Amazon Linux 2	Not scheduled	Not scheduled	Not scheduled
Python 3.9	python3.9	Amazon Linux 2	Not scheduled	Not scheduled	Not scheduled

To create a Python function

1. Open the [Lambda console](#).
2. Choose **Create function**.
3. Configure the following settings:
 - **Function name:** Enter a name for the function.
 - **Runtime:** Choose **Python 3.13**.

4. Choose **Create function**.

The console creates a Lambda function with a single source file named `lambda_function`. You can edit this file and add more files in the built-in code editor. In the **DEPLOY** section, choose **Deploy** to update your function's code. Then, to run your code, choose **Create test event** in the **TEST EVENTS** section.

Your Lambda function comes with a CloudWatch Logs log group. The function runtime sends details about each invocation to CloudWatch Logs. It relays any [logs that your function outputs](#) during invocation. If your function returns an error, Lambda formats the error and returns it to the invoker.

Topics

- [Runtime-included SDK versions](#)
- [Experimental features in Python 3.13](#)
- [Response format](#)
- [Graceful shutdown for extensions](#)
- [Define Lambda function handler in Python](#)
- [Working with .zip file archives for Python Lambda functions](#)
- [Deploy Python Lambda functions with container images](#)
- [Working with layers for Python Lambda functions](#)
- [Using the Lambda context object to retrieve Python function information](#)
- [Log and monitor Python Lambda functions](#)
- [AWS Lambda function testing in Python](#)
- [Instrumenting Python code in AWS Lambda](#)

Runtime-included SDK versions

The version of the AWS SDK included in the Python runtime depends on the runtime version and your AWS Region. To find the version of the SDK included in the runtime you're using, create a Lambda function with the following code.

```
import boto3
import botocore
```

```
def lambda_handler(event, context):
    print(f'boto3 version: {boto3.__version__}')
    print(f'botocore version: {botocore.__version__}')
```

Experimental features in Python 3.13

The Python 3.13 managed runtime and base images do not support the following experimental features. You cannot enable these features using runtime flags. To use these features in a Lambda function, you must deploy a [custom runtime](#) or [container image](#) containing your own build of Python 3.13.

- [Free-threaded CPython](#): You cannot disable the global interpreter lock.
- [Just-in-time \(JIT\) compiler](#): You cannot enable the JIT compiler.

Response format

In Python 3.12 and later Python runtimes, functions return Unicode characters as part of their JSON response. Earlier Python runtimes return escaped sequences for Unicode characters in responses. For example, in Python 3.11, if you return a Unicode string such as "こんにちは", it escapes the Unicode characters and returns "\u3053\u3093\u306b\u3061\u306f". The Python 3.12 runtime returns the original "こんにちは".

Using Unicode responses reduces the size of Lambda responses, making it easier to fit larger responses into the 6 MB maximum payload size for synchronous functions. In the previous example, the escaped version is 32 bytes—compared to 17 bytes with the Unicode string.

When you upgrade to Python 3.12 or later Python runtimes, you might need to adjust your code to account for the new response format. If the caller expects escaped Unicode, you must either add code to the returning function to escape the Unicode manually, or adjust the caller to handle the Unicode return.

Graceful shutdown for extensions

Python 3.12 and later Python runtimes offer improved graceful shutdown capabilities for functions with [external extensions](#). When Lambda shuts down an execution environment, it sends a SIGTERM signal to the runtime and then a SHUTDOWN event to each registered external extension. You

can catch the SIGTERM signal in your Lambda function and clean up resources such as database connections that were created by the function.

To learn more about the execution environment lifecycle, see [Understanding the Lambda execution environment lifecycle](#). For examples of how to use graceful shutdown with extensions, see the [AWS Samples GitHub repository](#).

Define Lambda function handler in Python

The Lambda function *handler* is the method in your function code that processes events. When your function is invoked, Lambda runs the handler method. Your function runs until the handler returns a response, exits, or times out.

You can use the following general syntax when creating a function handler in Python:

```
def handler_name(event, context):  
    ...  
    return some_value
```

Topics

- [Naming](#)
- [How it works](#)
- [Returning a value](#)
- [Examples](#)
- [Code best practices for Python Lambda functions](#)

Naming

The Lambda function handler name specified at the time that you create a Lambda function is derived from:

- The name of the file in which the Lambda handler function is located.
- The name of the Python handler function.

A function handler can be any name; however, the default name in the Lambda console is `lambda_function.lambda_handler`. This function handler name reflects the function name (`lambda_handler`) and the file where the handler code is stored (`lambda_function.py`).

If you create a function in the console using a different file name or function handler name, you must edit the default handler name.

To change the function handler name (console)

1. Open the [Functions](#) page of the Lambda console and choose your function.

2. Choose the **Code** tab.
3. Scroll down to the **Runtime settings** pane and choose **Edit**.
4. In **Handler**, enter the new name for your function handler.
5. Choose **Save**.

How it works

When Lambda invokes your function handler, the [Lambda runtime](#) passes two arguments to the function handler:

- The first argument is the [event object](#). An event is a JSON-formatted document that contains data for a Lambda function to process. The [Lambda runtime](#) converts the event to an object and passes it to your function code. It is usually of the Python `dict` type. It can also be `list`, `str`, `int`, `float`, or the `NoneType` type.

The event object contains information from the invoking service. When you invoke a function, you determine the structure and contents of the event. When an AWS service invokes your function, the service defines the event structure. For more information about events from AWS services, see [Invoking Lambda with events from other AWS services](#).

- The second argument is the [context object](#). A context object is passed to your function by Lambda at runtime. This object provides methods and properties that provide information about the invocation, function, and runtime environment.

Returning a value

Optionally, a handler can return a value. What happens to the returned value depends on the [invocation type](#) and the [service](#) that invoked the function. For example:

- If you use the RequestResponse invocation type, such as [Invoke a Lambda function synchronously](#), AWS Lambda returns the result of the Python function call to the client invoking the Lambda function (in the HTTP response to the invocation request, serialized into JSON). For example, AWS Lambda console uses the RequestResponse invocation type, so when you invoke the function on the console, the console will display the returned value.
- If the handler returns objects that can't be serialized by `json.dumps`, the runtime returns an error.

- If the handler returns `None`, as Python functions without a `return` statement implicitly do, the runtime returns `null`.
- If you use the Event invocation type (an [asynchronous invocation](#)), the value is discarded.

Note

In Python 3.9 and later releases, Lambda includes the `requestId` of the invocation in the error response.

Examples

The following section shows examples of Python functions you can use with Lambda. If you use the Lambda console to author your function, you do not need to attach a [.zip archive file](#) to run the functions in this section. These functions use standard Python libraries which are included with the Lambda runtime you selected. For more information about adding dependencies to a .zip file archive, see [???](#).

Returning a message

The following example shows a function called `lambda_handler`. The function accepts user input of a first and last name, and returns a message that contains data from the event it received as input.

```
def lambda_handler(event, context):
    message = 'Hello {} {}!'.format(event['first_name'], event['last_name'])
    return {
        'message' : message
    }
```

You can use the following event data to invoke the function:

```
{
  "first_name": "John",
  "last_name": "Smith"
}
```

The response shows the event data passed as input:

```
{
  "message": "Hello John Smith!"
}
```

Parsing a response

The following example shows a function called `lambda_handler`. The function uses event data passed by Lambda at runtime. It parses the [environment variable](#) in `AWS_REGION` returned in the JSON response.

```
import os
import json

def lambda_handler(event, context):
    json_region = os.environ['AWS_REGION']
    return {
        "statusCode": 200,
        "headers": {
            "Content-Type": "application/json"
        },
        "body": json.dumps({
            "Region ": json_region
        })
    }
```

You can use any event data to invoke the function:

```
{
  "key1": "value1",
  "key2": "value2",
  "key3": "value3"
}
```

Lambda runtimes set several environment variables during initialization. For more information on the environment variables returned in the response at runtime, see [Create Lambda environment variables](#).

The function in this example depends on a successful response (in `200`) from the Invoke API. For more information on the Invoke API status, see the [Invoke](#) Response Syntax.

Returning a calculation

The following example shows a function called `lambda_handler`. The function accepts user input and returns a calculation to the user. For more information about this example, see the [aws-doc-sdk-examples GitHub repository](#).

```
import logging

logger = logging.getLogger()
logger.setLevel(logging.INFO)

def lambda_handler(event, context):
    ...
    result = None
    action = event.get('action')
    if action == 'increment':
        result = event.get('number', 0) + 1
        logger.info('Calculated result of %s', result)
    else:
        logger.error("%s is not a valid action.", action)

    response = {'result': result}
    return response
```

You can use the following event data to invoke the function:

```
{
  "action": "increment",
  "number": 3
}
```

Code best practices for Python Lambda functions

Adhere to the guidelines in the following list to use best coding practices when building your Lambda functions:

- **Separate the Lambda handler from your core logic.** This allows you to make a more unit-testable function. For example, in Python, this may look like:

```
def lambda_handler(event, context):
    foo = event['foo']
```

```
bar = event['bar']

result = my_lambda_function(foo, bar)

def my_lambda_function(foo, bar):
    // MyLambdaFunction logic here
```

- **Control the dependencies in your function's deployment package.** The AWS Lambda execution environment contains a number of libraries. For the Node.js and Python runtimes, these include the AWS SDKs. To enable the latest set of features and security updates, Lambda will periodically update these libraries. These updates may introduce subtle changes to the behavior of your Lambda function. To have full control of the dependencies your function uses, package all of your dependencies with your deployment package.
- **Minimize the complexity of your dependencies.** Prefer simpler frameworks that load quickly on [execution environment](#) startup.
- **Minimize your deployment package size to its runtime necessities.** This will reduce the amount of time that it takes for your deployment package to be downloaded and unpacked ahead of invocation.
- **Take advantage of execution environment reuse to improve the performance of your function.** Initialize SDK clients and database connections outside of the function handler, and cache static assets locally in the /tmp directory. Subsequent invocations processed by the same instance of your function can reuse these resources. This saves cost by reducing function run time.

To avoid potential data leaks across invocations, don't use the execution environment to store user data, events, or other information with security implications. If your function relies on a mutable state that can't be stored in memory within the handler, consider creating a separate function or separate versions of a function for each user.

- **Use a keep-alive directive to maintain persistent connections.** Lambda purges idle connections over time. Attempting to reuse an idle connection when invoking a function will result in a connection error. To maintain your persistent connection, use the keep-alive directive associated with your runtime. For an example, see [Reusing Connections with Keep-Alive in Node.js](#).
- **Use [environment variables](#) to pass operational parameters to your function.** For example, if you are writing to an Amazon S3 bucket, instead of hard-coding the bucket name you are writing to, configure the bucket name as an environment variable.

- **Avoid using recursive invocations** in your Lambda function, where the function invokes itself or initiates a process that may invoke the function again. This could lead to unintended volume of function invocations and escalated costs. If you see an unintended volume of invocations, set the function reserved concurrency to 0 immediately to throttle all invocations to the function, while you update the code.
- **Do not use non-documented, non-public APIs** in your Lambda function code. For AWS Lambda managed runtimes, Lambda periodically applies security and functional updates to Lambda's internal APIs. These internal API updates may be backwards-incompatible, leading to unintended consequences such as invocation failures if your function has a dependency on these non-public APIs. See [the API reference](#) for a list of publicly available APIs.
- **Write idempotent code.** Writing idempotent code for your functions ensures that duplicate events are handled the same way. Your code should properly validate events and gracefully handle duplicate events. For more information, see [How do I make my Lambda function idempotent?](#)

Working with .zip file archives for Python Lambda functions

Your AWS Lambda function's code comprises a .py file containing your function's handler code, together with any additional packages and modules your code depends on. To deploy this function code to Lambda, you use a *deployment package*. This package may either be a .zip file archive or a container image. For more information about using container images with Python, see [Deploy Python Lambda functions with container images](#).

To create your deployment package as .zip file archive, you can use your command-line tool's built-in .zip file archive utility, or any other .zip file utility such as [7zip](#). The examples shown in the following sections assume you're using a command-line zip tool in a Linux or MacOS environment. To use the same commands in Windows, you can [install the Windows Subsystem for Linux](#) to get a Windows-integrated version of Ubuntu and Bash.

Note that Lambda uses POSIX file permissions, so you may need to [set permissions for the deployment package folder](#) before you create the .zip file archive.

Topics

- [Runtime dependencies in Python](#)
- [Creating a .zip deployment package with no dependencies](#)
- [Creating a .zip deployment package with dependencies](#)
- [Dependency search path and runtime-included libraries](#)
- [Using `__pycache__` folders](#)
- [Creating .zip deployment packages with native libraries](#)
- [Creating and updating Python Lambda functions using .zip files](#)

Runtime dependencies in Python

For Lambda functions that use the Python runtime, a dependency can be any Python package or module. When you deploy your function using a .zip archive, you can either add these dependencies to your .zip file with your function code or use a [Lambda layer](#). A layer is a separate .zip file that can contain additional code and other content. To learn more about using Lambda layers in Python, see [the section called "Layers"](#).

The Lambda Python runtimes include the AWS SDK for Python (Boto3) and its dependencies. Lambda provides the SDK in the runtime for deployment scenarios where you are unable to add your own dependencies. These scenarios include creating functions in the console using the built-

in code editor or using inline functions in AWS Serverless Application Model (AWS SAM) or AWS CloudFormation templates.

Lambda periodically updates the libraries in the Python runtime to include the latest updates and security patches. If your function uses the version of the Boto3 SDK included in the runtime but your deployment package includes SDK dependencies, this can cause version misalignment issues. For example, your deployment package could include the SDK dependency `urllib3`. When Lambda updates the SDK in the runtime, compatibility issues between the new version of the runtime and the version of `urllib3` in your deployment package can cause your function to fail.

Important

To maintain full control over your dependencies and to avoid possible version misalignment issues, we recommend you add all of your function's dependencies to your deployment package, even if versions of them are included in the Lambda runtime. This includes the Boto3 SDK.

To find out which version of the SDK for Python (Boto3) is included in the runtime you're using, see [the section called "Runtime-included SDK versions"](#).

Under the [AWS shared responsibility model](#), you are responsible for the management of any dependencies in your functions' deployment packages. This includes applying updates and security patches. To update dependencies in your function's deployment package, first create a new `.zip` file and then upload it to Lambda. See [Creating a .zip deployment package with dependencies](#) and [Creating and updating Python Lambda functions using .zip files](#) for more information.

Creating a .zip deployment package with no dependencies

If your function code has no dependencies, your `.zip` file contains only the `.py` file with your function's handler code. Use your preferred zip utility to create a `.zip` file with your `.py` file at the root. If the `.py` file is not at the root of your `.zip` file, Lambda won't be able to run your code.

To learn how to deploy your `.zip` file to create a new Lambda function or update an existing one, see [Creating and updating Python Lambda functions using .zip files](#).

Creating a .zip deployment package with dependencies

If your function code depends on additional packages or modules, you can either add these dependencies to your `.zip` file with your function code or [use a Lambda layer](#). The instructions

in this section show you how to include your dependencies in your .zip deployment package. For Lambda to run your code, the .py file containing your handler code and all of your function's dependencies must be installed at the root of the .zip file.

Suppose your function code is saved in a file named `lambda_function.py`. The following example CLI commands create a .zip file named `my_deployment_package.zip` containing your function code and its dependencies. You can either install your dependencies directly to a folder in your project directory or use a Python virtual environment.

To create the deployment package (project directory)

1. Navigate to the project directory containing your `lambda_function.py` source code file. In this example, the directory is named `my_function`.

```
cd my_function
```

2. Create a new directory named `package` into which you will install your dependencies.

```
mkdir package
```

Note that for a .zip deployment package, Lambda expects your source code and its dependencies all to be at the root of the .zip file. However, installing dependencies directly in your project directory can introduce a large number of new files and folders and make navigating around your IDE difficult. You create a separate `package` directory here to keep your dependencies separate from your source code.

3. Install your dependencies in the `package` directory. The example below installs the `Boto3` SDK from the Python Package Index using `pip`. If your function code uses Python packages you have created yourself, save them in the `package` directory.

```
pip install --target ./package boto3
```

4. Create a .zip file with the installed libraries at the root.

```
cd package  
zip -r ../my_deployment_package.zip .
```

This generates a `my_deployment_package.zip` file in your project directory.

5. Add the `lambda_function.py` file to the root of the .zip file

```
cd ..  
zip my_deployment_package.zip lambda_function.py
```

Your .zip file should have a flat directory structure, with your function's handler code and all your dependency folders installed at the root as follows.

```
my_deployment_package.zip  
|- bin  
|  |-jp.py  
|- boto3  
|  |-compat.py  
|  |-data  
|  |-docs  
...  
|- lambda_function.py
```

If the .py file containing your function's handler code is not at the root of your .zip file, Lambda will not be able to run your code.

To create the deployment package (virtual environment)

1. Create and activate a virtual environment in your project directory. In this example the project directory is named `my_function`.

```
~$ cd my_function  
~/my_function$ python3.13 -m venv my_virtual_env  
~/my_function$ source ./my_virtual_env/bin/activate
```

2. Install your required libraries using pip. The following example installs the Boto3 SDK

```
(my_virtual_env) ~/my_function$ pip install boto3
```

3. Use `pip show` to find the location in your virtual environment where pip has installed your dependencies.

```
(my_virtual_env) ~/my_function$ pip show <package_name>
```

The folder in which pip installs your libraries may be named `site-packages` or `dist-packages`. This folder may be located in either the `lib/python3.x` or `lib64/python3.x` directory (where `python3.x` represents the version of Python you are using).

4. Deactivate the virtual environment

```
(my_virtual_env) ~/my_function$ deactivate
```

5. Navigate into the directory containing the dependencies you installed with pip and create a .zip file in your project directory with the installed dependencies at the root. In this example, pip has installed your dependencies in the `my_virtual_env/lib/python3.13/site-packages` directory.

```
~/my_function$ cd my_virtual_env/lib/python3.13/site-packages
~/my_function/my_virtual_env/lib/python3.13/site-packages$ zip -r ../../../../
my_deployment_package.zip .
```

6. Navigate to the root of your project directory where the .py file containing your handler code is located and add that file to the root of your .zip package. In this example, your function code file is named `lambda_function.py`.

```
~/my_function/my_virtual_env/lib/python3.13/site-packages$ cd ../../../../
~/my_function$ zip my_deployment_package.zip lambda_function.py
```

Dependency search path and runtime-included libraries

When you use an `import` statement in your code, the Python runtime searches the directories in its search path until it finds the module or package. By default, the first location the runtime searches is the directory into which your .zip deployment package is decompressed and mounted (`/var/task`). If you include a version of a runtime-included library in your deployment package, your version will take precedence over the version that's included in the runtime. Dependencies in your deployment package also have precedence over dependencies in layers.

When you add a dependency to a layer, Lambda extracts this to `/opt/python/lib/python3.x/site-packages` (where `python3.x` represents the version of the runtime you're using) or `/opt/python`. In the search path, these directories have precedence over the directories containing the runtime-included libraries and pip-installed libraries (`/var/runtime` and `/var/lang/`

lib/python3.x/site-packages). Libraries in function layers therefore have precedence over versions included in the runtime.

Note

In the Python 3.11 managed runtime and base image, the AWS SDK and its dependencies are installed in the `/var/lang/lib/python3.11/site-packages` directory.

You can see the full search path for your Lambda function by adding the following code snippet.

```
import sys

search_path = sys.path
print(search_path)
```

Note

Because dependencies in your deployment package or layers take precedence over runtime-included libraries, this can cause version misalignment problems if you include an SDK dependency such as `urllib3` in your package without including the SDK as well. If you deploy your own version of a Boto3 dependency, you must also deploy Boto3 as a dependency in your deployment package. We recommend that you package all of your function's dependencies, even if versions of them are included in the runtime.

You can also add dependencies in a separate folder inside your `.zip` package. For example, you might add a version of the Boto3 SDK to a folder in your `.zip` package called `common`. When your `.zip` package is decompressed and mounted, this folder is placed inside the `/var/task` directory. To use a dependency from a folder in your `.zip` deployment package in your code, use an `import from` statement. For example, to use a version of Boto3 from a folder named `common` in your `.zip` package, use the following statement.

```
from common import boto3
```

Using `__pycache__` folders

We recommend that you don't include `__pycache__` folders in your function's deployment package. Python bytecode that's compiled on a build machine with a different architecture or operating system might not be compatible with the Lambda execution environment.

Creating .zip deployment packages with native libraries

If your function uses only pure Python packages and modules, you can use the `pip install` command to install your dependencies on any local build machine and create your .zip file. Many popular Python libraries, including NumPy and Pandas, are not pure Python and contain code written in C or C++. When you add libraries containing C/C++ code to your deployment package, you must build your package correctly to ensure that it's compatible with the Lambda execution environment.

Most packages available on the Python Package Index ([PyPI](#)) are available as “wheels” (.whl files). A .whl file is a type of ZIP file which contains a built distribution with pre-compiled binaries for a particular operating system and instruction set architecture. To make your deployment package compatible with Lambda, you install the wheel for Linux operating systems and your function's instruction set architecture.

Some packages may only be available as source distributions. For these packages, you need to compile and build the C/C++ components yourself.

To see what distributions are available for your required package, do the following:

1. Search for the name of the package on the [Python Package Index main page](#).
2. Choose the version of the package you want to use.
3. Choose **Download files**.

Working with built distributions (wheels)

To download a wheel that's compatible with Lambda, you use the `pip --platform` option.

If your Lambda function uses the `x86_64` instruction set architecture, run the following `pip install` command to install a compatible wheel in your package directory. Replace `--python 3.x` with the version of the Python runtime you are using.

```
pip install \
```

```
--platform manylinux2014_x86_64 \  
--target=package \  
--implementation cp \  
--python-version 3.x \  
--only-binary=:all: --upgrade \  
<package_name>
```

If your function uses the **arm64** instruction set architecture, run the following command. Replace `--python 3.x` with the version of the Python runtime you are using.

```
pip install \  
--platform manylinux2014_aarch64 \  
--target=package \  
--implementation cp \  
--python-version 3.x \  
--only-binary=:all: --upgrade \  
<package_name>
```

Working with source distributions

If your package is only available as a source distribution, you need to build the C/C++ libraries yourself. To make your package compatible with the Lambda execution environment, you need to build it in an environment that uses the same Amazon Linux 2 operating system. You can do this by building your package in an Amazon EC2 Linux instance.

To learn how to launch and connect to an Amazon EC2 Linux instance, see [Tutorial: Get started with Amazon EC2 Linux instances](#) in the *Amazon EC2 User Guide for Linux Instances*.

Creating and updating Python Lambda functions using .zip files

After you have created your .zip deployment package, you can use it to create a new Lambda function or update an existing one. You can deploy your .zip package using the Lambda console, the AWS Command Line Interface, and the Lambda API. You can also create and update Lambda functions using AWS Serverless Application Model (AWS SAM) and AWS CloudFormation.

The maximum size for a .zip deployment package for Lambda is 250 MB (unzipped). Note that this limit applies to the combined size of all the files you upload, including any Lambda layers.

The Lambda runtime needs permission to read the files in your deployment package. In Linux permissions octal notation, Lambda needs 644 permissions for non-executable files (rw-r--r--) and 755 permissions (rwxr-xr-x) for directories and executable files.

In Linux and MacOS, use the `chmod` command to change file permissions on files and directories in your deployment package. For example, to give a non-executable file the correct permissions, run the following command.

```
chmod 644 <filepath>
```

To change file permissions in Windows, see [Set, View, Change, or Remove Permissions on an Object](#) in the Microsoft Windows documentation.

Note

If you don't grant Lambda the permissions it needs to access directories in your deployment package, Lambda sets the permissions for those directories to 755 (rwxr-xr-x).

Creating and updating functions with .zip files using the console

To create a new function, you must first create the function in the console, then upload your .zip archive. To update an existing function, open the page for your function, then follow the same procedure to add your updated .zip file.

If your .zip file is less than 50MB, you can create or update a function by uploading the file directly from your local machine. For .zip files greater than 50MB, you must upload your package to an Amazon S3 bucket first. For instructions on how to upload a file to an Amazon S3 bucket using the AWS Management Console, see [Getting started with Amazon S3](#). To upload files using the AWS CLI, see [Move objects](#) in the *AWS CLI User Guide*.

Note

You cannot change the [deployment package type](#) (.zip or container image) for an existing function. For example, you cannot convert a container image function to use a .zip file archive. You must create a new function.

To create a new function (console)

1. Open the [Functions page](#) of the Lambda console and choose **Create Function**.
2. Choose **Author from scratch**.

3. Under **Basic information**, do the following:
 - a. For **Function name**, enter the name for your function.
 - b. For **Runtime**, select the runtime you want to use.
 - c. (Optional) For **Architecture**, choose the instruction set architecture for your function. The default architecture is x86_64. Ensure that the .zip deployment package for your function is compatible with the instruction set architecture you select.
4. (Optional) Under **Permissions**, expand **Change default execution role**. You can create a new **Execution role** or use an existing one.
5. Choose **Create function**. Lambda creates a basic 'Hello world' function using your chosen runtime.

To upload a .zip archive from your local machine (console)

1. In the [Functions page](#) of the Lambda console, choose the function you want to upload the .zip file for.
2. Select the **Code** tab.
3. In the **Code source** pane, choose **Upload from**.
4. Choose **.zip file**.
5. To upload the .zip file, do the following:
 - a. Select **Upload**, then select your .zip file in the file chooser.
 - b. Choose **Open**.
 - c. Choose **Save**.

To upload a .zip archive from an Amazon S3 bucket (console)

1. In the [Functions page](#) of the Lambda console, choose the function you want to upload a new .zip file for.
2. Select the **Code** tab.
3. In the **Code source** pane, choose **Upload from**.
4. Choose **Amazon S3 location**.
5. Paste the Amazon S3 link URL of your .zip file and choose **Save**.

Updating .zip file functions using the console code editor

For some functions with .zip deployment packages, you can use the Lambda console's built-in code editor to update your function code directly. To use this feature, your function must meet the following criteria:

- Your function must use one of the interpreted language runtimes (Python, Node.js, or Ruby)
- Your function's deployment package must be smaller than 50 MB (unzipped).

Function code for functions with container image deployment packages cannot be edited directly in the console.

To update function code using the console code editor

1. Open the [Functions page](#) of the Lambda console and select your function.
2. Select the **Code** tab.
3. In the **Code source** pane, select your source code file and edit it in the integrated code editor.
4. In the **DEPLOY** section, choose **Deploy** to update your function's code:

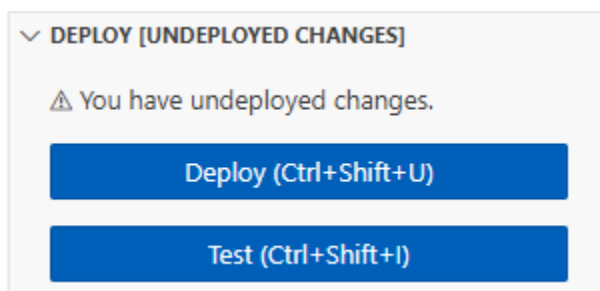

Creating and updating functions with .zip files using the AWS CLI

You can use the [AWS CLI](#) to create a new function or to update an existing one using a .zip file. Use the [create-function](#) and [update-function-code](#) commands to deploy your .zip package. If your .zip file is smaller than 50MB, you can upload the .zip package from a file location on your local build machine. For larger files, you must upload your .zip package from an Amazon S3 bucket. For instructions on how to upload a file to an Amazon S3 bucket using the AWS CLI, see [Move objects](#) in the *AWS CLI User Guide*.

Note

If you upload your .zip file from an Amazon S3 bucket using the AWS CLI, the bucket must be located in the same AWS Region as your function.

To create a new function using a .zip file with the AWS CLI, you must specify the following:

- The name of your function (`--function-name`)
- Your function's runtime (`--runtime`)
- The Amazon Resource Name (ARN) of your function's [execution role](#) (`--role`)
- The name of the handler method in your function code (`--handler`)

You must also specify the location of your .zip file. If your .zip file is located in a folder on your local build machine, use the `--zip-file` option to specify the file path, as shown in the following example command.

```
aws lambda create-function --function-name myFunction \  
--runtime python3.13 --handler lambda_function.lambda_handler \  
--role arn:aws:iam::111122223333:role/service-role/my-lambda-role \  
--zip-file fileb://myFunction.zip
```

To specify the location of .zip file in an Amazon S3 bucket, use the `--code` option as shown in the following example command. You only need to use the `S3ObjectVersion` parameter for versioned objects.

```
aws lambda create-function --function-name myFunction \  
--runtime python3.13 --handler lambda_function.lambda_handler \  
--role arn:aws:iam::111122223333:role/service-role/my-lambda-role \  
--code S3Bucket=amzn-s3-demo-  
bucket,S3Key=myFileName.zip,S3ObjectVersion=myObjectVersion
```

To update an existing function using the CLI, you specify the the name of your function using the `--function-name` parameter. You must also specify the location of the .zip file you want to use to update your function code. If your .zip file is located in a folder on your local build machine, use the `--zip-file` option to specify the file path, as shown in the following example command.

```
aws lambda update-function-code --function-name myFunction \  
--zip-file fileb://myFunction.zip
```

```
--zip-file fileb://myFunction.zip
```

To specify the location of .zip file in an Amazon S3 bucket, use the `--s3-bucket` and `--s3-key` options as shown in the following example command. You only need to use the `--s3-object-version` parameter for versioned objects.

```
aws lambda update-function-code --function-name myFunction \  
--s3-bucket amzn-s3-demo-bucket --s3-key myFileName.zip --s3-object-version myObject  
Version
```

Creating and updating functions with .zip files using the Lambda API

To create and update functions using a .zip file archive, use the following API operations:

- [CreateFunction](#)
- [UpdateFunctionCode](#)

Creating and updating functions with .zip files using AWS SAM

The AWS Serverless Application Model (AWS SAM) is a toolkit that helps streamline the process of building and running serverless applications on AWS. You define the resources for your application in a YAML or JSON template and use the AWS SAM command line interface (AWS SAM CLI) to build, package, and deploy your applications. When you build a Lambda function from an AWS SAM template, AWS SAM automatically creates a .zip deployment package or container image with your function code and any dependencies you specify. To learn more about using AWS SAM to build and deploy Lambda functions, see [Getting started with AWS SAM](#) in the *AWS Serverless Application Model Developer Guide*.

You can also use AWS SAM to create a Lambda function using an existing .zip file archive. To create a Lambda function using AWS SAM, you can save your .zip file in an Amazon S3 bucket or in a local folder on your build machine. For instructions on how to upload a file to an Amazon S3 bucket using the AWS CLI, see [Move objects](#) in the *AWS CLI User Guide*.

In your AWS SAM template, the `AWS::Serverless::Function` resource specifies your Lambda function. In this resource, set the following properties to create a function using a .zip file archive:

- `PackageType` - set to `Zip`
- `CodeUri` - set to the function code's Amazon S3 URI, path to local folder, or [FunctionCode](#) object
- `Runtime` - Set to your chosen runtime

With AWS SAM, if your .zip file is larger than 50MB, you don't need to upload it to an Amazon S3 bucket first. AWS SAM can upload .zip packages up to the maximum allowed size of 250MB (unzipped) from a location on your local build machine.

To learn more about deploying functions using .zip file in AWS SAM, see [AWS::Serverless::Function](#) in the *AWS SAM Developer Guide*.

Creating and updating functions with .zip files using AWS CloudFormation

You can use AWS CloudFormation to create a Lambda function using a .zip file archive. To create a Lambda function from a .zip file, you must first upload your file to an Amazon S3 bucket. For instructions on how to upload a file to an Amazon S3 bucket using the AWS CLI, see [Move objects](#) in the *AWS CLI User Guide*.

For Node.js and Python runtimes, you can also provide inline source code in your AWS CloudFormation template. AWS CloudFormation then creates a .zip file containing your code when you build your function.

Using an existing .zip file

In your AWS CloudFormation template, the `AWS::Lambda::Function` resource specifies your Lambda function. In this resource, set the following properties to create a function using a .zip file archive:

- `PackageType` - Set to `Zip`
- `Code` - Enter the Amazon S3 bucket name and the .zip file name in the `S3Bucket` and `S3Key` fields
- `Runtime` - Set to your chosen runtime

Creating a .zip file from inline code

You can declare simple functions written in Python or Node.js inline in an AWS CloudFormation template. Because the code is embedded in YAML or JSON, you can't add any external dependencies to your deployment package. This means your function has to use the version of the AWS SDK that's included in the runtime. The requirements of the template, such as having to escape certain characters, also make it harder to use your IDE's syntax checking and code completion features. This means that your template might require additional testing. Because of these limitations, declaring functions inline is best suited for very simple code that does not change frequently.

To create a .zip file from inline code for Node.js and Python runtimes, set the following properties in your template's `AWS::Lambda::Function` resource:

- `PackageType` - Set to `Zip`
- `Code` - Enter your function code in the `ZipFile` field
- `Runtime` - Set to your chosen runtime

The .zip file that AWS CloudFormation generates cannot exceed 4MB. To learn more about deploying functions using .zip file in AWS CloudFormation, see [AWS::Lambda::Function](#) in the *AWS CloudFormation User Guide*.

Deploy Python Lambda functions with container images

There are three ways to build a container image for a Python Lambda function:

- [Using an AWS base image for Python](#)

The [AWS base images](#) are preloaded with a language runtime, a runtime interface client to manage the interaction between Lambda and your function code, and a runtime interface emulator for local testing.

- [Using an AWS OS-only base image](#)

[AWS OS-only base images](#) contain an Amazon Linux distribution and the [runtime interface emulator](#). These images are commonly used to create container images for compiled languages, such as [Go](#) and [Rust](#), and for a language or language version that Lambda doesn't provide a base image for, such as Node.js 19. You can also use OS-only base images to implement a [custom runtime](#). To make the image compatible with Lambda, you must include the [runtime interface client for Python](#) in the image.

- [Using a non-AWS base image](#)

You can use an alternative base image from another container registry, such as Alpine Linux or Debian. You can also use a custom image created by your organization. To make the image compatible with Lambda, you must include the [runtime interface client for Python](#) in the image.

Tip

To reduce the time it takes for Lambda container functions to become active, see [Use multi-stage builds](#) in the Docker documentation. To build efficient container images, follow the [Best practices for writing Dockerfiles](#).

This page explains how to build, test, and deploy container images for Lambda.

Topics

- [AWS base images for Python](#)
- [Using an AWS base image for Python](#)
- [Using an alternative base image with the runtime interface client](#)

AWS base images for Python

AWS provides the following base images for Python:

Tags	Runtime	Operating system	Dockerfile	Deprecation
3.13	Python 3.13	Amazon Linux 2023	Dockerfile for Python 3.13 on GitHub	Not scheduled
3.12	Python 3.12	Amazon Linux 2023	Dockerfile for Python 3.12 on GitHub	Not scheduled
3.11	Python 3.11	Amazon Linux 2	Dockerfile for Python 3.11 on GitHub	Not scheduled
3.10	Python 3.10	Amazon Linux 2	Dockerfile for Python 3.10 on GitHub	Not scheduled
3.9	Python 3.9	Amazon Linux 2	Dockerfile for Python 3.9 on GitHub	Not scheduled

Amazon ECR repository: gallery.ecr.aws/lambda/python

Python 3.12 and later base images are based on the [Amazon Linux 2023 minimal container image](#). The Python 3.8-3.11 base images are based on the Amazon Linux 2 image. AL2023-based images provide several advantages over Amazon Linux 2, including a smaller deployment footprint and updated versions of libraries such as `glibc`.

AL2023-based images use `microdnf` (symlinked as `dnf`) as the package manager instead of `yum`, which is the default package manager in Amazon Linux 2. `microdnf` is a standalone implementation of `dnf`. For a list of packages that are included in AL2023-based images, refer to the **Minimal Container** columns in [Comparing packages installed on Amazon Linux 2023 Container Images](#). For more information about the differences between AL2023 and Amazon Linux 2, see [Introducing the Amazon Linux 2023 runtime for AWS Lambda](#) on the AWS Compute Blog.

Note

To run AL2023-based images locally, including with AWS Serverless Application Model (AWS SAM), you must use Docker version 20.10.10 or later.

Dependency search path in the base images

When you use an `import` statement in your code, the Python runtime searches the directories in its search path until it finds the module or package. By default, the runtime searches the `{LAMBDA_TASK_ROOT}` directory first. If you include a version of a runtime-included library in your image, your version will take precedence over the version that's included in the runtime.

Other steps in the search path depend on which version of the Lambda base image for Python you're using:

- **Python 3.11 and later:** Runtime-included libraries and pip-installed libraries are installed in the `/var/lang/lib/python3.11/site-packages` directory. This directory has precedence over `/var/runtime` in the search path. You can override the SDK by using pip to install a newer version. You can use pip to verify that the runtime-included SDK and its dependencies are compatible with any packages that you install.
- **Python 3.8-3.10:** Runtime-included libraries are installed in the `/var/runtime` directory. Pip-installed libraries are installed in the `/var/lang/lib/python3.x/site-packages` directory. The `/var/runtime` directory has precedence over `/var/lang/lib/python3.x/site-packages` in the search path.

You can see the full search path for your Lambda function by adding the following code snippet.

```
import sys

search_path = sys.path
print(search_path)
```

Using an AWS base image for Python

Prerequisites

To complete the steps in this section, you must have the following:

- [AWS CLI version 2](#)
- [Docker](#) (minimum version 20.10.10 for Python 3.12 and later base images)
- Python

Creating an image from a base image

To create a container image from an AWS base image for Python

1. Create a directory for the project, and then switch to that directory.

```
mkdir example
cd example
```

2. Create a new file called `lambda_function.py`. You can add the following sample function code to the file for testing, or use your own.

Example Python function

```
import sys
def handler(event, context):
    return 'Hello from AWS Lambda using Python' + sys.version + '!'
```

3. Create a new file called `requirements.txt`. If you're using the sample function code from the previous step, you can leave the file empty because there are no dependencies. Otherwise, list each required library. For example, here's what your `requirements.txt` should look like if your function uses the AWS SDK for Python (Boto3):

Example requirements.txt

```
boto3
```

4. Create a new Dockerfile with the following configuration:
 - Set the FROM property to the [URI of the base image](#).
 - Use the COPY command to copy the function code and runtime dependencies to `{LAMBDA_TASK_ROOT}`, a [Lambda-defined environment variable](#).
 - Set the CMD argument to the Lambda function handler.

Note that the example Dockerfile does not include a [USER instruction](#). When you deploy a container image to Lambda, Lambda automatically defines a default Linux user with least-privileged permissions. This is different from standard Docker behavior which defaults to the root user when no USER instruction is provided.

Example Dockerfile

```
FROM public.ecr.aws/lambda/python:3.12

# Copy requirements.txt
COPY requirements.txt ${LAMBDA_TASK_ROOT}

# Install the specified packages
RUN pip install -r requirements.txt

# Copy function code
COPY lambda_function.py ${LAMBDA_TASK_ROOT}

# Set the CMD to your handler (could also be done as a parameter override outside
  of the Dockerfile)
CMD [ "lambda_function.handler" ]
```

5. Build the Docker image with the [docker build](#) command. The following example names the image `docker-image` and gives it the test [tag](#).

```
docker build --platform linux/amd64 -t docker-image:test .
```

Note

The command specifies the `--platform linux/amd64` option to ensure that your container is compatible with the Lambda execution environment regardless of the architecture of your build machine. If you intend to create a Lambda function using the ARM64 instruction set architecture, be sure to change the command to use the `--platform linux/arm64` option instead.

(Optional) Test the image locally

1. Start the Docker image with the **docker run** command. In this example, `docker-image` is the image name and `test` is the tag.

```
docker run --platform linux/amd64 -p 9000:8080 docker-image:test
```

This command runs the image as a container and creates a local endpoint at `localhost:9000/2015-03-31/functions/function/invocations`.

Note

If you built the Docker image for the ARM64 instruction set architecture, be sure to use the `--platform linux/arm64` option instead of `--platform linux/amd64`.

2. From a new terminal window, post an event to the local endpoint.

Linux/macOS

In Linux and macOS, run the following `curl` command:

```
curl "http://localhost:9000/2015-03-31/functions/function/invocations" -d '{}'
```

This command invokes the function with an empty event and returns a response. If you're using your own function code rather than the sample function code, you might want to invoke the function with a JSON payload. Example:

```
curl "http://localhost:9000/2015-03-31/functions/function/invocations" -d  
'{"payload":"hello world!"}'
```

PowerShell

In PowerShell, run the following `Invoke-WebRequest` command:

```
Invoke-WebRequest -Uri "http://localhost:9000/2015-03-31/functions/function/  
invocations" -Method Post -Body '{}' -ContentType "application/json"
```

This command invokes the function with an empty event and returns a response. If you're using your own function code rather than the sample function code, you might want to invoke the function with a JSON payload. Example:

```
Invoke-WebRequest -Uri "http://localhost:9000/2015-03-31/functions/function/invocations" -Method Post -Body '{"payload":"hello world!"}' -ContentType "application/json"
```

3. Get the container ID.

```
docker ps
```

4. Use the [docker kill](#) command to stop the container. In this command, replace 3766c4ab331c with the container ID from the previous step.

```
docker kill 3766c4ab331c
```

Deploying the image

To upload the image to Amazon ECR and create the Lambda function

1. Run the [get-login-password](#) command to authenticate the Docker CLI to your Amazon ECR registry.
 - Set the `--region` value to the AWS Region where you want to create the Amazon ECR repository.
 - Replace 111122223333 with your AWS account ID.

```
aws ecr get-login-password --region us-east-1 | docker login --username AWS --password-stdin 111122223333.dkr.ecr.us-east-1.amazonaws.com
```

2. Create a repository in Amazon ECR using the [create-repository](#) command.

```
aws ecr create-repository --repository-name hello-world --region us-east-1 --image-scanning-configuration scanOnPush=true --image-tag-mutability MUTABLE
```

Note

The Amazon ECR repository must be in the same AWS Region as the Lambda function.

If successful, you see a response like this:

```
{
  "repository": {
    "repositoryArn": "arn:aws:ecr:us-east-1:111122223333:repository/hello-
world",
    "registryId": "111122223333",
    "repositoryName": "hello-world",
    "repositoryUri": "111122223333.dkr.ecr.us-east-1.amazonaws.com/hello-
world",
    "createdAt": "2023-03-09T10:39:01+00:00",
    "imageTagMutability": "MUTABLE",
    "imageScanningConfiguration": {
      "scanOnPush": true
    },
    "encryptionConfiguration": {
      "encryptionType": "AES256"
    }
  }
}
```

3. Copy the `repositoryUri` from the output in the previous step.
4. Run the [docker tag](#) command to tag your local image into your Amazon ECR repository as the latest version. In this command:
 - `docker-image:test` is the name and [tag](#) of your Docker image. This is the image name and tag that you specified in the `docker build` command.
 - Replace `<ECRrepositoryUri>` with the `repositoryUri` that you copied. Make sure to include `:latest` at the end of the URI.

```
docker tag docker-image:test <ECRrepositoryUri>:latest
```

Example:

```
docker tag docker-image:test 111122223333.dkr.ecr.us-east-1.amazonaws.com/hello-world:latest
```

5. Run the [docker push](#) command to deploy your local image to the Amazon ECR repository. Make sure to include `:latest` at the end of the repository URI.

```
docker push 111122223333.dkr.ecr.us-east-1.amazonaws.com/hello-world:latest
```

6. [Create an execution role](#) for the function, if you don't already have one. You need the Amazon Resource Name (ARN) of the role in the next step.
7. Create the Lambda function. For `ImageUri`, specify the repository URI from earlier. Make sure to include `:latest` at the end of the URI.

```
aws lambda create-function \  
  --function-name hello-world \  
  --package-type Image \  
  --code ImageUri=111122223333.dkr.ecr.us-east-1.amazonaws.com/hello-world:latest \  
  --role arn:aws:iam::111122223333:role/lambda-ex
```

Note

You can create a function using an image in a different AWS account, as long as the image is in the same Region as the Lambda function. For more information, see [Amazon ECR cross-account permissions](#).

8. Invoke the function.

```
aws lambda invoke --function-name hello-world response.json
```

You should see a response like this:

```
{  
  "ExecutedVersion": "$LATEST",  
  "StatusCode": 200  
}
```

9. To see the output of the function, check the `response.json` file.

To update the function code, you must build the image again, upload the new image to the Amazon ECR repository, and then use the [update-function-code](#) command to deploy the image to the Lambda function.

Lambda resolves the image tag to a specific image digest. This means that if you point the image tag that was used to deploy the function to a new image in Amazon ECR, Lambda doesn't automatically update the function to use the new image.

To deploy the new image to the same Lambda function, you must use the [update-function-code](#) command, even if the image tag in Amazon ECR remains the same. In the following example, the `--publish` option creates a new version of the function using the updated container image.

```
aws lambda update-function-code \  
  --function-name hello-world \  
  --image-uri 111122223333.dkr.ecr.us-east-1.amazonaws.com/hello-world:latest \  
  --publish
```

Using an alternative base image with the runtime interface client

If you use an [OS-only base image](#) or an alternative base image, you must include the runtime interface client in your image. The runtime interface client extends the [Using the Lambda runtime API for custom runtimes](#), which manages the interaction between Lambda and your function code.

Install the [runtime interface client for Python](#) using the pip package manager:

```
pip install awslambdaric
```

You can also download the [Python runtime interface client](#) from GitHub.

The following example demonstrates how to build a container image for Python using a non-AWS base image. The example Dockerfile uses an official Python base image. The Dockerfile includes the runtime interface client for Python.

Prerequisites

To complete the steps in this section, you must have the following:

- [AWS CLI version 2](#)
- [Docker](#)
- Python

Creating an image from an alternative base image

To create a container image from a non-AWS base image

1. Create a directory for the project, and then switch to that directory.

```
mkdir example
cd example
```

2. Create a new file called `lambda_function.py`. You can add the following sample function code to the file for testing, or use your own.

Example Python function

```
import sys
def handler(event, context):
    return 'Hello from AWS Lambda using Python' + sys.version + '!'
```

3. Create a new file called `requirements.txt`. If you're using the sample function code from the previous step, you can leave the file empty because there are no dependencies. Otherwise, list each required library. For example, here's what your `requirements.txt` should look like if your function uses the AWS SDK for Python (Boto3):

Example requirements.txt

```
boto3
```

4. Create a new Dockerfile. The following Dockerfile uses an official Python base image instead of an [AWS base image](#). The Dockerfile includes the [runtime interface client](#), which makes the image compatible with Lambda. The following example Dockerfile uses a [multi-stage build](#).

- Set the FROM property to the base image.
- Set the ENTRYPOINT to the module that you want the Docker container to run when it starts. In this case, the module is the runtime interface client.
- Set the CMD to the Lambda function handler.

Note that the example Dockerfile does not include a [USER instruction](#). When you deploy a container image to Lambda, Lambda automatically defines a default Linux user with least-

privileged permissions. This is different from standard Docker behavior which defaults to the root user when no USER instruction is provided.

Example Dockerfile

```
# Define custom function directory
ARG FUNCTION_DIR="/function"

FROM python:3.12 AS build-image

# Include global arg in this stage of the build
ARG FUNCTION_DIR

# Copy function code
RUN mkdir -p ${FUNCTION_DIR}
COPY . ${FUNCTION_DIR}

# Install the function's dependencies
RUN pip install \
    --target ${FUNCTION_DIR} \
        awslambdaric

# Use a slim version of the base Python image to reduce the final image size
FROM python:3.12-slim

# Include global arg in this stage of the build
ARG FUNCTION_DIR
# Set working directory to function root directory
WORKDIR ${FUNCTION_DIR}

# Copy in the built dependencies
COPY --from=build-image ${FUNCTION_DIR} ${FUNCTION_DIR}

# Set runtime interface client as default command for the container runtime
ENTRYPOINT [ "/usr/local/bin/python", "-m", "awslambdaric" ]
# Pass the name of the function handler as an argument to the runtime
CMD [ "lambda_function.handler" ]
```

5. Build the Docker image with the [docker build](#) command. The following example names the image `docker-image` and gives it the test [tag](#).

```
docker build --platform linux/amd64 -t docker-image:test .
```

Note

The command specifies the `--platform linux/amd64` option to ensure that your container is compatible with the Lambda execution environment regardless of the architecture of your build machine. If you intend to create a Lambda function using the ARM64 instruction set architecture, be sure to change the command to use the `--platform linux/arm64` option instead.

(Optional) Test the image locally

Use the [runtime interface emulator](#) to locally test the image. You can [build the emulator into your image](#) or use the following procedure to install it on your local machine.

To install and run the runtime interface emulator on your local machine

1. From your project directory, run the following command to download the runtime interface emulator (x86-64 architecture) from GitHub and install it on your local machine.

Linux/macOS

```
mkdir -p ~/.aws-lambda-rie && \  
  curl -Lo ~/.aws-lambda-rie/aws-lambda-rie https://github.com/aws/aws-lambda-  
runtime-interface-emulator/releases/latest/download/aws-lambda-rie && \  
  chmod +x ~/.aws-lambda-rie/aws-lambda-rie
```

To install the arm64 emulator, replace the GitHub repository URL in the previous command with the following:

```
https://github.com/aws/aws-lambda-runtime-interface-emulator/releases/latest/  
download/aws-lambda-rie-arm64
```

PowerShell

```
$dirPath = "$HOME\.aws-lambda-rie"  
if (-not (Test-Path $dirPath)) {  
    New-Item -Path $dirPath -ItemType Directory  
}
```

```
$downloadLink = "https://github.com/aws/aws-lambda-runtime-interface-emulator/
releases/latest/download/aws-lambda-rie"
$destinationPath = "$HOME\.aws-lambda-rie\aws-lambda-rie"
Invoke-WebRequest -Uri $downloadLink -OutFile $destinationPath
```

To install the arm64 emulator, replace the `$downloadLink` with the following:

```
https://github.com/aws/aws-lambda-runtime-interface-emulator/releases/latest/
download/aws-lambda-rie-arm64
```

2. Start the Docker image with the **docker run** command. Note the following:

- `docker-image` is the image name and `test` is the tag.
- `/usr/local/bin/python -m awslambdarc lambda_function.handler` is the ENTRYPOINT followed by the CMD from your Dockerfile.

Linux/macOS

```
docker run --platform linux/amd64 -d -v ~/.aws-lambda-rie:/aws-lambda -p
9000:8080 \
  --entrypoint /aws-lambda/aws-lambda-rie \
  docker-image:test \
  /usr/local/bin/python -m awslambdarc lambda_function.handler
```

PowerShell

```
docker run --platform linux/amd64 -d -v "$HOME\.aws-lambda-rie:/aws-lambda" -p
9000:8080 `
--entrypoint /aws-lambda/aws-lambda-rie `
docker-image:test `
/usr/local/bin/python -m awslambdarc lambda_function.handler
```

This command runs the image as a container and creates a local endpoint at `localhost:9000/2015-03-31/functions/function/invocations`.

Note

If you built the Docker image for the ARM64 instruction set architecture, be sure to use the `--platform linux/arm64` option instead of `--platform linux/amd64`.

3. Post an event to the local endpoint.

Linux/macOS

In Linux and macOS, run the following `curl` command:

```
curl "http://localhost:9000/2015-03-31/functions/function/invocations" -d '{}'
```

This command invokes the function with an empty event and returns a response. If you're using your own function code rather than the sample function code, you might want to invoke the function with a JSON payload. Example:

```
curl "http://localhost:9000/2015-03-31/functions/function/invocations" -d '{"payload": "hello world!"}'
```

PowerShell

In PowerShell, run the following `Invoke-WebRequest` command:

```
Invoke-WebRequest -Uri "http://localhost:9000/2015-03-31/functions/function/invocations" -Method Post -Body '{}' -ContentType "application/json"
```

This command invokes the function with an empty event and returns a response. If you're using your own function code rather than the sample function code, you might want to invoke the function with a JSON payload. Example:

```
Invoke-WebRequest -Uri "http://localhost:9000/2015-03-31/functions/function/invocations" -Method Post -Body '{"payload": "hello world!"}' -ContentType "application/json"
```

4. Get the container ID.

```
docker ps
```

5. Use the [docker kill](#) command to stop the container. In this command, replace `3766c4ab331c` with the container ID from the previous step.

```
docker kill 3766c4ab331c
```

Deploying the image

To upload the image to Amazon ECR and create the Lambda function

1. Run the [get-login-password](#) command to authenticate the Docker CLI to your Amazon ECR registry.
 - Set the `--region` value to the AWS Region where you want to create the Amazon ECR repository.
 - Replace `111122223333` with your AWS account ID.

```
aws ecr get-login-password --region us-east-1 | docker login --username AWS --password-stdin 111122223333.dkr.ecr.us-east-1.amazonaws.com
```

2. Create a repository in Amazon ECR using the [create-repository](#) command.

```
aws ecr create-repository --repository-name hello-world --region us-east-1 --image-scanning-configuration scanOnPush=true --image-tag-mutability MUTABLE
```

Note

The Amazon ECR repository must be in the same AWS Region as the Lambda function.

If successful, you see a response like this:

```
{
  "repository": {
    "repositoryArn": "arn:aws:ecr:us-east-1:111122223333:repository/hello-world",
    "registryId": "111122223333",
    "repositoryName": "hello-world",
```

```
    "repositoryUri": "111122223333.dkr.ecr.us-east-1.amazonaws.com/hello-
world",
    "createdAt": "2023-03-09T10:39:01+00:00",
    "imageTagMutability": "MUTABLE",
    "imageScanningConfiguration": {
      "scanOnPush": true
    },
    "encryptionConfiguration": {
      "encryptionType": "AES256"
    }
  }
}
```

3. Copy the `repositoryUri` from the output in the previous step.
4. Run the [docker tag](#) command to tag your local image into your Amazon ECR repository as the latest version. In this command:
 - `docker-image:test` is the name and [tag](#) of your Docker image. This is the image name and tag that you specified in the `docker build` command.
 - Replace `<ECRrepositoryUri>` with the `repositoryUri` that you copied. Make sure to include `:latest` at the end of the URI.

```
docker tag docker-image:test <ECRrepositoryUri>:latest
```

Example:

```
docker tag docker-image:test 111122223333.dkr.ecr.us-east-1.amazonaws.com/hello-
world:latest
```

5. Run the [docker push](#) command to deploy your local image to the Amazon ECR repository. Make sure to include `:latest` at the end of the repository URI.

```
docker push 111122223333.dkr.ecr.us-east-1.amazonaws.com/hello-world:latest
```

6. [Create an execution role](#) for the function, if you don't already have one. You need the Amazon Resource Name (ARN) of the role in the next step.
7. Create the Lambda function. For `ImageUri`, specify the repository URI from earlier. Make sure to include `:latest` at the end of the URI.

```
aws lambda create-function \  
  --function-name hello-world \  
  --package-type Image \  
  --code ImageUri=111122223333.dkr.ecr.us-east-1.amazonaws.com/hello-world:latest \  
  --role arn:aws:iam::111122223333:role/lambda-ex
```

Note

You can create a function using an image in a different AWS account, as long as the image is in the same Region as the Lambda function. For more information, see [Amazon ECR cross-account permissions](#).

8. Invoke the function.

```
aws lambda invoke --function-name hello-world response.json
```

You should see a response like this:

```
{  
  "ExecutedVersion": "$LATEST",  
  "StatusCode": 200  
}
```

9. To see the output of the function, check the `response.json` file.

To update the function code, you must build the image again, upload the new image to the Amazon ECR repository, and then use the [update-function-code](#) command to deploy the image to the Lambda function.

Lambda resolves the image tag to a specific image digest. This means that if you point the image tag that was used to deploy the function to a new image in Amazon ECR, Lambda doesn't automatically update the function to use the new image.

To deploy the new image to the same Lambda function, you must use the [update-function-code](#) command, even if the image tag in Amazon ECR remains the same. In the following example, the `--publish` option creates a new version of the function using the updated container image.

```
aws lambda update-function-code \  
  --publish
```

```
--function-name hello-world \  
--image-uri 111122223333.dkr.ecr.us-east-1.amazonaws.com/hello-world:latest \  
--publish
```

For an example of how to create a Python image from an Alpine base image, see [Container image support for Lambda](#) on the AWS Blog.

Working with layers for Python Lambda functions

A [Lambda layer](#) is a .zip file archive that contains supplementary code or data. Layers usually contain library dependencies, a [custom runtime](#), or configuration files. Creating a layer involves three general steps:

1. Package your layer content. This means creating a .zip file archive that contains the dependencies you want to use in your functions.
2. Create the layer in Lambda.
3. Add the layer to your functions.

This topic contains steps and guidance on how to properly package and create a Python Lambda layer with external library dependencies.

Topics

- [Prerequisites](#)
- [Python layer compatibility with Amazon Linux](#)
- [Layer paths for Python runtimes](#)
- [Packaging the layer content](#)
- [Creating the layer](#)
- [Adding the layer to your function](#)
- [Working with manylinux wheel distributions](#)

Prerequisites

To follow the steps in this section, you must have the following:

- [Python 3.11](#) and the [pip](#) package installer
- [AWS CLI version 2](#)

Throughout this topic, we reference the [layer-python](#) sample application on the **awsdocs** GitHub repository. This application contains scripts that download the dependencies and generate the layers. The application also contains corresponding functions that use dependencies from the layers. After creating a layer, you can deploy and invoke the corresponding function to verify that

everything works properly. Because you use the Python 3.11 runtime for the functions, the layers must also be compatible with Python 3.11.

In the `layer-python` sample application, there are two examples:

- The first example involves packaging the [requests](#) library into a Lambda layer. The `layer/` directory contains the scripts to generate the layer. The `function/` directory contains a sample function to help test that the layer works. The majority of this tutorial walks through how to create and package this layer.
- The second example involves packaging the [numpy](#) library into a Lambda layer. The `layer-numpy/` directory contains the scripts to generate the layer. The `function-numpy/` directory contains a sample function to help test that the layer works. For an example of how to create and package this layer, see [the section called “Working with manylinux wheel distributions”](#).

Python layer compatibility with Amazon Linux

The first step to creating a layer is to bundle all of your layer content into a .zip file archive. Because Lambda functions run on [Amazon Linux](#), your layer content must be able to compile and build in a Linux environment.

In Python, most packages are available as [wheels](#) (.whl files) in addition to the source distribution. Each wheel is a type of built distribution that supports a specific combination of Python versions, operating systems, and machine instruction sets.

Wheels are useful for ensuring that your layer is compatible with Amazon Linux. When you download your dependencies, download the *universal wheel* if possible. (By default, pip installs the universal wheel if one is available.) The universal wheel contains any as the platform tag, indicating that it's compatible with all platforms, including Amazon Linux.

In the example that follows, you package the `requests` library into a Lambda layer. The `requests` library is an example of a package that's available as a universal wheel.

Not all Python packages are distributed as universal wheels. For example, [numpy](#) has multiple wheel distributions, each supporting a different set of platforms. For such packages, download the `manylinux` distribution to ensure compatibility with Amazon Linux. For detailed instructions about how to package such layers, see [the section called “Working with manylinux wheel distributions”](#).

In rare cases, a Python package might not be available as a wheel. If only the [source distribution](#) (*sdist*) exists, then we recommend installing and packaging your dependencies in a [Docker](#)

environment based on the [Amazon Linux 2023 base container image](#). We also recommend this approach if you want to include your own custom libraries written in other languages such as C/C++. This approach mimics the Lambda execution environment in Docker, and ensures that your non-Python package dependencies are compatible with Amazon Linux.

Layer paths for Python runtimes

When you add a layer to a function, Lambda loads the layer content into the `/opt` directory of that execution environment. For each Lambda runtime, the `PATH` variable already includes specific folder paths within the `/opt` directory. To ensure that Lambda picks up your layer content, your layer `.zip` file should have its dependencies in the following folder paths:

- `python`
- `python/lib/python3.x/site-packages`

For example, the resulting layer `.zip` file that you create in this tutorial has the following directory structure:

```
layer_content.zip
# python
  # lib
    # python3.11
      # site-packages
        # requests
        # <other_dependencies> (i.e. dependencies of the requests package)
        # ...
```

The [requests](#) library is correctly located in the `python/lib/python3.11/site-packages` directory. This ensures that Lambda can locate the library during function invocations.

Packaging the layer content

In this example, you package the Python `requests` library in a layer `.zip` file. Complete the following steps to install and package the layer content.

To install and package your layer content

1. Clone the [aws-lambda-developer-guide GitHub repo](#), which contains the sample code that you need in the `sample-apps/layer-python` directory.

```
git clone https://github.com/awsdocs/aws-lambda-developer-guide.git
```

2. Navigate to the `layer` directory of the `layer-python` sample app. This directory contains the scripts that you use to create and package the layer properly.

```
cd aws-lambda-developer-guide/sample-apps/layer-python/layer
```

3. Examine the [requirements.txt](#) file. This file defines the dependencies that you want to include in the layer, namely the `requests` library. You can update this file to include any dependencies that you want to include in your own layer.

Example requirements.txt

```
requests==2.31.0
```

4. Ensure that you have permissions to run both scripts.

```
chmod 744 1-install.sh && chmod 744 2-package.sh
```

5. Run the [1-install.sh](#) script using the following command:

```
./1-install.sh
```

This script uses `venv` to create a Python virtual environment named `create_layer`. It then installs all required dependencies in the `create_layer/lib/python3.11/site-packages` directory.

Example 1-install.sh

```
python3.11 -m venv create_layer
source create_layer/bin/activate
pip install -r requirements.txt
```

6. Run the [2-package.sh](#) script using the following command:

```
./2-package.sh
```

This script copies the contents from the `create_layer/lib` directory into a new directory named `python`. It then zips the contents of the `python` directory into a file named

`layer_content.zip`. This is the `.zip` file for your layer. You can unzip the file and verify that it contains the correct file structure, as shown in the [the section called “Layer paths for Python runtimes”](#) section.

Example 2-package.sh

```
mkdir python
cp -r create_layer/lib python/
zip -r layer_content.zip python
```

Creating the layer

In this section, you take the `layer_content.zip` file that you generated in the previous section and upload it as a Lambda layer. You can upload a layer using the AWS Management Console or the Lambda API via the AWS Command Line Interface (AWS CLI). When you upload your layer `.zip` file, in the following [PublishLayerVersion](#) AWS CLI command, specify `python3.11` as the compatible runtime and `arm64` as the compatible architecture.

```
aws lambda publish-layer-version --layer-name python-requests-layer \
  --zip-file fileb://layer_content.zip \
  --compatible-runtimes python3.11 \
  --compatible-architectures "arm64"
```

From the response, note the `LayerVersionArn`, which looks like `arn:aws:lambda:us-east-1:123456789012:layer:python-requests-layer:1`. You'll need this Amazon Resource Name (ARN) in the next step of this tutorial, when you add the layer to your function.

Adding the layer to your function

In this section, you deploy a sample Lambda function that uses the `requests` library in its function code, then you attach the layer. To deploy the function, you need an [execution role](#). If you don't have an existing execution role, follow the steps in the collapsible section.

(Optional) Create an execution role

To create an execution role

1. Open the [roles page](#) in the IAM console.
2. Choose **Create role**.

3. Create a role with the following properties.
 - **Trusted entity – Lambda.**
 - **Permissions – `AWSLambdaBasicExecutionRole`.**
 - **Role name – `lambda-role`.**

The **`AWSLambdaBasicExecutionRole`** policy has the permissions that the function needs to write logs to CloudWatch Logs.

The Lambda [function code](#) imports the `requests` library, makes a simple HTTP request, and then returns the status code and body.

```
import requests

def lambda_handler(event, context):
    print(f"Version of requests library: {requests.__version__}")
    request = requests.get('https://api.github.com/')
    return {
        'statusCode': request.status_code,
        'body': request.text
    }
```

To deploy the Lambda function

1. Navigate to the `function/` directory. If you're currently in the `layer/` directory, then run the following command:

```
cd ../function
```

2. Create a `.zip` file deployment package using the following command:

```
zip my_deployment_package.zip lambda_function.py
```

3. Deploy the function. In the following AWS CLI command, replace the `--role` parameter with your execution role ARN:

```
aws lambda create-function --function-name python_function_with_layer \  
    --runtime python3.11 \  
    --architectures "arm64" \  
    --role arn:aws:iam::123456789012:role/lambda-role
```

```
--handler lambda_function.lambda_handler \  
--role arn:aws:iam::123456789012:role/lambda-role \  
--zip-file fileb://my_deployment_package.zip
```

4. Next, attach the layer to your function. In the following AWS CLI command, replace the `--layers` parameter with the layer version ARN that you noted earlier:

```
aws lambda update-function-configuration --function-name python_function_with_layer \  
\  
--cli-binary-format raw-in-base64-out \  
--layers "arn:aws:lambda:us-east-1:123456789012:layer:python-requests-layer:1"
```

5. Finally, try to invoke your function using the following AWS CLI command:

```
aws lambda invoke --function-name python_function_with_layer \  
--cli-binary-format raw-in-base64-out \  
--payload '{ "key": "value" }' response.json
```

You should see output that looks like this:

```
{  
  "StatusCode": 200,  
  "ExecutedVersion": "$LATEST"  
}
```

The output `response.json` file contains details about the response.

(Optional) Clean up your resources

You can now delete the resources that you created for this tutorial, unless you want to retain them. By deleting AWS resources that you're no longer using, you prevent unnecessary charges to your AWS account.

To delete the Lambda layer

1. Open the [Layers page](#) of the Lambda console.
2. Select the layer that you created.
3. Choose **Delete**, then choose **Delete** again.

To delete the Lambda function

1. Open the [Functions page](#) of the Lambda console.
2. Select the function that you created.
3. Choose **Actions, Delete**.
4. Type **confirm** in the text input field and choose **Delete**.

Working with manylinux wheel distributions

Sometimes, a package that you want to include as a dependency won't have a *universal wheel* (specifically, it doesn't have any as the platform tag). In this case, download the wheel that supports manylinux instead. This ensures that your layer libraries are compatible with Amazon Linux.

[numpy](#) is one package that doesn't have a universal wheel. If you want to include the numpy package in your layer, then you can complete the following example steps to install and package your layer properly.

To install and package your layer content

1. Clone the [aws-lambda-developer-guide GitHub repo](#), which contains the sample code that you need in the `sample-apps/layer-python` directory.

```
git clone https://github.com/awsdocs/aws-lambda-developer-guide.git
```

2. Navigate to the `layer-numpy` directory of the `layer-python` sample app. This directory contains the scripts that you use to create and package the layer properly.

```
cd aws-lambda-developer-guide/sample-apps/layer-python/layer-numpy
```

3. Examine the [requirements.txt](#) file. This file defines the dependencies that you want to include in your layer, namely the numpy library. Here, you specify the URL of the manylinux wheel distribution that's compatible with Python 3.11, Amazon Linux, and the x86_64 instruction set:

Example requirements.txt

```
https://files.pythonhosted.org/packages/3a/d0/
edc009c27b406c4f9cbc79274d6e46d634d139075492ad055e3d68445925/numpy-1.26.4-cp311-
cp311-manylinux_2_17_x86_64.manylinux2014_x86_64.whl
```

4. Ensure that you have permissions to run both scripts.

```
chmod 744 1-install.sh && chmod 744 2-package.sh
```

5. Run the [1-install.sh](#) script using the following command:

```
./1-install.sh
```

This script uses `venv` to create a Python virtual environment named `create_layer`. It then installs all required dependencies in the `create_layer/lib/python3.11/site-packages` directory. The `pip` command is different in this case, because you must specify the `--platform` tag as `manylinux2014_x86_64`. This tells `pip` to install the correct `manylinux` wheel, even if your local machine uses macOS or Windows.

Example 1-install.sh

```
python3.11 -m venv create_layer
source create_layer/bin/activate
pip install -r requirements.txt --platform=manylinux2014_x86_64 --only-binary=:all:
--target ./create_layer/lib/python3.11/site-packages
```

6. Run the [2-package.sh](#) script using the following command:

```
./2-package.sh
```

This script copies the contents from the `create_layer/lib` directory into a new directory named `python`. It then zips the contents of the `python` directory into a file named `layer_content.zip`. This is the `.zip` file for your layer. You can unzip the file and verify that it contains the correct file structure as shown in the [the section called “Layer paths for Python runtimes”](#) section.

Example 2-package.sh

```
mkdir python
cp -r create_layer/lib python/
zip -r layer_content.zip python
```

To upload this layer to Lambda, use the following [PublishLayerVersion](#) AWS CLI command:

```
aws lambda publish-layer-version --layer-name python-numpy-layer \
  --zip-file fileb://layer_content.zip \
  --compatible-runtimes python3.11 \
  --compatible-architectures "x86_64"
```

From the response, note the `LayerVersionArn`, which looks like `arn:aws:lambda:us-east-1:123456789012:layer:python-numpy-layer:1`. To verify that your layer works as expected, deploy the Lambda function in the `function-numpy` directory.

To deploy the Lambda function

1. Navigate to the `function-numpy/` directory. If you're currently in the `layer-numpy/` directory, then run the following command:

```
cd ../function-numpy
```

2. Review the [function code](#). The function imports the `numpy` library, creates a simple `numpy` array, and then returns a dummy status code and body.

```
import json
import numpy as np

def lambda_handler(event, context):

    x = np.arange(15, dtype=np.int64).reshape(3, 5)
    print(x)

    return {
        'statusCode': 200,
        'body': json.dumps('Hello from Lambda!')
    }
```

3. Create a .zip file deployment package using the following command:

```
zip my_deployment_package.zip lambda_function.py
```

4. Deploy the function. In the following AWS CLI command, replace the `--role` parameter with your execution role ARN:

```
aws lambda create-function --function-name python_function_with_numpy \  
  --runtime python3.11 \  
  --handler lambda_function.lambda_handler \  
  --role arn:aws:iam::123456789012:role/lambda-role \  
  --zip-file fileb://my_deployment_package.zip
```

5. Next, attach the layer to your function. In the following AWS CLI command, replace the `--layers` parameter with your layer version ARN:

```
aws lambda update-function-configuration --function-name python_function_with_numpy \  
  \  
  --cli-binary-format raw-in-base64-out \  
  --layers "arn:aws:lambda:us-east-1:123456789012:layer:python-requests-layer:1"
```

6. Finally, try to invoke your function using the following AWS CLI command:

```
aws lambda invoke --function-name python_function_with_numpy \  
  --cli-binary-format raw-in-base64-out \  
  --payload '{ "key": "value" }' response.json
```

You should see output that looks like this:

```
{  
  "StatusCode": 200,  
  "ExecutedVersion": "$LATEST"  
}
```

You can examine the function logs to verify that the code prints the numpy array to standard out.

Using the Lambda context object to retrieve Python function information

When Lambda runs your function, it passes a context object to the [handler](#). This object provides methods and properties that provide information about the invocation, function, and execution environment. For more information on how the context object is passed to the function handler, see [Define Lambda function handler in Python](#).

Context methods

- `get_remaining_time_in_millis` – Returns the number of milliseconds left before the execution times out.

Context properties

- `function_name` – The name of the Lambda function.
- `function_version` – The [version](#) of the function.
- `invoked_function_arn` – The Amazon Resource Name (ARN) that's used to invoke the function. Indicates if the invoker specified a version number or alias.
- `memory_limit_in_mb` – The amount of memory that's allocated for the function.
- `aws_request_id` – The identifier of the invocation request.
- `log_group_name` – The log group for the function.
- `log_stream_name` – The log stream for the function instance.
- `identity` – (mobile apps) Information about the Amazon Cognito identity that authorized the request.
 - `cognito_identity_id` – The authenticated Amazon Cognito identity.
 - `cognito_identity_pool_id` – The Amazon Cognito identity pool that authorized the invocation.
- `client_context` – (mobile apps) Client context that's provided to Lambda by the client application.
 - `client.installation_id`
 - `client.app_title`
 - `client.app_version_name`
 - `client.app_version_code`

- `client.app_package_name`
- `custom` – A dict of custom values set by the mobile client application.
- `env` – A dict of environment information provided by the AWS SDK.

Powertools for Lambda (Python) provides an interface definition for the Lambda context object. You can use the interface definition for type hints, or to further inspect the structure of the Lambda context object. For the interface definition, see [lambda_context.py](#) in the *powertools-lambda-python* repository on GitHub.

The following example shows a handler function that logs context information.

Example handler.py

```
import time

def lambda_handler(event, context):
    print("Lambda function ARN:", context.invoked_function_arn)
    print("CloudWatch log stream name:", context.log_stream_name)
    print("CloudWatch log group name:", context.log_group_name)
    print("Lambda Request ID:", context.aws_request_id)
    print("Lambda function memory limits in MB:", context.memory_limit_in_mb)
    # We have added a 1 second delay so you can see the time remaining in
    get_remaining_time_in_millis.
    time.sleep(1)
    print("Lambda time remaining in MS:", context.get_remaining_time_in_millis())
```

In addition to the options listed above, you can also use the AWS X-Ray SDK for [Instrumenting Python code in AWS Lambda](#) to identify critical code paths, trace their performance and capture the data for analysis.

Log and monitor Python Lambda functions

AWS Lambda automatically monitors Lambda functions and sends log entries to Amazon CloudWatch. Your Lambda function comes with a CloudWatch Logs log group and a log stream for each instance of your function. The Lambda runtime environment sends details about each invocation and other output from your function's code to the log stream. For more information about CloudWatch Logs, see [Using CloudWatch Logs with Lambda](#).

To output logs from your function code, you can use the built-in [logging](#) module. For more detailed entries, you can use any logging library that writes to `stdout` or `stderr`.

Printing to the log

To send basic output to the logs, you can use a `print` method in your function. The following example logs the values of the CloudWatch Logs log group and stream, and the event object.

Note that if your function outputs logs using Python `print` statements, Lambda can only send log outputs to CloudWatch Logs in plain text format. To capture logs in structured JSON, you need to use a supported logging library. See [the section called “Using Lambda advanced logging controls with Python”](#) for more information.

Example `lambda_function.py`

```
import os
def lambda_handler(event, context):
    print('## ENVIRONMENT VARIABLES')
    print(os.environ['AWS_LAMBDA_LOG_GROUP_NAME'])
    print(os.environ['AWS_LAMBDA_LOG_STREAM_NAME'])
    print('## EVENT')
    print(event)
```

Example log output

```
START RequestId: 8f507cfc-xmpl-4697-b07a-ac58fc914c95 Version: $LATEST
## ENVIRONMENT VARIABLES
/aws/lambda/my-function
2023/08/31/[$LATEST]3893xmpl7fac4485b47bb75b671a283c
## EVENT
{'key': 'value'}
```

```
END RequestId: 8f507cfc-xmpl-4697-b07a-ac58fc914c95
REPORT RequestId: 8f507cfc-xmpl-4697-b07a-ac58fc914c95 Duration: 15.74 ms Billed
  Duration: 16 ms Memory Size: 128 MB Max Memory Used: 56 MB Init Duration: 130.49 ms
XRAY TraceId: 1-5e34a614-10bdxmplf1fb44f07bc535a1 SegmentId: 07f5xmpl2d1f6f85
  Sampled: true
```

The Python runtime logs the START, END, and REPORT lines for each invocation. The REPORT line includes the following data:

REPORT line data fields

- **RequestId** – The unique request ID for the invocation.
- **Duration** – The amount of time that your function's handler method spent processing the event.
- **Billed Duration** – The amount of time billed for the invocation.
- **Memory Size** – The amount of memory allocated to the function.
- **Max Memory Used** – The amount of memory used by the function. When invocations share an execution environment, Lambda reports the maximum memory used across all invocations. This behavior might result in a higher than expected reported value.
- **Init Duration** – For the first request served, the amount of time it took the runtime to load the function and run code outside of the handler method.
- **XRAY TraceId** – For traced requests, the [AWS X-Ray trace ID](#).
- **SegmentId** – For traced requests, the X-Ray segment ID.
- **Sampled** – For traced requests, the sampling result.

Using a logging library

For more detailed logs, use the [logging](#) module in the standard library, or any third party logging library that writes to `stdout` or `stderr`.

For supported Python runtimes, you can choose whether logs created using the standard logging module are captured in plain text or JSON. To learn more, see [the section called "Using Lambda advanced logging controls with Python"](#).

Currently, the default log format for all Python runtimes is plain text. The following example shows how log outputs created using the standard logging module are captured in plain text in CloudWatch Logs.

```
import os
import logging
logger = logging.getLogger()
logger.setLevel("INFO")

def lambda_handler(event, context):
    logger.info('## ENVIRONMENT VARIABLES')
    logger.info(os.environ['AWS_LAMBDA_LOG_GROUP_NAME'])
    logger.info(os.environ['AWS_LAMBDA_LOG_STREAM_NAME'])
    logger.info('## EVENT')
    logger.info(event)
```

The output from `logger` includes the log level, timestamp, and request ID.

```
START RequestId: 1c8df7d3-xmpl-46da-9778-518e6eca8125 Version: $LATEST
[INFO] 2023-08-31T22:12:58.534Z 1c8df7d3-xmpl-46da-9778-518e6eca8125 ##
ENVIRONMENT VARIABLES
[INFO] 2023-08-31T22:12:58.534Z 1c8df7d3-xmpl-46da-9778-518e6eca8125 /aws/
lambda/my-function
[INFO] 2023-08-31T22:12:58.534Z 1c8df7d3-xmpl-46da-9778-518e6eca8125 2023/01/31/
[$LATEST]1bbe51xmplb34a2788dbaa7433b0aa4d
[INFO] 2023-08-31T22:12:58.535Z 1c8df7d3-xmpl-46da-9778-518e6eca8125 ## EVENT
[INFO] 2023-08-31T22:12:58.535Z 1c8df7d3-xmpl-46da-9778-518e6eca8125 {'key':
'value'}
END RequestId: 1c8df7d3-xmpl-46da-9778-518e6eca8125
REPORT RequestId: 1c8df7d3-xmpl-46da-9778-518e6eca8125 Duration: 2.75 ms Billed
Duration: 3 ms Memory Size: 128 MB Max Memory Used: 56 MB Init Duration: 113.51 ms
XRAY TraceId: 1-5e34a66a-474xmpl7c2534a87870b4370 SegmentId: 073cxmpl3e442861
Sampled: true
```

Note

When your function's log format is set to plain text, the default log-level setting for Python runtimes is `WARN`. This means that Lambda only sends log outputs of level `WARN` and lower to CloudWatch Logs. To change the default log level, use the Python logging `setLevel()` method as shown in this example code. If you set your function's log format to JSON, we recommend that you configure your function's log level using Lambda Advanced Logging Controls and not by setting the log level in code. To learn more, see [the section called "Using log-level filtering with Python"](#)

Using Lambda advanced logging controls with Python

To give you more control over how your functions' logs are captured, processed, and consumed, you can configure the following logging options for supported Lambda Python runtimes:

- **Log format** - select between plain text and structured JSON format for your function's logs
- **Log level** - for logs in JSON format, choose the detail level of the logs Lambda sends to Amazon CloudWatch, such as ERROR, DEBUG, or INFO
- **Log group** - choose the CloudWatch log group your function sends logs to

For more information about these logging options, and instructions on how to configure your function to use them, see [the section called "Configure function logs"](#).

To learn more about using the log format and log level options with your Python Lambda functions, see the guidance in the following sections.

Using structured JSON logs with Python

If you select JSON for your function's log format, Lambda will send logs output by the Python standard logging library to CloudWatch as structured JSON. Each JSON log object contains at least four key value pairs with the following keys:

- "timestamp" - the time the log message was generated
- "level" - the log level assigned to the message
- "message" - the contents of the log message
- "requestId" - the unique request ID for the function invocation

The Python logging library can also add extra key value pairs such as "logger" to this JSON object.

The examples in the following sections show how log outputs generated using the Python logging library are captured in CloudWatch Logs when you configure your function's log format as JSON.

Note that if you use the `print` method to produce basic log outputs as described in [the section called "Printing to the log"](#), Lambda will capture these outputs as plain text, even if you configure your function's logging format as JSON.

Standard JSON log outputs using Python logging library

The following example code snippet and log output show how standard log outputs generated using the Python logging library are captured in CloudWatch Logs when your function's log format is set to JSON.

Example Python logging code

```
import logging
logger = logging.getLogger()

def lambda_handler(event, context):
    logger.info("Inside the handler function")
```

Example JSON log record

```
{
  "timestamp": "2023-10-27T19:17:45.586Z",
  "level": "INFO",
  "message": "Inside the handler function",
  "logger": "root",
  "requestId": "79b4f56e-95b1-4643-9700-2807f4e68189"
}
```

Logging extra parameters in JSON

When your function's log format is set to JSON, you can also log additional parameters with the standard Python logging library by using the `extra` keyword to pass a Python dictionary to the log output.

Example Python logging code

```
import logging

def lambda_handler(event, context):
    logging.info(
        "extra parameters example",
        extra={"a": "b", "b": [3]},
    )
```

Example JSON log record

```
{
  "timestamp": "2023-11-02T15:26:28Z",
  "level": "INFO",
  "message": "extra parameters example",
  "logger": "root",
  "requestId": "3dbd5759-65f6-45f8-8d7d-5bdc79a3bd01",
  "a": "b",
  "b": [
    3
  ]
}
```

Logging exceptions in JSON

The following code snippet shows how Python exceptions are captured in your function's log output when you configure the log format as JSON. Note that log outputs generated using `logging.exception` are assigned the log level `ERROR`.

Example Python logging code

```
import logging

def lambda_handler(event, context):
    try:
        raise Exception("exception")
    except:
        logging.exception("msg")
```

Example JSON log record

```
{
  "timestamp": "2023-11-02T16:18:57Z",
  "level": "ERROR",
  "message": "msg",
  "logger": "root",
  "stackTrace": [
    " File \"/var/task/lambda_function.py\", line 15, in lambda_handler\n    raise\nException(\\"exception\\")\n"
  ],
}
```



```
"errorType": "Exception",
"errorMessage": "exception",
"requestId": "3f9d155c-0f09-46b7-bdf1-e91dab220855",
"location": "/var/task/lambda_function.py:lambda_handler:17"
}
```

JSON structured logs with other logging tools

If your code already uses another logging library, such as Powertools for AWS Lambda, to produce JSON structured logs, you don't need to make any changes. AWS Lambda doesn't double-encode any logs that are already JSON encoded. Even if you configure your function to use the JSON log format, your logging outputs appear in CloudWatch in the JSON structure you define.

The following example shows how log outputs generated using the Powertools for AWS Lambda package are captured in CloudWatch Logs. The format of this log output is the same whether your function's logging configuration is set to JSON or TEXT. For more information about using Powertools for AWS Lambda, see [the section called "Using Powertools for AWS Lambda \(Python\) and AWS SAM for structured logging"](#) and [the section called "Using Powertools for AWS Lambda \(Python\) and AWS CDK for structured logging"](#)

Example Python logging code snippet (using Powertools for AWS Lambda)

```
from aws_lambda_powertools import Logger

logger = Logger()

def lambda_handler(event, context):
    logger.info("Inside the handler function")
```

Example JSON log record (using Powertools for AWS Lambda)

```
{
  "level": "INFO",
  "location": "lambda_handler:7",
  "message": "Inside the handler function",
  "timestamp": "2023-10-31 22:38:21,010+0000",
  "service": "service_undefined",
  "xray_trace_id": "1-654181dc-65c15d6b0fecbdd1531ecb30"
}
```

Using log-level filtering with Python

By configuring log-level filtering, you can choose to send only logs of a certain logging level or lower to CloudWatch Logs. To learn how to configure log-level filtering for your function, see [the section called “Log-level filtering”](#).

For AWS Lambda to filter your application logs according to their log level, your function must use JSON formatted logs. You can achieve this in two ways:

- Create log outputs using the standard Python logging library and configure your function to use JSON log formatting. AWS Lambda then filters your log outputs using the “level” key value pair in the JSON object described in [the section called “Using structured JSON logs with Python”](#). To learn how to configure your function’s log format, see [the section called “Configure function logs”](#).
- Use another logging library or method to create JSON structured logs in your code that include a “level” key value pair defining the level of the log output. For example, you can use Powertools for AWS Lambda to generate JSON structured log outputs from your code.

You can also use a print statement to output a JSON object containing a log level identifier. The following print statement produces a JSON formatted output where the log level is set to INFO. AWS Lambda will send the JSON object to CloudWatch Logs if your function’s logging level is set to INFO, DEBUG, or TRACE.

```
print({'msg':"My log message", "level":"info"})
```

For Lambda to filter your function's logs, you must also include a "timestamp" key value pair in your JSON log output. The time must be specified in valid [RFC 3339](#) timestamp format. If you don't supply a valid timestamp, Lambda will assign the log the level INFO and add a timestamp for you.

Viewing logs in Lambda console

You can use the Lambda console to view log output after you invoke a Lambda function.

If your code can be tested from the embedded **Code** editor, you will find logs in the **execution results**. When you use the console test feature to invoke a function, you'll find **Log output** in the **Details** section.

Viewing logs in CloudWatch console

You can use the Amazon CloudWatch console to view logs for all Lambda function invocations.

To view logs on the CloudWatch console

1. Open the [Log groups page](#) on the CloudWatch console.
2. Choose the log group for your function (`/aws/lambda/your-function-name`).
3. Choose a log stream.

Each log stream corresponds to an [instance of your function](#). A log stream appears when you update your Lambda function, and when additional instances are created to handle multiple concurrent invocations. To find logs for a specific invocation, we recommend instrumenting your function with AWS X-Ray. X-Ray records details about the request and the log stream in the trace.

Viewing logs with AWS CLI

The AWS CLI is an open-source tool that enables you to interact with AWS services using commands in your command line shell. To complete the steps in this section, you must have the [AWS CLI version 2](#).

You can use the [AWS CLI](#) to retrieve logs for an invocation using the `--log-type` command option. The response contains a `LogResult` field that contains up to 4 KB of base64-encoded logs from the invocation.

Example retrieve a log ID

The following example shows how to retrieve a *log ID* from the `LogResult` field for a function named `my-function`.

```
aws lambda invoke --function-name my-function out --log-type Tail
```

You should see the following output:

```
{
  "StatusCode": 200,
  "LogResult":
  "U1RBULQgUmVxdWVzdElk0iA4N2QwNDRi0C1mMTU0LTExZTgt0GNkYS0y0Tc0YzVlNGZiMjEgVmVyc2lvc21vb...",
  "ExecutedVersion": "$LATEST"
```

```
}
```

Example decode the logs

In the same command prompt, use the `base64` utility to decode the logs. The following example shows how to retrieve base64-encoded logs for `my-function`.

```
aws lambda invoke --function-name my-function out --log-type Tail \  
--query 'LogResult' --output text --cli-binary-format raw-in-base64-out | base64 --  
decode
```

The **cli-binary-format** option is required if you're using AWS CLI version 2. To make this the default setting, run `aws configure set cli-binary-format raw-in-base64-out`. For more information, see [AWS CLI supported global command line options](#) in the *AWS Command Line Interface User Guide for Version 2*.

You should see the following output:

```
START RequestId: 57f231fb-1730-4395-85cb-4f71bd2b87b8 Version: $LATEST  
"AWS_SESSION_TOKEN": "AgoJb3JpZ2luX2VjELj...", "_X_AMZN_TRACE_ID": "Root=1-5d02e5ca-  
f5792818b6fe8368e5b51d50;Parent=191db58857df8395;Sampled=0\"",ask/lib:/opt/lib",  
END RequestId: 57f231fb-1730-4395-85cb-4f71bd2b87b8  
REPORT RequestId: 57f231fb-1730-4395-85cb-4f71bd2b87b8 Duration: 79.67 ms Billed  
Duration: 80 ms Memory Size: 128 MB Max Memory Used: 73 MB
```

The `base64` utility is available on Linux, macOS, and [Ubuntu on Windows](#). macOS users may need to use `base64 -D`.

Example get-logs.sh script

In the same command prompt, use the following script to download the last five log events. The script uses `sed` to remove quotes from the output file, and sleeps for 15 seconds to allow time for the logs to become available. The output includes the response from Lambda and the output from the `get-log-events` command.

Copy the contents of the following code sample and save in your Lambda project directory as `get-logs.sh`.

The **cli-binary-format** option is required if you're using AWS CLI version 2. To make this the default setting, run `aws configure set cli-binary-format raw-in-base64-out`. For more

information, see [AWS CLI supported global command line options](#) in the *AWS Command Line Interface User Guide for Version 2*.

```
#!/bin/bash
aws lambda invoke --function-name my-function --cli-binary-format raw-in-base64-out --
payload '{"key": "value"}' out
sed -i'' -e 's/"//g' out
sleep 15
aws logs get-log-events --log-group-name /aws/lambda/my-function --log-stream-
name stream1 --limit 5
```

Example macOS and Linux (only)

In the same command prompt, macOS and Linux users may need to run the following command to ensure the script is executable.

```
chmod -R 755 get-logs.sh
```

Example retrieve the last five log events

In the same command prompt, run the following script to get the last five log events.

```
./get-logs.sh
```

You should see the following output:

```
{
  "StatusCode": 200,
  "ExecutedVersion": "$LATEST"
}
{
  "events": [
    {
      "timestamp": 1559763003171,
      "message": "START RequestId: 4ce9340a-b765-490f-ad8a-02ab3415e2bf Version:
$LATEST\n",
      "ingestionTime": 1559763003309
    },
    {
      "timestamp": 1559763003173,
```

```

        "message": "2019-06-05T19:30:03.173Z\t4ce9340a-b765-490f-ad8a-02ab3415e2bf
\tINFO\tENVIRONMENT VARIABLES\r{\r  \"AWS_LAMBDA_FUNCTION_VERSION\": \"\$LATEST\",
\r ...",
    "ingestionTime": 1559763018353
  },
  {
    "timestamp": 1559763003173,
    "message": "2019-06-05T19:30:03.173Z\t4ce9340a-b765-490f-ad8a-02ab3415e2bf
\tINFO\tEVENT\r{\r  \"key\": \"value\"\r}\n",
    "ingestionTime": 1559763018353
  },
  {
    "timestamp": 1559763003218,
    "message": "END RequestId: 4ce9340a-b765-490f-ad8a-02ab3415e2bf\n",
    "ingestionTime": 1559763018353
  },
  {
    "timestamp": 1559763003218,
    "message": "REPORT RequestId: 4ce9340a-b765-490f-ad8a-02ab3415e2bf
\tDuration: 26.73 ms\tBilled Duration: 27 ms \tMemory Size: 128 MB\tMax Memory Used: 75
MB\t\n",
    "ingestionTime": 1559763018353
  }
],
"nextForwardToken": "f/34783877304859518393868359594929986069206639495374241795",
"nextBackwardToken": "b/34783877303811383369537420289090800615709599058929582080"
}

```

Deleting logs

Log groups aren't deleted automatically when you delete a function. To avoid storing logs indefinitely, delete the log group, or [configure a retention period](#) after which logs are deleted automatically.

Using other logging tools and libraries

[Powertools for AWS Lambda \(Python\)](#) is a developer toolkit to implement Serverless best practices and increase developer velocity. The [Logger utility](#) provides a Lambda optimized logger which includes additional information about function context across all your functions with output structured as JSON. Use this utility to do the following:

- Capture key fields from the Lambda context, cold start and structures logging output as JSON

- Log Lambda invocation events when instructed (disabled by default)
- Print all the logs only for a percentage of invocations via log sampling (disabled by default)
- Append additional keys to structured log at any point in time
- Use a custom log formatter (Bring Your Own Formatter) to output logs in a structure compatible with your organization's Logging RFC

Using Powertools for AWS Lambda (Python) and AWS SAM for structured logging

Follow the steps below to download, build, and deploy a sample Hello World Python application with integrated [Powertools for Python](#) modules using the AWS SAM. This application implements a basic API backend and uses Powertools for emitting logs, metrics, and traces. It consists of an Amazon API Gateway endpoint and a Lambda function. When you send a GET request to the API Gateway endpoint, the Lambda function invokes, sends logs and metrics using Embedded Metric Format to CloudWatch, and sends traces to AWS X-Ray. The function returns a `hello world` message.

Prerequisites

To complete the steps in this section, you must have the following:

- Python 3.9
- [AWS CLI version 2](#)
- [AWS SAM CLI version 1.75 or later](#). If you have an older version of the AWS SAM CLI, see [Upgrading the AWS SAM CLI](#).

Deploy a sample AWS SAM application

1. Initialize the application using the Hello World Python template.

```
sam init --app-template hello-world-powertools-python --name sam-app --package-type Zip --runtime python3.9 --no-tracing
```

2. Build the app.

```
cd sam-app && sam build
```

3. Deploy the app.

```
sam deploy --guided
```

4. Follow the on-screen prompts. To accept the default options provided in the interactive experience, press Enter.

Note

For **HelloWorldFunction** may not have authorization defined, Is this okay?, make sure to enter y.

5. Get the URL of the deployed application:

```
aws cloudformation describe-stacks --stack-name sam-app --query  
'Stacks[0].Outputs[?OutputKey=='HelloWorldApi'].OutputValue' --output text
```

6. Invoke the API endpoint:

```
curl GET <URL_FROM_PREVIOUS_STEP>
```

If successful, you'll see this response:

```
{"message":"hello world"}
```

7. To get the logs for the function, run [sam logs](#). For more information, see [Working with logs](#) in the *AWS Serverless Application Model Developer Guide*.

```
sam logs --stack-name sam-app
```

The log output looks like this:

```
2023/02/03/[$LATEST]ea9a64ec87294bf6bbc9026c05a01e04  
2023-02-03T14:59:50.371000 INIT_START Runtime Version:  
python:3.9.v16 Runtime Version ARN: arn:aws:lambda:us-  
east-1::runtime:07a48df201798d627f2b950f03bb227aab4a655a1d019c3296406f95937e2525  
2023/02/03/[$LATEST]ea9a64ec87294bf6bbc9026c05a01e04 2023-02-03T14:59:51.112000  
START RequestId: d455cfc4-7704-46df-901b-2a5cce9405be Version: $LATEST  
2023/02/03/[$LATEST]ea9a64ec87294bf6bbc9026c05a01e04 2023-02-03T14:59:51.114000 {  
  "level": "INFO",
```



```

"location": "hello:23",
"message": "Hello world API - HTTP 200",
"timestamp": "2023-02-03 14:59:51,113+0000",
"service": "PowertoolsHelloWorld",
"cold_start": true,
"function_name": "sam-app-HelloWorldFunction-YBg8yfYt0c9j",
"function_memory_size": "128",
"function_arn": "arn:aws:lambda:us-east-1:111122223333:function:sam-app-
HelloWorldFunction-YBg8yfYt0c9j",
"function_request_id": "d455cfc4-7704-46df-901b-2a5cce9405be",
"correlation_id": "e73f8aef-5e07-436e-a30b-63e4b23f0047",
"xray_trace_id": "1-63dd2166-434a12c22e1307ff2114f299"
}
2023/02/03/[$LATEST]ea9a64ec87294bf6bbc9026c05a01e04 2023-02-03T14:59:51.126000 {
  "_aws": {
    "Timestamp": 1675436391126,
    "CloudWatchMetrics": [
      {
        "Namespace": "Powertools",
        "Dimensions": [
          [
            "function_name",
            "service"
          ]
        ],
        "Metrics": [
          {
            "Name": "ColdStart",
            "Unit": "Count"
          }
        ]
      }
    ]
  }
},
"function_name": "sam-app-HelloWorldFunction-YBg8yfYt0c9j",
"service": "PowertoolsHelloWorld",
"ColdStart": [
  1.0
]
}
2023/02/03/[$LATEST]ea9a64ec87294bf6bbc9026c05a01e04 2023-02-03T14:59:51.126000 {
  "_aws": {
    "Timestamp": 1675436391126,
    "CloudWatchMetrics": [

```

```

    {
      "Namespace": "Powertools",
      "Dimensions": [
        [
          "service"
        ]
      ],
      "Metrics": [
        {
          "Name": "HelloWorldInvocations",
          "Unit": "Count"
        }
      ]
    }
  ],
  "service": "PowertoolsHelloWorld",
  "HelloWorldInvocations": [
    1.0
  ]
}
2023/02/03/[$LATEST]ea9a64ec87294bf6bbc9026c05a01e04 2023-02-03T14:59:51.128000 END
RequestId: d455cfc4-7704-46df-901b-2a5cce9405be
2023/02/03/[$LATEST]ea9a64ec87294bf6bbc9026c05a01e04 2023-02-03T14:59:51.128000
REPORT RequestId: d455cfc4-7704-46df-901b-2a5cce9405be    Duration: 16.33 ms
Billed Duration: 17 ms    Memory Size: 128 MB    Max Memory Used: 64 MB    Init
Duration: 739.46 ms
XRAY TraceId: 1-63dd2166-434a12c22e1307ff2114f299    SegmentId: 3c5d18d735a1ced0
Sampled: true

```

- This is a public API endpoint that is accessible over the internet. We recommend that you delete the endpoint after testing.

```
sam delete
```

Managing log retention

Log groups aren't deleted automatically when you delete a function. To avoid storing logs indefinitely, delete the log group, or configure a retention period after which CloudWatch automatically deletes the logs. To set up log retention, add the following to your AWS SAM template:

```
Resources:
  HelloWorldFunction:
    Type: AWS::Serverless::Function
    Properties:
      # Omitting other properties

  LogGroup:
    Type: AWS::Logs::LogGroup
    Properties:
      LogGroupName: !Sub "/aws/lambda/${HelloWorldFunction}"
      RetentionInDays: 7
```

Using Powertools for AWS Lambda (Python) and AWS CDK for structured logging

Follow the steps below to download, build, and deploy a sample Hello World Python application with integrated [Powertools for AWS Lambda \(Python\)](#) modules using the AWS CDK. This application implements a basic API backend and uses Powertools for emitting logs, metrics, and traces. It consists of an Amazon API Gateway endpoint and a Lambda function. When you send a GET request to the API Gateway endpoint, the Lambda function invokes, sends logs and metrics using Embedded Metric Format to CloudWatch, and sends traces to AWS X-Ray. The function returns a hello world message.

Prerequisites

To complete the steps in this section, you must have the following:

- Python 3.9
- [AWS CLI version 2](#)
- [AWS CDK version 2](#)
- [AWS SAM CLI version 1.75 or later](#). If you have an older version of the AWS SAM CLI, see [Upgrading the AWS SAM CLI](#).

Deploy a sample AWS CDK application

1. Create a project directory for your new application.

```
mkdir hello-world
```

```
cd hello-world
```

2. Initialize the app.

```
cdk init app --language python
```

3. Install the Python dependencies.

```
pip install -r requirements.txt
```

4. Create a directory **lambda_function** under the root folder.

```
mkdir lambda_function  
cd lambda_function
```

5. Create a file **app.py** and add the following code to the file. This is the code for the Lambda function.

```
from aws_lambda_powertools.event_handler import APIGatewayRestResolver  
from aws_lambda_powertools.utilities.typing import LambdaContext  
from aws_lambda_powertools.logging import correlation_paths  
from aws_lambda_powertools import Logger  
from aws_lambda_powertools import Tracer  
from aws_lambda_powertools import Metrics  
from aws_lambda_powertools.metrics import MetricUnit  
  
app = APIGatewayRestResolver()  
tracer = Tracer()  
logger = Logger()  
metrics = Metrics(namespace="PowertoolsSample")  
  
@app.get("/hello")  
@tracer.capture_method  
def hello():  
    # adding custom metrics  
    # See: https://docs.powertools.aws.dev/lambda-python/latest/core/metrics/metrics.add\_metric\(name="HelloWorldInvocations", unit=MetricUnit.Count, value=1\)  
  
    # structured log  
    # See: https://docs.powertools.aws.dev/lambda-python/latest/core/logger/logger.info\("Hello world API - HTTP 200"\)  
    return {"message": "hello world"}
```

```
# Enrich logging with contextual information from Lambda
@logger.inject_lambda_context(correlation_id_path=correlation_paths.API_GATEWAY_REST)
# Adding tracer
# See: https://docs.powertools.aws.dev/lambda-python/latest/core/tracer/
@tracer.capture_lambda_handler
# ensures metrics are flushed upon request completion/failure and capturing
  ColdStart metric
@metrics.log_metrics(capture_cold_start_metric=True)
def lambda_handler(event: dict, context: LambdaContext) -> dict:
    return app.resolve(event, context)
```

6. Open the **hello_world** directory. You should see a file called **hello_world_stack.py**.

```
cd ..
cd hello_world
```

7. Open **hello_world_stack.py** and add the following code to the file. This contains the [Lambda Constructor](#), which creates the Lambda function, configures environment variables for Powertools and sets log retention to one week, and the [ApiGatewayv1 Constructor](#), which creates the REST API.

```
from aws_cdk import (
    Stack,
    aws_apigateway as apigwv1,
    aws_lambda as lambda_,
    CfnOutput,
    Duration
)
from constructs import Construct

class HelloWorldStack(Stack):

    def __init__(self, scope: Construct, construct_id: str, **kwargs) -> None:
        super().__init__(scope, construct_id, **kwargs)

        # Powertools Lambda Layer
        powertools_layer = lambda_.LayerVersion.from_layer_version_arn(
            self,
            id="lambda-powertools",
            # At the moment we wrote this example, the aws_lambda_python_alpha CDK
            constructor is in Alpha, so we use layer to make the example simpler
```

```

        # See https://docs.aws.amazon.com/cdk/api/v2/python/
aws_cdk.aws_lambda_python_alpha/README.html
        # Check all Powertools layers versions here: https://
docs.powertools.aws.dev/lambda-python/latest/#lambda-layer
        layer_version_arn=f"arn:aws:lambda:
{self.region}:017000801446:layer:AWSLambdaPowertoolsPythonV2:21"
    )

    function = lambda_.Function(self,
        'sample-app-lambda',
        runtime=lambda_.Runtime.PYTHON_3_9,
        layers=[powertools_layer],
        code = lambda_.Code.from_asset("./lambda_function/"),
        handler="app.lambda_handler",
        memory_size=128,
        timeout=Duration.seconds(3),
        architecture=lambda_.Architecture.X86_64,
        environment={
            "POWERTOOLS_SERVICE_NAME": "PowertoolsHelloWorld",
            "POWERTOOLS_METRICS_NAMESPACE": "PowertoolsSample",
            "LOG_LEVEL": "INFO"
        }
    )

    apigw = apigwv1.RestApi(self, "PowertoolsAPI",
        deploy_options=apigwv1.StageOptions(stage_name="dev"))

    hello_api = apigw.root.add_resource("hello")
    hello_api.add_method("GET", apigwv1.LambdaIntegration(function,
        proxy=True))

    CfnOutput(self, "apiUrl", value=f"{apigw.url}hello")

```

8. Deploy your application.

```

cd ..
cdk deploy

```

9. Get the URL of the deployed application:

```

aws cloudformation describe-stacks --stack-name HelloWorldStack --query
'Stacks[0].Outputs[?OutputKey==`apiUrl`].OutputValue' --output text

```

10. Invoke the API endpoint:

```
curl GET <URL_FROM_PREVIOUS_STEP>
```

If successful, you'll see this response:

```
{"message":"hello world"}
```

11. To get the logs for the function, run [sam logs](#). For more information, see [Working with logs](#) in the *AWS Serverless Application Model Developer Guide*.

```
sam logs --stack-name HelloWorldStack
```

The log output looks like this:

```
2023/02/03/[$LATEST]ea9a64ec87294bf6bbc9026c05a01e04
 2023-02-03T14:59:50.371000 INIT_START Runtime Version:
 python:3.9.v16 Runtime Version ARN: arn:aws:lambda:us-
 east-1::runtime:07a48df201798d627f2b950f03bb227aab4a655a1d019c3296406f95937e2525
2023/02/03/[$LATEST]ea9a64ec87294bf6bbc9026c05a01e04 2023-02-03T14:59:51.112000
 START RequestId: d455cfc4-7704-46df-901b-2a5cce9405be Version: $LATEST
2023/02/03/[$LATEST]ea9a64ec87294bf6bbc9026c05a01e04 2023-02-03T14:59:51.114000 {
  "level": "INFO",
  "location": "hello:23",
  "message": "Hello world API - HTTP 200",
  "timestamp": "2023-02-03 14:59:51,113+0000",
  "service": "PowertoolsHelloWorld",
  "cold_start": true,
  "function_name": "sam-app-HelloWorldFunction-YBg8yfYt0c9j",
  "function_memory_size": "128",
  "function_arn": "arn:aws:lambda:us-east-1:111122223333:function:sam-app-
 HelloWorldFunction-YBg8yfYt0c9j",
  "function_request_id": "d455cfc4-7704-46df-901b-2a5cce9405be",
  "correlation_id": "e73f8aef-5e07-436e-a30b-63e4b23f0047",
  "xray_trace_id": "1-63dd2166-434a12c22e1307ff2114f299"
}
2023/02/03/[$LATEST]ea9a64ec87294bf6bbc9026c05a01e04 2023-02-03T14:59:51.126000 {
  "_aws": {
    "Timestamp": 1675436391126,
    "CloudWatchMetrics": [
      {
        "Namespace": "Powertools",
```

```

    "Dimensions": [
      [
        "function_name",
        "service"
      ]
    ],
    "Metrics": [
      {
        "Name": "ColdStart",
        "Unit": "Count"
      }
    ]
  }
]
},
"function_name": "sam-app-HelloWorldFunction-YBg8yfYt0c9j",
"service": "PowertoolsHelloWorld",
"ColdStart": [
  1.0
]
}
2023/02/03/[$LATEST]ea9a64ec87294bf6bbc9026c05a01e04 2023-02-03T14:59:51.126000 {
  "_aws": {
    "Timestamp": 1675436391126,
    "CloudWatchMetrics": [
      {
        "Namespace": "Powertools",
        "Dimensions": [
          [
            "service"
          ]
        ],
        "Metrics": [
          {
            "Name": "HelloWorldInvocations",
            "Unit": "Count"
          }
        ]
      }
    ]
  }
},
"service": "PowertoolsHelloWorld",
"HelloWorldInvocations": [
  1.0
]
}

```



```
]
}
2023/02/03/[$LATEST]ea9a64ec87294bf6bbc9026c05a01e04 2023-02-03T14:59:51.128000 END
  RequestId: d455cfc4-7704-46df-901b-2a5cce9405be
2023/02/03/[$LATEST]ea9a64ec87294bf6bbc9026c05a01e04 2023-02-03T14:59:51.128000
  REPORT RequestId: d455cfc4-7704-46df-901b-2a5cce9405be    Duration: 16.33 ms
  Billed Duration: 17 ms    Memory Size: 128 MB    Max Memory Used: 64 MB    Init
  Duration: 739.46 ms
XRAY TraceId: 1-63dd2166-434a12c22e1307ff2114f299    SegmentId: 3c5d18d735a1ced0
  Sampled: true
```

12. This is a public API endpoint that is accessible over the internet. We recommend that you delete the endpoint after testing.

```
cdk destroy
```

AWS Lambda function testing in Python

Note

See the [Testing functions](#) chapter for a complete introduction to techniques and best practices for testing serverless solutions.

Testing serverless functions uses traditional test types and techniques, but you must also consider testing serverless applications as a whole. Cloud-based tests will provide the **most accurate** measure of quality of both your functions and serverless applications.

A serverless application architecture includes managed services that provide critical application functionality through API calls. For this reason, your development cycle should include automated tests that verify functionality when your function and services interact.

If you do not create cloud-based tests, you could encounter issues due to differences between your local environment and the deployed environment. Your continuous integration process should run tests against a suite of resources provisioned in the cloud before promoting your code to the next deployment environment, such as QA, Staging, or Production.

Continue reading this short guide to learn about testing strategies for serverless applications, or visit the [Serverless Test Samples repository](#) to dive in with practical examples, specific to your chosen language and runtime.

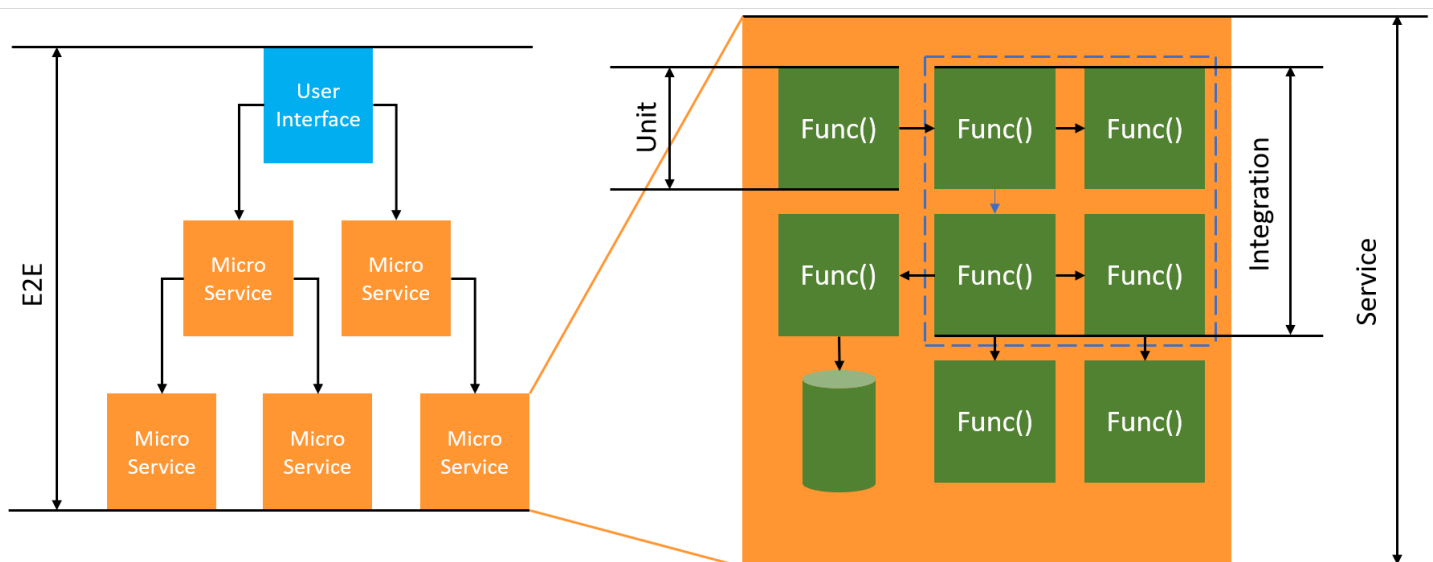

For serverless testing, you will still write *unit*, *integration* and *end-to-end* tests.

- **Unit tests** - Tests that run against an isolated block of code. For example, verifying the business logic to calculate the delivery charge given a particular item and destination.
- **Integration tests** - Tests involving two or more components or services that interact, typically in a cloud environment. For example, verifying a function processes events from a queue.
- **End-to-end tests** - Tests that verify behavior across an entire application. For example, ensuring infrastructure is set up correctly and that events flow between services as expected to record a customer's order.

Testing your serverless applications

You will generally use a mix of approaches to test your serverless application code, including testing in the cloud, testing with mocks, and occasionally testing with emulators.

Testing in the cloud

Testing in the cloud is valuable for all phases of testing, including unit tests, integration tests, and end-to-end tests. You run tests against code deployed in the cloud and interacting with cloud-based services. This approach provides the **most accurate** measure of quality of your code.

A convenient way to debug your Lambda function in the cloud is through the console with a test event. A *test event* is a JSON input to your function. If your function does not require input, the event can be an empty JSON document (`{}`). The console provides sample events for a variety of service integrations. After creating an event in the console, you can share it with your team to make testing easier and consistent.

Note

[Testing a function in the console](#) is a quick way to get started, but automating your test cycles ensures application quality and development speed.

Testing tools

Tools and techniques exist to accelerate development feedback loops. For example, [AWS SAM Accelerate](#) and [AWS CDK watch mode](#) both decrease the time required to update cloud environments.

[Moto](#) is a Python library for mocking AWS services and resources, so that you can test your functions with little or no modification using decorators to intercept and simulate responses.

The validation feature of the [Powertools for AWS Lambda \(Python\)](#) provides decorators so you can validate input events and output responses from your Python functions.

For more information, read the blog post [Unit Testing Lambda with Python and Mock AWS Services](#).

To reduce the latency involved with cloud deployment iterations, see [AWS Serverless Application Model \(AWS SAM\) Accelerate](#), [AWS Cloud Development Kit \(AWS CDK\) watch mode](#). These tools monitor your infrastructure and code for changes. They react to these changes by creating and deploying incremental updates automatically into your cloud environment.

Examples that use these tools are available in the [Python Test Samples](#) code repository.

Instrumenting Python code in AWS Lambda

Lambda integrates with AWS X-Ray to help you trace, debug, and optimize Lambda applications. You can use X-Ray to trace a request as it traverses resources in your application, which may include Lambda functions and other AWS services.

To send tracing data to X-Ray, you can use one of three SDK libraries:

- [AWS Distro for OpenTelemetry \(ADOT\)](#) – A secure, production-ready, AWS-supported distribution of the OpenTelemetry (OTel) SDK.
- [AWS X-Ray SDK for Python](#) – An SDK for generating and sending trace data to X-Ray.
- [Powertools for AWS Lambda \(Python\)](#) – A developer toolkit to implement Serverless best practices and increase developer velocity.

Each of the SDKs offer ways to send your telemetry data to the X-Ray service. You can then use X-Ray to view, filter, and gain insights into your application's performance metrics to identify issues and opportunities for optimization.

Important

The X-Ray and Powertools for AWS Lambda SDKs are part of a tightly integrated instrumentation solution offered by AWS. The ADOT Lambda Layers are part of an industry-wide standard for tracing instrumentation that collect more data in general, but may not be suited for all use cases. You can implement end-to-end tracing in X-Ray using either solution. To learn more about choosing between them, see [Choosing between the AWS Distro for Open Telemetry and X-Ray SDKs](#).

Sections

- [Using Powertools for AWS Lambda \(Python\) and AWS SAM for tracing](#)
- [Using Powertools for AWS Lambda \(Python\) and the AWS CDK for tracing](#)
- [Using ADOT to instrument your Python functions](#)
- [Using the X-Ray SDK to instrument your Python functions](#)
- [Activating tracing with the Lambda console](#)
- [Activating tracing with the Lambda API](#)
- [Activating tracing with AWS CloudFormation](#)

- [Interpreting an X-Ray trace](#)
- [Storing runtime dependencies in a layer \(X-Ray SDK\)](#)

Using Powertools for AWS Lambda (Python) and AWS SAM for tracing

Follow the steps below to download, build, and deploy a sample Hello World Python application with integrated [Powertools for AWS Lambda \(Python\)](#) modules using the AWS SAM. This application implements a basic API backend and uses Powertools for emitting logs, metrics, and traces. It consists of an Amazon API Gateway endpoint and a Lambda function. When you send a GET request to the API Gateway endpoint, the Lambda function invokes, sends logs and metrics using Embedded Metric Format to CloudWatch, and sends traces to AWS X-Ray. The function returns a hello world message.

Prerequisites

To complete the steps in this section, you must have the following:

- Python 3.11
- [AWS CLI version 2](#)
- [AWS SAM CLI version 1.75 or later](#). If you have an older version of the AWS SAM CLI, see [Upgrading the AWS SAM CLI](#).

Deploy a sample AWS SAM application

1. Initialize the application using the Hello World Python template.

```
sam init --app-template hello-world-powertools-python --name sam-app --package-type Zip --runtime python3.11 --no-tracing
```

2. Build the app.

```
cd sam-app && sam build
```

3. Deploy the app.

```
sam deploy --guided
```

4. Follow the on-screen prompts. To accept the default options provided in the interactive experience, press Enter.

Note

For **HelloWorldFunction** may not have authorization defined, Is this okay?, make sure to enter y.

5. Get the URL of the deployed application:

```
aws cloudformation describe-stacks --stack-name sam-app --query  
'Stacks[0].Outputs[?OutputKey=='HelloWorldApi'].OutputValue' --output text
```

6. Invoke the API endpoint:

```
curl -X GET <URL_FROM_PREVIOUS_STEP>
```

If successful, you'll see this response:

```
{"message":"hello world"}
```

7. To get the traces for the function, run [sam traces](#).

```
sam traces
```

The trace output looks like this:

```
New XRay Service Graph  
Start time: 2023-02-03 14:59:50+00:00  
End time: 2023-02-03 14:59:50+00:00  
Reference Id: 0 - (Root) AWS::Lambda - sam-app-HelloWorldFunction-YBg8yfYt0c9j -  
Edges: [1]  
  Summary_statistics:  
    - total requests: 1  
    - ok count(2XX): 1  
    - error count(4XX): 0  
    - fault count(5XX): 0  
    - total response time: 0.924  
Reference Id: 1 - AWS::Lambda::Function - sam-app-HelloWorldFunction-YBg8yfYt0c9j  
- Edges: []  
  Summary_statistics:  
    - total requests: 1  
    - ok count(2XX): 1
```

```

- error count(4XX): 0
- fault count(5XX): 0
- total response time: 0.016
Reference Id: 2 - client - sam-app-HelloWorldFunction-YBg8yfYt0c9j - Edges: [0]
Summary_statistics:
- total requests: 0
- ok count(2XX): 0
- error count(4XX): 0
- fault count(5XX): 0
- total response time: 0

XRay Event [revision 1] at (2023-02-03T14:59:50.204000) with id
(1-63dd2166-434a12c22e1307ff2114f299) and duration (0.924s)
- 0.924s - sam-app-HelloWorldFunction-YBg8yfYt0c9j [HTTP: 200]
- 0.016s - sam-app-HelloWorldFunction-YBg8yfYt0c9j
- 0.739s - Initialization
- 0.016s - Invocation
- 0.013s - ## lambda_handler
- 0.000s - ## app.hello
- 0.000s - Overhead

```

- This is a public API endpoint that is accessible over the internet. We recommend that you delete the endpoint after testing.

```
sam delete
```

X-Ray doesn't trace all requests to your application. X-Ray applies a sampling algorithm to ensure that tracing is efficient, while still providing a representative sample of all requests. The sampling rate is 1 request per second and 5 percent of additional requests. You can't configure the X-Ray sampling rate for your functions.

Using Powertools for AWS Lambda (Python) and the AWS CDK for tracing

Follow the steps below to download, build, and deploy a sample Hello World Python application with integrated [Powertools for AWS Lambda \(Python\)](#) modules using the AWS CDK. This application implements a basic API backend and uses Powertools for emitting logs, metrics, and traces. It consists of an Amazon API Gateway endpoint and a Lambda function. When you send a GET request to the API Gateway endpoint, the Lambda function invokes, sends logs and metrics

using Embedded Metric Format to CloudWatch, and sends traces to AWS X-Ray. The function returns a hello world message.

Prerequisites

To complete the steps in this section, you must have the following:

- Python 3.11
- [AWS CLI version 2](#)
- [AWS CDK version 2](#)
- [AWS SAM CLI version 1.75 or later](#). If you have an older version of the AWS SAM CLI, see [Upgrading the AWS SAM CLI](#).

Deploy a sample AWS CDK application

1. Create a project directory for your new application.

```
mkdir hello-world
cd hello-world
```

2. Initialize the app.

```
cdk init app --language python
```

3. Install the Python dependencies.

```
pip install -r requirements.txt
```

4. Create a directory **lambda_function** under the root folder.

```
mkdir lambda_function
cd lambda_function
```

5. Create a file **app.py** and add the following code to the file. This is the code for the Lambda function.

```
from aws_lambda_powertools.event_handler import APIGatewayRestResolver
from aws_lambda_powertools.utilities.typing import LambdaContext
from aws_lambda_powertools.logging import correlation_paths
from aws_lambda_powertools import Logger
```

```
from aws_lambda_powertools import Tracer
from aws_lambda_powertools import Metrics
from aws_lambda_powertools.metrics import MetricUnit

app = APIGatewayRestResolver()
tracer = Tracer()
logger = Logger()
metrics = Metrics(namespace="PowertoolsSample")

@app.get("/hello")
@tracer.capture_method
def hello():
    # adding custom metrics
    # See: https://docs.powertools.aws.dev/lambda-python/latest/core/metrics/
    metrics.add_metric(name="HelloWorldInvocations", unit=MetricUnit.Count,
value=1)

    # structured log
    # See: https://docs.powertools.aws.dev/lambda-python/latest/core/logger/
    logger.info("Hello world API - HTTP 200")
    return {"message": "hello world"}

# Enrich logging with contextual information from Lambda
@logger.inject_lambda_context(correlation_id_path=correlation_paths.API_GATEWAY_REST)
# Adding tracer
# See: https://docs.powertools.aws.dev/lambda-python/latest/core/tracer/
@tracer.capture_lambda_handler
# ensures metrics are flushed upon request completion/failure and capturing
ColdStart metric
@metrics.log_metrics(capture_cold_start_metric=True)
def lambda_handler(event: dict, context: LambdaContext) -> dict:
    return app.resolve(event, context)
```

6. Open the **hello_world** directory. You should see a file called **hello_world_stack.py**.

```
cd ..
cd hello_world
```

7. Open **hello_world_stack.py** and add the following code to the file. This contains the [Lambda Constructor](#), which creates the Lambda function, configures environment variables for Powertools and sets log retention to one week, and the [ApiGatewayv1 Constructor](#), which creates the REST API.

```
from aws_cdk import (
    Stack,
    aws_apigateway as apigwv1,
    aws_lambda as lambda_,
    CfnOutput,
    Duration
)
from constructs import Construct

class HelloWorldStack(Stack):

    def __init__(self, scope: Construct, construct_id: str, **kwargs) -> None:
        super().__init__(scope, construct_id, **kwargs)

        # Powertools Lambda Layer
        powertools_layer = lambda_.LayerVersion.from_layer_version_arn(
            self,
            id="lambda-powertools",
            # At the moment we wrote this example, the aws_lambda_python_alpha CDK
            # constructor is in Alpha, so we use layer to make the example simpler
            # See https://docs.aws.amazon.com/cdk/api/v2/python/
            # aws\_cdk.aws\_lambda\_python\_alpha/README.html
            # Check all Powertools layers versions here: https://
            # docs.powertools.aws.dev/lambda-python/latest/#lambda-layer
            layer_version_arn=f"arn:aws:lambda:
{self.region}:017000801446:layer:AWSLambdaPowertoolsPythonV2:21"
        )

        function = lambda_.Function(self,
            'sample-app-lambda',
            runtime=lambda_.Runtime.PYTHON_3_11,
            layers=[powertools_layer],
            code = lambda_.Code.from_asset("./lambda_function/"),
            handler="app.lambda_handler",
            memory_size=128,
            timeout=Duration.seconds(3),
            architecture=lambda_.Architecture.X86_64,
            environment={
                "POWERTOOLS_SERVICE_NAME": "PowertoolsHelloWorld",
                "POWERTOOLS_METRICS_NAMESPACE": "PowertoolsSample",
                "LOG_LEVEL": "INFO"
            }
        )
```

```
    apigw = apigwv1.RestApi(self, "PowertoolsAPI",
    deploy_options=apigwv1.StageOptions(stage_name="dev"))

    hello_api = apigw.root.add_resource("hello")
    hello_api.add_method("GET", apigwv1.LambdaIntegration(function,
    proxy=True))

    CfnOutput(self, "apiUrl", value=f"{apigw.url}hello")
```

8. Deploy your application.

```
cd ..
cdk deploy
```

9. Get the URL of the deployed application:

```
aws cloudformation describe-stacks --stack-name HelloWorldStack --query
'Stacks[0].Outputs[?OutputKey==`apiUrl`].OutputValue' --output text
```

10. Invoke the API endpoint:

```
curl -X GET <URL_FROM_PREVIOUS_STEP>
```

If successful, you'll see this response:

```
{"message":"hello world"}
```

11. To get the traces for the function, run [sam traces](#).

```
sam traces
```

The traces output looks like this:

```
New XRay Service Graph
Start time: 2023-02-03 14:59:50+00:00
End time: 2023-02-03 14:59:50+00:00
Reference Id: 0 - (Root) AWS::Lambda - sam-app-HelloWorldFunction-YBg8yfYt0c9j -
Edges: [1]
Summary_statistics:
  - total requests: 1
  - ok count(2XX): 1
```

```

- error count(4XX): 0
- fault count(5XX): 0
- total response time: 0.924
Reference Id: 1 - AWS::Lambda::Function - sam-app>HelloWorldFunction-YBg8yfYt0c9j
- Edges: []
Summary_statistics:
- total requests: 1
- ok count(2XX): 1
- error count(4XX): 0
- fault count(5XX): 0
- total response time: 0.016
Reference Id: 2 - client - sam-app>HelloWorldFunction-YBg8yfYt0c9j - Edges: [0]
Summary_statistics:
- total requests: 0
- ok count(2XX): 0
- error count(4XX): 0
- fault count(5XX): 0
- total response time: 0

XRay Event [revision 1] at (2023-02-03T14:59:50.204000) with id
(1-63dd2166-434a12c22e1307ff2114f299) and duration (0.924s)
- 0.924s - sam-app>HelloWorldFunction-YBg8yfYt0c9j [HTTP: 200]
- 0.016s - sam-app>HelloWorldFunction-YBg8yfYt0c9j
- 0.739s - Initialization
- 0.016s - Invocation
- 0.013s - ## lambda_handler
- 0.000s - ## app.hello
- 0.000s - Overhead

```

12. This is a public API endpoint that is accessible over the internet. We recommend that you delete the endpoint after testing.

```
cdk destroy
```

Using ADOT to instrument your Python functions

ADOT provides fully managed Lambda [layers](#) that package everything you need to collect telemetry data using the OTel SDK. By consuming this layer, you can instrument your Lambda functions without having to modify any function code. You can also configure your layer to do custom initialization of OTel. For more information, see [Custom configuration for the ADOT Collector on Lambda](#) in the ADOT documentation.

For Python runtimes, you can add the **AWS managed Lambda layer for ADOT Python** to automatically instrument your functions. This layer works for both `arm64` and `x86_64` architectures. For detailed instructions on how to add this layer, see [AWS Distro for OpenTelemetry Lambda Support for Python](#) in the ADOT documentation.

Using the X-Ray SDK to instrument your Python functions

To record details about calls that your Lambda function makes to other resources in your application, you can also use the AWS X-Ray SDK for Python. To get the SDK, add the `aws-xray-sdk` package to your application's dependencies.

Example [requirements.txt](#)

```
jsonpickle==1.3
aws-xray-sdk==2.4.3
```

In your function code, you can instrument AWS SDK clients by patching the `boto3` library with the `aws_xray_sdk.core` module.

Example [function – Tracing an AWS SDK client](#)

```
import boto3
from aws_xray_sdk.core import xray_recorder
from aws_xray_sdk.core import patch_all

logger = logging.getLogger()
logger.setLevel(logging.INFO)
patch_all()

client = boto3.client('lambda')
client.get_account_settings()

def lambda_handler(event, context):
    logger.info('## ENVIRONMENT VARIABLES\r' + jsonpickle.encode(dict(**os.environ)))
    ...
```

After you add the correct dependencies and make the necessary code changes, activate tracing in your function's configuration via the Lambda console or the API.

Activating tracing with the Lambda console

To toggle active tracing on your Lambda function with the console, follow these steps:

To turn on active tracing

1. Open the [Functions page](#) of the Lambda console.
2. Choose a function.
3. Choose **Configuration** and then choose **Monitoring and operations tools**.
4. Choose **Edit**.
5. Under **X-Ray**, toggle on **Active tracing**.
6. Choose **Save**.

Activating tracing with the Lambda API

Configure tracing on your Lambda function with the AWS CLI or AWS SDK, use the following API operations:

- [UpdateFunctionConfiguration](#)
- [GetFunctionConfiguration](#)
- [CreateFunction](#)

The following example AWS CLI command enables active tracing on a function named **my-function**.

```
aws lambda update-function-configuration --function-name my-function \  
--tracing-config Mode=Active
```

Tracing mode is part of the version-specific configuration when you publish a version of your function. You can't change the tracing mode on a published version.

Activating tracing with AWS CloudFormation

To activate tracing on an `AWS::Lambda::Function` resource in an AWS CloudFormation template, use the `TracingConfig` property.

Example [function-inline.yml](#) – Tracing configuration

```
Resources:
  function:
    Type: AWS::Lambda::Function
    Properties:
      TracingConfig:
        Mode: Active
      ...
```

For an AWS Serverless Application Model (AWS SAM) `AWS::Serverless::Function` resource, use the `Tracing` property.

Example [template.yml](#) – Tracing configuration

```
Resources:
  function:
    Type: AWS::Serverless::Function
    Properties:
      Tracing: Active
      ...
```

Interpreting an X-Ray trace

Your function needs permission to upload trace data to X-Ray. When you activate tracing in the Lambda console, Lambda adds the required permissions to your function's [execution role](#). Otherwise, add the [AWSXRayDaemonWriteAccess](#) policy to the execution role.

After you've configured active tracing, you can observe specific requests through your application. The [X-Ray service graph](#) shows information about your application and all its components. The following example shows an application with two functions. The primary function processes events and sometimes returns errors. The second function at the top processes errors that appear in the first's log group and uses the AWS SDK to call X-Ray, Amazon Simple Storage Service (Amazon S3), and Amazon CloudWatch Logs.



X-Ray doesn't trace all requests to your application. X-Ray applies a sampling algorithm to ensure that tracing is efficient, while still providing a representative sample of all requests. The sampling rate is 1 request per second and 5 percent of additional requests. You can't configure the X-Ray sampling rate for your functions.

In X-Ray, a *trace* records information about a request that is processed by one or more *services*. Lambda records 2 segments per trace, which creates two nodes on the service graph. The following image highlights these two nodes:

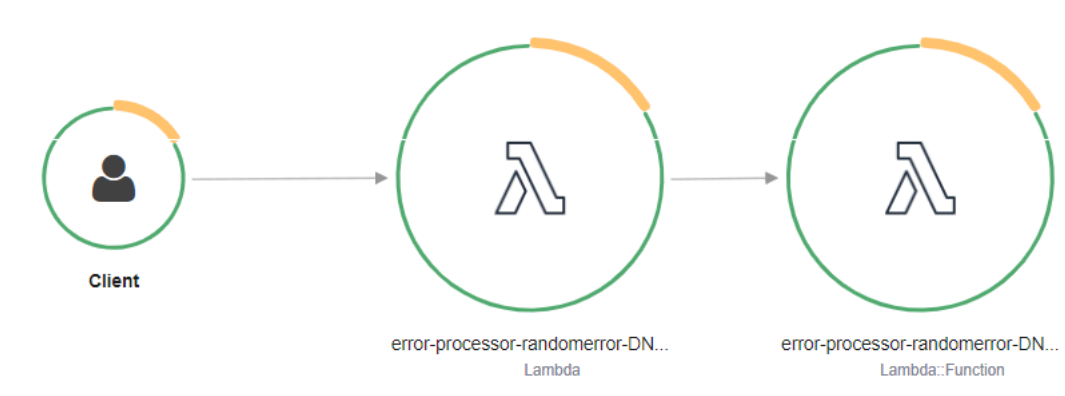

The first node on the left represents the Lambda service, which receives the invocation request. The second node represents your specific Lambda function. The following example shows a trace with these two segments. Both are named **my-function**, but one has an origin of `AWS::Lambda` and the other has an origin of `AWS::Lambda::Function`. If the `AWS::Lambda` segment shows an error, the Lambda service had an issue. If the `AWS::Lambda::Function` segment shows an error, your function had an issue.

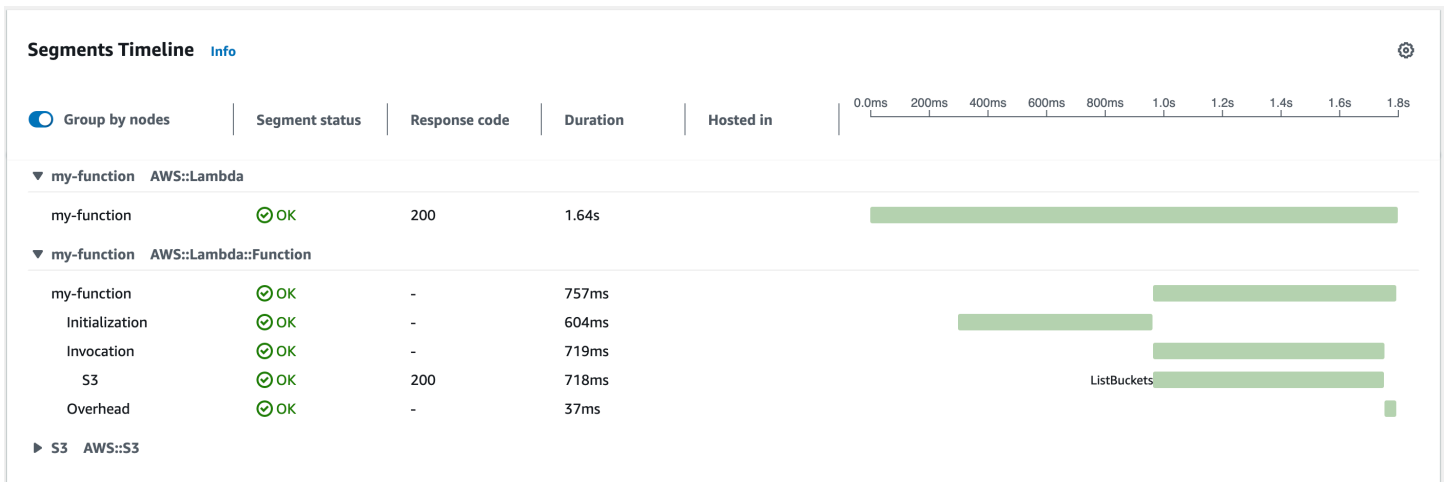

This example expands the `AWS::Lambda::Function` segment to show its three subsegments.

Note

AWS is currently implementing changes to the Lambda service. Due to these changes, you may see minor differences between the structure and content of system log messages and trace segments emitted by different Lambda functions in your AWS account.

The example trace shown here illustrates the old-style function segment. The differences between the old- and new-style segments are described in the following paragraphs.

These changes will be implemented during the coming weeks, and all functions in all AWS Regions except the China and GovCloud regions will transition to use the new-format log messages and trace segments.

The old-style function segment contains the following subsegments:

- **Initialization** – Represents time spent loading your function and running [initialization code](#). This subsegment only appears for the first event that each instance of your function processes.
- **Invocation** – Represents the time spent running your handler code.
- **Overhead** – Represents the time the Lambda runtime spends preparing to handle the next event.

The new-style function segment doesn't contain an `Invocation` subsegment. Instead, customer subsegments are attached directly to the function segment. For more information about the structure of the old- and new-style function segments, see [the section called "Understanding X-Ray traces"](#).

You can also instrument HTTP clients, record SQL queries, and create custom subsegments with annotations and metadata. For more information, see the [AWS X-Ray SDK for Python](#) in the *AWS X-Ray Developer Guide*.

Pricing

You can use X-Ray tracing for free each month up to a certain limit as part of the AWS Free Tier. Beyond that threshold, X-Ray charges for trace storage and retrieval. For more information, see [AWS X-Ray pricing](#).

Storing runtime dependencies in a layer (X-Ray SDK)

If you use the X-Ray SDK to instrument AWS SDK clients your function code, your deployment package can become quite large. To avoid uploading runtime dependencies every time you update your function code, package the X-Ray SDK in a [Lambda layer](#).

The following example shows an `AWS::Serverless::LayerVersion` resource that stores the AWS X-Ray SDK for Python.

Example [template.yml](#) – Dependencies layer

```
Resources:
  function:
    Type: AWS::Serverless::Function
    Properties:
      CodeUri: function/.
      Tracing: Active
      Layers:
        - !Ref libs
        ...
  libs:
    Type: AWS::Serverless::LayerVersion
    Properties:
      LayerName: blank-python-lib
      Description: Dependencies for the blank-python sample app.
      ContentUri: package/.
      CompatibleRuntimes:
        - python3.11
```

With this configuration, you update the library layer only if you change your runtime dependencies. Since the function deployment package contains only your code, this can help reduce upload times.

Creating a layer for dependencies requires build changes to generate the layer archive prior to deployment. For a working example, see the [blank-python](#) sample application.

Building Lambda functions with Ruby

You can run Ruby code in AWS Lambda. Lambda provides [runtimes](#) for Ruby that run your code to process events. Your code runs in an environment that includes the AWS SDK for Ruby, with credentials from an AWS Identity and Access Management (IAM) role that you manage. To learn more about the SDK versions included with the Ruby runtimes, see [the section called “Runtime-included SDK versions”](#).

Lambda supports the following Ruby runtimes.

Name	Identifier	Operating system	Deprecation date	Block function create	Block function update
Ruby 3.3	ruby3.3	Amazon Linux 2023	Not scheduled	Not scheduled	Not scheduled
Ruby 3.2	ruby3.2	Amazon Linux 2	Not scheduled	Not scheduled	Not scheduled

To create a Ruby function

1. Open the [Lambda console](#).
2. Choose **Create function**.
3. Configure the following settings:
 - **Function name:** Enter a name for the function.
 - **Runtime:** Choose **Ruby 3.2**.
4. Choose **Create function**.

The console creates a Lambda function with a single source file named `lambda_function.rb`. You can edit this file and add more files in the built-in code editor. In the **DEPLOY** section, choose **Deploy** to update your function's code. Then, to run your code, choose **Create test event** in the **TEST EVENTS** section.

The `lambda_function.rb` file exports a function named `lambda_handler` that takes an event object and a context object. This is the [handler function](#) that Lambda calls when the function is invoked. The Ruby function runtime gets invocation events from Lambda and passes them to the handler. In the function configuration, the handler value is `lambda_function.lambda_handler`.

When you save your function code, the Lambda console creates a .zip file archive deployment package. When you develop your function code outside of the console (using an IDE) you need to [create a deployment package](#) to upload your code to the Lambda function.

The function runtime passes a context object to the handler, in addition to the invocation event. The [context object](#) contains additional information about the invocation, the function, and the execution environment. More information is available from environment variables.

Your Lambda function comes with a CloudWatch Logs log group. The function runtime sends details about each invocation to CloudWatch Logs. It relays any [logs that your function outputs](#) during invocation. If your function returns an error, Lambda formats the error and returns it to the invoker.

Topics

- [Runtime-included SDK versions](#)
- [Enabling Yet Another Ruby JIT \(YJIT\)](#)
- [Define Lambda function handler in Ruby](#)
- [Deploy Ruby Lambda functions with .zip file archives](#)
- [Deploy Ruby Lambda functions with container images](#)
- [Working with layers for Ruby Lambda functions](#)
- [Using the Lambda context object to retrieve Ruby function information](#)
- [Log and monitor Ruby Lambda functions](#)
- [Instrumenting Ruby code in AWS Lambda](#)

Runtime-included SDK versions

The version of the AWS SDK included in the Ruby runtime depends on the runtime version and your AWS Region. The AWS SDK for Ruby is designed to be modular and is separated by AWS service. To find the version number of a particular service gem included in the runtime you're using, create a Lambda function with code in the following format. Replace `aws-sdk-s3` and `Aws::S3` with the name of the service gems your code uses.

```
require 'aws-sdk-s3'

def lambda_handler(event:, context:)
  puts "Service gem version: #{Aws::S3::GEM_VERSION}"
  puts "Core version: #{Aws::CORE_GEM_VERSION}"
end
```

Enabling Yet Another Ruby JIT (YJIT)

The Ruby 3.2 runtime supports [YJIT](#), a lightweight, minimalistic Ruby JIT compiler. YJIT provides significantly higher performance, but also uses more memory than the Ruby interpreter. YJIT is recommended for Ruby on Rails workloads.

YJIT is not enabled by default. To enable YJIT for a Ruby 3.2 function, set the `RUBY_YJIT_ENABLE` environment variable to 1. To confirm that YJIT is enabled, print the result of the `RubyVM::YJIT.enabled?` method.

Example — Confirm that YJIT is enabled

```
puts(RubyVM::YJIT.enabled?())
# => true
```

Define Lambda function handler in Ruby

The Lambda function *handler* is the method in your function code that processes events. When your function is invoked, Lambda runs the handler method. Your function runs until the handler returns a response, exits, or times out.

Topics

- [Ruby handler basics](#)
- [Code best practices for Ruby Lambda functions](#)

Ruby handler basics

In the following example, the file `function.rb` defines a handler method named `handler`. The handler function takes two objects as input and returns a JSON document.

Example function.rb

```
require 'json'

def handler(event:, context:)
  { event: JSON.generate(event), context: JSON.generate(context.inspect) }
end
```

In your function configuration, the `handler` setting tells Lambda where to find the handler. For the preceding example, the correct value for this setting is **`function.handler`**. It includes two names separated by a dot: the name of the file and the name of the handler method.

You can also define your handler method in a class. The following example defines a handler method named `process` on a class named `Handler` in a module named `LambdaFunctions`.

Example source.rb

```
module LambdaFunctions
  class Handler
    def self.process(event:, context:)
      "Hello!"
    end
  end
end
```

In this case, the handler setting is `source.LambdaFunctions::Handler.process`.

The two objects that the handler accepts are the invocation event and context. The event is a Ruby object that contains the payload that's provided by the invoker. If the payload is a JSON document, the event object is a Ruby hash. Otherwise, it's a string. The [context object](#) has methods and properties that provide information about the invocation, the function, and the execution environment.

The function handler is executed every time your Lambda function is invoked. Static code outside of the handler is executed once per instance of the function. If your handler uses resources like SDK clients and database connections, you can create them outside of the handler method to reuse them for multiple invocations.

Each instance of your function can process multiple invocation events, but it only processes one event at a time. The number of instances processing an event at any given time is your function's *concurrency*. For more information about the Lambda execution environment, see [Understanding the Lambda execution environment lifecycle](#).

Code best practices for Ruby Lambda functions

Adhere to the guidelines in the following list to use best coding practices when building your Lambda functions:

- **Separate the Lambda handler from your core logic.** This allows you to make a more unit-testable function. For example, in Ruby, this may look like:

```
def lambda_handler(event:, context:)
  foo = event['foo']
  bar = event['bar']

  result = my_lambda_function(foo:, bar:)
end

def my_lambda_function(foo:, bar:)
  // MyLambdaFunction logic here
end
```

- **Control the dependencies in your function's deployment package.** The AWS Lambda execution environment contains a number of libraries. For the Ruby runtime, these include the

AWS SDK. To enable the latest set of features and security updates, Lambda will periodically update these libraries. These updates may introduce subtle changes to the behavior of your Lambda function. To have full control of the dependencies your function uses, package all of your dependencies with your deployment package.

- **Minimize the complexity of your dependencies.** Prefer simpler frameworks that load quickly on [execution environment](#) startup.
- **Minimize your deployment package size to its runtime necessities.** This will reduce the amount of time that it takes for your deployment package to be downloaded and unpacked ahead of invocation. For functions authored in Ruby, avoid uploading the entire AWS SDK library as part of your deployment package. Instead, selectively depend on the gems which pick up components of the SDK you need (e.g. the DynamoDB or Amazon S3 SDK gems).
- **Take advantage of execution environment reuse to improve the performance of your function.** Initialize SDK clients and database connections outside of the function handler, and cache static assets locally in the `/tmp` directory. Subsequent invocations processed by the same instance of your function can reuse these resources. This saves cost by reducing function run time.

To avoid potential data leaks across invocations, don't use the execution environment to store user data, events, or other information with security implications. If your function relies on a mutable state that can't be stored in memory within the handler, consider creating a separate function or separate versions of a function for each user.

- **Use a keep-alive directive to maintain persistent connections.** Lambda purges idle connections over time. Attempting to reuse an idle connection when invoking a function will result in a connection error. To maintain your persistent connection, use the keep-alive directive associated with your runtime. For an example, see [Reusing Connections with Keep-Alive in Node.js](#).
- **Use [environment variables](#) to pass operational parameters to your function.** For example, if you are writing to an Amazon S3 bucket, instead of hard-coding the bucket name you are writing to, configure the bucket name as an environment variable.
- **Avoid using recursive invocations** in your Lambda function, where the function invokes itself or initiates a process that may invoke the function again. This could lead to unintended volume of function invocations and escalated costs. If you see an unintended volume of invocations, set the function reserved concurrency to `0` immediately to throttle all invocations to the function, while you update the code.

- **Do not use non-documented, non-public APIs** in your Lambda function code. For AWS Lambda managed runtimes, Lambda periodically applies security and functional updates to Lambda's internal APIs. These internal API updates may be backwards-incompatible, leading to unintended consequences such as invocation failures if your function has a dependency on these non-public APIs. See [the API reference](#) for a list of publicly available APIs.
- **Write idempotent code.** Writing idempotent code for your functions ensures that duplicate events are handled the same way. Your code should properly validate events and gracefully handle duplicate events. For more information, see [How do I make my Lambda function idempotent?](#)

Deploy Ruby Lambda functions with .zip file archives

Your AWS Lambda function's code comprises a .rb file containing your function's handler code, together with any additional dependencies (gems) your code depends on. To deploy this function code to Lambda, you use a *deployment package*. This package may either be a .zip file archive or a container image. For more information about using container images with Ruby, see [Deploy Ruby Lambda functions with container images](#).

To create your deployment package as .zip file archive, you can use your command-line tool's built-in .zip file archive utility, or any other .zip file utility such as [7zip](#). The examples shown in the following sections assume you're using a command-line zip tool in a Linux or MacOS environment. To use the same commands in Windows, you can [install the Windows Subsystem for Linux](#) to get a Windows-integrated version of Ubuntu and Bash.

Note that Lambda uses POSIX file permissions, so you may need to [set permissions for the deployment package folder](#) before you create the .zip file archive.

The example commands in the following sections use the [Bundler](#) utility to add dependencies to your deployment package. To install bundler, run the following command.

```
gem install bundler
```

Sections

- [Dependencies in Ruby](#)
- [Creating a .zip deployment package with no dependencies](#)
- [Creating a .zip deployment package with dependencies](#)
- [Creating a Ruby layer for your dependencies](#)
- [Creating .zip deployment packages with native libraries](#)
- [Creating and updating Ruby Lambda functions using .zip files](#)

Dependencies in Ruby

For Lambda functions that use the Ruby runtime, a dependency can be any Ruby gem. When you deploy your function using a .zip archive, you can either add these dependencies to your .zip file with your function code or use a Lambda layer. A layer is a separate .zip file that can contain additional code and other content. To learn more about using Lambda layers, see [Lambda layers](#).

The Ruby runtime includes the AWS SDK for Ruby. If your function uses the SDK, you don't need to bundle it with your code. However, to maintain full control of your dependencies, or to use a specific version of the SDK, you can add it to your function's deployment package. You can either include the SDK in your .zip file, or add it using a Lambda layer. Dependencies in your .zip file or in Lambda layers take precedence over versions included in the runtime. To find out which version of the SDK for Ruby is included in your runtime version, see [the section called “Runtime-included SDK versions”](#).

Under the [AWS shared responsibility model](#), you are responsible for the management of any dependencies in your functions' deployment packages. This includes applying updates and security patches. To update dependencies in your function's deployment package, first create a new .zip file and then upload it to Lambda. See [Creating a .zip deployment package with dependencies](#) and [Creating and updating Ruby Lambda functions using .zip files](#) for more information.

Creating a .zip deployment package with no dependencies

If your function code has no dependencies, your .zip file contains only the .rb file with your function's handler code. Use your preferred zip utility to create a .zip file with your .rb file at the root. If the .rb file is not at the root of your .zip file, Lambda won't be able to run your code.

To learn how to deploy your .zip file to create a new Lambda function or update an existing one, see [Creating and updating Ruby Lambda functions using .zip files](#).

Creating a .zip deployment package with dependencies

If your function code depends on additional Ruby gems, you can either add these dependencies to your .zip file with your function code or use a [Lambda layer](#). The instructions in this section show you how to include dependencies in your .zip deployment package. For instructions on how to include your dependencies in a layer, see [the section called “Creating a Ruby layer for your dependencies”](#).

Suppose your function code is saved in a file named `lambda_function.rb` in your project directory. The following example CLI commands create a .zip file named `my_deployment_package.zip` containing your function code and its dependencies.

To create the deployment package

1. In your project directory, create a `Gemfile` to specify your dependencies in.

```
bundle init
```

- Using your preferred text editor, edit the `Gemfile` to specify your function's dependencies. For example, to use the `TZInfo` gem, edit your `Gemfile` to look like the following.

```
source "https://rubygems.org"  
gem "tzinfo"
```

- Run the following command to install the gems specified in your `Gemfile` in your project directory. This command sets `vendor/bundle` as the default path for gem installations.

```
bundle config set --local path 'vendor/bundle' && bundle install
```

You should see output similar to the following.

```
Fetching gem metadata from https://rubygems.org/.....  
Resolving dependencies...  
Using bundler 2.4.13  
Fetching tzinfo 2.0.6  
Installing tzinfo 2.0.6  
...
```

Note

To install gems globally again later, run the following command.

```
bundle config set --local system 'true'
```

- Create a `.zip` file archive containing the `lambda_function.rb` file with your function's handler code and the dependencies you installed in the previous step.

```
zip -r my_deployment_package.zip lambda_function.rb vendor
```

You should see output similar to the following.

```
adding: lambda_function.rb (deflated 37%)  
adding: vendor/ (stored 0%)  
adding: vendor/bundle/ (stored 0%)
```

```
adding: vendor/bundle/ruby/ (stored 0%)
adding: vendor/bundle/ruby/3.2.0/ (stored 0%)
adding: vendor/bundle/ruby/3.2.0/build_info/ (stored 0%)
adding: vendor/bundle/ruby/3.2.0/cache/ (stored 0%)
adding: vendor/bundle/ruby/3.2.0/cache/aws-eventstream-1.0.1.gem (deflated 36%)
...
```

Creating a Ruby layer for your dependencies

To learn how to package your Ruby dependencies into a Lambda layer, see [the section called “Layers”](#).

Creating .zip deployment packages with native libraries

Many common Ruby gems such as `nokogiri`, `nio4r`, and `mysql` contain native extensions written in C. When you add libraries containing C code to your deployment package, you must build your package correctly to ensure that it's compatible with the Lambda execution environment.

For production applications, we recommend building and deploying your code using the AWS Serverless Application Model (AWS SAM). In AWS SAM use the `sam build --use-container` option to build your function inside a Lambda-like Docker container. To learn more about using AWS SAM to deploy your function code, see [Building applications](#) in the *AWS SAM Developer Guide*.

To create a .zip deployment package containing gems with native extensions without using AWS SAM, you can alternatively use a container to bundle your dependencies in an environment that is the same as the Lambda Ruby runtime environment. To complete these steps, you must have Docker installed on your build machine. To learn more about installing Docker, see [Install Docker Engine](#).

To create a .zip deployment package in a Docker container

1. Create a folder on your local build machine to save your container in. Inside that folder, create a file named `dockerfile` and paste the following code into it.

```
FROM public.ecr.aws/sam/build-ruby3.2:latest-x86_64
RUN gem update bundler
CMD "/bin/bash"
```

2. Inside the folder you created your `dockerfile` in, run the following command to create the Docker container.

```
docker build -t awsruby32 .
```

3. Navigate to the project directory containing the `.rb` file with your function's handler code and the `Gemfile` specifying your function's dependencies. From inside that directory, run the following command to start the Lambda Ruby container.

Linux/macOS

```
docker run --rm -it -v $PWD:/var/task -w /var/task awsruby32
```

Note

In macOS, you might see a warning informing you that the requested image's platform does not match the detected host platform. Ignore this warning.

Windows PowerShell

```
docker run --rm -it -v ${pwd}:var/task -w /var/task awsruby32
```

When your container starts, you should see a bash prompt.

```
bash-4.2#
```

4. Configure the `bundle` utility to install the gems specified in your `Gemfile` in a local `vendor/bundle` directory and install your dependencies.

```
bash-4.2# bundle config set --local path 'vendor/bundle' && bundle install
```

5. Create the `.zip` deployment package with your function code and its dependencies. In this example, the file containing your function's handler code is named `lambda_function.rb`.

```
bash-4.2# zip -r my_deployment_package.zip lambda_function.rb vendor
```

6. Exit the container and return to your local project directory.

```
bash-4.2# exit
```

You can now use the .zip file deployment package to create or update your Lambda function. See [Creating and updating Ruby Lambda functions using .zip files](#)

Creating and updating Ruby Lambda functions using .zip files

After you have created your .zip deployment package, you can use it to create a new Lambda function or update an existing one. You can deploy your .zip package using the Lambda console, the AWS Command Line Interface, and the Lambda API. You can also create and update Lambda functions using AWS Serverless Application Model (AWS SAM) and AWS CloudFormation.

The maximum size for a .zip deployment package for Lambda is 250 MB (unzipped). Note that this limit applies to the combined size of all the files you upload, including any Lambda layers.

The Lambda runtime needs permission to read the files in your deployment package. In Linux permissions octal notation, Lambda needs 644 permissions for non-executable files (rw-r--r--) and 755 permissions (rwxr-xr-x) for directories and executable files.

In Linux and MacOS, use the `chmod` command to change file permissions on files and directories in your deployment package. For example, to give a non-executable file the correct permissions, run the following command.

```
chmod 644 <filepath>
```

To change file permissions in Windows, see [Set, View, Change, or Remove Permissions on an Object](#) in the Microsoft Windows documentation.

Note

If you don't grant Lambda the permissions it needs to access directories in your deployment package, Lambda sets the permissions for those directories to 755 (rwxr-xr-x).

Creating and updating functions with .zip files using the console

To create a new function, you must first create the function in the console, then upload your .zip archive. To update an existing function, open the page for your function, then follow the same procedure to add your updated .zip file.

If your .zip file is less than 50MB, you can create or update a function by uploading the file directly from your local machine. For .zip files greater than 50MB, you must upload your package to an Amazon S3 bucket first. For instructions on how to upload a file to an Amazon S3 bucket using the AWS Management Console, see [Getting started with Amazon S3](#). To upload files using the AWS CLI, see [Move objects](#) in the *AWS CLI User Guide*.

Note

You cannot change the [deployment package type](#) (.zip or container image) for an existing function. For example, you cannot convert a container image function to use a .zip file archive. You must create a new function.

To create a new function (console)

1. Open the [Functions page](#) of the Lambda console and choose **Create Function**.
2. Choose **Author from scratch**.
3. Under **Basic information**, do the following:
 - a. For **Function name**, enter the name for your function.
 - b. For **Runtime**, select the runtime you want to use.
 - c. (Optional) For **Architecture**, choose the instruction set architecture for your function. The default architecture is x86_64. Ensure that the .zip deployment package for your function is compatible with the instruction set architecture you select.
4. (Optional) Under **Permissions**, expand **Change default execution role**. You can create a new **Execution role** or use an existing one.
5. Choose **Create function**. Lambda creates a basic 'Hello world' function using your chosen runtime.

To upload a .zip archive from your local machine (console)

1. In the [Functions page](#) of the Lambda console, choose the function you want to upload the .zip file for.
2. Select the **Code** tab.
3. In the **Code source** pane, choose **Upload from**.
4. Choose **.zip file**.

5. To upload the .zip file, do the following:
 - a. Select **Upload**, then select your .zip file in the file chooser.
 - b. Choose **Open**.
 - c. Choose **Save**.

To upload a .zip archive from an Amazon S3 bucket (console)

1. In the [Functions page](#) of the Lambda console, choose the function you want to upload a new .zip file for.
2. Select the **Code** tab.
3. In the **Code source** pane, choose **Upload from**.
4. Choose **Amazon S3 location**.
5. Paste the Amazon S3 link URL of your .zip file and choose **Save**.

Updating .zip file functions using the console code editor

For some functions with .zip deployment packages, you can use the Lambda console's built-in code editor to update your function code directly. To use this feature, your function must meet the following criteria:

- Your function must use one of the interpreted language runtimes (Python, Node.js, or Ruby)
- Your function's deployment package must be smaller than 50 MB (unzipped).

Function code for functions with container image deployment packages cannot be edited directly in the console.

To update function code using the console code editor

1. Open the [Functions page](#) of the Lambda console and select your function.
2. Select the **Code** tab.
3. In the **Code source** pane, select your source code file and edit it in the integrated code editor.
4. In the **DEPLOY** section, choose **Deploy** to update your function's code:

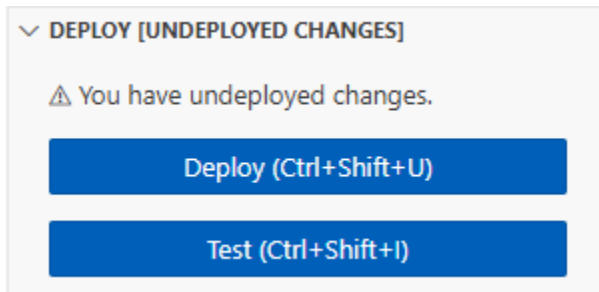

Creating and updating functions with .zip files using the AWS CLI

You can use the [AWS CLI](#) to create a new function or to update an existing one using a .zip file. Use the [create-function](#) and [update-function-code](#) commands to deploy your .zip package. If your .zip file is smaller than 50MB, you can upload the .zip package from a file location on your local build machine. For larger files, you must upload your .zip package from an Amazon S3 bucket. For instructions on how to upload a file to an Amazon S3 bucket using the AWS CLI, see [Move objects](#) in the *AWS CLI User Guide*.

Note

If you upload your .zip file from an Amazon S3 bucket using the AWS CLI, the bucket must be located in the same AWS Region as your function.

To create a new function using a .zip file with the AWS CLI, you must specify the following:

- The name of your function (`--function-name`)
- Your function's runtime (`--runtime`)
- The Amazon Resource Name (ARN) of your function's [execution role](#) (`--role`)
- The name of the handler method in your function code (`--handler`)

You must also specify the location of your .zip file. If your .zip file is located in a folder on your local build machine, use the `--zip-file` option to specify the file path, as shown in the following example command.

```
aws lambda create-function --function-name myFunction \  
--runtime ruby3.2 --handler lambda_function.lambda_handler \  
--role arn:aws:iam::111122223333:role/service-role/my-lambda-role \  
--zip-file fileb://myFunction.zip
```

To specify the location of .zip file in an Amazon S3 bucket, use the `--code` option as shown in the following example command. You only need to use the `S3ObjectVersion` parameter for versioned objects.

```
aws lambda create-function --function-name myFunction \  
--runtime ruby3.2 --handler lambda_function.lambda_handler \  
--role arn:aws:iam::111122223333:role/service-role/my-lambda-role \  
--code S3Bucket=amzn-s3-demo-  
bucket,S3Key=myFileName.zip,S3ObjectVersion=myObjectVersion
```

To update an existing function using the CLI, you specify the the name of your function using the `--function-name` parameter. You must also specify the location of the .zip file you want to use to update your function code. If your .zip file is located in a folder on your local build machine, use the `--zip-file` option to specify the file path, as shown in the following example command.

```
aws lambda update-function-code --function-name myFunction \  
--zip-file fileb://myFunction.zip
```

To specify the location of .zip file in an Amazon S3 bucket, use the `--s3-bucket` and `--s3-key` options as shown in the following example command. You only need to use the `--s3-object-version` parameter for versioned objects.

```
aws lambda update-function-code --function-name myFunction \  
--s3-bucket amzn-s3-demo-bucket --s3-key myFileName.zip --s3-object-version myObject  
Version
```

Creating and updating functions with .zip files using the Lambda API

To create and update functions using a .zip file archive, use the following API operations:

- [CreateFunction](#)
- [UpdateFunctionCode](#)

Creating and updating functions with .zip files using AWS SAM

The AWS Serverless Application Model (AWS SAM) is a toolkit that helps streamline the process of building and running serverless applications on AWS. You define the resources for your application in a YAML or JSON template and use the AWS SAM command line interface (AWS SAM CLI) to build,

package, and deploy your applications. When you build a Lambda function from an AWS SAM template, AWS SAM automatically creates a .zip deployment package or container image with your function code and any dependencies you specify. To learn more about using AWS SAM to build and deploy Lambda functions, see [Getting started with AWS SAM](#) in the *AWS Serverless Application Model Developer Guide*.

You can also use AWS SAM to create a Lambda function using an existing .zip file archive. To create a Lambda function using AWS SAM, you can save your .zip file in an Amazon S3 bucket or in a local folder on your build machine. For instructions on how to upload a file to an Amazon S3 bucket using the AWS CLI, see [Move objects](#) in the *AWS CLI User Guide*.

In your AWS SAM template, the `AWS::Serverless::Function` resource specifies your Lambda function. In this resource, set the following properties to create a function using a .zip file archive:

- `PackageType` - set to `Zip`
- `CodeUri` - set to the function code's Amazon S3 URI, path to local folder, or [FunctionCode](#) object
- `Runtime` - Set to your chosen runtime

With AWS SAM, if your .zip file is larger than 50MB, you don't need to upload it to an Amazon S3 bucket first. AWS SAM can upload .zip packages up to the maximum allowed size of 250MB (unzipped) from a location on your local build machine.

To learn more about deploying functions using .zip file in AWS SAM, see [AWS::Serverless::Function](#) in the *AWS SAM Developer Guide*.

Creating and updating functions with .zip files using AWS CloudFormation

You can use AWS CloudFormation to create a Lambda function using a .zip file archive. To create a Lambda function from a .zip file, you must first upload your file to an Amazon S3 bucket. For instructions on how to upload a file to an Amazon S3 bucket using the AWS CLI, see [Move objects](#) in the *AWS CLI User Guide*.

In your AWS CloudFormation template, the `AWS::Lambda::Function` resource specifies your Lambda function. In this resource, set the following properties to create a function using a .zip file archive:

- `PackageType` - Set to `Zip`
- `Code` - Enter the Amazon S3 bucket name and the .zip file name in the `S3Bucket` and `S3Key` fields

- Runtime - Set to your chosen runtime

The .zip file that AWS CloudFormation generates cannot exceed 4MB. To learn more about deploying functions using .zip file in AWS CloudFormation, see [AWS::Lambda::Function](#) in the *AWS CloudFormation User Guide*.

Deploy Ruby Lambda functions with container images

There are three ways to build a container image for a Ruby Lambda function:

- [Using an AWS base image for Ruby](#)

The [AWS base images](#) are preloaded with a language runtime, a runtime interface client to manage the interaction between Lambda and your function code, and a runtime interface emulator for local testing.

- [Using an AWS OS-only base image](#)

[AWS OS-only base images](#) contain an Amazon Linux distribution and the [runtime interface emulator](#). These images are commonly used to create container images for compiled languages, such as [Go](#) and [Rust](#), and for a language or language version that Lambda doesn't provide a base image for, such as Node.js 19. You can also use OS-only base images to implement a [custom runtime](#). To make the image compatible with Lambda, you must include the [runtime interface client for Ruby](#) in the image.

- [Using a non-AWS base image](#)

You can use an alternative base image from another container registry, such as Alpine Linux or Debian. You can also use a custom image created by your organization. To make the image compatible with Lambda, you must include the [runtime interface client for Ruby](#) in the image.

Tip

To reduce the time it takes for Lambda container functions to become active, see [Use multi-stage builds](#) in the Docker documentation. To build efficient container images, follow the [Best practices for writing Dockerfiles](#).

This page explains how to build, test, and deploy container images for Lambda.

Topics

- [AWS base images for Ruby](#)
- [Using an AWS base image for Ruby](#)
- [Using an alternative base image with the runtime interface client](#)

AWS base images for Ruby

AWS provides the following base images for Ruby:

Tags	Runtime	Operating system	Dockerfile	Deprecation
3.3	Ruby 3.3	Amazon Linux 2023	Dockerfile for Ruby 3.3 on GitHub	Not scheduled
3.2	Ruby 3.2	Amazon Linux 2	Dockerfile for Ruby 3.2 on GitHub	Not scheduled

Amazon ECR repository: gallery.ecr.aws/lambda/ruby

Using an AWS base image for Ruby

Prerequisites

To complete the steps in this section, you must have the following:

- [AWS CLI version 2](#)
- [Docker](#)
- Ruby

Creating an image from a base image

To create a container image for Ruby

1. Create a directory for the project, and then switch to that directory.

```
mkdir example
cd example
```

2. Create a new file called `Gemfile`. This is where you list your application's required RubyGems packages. The AWS SDK for Ruby is available from RubyGems. You should choose specific AWS service gems to install. For example, to use the [Ruby gem for Lambda](#), your `Gemfile` should look like this:

```
source 'https://rubygems.org'  
  
gem 'aws-sdk-lambda'
```

Alternatively, the [aws-sdk](#) gem contains every available AWS service gem. This gem is very large. We recommend that you use it only if you depend on many AWS services.

3. Install the dependencies specified in the Gemfile using [bundle install](#).

```
bundle install
```

4. Create a new file called `lambda_function.rb`. You can add the following sample function code to the file for testing, or use your own.

Example Ruby function

```
module LambdaFunction  
  class Handler  
    def self.process(event:, context:)  
      "Hello from Lambda!"  
    end  
  end  
end
```

5. Create a new Dockerfile. The following is an example Dockerfile that uses an [AWS base image](#). This Dockerfiles uses the following configuration:
 - Set the FROM property to the URI of the base image.
 - Use the COPY command to copy the function code and runtime dependencies to `{LAMBDA_TASK_ROOT}`, a [Lambda-defined environment variable](#).
 - Set the CMD argument to the Lambda function handler.

Note that the example Dockerfile does not include a [USER instruction](#). When you deploy a container image to Lambda, Lambda automatically defines a default Linux user with least-privileged permissions. This is different from standard Docker behavior which defaults to the root user when no USER instruction is provided.

Example Dockerfile

```
FROM public.ecr.aws/lambda/ruby:3.2

# Copy Gemfile and Gemfile.lock
COPY Gemfile Gemfile.lock ${LAMBDA_TASK_ROOT}/

# Install Bundler and the specified gems
RUN gem install bundler:2.4.20 && \
    bundle config set --local path 'vendor/bundle' && \
    bundle install

# Copy function code
COPY lambda_function.rb ${LAMBDA_TASK_ROOT}/

# Set the CMD to your handler (could also be done as a parameter override outside
of the Dockerfile)
CMD [ "lambda_function.LambdaFunction::Handler.process" ]
```

6. Build the Docker image with the [docker build](#) command. The following example names the image `docker-image` and gives it the test [tag](#).

```
docker build --platform linux/amd64 -t docker-image:test .
```

Note

The command specifies the `--platform linux/amd64` option to ensure that your container is compatible with the Lambda execution environment regardless of the architecture of your build machine. If you intend to create a Lambda function using the ARM64 instruction set architecture, be sure to change the command to use the `--platform linux/arm64` option instead.

(Optional) Test the image locally

1. Start the Docker image with the **docker run** command. In this example, `docker-image` is the image name and `test` is the tag.

```
docker run --platform linux/amd64 -p 9000:8080 docker-image:test
```

This command runs the image as a container and creates a local endpoint at `localhost:9000/2015-03-31/functions/function/invocations`.

Note

If you built the Docker image for the ARM64 instruction set architecture, be sure to use the `--platform linux/arm64` option instead of `--platform linux/amd64`.

2. From a new terminal window, post an event to the local endpoint.

Linux/macOS

In Linux and macOS, run the following `curl` command:

```
curl "http://localhost:9000/2015-03-31/functions/function/invocations" -d '{}'
```

This command invokes the function with an empty event and returns a response. If you're using your own function code rather than the sample function code, you might want to invoke the function with a JSON payload. Example:

```
curl "http://localhost:9000/2015-03-31/functions/function/invocations" -d '{"payload": "hello world!"}'
```

PowerShell

In PowerShell, run the following `Invoke-WebRequest` command:

```
Invoke-WebRequest -Uri "http://localhost:9000/2015-03-31/functions/function/invocations" -Method Post -Body '{}' -ContentType "application/json"
```

This command invokes the function with an empty event and returns a response. If you're using your own function code rather than the sample function code, you might want to invoke the function with a JSON payload. Example:

```
Invoke-WebRequest -Uri "http://localhost:9000/2015-03-31/functions/function/invocations" -Method Post -Body '{"payload": "hello world!"}' -ContentType "application/json"
```

3. Get the container ID.

```
docker ps
```

4. Use the [docker kill](#) command to stop the container. In this command, replace 3766c4ab331c with the container ID from the previous step.

```
docker kill 3766c4ab331c
```

Deploying the image

To upload the image to Amazon ECR and create the Lambda function

1. Run the [get-login-password](#) command to authenticate the Docker CLI to your Amazon ECR registry.
 - Set the `--region` value to the AWS Region where you want to create the Amazon ECR repository.
 - Replace 111122223333 with your AWS account ID.

```
aws ecr get-login-password --region us-east-1 | docker login --username AWS --password-stdin 111122223333.dkr.ecr.us-east-1.amazonaws.com
```

2. Create a repository in Amazon ECR using the [create-repository](#) command.

```
aws ecr create-repository --repository-name hello-world --region us-east-1 --image-scanning-configuration scanOnPush=true --image-tag-mutability MUTABLE
```

Note

The Amazon ECR repository must be in the same AWS Region as the Lambda function.

If successful, you see a response like this:

```
{
  "repository": {
    "repositoryArn": "arn:aws:ecr:us-east-1:111122223333:repository/hello-world",
```

```
    "registryId": "111122223333",
    "repositoryName": "hello-world",
    "repositoryUri": "111122223333.dkr.ecr.us-east-1.amazonaws.com/hello-
world",
    "createdAt": "2023-03-09T10:39:01+00:00",
    "imageTagMutability": "MUTABLE",
    "imageScanningConfiguration": {
      "scanOnPush": true
    },
    "encryptionConfiguration": {
      "encryptionType": "AES256"
    }
  }
}
```

3. Copy the `repositoryUri` from the output in the previous step.
4. Run the [docker tag](#) command to tag your local image into your Amazon ECR repository as the latest version. In this command:
 - `docker-image:test` is the name and [tag](#) of your Docker image. This is the image name and tag that you specified in the `docker build` command.
 - Replace `<ECRrepositoryUri>` with the `repositoryUri` that you copied. Make sure to include `:latest` at the end of the URI.

```
docker tag docker-image:test <ECRrepositoryUri>:latest
```

Example:

```
docker tag docker-image:test 111122223333.dkr.ecr.us-east-1.amazonaws.com/hello-
world:latest
```

5. Run the [docker push](#) command to deploy your local image to the Amazon ECR repository. Make sure to include `:latest` at the end of the repository URI.

```
docker push 111122223333.dkr.ecr.us-east-1.amazonaws.com/hello-world:latest
```

6. [Create an execution role](#) for the function, if you don't already have one. You need the Amazon Resource Name (ARN) of the role in the next step.

7. Create the Lambda function. For `ImageUri`, specify the repository URI from earlier. Make sure to include `:latest` at the end of the URI.

```
aws lambda create-function \  
  --function-name hello-world \  
  --package-type Image \  
  --code ImageUri=111122223333.dkr.ecr.us-east-1.amazonaws.com/hello-world:latest \  
  --role arn:aws:iam::111122223333:role/lambda-ex
```

Note

You can create a function using an image in a different AWS account, as long as the image is in the same Region as the Lambda function. For more information, see [Amazon ECR cross-account permissions](#).

8. Invoke the function.

```
aws lambda invoke --function-name hello-world response.json
```

You should see a response like this:

```
{  
  "ExecutedVersion": "$LATEST",  
  "StatusCode": 200  
}
```

9. To see the output of the function, check the `response.json` file.

To update the function code, you must build the image again, upload the new image to the Amazon ECR repository, and then use the [update-function-code](#) command to deploy the image to the Lambda function.

Lambda resolves the image tag to a specific image digest. This means that if you point the image tag that was used to deploy the function to a new image in Amazon ECR, Lambda doesn't automatically update the function to use the new image.

To deploy the new image to the same Lambda function, you must use the [update-function-code](#) command, even if the image tag in Amazon ECR remains the same. In the following example, the `--publish` option creates a new version of the function using the updated container image.

```
aws lambda update-function-code \  
  --function-name hello-world \  
  --image-uri 111122223333.dkr.ecr.us-east-1.amazonaws.com/hello-world:latest \  
  --publish
```

Using an alternative base image with the runtime interface client

If you use an [OS-only base image](#) or an alternative base image, you must include the runtime interface client in your image. The runtime interface client extends the [Using the Lambda runtime API for custom runtimes](#), which manages the interaction between Lambda and your function code.

Install the [Lambda runtime interface client for Ruby](#) using the RubyGems.org package manager:

```
gem install aws_lambda_ri
```

You can also download the [Ruby runtime interface client](#) from GitHub.

The following example demonstrates how to build a container image for Ruby using a non-AWS base image. The example Dockerfile uses an official Ruby base image. The Dockerfile includes the runtime interface client.

Prerequisites

To complete the steps in this section, you must have the following:

- [AWS CLI version 2](#)
- [Docker](#)
- Ruby

Creating an image from an alternative base image

To create a container image for Ruby using an alternative base image

1. Create a directory for the project, and then switch to that directory.

```
mkdir example  
cd example
```

2. Create a new file called `Gemfile`. This is where you list your application's required RubyGems packages. The AWS SDK for Ruby is available from RubyGems. You should choose specific AWS

service gems to install. For example, to use the [Ruby gem for Lambda](#), your Gemfile should look like this:

```
source 'https://rubygems.org'

gem 'aws-sdk-lambda'
```

Alternatively, the [aws-sdk](#) gem contains every available AWS service gem. This gem is very large. We recommend that you use it only if you depend on many AWS services.

3. Install the dependencies specified in the Gemfile using [bundle install](#).

```
bundle install
```

4. Create a new file called `lambda_function.rb`. You can add the following sample function code to the file for testing, or use your own.

Example Ruby function

```
module LambdaFunction
  class Handler
    def self.process(event:, context:)
      "Hello from Lambda!"
    end
  end
end
```

5. Create a new Dockerfile. The following Dockerfile uses a Ruby base image instead of an [AWS base image](#). The Dockerfile includes the [runtime interface client for Ruby](#), which makes the image compatible with Lambda. Alternatively, you can add the runtime interface client to your application's Gemfile.

- Set the FROM property to the Ruby base image.
- Create a directory for the function code and an environment variable that points to that directory. In this example, the directory is `/var/task`, which mirrors the Lambda execution environment. However, you can choose any directory for the function code because the Dockerfile doesn't use an AWS base image.
- Set the ENTRYPOINT to the module that you want the Docker container to run when it starts. In this case, the module is the runtime interface client.
- Set the CMD argument to the Lambda function handler.

Note that the example Dockerfile does not include a [USER instruction](#). When you deploy a container image to Lambda, Lambda automatically defines a default Linux user with least-privileged permissions. This is different from standard Docker behavior which defaults to the root user when no USER instruction is provided.

Example Dockerfile

```
FROM ruby:2.7

# Install the runtime interface client for Ruby
RUN gem install aws_lambda_ric

# Add the runtime interface client to the PATH
ENV PATH="/usr/local/bundle/bin:${PATH}"

# Create a directory for the Lambda function
ENV LAMBDA_TASK_ROOT=/var/task
RUN mkdir -p ${LAMBDA_TASK_ROOT}
WORKDIR ${LAMBDA_TASK_ROOT}

# Copy Gemfile and Gemfile.lock
COPY Gemfile Gemfile.lock ${LAMBDA_TASK_ROOT}/

# Install Bundler and the specified gems
RUN gem install bundler:2.4.20 && \
    bundle config set --local path 'vendor/bundle' && \
    bundle install

# Copy function code
COPY lambda_function.rb ${LAMBDA_TASK_ROOT}/

# Set runtime interface client as default command for the container runtime
ENTRYPOINT [ "aws_lambda_ric" ]

# Set the CMD to your handler (could also be done as a parameter override outside
of the Dockerfile)
CMD [ "lambda_function.LambdaFunction::Handler.process" ]
```

6. Build the Docker image with the [docker build](#) command. The following example names the image `docker-image` and gives it the test [tag](#).

```
docker build --platform linux/amd64 -t docker-image:test .
```

Note

The command specifies the `--platform linux/amd64` option to ensure that your container is compatible with the Lambda execution environment regardless of the architecture of your build machine. If you intend to create a Lambda function using the ARM64 instruction set architecture, be sure to change the command to use the `--platform linux/arm64` option instead.

(Optional) Test the image locally

Use the [runtime interface emulator](#) to locally test the image. You can [build the emulator into your image](#) or use the following procedure to install it on your local machine.

To install and run the runtime interface emulator on your local machine

1. From your project directory, run the following command to download the runtime interface emulator (x86-64 architecture) from GitHub and install it on your local machine.

Linux/macOS

```
mkdir -p ~/.aws-lambda-rie && \  
  curl -Lo ~/.aws-lambda-rie/aws-lambda-rie https://github.com/aws/aws-lambda-  
runtime-interface-emulator/releases/latest/download/aws-lambda-rie && \  
  chmod +x ~/.aws-lambda-rie/aws-lambda-rie
```

To install the arm64 emulator, replace the GitHub repository URL in the previous command with the following:

```
https://github.com/aws/aws-lambda-runtime-interface-emulator/releases/latest/  
download/aws-lambda-rie-arm64
```

PowerShell

```
$dirPath = "$HOME\.aws-lambda-rie"  
if (-not (Test-Path $dirPath)) {
```

```

    New-Item -Path $dirPath -ItemType Directory
}

$downloadLink = "https://github.com/aws/aws-lambda-runtime-interface-emulator/
releases/latest/download/aws-lambda-rie"
$destinationPath = "$HOME\.aws-lambda-rie\aws-lambda-rie"
Invoke-WebRequest -Uri $downloadLink -OutFile $destinationPath

```

To install the arm64 emulator, replace the `$downloadLink` with the following:

```

https://github.com/aws/aws-lambda-runtime-interface-emulator/releases/latest/
download/aws-lambda-rie-arm64

```

2. Start the Docker image with the **docker run** command. Note the following:

- `docker-image` is the image name and `test` is the tag.
- `aws_lambda_rie lambda_function.LambdaFunction::Handler.process` is the ENTRYPOINT followed by the CMD from your Dockerfile.

Linux/macOS

```

docker run --platform linux/amd64 -d -v ~/.aws-lambda-rie:/aws-lambda -p
9000:8080 \
  --entrypoint /aws-lambda/aws-lambda-rie \
  docker-image:test \
  aws_lambda_rie lambda_function.LambdaFunction::Handler.process

```

PowerShell

```

docker run --platform linux/amd64 -d -v "$HOME\.aws-lambda-rie:/aws-lambda" -p
9000:8080 `
  --entrypoint /aws-lambda/aws-lambda-rie `
  docker-image:test `
  aws_lambda_rie lambda_function.LambdaFunction::Handler.process

```

This command runs the image as a container and creates a local endpoint at `localhost:9000/2015-03-31/functions/function/invocations`.

Note

If you built the Docker image for the ARM64 instruction set architecture, be sure to use the `--platform linux/arm64` option instead of `--platform linux/amd64`.

3. Post an event to the local endpoint.

Linux/macOS

In Linux and macOS, run the following `curl` command:

```
curl "http://localhost:9000/2015-03-31/functions/function/invocations" -d '{}'
```

This command invokes the function with an empty event and returns a response. If you're using your own function code rather than the sample function code, you might want to invoke the function with a JSON payload. Example:

```
curl "http://localhost:9000/2015-03-31/functions/function/invocations" -d '{"payload": "hello world!"}'
```

PowerShell

In PowerShell, run the following `Invoke-WebRequest` command:

```
Invoke-WebRequest -Uri "http://localhost:9000/2015-03-31/functions/function/invocations" -Method Post -Body '{} ' -ContentType "application/json"
```

This command invokes the function with an empty event and returns a response. If you're using your own function code rather than the sample function code, you might want to invoke the function with a JSON payload. Example:

```
Invoke-WebRequest -Uri "http://localhost:9000/2015-03-31/functions/function/invocations" -Method Post -Body '{"payload": "hello world!"}' -ContentType "application/json"
```

4. Get the container ID.

```
docker ps
```

5. Use the [docker kill](#) command to stop the container. In this command, replace `3766c4ab331c` with the container ID from the previous step.

```
docker kill 3766c4ab331c
```

Deploying the image

To upload the image to Amazon ECR and create the Lambda function

1. Run the [get-login-password](#) command to authenticate the Docker CLI to your Amazon ECR registry.
 - Set the `--region` value to the AWS Region where you want to create the Amazon ECR repository.
 - Replace `111122223333` with your AWS account ID.

```
aws ecr get-login-password --region us-east-1 | docker login --username AWS --password-stdin 111122223333.dkr.ecr.us-east-1.amazonaws.com
```

2. Create a repository in Amazon ECR using the [create-repository](#) command.

```
aws ecr create-repository --repository-name hello-world --region us-east-1 --image-scanning-configuration scanOnPush=true --image-tag-mutability MUTABLE
```

Note

The Amazon ECR repository must be in the same AWS Region as the Lambda function.

If successful, you see a response like this:

```
{
  "repository": {
    "repositoryArn": "arn:aws:ecr:us-east-1:111122223333:repository/hello-world",
    "registryId": "111122223333",
    "repositoryName": "hello-world",
```

```
    "repositoryUri": "111122223333.dkr.ecr.us-east-1.amazonaws.com/hello-
world",
    "createdAt": "2023-03-09T10:39:01+00:00",
    "imageTagMutability": "MUTABLE",
    "imageScanningConfiguration": {
      "scanOnPush": true
    },
    "encryptionConfiguration": {
      "encryptionType": "AES256"
    }
  }
}
```

3. Copy the `repositoryUri` from the output in the previous step.
4. Run the [docker tag](#) command to tag your local image into your Amazon ECR repository as the latest version. In this command:
 - `docker-image:test` is the name and [tag](#) of your Docker image. This is the image name and tag that you specified in the `docker build` command.
 - Replace `<ECRrepositoryUri>` with the `repositoryUri` that you copied. Make sure to include `:latest` at the end of the URI.

```
docker tag docker-image:test <ECRrepositoryUri>:latest
```

Example:

```
docker tag docker-image:test 111122223333.dkr.ecr.us-east-1.amazonaws.com/hello-
world:latest
```

5. Run the [docker push](#) command to deploy your local image to the Amazon ECR repository. Make sure to include `:latest` at the end of the repository URI.

```
docker push 111122223333.dkr.ecr.us-east-1.amazonaws.com/hello-world:latest
```

6. [Create an execution role](#) for the function, if you don't already have one. You need the Amazon Resource Name (ARN) of the role in the next step.
7. Create the Lambda function. For `ImageUri`, specify the repository URI from earlier. Make sure to include `:latest` at the end of the URI.

```
aws lambda create-function \  
  --function-name hello-world \  
  --package-type Image \  
  --code ImageUri=111122223333.dkr.ecr.us-east-1.amazonaws.com/hello-world:latest \  
  --role arn:aws:iam::111122223333:role/lambda-ex
```

Note

You can create a function using an image in a different AWS account, as long as the image is in the same Region as the Lambda function. For more information, see [Amazon ECR cross-account permissions](#).

8. Invoke the function.

```
aws lambda invoke --function-name hello-world response.json
```

You should see a response like this:

```
{  
  "ExecutedVersion": "$LATEST",  
  "StatusCode": 200  
}
```

9. To see the output of the function, check the `response.json` file.

To update the function code, you must build the image again, upload the new image to the Amazon ECR repository, and then use the [update-function-code](#) command to deploy the image to the Lambda function.

Lambda resolves the image tag to a specific image digest. This means that if you point the image tag that was used to deploy the function to a new image in Amazon ECR, Lambda doesn't automatically update the function to use the new image.

To deploy the new image to the same Lambda function, you must use the [update-function-code](#) command, even if the image tag in Amazon ECR remains the same. In the following example, the `--publish` option creates a new version of the function using the updated container image.

```
aws lambda update-function-code \  
  --publish
```



```
--function-name hello-world \  
--image-uri 111122223333.dkr.ecr.us-east-1.amazonaws.com/hello-world:latest \  
--publish
```

Working with layers for Ruby Lambda functions

A [Lambda layer](#) is a .zip file archive that contains supplementary code or data. Layers usually contain library dependencies, a [custom runtime](#), or configuration files. Creating a layer involves three general steps:

1. Package your layer content. This means creating a .zip file archive that contains the dependencies you want to use in your functions.
2. Create the layer in Lambda.
3. Add the layer to your functions.

This topic contains steps and guidance on how to properly package and create a Ruby Lambda layer with external library dependencies.

Topics

- [Prerequisites](#)
- [Ruby layer compatibility with the Lambda runtime environment](#)
- [Layer paths for Ruby runtimes](#)
- [Packaging the layer content](#)
- [Creating the layer](#)
- [Adding the layer to your function](#)

Prerequisites

To follow the steps in this section, you must have the following:

- [Ruby 3.3](#), which is distributed with the gem package installer.
- [AWS CLI version 2](#)

Throughout this topic, we reference the [layer-ruby](#) sample application on the **awsdocs** GitHub repository. This application contains scripts that download the dependencies and generate the layers. The application also contains corresponding functions that use dependencies from the layers. After creating a layer, you can deploy and invoke the corresponding function to verify that everything works properly. Because you use the Ruby 3.3 runtime for the functions, the layers must also be compatible with Ruby 3.3.

In the `layer-ruby` sample application, you package the [tzinfo](#) library into a Lambda layer. The `layer/` directory contains the scripts to generate the layer. The `function/` directory contains a sample function to help test that the layer works. The majority of this tutorial walks through how to create and package this layer.

Ruby layer compatibility with the Lambda runtime environment

When you package code in a Ruby layer, you specify the Lambda runtime environments that the code is compatible with. To assess code compatibility with a runtime, consider what versions of Ruby, what operating systems, and what instruction set architectures the code is designed for.

Lambda Ruby runtimes specify their Ruby version and operating system. In this document, you use the Ruby 3.3 runtime, which is based on AL2023. For more information about runtime versions, see [the section called “Supported runtimes”](#). When you create a Lambda function, you specify the instruction set architecture. In this document, you use the `x86_64` architecture. For more information about architectures in Lambda, see [the section called “Instruction sets \(ARM/x86\)”](#).

When you use code provided in a package, each package maintainer independently defines their compatibility. Most gems are written completely in Ruby, and are compatible with any runtime using a compatible Ruby language version.

Sometimes, gems use a Ruby feature called extensions to compile code or include precompiled code as part of their install process. If you depend on a gem with a native extension, you must assess operating system and instruction set architecture compatibility. To assess the compatibility between your gems and your Ruby runtime, you need to inspect your gems and their documentation. You can identify if your gem uses extensions by checking whether `extensions` is defined in its Gem specification. Ruby identifies the platform it is running on through the `RUBY_PLATFORM` global constant. The Lambda Ruby runtime defines the platform as `aarch64-linux` when running on the `arm64` architecture, or `x86_64-linux` when running on the `x86_64` architecture. There is no guaranteed way to check if a gem is compatible with these platforms, but some gems declare their supported platforms through the `platform` Gem specification attribute.

Layer paths for Ruby runtimes

When you add a layer to a function, Lambda loads the layer content into the `/opt` directory of that execution environment. For each Lambda runtime, the `PATH` variable already includes specific folder paths within the `/opt` directory. To ensure that Lambda picks up your layer content, your layer `.zip` file should have its dependencies in the following folder paths:

- `ruby/gems/x`, where `x` is the Ruby version on your runtime, such as `3.3.0`.
- `ruby/lib/`

In this document, use the `ruby/gems/x` path. Lambda expects the contents of this directory to correspond to the structure of a Bundler install directory. Store your gem dependencies in the `/gems` subdirectory of the layer path, alongside other metadata subdirectories. For example, the resulting layer `.zip` file that you create in this tutorial has the following directory structure:

```
layer_content.zip
# ruby
  # gems
    # 3.3.0
      # gems
        # tzinfo-2.0.6
        # <other_dependencies> (i.e. dependencies of the tzinfo package)
        # ...
      # <metadata generated by bundle>
```

The `tzinfo` library is correctly located in the `ruby/gems/3.3.0/` directory. This ensure that Lambda can locate the library during function invocations.

Packaging the layer content

In this example, you package the Ruby `tzinfo` library in a layer `.zip` file. Complete the following steps to install and package the layer content.

To install and package your layer content

1. Clone the [aws-lambda-developer-guide GitHub repo](https://github.com/awsdocs/aws-lambda-developer-guide), which contains the sample code that you need in the `sample-apps/layer-ruby` directory.

```
git clone https://github.com/awsdocs/aws-lambda-developer-guide.git
```

2. Navigate to the `layer` directory of the `layer-ruby` sample app. This directory contains the scripts that you use to create and package the layer properly.

```
cd aws-lambda-developer-guide/sample-apps/layer-ruby/layer
```

3. Examine the [Gemfile](#). This file defines the dependencies that you want to include in the layer, namely the tzinfo library. You can update this file to include any dependencies that you want to include in your own layer.

Example Gemfile

```
source "https://rubygems.org"

gem "tzinfo"
```

4. Ensure that you have permissions to run both scripts.

```
chmod 744 1-install.sh && chmod 744 2-package.sh
```

5. Run the [1-install.sh](#) script using the following command:

```
./1-install.sh
```

This script configures bundler to install dependencies in your project directory. It then installs all required dependencies in the `vendor/bundle/` directory.

Example 1-install.sh

```
bundle config set --local path 'vendor/bundle'
bundle install
```

6. Run the [2-package.sh](#) script using the following command:

```
./2-package.sh
```

This script copies the contents from the `vendor/bundle` directory into a new directory named `ruby`. It then zips the contents of the `ruby` directory into a file named `layer_content.zip`. This is the `.zip` file for your layer. You can unzip the file and verify that it contains the correct file structure, as shown in the [the section called “Layer paths for Ruby runtimes”](#) section.

Example 2-package.sh

```
mkdir -p ruby/gems/3.3.0
cp -r vendor/bundle/ruby/3.3.0/* ruby/gems/3.3.0/
```

```
zip -r layer_content.zip ruby
```

Creating the layer

In this section, you take the `layer_content.zip` file that you generated in the previous section and upload it as a Lambda layer. You can upload a layer using the AWS Management Console or the Lambda API via the AWS Command Line Interface (AWS CLI). When you upload your layer .zip file, in the following [PublishLayerVersion](#) AWS CLI command, specify `ruby3.3` as the compatible runtime and `arm64` as the compatible architecture.

```
aws lambda publish-layer-version --layer-name ruby-requests-layer \  
  --zip-file fileb://layer_content.zip \  
  --compatible-runtimes ruby3.3 \  
  --compatible-architectures "arm64"
```

From the response, note the `LayerVersionArn`, which looks like `arn:aws:lambda:us-east-1:123456789012:layer:ruby-requests-layer:1`. You'll need this Amazon Resource Name (ARN) in the next step of this tutorial, when you add the layer to your function.

Adding the layer to your function

In this section, you deploy a sample Lambda function that uses the `tzinfo` library in its function code, then you attach the layer. To deploy the function, you need a [the section called "Execution role \(permissions for functions to access other resources\)"](#). If you don't have an existing execution role, follow the steps in the collapsible section.

(Optional) Create an execution role

To create an execution role

1. Open the [roles page](#) in the IAM console.
2. Choose **Create role**.
3. Create a role with the following properties.
 - **Trusted entity** – `Lambda`.
 - **Permissions** – `AWSLambdaBasicExecutionRole`.
 - **Role name** – `lambda-role`.

The **AWSLambdaBasicExecutionRole** policy has the permissions that the function needs to write logs to CloudWatch Logs.

The Lambda [function code](#) imports the `tzinfo` library, then returns the status code and a localized date string.

```
require 'json'
require 'tzinfo'

def lambda_handler(event:, context:)
  tz = TZInfo::Timezone.get('America/New_York')
  { statusCode: 200, body: tz.to_local(Time.utc(2018, 2, 1, 12, 30, 0)) }
end
```

To deploy the Lambda function

1. Navigate to the `function/` directory. If you're currently in the `layer/` directory, then run the following command:

```
cd ../function
```

2. Create a `.zip` file deployment package using the following command:

```
zip my_deployment_package.zip lambda_function.rb
```

3. Deploy the function. In the following AWS CLI command, replace the `--role` parameter with your execution role ARN:

```
aws lambda create-function --function-name ruby_function_with_layer \
  --runtime ruby3.3 \
  --architectures "arm64" \
  --handler lambda_function.lambda_handler \
  --role arn:aws:iam::123456789012:role/lambda-role \
  --zip-file fileb://my_deployment_package.zip
```

4. Next, attach the layer to your function. In the following AWS CLI command, replace the `--layers` parameter with the layer version ARN that you noted earlier:

```
aws lambda update-function-configuration --function-name ruby_function_with_layer \
```

```
--cli-binary-format raw-in-base64-out \  
--layers "arn:aws:lambda:us-east-1:123456789012:layer:ruby-requests-layer:1"
```

5. Finally, try to invoke your function using the following AWS CLI command:

```
aws lambda invoke --function-name ruby_function_with_layer \  
--cli-binary-format raw-in-base64-out \  
--payload '{ "key": "value" }' response.json
```

You should see output that looks like this:

```
{  
  "StatusCode": 200,  
  "ExecutedVersion": "$LATEST"  
}
```

The output `response.json` file contains details about the response.

(Optional) Clean up your resources

You can now delete the resources that you created for this tutorial, unless you want to retain them. By deleting AWS resources that you're no longer using, you prevent unnecessary charges to your AWS account.

To delete the Lambda layer

1. Open the [Layers page](#) of the Lambda console.
2. Select the layer that you created.
3. Choose **Delete**, then choose **Delete** again.

To delete the Lambda function

1. Open the [Functions page](#) of the Lambda console.
2. Select the function that you created.
3. Choose **Actions, Delete**.
4. Type **confirm** in the text input field and choose **Delete**.

Using the Lambda context object to retrieve Ruby function information

When Lambda runs your function, it passes a context object to the [handler](#). This object provides methods and properties that provide information about the invocation, function, and execution environment.

Context methods

- `get_remaining_time_in_millis` – Returns the number of milliseconds left before the execution times out.

Context properties

- `function_name` – The name of the Lambda function.
- `function_version` – The [version](#) of the function.
- `invoked_function_arn` – The Amazon Resource Name (ARN) that's used to invoke the function. Indicates if the invoker specified a version number or alias.
- `memory_limit_in_mb` – The amount of memory that's allocated for the function.
- `aws_request_id` – The identifier of the invocation request.
- `log_group_name` – The log group for the function.
- `log_stream_name` – The log stream for the function instance.
- `deadline_ms` – The date that the execution times out, in Unix time milliseconds.
- `identity` – (mobile apps) Information about the Amazon Cognito identity that authorized the request.
- `client_context` – (mobile apps) Client context that's provided to Lambda by the client application.

Log and monitor Ruby Lambda functions

AWS Lambda automatically monitors Lambda functions on your behalf and sends logs to Amazon CloudWatch. Your Lambda function comes with a CloudWatch Logs log group and a log stream for each instance of your function. The Lambda runtime environment sends details about each invocation to the log stream, and relays logs and other output from your function's code. For more information, see [Using CloudWatch Logs with Lambda](#).

This page describes how to produce log output from your Lambda function's code, and access logs using the AWS Command Line Interface, the Lambda console, or the CloudWatch console.

Sections

- [Creating a function that returns logs](#)
- [Viewing logs in the Lambda console](#)
- [Viewing logs in the CloudWatch console](#)
- [Viewing logs using the AWS Command Line Interface \(AWS CLI\)](#)
- [Deleting logs](#)
- [Working with the Ruby logger library](#)

Creating a function that returns logs

To output logs from your function code, you can use `puts` statements, or any logging library that writes to `stdout` or `stderr`. The following example logs the values of environment variables and the event object.

Example `lambda_function.rb`

```
# lambda_function.rb

def handler(event:, context:)
  puts "## ENVIRONMENT VARIABLES"
  puts ENV.to_a
  puts "## EVENT"
  puts event.to_a
end
```

Example log format

```
START RequestId: 8f507cfc-xmpl-4697-b07a-ac58fc914c95 Version: $LATEST
## ENVIRONMENT VARIABLES
environ({'AWS_LAMBDA_LOG_GROUP_NAME': '/aws/lambda/my-function',
  'AWS_LAMBDA_LOG_STREAM_NAME': '2020/01/31/[$LATEST]3893xmpl7fac4485b47bb75b671a283c',
  'AWS_LAMBDA_FUNCTION_NAME': 'my-function', ...})
## EVENT
{'key': 'value'}
END RequestId: 8f507cfc-xmpl-4697-b07a-ac58fc914c95
REPORT RequestId: 8f507cfc-xmpl-4697-b07a-ac58fc914c95 Duration: 15.74 ms Billed
  Duration: 16 ms Memory Size: 128 MB Max Memory Used: 56 MB Init Duration: 130.49 ms
XRAY TraceId: 1-5e34a614-10bdxmplf1fb44f07bc535a1 SegmentId: 07f5xmpl2d1f6f85
  Sampled: true
```

The Ruby runtime logs the START, END, and REPORT lines for each invocation. The report line provides the following details.

REPORT line data fields

- **RequestId** – The unique request ID for the invocation.
- **Duration** – The amount of time that your function's handler method spent processing the event.
- **Billed Duration** – The amount of time billed for the invocation.
- **Memory Size** – The amount of memory allocated to the function.
- **Max Memory Used** – The amount of memory used by the function. When invocations share an execution environment, Lambda reports the maximum memory used across all invocations. This behavior might result in a higher than expected reported value.
- **Init Duration** – For the first request served, the amount of time it took the runtime to load the function and run code outside of the handler method.
- **XRAY TraceId** – For traced requests, the [AWS X-Ray trace ID](#).
- **SegmentId** – For traced requests, the X-Ray segment ID.
- **Sampled** – For traced requests, the sampling result.

For more detailed logs, use the [the section called “Working with the Ruby logger library”](#).

Viewing logs in the Lambda console

You can use the Lambda console to view log output after you invoke a Lambda function.

If your code can be tested from the embedded **Code** editor, you will find logs in the **execution results**. When you use the console test feature to invoke a function, you'll find **Log output** in the **Details** section.

Viewing logs in the CloudWatch console

You can use the Amazon CloudWatch console to view logs for all Lambda function invocations.

To view logs on the CloudWatch console

1. Open the [Log groups page](#) on the CloudWatch console.
2. Choose the log group for your function (`/aws/lambda/your-function-name`).
3. Choose a log stream.

Each log stream corresponds to an [instance of your function](#). A log stream appears when you update your Lambda function, and when additional instances are created to handle multiple concurrent invocations. To find logs for a specific invocation, we recommend instrumenting your function with AWS X-Ray. X-Ray records details about the request and the log stream in the trace.

Viewing logs using the AWS Command Line Interface (AWS CLI)

The AWS CLI is an open-source tool that enables you to interact with AWS services using commands in your command line shell. To complete the steps in this section, you must have the [AWS CLI version 2](#).

You can use the [AWS CLI](#) to retrieve logs for an invocation using the `--log-type` command option. The response contains a `LogResult` field that contains up to 4 KB of base64-encoded logs from the invocation.

Example retrieve a log ID

The following example shows how to retrieve a *log ID* from the `LogResult` field for a function named `my-function`.

```
aws lambda invoke --function-name my-function out --log-type Tail
```

You should see the following output:

```
{
```

```

    "StatusCode": 200,
    "LogResult":
      "U1RBULQgUmVxdWVzdElkOiA4N2QwNDRiOC1mMTU0LTExZTgtOGNkYS0yOTc0YzVlNGZiMjEgVmVyc2l1vb...",
    "ExecutedVersion": "$LATEST"
  }

```

Example decode the logs

In the same command prompt, use the base64 utility to decode the logs. The following example shows how to retrieve base64-encoded logs for my-function.

```

aws lambda invoke --function-name my-function out --log-type Tail \
--query 'LogResult' --output text --cli-binary-format raw-in-base64-out | base64 --
decode

```

The **cli-binary-format** option is required if you're using AWS CLI version 2. To make this the default setting, run `aws configure set cli-binary-format raw-in-base64-out`. For more information, see [AWS CLI supported global command line options](#) in the *AWS Command Line Interface User Guide for Version 2*.

You should see the following output:

```

START RequestId: 57f231fb-1730-4395-85cb-4f71bd2b87b8 Version: $LATEST
"AWS_SESSION_TOKEN": "AgoJb3JpZ2luX2VjELj...", "_X_AMZN_TRACE_ID": "Root=1-5d02e5ca-
f5792818b6fe8368e5b51d50;Parent=191db58857df8395;Sampled=0"",ask/lib:/opt/lib",
END RequestId: 57f231fb-1730-4395-85cb-4f71bd2b87b8
REPORT RequestId: 57f231fb-1730-4395-85cb-4f71bd2b87b8 Duration: 79.67 ms Billed
Duration: 80 ms Memory Size: 128 MB Max Memory Used: 73 MB

```

The base64 utility is available on Linux, macOS, and [Ubuntu on Windows](#). macOS users may need to use `base64 -D`.

Example get-logs.sh script

In the same command prompt, use the following script to download the last five log events. The script uses `sed` to remove quotes from the output file, and sleeps for 15 seconds to allow time for the logs to become available. The output includes the response from Lambda and the output from the `get-log-events` command.

Copy the contents of the following code sample and save in your Lambda project directory as `get-logs.sh`.

The **cli-binary-format** option is required if you're using AWS CLI version 2. To make this the default setting, run `aws configure set cli-binary-format raw-in-base64-out`. For more information, see [AWS CLI supported global command line options](#) in the *AWS Command Line Interface User Guide for Version 2*.

```
#!/bin/bash
aws lambda invoke --function-name my-function --cli-binary-format raw-in-base64-out --
payload '{"key": "value"}' out
sed -i'' -e 's/"//g' out
sleep 15
aws logs get-log-events --log-group-name /aws/lambda/my-function --log-stream-
name stream1 --limit 5
```

Example macOS and Linux (only)

In the same command prompt, macOS and Linux users may need to run the following command to ensure the script is executable.

```
chmod -R 755 get-logs.sh
```

Example retrieve the last five log events

In the same command prompt, run the following script to get the last five log events.

```
./get-logs.sh
```

You should see the following output:

```
{
  "StatusCode": 200,
  "ExecutedVersion": "$LATEST"
}
{
  "events": [
    {
      "timestamp": 1559763003171,
      "message": "START RequestId: 4ce9340a-b765-490f-ad8a-02ab3415e2bf Version:
$LATEST\n",
      "ingestionTime": 1559763003309
    },
    {
```

```

        "timestamp": 1559763003173,
        "message": "2019-06-05T19:30:03.173Z\t4ce9340a-b765-490f-ad8a-02ab3415e2bf
\tINFO\tENVIRONMENT VARIABLES\r{\r  \"AWS_LAMBDA_FUNCTION_VERSION\": \"\$LATEST\",
\r ...",
        "ingestionTime": 1559763018353
    },
    {
        "timestamp": 1559763003173,
        "message": "2019-06-05T19:30:03.173Z\t4ce9340a-b765-490f-ad8a-02ab3415e2bf
\tINFO\tEVENT\r{\r  \"key\": \"value\"\r}\n",
        "ingestionTime": 1559763018353
    },
    {
        "timestamp": 1559763003218,
        "message": "END RequestId: 4ce9340a-b765-490f-ad8a-02ab3415e2bf\n",
        "ingestionTime": 1559763018353
    },
    {
        "timestamp": 1559763003218,
        "message": "REPORT RequestId: 4ce9340a-b765-490f-ad8a-02ab3415e2bf
\tDuration: 26.73 ms\tBilled Duration: 27 ms \tMemory Size: 128 MB\tMax Memory Used: 75
MB\t\n",
        "ingestionTime": 1559763018353
    }
  ],
  "nextForwardToken": "f/34783877304859518393868359594929986069206639495374241795",
  "nextBackwardToken": "b/34783877303811383369537420289090800615709599058929582080"
}

```

Deleting logs

Log groups aren't deleted automatically when you delete a function. To avoid storing logs indefinitely, delete the log group, or [configure a retention period](#) after which logs are deleted automatically.

Working with the Ruby logger library

The Ruby [logger library](#) returns streamlined logs that are easily read. Use the logger utility to output detailed information, messages, and errors codes related to your function.

```
# lambda_function.rb
```

```
require 'logger'

def handler(event:, context:)
  logger = Logger.new($stdout)
  logger.info('## ENVIRONMENT VARIABLES')
  logger.info(ENV.to_a)
  logger.info('## EVENT')
  logger.info(event)
  event.to_a
end
```

The output from `logger` includes the log level, timestamp, and request ID.

```
START RequestId: 1c8df7d3-xmpl-46da-9778-518e6eca8125 Version: $LATEST
[INFO] 2020-01-31T22:12:58.534Z 1c8df7d3-xmpl-46da-9778-518e6eca8125 ##
ENVIRONMENT VARIABLES

[INFO] 2020-01-31T22:12:58.534Z 1c8df7d3-xmpl-46da-9778-518e6eca8125
  environ({'AWS_LAMBDA_LOG_GROUP_NAME': '/aws/lambda/my-function',
'AWS_LAMBDA_LOG_STREAM_NAME': '2020/01/31/[$LATEST]1bbe51xmplb34a2788dbaa7433b0aa4d',
'AWS_LAMBDA_FUNCTION_NAME': 'my-function', ...})

[INFO] 2020-01-31T22:12:58.535Z 1c8df7d3-xmpl-46da-9778-518e6eca8125 ## EVENT

[INFO] 2020-01-31T22:12:58.535Z 1c8df7d3-xmpl-46da-9778-518e6eca8125 {'key':
'value'}

END RequestId: 1c8df7d3-xmpl-46da-9778-518e6eca8125
REPORT RequestId: 1c8df7d3-xmpl-46da-9778-518e6eca8125 Duration: 2.75 ms Billed
Duration: 3 ms Memory Size: 128 MB Max Memory Used: 56 MB Init Duration: 113.51 ms
XRAY TraceId: 1-5e34a66a-474xmpl7c2534a87870b4370 SegmentId: 073cxmpl3e442861
Sampled: true
```

Instrumenting Ruby code in AWS Lambda

Lambda integrates with AWS X-Ray to enable you to trace, debug, and optimize Lambda applications. You can use X-Ray to trace a request as it traverses resources in your application, from the frontend API to storage and database on the backend. By simply adding the X-Ray SDK library to your build configuration, you can record errors and latency for any call that your function makes to an AWS service.

After you've configured active tracing, you can observe specific requests through your application. The [X-Ray service graph](#) shows information about your application and all its components. The following example shows an application with two functions. The primary function processes events and sometimes returns errors. The second function at the top processes errors that appear in the first's log group and uses the AWS SDK to call X-Ray, Amazon Simple Storage Service (Amazon S3), and Amazon CloudWatch Logs.



To toggle active tracing on your Lambda function with the console, follow these steps:

To turn on active tracing

1. Open the [Functions page](#) of the Lambda console.
2. Choose a function.
3. Choose **Configuration** and then choose **Monitoring and operations tools**.
4. Choose **Edit**.
5. Under **X-Ray**, toggle on **Active tracing**.
6. Choose **Save**.

Pricing

You can use X-Ray tracing for free each month up to a certain limit as part of the AWS Free Tier. Beyond that threshold, X-Ray charges for trace storage and retrieval. For more information, see [AWS X-Ray pricing](#).

Your function needs permission to upload trace data to X-Ray. When you activate tracing in the Lambda console, Lambda adds the required permissions to your function's [execution role](#). Otherwise, add the [AWSXRayDaemonWriteAccess](#) policy to the execution role.

X-Ray doesn't trace all requests to your application. X-Ray applies a sampling algorithm to ensure that tracing is efficient, while still providing a representative sample of all requests. The sampling rate is 1 request per second and 5 percent of additional requests. You can't configure the X-Ray sampling rate for your functions.

In X-Ray, a *trace* records information about a request that is processed by one or more *services*. Lambda records 2 segments per trace, which creates two nodes on the service graph. The following image highlights these two nodes:



The first node on the left represents the Lambda service, which receives the invocation request. The second node represents your specific Lambda function. The following example shows a trace with these two segments. Both are named **my-function**, but one has an origin of `AWS::Lambda` and the other has an origin of `AWS::Lambda::Function`. If the `AWS::Lambda` segment shows an error, the Lambda service had an issue. If the `AWS::Lambda::Function` segment shows an error, your function had an issue.

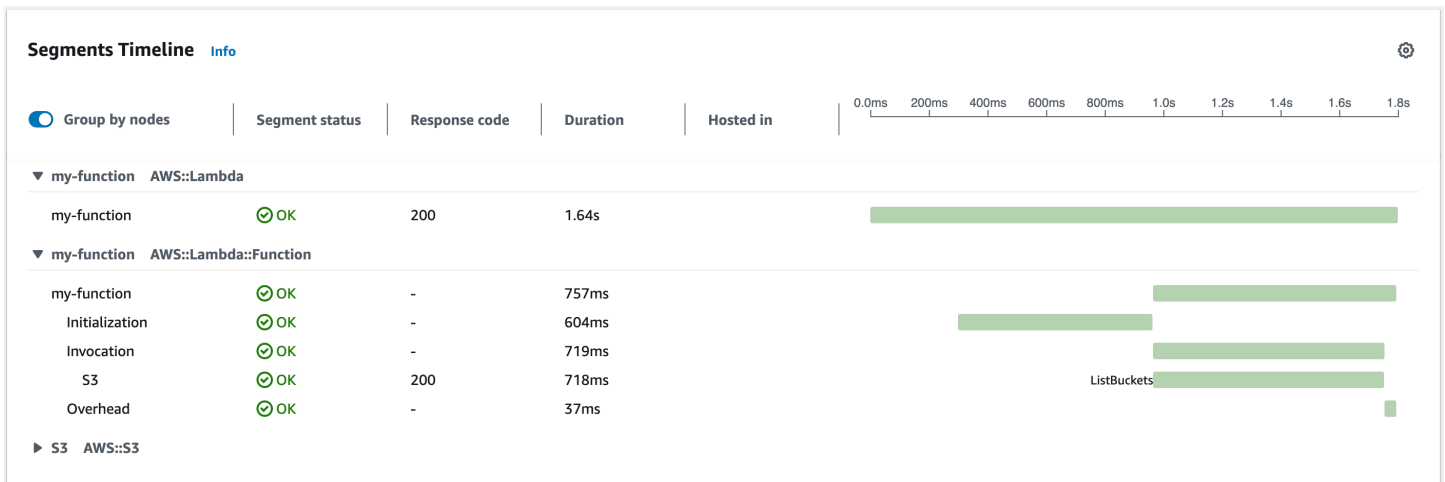

This example expands the `AWS::Lambda::Function` segment to show its three subsegments.

Note

AWS is currently implementing changes to the Lambda service. Due to these changes, you may see minor differences between the structure and content of system log messages and trace segments emitted by different Lambda functions in your AWS account.

The example trace shown here illustrates the old-style function segment. The differences between the old- and new-style segments are described in the following paragraphs.

These changes will be implemented during the coming weeks, and all functions in all AWS Regions except the China and GovCloud regions will transition to use the new-format log messages and trace segments.

The old-style function segment contains the following subsegments:

- **Initialization** – Represents time spent loading your function and running [initialization code](#). This subsegment only appears for the first event that each instance of your function processes.
- **Invocation** – Represents the time spent running your handler code.
- **Overhead** – Represents the time the Lambda runtime spends preparing to handle the next event.

The new-style function segment doesn't contain an `Invocation` subsegment. Instead, customer subsegments are attached directly to the function segment. For more information about the structure of the old- and new-style function segments, see [the section called "Understanding X-Ray traces"](#).

You can instrument your handler code to record metadata and trace downstream calls. To record detail about calls that your handler makes to other resources and services, use the X-Ray SDK for Ruby. To get the SDK, add the `aws-xray-sdk` package to your application's dependencies.

Example [blank-ruby/function/Gemfile](#)

```
# Gemfile
source 'https://rubygems.org'

gem 'aws-xray-sdk', '0.11.4'
gem 'aws-sdk-lambda', '1.39.0'
gem 'test-unit', '3.3.5'
```

To instrument AWS SDK clients, require the `aws-xray-sdk/lambda` module after creating a client in initialization code.

Example [blank-ruby/function/lambda_function.rb](#) – Tracing an AWS SDK client

```
# lambda_function.rb
require 'logger'
require 'json'
require 'aws-sdk-lambda'
$client = Aws::Lambda::Client.new()
$client.get_account_settings()

require 'aws-xray-sdk/lambda'

def lambda_handler(event:, context:)
  logger = Logger.new($stdout)
  ...
```

In X-Ray, a *trace* records information about a request that is processed by one or more *services*. Lambda records 2 segments per trace, which creates two nodes on the service graph. The following image highlights these two nodes:

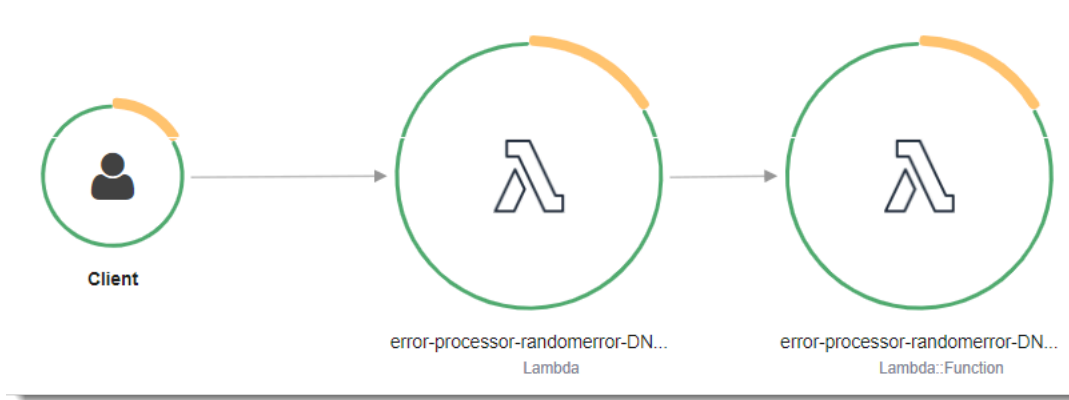

The first node on the left represents the Lambda service, which receives the invocation request. The second node represents your specific Lambda function. The following example shows a trace with these two segments. Both are named **my-function**, but one has an origin of `AWS::Lambda` and the other has an origin of `AWS::Lambda::Function`. If the `AWS::Lambda` segment shows an error, the Lambda service had an issue. If the `AWS::Lambda::Function` segment shows an error, your function had an issue.

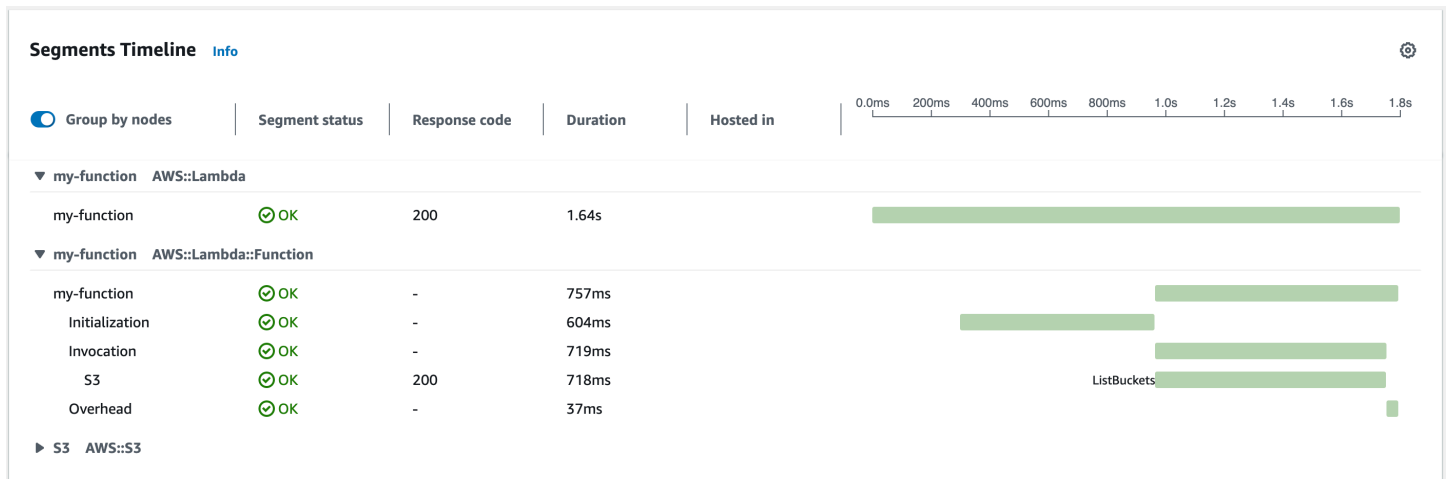

This example expands the `AWS::Lambda::Function` segment to show its three subsegments.

Note

AWS is currently implementing changes to the Lambda service. Due to these changes, you may see minor differences between the structure and content of system log messages and trace segments emitted by different Lambda functions in your AWS account. The example trace shown here illustrates the old-style function segment. The differences between the old- and new-style segments are described in the following paragraphs.

These changes will be implemented during the coming weeks, and all functions in all AWS Regions except the China and GovCloud regions will transition to use the new-format log messages and trace segments.

The old-style function segment contains the following subsegments:

- **Initialization** – Represents time spent loading your function and running [initialization code](#). This subsegment only appears for the first event that each instance of your function processes.
- **Invocation** – Represents the time spent running your handler code.
- **Overhead** – Represents the time the Lambda runtime spends preparing to handle the next event.

The new-style function segment doesn't contain an `Invocation` subsegment. Instead, customer subsegments are attached directly to the function segment. For more information about the structure of the old- and new-style function segments, see [the section called “Understanding X-Ray traces”](#).

You can also instrument HTTP clients, record SQL queries, and create custom subsegments with annotations and metadata. For more information, see [The X-Ray SDK for Ruby](#) in the AWS X-Ray Developer Guide.

Sections

- [Enabling active tracing with the Lambda API](#)
- [Enabling active tracing with AWS CloudFormation](#)
- [Storing runtime dependencies in a layer](#)

Enabling active tracing with the Lambda API

To manage tracing configuration with the AWS CLI or AWS SDK, use the following API operations:

- [UpdateFunctionConfiguration](#)
- [GetFunctionConfiguration](#)
- [CreateFunction](#)

The following example AWS CLI command enables active tracing on a function named **my-function**.

```
aws lambda update-function-configuration --function-name my-function \  
--tracing-config Mode=Active
```

Tracing mode is part of the version-specific configuration when you publish a version of your function. You can't change the tracing mode on a published version.

Enabling active tracing with AWS CloudFormation

To activate tracing on an `AWS::Lambda::Function` resource in an AWS CloudFormation template, use the `TracingConfig` property.

Example [function-inline.yml](#) – Tracing configuration

```
Resources:  
  function:  
    Type: AWS::Lambda::Function  
    Properties:  
      TracingConfig:  
        Mode: Active  
      ...
```

For an AWS Serverless Application Model (AWS SAM) `AWS::Serverless::Function` resource, use the `Tracing` property.

Example [template.yml](#) – Tracing configuration

```
Resources:  
  function:  
    Type: AWS::Serverless::Function  
    Properties:  
      Tracing: Active  
      ...
```

Storing runtime dependencies in a layer

If you use the X-Ray SDK to instrument AWS SDK clients your function code, your deployment package can become quite large. To avoid uploading runtime dependencies every time you update your function code, package the X-Ray SDK in a [Lambda layer](#).

The following example shows an `AWS::Serverless::LayerVersion` resource that stores X-Ray SDK for Ruby.

Example [template.yml](#) – Dependencies layer

```
Resources:
  function:
    Type: AWS::Serverless::Function
    Properties:
      CodeUri: function/.
      Tracing: Active
      Layers:
        - !Ref libs
        ...
  libs:
    Type: AWS::Serverless::LayerVersion
    Properties:
      LayerName: blank-ruby-lib
      Description: Dependencies for the blank-ruby sample app.
      ContentUri: lib/.
      CompatibleRuntimes:
        - ruby2.5
```

With this configuration, you update the library layer only if you change your runtime dependencies. Since the function deployment package contains only your code, this can help reduce upload times.

Creating a layer for dependencies requires build changes to generate the layer archive prior to deployment. For a working example, see the [blank-ruby](#) sample application.

Building Lambda functions with Java

You can run Java code in AWS Lambda. Lambda provides [runtimes](#) for Java that run your code to process events. Your code runs in an Amazon Linux environment that includes AWS credentials from an AWS Identity and Access Management (IAM) role that you manage.

Lambda supports the following Java runtimes.

Name	Identifier	Operating system	Deprecation date	Block function create	Block function update
Java 21	java21	Amazon Linux 2023	Not scheduled	Not scheduled	Not scheduled
Java 17	java17	Amazon Linux 2	Not scheduled	Not scheduled	Not scheduled
Java 11	java11	Amazon Linux 2	Not scheduled	Not scheduled	Not scheduled
Java 8	java8.a12	Amazon Linux 2	Not scheduled	Not scheduled	Not scheduled

Lambda provides the following libraries for Java functions:

- [com.amazonaws:aws-lambda-java-core](#) (required) – Defines handler method interfaces and the context object that the runtime passes to the handler. If you define your own input types, this is the only library that you need.
- [com.amazonaws:aws-lambda-java-events](#) – Input types for events from services that invoke Lambda functions.
- [com.amazonaws:aws-lambda-java-log4j2](#) – An appender library for Apache Log4j 2 that you can use to add the request ID for the current invocation to your [function logs](#).
- [AWS SDK for Java 2.0](#) – The official AWS SDK for the Java programming language.

⚠ Important

Don't use private components of the JDK API, such as private fields, methods, or classes. Non-public API components can change or be removed in any update, causing your application to break.

To create a Java function

1. Open the [Lambda console](#).
2. Choose **Create function**.
3. Configure the following settings:
 - **Function name:** Enter a name for the function.
 - **Runtime:** Choose **Java 21**.
4. Choose **Create function**.

The console creates a Lambda function with a handler class named `Hello`. Since Java is a compiled language, you can't view or edit the source code in the Lambda console, but you can modify its configuration, invoke it, and configure triggers.

📘 Note

To get started with application development in your local environment, deploy one of the [sample applications](#) available in this guide's GitHub repository.

The `Hello` class has a function named `handleRequest` that takes an event object and a context object. This is the [handler function](#) that Lambda calls when the function is invoked. The Java function runtime gets invocation events from Lambda and passes them to the handler. In the function configuration, the handler value is `example>Hello::handleRequest`.

To update the function's code, you create a deployment package, which is a .zip file archive that contains your function code. As your function development progresses, you will want to store your function code in source control, add libraries, and automate deployments. Start by [creating a deployment package](#) and updating your code at the command line.

The function runtime passes a context object to the handler, in addition to the invocation event. The [context object](#) contains additional information about the invocation, the function, and the execution environment. More information is available from environment variables.

Your Lambda function comes with a CloudWatch Logs log group. The function runtime sends details about each invocation to CloudWatch Logs. It relays any [logs that your function outputs](#) during invocation. If your function returns an error, Lambda formats the error and returns it to the invoker.

Topics

- [Define Lambda function handler in Java](#)
- [Deploy Java Lambda functions with .zip or JAR file archives](#)
- [Deploy Java Lambda functions with container images](#)
- [Working with layers for Java Lambda functions](#)
- [Customize serialization for Lambda Java functions](#)
- [Customize Java runtime startup behavior for Lambda functions](#)
- [Using the Lambda context object to retrieve Java function information](#)
- [Log and monitor Java Lambda functions](#)
- [Instrumenting Java code in AWS Lambda](#)
- [Java sample applications for AWS Lambda](#)

Define Lambda function handler in Java

The Lambda function *handler* is the method in your function code that processes events. When your function is invoked, Lambda runs the handler method. Your function runs until the handler returns a response, exits, or times out.

The GitHub repo for this guide provides easy-to-deploy sample applications that demonstrate a variety of handler types. For details, see the [end of this topic](#).

Sections

- [Example handler: Java 17 runtimes](#)
- [Example handler: Java 11 runtimes and below](#)
- [Initialization code](#)
- [Choosing input and output types](#)
- [Handler interfaces](#)
- [Code best practices for Java Lambda functions](#)
- [Sample handler code](#)

Example handler: Java 17 runtimes

In the following Java 17 example, a class named `HandlerIntegerJava17` defines a handler method named `handleRequest`. The handler method takes in the following inputs:

- An `IntegerRecord`, which is a custom Java [record](#) that represents event data. In this example, we define `IntegerRecord` as follows:

```
record IntegerRecord(int x, int y, String message) {  
}
```

- A [context object](#), which provides methods and properties that provide information about the invocation, function, and execution environment.

Suppose we want to write a function that logs the message from the input `IntegerRecord`, and returns the sum of `x` and `y`. The following is the function code:

Example [HandlerIntegerJava17.java](#)

```
package example;

import com.amazonaws.services.lambda.runtime.Context;
import com.amazonaws.services.lambda.runtime.LambdaLogger;
import com.amazonaws.services.lambda.runtime.RequestHandler;

// Handler value: example.HandlerInteger
public class HandlerIntegerJava17 implements RequestHandler<IntegerRecord, Integer>{

    @Override
    /*
     * Takes in an InputRecord, which contains two integers and a String.
     * Logs the String, then returns the sum of the two Integers.
     */
    public Integer handleRequest(IntegerRecord event, Context context)
    {
        LambdaLogger logger = context.getLogger();
        logger.log("String found: " + event.message());
        return event.x() + event.y();
    }
}

record IntegerRecord(int x, int y, String message) {
}
```

You specify which method you want Lambda to invoke by setting the handler parameter on your function's configuration. You can express the handler in the following formats:

- *package.Class::method* – Full format. For example: `example.Handler::handleRequest`.
- *package.Class* – Abbreviated format for classes that implement a [handler interface](#). For example: `example.Handler`.

When Lambda invokes your handler, the [Lambda runtime](#) receives an event as a JSON-formatted string and converts it into an object. For the previous example, a sample event might look like the following:

Example [event.json](#)

```
{
```

```
"x": 1,  
"y": 20,  
"message": "Hello World!"  
}
```

You can save this file and test your function locally with the following AWS Command Line Interface (CLI) command:

```
aws lambda invoke --function-name function_name --payload file:///event.json out.json
```

Example handler: Java 11 runtimes and below

Lambda supports records in Java 17 and later runtimes. In all Java runtimes, you can use a class to represent event data. The following example takes a list of integers and a context object as input, and returns the sum of all integers in the list.

Example [Handler.java](#)

In the following example, a class named `Handler` defines a handler method named `handleRequest`. The handler method takes an event and context object as input and returns a string.

Example [HandlerList.java](#)

```
package example;  
  
import com.amazonaws.services.lambda.runtime.Context;  
import com.amazonaws.services.lambda.runtime.LambdaLogger;  
import com.amazonaws.services.lambda.runtime.RequestHandler;  
  
import java.util.List;  
  
// Handler value: example.HandlerList  
public class HandlerList implements RequestHandler<List<Integer>, Integer>{  
  
    @Override  
    /*  
     * Takes a list of Integers and returns its sum.  
     */  
    public Integer handleRequest(List<Integer> event, Context context)  
    {
```

```
LambdaLogger logger = context.getLogger();
logger.log("EVENT TYPE: " + event.getClass().toString());
return event.stream().mapToInt(Integer::intValue).sum();
}
}
```

For more examples, see [Sample handler code](#).

Initialization code

Lambda runs your static code and the class constructor during the [initialization phase](#) before invoking your function for the first time. Resources created during initialization stay in memory between invocations and can be reused by the handler thousands of times. Thus, you can add [initialization code](#) outside of your main handler method to save compute time and reuse resources across multiple invocations.

In the following example, the client initialization code is outside the main handler method. The runtime initializes the client before the function serves its first event. Subsequent events are much faster because Lambda doesn't need to initialize the client again.

Example [Handler.java](#)

```
package example;

import com.amazonaws.services.lambda.runtime.Context;
import com.amazonaws.services.lambda.runtime.LambdaLogger;
import com.amazonaws.services.lambda.runtime.RequestHandler;

import java.util.Map;

import software.amazon.awssdk.services.lambda.LambdaClient;
import software.amazon.awssdk.services.lambda.model.GetAccountSettingsResponse;
import software.amazon.awssdk.services.lambda.model.LambdaException;

// Handler value: example.Handler
public class Handler implements RequestHandler<Map<String,String>, String> {

    private static final LambdaClient lambdaClient = LambdaClient.builder().build();

    @Override
    public String handleRequest(Map<String,String> event, Context context) {
```

```
LambdaLogger logger = context.getLogger();
logger.log("Handler invoked");

GetAccountSettingsResponse response = null;
try {
    response = lambdaClient.getAccountSettings();
} catch (LambdaException e) {
    logger.log(e.getMessage());
}
return response != null ? "Total code size for your account is " +
response.accountLimit().totalCodeSize() + " bytes" : "Error";
}
```

Choosing input and output types

You specify the type of object that the event maps to in the handler method's signature. In the preceding example, the Java runtime deserializes the event into a type that implements the `Map<String, String>` interface. String-to-string maps work for flat events like the following:

Example [Event.json](#) – Weather data

```
{
  "temperatureK": 281,
  "windKmh": -3,
  "humidityPct": 0.55,
  "pressureHPa": 1020
}
```

However, the value of each field must be a string or number. If the event includes a field that has an object as a value, the runtime can't deserialize it and returns an error.

Choose an input type that works with the event data that your function processes. You can use a basic type, a generic type, or a well-defined type.

Input types

- `Integer`, `Long`, `Double`, etc. – The event is a number with no additional formatting—for example, `3.5`. The runtime converts the value into an object of the specified type.
- `String` – The event is a JSON string, including quotes—for example, `"My string."`. The runtime converts the value (without quotes) into a `String` object.

- *Type*, `Map<String, Type>` etc. – The event is a JSON object. The runtime deserializes it into an object of the specified type or interface.
- `List<Integer>`, `List<String>`, `List<Object>`, etc. – The event is a JSON array. The runtime deserializes it into an object of the specified type or interface.
- `InputStream` – The event is any JSON type. The runtime passes a byte stream of the document to the handler without modification. You deserialize the input and write output to an output stream.
- Library type – For events sent by AWS services, use the types in the [aws-lambda-java-events](#) library.

If you define your own input type, it should be a deserializable, mutable plain old Java object (POJO), with a default constructor and properties for each field in the event. Keys in the event that don't map to a property as well as properties that aren't included in the event are dropped without error.

The output type can be an object or `void`. The runtime serializes return values into text. If the output is an object with fields, the runtime serializes it into a JSON document. If it's a type that wraps a primitive value, the runtime returns a text representation of that value.

Handler interfaces

The [aws-lambda-java-core](#) library defines two interfaces for handler methods. Use the provided interfaces to simplify handler configuration and validate the handler method signature at compile time.

- [com.amazonaws.services.lambda.runtime.RequestHandler](#)
- [com.amazonaws.services.lambda.runtime.RequestStreamHandler](#)

The `RequestHandler` interface is a generic type that takes two parameters: the input type and the output type. Both types must be objects. When you use this interface, the Java runtime deserializes the event into an object with the input type, and serializes the output into text. Use this interface when the built-in serialization works with your input and output types.

Example [Handler.java](#) – Handler interface

```
// Handler value: example.Handler
```

```
public class Handler implements RequestHandler<Map<String,String>, String>{
    @Override
    public String handleRequest(Map<String,String> event, Context context)
```

To use your own serialization, implement the `RequestStreamHandler` interface. With this interface, Lambda passes your handler an input stream and output stream. The handler reads bytes from the input stream, writes to the output stream, and returns void.

The following Java 21 example shows how you might use a Lambda function to process orders. The example uses buffered reader and writer types to work with the input and output streams, and shows how you can define custom Java records to use within your function.

Example [HandlerStream.java](#)

```
import com.amazonaws.services.lambda.runtime.Context;
import com.amazonaws.services.lambda.runtime.RequestStreamHandler;
import com.fasterxml.jackson.annotation.JsonProperty;
import com.fasterxml.jackson.databind.ObjectMapper;

import java.io.IOException;
import java.io.InputStream;
import java.io.OutputStream;
import java.util.List;

public class HandlerStream implements RequestStreamHandler {

    private static final ObjectMapper objectMapper = new ObjectMapper();

    @Override
    public void handleRequest(InputStream input, OutputStream output, Context context)
        throws IOException {
        Order order = objectMapper.readValue(input, Order.class);

        processOrder(order);
        OrderAccepted orderAccepted = new OrderAccepted(order.orderId);

        objectMapper.writeValue(output, orderAccepted);
    }

    private void processOrder(Order order) {
        // business logic
    }
}
```

```
public record Order(@JsonProperty("orderId") String orderId, @JsonProperty("items")
List<Item> items) { }

public record Item(@JsonProperty("name") String name, @JsonProperty("quantity")
Integer quantity) { }

public record OrderAccepted(@JsonProperty("orderId") String orderId) { }
}
```

Code best practices for Java Lambda functions

Adhere to the guidelines in the following list to use best coding practices when building your Lambda functions:

- **Separate the Lambda handler from your core logic.** This allows you to make a more unit-testable function.
- **Control the dependencies in your function's deployment package.** The AWS Lambda execution environment contains a number of libraries. To enable the latest set of features and security updates, Lambda will periodically update these libraries. These updates may introduce subtle changes to the behavior of your Lambda function. To have full control of the dependencies your function uses, package all of your dependencies with your deployment package.
- **Minimize the complexity of your dependencies.** Prefer simpler frameworks that load quickly on [execution environment](#) startup. For example, prefer simpler Java dependency injection (IoC) frameworks like [Dagger](#) or [Guice](#), over more complex ones like [Spring Framework](#).
- **Minimize your deployment package size to its runtime necessities.** This will reduce the amount of time that it takes for your deployment package to be downloaded and unpacked ahead of invocation. For functions authored in Java, avoid uploading the entire AWS SDK library as part of your deployment package. Instead, selectively depend on the modules which pick up components of the SDK you need (e.g. DynamoDB, Amazon S3 SDK modules and [Lambda core libraries](#)).
- **Take advantage of execution environment reuse to improve the performance of your function.** Initialize SDK clients and database connections outside of the function handler, and cache static assets locally in the /tmp directory. Subsequent invocations processed by the same instance of your function can reuse these resources. This saves cost by reducing function run time.

To avoid potential data leaks across invocations, don't use the execution environment to store user data, events, or other information with security implications. If your function relies on a mutable state that can't be stored in memory within the handler, consider creating a separate function or separate versions of a function for each user.

- **Use a keep-alive directive to maintain persistent connections.** Lambda purges idle connections over time. Attempting to reuse an idle connection when invoking a function will result in a connection error. To maintain your persistent connection, use the keep-alive directive associated with your runtime. For an example, see [Reusing Connections with Keep-Alive in Node.js](#).
- **Use [environment variables](#) to pass operational parameters to your function.** For example, if you are writing to an Amazon S3 bucket, instead of hard-coding the bucket name you are writing to, configure the bucket name as an environment variable.
- **Avoid using recursive invocations** in your Lambda function, where the function invokes itself or initiates a process that may invoke the function again. This could lead to unintended volume of function invocations and escalated costs. If you see an unintended volume of invocations, set the function reserved concurrency to 0 immediately to throttle all invocations to the function, while you update the code.
- **Do not use non-documented, non-public APIs** in your Lambda function code. For AWS Lambda managed runtimes, Lambda periodically applies security and functional updates to Lambda's internal APIs. These internal API updates may be backwards-incompatible, leading to unintended consequences such as invocation failures if your function has a dependency on these non-public APIs. See [the API reference](#) for a list of publicly available APIs.
- **Write idempotent code.** Writing idempotent code for your functions ensures that duplicate events are handled the same way. Your code should properly validate events and gracefully handle duplicate events. For more information, see [How do I make my Lambda function idempotent?](#).
- **Avoid using the Java DNS cache.** Lambda functions already cache DNS responses. If you use another DNS cache, then you might experience connection timeouts.

The `java.util.logging.Logger` class can indirectly enable the JVM DNS cache. To override the default settings, set [networkaddress.cache.ttl](#) to 0 before initializing `logger`. Example:

```
public class MyHandler {
    // first set TTL property
    static{
```

```
    java.security.Security.setProperty("networkaddress.cache.ttl" , "0");
  }
  // then instantiate logger
  var logger = org.apache.logging.log4j.LogManager.getLogger(MyHandler.class);
}
```

- **Reduce the time it takes Lambda to unpack deployment packages** authored in Java by putting your dependency .jar files in a separate /lib directory. This is faster than putting all your function's code in a single jar with a large number of .class files. See [Deploy Java Lambda functions with .zip or JAR file archives](#) for instructions.

Sample handler code

The GitHub repository for this guide includes sample applications that demonstrate the use of various handler types and interfaces. Each sample application includes scripts for easy deployment and cleanup, an AWS SAM template, and supporting resources.

Sample Lambda applications in Java

- [java17-examples](#) – A Java function that demonstrates how to use a Java record to represent an input event data object.
- [java-basic](#) – A collection of minimal Java functions with unit tests and variable logging configuration.
- [java-events](#) – A collection of Java functions that contain skeleton code for how to handle events from various services such as Amazon API Gateway, Amazon SQS, and Amazon Kinesis. These functions use the latest version of the [aws-lambda-java-events](#) library (3.0.0 and newer). These examples do not require the AWS SDK as a dependency.
- [s3-java](#) – A Java function that processes notification events from Amazon S3 and uses the Java Class Library (JCL) to create thumbnails from uploaded image files.
- [custom-serialization](#) – Examples of how to implement [custom serialization](#) using popular libraries such as fastJson, Gson, Moshi, and jackson-jr.
- [Use API Gateway to invoke a Lambda function](#) – A Java function that scans a Amazon DynamoDB table that contains employee information. It then uses Amazon Simple Notification Service to send a text message to employees celebrating their work anniversaries. This example uses API Gateway to invoke the function.

The `java-events` and `s3-java` applications take an AWS service event as input and return a string. The `java-basic` application includes several types of handlers:

- [Handler.java](#) – Takes a `Map<String, String>` as input.
- [HandlerInteger.java](#) – Takes an `Integer` as input.
- [HandlerList.java](#) – Takes a `List<Integer>` as input.
- [HandlerStream.java](#) – Takes an `InputStream` and `OutputStream` as input.
- [HandlerString.java](#) – Takes a `String` as input.
- [HandlerWeatherData.java](#) – Takes a custom type as input.

To test different handler types, just change the handler value in the AWS SAM template. For detailed instructions, see the sample application's readme file.

Deploy Java Lambda functions with .zip or JAR file archives

Your AWS Lambda function's code consists of scripts or compiled programs and their dependencies. You use a *deployment package* to deploy your function code to Lambda. Lambda supports two types of deployment packages: container images and .zip file archives.

This page describes how to create your deployment package as a .zip file or Jar file, and then use the deployment package to deploy your function code to AWS Lambda using the AWS Command Line Interface (AWS CLI).

Sections

- [Prerequisites](#)
- [Tools and libraries](#)
- [Building a deployment package with Gradle](#)
- [Creating a Java layer for your dependencies](#)
- [Building a deployment package with Maven](#)
- [Uploading a deployment package with the Lambda console](#)
- [Uploading a deployment package with the AWS CLI](#)
- [Uploading a deployment package with AWS SAM](#)

Prerequisites

The AWS CLI is an open-source tool that enables you to interact with AWS services using commands in your command line shell. To complete the steps in this section, you must have the [AWS CLI version 2](#).

Tools and libraries

Lambda provides the following libraries for Java functions:

- [com.amazonaws:aws-lambda-java-core](#) (required) – Defines handler method interfaces and the context object that the runtime passes to the handler. If you define your own input types, this is the only library that you need.
- [com.amazonaws:aws-lambda-java-events](#) – Input types for events from services that invoke Lambda functions.

- [com.amazonaws:aws-lambda-java-log4j2](#) – An appender library for Apache Log4j 2 that you can use to add the request ID for the current invocation to your [function logs](#).
- [AWS SDK for Java 2.0](#) – The official AWS SDK for the Java programming language.

These libraries are available through [Maven Central Repository](#). Add them to your build definition as follows:

Gradle

```
dependencies {  
    implementation 'com.amazonaws:aws-lambda-java-core:1.2.2'  
    implementation 'com.amazonaws:aws-lambda-java-events:3.11.1'  
    runtimeOnly 'com.amazonaws:aws-lambda-java-log4j2:1.5.1'  
}
```

Maven

```
<dependencies>  
  <dependency>  
    <groupId>com.amazonaws</groupId>  
    <artifactId>aws-lambda-java-core</artifactId>  
    <version>1.2.2</version>  
  </dependency>  
  <dependency>  
    <groupId>com.amazonaws</groupId>  
    <artifactId>aws-lambda-java-events</artifactId>  
    <version>3.11.1</version>  
  </dependency>  
  <dependency>  
    <groupId>com.amazonaws</groupId>  
    <artifactId>aws-lambda-java-log4j2</artifactId>  
    <version>1.5.1</version>  
  </dependency>  
</dependencies>
```

To create a deployment package, compile your function code and dependencies into a single .zip file or Java Archive (JAR) file. For Gradle, [use the Zip build type](#). For Apache Maven, [use the Maven Shade plugin](#). To upload your deployment package, use the Lambda console, the Lambda API, or AWS Serverless Application Model (AWS SAM).

Note

To keep your deployment package size small, package your function's dependencies in layers. Layers enable you to manage your dependencies independently, can be used by multiple functions, and can be shared with other accounts. For more information, see [Lambda layers](#).

Building a deployment package with Gradle

To create a deployment package with your function's code and dependencies in Gradle, use the Zip build type. Here's an example from a [complete sample build.gradle file](#):

Example build.gradle – Build task

```
task buildZip(type: Zip) {
    into('lib') {
        from(jar)
        from(configurations.runtimeClasspath)
    }
}
```

This build configuration produces a deployment package in the `build/distributions` directory. Within the `into('lib')` statement, the `jar` task assembles a jar archive containing your main classes into a folder named `lib`. Additionally, the `configurations.runtimeClasspath` task copies dependency libraries from the build's classpath into the same `lib` folder.

Example build.gradle – Dependencies

```
dependencies {
    ...
    implementation 'com.amazonaws:aws-lambda-java-core:1.2.2'
    implementation 'com.amazonaws:aws-lambda-java-events:3.11.1'
    implementation 'org.apache.logging.log4j:log4j-api:2.17.1'
    implementation 'org.apache.logging.log4j:log4j-core:2.17.1'
    runtimeOnly 'org.apache.logging.log4j:log4j-slf4j18-impl:2.17.1'
    runtimeOnly 'com.amazonaws:aws-lambda-java-log4j2:1.5.1'
    ...
}
```

Lambda loads JAR files in Unicode alphabetical order. If multiple JAR files in the `lib` directory contain the same class, the first one is used. You can use the following shell script to identify duplicate classes:

Example `test-zip.sh`

```
mkdir -p expanded
unzip path/to/my/function.zip -d expanded
find ./expanded/lib -name '*.jar' | xargs -n1 zipinfo -1 | grep '.*.class' | sort |
  uniq -c | sort
```

Creating a Java layer for your dependencies

Note

Using layers with functions in a compiled language like Java may not provide the same amount of benefit as with an interpreted language like Python. Since Java is a compiled language, your functions still have to manually load any shared assemblies into memory during the init phase, which can increase cold start times. Instead, we recommend including any shared code at compile time to take advantage of any built-in compiler optimizations.

The instructions in this section show you how to include your dependencies in a layer. For instructions on how to include your dependencies in your deployment package, see [the section called “Building a deployment package with Gradle”](#) or [the section called “Building a deployment package with Maven”](#).

When you add a layer to a function, Lambda loads the layer content into the `/opt` directory of that execution environment. For each Lambda runtime, the `PATH` variable already includes specific folder paths within the `/opt` directory. To ensure that Lambda picks up your layer content, your layer `.zip` file should have its dependencies in the following folder paths:

- `java/lib` (CLASSPATH)

For example, your layer `.zip` file structure might look like the following:

```
jackson.zip
# java/lib/jackson-core-2.2.3.jar
```

In addition, Lambda automatically detects any libraries in the `/opt/lib` directory, and any binaries in the `/opt/bin` directory. To ensure that Lambda properly finds your layer content, you can also create a layer with the following structure:

```
custom-layer.zip
# lib
  | lib_1
  | lib_2
# bin
  | bin_1
  | bin_2
```

After you package your layer, see [the section called “Creating and deleting layers”](#) and [the section called “Adding layers”](#) to complete your layer setup.

Building a deployment package with Maven

To build a deployment package with Maven, use the [Maven Shade plugin](#). The plugin creates a JAR file that contains the compiled function code and all of its dependencies.

Example pom.xml – Plugin configuration

```
<plugin>
  <groupId>org.apache.maven.plugins</groupId>
  <artifactId>maven-shade-plugin</artifactId>
  <version>3.2.2</version>
  <configuration>
    <createDependencyReducedPom>>false</createDependencyReducedPom>
  </configuration>
  <executions>
    <execution>
      <phase>package</phase>
      <goals>
        <goal>shade</goal>
      </goals>
    </execution>
  </executions>
</plugin>
```

To build the deployment package, use the `mvn package` command.

```
[INFO] Scanning for projects...
```

```
[INFO] -----< com.example:java-maven >-----
[INFO] Building java-maven-function 1.0-SNAPSHOT
[INFO] -----[ jar ]-----
...
[INFO] --- maven-jar-plugin:2.4:jar (default-jar) @ java-maven ---
[INFO] Building jar: target/java-maven-1.0-SNAPSHOT.jar
[INFO]
[INFO] --- maven-shade-plugin:3.2.2:shade (default) @ java-maven ---
[INFO] Including com.amazonaws:aws-lambda-java-core:jar:1.2.2 in the shaded jar.
[INFO] Including com.amazonaws:aws-lambda-java-events:jar:3.11.1 in the shaded jar.
[INFO] Including joda-time:joda-time:jar:2.6 in the shaded jar.
[INFO] Including com.google.code.gson:gson:jar:2.8.6 in the shaded jar.
[INFO] Replacing original artifact with shaded artifact.
[INFO] Replacing target/java-maven-1.0-SNAPSHOT.jar with target/java-maven-1.0-
SNAPSHOT-shaded.jar
[INFO] -----
[INFO] BUILD SUCCESS
[INFO] -----
[INFO] Total time: 8.321 s
[INFO] Finished at: 2020-03-03T09:07:19Z
[INFO] -----
```

This command generates a JAR file in the target directory.

Note

If you're working with a [multi-release JAR \(MRJAR\)](#), you must include the MRJAR (i.e. the shaded JAR produced by the Maven Shade plugin) in the `lib` directory and zip it before uploading your deployment package to Lambda. Otherwise, Lambda may not properly unpack your JAR file, causing your `MANIFEST.MF` file to be ignored.

If you use the appender library (`aws-lambda-java-log4j2`), you must also configure a transformer for the Maven Shade plugin. The transformer library combines versions of a cache file that appear in both the appender library and in Log4j.

Example pom.xml – Plugin configuration with Log4j 2 appender

```
<plugin>
  <groupId>org.apache.maven.plugins</groupId>
  <artifactId>maven-shade-plugin</artifactId>
```

```
<version>3.2.2</version>
<configuration>
  <createDependencyReducedPom>>false</createDependencyReducedPom>
</configuration>
<executions>
  <execution>
    <phase>package</phase>
    <goals>
      <goal>shade</goal>
    </goals>
    <configuration>
      <transformers>
        <transformer
implementation="com.github.edwgiz.maven_shade_plugin.log4j2_cache_transformer.PluginsCacheFile
        </transformer>
      </transformers>
    </configuration>
  </execution>
</executions>
<dependencies>
  <dependency>
    <groupId>com.github.edwgiz</groupId>
    <artifactId>maven-shade-plugin.log4j2-cachefile-transformer</artifactId>
    <version>2.13.0</version>
  </dependency>
</dependencies>
</plugin>
```

Uploading a deployment package with the Lambda console

To create a new function, you must first create the function in the console, then upload your .zip or JAR file. To update an existing function, open the page for your function, then follow the same procedure to add your updated .zip or JAR file.

If your deployment package file is less than 50MB, you can create or update a function by uploading the file directly from your local machine. For .zip or JAR files greater than 50MB, you must upload your package to an Amazon S3 bucket first. For instructions on how to upload a file to an Amazon S3 bucket using the AWS Management Console, see [Getting started with Amazon S3](#). To upload files using the AWS CLI, see [Move objects](#) in the *AWS CLI User Guide*.

Note

You cannot change the [deployment package type](#) (.zip or container image) for an existing function. For example, you cannot convert a container image function to use a .zip file archive. You must create a new function.

To create a new function (console)

1. Open the [Functions page](#) of the Lambda console and choose **Create Function**.
2. Choose **Author from scratch**.
3. Under **Basic information**, do the following:
 - a. For **Function name**, enter the name for your function.
 - b. For **Runtime**, select the runtime you want to use.
 - c. (Optional) For **Architecture**, choose the instruction set architecture for your function. The default architecture is x86_64. Ensure that the .zip deployment package for your function is compatible with the instruction set architecture you select.
4. (Optional) Under **Permissions**, expand **Change default execution role**. You can create a new **Execution role** or use an existing one.
5. Choose **Create function**. Lambda creates a basic 'Hello world' function using your chosen runtime.

To upload a .zip or JAR archive from your local machine (console)

1. In the [Functions page](#) of the Lambda console, choose the function you want to upload the .zip or JAR file for.
2. Select the **Code** tab.
3. In the **Code source** pane, choose **Upload from**.
4. Choose **.zip or .jar file**.
5. To upload the .zip or JAR file, do the following:
 - a. Select **Upload**, then select your .zip or JAR file in the file chooser.
 - b. Choose **Open**.
 - c. Choose **Save**.

To upload a .zip or JAR archive from an Amazon S3 bucket (console)

1. In the [Functions page](#) of the Lambda console, choose the function you want to upload a new .zip or JAR file for.
2. Select the **Code** tab.
3. In the **Code source** pane, choose **Upload from**.
4. Choose **Amazon S3 location**.
5. Paste the Amazon S3 link URL of your .zip file and choose **Save**.

Uploading a deployment package with the AWS CLI

You can use the [AWS CLI](#) to create a new function or to update an existing one using a .zip or JAR file. Use the [create-function](#) and [update-function-code](#) commands to deploy your .zip or JAR package. If your file is smaller than 50MB, you can upload the package from a file location on your local build machine. For larger files, you must upload your .zip or JAR package from an Amazon S3 bucket. For instructions on how to upload a file to an Amazon S3 bucket using the AWS CLI, see [Move objects](#) in the *AWS CLI User Guide*.

Note

If you upload your .zip or JAR file from an Amazon S3 bucket using the AWS CLI, the bucket must be located in the same AWS Region as your function.

To create a new function using a .zip or JAR file with the AWS CLI, you must specify the following:

- The name of your function (`--function-name`)
- Your function's runtime (`--runtime`)
- The Amazon Resource Name (ARN) of your function's [execution role](#) (`--role`)
- The name of the handler method in your function code (`--handler`)

You must also specify the location of your .zip or JAR file. If your .zip or JAR file is located in a folder on your local build machine, use the `--zip-file` option to specify the file path, as shown in the following example command.

```
aws lambda create-function --function-name myFunction \  
--runtime java21 --handler example.handler \  
--zip-file s3://my-bucket/my-file.zip
```

```
--role arn:aws:iam::123456789012:role/service-role/my-lambda-role \  
--zip-file fileb://myFunction.zip
```

To specify the location of .zip file in an Amazon S3 bucket, use the `--code` option as shown in the following example command. You only need to use the `S3ObjectVersion` parameter for versioned objects.

```
aws lambda create-function --function-name myFunction \  
--runtime java21 --handler example.handler \  
--role arn:aws:iam::123456789012:role/service-role/my-lambda-role \  
--code S3Bucket=amzn-s3-demo-  
bucket,S3Key=myFileName.zip,S3ObjectVersion=myObjectVersion
```

To update an existing function using the CLI, you specify the the name of your function using the `--function-name` parameter. You must also specify the location of the .zip file you want to use to update your function code. If your .zip file is located in a folder on your local build machine, use the `--zip-file` option to specify the file path, as shown in the following example command.

```
aws lambda update-function-code --function-name myFunction \  
--zip-file fileb://myFunction.zip
```

To specify the location of .zip file in an Amazon S3 bucket, use the `--s3-bucket` and `--s3-key` options as shown in the following example command. You only need to use the `--s3-object-version` parameter for versioned objects.

```
aws lambda update-function-code --function-name myFunction \  
--s3-bucket amzn-s3-demo-bucket --s3-key myFileName.zip --s3-object-version myObject  
Version
```

Uploading a deployment package with AWS SAM

You can use AWS SAM to automate deployments of your function code, configuration, and dependencies. AWS SAM is an extension of AWS CloudFormation that provides a simplified syntax for defining serverless applications. The following example template defines a function with a deployment package in the `build/distributions` directory that Gradle uses:

Example template.yml

```
AWSTemplateFormatVersion: '2010-09-09'  
Transform: 'AWS::Serverless-2016-10-31'
```

Description: An AWS Lambda application that calls the Lambda API.

Resources:

function:

Type: [AWS::Serverless::Function](#)

Properties:

CodeUri: `build/distributions/java-basic.zip`

Handler: `example.Handler`

Runtime: `java21`

Description: `Java function`

MemorySize: `512`

Timeout: `10`

Function's execution role

Policies:

- `AWSLambdaBasicExecutionRole`
- `AWSLambda_ReadOnlyAccess`
- `AWSXrayWriteOnlyAccess`
- `AWSLambdaVPCLAccessExecutionRole`

Tracing: `Active`

To create the function, use the `package` and `deploy` commands. These commands are customizations to the AWS CLI. They wrap other commands to upload the deployment package to Amazon S3, rewrite the template with the object URI, and update the function's code.

The following example script runs a Gradle build and uploads the deployment package that it creates. It creates an AWS CloudFormation stack the first time you run it. If the stack already exists, the script updates it.

Example `deploy.sh`

```
#!/bin/bash
set -eo pipefail
aws cloudformation package --template-file template.yml --s3-bucket MY_BUCKET --output-template-file out.yml
aws cloudformation deploy --template-file out.yml --stack-name java-basic --capabilities CAPABILITY_NAMED_IAM
```

For a complete working example, see the following sample applications:

Sample Lambda applications in Java

- [java17-examples](#) – A Java function that demonstrates how to use a Java record to represent an input event data object.

- [java-basic](#) – A collection of minimal Java functions with unit tests and variable logging configuration.
- [java-events](#) – A collection of Java functions that contain skeleton code for how to handle events from various services such as Amazon API Gateway, Amazon SQS, and Amazon Kinesis. These functions use the latest version of the [aws-lambda-java-events](#) library (3.0.0 and newer). These examples do not require the AWS SDK as a dependency.
- [s3-java](#) – A Java function that processes notification events from Amazon S3 and uses the Java Class Library (JCL) to create thumbnails from uploaded image files.
- [custom-serialization](#) – Examples of how to implement [custom serialization](#) using popular libraries such as fastJson, Gson, Moshi, and jackson-jr.
- [Use API Gateway to invoke a Lambda function](#) – A Java function that scans a Amazon DynamoDB table that contains employee information. It then uses Amazon Simple Notification Service to send a text message to employees celebrating their work anniversaries. This example uses API Gateway to invoke the function.

Deploy Java Lambda functions with container images

There are three ways to build a container image for a Java Lambda function:

- [Using an AWS base image for Java](#)

The [AWS base images](#) are preloaded with a language runtime, a runtime interface client to manage the interaction between Lambda and your function code, and a runtime interface emulator for local testing.

- [Using an AWS OS-only base image](#)

[AWS OS-only base images](#) contain an Amazon Linux distribution and the [runtime interface emulator](#). These images are commonly used to create container images for compiled languages, such as [Go](#) and [Rust](#), and for a language or language version that Lambda doesn't provide a base image for, such as Node.js 19. You can also use OS-only base images to implement a [custom runtime](#). To make the image compatible with Lambda, you must include the [runtime interface client for Java](#) in the image.

- [Using a non-AWS base image](#)

You can use an alternative base image from another container registry, such as Alpine Linux or Debian. You can also use a custom image created by your organization. To make the image compatible with Lambda, you must include the [runtime interface client for Java](#) in the image.

Tip

To reduce the time it takes for Lambda container functions to become active, see [Use multi-stage builds](#) in the Docker documentation. To build efficient container images, follow the [Best practices for writing Dockerfiles](#).

This page explains how to build, test, and deploy container images for Lambda.

Topics

- [AWS base images for Java](#)
- [Using an AWS base image for Java](#)
- [Using an alternative base image with the runtime interface client](#)

AWS base images for Java

AWS provides the following base images for Java:

Tags	Runtime	Operating system	Dockerfile	Deprecation
21	Java 21	Amazon Linux 2023	Dockerfile for Java 21 on GitHub	Not scheduled
17	Java 17	Amazon Linux 2	Dockerfile for Java 17 on GitHub	Not scheduled
11	Java 11	Amazon Linux 2	Dockerfile for Java 11 on GitHub	Not scheduled
8.al2	Java 8	Amazon Linux 2	Dockerfile for Java 8 on GitHub	Not scheduled

Amazon ECR repository: gallery.ecr.aws/lambda/java

The Java 21 and later base images are based on the [Amazon Linux 2023 minimal container image](#). Earlier base images use Amazon Linux 2. AL2023 provides several advantages over Amazon Linux 2, including a smaller deployment footprint and updated versions of libraries such as `glibc`.

AL2023-based images use `microdnf` (symlinked as `dnf`) as the package manager instead of `yum`, which is the default package manager in Amazon Linux 2. `microdnf` is a standalone implementation of `dnf`. For a list of packages that are included in AL2023-based images, refer to the **Minimal Container** columns in [Comparing packages installed on Amazon Linux 2023 Container Images](#). For more information about the differences between AL2023 and Amazon Linux 2, see [Introducing the Amazon Linux 2023 runtime for AWS Lambda](#) on the AWS Compute Blog.

Note

To run AL2023-based images locally, including with AWS Serverless Application Model (AWS SAM), you must use Docker version 20.10.10 or later.

Using an AWS base image for Java

Prerequisites

To complete the steps in this section, you must have the following:

- Java (for example, [Amazon Corretto](#))
- [Docker](#) (minimum version 20.10.10 for Java 21 and later base images)
- [Apache Maven](#) or [Gradle](#)
- [AWS CLI version 2](#)

Creating an image from a base image

Maven

1. Run the following command to create a Maven project using the [archetype for Lambda](#). The following parameters are required:
 - **service** – The AWS service client to use in the Lambda function. For a list of available sources, see [aws-sdk-java-v2/services](#) on GitHub.
 - **region** – The AWS Region where you want to create the Lambda function.
 - **groupId** – The full package namespace of your application.
 - **artifactId** – Your project name. This becomes the name of the directory for your project.

In Linux and macOS, run this command:

```
mvn -B archetype:generate \  
  -DarchetypeGroupId=software.amazon.awssdk \  
  -DarchetypeArtifactId=archetype-lambda -Dservice=s3 -Dregion=US_WEST_2 \  
  -DgroupId=com.example.myapp \  
  -DartifactId=myapp
```

In PowerShell, run this command:

```
mvn -B archetype:generate \  
  "-DarchetypeGroupId=software.amazon.awssdk" \  
  "-DarchetypeArtifactId=archetype-lambda" "-Dservice=s3" "-Dregion=US_WEST_2"
```

```
"-DgroupId=com.example.myapp" `
"-DartifactId=myapp"
```

The Maven archetype for Lambda is preconfigured to compile with Java SE 8 and includes a dependency to the AWS SDK for Java. If you create your project with a different archetype or by using another method, you must [configure the Java compiler for Maven](#) and [declare the SDK as a dependency](#).

2. Open the `myapp/src/main/java/com/example/myapp` directory, and find the `App.java` file. This is the code for the Lambda function. You can use the provided sample code for testing, or replace it with your own.
3. Navigate back to the project's root directory, and then create a new Dockerfile with the following configuration:
 - Set the FROM property to the [URI of the base image](#).
 - Set the CMD argument to the Lambda function handler.

Note that the example Dockerfile does not include a [USER instruction](#). When you deploy a container image to Lambda, Lambda automatically defines a default Linux user with least-privileged permissions. This is different from standard Docker behavior which defaults to the root user when no USER instruction is provided.

Example Dockerfile

```
FROM public.ecr.aws/lambda/java:21

# Copy function code and runtime dependencies from Maven layout
COPY target/classes ${LAMBDA_TASK_ROOT}
COPY target/dependency/* ${LAMBDA_TASK_ROOT}/lib/

# Set the CMD to your handler (could also be done as a parameter override
  outside of the Dockerfile)
CMD [ "com.example.myapp.App::handleRequest" ]
```

4. Compile the project and collect the runtime dependencies.

```
mvn compile dependency:copy-dependencies -DincludeScope=runtime
```

5. Build the Docker image with the [docker build](#) command. The following example names the image `docker-image` and gives it the test [tag](#).

```
docker build --platform linux/amd64 -t docker-image:test .
```

Note

The command specifies the `--platform linux/amd64` option to ensure that your container is compatible with the Lambda execution environment regardless of the architecture of your build machine. If you intend to create a Lambda function using the ARM64 instruction set architecture, be sure to change the command to use the `--platform linux/arm64` option instead.

Gradle

1. Create a directory for the project, and then switch to that directory.

```
mkdir example  
cd example
```

2. Run the following command to have Gradle generate a new Java application project in the example directory in your environment. For **Select build script DSL**, choose **2: Groovy**.

```
gradle init --type java-application
```

3. Open the `/example/app/src/main/java/example` directory, and find the `App.java` file. This is the code for the Lambda function. You can use the following sample code for testing, or replace it with your own.

Example App.java

```
package com.example;  
import com.amazonaws.services.lambda.runtime.Context;  
import com.amazonaws.services.lambda.runtime.RequestHandler;  
public class App implements RequestHandler<Object, String> {  
    public String handleRequest(Object input, Context context) {  
        return "Hello world!";  
    }  
}
```

4. Open the `build.gradle` file. If you're using the sample function code from the previous step, replace the contents of `build.gradle` with the following. If you're using your own function code, modify your `build.gradle` file as needed.

Example `build.gradle` (Groovy DSL)

```
plugins {
    id 'java'
}
group 'com.example'
version '1.0-SNAPSHOT'
sourceCompatibility = 1.8
repositories {
    mavenCentral()
}
dependencies {
    implementation 'com.amazonaws:aws-lambda-java-core:1.2.1'
}
jar {
    manifest {
        attributes 'Main-Class': 'com.example.App'
    }
}
```

5. The `gradle init` command from step 2 also generated a dummy test case in the `app/test` directory. For the purposes of this tutorial, skip running tests by deleting the `/test` directory.
6. Build the project.

```
gradle build
```

7. In the project's root directory (`/example`), create a `Dockerfile` with the following configuration:
 - Set the `FROM` property to the [URI of the base image](#).
 - Use the `COPY` command to copy the function code and runtime dependencies to `{LAMBDA_TASK_ROOT}`, a [Lambda-defined environment variable](#).
 - Set the `CMD` argument to the Lambda function handler.

Note that the example Dockerfile does not include a [USER instruction](#). When you deploy a container image to Lambda, Lambda automatically defines a default Linux user with least-privileged permissions. This is different from standard Docker behavior which defaults to the root user when no USER instruction is provided.

Example Dockerfile

```
FROM public.ecr.aws/lambda/java:21

# Copy function code and runtime dependencies from Gradle layout
COPY app/build/classes/java/main ${LAMBDA_TASK_ROOT}

# Set the CMD to your handler (could also be done as a parameter override
  outside of the Dockerfile)
CMD [ "com.example.App::handleRequest" ]
```

8. Build the Docker image with the [docker build](#) command. The following example names the image `docker-image` and gives it the test [tag](#).

```
docker build --platform linux/amd64 -t docker-image:test .
```

Note

The command specifies the `--platform linux/amd64` option to ensure that your container is compatible with the Lambda execution environment regardless of the architecture of your build machine. If you intend to create a Lambda function using the ARM64 instruction set architecture, be sure to change the command to use the `--platform linux/arm64` option instead.

(Optional) Test the image locally

1. Start the Docker image with the **docker run** command. In this example, `docker-image` is the image name and `test` is the tag.

```
docker run --platform linux/amd64 -p 9000:8080 docker-image:test
```

This command runs the image as a container and creates a local endpoint at `localhost:9000/2015-03-31/functions/function/invocations`.

Note

If you built the Docker image for the ARM64 instruction set architecture, be sure to use the `--platform linux/arm64` option instead of `--platform linux/amd64`.

2. From a new terminal window, post an event to the local endpoint.

Linux/macOS

In Linux and macOS, run the following `curl` command:

```
curl "http://localhost:9000/2015-03-31/functions/function/invocations" -d '{}'
```

This command invokes the function with an empty event and returns a response. If you're using your own function code rather than the sample function code, you might want to invoke the function with a JSON payload. Example:

```
curl "http://localhost:9000/2015-03-31/functions/function/invocations" -d '{"payload": "hello world!"}'
```

PowerShell

In PowerShell, run the following `Invoke-WebRequest` command:

```
Invoke-WebRequest -Uri "http://localhost:9000/2015-03-31/functions/function/invocations" -Method Post -Body '{}' -ContentType "application/json"
```

This command invokes the function with an empty event and returns a response. If you're using your own function code rather than the sample function code, you might want to invoke the function with a JSON payload. Example:

```
Invoke-WebRequest -Uri "http://localhost:9000/2015-03-31/functions/function/invocations" -Method Post -Body '{"payload": "hello world!"}' -ContentType "application/json"
```

3. Get the container ID.

```
docker ps
```

4. Use the [docker kill](#) command to stop the container. In this command, replace 3766c4ab331c with the container ID from the previous step.

```
docker kill 3766c4ab331c
```

Deploying the image

To upload the image to Amazon ECR and create the Lambda function

1. Run the [get-login-password](#) command to authenticate the Docker CLI to your Amazon ECR registry.
 - Set the `--region` value to the AWS Region where you want to create the Amazon ECR repository.
 - Replace 111122223333 with your AWS account ID.

```
aws ecr get-login-password --region us-east-1 | docker login --username AWS --password-stdin 111122223333.dkr.ecr.us-east-1.amazonaws.com
```

2. Create a repository in Amazon ECR using the [create-repository](#) command.

```
aws ecr create-repository --repository-name hello-world --region us-east-1 --image-scanning-configuration scanOnPush=true --image-tag-mutability MUTABLE
```

Note

The Amazon ECR repository must be in the same AWS Region as the Lambda function.

If successful, you see a response like this:

```
{
  "repository": {
    "repositoryArn": "arn:aws:ecr:us-east-1:111122223333:repository/hello-world",
```

```
    "registryId": "111122223333",
    "repositoryName": "hello-world",
    "repositoryUri": "111122223333.dkr.ecr.us-east-1.amazonaws.com/hello-
world",
    "createdAt": "2023-03-09T10:39:01+00:00",
    "imageTagMutability": "MUTABLE",
    "imageScanningConfiguration": {
      "scanOnPush": true
    },
    "encryptionConfiguration": {
      "encryptionType": "AES256"
    }
  }
}
```

3. Copy the `repositoryUri` from the output in the previous step.
4. Run the [docker tag](#) command to tag your local image into your Amazon ECR repository as the latest version. In this command:
 - `docker-image:test` is the name and [tag](#) of your Docker image. This is the image name and tag that you specified in the `docker build` command.
 - Replace `<ECRrepositoryUri>` with the `repositoryUri` that you copied. Make sure to include `:latest` at the end of the URI.

```
docker tag docker-image:test <ECRrepositoryUri>:latest
```

Example:

```
docker tag docker-image:test 111122223333.dkr.ecr.us-east-1.amazonaws.com/hello-
world:latest
```

5. Run the [docker push](#) command to deploy your local image to the Amazon ECR repository. Make sure to include `:latest` at the end of the repository URI.

```
docker push 111122223333.dkr.ecr.us-east-1.amazonaws.com/hello-world:latest
```

6. [Create an execution role](#) for the function, if you don't already have one. You need the Amazon Resource Name (ARN) of the role in the next step.

7. Create the Lambda function. For `ImageUri`, specify the repository URI from earlier. Make sure to include `:latest` at the end of the URI.

```
aws lambda create-function \
  --function-name hello-world \
  --package-type Image \
  --code ImageUri=111122223333.dkr.ecr.us-east-1.amazonaws.com/hello-world:latest \
  --role arn:aws:iam::111122223333:role/lambda-ex
```

Note

You can create a function using an image in a different AWS account, as long as the image is in the same Region as the Lambda function. For more information, see [Amazon ECR cross-account permissions](#).

8. Invoke the function.

```
aws lambda invoke --function-name hello-world response.json
```

You should see a response like this:

```
{
  "ExecutedVersion": "$LATEST",
  "StatusCode": 200
}
```

9. To see the output of the function, check the `response.json` file.

To update the function code, you must build the image again, upload the new image to the Amazon ECR repository, and then use the [update-function-code](#) command to deploy the image to the Lambda function.

Lambda resolves the image tag to a specific image digest. This means that if you point the image tag that was used to deploy the function to a new image in Amazon ECR, Lambda doesn't automatically update the function to use the new image.

To deploy the new image to the same Lambda function, you must use the [update-function-code](#) command, even if the image tag in Amazon ECR remains the same. In the following example, the `--publish` option creates a new version of the function using the updated container image.

```
aws lambda update-function-code \  
  --function-name hello-world \  
  --image-uri 111122223333.dkr.ecr.us-east-1.amazonaws.com/hello-world:latest \  
  --publish
```

Using an alternative base image with the runtime interface client

If you use an [OS-only base image](#) or an alternative base image, you must include the runtime interface client in your image. The runtime interface client extends the [Using the Lambda runtime API for custom runtimes](#), which manages the interaction between Lambda and your function code.

Install the runtime interface client for Java in your Dockerfile, or as a dependency in your project. For example, to install the runtime interface client using the Maven package manager, add the following to your `pom.xml` file:

```
<dependency>  
  <groupId>com.amazonaws</groupId>  
  <artifactId>aws-lambda-java-runtime-interface-client</artifactId>  
  <version>2.3.2</version>  
</dependency>
```

For package details, see [AWS Lambda Java Runtime Interface Client](#) in the Maven Central Repository. You can also review the runtime interface client source code in the [AWS Lambda Java Support Libraries](#) GitHub repository.

The following example demonstrates how to build a container image for Java using an [Amazon Corretto image](#). Amazon Corretto is a no-cost, multiplatform, production-ready distribution of the Open Java Development Kit (OpenJDK). The Maven project includes the runtime interface client as a dependency.

Prerequisites

To complete the steps in this section, you must have the following:

- Java (for example, [Amazon Corretto](#))
- [Docker](#)
- [Apache Maven](#)
- [AWS CLI version 2](#)

Creating an image from an alternative base image

1. Create a Maven project. The following parameters are required:

- **groupId** – The full package namespace of your application.
- **artifactId** – Your project name. This becomes the name of the directory for your project.

Linux/macOS

```
mvn -B archetype:generate \  
  -DarchetypeArtifactId=maven-archetype-quickstart \  
  -DgroupId=example \  
  -DartifactId=myapp \  
  -DinteractiveMode=false
```

PowerShell

```
mvn -B archetype:generate `\  
  -DarchetypeArtifactId=maven-archetype-quickstart `\  
  -DgroupId=example `\  
  -DartifactId=myapp `\  
  -DinteractiveMode=false
```

2. Open the project directory.

```
cd myapp
```

3. Open the `pom.xml` file and replace the contents with the following. This file includes the [aws-lambda-java-runtime-interface-client](#) as a dependency. Alternatively, you can install the runtime interface client in the Dockerfile. However, the simplest approach is to include the library as a dependency.

```
<project xmlns="http://maven.apache.org/POM/4.0.0" xmlns:xsi="http://  
www.w3.org/2001/XMLSchema-instance"  
  xsi:schemaLocation="http://maven.apache.org/POM/4.0.0 http://maven.apache.org/  
maven-v4_0_0.xsd">  
  <modelVersion>4.0.0</modelVersion>  
  <groupId>example</groupId>  
  <artifactId>hello-lambda</artifactId>  
  <packaging>jar</packaging>  
  <version>1.0-SNAPSHOT</version>
```

```
<name>hello-lambda</name>
<url>http://maven.apache.org</url>
<properties>
  <maven.compiler.source>1.8</maven.compiler.source>
  <maven.compiler.target>1.8</maven.compiler.target>
</properties>
<dependencies>
  <dependency>
    <groupId>com.amazonaws</groupId>
    <artifactId>aws-lambda-java-runtime-interface-client</artifactId>
    <version>2.3.2</version>
  </dependency>
</dependencies>
<build>
  <plugins>
    <plugin>
      <groupId>org.apache.maven.plugins</groupId>
      <artifactId>maven-dependency-plugin</artifactId>
      <version>3.1.2</version>
      <executions>
        <execution>
          <id>copy-dependencies</id>
          <phase>package</phase>
          <goals>
            <goal>copy-dependencies</goal>
          </goals>
        </execution>
      </executions>
    </plugin>
  </plugins>
</build>
</project>
```

4. Open the `myapp/src/main/java/com/example/myapp` directory, and find the `App.java` file. This is the code for the Lambda function. Replace the code with the following.

Example function handler

```
package example;

public class App {
    public static String sayHello() {
        return "Hello world!";
    }
}
```



```
}  
}
```

5. The `mvn -B archetype:generate` command from step 1 also generated a dummy test case in the `src/test` directory. For the purposes of this tutorial, skip over running tests by deleting this entire generated `/test` directory.
6. Navigate back to the project's root directory, and then create a new Dockerfile. The following example Dockerfile uses an [Amazon Corretto image](#). Amazon Corretto is a no-cost, multiplatform, production-ready distribution of the OpenJDK.
 - Set the `FROM` property to the URI of the base image.
 - Set the `ENTRYPOINT` to the module that you want the Docker container to run when it starts. In this case, the module is the runtime interface client.
 - Set the `CMD` argument to the Lambda function handler.

Note that the example Dockerfile does not include a [USER instruction](#). When you deploy a container image to Lambda, Lambda automatically defines a default Linux user with least-privileged permissions. This is different from standard Docker behavior which defaults to the root user when no `USER` instruction is provided.

Example Dockerfile

```
FROM public.ecr.aws/amazoncorretto/amazoncorretto:21 as base  
  
# Configure the build environment  
FROM base as build  
RUN yum install -y maven  
WORKDIR /src  
  
# Cache and copy dependencies  
ADD pom.xml .  
RUN mvn dependency:go-offline dependency:copy-dependencies  
  
# Compile the function  
ADD . .  
RUN mvn package  
  
# Copy the function artifact and dependencies onto a clean base  
FROM base  
WORKDIR /function
```

```

COPY --from=build /src/target/dependency/*.jar ./
COPY --from=build /src/target/*.jar ./

# Set runtime interface client as default command for the container runtime
ENTRYPOINT [ "/usr/bin/java", "-cp", "./*",
             "com.amazonaws.services.lambda.runtime.api.client.AWSLambda" ]
# Pass the name of the function handler as an argument to the runtime
CMD [ "example.App::sayHello" ]

```

7. Build the Docker image with the [docker build](#) command. The following example names the image `docker-image` and gives it the test [tag](#).

```
docker build --platform linux/amd64 -t docker-image:test .
```

Note

The command specifies the `--platform linux/amd64` option to ensure that your container is compatible with the Lambda execution environment regardless of the architecture of your build machine. If you intend to create a Lambda function using the ARM64 instruction set architecture, be sure to change the command to use the `--platform linux/arm64` option instead.

(Optional) Test the image locally

Use the [runtime interface emulator](#) to locally test the image. You can [build the emulator into your image](#) or use the following procedure to install it on your local machine.

To install and run the runtime interface emulator on your local machine

1. From your project directory, run the following command to download the runtime interface emulator (x86-64 architecture) from GitHub and install it on your local machine.

Linux/macOS

```

mkdir -p ~/.aws-lambda-rie && \
  curl -Lo ~/.aws-lambda-rie/aws-lambda-rie https://github.com/aws/aws-lambda-
runtime-interface-emulator/releases/latest/download/aws-lambda-rie && \
  chmod +x ~/.aws-lambda-rie/aws-lambda-rie

```

To install the arm64 emulator, replace the GitHub repository URL in the previous command with the following:

```
https://github.com/aws/aws-lambda-runtime-interface-emulator/releases/latest/download/aws-lambda-rie-arm64
```

PowerShell

```
$dirPath = "$HOME\.aws-lambda-rie"
if (-not (Test-Path $dirPath)) {
    New-Item -Path $dirPath -ItemType Directory
}

$downloadLink = "https://github.com/aws/aws-lambda-runtime-interface-emulator/releases/latest/download/aws-lambda-rie"
$destinationPath = "$HOME\.aws-lambda-rie\aws-lambda-rie"
Invoke-WebRequest -Uri $downloadLink -OutFile $destinationPath
```

To install the arm64 emulator, replace the `$downloadLink` with the following:

```
https://github.com/aws/aws-lambda-runtime-interface-emulator/releases/latest/download/aws-lambda-rie-arm64
```

2. Start the Docker image with the **docker run** command. Note the following:

- `docker-image` is the image name and `test` is the tag.
- `/usr/bin/java -cp './*' com.amazonaws.services.lambda.runtime.api.client.AWSLambda example.App::sayHello` is the ENTRYPOINT followed by the CMD from your Dockerfile.

Linux/macOS

```
docker run --platform linux/amd64 -d -v ~/.aws-lambda-rie:/aws-lambda -p
9000:8080 \
    --entrypoint /aws-lambda/aws-lambda-rie \
    docker-image:test \
    /usr/bin/java -cp './*'
com.amazonaws.services.lambda.runtime.api.client.AWSLambda
example.App::sayHello
```

PowerShell

```
docker run --platform linux/amd64 -d -v "$HOME\.aws-lambda-rie:/aws-lambda" -p
9000:8080 `
--entrypoint /aws-lambda/aws-lambda-rie `
docker-image:test `
  /usr/bin/java -cp './*'
  com.amazonaws.services.lambda.runtime.api.client.AWSLambda
  example.App::sayHello
```

This command runs the image as a container and creates a local endpoint at `localhost:9000/2015-03-31/functions/function/invocations`.

Note

If you built the Docker image for the ARM64 instruction set architecture, be sure to use the `--platform linux/arm64` option instead of `--platform linux/amd64`.

3. Post an event to the local endpoint.

Linux/macOS

In Linux and macOS, run the following `curl` command:

```
curl "http://localhost:9000/2015-03-31/functions/function/invocations" -d '{}'
```

This command invokes the function with an empty event and returns a response. If you're using your own function code rather than the sample function code, you might want to invoke the function with a JSON payload. Example:

```
curl "http://localhost:9000/2015-03-31/functions/function/invocations" -d
'{"payload":"hello world!"}'
```

PowerShell

In PowerShell, run the following `Invoke-WebRequest` command:

```
Invoke-WebRequest -Uri "http://localhost:9000/2015-03-31/functions/function/invocations" -Method Post -Body '{}' -ContentType "application/json"
```

This command invokes the function with an empty event and returns a response. If you're using your own function code rather than the sample function code, you might want to invoke the function with a JSON payload. Example:

```
Invoke-WebRequest -Uri "http://localhost:9000/2015-03-31/functions/function/invocations" -Method Post -Body '{"payload":"hello world!"}' -ContentType "application/json"
```

4. Get the container ID.

```
docker ps
```

5. Use the [docker kill](#) command to stop the container. In this command, replace 3766c4ab331c with the container ID from the previous step.

```
docker kill 3766c4ab331c
```

Deploying the image

To upload the image to Amazon ECR and create the Lambda function

1. Run the [get-login-password](#) command to authenticate the Docker CLI to your Amazon ECR registry.
 - Set the `--region` value to the AWS Region where you want to create the Amazon ECR repository.
 - Replace 111122223333 with your AWS account ID.

```
aws ecr get-login-password --region us-east-1 | docker login --username AWS --password-stdin 111122223333.dkr.ecr.us-east-1.amazonaws.com
```

2. Create a repository in Amazon ECR using the [create-repository](#) command.

```
aws ecr create-repository --repository-name hello-world --region us-east-1 --image-scanning-configuration scanOnPush=true --image-tag-mutability MUTABLE
```

Note

The Amazon ECR repository must be in the same AWS Region as the Lambda function.

If successful, you see a response like this:

```
{
  "repository": {
    "repositoryArn": "arn:aws:ecr:us-east-1:111122223333:repository/hello-world",
    "registryId": "111122223333",
    "repositoryName": "hello-world",
    "repositoryUri": "111122223333.dkr.ecr.us-east-1.amazonaws.com/hello-world",
    "createdAt": "2023-03-09T10:39:01+00:00",
    "imageTagMutability": "MUTABLE",
    "imageScanningConfiguration": {
      "scanOnPush": true
    },
    "encryptionConfiguration": {
      "encryptionType": "AES256"
    }
  }
}
```

3. Copy the `repositoryUri` from the output in the previous step.
4. Run the [docker tag](#) command to tag your local image into your Amazon ECR repository as the latest version. In this command:
 - `docker-image:test` is the name and [tag](#) of your Docker image. This is the image name and tag that you specified in the `docker build` command.
 - Replace `<ECRrepositoryUri>` with the `repositoryUri` that you copied. Make sure to include `:latest` at the end of the URI.

```
docker tag docker-image:test <ECRrepositoryUri>:latest
```

Example:

```
docker tag docker-image:test 111122223333.dkr.ecr.us-east-1.amazonaws.com/hello-world:latest
```

5. Run the [docker push](#) command to deploy your local image to the Amazon ECR repository. Make sure to include `:latest` at the end of the repository URI.

```
docker push 111122223333.dkr.ecr.us-east-1.amazonaws.com/hello-world:latest
```

6. [Create an execution role](#) for the function, if you don't already have one. You need the Amazon Resource Name (ARN) of the role in the next step.
7. Create the Lambda function. For `ImageUri`, specify the repository URI from earlier. Make sure to include `:latest` at the end of the URI.

```
aws lambda create-function \  
  --function-name hello-world \  
  --package-type Image \  
  --code ImageUri=111122223333.dkr.ecr.us-east-1.amazonaws.com/hello-world:latest \  
  --role arn:aws:iam::111122223333:role/lambda-ex
```

Note

You can create a function using an image in a different AWS account, as long as the image is in the same Region as the Lambda function. For more information, see [Amazon ECR cross-account permissions](#).

8. Invoke the function.

```
aws lambda invoke --function-name hello-world response.json
```

You should see a response like this:

```
{  
  "ExecutedVersion": "$LATEST",
```

```
"statusCode": 200
}
```

9. To see the output of the function, check the `response.json` file.

To update the function code, you must build the image again, upload the new image to the Amazon ECR repository, and then use the [update-function-code](#) command to deploy the image to the Lambda function.

Lambda resolves the image tag to a specific image digest. This means that if you point the image tag that was used to deploy the function to a new image in Amazon ECR, Lambda doesn't automatically update the function to use the new image.

To deploy the new image to the same Lambda function, you must use the [update-function-code](#) command, even if the image tag in Amazon ECR remains the same. In the following example, the `--publish` option creates a new version of the function using the updated container image.

```
aws lambda update-function-code \  
  --function-name hello-world \  
  --image-uri 111122223333.dkr.ecr.us-east-1.amazonaws.com/hello-world:latest \  
  --publish
```

Working with layers for Java Lambda functions

A [Lambda layer](#) is a .zip file archive that contains supplementary code or data. Layers usually contain library dependencies, a [custom runtime](#), or configuration files. Creating a layer involves three general steps:

1. Package your layer content. This means creating a .zip file archive that contains the dependencies you want to use in your functions.
2. Create the layer in Lambda.
3. Add the layer to your functions.

This topic contains steps and guidance on how to properly package and create a Java Lambda layer with external library dependencies.

Topics

- [Prerequisites](#)
- [Java layer compatibility with Amazon Linux](#)
- [Layer paths for Java runtimes](#)
- [Packaging the layer content](#)
- [Creating the layer](#)
- [Adding the layer to your function](#)

Prerequisites

To follow the steps in this section, you must have the following:

- [Java 21](#)
- [Apache Maven 3.8.6 or later](#)
- [AWS CLI version 2](#)

Note

Ensure that the Java version that Maven refers to is the same as the Java version of the function that you intend to deploy. For example, for a Java 21 function, the `mvn -v` command should list Java version 21 in the output:

```
Apache Maven 3.8.6
...
Java version: 21.0.2, vendor: Oracle Corporation, runtime: /Library/Java/
JavaVirtualMachines/jdk-21.jdk/Contents/Home
...
```

Throughout this topic, we reference the [layer-java](#) sample application on the **awsdocs** GitHub repository. This application contains scripts that download the dependencies and generate the layer. The application also contains a corresponding function that uses dependencies from the layer. After creating a layer, you can deploy and invoke the corresponding function to verify that everything works properly. Because you use the Java 21 runtime for the functions, the layers must also be compatible with Java 21.

The `layer-java` sample application contains a single example within two sub-directories. The `layer` directory contains a `pom.xml` file that defines the layer dependencies, as well as scripts to generate the layer. The `function` directory contains a sample function to help test that the layer works. This tutorial walks through how to create and package this layer.

Java layer compatibility with Amazon Linux

The first step to creating a layer is to bundle all of your layer content into a `.zip` file archive. Because Lambda functions run on [Amazon Linux](#), your layer content must be able to compile and build in a Linux environment.

Java code is designed to be platform-independent, so you can package your layers on your local machine even if it doesn't use a Linux environment. After you upload the Java layer to Lambda, it'll still be compatible with Amazon Linux.

Layer paths for Java runtimes

When you add a layer to a function, Lambda loads the layer content into the `/opt` directory of that execution environment. For each Lambda runtime, the `PATH` variable already includes specific folder paths within the `/opt` directory. To ensure that Lambda picks up your layer content, your layer `.zip` file should have its dependencies in the following folder paths:

- `java/lib`

For example, the resulting layer .zip file that you create in this tutorial has the following directory structure:

```
layer_content.zip
# java
  # lib
    # layer-java-layer-1.0-SNAPSHOT.jar
```

The `layer-java-layer-1.0-SNAPSHOT.jar` JAR file (an uber-jar that contains all of our required dependencies) is correctly located in the `java/lib` directory. This ensures that Lambda can locate the library during function invocations.

Packaging the layer content

In this example, you package the following two Java libraries into a single JAR file:

- [aws-lambda-java-core](#) – A minimal set of interface definitions for working with Java in AWS Lambda
- [Jackson](#) – A popular suite of data-processing tools, particularly for working with JSON.

Complete the following steps to install and package the layer content.

To install and package your layer content

1. Clone the [aws-lambda-developer-guide GitHub repo](#), which contains the sample code that you need in the `sample-apps/layer-java` directory.

```
git clone https://github.com/awsdocs/aws-lambda-developer-guide.git
```

2. Navigate to the `layer` directory of the `layer-java` sample app. This directory contains the scripts that you use to create and package the layer properly.

```
cd aws-lambda-developer-guide/sample-apps/layer-java/layer
```

3. Examine the [pom.xml](#) file. In the `<dependencies>` section, you define the dependencies that you want to include in the layer, namely the `aws-lambda-java-core` and `jackson-databind` libraries. You can update this file to include any dependencies that you want to include in your own layer.

Example pom.xml

```
<dependencies>
  <dependency>
    <groupId>com.amazonaws</groupId>
    <artifactId>aws-lambda-java-core</artifactId>
    <version>1.2.3</version>
  </dependency>

  <dependency>
    <groupId>com.fasterxml.jackson.core</groupId>
    <artifactId>jackson-databind</artifactId>
    <version>2.17.0</version>
  </dependency>
</dependencies>
```

Note

The `<build>` section of this `pom.xml` file contains two plugins. The [maven-compiler-plugin](#) compiles the source code. The [maven-shade-plugin](#) packages your artifacts into a single uber-jar.

4. Ensure that you have permissions to run both scripts.

```
chmod 744 1-install.sh && chmod 744 2-package.sh
```

5. Run the [1-install.sh](#) script using the following command:

```
./1-install.sh
```

This script runs `mvn clean install` in the current directory. This creates the uber-jar with all required dependencies in the `target/` directory.

Example 1-install.sh

```
mvn clean install
```

6. Run the [2-package.sh](#) script using the following command:

```
./2-package.sh
```

This script creates the `java/lib` directory structure that you need to properly package your layer content. It then copies the `uber-jar` from the `/target` directory into the newly created `java/lib` directory. Finally, the script zips the contents of the `java` directory into a file named `layer_content.zip`. This is the `.zip` file for your layer. You can unzip the file and verify that it contains the correct file structure, as shown in the [the section called “Layer paths for Java runtimes”](#) section.

Example 2-package.sh

```
mkdir java
mkdir java/lib
cp -r target/layer-java-layer-1.0-SNAPSHOT.jar java/lib/
zip -r layer_content.zip java
```

Creating the layer

In this section, you take the `layer_content.zip` file that you generated in the previous section and upload it as a Lambda layer. You can upload a layer using the AWS Management Console or the Lambda API via the AWS Command Line Interface (AWS CLI). When you upload your layer `.zip` file, in the following [PublishLayerVersion](#) AWS CLI command, specify `java21` as the compatible runtime and `arm64` as the compatible architecture.

```
aws lambda publish-layer-version --layer-name java-jackson-layer \
  --zip-file fileb://layer_content.zip \
  --compatible-runtimes java21 \
  --compatible-architectures "arm64"
```

From the response, note the `LayerVersionArn`, which looks like `arn:aws:lambda:us-east-1:123456789012:layer:java-jackson-layer:1`. You'll need this Amazon Resource Name (ARN) in the next step of this tutorial, when you add the layer to your function.

Adding the layer to your function

In this section, you deploy a sample Lambda function that uses the Jackson library in its function code, then you attach the layer. To deploy the function, you need a [the section called “Execution](#)

[role \(permissions for functions to access other resources\)](#)". If you don't have an existing execution role, follow the steps in the collapsible section.

(Optional) Create an execution role

To create an execution role

1. Open the [roles page](#) in the IAM console.
2. Choose **Create role**.
3. Create a role with the following properties.
 - **Trusted entity** – **Lambda**.
 - **Permissions** – **AWSLambdaBasicExecutionRole**.
 - **Role name** – **lambda-role**.

The **AWSLambdaBasicExecutionRole** policy has the permissions that the function needs to write logs to CloudWatch Logs.

The Lambda [function code](#) takes in a `Map<String, String>` as input, and uses Jackson to write the input as a JSON String before converting it into a pre-defined [F1Car](#) Java object. Finally, the function uses fields from the `F1Car` object to construct a String that the function returns.

```
package example;

import com.amazonaws.services.lambda.runtime.Context;
import com.fasterxml.jackson.databind.ObjectMapper;

import java.io.IOException;
import java.util.Map;

public class Handler {

    public String handleRequest(Map<String, String> input, Context context) throws
    IOException {
        // Parse the input JSON
        ObjectMapper objectMapper = new ObjectMapper();
        F1Car f1Car = objectMapper.readValue(objectMapper.writeValueAsString(input),
        F1Car.class);

        StringBuilder finalString = new StringBuilder();
```

```
        finalString.append(f1Car.getDriver());
        finalString.append(" is a driver for team ");
        finalString.append(f1Car.getTeam());
        return finalString.toString();
    }
}
```

To deploy the Lambda function

1. Navigate to the `function/` directory. If you're currently in the `layer/` directory, then run the following command:

```
cd ../function
```

2. Build the project using the following Maven command:

```
mvn package
```

This command produces a JAR file in the `target/` directory named `layer-java-function-1.0-SNAPSHOT.jar`.

3. Deploy the function. In the following AWS CLI command, replace the `--role` parameter with your execution role ARN:

```
aws lambda create-function --function-name java_function_with_layer \  
  --runtime java21 \  
  --architectures "arm64" \  
  --handler example.Handler::handleRequest \  
  --timeout 30 \  
  --role arn:aws:iam::123456789012:role/lambda-role \  
  --zip-file fileb://target/layer-java-function-1.0-SNAPSHOT.jar
```

4. Next, attach the layer to your function. In the following AWS CLI command, replace the `--layers` parameter with the layer version ARN that you noted earlier:

```
aws lambda update-function-configuration --function-name java_function_with_layer \  
  --cli-binary-format raw-in-base64-out \  
  --layers "arn:aws:lambda:us-east-1:123456789012:layer:java-jackson-layer:1"
```

5. Finally, try to invoke your function using the following AWS CLI command:

```
aws lambda invoke --function-name java_function_with_layer \  
  --cli-binary-format raw-in-base64-out \  
  --payload '{ "driver": "Max Verstappen", "team": "Red Bull" }' response.json
```

You should see output that looks like this:

```
{  
  "StatusCode": 200,  
  "ExecutedVersion": "$LATEST"  
}
```

This indicates that the function was able to use the Jackson dependency to properly execute the function. You can check that the output `response.json` file contains the correct returned String:

```
"Max Verstappen is a driver for team Red Bull"
```

(Optional) Clean up your resources

You can now delete the resources that you created for this tutorial, unless you want to retain them. By deleting AWS resources that you're no longer using, you prevent unnecessary charges to your AWS account.

To delete the Lambda layer

1. Open the [Layers page](#) of the Lambda console.
2. Select the layer that you created.
3. Choose **Delete**, then choose **Delete** again.

To delete the Lambda function

1. Open the [Functions page](#) of the Lambda console.
2. Select the function that you created.
3. Choose **Actions, Delete**.
4. Type **confirm** in the text input field and choose **Delete**.

Customize serialization for Lambda Java functions

The Lambda [Java managed runtimes](#) support custom serialization for JSON events. Custom serialization can simplify your code and potentially improve performance.

Topics

- [When to use custom serialization](#)
- [Implementing custom serialization](#)
- [Testing custom serialization](#)

When to use custom serialization

When your Lambda function is invoked, the input event data needs to be deserialized into a Java object, and the output from your function needs to be serialized back into a format that can be returned as the function's response. The Lambda Java managed runtimes provide default serialization and deserialization capabilities that work well for handling event payloads from various AWS services, such as Amazon API Gateway and Amazon Simple Queue Service (Amazon SQS). To work with these service integration events in your function, add the [aws-java-lambda-events](#) dependency to your project. This AWS library contains Java objects representing these service integration events.

You can also use your own objects to represent the event JSON that you pass to your Lambda function. The managed runtime attempts to serialize the JSON to a new instance of your object with its default behavior. If the default serializer doesn't have the desired behavior for your use case, use custom serialization.

For example, assume that your function handler expects a `Vehicle` class as input, with the following structure:

```
public class Vehicle {
    private String vehicleType;
    private long vehicleId;
}
```

However, the JSON event payload looks like this:

```
{
```

```
"vehicle-type": "car",  
"vehicleID": 123  
}
```

In this scenario, the default serialization in the managed runtime expects the JSON property names to match the camel case Java class property names (`vehicleType`, `vehicleId`). Because the property names in the JSON event aren't in camel case (`vehicle-type`, `vehicleID`), you must use custom serialization.

Implementing custom serialization

Use a [Service Provider Interface](#) to load a serializer of your choice instead of the managed runtime's default serialization logic. You can serialize your JSON event payloads directly into Java objects, using the standard `RequestHandler` interface.

To use custom serialization in your Lambda Java function

1. Add the [aws-lambda-java-core](#) library as a dependency. This library includes the [CustomPojoSerializer](#) interface, along with other interface definitions for working with Java in Lambda.
2. Create a file named `com.amazonaws.services.lambda.runtime.CustomPojoSerializer` in the `src/main/META-INF/services/` directory of your project.
3. In this file, specify the fully qualified name of your custom serializer implementation, which must implement the `CustomPojoSerializer` interface. Example:

```
com.mycompany.vehicles.CustomLambdaSerializer
```

4. Implement the `CustomPojoSerializer` interface to provide your custom serialization logic.
5. Use the standard `RequestHandler` interface in your Lambda function. The managed runtime will use your custom serializer.

For more examples of how to implement custom serialization using popular libraries such as `fastJson`, `Gson`, `Moshi`, and `jackson-jr`, see the [custom-serialization](#) sample in the AWS GitHub repository.

Testing custom serialization

Test your function to make sure that your serialization and deserialization logic is working as expected. You can use the AWS Serverless Application Model Command Line Interface (AWS SAM CLI) to emulate the invocation of your Lambda payload. This can help you quickly test and iterate on your function as you introduce a custom serializer.

1. Create a file with the JSON event payload that you would like to invoke your function with then call the AWS SAM CLI.
2. Run the [sam local invoke](#) command to invoke your function locally. Example:

```
sam local invoke -e src/test/resources/event.json
```

For more information, see [Locally invoke Lambda functions with AWS SAM](#).

Customize Java runtime startup behavior for Lambda functions

This page describes settings specific to Java functions in AWS Lambda. You can use these settings to customize Java runtime startup behavior. This can reduce overall function latency and improve overall function performance, without having to modify any code.

Sections

- [Understanding the JAVA_TOOL_OPTIONS environment variable](#)

Understanding the JAVA_TOOL_OPTIONS environment variable

In Java, Lambda supports the `JAVA_TOOL_OPTIONS` environment variable to set additional command-line variables in Lambda. You can use this environment variable in various ways, such as to customize tiered-compilation settings. The next example demonstrates how to use the `JAVA_TOOL_OPTIONS` environment variable for this use case.

Example: Customizing tiered compilation settings

Tiered compilation is a feature of the Java virtual machine (JVM). You can use specific tiered compilation settings to make best use of the JVM's just-in-time (JIT) compilers. Typically, the C1 compiler is optimized for fast start-up time. The C2 compiler is optimized for best overall performance, but it also uses more memory and takes a longer time to achieve it.

There are 5 different levels of tiered compilation. At Level 0, the JVM interprets Java byte code. At Level 4, the JVM uses the C2 compiler to analyze profiling data collected during application startup. Over time, it monitors code usage to identify the best optimizations.

Customizing the tiered compilation level can help you reduce Java function cold start latency. For example, set the tiered compilation level to 1 to have the JVM use the C1 compiler. This compiler quickly produces optimized native code but it doesn't generate any profiling data and never uses the C2 compiler.

In the Java 17 runtime, the JVM flag for tiered compilation is set to stop at level 1 by default. For the Java 11 runtime and below, you can set the tiered compilation level to 1 by doing the following steps:

To customize tiered compilation settings (console)

1. Open the [Functions page](#) in the Lambda console.

2. Choose a Java function that you want to customize tiered compilation for.
3. Choose the **Configuration** tab, then choose **Environment variables** in the left menu.
4. Choose **Edit**.
5. Choose **Add environment variable**.
6. For the key, enter `JAVA_TOOL_OPTIONS`. For the value, enter `-XX:+TieredCompilation -XX:TieredStopAtLevel=1`.

Edit environment variables

Environment variables

You can define environment variables as key-value pairs that are accessible from your function code. These are useful to store configuration settings without the need to change function code. [Learn more](#) 

Key	Value	
<input type="text" value="JAVA_TOOL_OPTIONS"/>	<input type="text" value="-XX:+TieredCompilation -XX:TieredStopAtLevel=1"/>	<input type="button" value="Remove"/>

► Encryption configuration

7. Choose **Save**.

Note

You can also use Lambda SnapStart to mitigate cold start issues. SnapStart uses cached snapshots of your execution environment to significantly improve start-up performance. For more information about SnapStart features, limitations, and supported regions, see [Improving startup performance with Lambda SnapStart](#).

Example: Customizing GC behavior using JAVA_TOOL_OPTIONS

Java 11 runtimes use the [Serial](#) garbage collector (GC) for garbage collection. By default, Java 17 runtimes also use the Serial GC. However, with Java 17 you can also use the `JAVA_TOOL_OPTIONS` environment variable to change the default GC. You can choose between the Parallel GC and [Shenandoah GC](#).

For example, if your workload uses more memory and multiple CPUs, consider using the Parallel GC for better performance. You can do this by appending the following to the value of your `JAVA_TOOL_OPTIONS` environment variable:

```
-XX:+UseParallelGC
```

Using the Lambda context object to retrieve Java function information

When Lambda runs your function, it passes a context object to the [handler](#). This object provides methods and properties that provide information about the invocation, function, and execution environment.

Context methods

- `getRemainingTimeInMillis()` – Returns the number of milliseconds left before the execution times out.
- `getFunctionName()` – Returns the name of the Lambda function.
- `getFunctionVersion()` – Returns the [version](#) of the function.
- `getInvokedFunctionArn()` – Returns the Amazon Resource Name (ARN) that's used to invoke the function. Indicates if the invoker specified a version number or alias.
- `getMemoryLimitInMB()` – Returns the amount of memory that's allocated for the function.
- `getAwsRequestId()` – Returns the identifier of the invocation request.
- `getLogGroupName()` – Returns the log group for the function.
- `getLogStreamName()` – Returns the log stream for the function instance.
- `getIdentity()` – (mobile apps) Returns information about the Amazon Cognito identity that authorized the request.
- `getClientContext()` – (mobile apps) Returns the client context that's provided to Lambda by the client application.
- `getLogger()` – Returns the [logger object](#) for the function.

The following example shows a function that uses the context object to access the Lambda logger.

Example [Handler.java](#)

```
package example;

import com.amazonaws.services.lambda.runtime.Context;
import com.amazonaws.services.lambda.runtime.LambdaLogger;
import com.amazonaws.services.lambda.runtime.RequestHandler;

import java.util.Map;
```



```
// Handler value: example.Handler
public class Handler implements RequestHandler<Map<String,String>, Void>{

    @Override
    public Void handleRequest(Map<String,String> event, Context context)
    {
        LambdaLogger logger = context.getLogger();
        logger.log("EVENT TYPE: " + event.getClass());
        return null;
    }
}
```

The function logs the class type of the incoming event before returning null.

Example log output

```
EVENT TYPE: class java.util.LinkedHashMap
```

The interface for the context object is available in the [aws-lambda-java-core](#) library. You can implement this interface to create a context class for testing. The following example shows a context class that returns dummy values for most properties and a working test logger.

Example [src/test/java/example/TestContext.java](#)

```
package example;

import com.amazonaws.services.lambda.runtime.Context;
import com.amazonaws.services.lambda.runtime.CognitoIdentity;
import com.amazonaws.services.lambda.runtime.ClientContext;
import com.amazonaws.services.lambda.runtime.LambdaLogger;

public class TestContext implements Context{

    public TestContext() {}
    public String getAwsRequestId(){
        return new String("495b12a8-xmpl-4eca-8168-160484189f99");
    }
    public String getLogGroupName(){
        return new String("/aws/lambda/my-function");
    }
    public String getLogStreamName(){
        return new String("2020/02/26/[$LATEST]704f8dxmpla04097b9134246b8438f1a");
    }
}
```

```
}
public String getFunctionName(){
    return new String("my-function");
}
public String getFunctionVersion(){
    return new String("$LATEST");
}
public String getInvokedFunctionArn(){
    return new String("arn:aws:lambda:us-east-2:123456789012:function:my-function");
}
public CognitoIdentity getIdentity(){
    return null;
}
public ClientContext getClientContext(){
    return null;
}
public int getRemainingTimeInMillis(){
    return 300000;
}
public int getMemoryLimitInMB(){
    return 512;
}
public LambdaLogger getLogger(){
    return new TestLogger();
}
}
```

For more information on logging, see [Log and monitor Java Lambda functions](#).

Context in sample applications

The GitHub repository for this guide includes sample applications that demonstrate the use of the context object. Each sample application includes scripts for easy deployment and cleanup, an AWS Serverless Application Model (AWS SAM) template, and supporting resources.

Sample Lambda applications in Java

- [java17-examples](#) – A Java function that demonstrates how to use a Java record to represent an input event data object.
- [java-basic](#) – A collection of minimal Java functions with unit tests and variable logging configuration.

- [java-events](#) – A collection of Java functions that contain skeleton code for how to handle events from various services such as Amazon API Gateway, Amazon SQS, and Amazon Kinesis. These functions use the latest version of the [aws-lambda-java-events](#) library (3.0.0 and newer). These examples do not require the AWS SDK as a dependency.
- [s3-java](#) – A Java function that processes notification events from Amazon S3 and uses the Java Class Library (JCL) to create thumbnails from uploaded image files.
- [custom-serialization](#) – Examples of how to implement [custom serialization](#) using popular libraries such as fastJson, Gson, Moshi, and jackson-jr.
- [Use API Gateway to invoke a Lambda function](#) – A Java function that scans a Amazon DynamoDB table that contains employee information. It then uses Amazon Simple Notification Service to send a text message to employees celebrating their work anniversaries. This example uses API Gateway to invoke the function.

Log and monitor Java Lambda functions

AWS Lambda automatically monitors Lambda functions and sends log entries to Amazon CloudWatch. Your Lambda function comes with a CloudWatch Logs log group and a log stream for each instance of your function. The Lambda runtime environment sends details about each invocation and other output from your function's code to the log stream. For more information about CloudWatch Logs, see [Using CloudWatch Logs with Lambda](#).

To output logs from your function code, you can use methods on [java.lang.System](#), or any logging module that writes to stdout or stderr.

Sections

- [Creating a function that returns logs](#)
- [Using Lambda advanced logging controls with Java](#)
- [Implementing advanced logging with Log4j2 and SLF4J](#)
- [Using other logging tools and libraries](#)
- [Using Powertools for AWS Lambda \(Java\) and AWS SAM for structured logging](#)
- [Viewing logs in the Lambda console](#)
- [Viewing logs in the CloudWatch console](#)
- [Viewing logs using the AWS Command Line Interface \(AWS CLI\)](#)
- [Deleting logs](#)
- [Sample logging code](#)

Creating a function that returns logs

To output logs from your function code, you can use methods on [java.lang.System](#), or any logging module that writes to stdout or stderr. The [aws-lambda-java-core](#) library provides a logger class named `LambdaLogger` that you can access from the context object. The logger class supports multiline logs.

The following example uses the `LambdaLogger` logger provided by the context object.

Example Handler.java

```
// Handler value: example.Handler
public class Handler implements RequestHandler<Object, String>{
```

```
Gson gson = new GsonBuilder().setPrettyPrinting().create();
@Override
public String handleRequest(Object event, Context context)
{
    LambdaLogger logger = context.getLogger();
    String response = new String("SUCCESS");
    // log execution details
    logger.log("ENVIRONMENT VARIABLES: " + gson.toJson(System.getenv()));
    logger.log("CONTEXT: " + gson.toJson(context));
    // process event
    logger.log("EVENT: " + gson.toJson(event));
    return response;
}
}
```

Example log format

```
START RequestId: 6bc28136-xmpl-4365-b021-0ce6b2e64ab0 Version: $LATEST
ENVIRONMENT VARIABLES:
{
  "_HANDLER": "example.Handler",
  "AWS_EXECUTION_ENV": "AWS_Lambda_java8",
  "AWS_LAMBDA_FUNCTION_MEMORY_SIZE": "512",
  ...
}
CONTEXT:
{
  "memoryLimit": 512,
  "awsRequestId": "6bc28136-xmpl-4365-b021-0ce6b2e64ab0",
  "functionName": "java-console",
  ...
}
EVENT:
{
  "records": [
    {
      "messageId": "19dd0b57-xmpl-4ac1-bd88-01bbb068cb78",
      "receiptHandle": "MessageReceiptHandle",
      "body": "Hello from SQS!",
      ...
    }
  ]
}
```

```
END RequestId: 6bc28136-xmpl-4365-b021-0ce6b2e64ab0
REPORT RequestId: 6bc28136-xmpl-4365-b021-0ce6b2e64ab0 Duration: 198.50 ms Billed
Duration: 200 ms Memory Size: 512 MB Max Memory Used: 90 MB Init Duration: 524.75 ms
```

The Java runtime logs the START, END, and REPORT lines for each invocation. The report line provides the following details:

REPORT line data fields

- **RequestId** – The unique request ID for the invocation.
- **Duration** – The amount of time that your function's handler method spent processing the event.
- **Billed Duration** – The amount of time billed for the invocation.
- **Memory Size** – The amount of memory allocated to the function.
- **Max Memory Used** – The amount of memory used by the function. When invocations share an execution environment, Lambda reports the maximum memory used across all invocations. This behavior might result in a higher than expected reported value.
- **Init Duration** – For the first request served, the amount of time it took the runtime to load the function and run code outside of the handler method.
- **XRAY TraceId** – For traced requests, the [AWS X-Ray trace ID](#).
- **SegmentId** – For traced requests, the X-Ray segment ID.
- **Sampled** – For traced requests, the sampling result.

Using Lambda advanced logging controls with Java

To give you more control over how your functions' logs are captured, processed, and consumed, you can configure the following logging options for supported Java runtimes:

- **Log format** - select between plain text and structured JSON format for your function's logs
- **Log level** - for logs in JSON format, choose the detail level of the logs Lambda sends to CloudWatch, such as ERROR, DEBUG, or INFO
- **Log group** - choose the CloudWatch log group your function sends logs to

For more information about these logging options, and instructions on how to configure your function to use them, see [the section called "Configure function logs"](#).

To use the log format and log level options with your Java Lambda functions, see the guidance in the following sections.

Using structured JSON log format with Java

If you select JSON for your function's log format, Lambda will send logs output using the `LambdaLogger` class as structured JSON. Each JSON log object contains at least four key value pairs with the following keys:

- "timestamp" - the time the log message was generated
- "level" - the log level assigned to the message
- "message" - the contents of the log message
- "AWSrequestId" - the unique request ID for the function invocation

Depending on the logging method you use, log outputs from your function captured in JSON format can also contain additional key value pairs.

To assign a level to logs you create using the `LambdaLogger` logger, you need to provide a `LogLevel` argument in your logging command as shown in the following example.

Example Java logging code

```
LambdaLogger logger = context.getLogger();  
logger.log("This is a debug log", LogLevel.DEBUG);
```

This log output by this example code would be captured in CloudWatch Logs as follows:

Example JSON log record

```
{  
  "timestamp":"2023-11-01T00:21:51.358Z",  
  "level":"DEBUG",  
  "message":"This is a debug log",  
  "AWSrequestId":"93f25699-2cbf-4976-8f94-336a0aa98c6f"  
}
```

If you don't assign a level to your log output, Lambda will automatically assign it the level INFO.

If your code already uses another logging library to produce JSON structured logs, you don't need to make any changes. Lambda doesn't double-encode any logs that are already JSON encoded.

Even if you configure your function to use the JSON log format, your logging outputs appear in CloudWatch in the JSON structure you define.

Using log-level filtering with Java

For AWS Lambda to filter your application logs according to their log level, your function must use JSON formatted logs. You can achieve this in two ways:

- Create log outputs using the standard `LambdaLogger` and configure your function to use JSON log formatting. Lambda then filters your log outputs using the “level” key value pair in the JSON object described in [the section called “Using structured JSON log format with Java”](#). To learn how to configure your function’s log format, see [the section called “Configure function logs”](#).
- Use another logging library or method to create JSON structured logs in your code that include a “level” key value pair defining the level of the log output. You can use any logging library that can write JSON logs to `stdout` or `stderr`. For example, you can use Powertools for AWS Lambda or the Log4j2 package to generate JSON structured log outputs from your code. See [the section called “Using Powertools for AWS Lambda \(Java\) and AWS SAM for structured logging”](#) and [the section called “Implementing advanced logging with Log4j2 and SLF4J”](#) to learn more.

When you configure your function to use log-level filtering, you must select from the following options for the level of logs you want Lambda to send to CloudWatch Logs:

Log level	Standard usage
TRACE (most detail)	The most fine-grained information used to trace the path of your code's execution
DEBUG	Detailed information for system debugging
INFO	Messages that record the normal operation of your function
WARN	Messages about potential errors that may lead to unexpected behavior if unaddressed
ERROR	Messages about problems that prevent the code from performing as expected

Log level	Standard usage
FATAL (least detail)	Messages about serious errors that cause the application to stop functioning

For Lambda to filter your function's logs, you must also include a "timestamp" key value pair in your JSON log output. The time must be specified in valid [RFC 3339](#) timestamp format. If you don't supply a valid timestamp, Lambda will assign the log the level INFO and add a timestamp for you.

Lambda sends logs of the selected level and lower to CloudWatch. For example, if you configure a log level of WARN, Lambda will send logs corresponding to the WARN, ERROR, and FATAL levels.

Implementing advanced logging with Log4j2 and SLF4J

Note

AWS Lambda does not include Log4j2 in its managed runtimes or base container images. These are therefore not affected by the issues described in CVE-2021-44228, CVE-2021-45046, and CVE-2021-45105.

For cases where a customer function includes an impacted Log4j2 version, we have applied a change to the Lambda Java [managed runtimes](#) and [base container images](#) that helps to mitigate the issues in CVE-2021-44228, CVE-2021-45046, and CVE-2021-45105. As a result of this change, customers using Log4J2 may see an additional log entry, similar to "Transforming org/apache/logging/log4j/core/lookup/JndiLookup (java.net.URLClassLoader@. . .)". Any log strings that reference the jndi mapper in the Log4J2 output will be replaced with "Patched JndiLookup::lookup()".

Independent of this change, we strongly encourage all customers whose functions include Log4j2 to update to the latest version. Specifically, customers using the aws-lambda-java-log4j2 library in their functions should update to version 1.5.0 (or later), and redeploy their functions. This version updates the underlying Log4j2 utility dependencies to version 2.17.0 (or later). The updated aws-lambda-java-log4j2 binary is available at the [Maven repository](#) and its source code is available in [Github](#).

Lastly, take note that any libraries related to **aws-lambda-java-log4j (v1.0.0 or 1.0.1)** should **not** be used under **any** circumstance. These libraries are related to version 1.x of log4j which went end of life in 2015. The libraries are not supported, not maintained, not patched, and have known security vulnerabilities.

To customize log output, support logging during unit tests, and log AWS SDK calls, use Apache Log4j2 with SLF4J. Log4j is a logging library for Java programs that enables you to configure log levels and use appender libraries. SLF4J is a facade library that lets you change which library you use without changing your function code.

To add the request ID to your function's logs, use the appender in the [aws-lambda-java-log4j2](#) library.

Example [src/main/resources/log4j2.xml](#) – Appender configuration

```
<Configuration>
  <Appenders>
    <Lambda name="Lambda" format="{env:AWS_LAMBDA_LOG_FORMAT:-TEXT}">
      <LambdaTextFormat>
        <PatternLayout>
          <pattern>%d{yyyy-MM-dd HH:mm:ss} %X{AWSRequestId} %-5p %c{1} - %m%n </
pattern>
        </PatternLayout>
      </LambdaTextFormat>
      <LambdaJSONFormat>
        <JsonTemplateLayout eventTemplateUri="classpath:LambdaLayout.json" />
      </LambdaJSONFormat>
    </Lambda>
  </Appenders>
  <Loggers>
    <Root level="{env:AWS_LAMBDA_LOG_LEVEL:-INFO}">
      <AppenderRef ref="Lambda"/>
    </Root>
    <Logger name="software.amazon.awssdk" level="WARN" />
    <Logger name="software.amazon.awssdk.request" level="DEBUG" />
  </Loggers>
</Configuration>
```

You can decide how your Log4j2 logs are configured for either plain text or JSON outputs by specifying a layout under the `<LambdaTextFormat>` and `<LambdaJSONFormat>` tags.

In this example, in text mode, each line is prepended with the date, time, request ID, log level, and class name. In JSON mode, the `<JsonTemplateLayout>` is used with a configuration that ships together with the `aws-lambda-java-log4j2` library.

SLF4J is a facade library for logging in Java code. In your function code, you use the SLF4J logger factory to retrieve a logger with methods for log levels like `info()` and `warn()`. In your build

configuration, you include the logging library and SLF4J adapter in the classpath. By changing the libraries in the build configuration, you can change the logger type without changing your function code. SLF4J is required to capture logs from the SDK for Java.

In the following example code, the handler class uses SLF4J to retrieve a logger.

Example [src/main/java/example/HandlerS3.java](#) – Logging with SLF4J

```
package example;

import org.slf4j.Logger;
import org.slf4j.LoggerFactory;

import com.amazonaws.services.lambda.runtime.Context;
import com.amazonaws.services.lambda.runtime.RequestHandler;
import com.amazonaws.services.lambda.runtime.events.S3Event;

import static org.apache.logging.log4j.CloseableThreadContext.put;

public class HandlerS3 implements RequestHandler<S3Event, String>{
    private static final Logger logger = LoggerFactory.getLogger(HandlerS3.class);

    @Override
    public String handleRequest(S3Event event, Context context) {
        for(var record : event.getRecords()) {
            try (var loggingCtx = put("awsRegion", record.getAwsRegion())) {
                loggingCtx.put("eventName", record.getEventName());
                loggingCtx.put("bucket", record.getS3().getBucket().getName());
                loggingCtx.put("key", record.getS3().getObject().getKey());

                logger.info("Handling s3 event");
            }
        }

        return "Ok";
    }
}
```

This code produces log outputs like the following:

Example log format

```
{
  "timestamp": "2023-11-15T16:56:00.815Z",
  "level": "INFO",
  "message": "Handling s3 event",
  "logger": "example.HandlerS3",
  "AWSRequestId": "0bced576-3936-4e5a-9dcd-db9477b77f97",
  "awsRegion": "eu-south-1",
  "bucket": "java-logging-test-input-bucket",
  "eventName": "ObjectCreated:Put",
  "key": "test-folder/"
}
```

The build configuration takes runtime dependencies on the Lambda appender and SLF4J adapter, and implementation dependencies on Log4j2.

Example build.gradle – Logging dependencies

```
dependencies {
    ...
    'com.amazonaws:aws-lambda-java-log4j2:[1.6.0,)',
    'com.amazonaws:aws-lambda-java-events:[3.11.3,)',
    'org.apache.logging.log4j:log4j-layout-template-json:[2.17.1,)',
    'org.apache.logging.log4j:log4j-slf4j2-impl:[2.19.0,)',
    ...
}
```

When you run your code locally for tests, the context object with the Lambda logger is not available, and there's no request ID for the Lambda appender to use. For example test configurations, see the sample applications in the next section.

Using other logging tools and libraries

[Powertools for AWS Lambda \(Java\)](#) is a developer toolkit to implement Serverless best practices and increase developer velocity. The [Logging utility](#) provides a Lambda optimized logger which includes additional information about function context across all your functions with output structured as JSON. Use this utility to do the following:

- Capture key fields from the Lambda context, cold start and structures logging output as JSON

- Log Lambda invocation events when instructed (disabled by default)
- Print all the logs only for a percentage of invocations via log sampling (disabled by default)
- Append additional keys to structured log at any point in time
- Use a custom log formatter (Bring Your Own Formatter) to output logs in a structure compatible with your organization's Logging RFC

Using Powertools for AWS Lambda (Java) and AWS SAM for structured logging

Follow the steps below to download, build, and deploy a sample Hello World Java application with integrated [Powertools for AWS Lambda \(Java\)](#) modules using the AWS SAM. This application implements a basic API backend and uses Powertools for emitting logs, metrics, and traces. It consists of an Amazon API Gateway endpoint and a Lambda function. When you send a GET request to the API Gateway endpoint, the Lambda function invokes, sends logs and metrics using Embedded Metric Format to CloudWatch, and sends traces to AWS X-Ray. The function returns a `hello world` message.

Prerequisites

To complete the steps in this section, you must have the following:

- Java 11
- [AWS CLI version 2](#)
- [AWS SAM CLI version 1.75 or later](#). If you have an older version of the AWS SAM CLI, see [Upgrading the AWS SAM CLI](#).

Deploy a sample AWS SAM application

1. Initialize the application using the Hello World Java template.

```
sam init --app-template hello-world-powertools-java --name sam-app --package-type Zip --runtime java11 --no-tracing
```

2. Build the app.

```
cd sam-app && sam build
```

3. Deploy the app.

```
sam deploy --guided
```

4. Follow the on-screen prompts. To accept the default options provided in the interactive experience, press Enter.

Note

For **HelloWorldFunction** may not have authorization defined, Is this okay?, make sure to enter y.

5. Get the URL of the deployed application:

```
aws cloudformation describe-stacks --stack-name sam-app --query  
'Stacks[0].Outputs[?OutputKey=='HelloWorldApi'].OutputValue' --output text
```

6. Invoke the API endpoint:

```
curl -X GET <URL_FROM_PREVIOUS_STEP>
```

If successful, you'll see this response:

```
{"message":"hello world"}
```

7. To get the logs for the function, run [sam logs](#). For more information, see [Working with logs](#) in the *AWS Serverless Application Model Developer Guide*.

```
sam logs --stack-name sam-app
```

The log output looks like this:

```
2023/02/03/[$LATEST]851411a899b545eea2cffebea4cfbec81 2023-02-03T09:24:34.095000  
  INIT_START Runtime Version: java:11.v15    Runtime Version ARN: arn:aws:lambda:eu-  
central-1::runtime:0a25e3e7a1cc9ce404bc435eeb2ad358d8fa64338e618d0c224fe509403583ca  
2023/02/03/[$LATEST]851411a899b545eea2cffebea4cfbec81 2023-02-03T09:24:34.114000  
  Picked up JAVA_TOOL_OPTIONS: -XX:+TieredCompilation -XX:TieredStopAtLevel=1  
2023/02/03/[$LATEST]851411a899b545eea2cffebea4cfbec81 2023-02-03T09:24:34.793000  
  Transforming org/apache/logging/log4j/core/lookup/JndiLookup  
  (lambdainternal.CustomerClassLoader@1a6c5a9e)
```

```

2023/02/03/[$LATEST]851411a899b545eea2cffebe4cfbec81 2023-02-03T09:24:35.252000
START RequestId: 7fcf1548-d2d4-41cd-a9a8-6ae47c51f765 Version: $LATEST
2023/02/03/[$LATEST]851411a899b545eea2cffebe4cfbec81 2023-02-03T09:24:36.531000 {
  "_aws": {
    "Timestamp": 1675416276051,
    "CloudWatchMetrics": [
      {
        "Namespace": "sam-app-powerools-java",
        "Metrics": [
          {
            "Name": "ColdStart",
            "Unit": "Count"
          }
        ],
        "Dimensions": [
          [
            "Service",
            "FunctionName"
          ]
        ]
      }
    ]
  },
  "function_request_id": "7fcf1548-d2d4-41cd-a9a8-6ae47c51f765",
  "traceId":
"Root=1-63dcd2d1-25f90b9d1c753a783547f4dd;Parent=e29684c1be352ce4;Sampled=1",
  "FunctionName": "sam-app-HelloWorldFunction-y9Iu1FLJJBGD",
  "functionVersion": "$LATEST",
  "ColdStart": 1.0,
  "Service": "service_undefined",
  "logStreamId": "2023/02/03/[$LATEST]851411a899b545eea2cffebe4cfbec81",
  "executionEnvironment": "AWS_Lambda_java11"
}
2023/02/03/[$LATEST]851411a899b545eea2cffebe4cfbec81 2023-02-03T09:24:36.974000 Feb
03, 2023 9:24:36 AM com.amazonaws.xray.AWSXRayRecorder <init>
2023/02/03/[$LATEST]851411a899b545eea2cffebe4cfbec81 2023-02-03T09:24:36.993000 Feb
03, 2023 9:24:36 AM com.amazonaws.xray.config.DaemonConfiguration <init>
2023/02/03/[$LATEST]851411a899b545eea2cffebe4cfbec81 2023-02-03T09:24:36.993000
INFO: Environment variable AWS_XRAY_DAEMON_ADDRESS is set. Emitting to daemon on
address XXXX.XXXX.XXXX.XXXX:2000.
2023/02/03/[$LATEST]851411a899b545eea2cffebe4cfbec81 2023-02-03T09:24:37.331000
09:24:37.294 [main] INFO helloworld.App - {"version":null,"resource":"/
hello","path":"/hello/","httpMethod":"GET","headers":{"Accept":"*/
*","CloudFront-Forwarded-Proto":"https","CloudFront-Is-Desktop-

```

```

Viewer":"true","CloudFront-Is-Mobile-Viewer":"false","CloudFront-Is-SmartTV-Viewer":"false","CloudFront-Is-Tablet-Viewer":"false","CloudFront-Viewer-ASN":"16509","CloudFront-Viewer-Country":"IE","Host":"XXXX.execute-api.eu-central-1.amazonaws.com","User-Agent":"curl/7.86.0","Via":["2.0 f0300a9921a99446a44423d996042050.cloudfront.net (CloudFront)","X-Amz-Cf-Id":["t9W5ByT11HaY33NM8YioKECn_4eMpNsOMPfEVRczD7T1RdhbtivV1Q=="],"X-Amzn-Trace-Id":["Root=1-63dcd2d1-25f90b9d1c753a783547f4dd"],"X-Forwarded-For":["XX.XXX.XXX.XX, XX.XXX.XXX.XX"],"X-Forwarded-Port":["443"],"X-Forwarded-Proto":["https"],"multiValueHeaders":{"Accept":["*/*"],"CloudFront-Forwarded-Proto":["https"],"CloudFront-Is-Desktop-Viewer":["true"],"CloudFront-Is-Mobile-Viewer":["false"],"CloudFront-Is-SmartTV-Viewer":["false"],"CloudFront-Is-Tablet-Viewer":["false"],"CloudFront-Viewer-ASN":["16509"],"CloudFront-Viewer-Country":["IE"],"Host":["XXXX.execute-api.eu-central-1.amazonaws.com"],"User-Agent":["curl/7.86.0"],"Via":["2.0 f0300a9921a99446a44423d996042050.cloudfront.net (CloudFront)","X-Amz-Cf-Id":["t9W5ByT11HaY33NM8YioKECn_4eMpNsOMPfEVRczD7T1RdhbtivV1Q=="],"X-Amzn-Trace-Id":["Root=1-63dcd2d1-25f90b9d1c753a783547f4dd"],"X-Forwarded-For":["XXX, XXX"],"X-Forwarded-Port":["443"],"X-Forwarded-Proto":["https"]},"queryStringParameters":null,"multiValueQueryStringParameters":null,"pathParameters":{"accountId":"XXX","stage":"Prod","resourceId":"at73a1","requestId":"ba09ecd2-acf3-40f6-89af-fad32df67597","operationName":null,"identity":{"cognitoIdentityPoolId":null,"accountId":null,"cognitoIdentityId":null,"caller":null,"apiKey":"hello","httpMethod":"GET","apiId":"XXX","path":"/Prod/hello/"},"authorizer":null},"body":null,"isBase64Encoded":false}
2023/02/03/[$LATEST]851411a899b545eea2cffeba4cfbec81 2023-02-03T09:24:37.351000
09:24:37.351 [main] INFO helloworld.App - Retrieving https://
checkip.amazonaws.com
2023/02/03/[$LATEST]851411a899b545eea2cffeba4cfbec81 2023-02-03T09:24:39.313000 {
  "function_request_id": "7fcf1548-d2d4-41cd-a9a8-6ae47c51f765",
  "traceId":
  "Root=1-63dcd2d1-25f90b9d1c753a783547f4dd;Parent=e29684c1be352ce4;Sampled=1",
  "xray_trace_id": "1-63dcd2d1-25f90b9d1c753a783547f4dd",
  "functionVersion": "$LATEST",
  "Service": "service_undefined",
  "logStreamId": "2023/02/03/[$LATEST]851411a899b545eea2cffeba4cfbec81",
  "executionEnvironment": "AWS_Lambda_java11"
}
2023/02/03/[$LATEST]851411a899b545eea2cffeba4cfbec81 2023-02-03T09:24:39.371000 END
RequestId: 7fcf1548-d2d4-41cd-a9a8-6ae47c51f765
2023/02/03/[$LATEST]851411a899b545eea2cffeba4cfbec81 2023-02-03T09:24:39.371000
REPORT RequestId: 7fcf1548-d2d4-41cd-a9a8-6ae47c51f765 Duration: 4118.98 ms
Billed Duration: 4119 ms Memory Size: 512 MB Max Memory Used: 152 MB Init
Duration: 1155.47 ms

```



```
XRAY TraceId: 1-63dcd2d1-25f90b9d1c753a783547f4dd   SegmentId: 3a028fee19b895cb  
Sampled: true
```

- This is a public API endpoint that is accessible over the internet. We recommend that you delete the endpoint after testing.

```
sam delete
```

Managing log retention

Log groups aren't deleted automatically when you delete a function. To avoid storing logs indefinitely, delete the log group, or configure a retention period after which CloudWatch automatically deletes the logs. To set up log retention, add the following to your AWS SAM template:

```
Resources:  
  HelloWorldFunction:  
    Type: AWS::Serverless::Function  
    Properties:  
      # Omitting other properties  
  
  LogGroup:  
    Type: AWS::Logs::LogGroup  
    Properties:  
      LogGroupName: !Sub "/aws/lambda/${HelloWorldFunction}"  
      RetentionInDays: 7
```

Viewing logs in the Lambda console

You can use the Lambda console to view log output after you invoke a Lambda function.

If your code can be tested from the embedded **Code** editor, you will find logs in the **execution results**. When you use the console test feature to invoke a function, you'll find **Log output** in the **Details** section.

Viewing logs in the CloudWatch console

You can use the Amazon CloudWatch console to view logs for all Lambda function invocations.

To view logs on the CloudWatch console

1. Open the [Log groups page](#) on the CloudWatch console.
2. Choose the log group for your function (`/aws/lambda/your-function-name`).
3. Choose a log stream.

Each log stream corresponds to an [instance of your function](#). A log stream appears when you update your Lambda function, and when additional instances are created to handle multiple concurrent invocations. To find logs for a specific invocation, we recommend instrumenting your function with AWS X-Ray. X-Ray records details about the request and the log stream in the trace.

Viewing logs using the AWS Command Line Interface (AWS CLI)

The AWS CLI is an open-source tool that enables you to interact with AWS services using commands in your command line shell. To complete the steps in this section, you must have the [AWS CLI version 2](#).

You can use the [AWS CLI](#) to retrieve logs for an invocation using the `--log-type` command option. The response contains a `LogResult` field that contains up to 4 KB of base64-encoded logs from the invocation.

Example retrieve a log ID

The following example shows how to retrieve a *log ID* from the `LogResult` field for a function named `my-function`.

```
aws lambda invoke --function-name my-function out --log-type Tail
```

You should see the following output:

```
{
  "StatusCode": 200,
  "LogResult":
  "U1RBULQgUmVxdWVzdElkOiA4N2QwNDRiOC1mMTU0LTEXZTgt0GNkYS0yOTc0YzVlNGZiMjEgVmVyc2l1vb...",
  "ExecutedVersion": "$LATEST"
}
```

Example decode the logs

In the same command prompt, use the `base64` utility to decode the logs. The following example shows how to retrieve base64-encoded logs for `my-function`.

```
aws lambda invoke --function-name my-function out --log-type Tail \  
--query 'LogResult' --output text --cli-binary-format raw-in-base64-out | base64 --  
decode
```

The `cli-binary-format` option is required if you're using AWS CLI version 2. To make this the default setting, run `aws configure set cli-binary-format raw-in-base64-out`. For more information, see [AWS CLI supported global command line options](#) in the *AWS Command Line Interface User Guide for Version 2*.

You should see the following output:

```
START RequestId: 57f231fb-1730-4395-85cb-4f71bd2b87b8 Version: $LATEST  
"AWS_SESSION_TOKEN": "AgoJb3JpZ2luX2VjELj...", "_X_AMZN_TRACE_ID": "Root=1-5d02e5ca-  
f5792818b6fe8368e5b51d50;Parent=191db58857df8395;Sampled=0\"", ask/lib:/opt/lib",  
END RequestId: 57f231fb-1730-4395-85cb-4f71bd2b87b8  
REPORT RequestId: 57f231fb-1730-4395-85cb-4f71bd2b87b8 Duration: 79.67 ms Billed  
Duration: 80 ms Memory Size: 128 MB Max Memory Used: 73 MB
```

The `base64` utility is available on Linux, macOS, and [Ubuntu on Windows](#). macOS users may need to use `base64 -D`.

Example get-logs.sh script

In the same command prompt, use the following script to download the last five log events. The script uses `sed` to remove quotes from the output file, and sleeps for 15 seconds to allow time for the logs to become available. The output includes the response from Lambda and the output from the `get-log-events` command.

Copy the contents of the following code sample and save in your Lambda project directory as `get-logs.sh`.

The `cli-binary-format` option is required if you're using AWS CLI version 2. To make this the default setting, run `aws configure set cli-binary-format raw-in-base64-out`. For more information, see [AWS CLI supported global command line options](#) in the *AWS Command Line Interface User Guide for Version 2*.

```
#!/bin/bash
aws lambda invoke --function-name my-function --cli-binary-format raw-in-base64-out --
payload '{"key": "value"}' out
sed -i'' -e 's/"//g' out
sleep 15
aws logs get-log-events --log-group-name /aws/lambda/my-function --log-stream-
name stream1 --limit 5
```

Example macOS and Linux (only)

In the same command prompt, macOS and Linux users may need to run the following command to ensure the script is executable.

```
chmod -R 755 get-logs.sh
```

Example retrieve the last five log events

In the same command prompt, run the following script to get the last five log events.

```
./get-logs.sh
```

You should see the following output:

```
{
  "StatusCode": 200,
  "ExecutedVersion": "$LATEST"
}
{
  "events": [
    {
      "timestamp": 1559763003171,
      "message": "START RequestId: 4ce9340a-b765-490f-ad8a-02ab3415e2bf Version:
$LATEST\n",
      "ingestionTime": 1559763003309
    },
    {
      "timestamp": 1559763003173,
      "message": "2019-06-05T19:30:03.173Z\t4ce9340a-b765-490f-ad8a-02ab3415e2bf
\tINFO\tENVIRONMENT VARIABLES\r{\r  \"AWS_LAMBDA_FUNCTION_VERSION\": \"\n$LATEST\n",
\r ...",
      "ingestionTime": 1559763018353
    },
  ],
}
```

```

    {
      "timestamp": 1559763003173,
      "message": "2019-06-05T19:30:03.173Z\t4ce9340a-b765-490f-ad8a-02ab3415e2bf
\tINFO\tEVENT\r{\r  \tkey\t: \tvalue\t\r}\n",
      "ingestionTime": 1559763018353
    },
    {
      "timestamp": 1559763003218,
      "message": "END RequestId: 4ce9340a-b765-490f-ad8a-02ab3415e2bf\n",
      "ingestionTime": 1559763018353
    },
    {
      "timestamp": 1559763003218,
      "message": "REPORT RequestId: 4ce9340a-b765-490f-ad8a-02ab3415e2bf
\tDuration: 26.73 ms\tBilled Duration: 27 ms \tMemory Size: 128 MB\tMax Memory Used: 75
MB\t\n",
      "ingestionTime": 1559763018353
    }
  ],
  "nextForwardToken": "f/34783877304859518393868359594929986069206639495374241795",
  "nextBackwardToken": "b/34783877303811383369537420289090800615709599058929582080"
}

```

Deleting logs

Log groups aren't deleted automatically when you delete a function. To avoid storing logs indefinitely, delete the log group, or [configure a retention period](#) after which logs are deleted automatically.

Sample logging code

The GitHub repository for this guide includes sample applications that demonstrate the use of various logging configurations. Each sample application includes scripts for easy deployment and cleanup, an AWS SAM template, and supporting resources.

Sample Lambda applications in Java

- [java17-examples](#) – A Java function that demonstrates how to use a Java record to represent an input event data object.
- [java-basic](#) – A collection of minimal Java functions with unit tests and variable logging configuration.

- [java-events](#) – A collection of Java functions that contain skeleton code for how to handle events from various services such as Amazon API Gateway, Amazon SQS, and Amazon Kinesis. These functions use the latest version of the [aws-lambda-java-events](#) library (3.0.0 and newer). These examples do not require the AWS SDK as a dependency.
- [s3-java](#) – A Java function that processes notification events from Amazon S3 and uses the Java Class Library (JCL) to create thumbnails from uploaded image files.
- [custom-serialization](#) – Examples of how to implement [custom serialization](#) using popular libraries such as fastJson, Gson, Moshi, and jackson-jr.
- [Use API Gateway to invoke a Lambda function](#) – A Java function that scans a Amazon DynamoDB table that contains employee information. It then uses Amazon Simple Notification Service to send a text message to employees celebrating their work anniversaries. This example uses API Gateway to invoke the function.

The `java-basic` sample application shows a minimal logging configuration that supports logging tests. The handler code uses the `LambdaLogger` logger provided by the context object. For tests, the application uses a custom `TestLogger` class that implements the `LambdaLogger` interface with a Log4j2 logger. It uses SLF4J as a facade for compatibility with the AWS SDK. Logging libraries are excluded from build output to keep the deployment package small.

Instrumenting Java code in AWS Lambda

Lambda integrates with AWS X-Ray to help you trace, debug, and optimize Lambda applications. You can use X-Ray to trace a request as it traverses resources in your application, which may include Lambda functions and other AWS services.

To send tracing data to X-Ray, you can use one of two SDK libraries:

- [AWS Distro for OpenTelemetry \(ADOT\)](#) – A secure, production-ready, AWS-supported distribution of the OpenTelemetry (OTel) SDK.
- [AWS X-Ray SDK for Java](#) – An SDK for generating and sending trace data to X-Ray.
- [Powertools for AWS Lambda \(Java\)](#) – A developer toolkit to implement Serverless best practices and increase developer velocity.

Each of the SDKs offer ways to send your telemetry data to the X-Ray service. You can then use X-Ray to view, filter, and gain insights into your application's performance metrics to identify issues and opportunities for optimization.

Important

The X-Ray and Powertools for AWS Lambda SDKs are part of a tightly integrated instrumentation solution offered by AWS. The ADOT Lambda Layers are part of an industry-wide standard for tracing instrumentation that collect more data in general, but may not be suited for all use cases. You can implement end-to-end tracing in X-Ray using either solution. To learn more about choosing between them, see [Choosing between the AWS Distro for Open Telemetry and X-Ray SDKs](#).

Sections

- [Using Powertools for AWS Lambda \(Java\) and AWS SAM for tracing](#)
- [Using Powertools for AWS Lambda \(Java\) and the AWS CDK for tracing](#)
- [Using ADOT to instrument your Java functions](#)
- [Using the X-Ray SDK to instrument your Java functions](#)
- [Activating tracing with the Lambda console](#)
- [Activating tracing with the Lambda API](#)
- [Activating tracing with AWS CloudFormation](#)

- [Interpreting an X-Ray trace](#)
- [Storing runtime dependencies in a layer \(X-Ray SDK\)](#)
- [X-Ray tracing in sample applications \(X-Ray SDK\)](#)

Using Powertools for AWS Lambda (Java) and AWS SAM for tracing

Follow the steps below to download, build, and deploy a sample Hello World Java application with integrated [Powertools for AWS Lambda \(Java\)](#) modules using the AWS SAM. This application implements a basic API backend and uses Powertools for emitting logs, metrics, and traces. It consists of an Amazon API Gateway endpoint and a Lambda function. When you send a GET request to the API Gateway endpoint, the Lambda function invokes, sends logs and metrics using Embedded Metric Format to CloudWatch, and sends traces to AWS X-Ray. The function returns a `hello world` message.

Prerequisites

To complete the steps in this section, you must have the following:

- Java 11
- [AWS CLI version 2](#)
- [AWS SAM CLI version 1.75 or later](#). If you have an older version of the AWS SAM CLI, see [Upgrading the AWS SAM CLI](#).

Deploy a sample AWS SAM application

1. Initialize the application using the Hello World Java template.

```
sam init --app-template hello-world-powertools-java --name sam-app --package-type Zip --runtime java11 --no-tracing
```

2. Build the app.

```
cd sam-app && sam build
```

3. Deploy the app.

```
sam deploy --guided
```

- Follow the on-screen prompts. To accept the default options provided in the interactive experience, press Enter.

Note

For **HelloWorldFunction** may not have authorization defined, Is this okay?, make sure to enter y.

- Get the URL of the deployed application:

```
aws cloudformation describe-stacks --stack-name sam-app --query
'Stacks[0].Outputs[?OutputKey=='HelloWorldApi'].OutputValue' --output text
```

- Invoke the API endpoint:

```
curl -X GET <URL_FROM_PREVIOUS_STEP>
```

If successful, you'll see this response:

```
{"message":"hello world"}
```

- To get the traces for the function, run [sam traces](#).

```
sam traces
```

The trace output looks like this:

```
New XRay Service Graph
Start time: 2023-02-03 14:31:48+01:00
End time: 2023-02-03 14:31:48+01:00
Reference Id: 0 - (Root) AWS::Lambda - sam-app-HelloWorldFunction-y9Iu1FLJJBGD -
Edges: []
Summary_statistics:
- total requests: 1
- ok count(2XX): 1
- error count(4XX): 0
- fault count(5XX): 0
- total response time: 5.587
Reference Id: 1 - client - sam-app-HelloWorldFunction-y9Iu1FLJJBGD - Edges: [0]
Summary_statistics:
```

```
- total requests: 0
- ok count(2XX): 0
- error count(4XX): 0
- fault count(5XX): 0
- total response time: 0
```

```
XRay Event [revision 3] at (2023-02-03T14:31:48.500000) with id
(1-63dd0cc4-3c869dec72a586875da39777) and duration (5.603s)
```

```
- 5.587s - sam-app-HelloWorldFunction-y9Iu1FLJJBGD [HTTP: 200]
- 4.053s - sam-app-HelloWorldFunction-y9Iu1FLJJBGD
  - 1.181s - Initialization
  - 4.037s - Invocation
    - 1.981s - ## handleRequest
      - 1.840s - ## getPageContents
    - 0.000s - Overhead
```

8. This is a public API endpoint that is accessible over the internet. We recommend that you delete the endpoint after testing.

```
sam delete
```

Using Powertools for AWS Lambda (Java) and the AWS CDK for tracing

Follow the steps below to download, build, and deploy a sample Hello World Java application with integrated [Powertools for AWS Lambda \(Java\)](#) modules using the AWS CDK. This application implements a basic API backend and uses Powertools for emitting logs, metrics, and traces. It consists of an Amazon API Gateway endpoint and a Lambda function. When you send a GET request to the API Gateway endpoint, the Lambda function invokes, sends logs and metrics using Embedded Metric Format to CloudWatch, and sends traces to AWS X-Ray. The function returns a hello world message.

Prerequisites

To complete the steps in this section, you must have the following:

- Java 11
- [AWS CLI version 2](#)
- [AWS CDK version 2](#)

- [AWS SAM CLI version 1.75 or later](#). If you have an older version of the AWS SAM CLI, see [Upgrading the AWS SAM CLI](#).

Deploy a sample AWS CDK application

1. Create a project directory for your new application.

```
mkdir hello-world
cd hello-world
```

2. Initialize the app.

```
cdk init app --language java
```

3. Create a maven project with the following command:

```
mkdir app
cd app
mvn archetype:generate -DgroupId=helloworld -DartifactId=Function -
DarchetypeArtifactId=maven-archetype-quickstart -DinteractiveMode=false
```

4. Open `pom.xml` in the `hello-world\app\Function` directory and replace the existing code with the following code that includes dependencies and maven plugins for Powertools.

```
<project xmlns="http://maven.apache.org/POM/4.0.0" xmlns:xsi="http://
www.w3.org/2001/XMLSchema-instance"
  xsi:schemaLocation="http://maven.apache.org/POM/4.0.0 http://maven.apache.org/
maven-v4_0_0.xsd">
  <modelVersion>4.0.0</modelVersion>
  <groupId>helloworld</groupId>
  <artifactId>Function</artifactId>
  <packaging>jar</packaging>
  <version>1.0-SNAPSHOT</version>
  <name>Function</name>
  <url>http://maven.apache.org</url>
  <properties>
    <maven.compiler.source>11</maven.compiler.source>
    <maven.compiler.target>11</maven.compiler.target>
    <log4j.version>2.17.2</log4j.version>
  </properties>
  <dependencies>
    <dependency>
```

```

        <groupId>junit</groupId>
        <artifactId>junit</artifactId>
        <version>3.8.1</version>
        <scope>test</scope>
    </dependency>
    <dependency>
        <groupId>software.amazon.lambda</groupId>
        <artifactId>powertools-tracing</artifactId>
        <version>1.3.0</version>
    </dependency>
    <dependency>
        <groupId>software.amazon.lambda</groupId>
        <artifactId>powertools-metrics</artifactId>
        <version>1.3.0</version>
    </dependency>
    <dependency>
        <groupId>software.amazon.lambda</groupId>
        <artifactId>powertools-logging</artifactId>
        <version>1.3.0</version>
    </dependency>
    <dependency>
        <groupId>com.amazonaws</groupId>
        <artifactId>aws-lambda-java-core</artifactId>
        <version>1.2.2</version>
    </dependency>
    <dependency>
        <groupId>com.amazonaws</groupId>
        <artifactId>aws-lambda-java-events</artifactId>
        <version>3.11.1</version>
    </dependency>
</dependencies>
<build>
    <plugins>
        <plugin>
            <groupId>org.codehaus.mojo</groupId>
            <artifactId>aspectj-maven-plugin</artifactId>
            <version>1.14.0</version>
            <configuration>
                <source>${maven.compiler.source}</source>
                <target>${maven.compiler.target}</target>
                <complianceLevel>${maven.compiler.target}</complianceLevel>
                <aspectLibraries>
                    <aspectLibrary>
                        <groupId>software.amazon.lambda</groupId>

```

```

        <artifactId>powertools-tracing</artifactId>
    </aspectLibrary>
    <aspectLibrary>
        <groupId>software.amazon.lambda</groupId>
        <artifactId>powertools-metrics</artifactId>
    </aspectLibrary>
    <aspectLibrary>
        <groupId>software.amazon.lambda</groupId>
        <artifactId>powertools-logging</artifactId>
    </aspectLibrary>
</aspectLibraries>
</configuration>
<executions>
    <execution>
        <goals>
            <goal>compile</goal>
        </goals>
    </execution>
</executions>
</plugin>
<plugin>
    <groupId>org.apache.maven.plugins</groupId>
    <artifactId>maven-shade-plugin</artifactId>
    <version>3.4.1</version>
    <executions>
        <execution>
            <phase>package</phase>
            <goals>
                <goal>shade</goal>
            </goals>
            <configuration>
                <transformers>
                    <transformer
implementation="com.github.edwgiz.maven_shade_plugin.log4j2_cache_transformer.PluginsCache
                        </transformer>
                    </transformers>
                <createDependencyReducedPom>>false</
createDependencyReducedPom>
                    <finalName>function</finalName>

                </configuration>
            </execution>
        </executions>

```

```

        <dependencies>
            <dependency>
                <groupId>com.github.edwgiz</groupId>
                <artifactId>maven-shade-plugin.log4j2-cachefile-
transformer</artifactId>
                <version>2.15</version>
            </dependency>
        </dependencies>
    </plugin>
</plugins>
</build>
</project>

```

5. Create the `hello-world\app\src\main\resource` directory and create `log4j.xml` for the log configuration.

```

mkdir -p src/main/resource
cd src/main/resource
touch log4j.xml

```

6. Open `log4j.xml` and add the following code.

```

<?xml version="1.0" encoding="UTF-8"?>
<Configuration>
    <Appenders>
        <Console name="JsonAppender" target="SYSTEM_OUT">
            <JsonTemplateLayout
eventTemplateUri="classpath:LambdaJsonLayout.json" />
        </Console>
    </Appenders>
    <Loggers>
        <Logger name="JsonLogger" level="INFO" additivity="false">
            <AppenderRef ref="JsonAppender"/>
        </Logger>
        <Root level="info">
            <AppenderRef ref="JsonAppender"/>
        </Root>
    </Loggers>
</Configuration>

```

7. Open `App.java` from the `hello-world\app\Function\src\main\java\helloworld` directory and replace the existing code with the following code. This is the code for the Lambda function.

```
package helloworld;

import java.io.BufferedReader;
import java.io.IOException;
import java.io.InputStreamReader;
import java.net.URL;
import java.util.HashMap;
import java.util.Map;
import java.util.stream.Collectors;

import com.amazonaws.services.lambda.runtime.Context;
import com.amazonaws.services.lambda.runtime.RequestHandler;
import com.amazonaws.services.lambda.runtime.events.APIGatewayProxyRequestEvent;
import com.amazonaws.services.lambda.runtime.events.APIGatewayProxyResponseEvent;
import org.apache.logging.log4j.LogManager;
import org.apache.logging.log4j.Logger;
import software.amazon.lambda.powertools.logging.Logging;
import software.amazon.lambda.powertools.metrics.Metrics;
import software.amazon.lambda.powertools.tracing.CaptureMode;
import software.amazon.lambda.powertools.tracing.Tracing;

import static software.amazon.lambda.powertools.tracing.CaptureMode.*;

/**
 * Handler for requests to Lambda function.
 */
public class App implements RequestHandler<APIGatewayProxyRequestEvent,
APIGatewayProxyResponseEvent> {
    Logger log = LogManager.getLogger(App.class);

    @Logging(logEvent = true)
    @Tracing(captureMode = DISABLED)
    @Metrics(captureColdStart = true)
    public APIGatewayProxyResponseEvent handleRequest(final
APIGatewayProxyRequestEvent input, final Context context) {
        Map<String, String> headers = new HashMap<>();
        headers.put("Content-Type", "application/json");
        headers.put("X-Custom-Header", "application/json");

        APIGatewayProxyResponseEvent response = new APIGatewayProxyResponseEvent()
            .withHeaders(headers);
        try {
```

```

        final String pageContents = this.getPageContents("https://
checkip.amazonaws.com");
        String output = String.format("{ \"message\": \"hello world\",
\"location\": \"%s\" }", pageContents);

        return response
            .withStatusCode(200)
            .withBody(output);
    } catch (IOException e) {
        return response
            .withBody("{}")
            .withStatusCode(500);
    }
}
}
@Tracing(namespace = "getPageContents")
private String getPageContents(String address) throws IOException {
    log.info("Retrieving {}", address);
    URL url = new URL(address);
    try (BufferedReader br = new BufferedReader(new
InputStreamReader(url.openStream())))) {
        return br.lines().collect(Collectors.joining(System.lineSeparator()));
    }
}
}
}

```

8. Open `HelloWorldStack.java` from the `hello-world\src\main\java\com\myorg` directory and replace the existing code with the following code. This code uses [Lambda Constructor](#) and the [ApiGatewayv2 Constructor](#) to create a REST API and a Lambda function.

```

package com.myorg;

import software.amazon.awscdk.*;
import software.amazon.awscdk.services.apigatewayv2.alpha.*;
import
    software.amazon.awscdk.services.apigatewayv2.integrations.alpha.HttpLambdaIntegration;
import
    software.amazon.awscdk.services.apigatewayv2.integrations.alpha.HttpLambdaIntegrationProps;
import software.amazon.awscdk.services.lambda.Code;
import software.amazon.awscdk.services.lambda.Function;
import software.amazon.awscdk.services.lambda.FunctionProps;
import software.amazon.awscdk.services.lambda.Runtime;
import software.amazon.awscdk.services.lambda.Tracing;
import software.amazon.awscdk.services.logs.RetentionDays;

```



```
import software.amazon.awscdk.services.s3.assets.AssetOptions;
import software.constructs.Construct;

import java.util.Arrays;
import java.util.List;

import static java.util.Collections.singletonList;
import static software.amazon.awscdk.BundlingOutput.ARCHIVED;

public class HelloWorldStack extends Stack {
    public HelloWorldStack(final Construct scope, final String id) {
        this(scope, id, null);
    }

    public HelloWorldStack(final Construct scope, final String id, final StackProps
props) {
        super(scope, id, props);

        List<String> functionPackagingInstructions = Arrays.asList(
            "/bin/sh",
            "-c",
            "cd Function " +
                "&& mvn clean install " +
                "&& cp /asset-input/Function/target/function.jar /asset-
output/"
        );
        BundlingOptions.Builder builderOptions = BundlingOptions.builder()
            .command(functionPackagingInstructions)
            .image(Runtime.JAVA_11.getBundlingImage())
            .volumes(singletonList(
                // Mount local .m2 repo to avoid download all the
dependencies again inside the container
                DockerVolume.builder()
                    .hostPath(System.getProperty("user.home") +
"/.m2/")
                    .containerPath("/root/.m2/")
                    .build()
            ))
            .user("root")
            .outputType(ARCHIVED);

        Function function = new Function(this, "Function", FunctionProps.builder()
            .runtime(Runtime.JAVA_11)
            .code(Code.fromAsset("app", AssetOptions.builder())
```

```

        .bundling(builderOptions
            .command(functionPackagingInstructions)
            .build())
        .build()))
    .handler("helloworld.App::handleRequest")
    .memorySize(1024)
    .tracing(Tracing.ACTIVE)
    .timeout(Duration.seconds(10))
    .logRetention(RetentionDays.ONE_WEEK)
    .build());

    HttpApi httpApi = new HttpApi(this, "sample-api", HttpApiProps.builder()
        .apiName("sample-api")
        .build());

    httpApi.addRoutes(AddRoutesOptions.builder()
        .path("/")
        .methods(singletonList(HttpMethod.GET))
        .integration(new HttpLambdaIntegration("function", function,
HttpLambdaIntegrationProps.builder()
            .payloadFormatVersion(PayloadFormatVersion.VERSION_2_0)
            .build()))
        .build());

    new CfnOutput(this, "HttpApi", CfnOutputProps.builder()
        .description("Url for Http Api")
        .value(httpApi.getApiEndpoint())
        .build());
}
}

```

- Open `pom.xml` from the `hello-world` directory and replace the existing code with the following code.

```

<?xml version="1.0" encoding="UTF-8"?>
<project xsi:schemaLocation="http://maven.apache.org/POM/4.0.0 http://
maven.apache.org/xsd/maven-4.0.0.xsd"
    xmlns="http://maven.apache.org/POM/4.0.0" xmlns:xsi="http://
www.w3.org/2001/XMLSchema-instance">
    <modelVersion>4.0.0</modelVersion>

    <groupId>com.myorg</groupId>
    <artifactId>hello-world</artifactId>

```

```
<version>0.1</version>

<properties>
  <project.build.sourceEncoding>UTF-8</project.build.sourceEncoding>
  <cdk.version>2.70.0</cdk.version>
  <constructs.version>[10.0.0,11.0.0)</constructs.version>
  <junit.version>5.7.1</junit.version>
</properties>

<build>
  <plugins>
    <plugin>
      <groupId>org.apache.maven.plugins</groupId>
      <artifactId>maven-compiler-plugin</artifactId>
      <version>3.8.1</version>
      <configuration>
        <source>1.8</source>
        <target>1.8</target>
      </configuration>
    </plugin>

    <plugin>
      <groupId>org.codehaus.mojo</groupId>
      <artifactId>exec-maven-plugin</artifactId>
      <version>3.0.0</version>
      <configuration>
        <mainClass>com.myorg.HelloWorldApp</mainClass>
      </configuration>
    </plugin>
  </plugins>
</build>

<dependencies>
  <!-- AWS Cloud Development Kit -->
  <dependency>
    <groupId>software.amazon.awscdk</groupId>
    <artifactId>aws-cdk-lib</artifactId>
    <version>${cdk.version}</version>
  </dependency>
  <dependency>
    <groupId>software.constructs</groupId>
    <artifactId>constructs</artifactId>
    <version>${constructs.version}</version>
  </dependency>
```

```
<dependency>
  <groupId>org.junit.jupiter</groupId>
  <artifactId>junit-jupiter</artifactId>
  <version>${junit.version}</version>
  <scope>test</scope>
</dependency>
<dependency>
  <groupId>software.amazon.awscdk</groupId>
  <artifactId>apigatewayv2-alpha</artifactId>
  <version>${cdk.version}-alpha.0</version>
</dependency>
<dependency>
  <groupId>software.amazon.awscdk</groupId>
  <artifactId>apigatewayv2-integrations-alpha</artifactId>
  <version>${cdk.version}-alpha.0</version>
</dependency>
</dependencies>
</project>
```

10. Make sure you're in the `hello-world` directory and deploy your application.

```
cdk deploy
```

11. Get the URL of the deployed application:

```
aws cloudformation describe-stacks --stack-name HelloWorldStack --query
'Stacks[0].Outputs[?OutputKey=='HttpApi'].OutputValue' --output text
```

12. Invoke the API endpoint:

```
curl -X GET <URL_FROM_PREVIOUS_STEP>
```

If successful, you'll see this response:

```
{"message":"hello world"}
```

13. To get the traces for the function, run [sam traces](#).

```
sam traces
```

The trace output looks like this:

New XRay Service Graph

Start time: 2023-02-03 14:59:50+00:00

End time: 2023-02-03 14:59:50+00:00

Reference Id: 0 - (Root) AWS::Lambda - sam-app-HelloWorldFunction-YBg8yfYt0c9j - Edges: [1]

Summary_statistics:

- total requests: 1
- ok count(2XX): 1
- error count(4XX): 0
- fault count(5XX): 0
- total response time: 0.924

Reference Id: 1 - AWS::Lambda::Function - sam-app-HelloWorldFunction-YBg8yfYt0c9j

- Edges: []

Summary_statistics:

- total requests: 1
- ok count(2XX): 1
- error count(4XX): 0
- fault count(5XX): 0
- total response time: 0.016

Reference Id: 2 - client - sam-app-HelloWorldFunction-YBg8yfYt0c9j - Edges: [0]

Summary_statistics:

- total requests: 0
- ok count(2XX): 0
- error count(4XX): 0
- fault count(5XX): 0
- total response time: 0

XRay Event [revision 1] at (2023-02-03T14:59:50.204000) with id (1-63dd2166-434a12c22e1307ff2114f299) and duration (0.924s)

- 0.924s - sam-app-HelloWorldFunction-YBg8yfYt0c9j [HTTP: 200]
- 0.016s - sam-app-HelloWorldFunction-YBg8yfYt0c9j
- 0.739s - Initialization
- 0.016s - Invocation
 - 0.013s - ## lambda_handler
 - 0.000s - ## app.hello
- 0.000s - Overhead

14. This is a public API endpoint that is accessible over the internet. We recommend that you delete the endpoint after testing.

```
cdk destroy
```

Using ADOT to instrument your Java functions

ADOT provides fully managed Lambda [layers](#) that package everything you need to collect telemetry data using the OTel SDK. By consuming this layer, you can instrument your Lambda functions without having to modify any function code. You can also configure your layer to do custom initialization of OTel. For more information, see [Custom configuration for the ADOT Collector on Lambda](#) in the ADOT documentation.

For Java runtimes, you can choose between two layers to consume:

- **AWS managed Lambda layer for ADOT Java (Auto-instrumentation Agent)** – This layer automatically transforms your function code at startup to collect tracing data. For detailed instructions on how to consume this layer together with the ADOT Java agent, see [AWS Distro for OpenTelemetry Lambda Support for Java \(Auto-instrumentation Agent\)](#) in the ADOT documentation.
- **AWS managed Lambda layer for ADOT Java** – This layer also provides built-in instrumentation for Lambda functions, but it requires a few manual code changes to initialize the OTel SDK. For detailed instructions on how to consume this layer, see [AWS Distro for OpenTelemetry Lambda Support for Java](#) in the ADOT documentation.

Using the X-Ray SDK to instrument your Java functions

To record data about calls that your function makes to other resources and services in your application, you can add the X-Ray SDK for Java to your build configuration. The following example shows a Gradle build configuration that includes the libraries that activate automatic instrumentation of AWS SDK for Java 2.x clients.

Example [build.gradle](#) – Tracing dependencies

```
dependencies {
    implementation platform('software.amazon.awssdk:bom:2.16.1')
    implementation platform('com.amazonaws:aws-xray-recorder-sdk-bom:2.11.0')
    ...
    implementation 'com.amazonaws:aws-xray-recorder-sdk-core'
    implementation 'com.amazonaws:aws-xray-recorder-sdk-aws-sdk'
    implementation 'com.amazonaws:aws-xray-recorder-sdk-aws-sdk-v2-instrumentor'
    ...
}
```

After you add the correct dependencies and make the necessary code changes, activate tracing in your function's configuration via the Lambda console or the API.

Activating tracing with the Lambda console

To toggle active tracing on your Lambda function with the console, follow these steps:

To turn on active tracing

1. Open the [Functions page](#) of the Lambda console.
2. Choose a function.
3. Choose **Configuration** and then choose **Monitoring and operations tools**.
4. Choose **Edit**.
5. Under **X-Ray**, toggle on **Active tracing**.
6. Choose **Save**.

Activating tracing with the Lambda API

Configure tracing on your Lambda function with the AWS CLI or AWS SDK, use the following API operations:

- [UpdateFunctionConfiguration](#)
- [GetFunctionConfiguration](#)
- [CreateFunction](#)

The following example AWS CLI command enables active tracing on a function named **my-function**.

```
aws lambda update-function-configuration --function-name my-function \  
--tracing-config Mode=Active
```

Tracing mode is part of the version-specific configuration when you publish a version of your function. You can't change the tracing mode on a published version.

Activating tracing with AWS CloudFormation

To activate tracing on an `AWS::Lambda::Function` resource in an AWS CloudFormation template, use the `TracingConfig` property.

Example [function-inline.yml](#) – Tracing configuration

```
Resources:
  function:
    Type: AWS::Lambda::Function
    Properties:
      TracingConfig:
        Mode: Active
      ...
```

For an AWS Serverless Application Model (AWS SAM) `AWS::Serverless::Function` resource, use the `Tracing` property.

Example [template.yml](#) – Tracing configuration

```
Resources:
  function:
    Type: AWS::Serverless::Function
    Properties:
      Tracing: Active
      ...
```

Interpreting an X-Ray trace

Your function needs permission to upload trace data to X-Ray. When you activate tracing in the Lambda console, Lambda adds the required permissions to your function's [execution role](#). Otherwise, add the [AWSXRayDaemonWriteAccess](#) policy to the execution role.

After you've configured active tracing, you can observe specific requests through your application. The [X-Ray service graph](#) shows information about your application and all its components. The following example shows an application with two functions. The primary function processes events and sometimes returns errors. The second function at the top processes errors that appear in the first's log group and uses the AWS SDK to call X-Ray, Amazon Simple Storage Service (Amazon S3), and Amazon CloudWatch Logs.



X-Ray doesn't trace all requests to your application. X-Ray applies a sampling algorithm to ensure that tracing is efficient, while still providing a representative sample of all requests. The sampling rate is 1 request per second and 5 percent of additional requests. You can't configure the X-Ray sampling rate for your functions.

In X-Ray, a *trace* records information about a request that is processed by one or more *services*. Lambda records 2 segments per trace, which creates two nodes on the service graph. The following image highlights these two nodes:

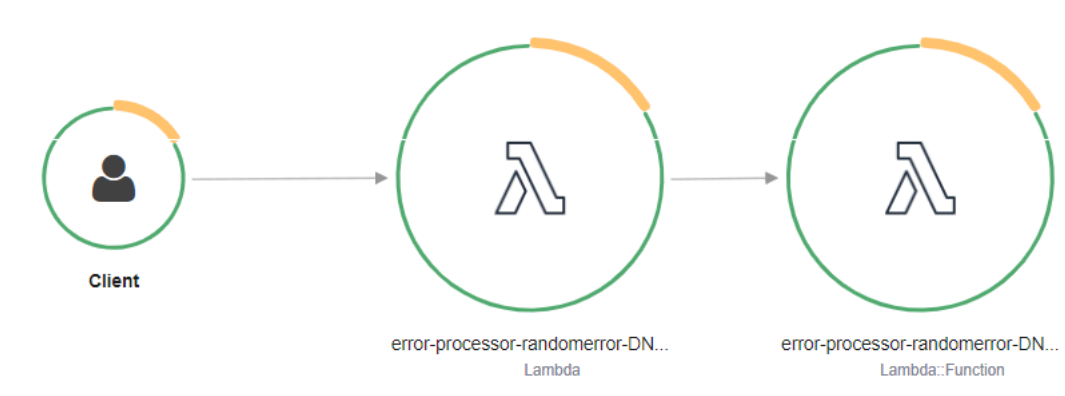

The first node on the left represents the Lambda service, which receives the invocation request. The second node represents your specific Lambda function. The following example shows a trace with these two segments. Both are named **my-function**, but one has an origin of `AWS::Lambda` and the other has an origin of `AWS::Lambda::Function`. If the `AWS::Lambda` segment shows an error, the Lambda service had an issue. If the `AWS::Lambda::Function` segment shows an error, your function had an issue.

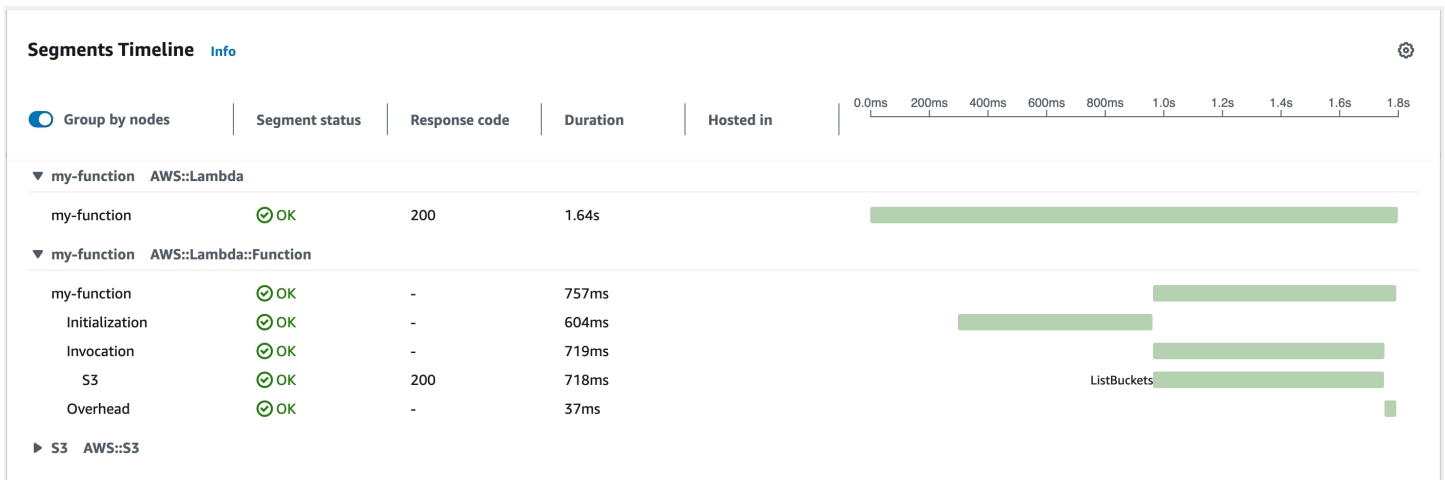

This example expands the `AWS::Lambda::Function` segment to show its three subsegments.

Note

AWS is currently implementing changes to the Lambda service. Due to these changes, you may see minor differences between the structure and content of system log messages and trace segments emitted by different Lambda functions in your AWS account.

The example trace shown here illustrates the old-style function segment. The differences between the old- and new-style segments are described in the following paragraphs.

These changes will be implemented during the coming weeks, and all functions in all AWS Regions except the China and GovCloud regions will transition to use the new-format log messages and trace segments.

The old-style function segment contains the following subsegments:

- **Initialization** – Represents time spent loading your function and running [initialization code](#). This subsegment only appears for the first event that each instance of your function processes.
- **Invocation** – Represents the time spent running your handler code.
- **Overhead** – Represents the time the Lambda runtime spends preparing to handle the next event.

The new-style function segment doesn't contain an `Invocation` subsegment. Instead, customer subsegments are attached directly to the function segment. For more information about the structure of the old- and new-style function segments, see [the section called "Understanding X-Ray traces"](#).

Note

[Lambda SnapStart](#) functions also include a Restore subsegment. The Restore subsegment shows the time it takes for Lambda to restore a snapshot, load the runtime (JVM), and run any `afterRestore` [runtime hooks](#). The process of restoring snapshots can include time spent on activities outside the MicroVM. This time is reported in the Restore subsegment. You aren't charged for the time spent outside the microVM to restore a snapshot.

You can also instrument HTTP clients, record SQL queries, and create custom subsegments with annotations and metadata. For more information, see [AWS X-Ray SDK for Java](#) in the *AWS X-Ray Developer Guide*.

Pricing

You can use X-Ray tracing for free each month up to a certain limit as part of the AWS Free Tier. Beyond that threshold, X-Ray charges for trace storage and retrieval. For more information, see [AWS X-Ray pricing](#).

Storing runtime dependencies in a layer (X-Ray SDK)

If you use the X-Ray SDK to instrument AWS SDK clients your function code, your deployment package can become quite large. To avoid uploading runtime dependencies every time you update your function code, package the X-Ray SDK in a [Lambda layer](#).

The following example shows an `AWS::Serverless::LayerVersion` resource that stores the AWS SDK for Java and X-Ray SDK for Java.

Example [template.yml](#) – Dependencies layer

```
Resources:
  function:
    Type: AWS::Serverless::Function
    Properties:
      CodeUri: build/distributions/blank-java.zip
      Tracing: Active
    Layers:
      - !Ref libs
```

```
...
libs:
  Type: AWS::Serverless::LayerVersion
  Properties:
    LayerName: blank-java-lib
    Description: Dependencies for the blank-java sample app.
    ContentUri: build/blank-java-lib.zip
    CompatibleRuntimes:
      - java21
```

With this configuration, you update the library layer only if you change your runtime dependencies. Since the function deployment package contains only your code, this can help reduce upload times.

Creating a layer for dependencies requires build configuration changes to generate the layer archive prior to deployment. For a working example, see the [java-basic](#) sample application on GitHub.

X-Ray tracing in sample applications (X-Ray SDK)

The GitHub repository for this guide includes sample applications that demonstrate the use of X-Ray tracing. Each sample application includes scripts for easy deployment and cleanup, an AWS SAM template, and supporting resources.

Sample Lambda applications in Java

- [java17-examples](#) – A Java function that demonstrates how to use a Java record to represent an input event data object.
- [java-basic](#) – A collection of minimal Java functions with unit tests and variable logging configuration.
- [java-events](#) – A collection of Java functions that contain skeleton code for how to handle events from various services such as Amazon API Gateway, Amazon SQS, and Amazon Kinesis. These functions use the latest version of the [aws-lambda-java-events](#) library (3.0.0 and newer). These examples do not require the AWS SDK as a dependency.
- [s3-java](#) – A Java function that processes notification events from Amazon S3 and uses the Java Class Library (JCL) to create thumbnails from uploaded image files.
- [custom-serialization](#) – Examples of how to implement [custom serialization](#) using popular libraries such as fastJson, Gson, Moshi, and jackson-jr.
- [Use API Gateway to invoke a Lambda function](#) – A Java function that scans a Amazon DynamoDB table that contains employee information. It then uses Amazon Simple Notification Service to

send a text message to employees celebrating their work anniversaries. This example uses API Gateway to invoke the function.

All of the sample applications have active tracing enabled for Lambda functions. For example, the `s3-java` application shows automatic instrumentation of AWS SDK for Java 2.x clients, segment management for tests, custom subsegments, and the use of Lambda layers to store runtime dependencies.

Java sample applications for AWS Lambda

The GitHub repository for this guide provides sample applications that demonstrate the use of Java in AWS Lambda. Each sample application includes scripts for easy deployment and cleanup, an AWS CloudFormation template, and supporting resources.

Sample Lambda applications in Java

- [java17-examples](#) – A Java function that demonstrates how to use a Java record to represent an input event data object.
- [java-basic](#) – A collection of minimal Java functions with unit tests and variable logging configuration.
- [java-events](#) – A collection of Java functions that contain skeleton code for how to handle events from various services such as Amazon API Gateway, Amazon SQS, and Amazon Kinesis. These functions use the latest version of the [aws-lambda-java-events](#) library (3.0.0 and newer). These examples do not require the AWS SDK as a dependency.
- [s3-java](#) – A Java function that processes notification events from Amazon S3 and uses the Java Class Library (JCL) to create thumbnails from uploaded image files.
- [custom-serialization](#) – Examples of how to implement [custom serialization](#) using popular libraries such as fastJson, Gson, Moshi, and jackson-jr.
- [Use API Gateway to invoke a Lambda function](#) – A Java function that scans a Amazon DynamoDB table that contains employee information. It then uses Amazon Simple Notification Service to send a text message to employees celebrating their work anniversaries. This example uses API Gateway to invoke the function.

Running popular Java frameworks on Lambda

- [spring-cloud-function-samples](#) – An example from Spring that shows how to use the [Spring Cloud Function](#) framework to create AWS Lambda functions.
- [Serverless Spring Boot Application Demo](#) – An example that shows how to set up a typical Spring Boot application in a managed Java runtime with and without SnapStart, or as a GraalVM native image with a custom runtime.
- [Serverless Micronaut Application Demo](#) – An example that shows how to use Micronaut in a managed Java runtime with and without SnapStart, or as a GraalVM native image with a custom runtime. Learn more in the [Micronaut/Lambda guides](#).

- [Serverless Quarkus Application Demo](#) – An example that shows how to use Quarkus in a managed Java runtime with and without SnapStart, or as a GraalVM native image with a custom runtime. Learn more in the [Quarkus/Lambda guide](#) and [Quarkus/SnapStart guide](#).

If you're new to Lambda functions in Java, start with the `java-basic` examples. To get started with Lambda event sources, see the `java-events` examples. Both of these example sets show the use of Lambda's Java libraries, environment variables, the AWS SDK, and the AWS X-Ray SDK. These examples require minimal setup and you can deploy them from the command line in less than a minute.

Building Lambda functions with Go

Go is implemented differently than other managed runtimes. Because Go compiles natively to an executable binary, it doesn't require a dedicated language runtime. Use an [OS-only runtime](#) (the provided runtime family) to deploy Go functions to Lambda.

Topics

- [Go runtime support](#)
- [Tools and libraries](#)
- [Define Lambda function handlers in Go](#)
- [Using the Lambda context object to retrieve Go function information](#)
- [Deploy Go Lambda functions with .zip file archives](#)
- [Deploy Go Lambda functions with container images](#)
- [Working with layers for Go Lambda functions](#)
- [Log and monitor Go Lambda functions](#)
- [Instrumenting Go code in AWS Lambda](#)

Go runtime support

The Go 1.x managed runtime for Lambda is [deprecated](#). If you have functions that use the Go 1.x runtime, you must migrate your functions to `provided.al2023` or `provided.al2`. The `provided.al2023` and `provided.al2` runtimes offer several advantages over `go1.x`, including support for the arm64 architecture (AWS Graviton2 processors), smaller binaries, and slightly faster invoke times.

No code changes are required for this migration. The only required changes relate to how you build your deployment package and which runtime you use to create your function. For more information, see [Migrating AWS Lambda functions from the Go1.x runtime to the custom runtime on Amazon Linux 2](#) on the *AWS Compute Blog*.

Name	Identifier	Operating system	Deprecation date	Block function create	Block function update
OS-only Runtime	provided.a12023	Amazon Linux 2023	Not scheduled	Not scheduled	Not scheduled
OS-only Runtime	provided.a12	Amazon Linux 2	Not scheduled	Not scheduled	Not scheduled

Tools and libraries

Lambda provides the following tools and libraries for the Go runtime:

- [AWS SDK for Go](#): the official AWS SDK for the Go programming language.
- github.com/aws/aws-lambda-go/lambda: The implementation of the Lambda programming model for Go. This package is used by AWS Lambda to invoke your [handler](#).
- github.com/aws/aws-lambda-go/lambdacontext: Helpers for accessing context information from the [context object](#).
- github.com/aws/aws-lambda-go/events: This library provides type definitions for common event source integrations.
- github.com/aws/aws-lambda-go/cmd/build-lambda-zip: This tool can be used to create a .zip file archive on Windows.

For more information, see [aws-lambda-go](#) on GitHub.

Lambda provides the following sample applications for the Go runtime:

Sample Lambda applications in Go

- [go-a12](#) – A hello world function that returns the public IP address. This app uses the `provided.a12` custom runtime.
- [blank-go](#) – A Go function that shows the use of Lambda's Go libraries, logging, environment variables, and the AWS SDK. This app uses the `go1.x` runtime.

Define Lambda function handlers in Go

The Lambda function *handler* is the method in your function code that processes events. When your function is invoked, Lambda runs the handler method. Your function runs until the handler returns a response, exits, or times out.

This page describes how to work with Lambda function handlers in Go, including project setup, naming conventions, and best practices. This page also includes an example of a Go Lambda function that takes in information about an order, produces a text file receipt, and puts this file in an Amazon Simple Storage Service (S3) bucket. For information about how to deploy your function after writing it, see [the section called “Deploy .zip file archives”](#) or [the section called “Deploy container images”](#).

Topics

- [Setting up your Go handler project](#)
- [Example Go Lambda function code](#)
- [Handler naming conventions](#)
- [Defining and accessing the input event object](#)
- [Accessing and using the Lambda context object](#)
- [Valid handler signatures for Go handlers](#)
- [Using the AWS SDK for Go v2 in your handler](#)
- [Accessing environment variables](#)
- [Using global state](#)
- [Code best practices for Go Lambda functions](#)

Setting up your Go handler project

A Lambda function written in [Go](#) is authored as a Go executable. You can initialize a Go Lambda function project the same way you initialize any other Go project using the following `go mod init` command:

```
go mod init example-go
```

Here, `example-go` is the module name. You can replace this with anything. This command initializes your project and generates the `go.mod` file that lists your project's dependencies.

Use the `go get` command to add any external dependencies to your project. For example, for all Lambda functions in Go, you must include the github.com/aws/aws-lambda-go/lambda package, which implements the Lambda programming model for Go. Include this package with the following `go get` command:

```
go get github.com/aws/aws-lambda-go
```

Your function code should live in a Go file. In the following example, we name this file `main.go`. In this file, you implement your core function logic in a handler method, as well as a `main()` function that calls this handler.

Example Go Lambda function code

The following example Go Lambda function code takes in information about an order, produces a text file receipt, and puts this file in an Amazon S3 bucket.

Example `main.go` Lambda function

```
package main

import (
    "context"
    "encoding/json"
    "fmt"
    "log"
    "os"
    "strings"

    "github.com/aws/aws-lambda-go/lambda"
    "github.com/aws/aws-sdk-go-v2/config"
    "github.com/aws/aws-sdk-go-v2/service/s3"
)

type Order struct {
    OrderID string `json:"order_id"`
    Amount  float64 `json:"amount"`
    Item    string  `json:"item"`
}

var (
    s3Client *s3.Client
)
```

```
func init() {
    // Initialize the S3 client outside of the handler, during the init phase
    cfg, err := config.LoadDefaultConfig(context.TODO())
    if err != nil {
        log.Fatalf("unable to load SDK config, %v", err)
    }

    s3Client = s3.NewFromConfig(cfg)
}

func uploadReceiptToS3(ctx context.Context, bucketName, key, receiptContent string)
error {
    _, err := s3Client.PutObject(ctx, &s3.PutObjectInput{
        Bucket: &bucketName,
        Key:    &key,
        Body:   strings.NewReader(receiptContent),
    })
    if err != nil {
        log.Printf("Failed to upload receipt to S3: %v", err)
        return err
    }
    return nil
}

func handleRequest(ctx context.Context, event json.RawMessage) error {
    // Parse the input event
    var order Order
    if err := json.Unmarshal(event, &order); err != nil {
        log.Printf("Failed to unmarshal event: %v", err)
        return err
    }

    // Access environment variables
    bucketName := os.Getenv("RECEIPT_BUCKET")
    if bucketName == "" {
        log.Printf("RECEIPT_BUCKET environment variable is not set")
        return fmt.Errorf("missing required environment variable RECEIPT_BUCKET")
    }

    // Create the receipt content and key destination
    receiptContent := fmt.Sprintf("OrderID: %s\nAmount: $%.2f\nItem: %s",
        order.OrderID, order.Amount, order.Item)
    key := "receipts/" + order.OrderID + ".txt"
}
```

```
// Upload the receipt to S3 using the helper method
if err := uploadReceiptToS3(ctx, bucketName, key, receiptContent); err != nil {
    return err
}

log.Printf("Successfully processed order %s and stored receipt in S3 bucket %s",
order.OrderID, bucketName)
return nil
}

func main() {
    lambda.Start(handleRequest)
}
```

This `main.go` file contains the following sections of code:

- `package main`: In Go, the package containing your `func main()` function must always be named `main`.
- `import` block: Use this block to include libraries that your Lambda function requires.
- `type Order struct {}` block: Define the shape of the expected input event in this Go struct.
- `var ()` block: Use this block to define any global variables that you'll use in your Lambda function.
- `func init() {}`: Include any code you want Lambda to run during the [initialization phase](#) in this `init()` method.
- `func uploadReceiptToS3(...) {}`: This is a helper method that's referenced by the main `handleRequest` handler method.
- `func handleRequest(ctx context.Context, event json.RawMessage) error {}`: This is the **main handler method**, which contains your main application logic.
- `func main() {}`: This is a required entry point for your Lambda handler. The argument to the `lambda.Start()` method is your main handler method.

For this function to work properly, its [execution role](#) must allow the `s3:PutObject` action. Also, ensure that you define the `RECEIPT_BUCKET` environment variable. After a successful invocation, the Amazon S3 bucket should contain a receipt file.

Handler naming conventions

For Lambda functions in Go, you can use any name for the handler. In this example, the handler method name is `handleRequest`. To reference the handler value in your code, you can use the `_HANDLER` environment variable.

For Go functions deployed using a [.zip deployment package](#), the executable file that contains your function code must be named `bootstrap`. In addition, the `bootstrap` file must be at the root of the `.zip` file. For Go functions deployed using a [container image](#), you can use any name for the executable file.

Defining and accessing the input event object

JSON is the most common and standard input format for Lambda functions. In this example, the function expects an input similar to the following:

```
{
  "order_id": "12345",
  "amount": 199.99,
  "item": "Wireless Headphones"
}
```

When working with Lambda functions in Go, you can define the shape of the expected input event as a Go struct. In this example, we define a struct to represent an `Order`:

```
type Order struct {
  OrderID string `json:"order_id"`
  Amount  float64 `json:"amount"`
  Item    string  `json:"item"`
}
```

This struct matches the expected input shape. After you define your struct, you can write a handler signature that takes in a generic JSON type compatible with the [encoding/json standard library](#). You can then deserialize it into your struct using the [func Unmarshal](#) function. This is illustrated in the first few lines of the handler:

```
func handleRequest(ctx context.Context, event json.RawMessage) error {
  // Parse the input event
  var order Order
  if err := json.Unmarshal(event, &order); err != nil {
```

```
    log.Printf("Failed to unmarshal event: %v", err)
    return err
    ...
}
```

After this deserialization, you can access the fields of the `order` variable. For example, `order.OrderID` retrieves the value of "order_id" from the original input.

Note

The `encoding/json` package can access only exported fields. To be exported, field names in the event struct must be capitalized.

Accessing and using the Lambda context object

The Lambda [context object](#) contains information about the invocation, function, and execution environment. In this example, we declared this variable as `ctx` in the handler signature:

```
func handleRequest(ctx context.Context, event json.RawMessage) error {
    ...
}
```

The `ctx context.Context` input is an optional argument in your function handler. For more information about accepted handler signatures, see [the section called "Valid handler signatures for Go handlers"](#).

If you make calls to other services using the AWS SDK, the context object is required in a few key areas. For example, to properly initialize your SDK clients, you can load the correct AWS SDK configuration using the context object as follows:

```
// Load AWS SDK configuration using the default credential provider chain
cfg, err := config.LoadDefaultConfig(ctx)
```

SDK calls themselves may require the context object as an input. For example, the `s3Client.PutObject` call accepts the context object as its first argument:

```
// Upload the receipt to S3
_, err = s3Client.PutObject(ctx, &s3.PutObjectInput{
    ...
}
```

```
})
```

Outside of AWS SDK requests, you can also use the context object for function monitoring. For more information about the context object, see [the section called “Context”](#).

Valid handler signatures for Go handlers

You have several options when building a Lambda function handler in Go, but you must adhere to the following rules:

- The handler must be a function.
- The handler may take between 0 and 2 arguments. If there are two arguments, the first argument must implement `context.Context`.
- The handler may return between 0 and 2 arguments. If there is a single return value, it must implement `error`. If there are two return values, the second value must implement `error`.

The following lists valid handler signatures. `TIn` and `TOut` represent types compatible with the *encoding/json* standard library. For more information, see [func Unmarshal](#) to learn how these types are deserialized.

- `func ()`
- `func () error`
- `func () (TOut, error)`
- `func (TIn) error`
- `func (TIn) (TOut, error)`
- `func (context.Context) error`
- `func (context.Context) (TOut, error)`
- `func (context.Context, TIn) error`
- `func (context.Context, TIn) (TOut, error)`

Using the AWS SDK for Go v2 in your handler

Often, you'll use Lambda functions to interact with or make updates to other AWS resources. The simplest way to interface with these resources is to use the AWS SDK for Go v2.

Note

The AWS SDK for Go (v1) is in maintenance mode, and will reach end-of-support on July 31, 2025. We recommend that you use only the AWS SDK for Go v2 going forward.

To add SDK dependencies to your function, use the `go get` command for the specific SDK clients that you need. In the example code earlier, we used the `config` library and the `s3` library. Add these dependencies by running the following commands in the directory that contains your `go.mod` and `main.go` files:

```
go get github.com/aws/aws-sdk-go-v2/config
go get github.com/aws/aws-sdk-go-v2/service/s3
```

Then, import the dependencies accordingly in your function's import block:

```
import (
    ...
    "github.com/aws/aws-sdk-go-v2/config"
    "github.com/aws/aws-sdk-go-v2/service/s3"
)
```

When using the SDK in your handler, configure your clients with the right settings. The simplest way to do this is to use the [default credential provider chain](#). This example illustrates one way to load this configuration:

```
// Load AWS SDK configuration using the default credential provider chain
cfg, err := config.LoadDefaultConfig(ctx)
if err != nil {
    log.Printf("Failed to load AWS SDK config: %v", err)
    return err
}
```

After loading this configuration into the `cfg` variable, you can pass this variable into client instantiations. The example code instantiates an Amazon S3 client as follows:

```
// Create an S3 client
s3Client := s3.NewFromConfig(cfg)
```

In this example, we initialized our Amazon S3 client in the `init()` function to avoid having to initialize it every time we invoke our function. The problem is that in the `init()` function, Lambda doesn't have access to the context object. As a workaround, you can pass in a placeholder like `context.TODO()` during the initialization phase. Later, when you make a call using the client, pass in the full context object. This workaround is also described in [the section called "Using the context in AWS SDK client initializations and calls"](#).

After you configure and initialize your SDK client, you can then use it to interact with other AWS services. The example code calls the Amazon S3 `PutObject` API as follows:

```
_, err = s3Client.PutObject(ctx, &s3.PutObjectInput{
    Bucket: &bucketName,
    Key:    &key,
    Body:   strings.NewReader(receiptContent),
})
```

Accessing environment variables

In your handler code, you can reference any [environment variables](#) by using the `os.Getenv()` method. In this example, we reference the defined `RECEIPT_BUCKET` environment variable using the following line of code:

```
// Access environment variables
bucketName := os.Getenv("RECEIPT_BUCKET")
if bucketName == "" {
    log.Printf("RECEIPT_BUCKET environment variable is not set")
    return fmt.Errorf("missing required environment variable RECEIPT_BUCKET")
}
```

Using global state

To avoid creating new resources every time you invoke your function, you can declare and modify global variables outside of your Lambda function's handler code. You define these global variables in a `var` block or statement. In addition, your handler may declare an `init()` function that is executed during the [initialization phase](#). The `init` method behaves the same in AWS Lambda as it does in standard Go programs.

Code best practices for Go Lambda functions

Adhere to the guidelines in the following list to use best coding practices when building your Lambda functions:

- **Separate the Lambda handler from your core logic.** This allows you to make a more unit-testable function.
- **Minimize the complexity of your dependencies.** Prefer simpler frameworks that load quickly on [execution environment](#) startup.
- **Minimize your deployment package size to its runtime necessities.** This will reduce the amount of time that it takes for your deployment package to be downloaded and unpacked ahead of invocation.
- **Take advantage of execution environment reuse to improve the performance of your function.** Initialize SDK clients and database connections outside of the function handler, and cache static assets locally in the /tmp directory. Subsequent invocations processed by the same instance of your function can reuse these resources. This saves cost by reducing function run time.

To avoid potential data leaks across invocations, don't use the execution environment to store user data, events, or other information with security implications. If your function relies on a mutable state that can't be stored in memory within the handler, consider creating a separate function or separate versions of a function for each user.

- **Use a keep-alive directive to maintain persistent connections.** Lambda purges idle connections over time. Attempting to reuse an idle connection when invoking a function will result in a connection error. To maintain your persistent connection, use the keep-alive directive associated with your runtime. For an example, see [Reusing Connections with Keep-Alive in Node.js](#).
- **Use [environment variables](#) to pass operational parameters to your function.** For example, if you are writing to an Amazon S3 bucket, instead of hard-coding the bucket name you are writing to, configure the bucket name as an environment variable.
- **Avoid using recursive invocations** in your Lambda function, where the function invokes itself or initiates a process that may invoke the function again. This could lead to unintended volume of function invocations and escalated costs. If you see an unintended volume of invocations, set the function reserved concurrency to 0 immediately to throttle all invocations to the function, while you update the code.

- **Do not use non-documented, non-public APIs** in your Lambda function code. For AWS Lambda managed runtimes, Lambda periodically applies security and functional updates to Lambda's internal APIs. These internal API updates may be backwards-incompatible, leading to unintended consequences such as invocation failures if your function has a dependency on these non-public APIs. See [the API reference](#) for a list of publicly available APIs.
- **Write idempotent code.** Writing idempotent code for your functions ensures that duplicate events are handled the same way. Your code should properly validate events and gracefully handle duplicate events. For more information, see [How do I make my Lambda function idempotent?](#)

Using the Lambda context object to retrieve Go function information

In Lambda, the context object provides methods and properties with information about the invocation, function, and execution environment. When Lambda runs your function, it passes a context object to the [handler](#). To use the context object in your handler, you can optionally declare it as an input parameter to your handler. The context object is necessary if you want to do the following in your handler:

- You need access to any of the [global variables, methods, or properties](#) offered by the context object. These methods and properties are useful for tasks like determining the entity that invoked your function or measuring the invocation time of your function, as illustrated in [the section called “Accessing invoke context information”](#).
- You need to use the AWS SDK for Go to make calls to other services. The context object is an important input parameter to most of these calls. For more information, see [the section called “Using the context in AWS SDK client initializations and calls”](#).

Topics

- [Supported variables, methods, and properties in the context object](#)
- [Accessing invoke context information](#)
- [Using the context in AWS SDK client initializations and calls](#)

Supported variables, methods, and properties in the context object

The Lambda context library provides the following global variables, methods, and properties.

Global variables

- `FunctionName` – The name of the Lambda function.
- `FunctionVersion` – The [version](#) of the function.
- `MemoryLimitInMB` – The amount of memory that's allocated for the function.
- `LogGroupName` – The log group for the function.
- `LogStreamName` – The log stream for the function instance.

Context methods

- `Deadline` – Returns the date that the execution times out, in Unix time milliseconds.

Context properties

- `InvokedFunctionArn` – The Amazon Resource Name (ARN) that's used to invoke the function. Indicates if the invoker specified a version number or alias.
- `AwsRequestID` – The identifier of the invocation request.
- `Identity` – (mobile apps) Information about the Amazon Cognito identity that authorized the request.
- `ClientContext` – (mobile apps) Client context that's provided to Lambda by the client application.

Accessing invoke context information

Lambda functions have access to metadata about their environment and the invocation request. This can be accessed at [Package context](#). Should your handler include `context.Context` as a parameter, Lambda will insert information about your function into the context's `Value` property. Note that you need to import the `lambdacontext` library to access the contents of the `context.Context` object.

```
package main

import (
    "context"
    "log"
    "github.com/aws/aws-lambda-go/lambda"
    "github.com/aws/aws-lambda-go/lambdacontext"
)

func CognitoHandler(ctx context.Context) {
    lc, _ := lambdacontext.FromContext(ctx)
    log.Print(lc.Identity.CognitoIdentityPoolID)
}

func main() {
    lambda.Start(CognitoHandler)
}
```

```
}
```

In the example above, `lc` is the variable used to consume the information that the context object captured and `log.Print(lc.Identity.CognitoIdentityPoolID)` prints that information, in this case, the `CognitoIdentityPoolID`.

The following example introduces how to use the context object to monitor how long your Lambda function takes to complete. This allows you to analyze performance expectations and adjust your function code accordingly, if needed.

```
package main

import (
    "context"
    "log"
    "time"
    "github.com/aws/aws-lambda-go/lambda"
)

func LongRunningHandler(ctx context.Context) (string, error) {

    deadline, _ := ctx.Deadline()
    deadline = deadline.Add(-100 * time.Millisecond)
    timeoutChannel := time.After(time.Until(deadline))

    for {

        select {

            case <- timeoutChannel:
                return "Finished before timing out.", nil

            default:
                log.Print("hello!")
                time.Sleep(50 * time.Millisecond)
            }
        }
    }

}

func main() {
    lambda.Start(LongRunningHandler)
}
```

Using the context in AWS SDK client initializations and calls

If your handler needs to use the AWS SDK for Go to make calls to other services, include the context object as an input to your handler. In AWS, it's a best practice to pass in the context object in most AWS SDK calls. For example, the Amazon S3 `PutObject` call accepts the context object (`ctx`) as its first argument:

```
// Upload an object to S3
_, err = s3Client.PutObject(ctx, &s3.PutObjectInput{
    ...
})
```

To initialize your SDK clients properly, you can also use the context object to load the correct configuration before passing that configuration object to the client:

```
// Load AWS SDK configuration using the default credential provider chain
cfg, err := config.LoadDefaultConfig(ctx)
...
s3Client = s3.NewFromConfig(cfg)
```

If you want to initialize your SDK clients outside of your main handler (i.e. during the initialization phase), you can pass in a placeholder context object:

```
func init() {
    // Initialize the S3 client outside of the handler, during the init phase
    cfg, err := config.LoadDefaultConfig(context.TODO())
    ...
    s3Client = s3.NewFromConfig(cfg)
}
```

If you initialize your clients this way, ensure that you pass in the correct context object in SDK calls from your main handler.

Deploy Go Lambda functions with .zip file archives

Your AWS Lambda function's code consists of scripts or compiled programs and their dependencies. You use a *deployment package* to deploy your function code to Lambda. Lambda supports two types of deployment packages: container images and .zip file archives.

This page describes how to create a .zip file as your deployment package for the Go runtime, and then use the .zip file to deploy your function code to AWS Lambda using the AWS Management Console, AWS Command Line Interface (AWS CLI), and AWS Serverless Application Model (AWS SAM).

Note that Lambda uses POSIX file permissions, so you may need to [set permissions for the deployment package folder](#) before you create the .zip file archive.

Sections

- [Creating a .zip file on macOS and Linux](#)
- [Creating a .zip file on Windows](#)
- [Creating and updating Go Lambda functions using .zip files](#)

Creating a .zip file on macOS and Linux

The following steps show how to compile your executable using the `go build` command and create a .zip file deployment package for Lambda. Before compiling your code, make sure you have installed the [lambda](#) package from GitHub. This module provides an implementation of the runtime interface, which manages the interaction between Lambda and your function code. To download this library, run the following command.

```
go get github.com/aws/aws-lambda-go/lambda
```

If your function uses the AWS SDK for Go, download the standard set of SDK modules, along with any AWS service API clients required by your application. To learn how to install the SDK for Go, see [Getting Started with the AWS SDK for Go V2](#).

Using the provided runtime family

Go is implemented differently than other managed runtimes. Because Go compiles natively to an executable binary, it doesn't require a dedicated language runtime. Use an [OS-only runtime](#) (the provided runtime family) to deploy Go functions to Lambda.

To create a .zip deployment package (macOS/Linux)

1. In the project directory that contains your application's `main.go` file, compile your executable. Note the following:

- The executable must be named `bootstrap`. For more information, see [Handler naming conventions](#).
- Set your target [instruction set architecture](#). OS-only runtimes support both `arm64` and `x86_64`.
- You can use the optional `lambda.norpc` tag to exclude the Remote Procedure Call (RPC) component of the [lambda](#) library. The RPC component is only required if you are using the deprecated Go 1.x runtime. Excluding the RPC reduces the size of the deployment package.

For the `arm64` architecture:

```
GOOS=linux GOARCH=arm64 go build -tags lambda.norpc -o bootstrap main.go
```

For the `x86_64` architecture:

```
GOOS=linux GOARCH=amd64 go build -tags lambda.norpc -o bootstrap main.go
```

2. (Optional) You may need to compile packages with `CGO_ENABLED=0` set on Linux:

```
GOOS=linux GOARCH=arm64 CGO_ENABLED=0 go build -o bootstrap -tags lambda.norpc main.go
```

This command creates a stable binary package for standard C library (`libc`) versions, which may be different on Lambda and other devices.

3. Create a deployment package by packaging the executable in a `.zip` file.

```
zip myFunction.zip bootstrap
```

Note

The `bootstrap` file must be at the root of the `.zip` file.

4. Create the function. Note the following:

- The binary must be named `bootstrap`, but the handler name can be anything. For more information, see [Handler naming conventions](#).
- The `--architectures` option is only required if you're using `arm64`. The default value is `x86_64`.
- For `--role`, specify the Amazon Resource Name (ARN) of the [execution role](#).

```
aws lambda create-function --function-name myFunction \  
--runtime provided.al2023 --handler bootstrap \  
--architectures arm64 \  
--role arn:aws:iam::111122223333:role/lambda-ex \  
--zip-file fileb://myFunction.zip
```

Creating a .zip file on Windows

The following steps show how to download the [build-lambda-zip](#) tool for Windows from GitHub, compile your executable, and create a .zip deployment package.

Note

If you have not already done so, you must install [git](#) and then add the `git` executable to your Windows `%PATH%` environment variable.

Before compiling your code, make sure you have installed the [lambda](#) library from GitHub. To download this library, run the following command.

```
go get github.com/aws/aws-lambda-go/lambda
```

If your function uses the AWS SDK for Go, download the standard set of SDK modules, along with any AWS service API clients required by your application. To learn how to install the SDK for Go, see [Getting Started with the AWS SDK for Go V2](#).

Using the provided runtime family

Go is implemented differently than other managed runtimes. Because Go compiles natively to an executable binary, it doesn't require a dedicated language runtime. Use an [OS-only runtime](#) (the provided runtime family) to deploy Go functions to Lambda.

To create a .zip deployment package (Windows)

1. Download the **build-lambda-zip** tool from GitHub.

```
go install github.com/aws/aws-lambda-go/cmd/build-lambda-zip@latest
```

2. Use the tool from your GOPATH to create a .zip file. If you have a default installation of Go, the tool is typically in %USERPROFILE%\Go\bin. Otherwise, navigate to where you installed the Go runtime and do one of the following:

cmd.exe

In cmd.exe, run one of the following, depending on your target [instruction set architecture](#). OS-only runtimes support both arm64 and x86_64.

You can use the optional `lambda.norpc` tag to exclude the Remote Procedure Call (RPC) component of the [lambda](#) library. The RPC component is only required if you are using the deprecated Go 1.x runtime. Excluding the RPC reduces the size of the deployment package.

Example — For the x86_64 architecture

```
set GOOS=linux
set GOARCH=amd64
set CGO_ENABLED=0
go build -tags lambda.norpc -o bootstrap main.go
%USERPROFILE%\Go\bin\build-lambda-zip.exe -o myFunction.zip bootstrap
```

Example — For the arm64 architecture

```
set GOOS=linux
set GOARCH=arm64
set CGO_ENABLED=0
go build -tags lambda.norpc -o bootstrap main.go
%USERPROFILE%\Go\bin\build-lambda-zip.exe -o myFunction.zip bootstrap
```

PowerShell

In PowerShell, run one of the following, depending on your target [instruction set architecture](#). OS-only runtimes support both `arm64` and `x86_64`.

You can use the optional `lambda.norpc` tag to exclude the Remote Procedure Call (RPC) component of the [lambda](#) library. The RPC component is only required if you are using the deprecated Go 1.x runtime. Excluding the RPC reduces the size of the deployment package.

For the `x86_64` architecture:

```
$env:GOOS = "linux"
$env:GOARCH = "amd64"
$env:CGO_ENABLED = "0"
go build -tags lambda.norpc -o bootstrap main.go
~\Go\Bin\build-lambda-zip.exe -o myFunction.zip bootstrap
```

For the `arm64` architecture:

```
$env:GOOS = "linux"
$env:GOARCH = "arm64"
$env:CGO_ENABLED = "0"
go build -tags lambda.norpc -o bootstrap main.go
~\Go\Bin\build-lambda-zip.exe -o myFunction.zip bootstrap
```

3. Create the function. Note the following:

- The binary must be named `bootstrap`, but the handler name can be anything. For more information, see [Handler naming conventions](#).
- The `--architectures` option is only required if you're using `arm64`. The default value is `x86_64`.
- For `--role`, specify the Amazon Resource Name (ARN) of the [execution role](#).

```
aws lambda create-function --function-name myFunction \
--runtime provided.al2023 --handler bootstrap \
--architectures arm64 \
--role arn:aws:iam::111122223333:role/lambda-ex \
--zip-file fileb://myFunction.zip
```

Creating and updating Go Lambda functions using .zip files

After you have created your .zip deployment package, you can use it to create a new Lambda function or update an existing one. You can deploy your .zip package using the Lambda console, the AWS Command Line Interface, and the Lambda API. You can also create and update Lambda functions using AWS Serverless Application Model (AWS SAM) and AWS CloudFormation.

The maximum size for a .zip deployment package for Lambda is 250 MB (unzipped). Note that this limit applies to the combined size of all the files you upload, including any Lambda layers.

The Lambda runtime needs permission to read the files in your deployment package. In Linux permissions octal notation, Lambda needs 644 permissions for non-executable files (rw-r--r--) and 755 permissions (rwxr-xr-x) for directories and executable files.

In Linux and MacOS, use the `chmod` command to change file permissions on files and directories in your deployment package. For example, to give a non-executable file the correct permissions, run the following command.

```
chmod 644 <filepath>
```

To change file permissions in Windows, see [Set, View, Change, or Remove Permissions on an Object](#) in the Microsoft Windows documentation.

Note

If you don't grant Lambda the permissions it needs to access directories in your deployment package, Lambda sets the permissions for those directories to 755 (rwxr-xr-x).

Creating and updating functions with .zip files using the console

To create a new function, you must first create the function in the console, then upload your .zip archive. To update an existing function, open the page for your function, then follow the same procedure to add your updated .zip file.

If your .zip file is less than 50MB, you can create or update a function by uploading the file directly from your local machine. For .zip files greater than 50MB, you must upload your package to an Amazon S3 bucket first. For instructions on how to upload a file to an Amazon S3 bucket using the

AWS Management Console, see [Getting started with Amazon S3](#). To upload files using the AWS CLI, see [Move objects](#) in the *AWS CLI User Guide*.

 **Note**

You cannot convert an existing container image function to use a .zip archive. You must create a new function.

To create a new function (console)

1. Open the [Functions page](#) of the Lambda console and choose **Create Function**.
2. Choose **Author from scratch**.
3. Under **Basic information**, do the following:
 - a. For **Function name**, enter the name for your function.
 - b. For **Runtime**, choose `provided.al2023`.
4. (Optional) Under **Permissions**, expand **Change default execution role**. You can create a new **Execution role** or use an existing one.
5. Choose **Create function**. Lambda creates a basic 'Hello world' function using your chosen runtime.

To upload a .zip archive from your local machine (console)

1. In the [Functions page](#) of the Lambda console, choose the function you want to upload the .zip file for.
2. Select the **Code** tab.
3. In the **Code source** pane, choose **Upload from**.
4. Choose **.zip file**.
5. To upload the .zip file, do the following:
 - a. Select **Upload**, then select your .zip file in the file chooser.
 - b. Choose **Open**.
 - c. Choose **Save**.

To upload a .zip archive from an Amazon S3 bucket (console)

1. In the [Functions page](#) of the Lambda console, choose the function you want to upload a new .zip file for.
2. Select the **Code** tab.
3. In the **Code source** pane, choose **Upload from**.
4. Choose **Amazon S3 location**.
5. Paste the Amazon S3 link URL of your .zip file and choose **Save**.

Creating and updating functions with .zip files using the AWS CLI

You can use the [AWS CLI](#) to create a new function or to update an existing one using a .zip file. Use the [create-function](#) and [update-function-code](#) commands to deploy your .zip package. If your .zip file is smaller than 50MB, you can upload the .zip package from a file location on your local build machine. For larger files, you must upload your .zip package from an Amazon S3 bucket. For instructions on how to upload a file to an Amazon S3 bucket using the AWS CLI, see [Move objects](#) in the *AWS CLI User Guide*.

Note

If you upload your .zip file from an Amazon S3 bucket using the AWS CLI, the bucket must be located in the same AWS Region as your function.

To create a new function using a .zip file with the AWS CLI, you must specify the following:

- The name of your function (`--function-name`)
- Your function's runtime (`--runtime`)
- The Amazon Resource Name (ARN) of your function's [execution role](#) (`--role`)
- The name of the handler method in your function code (`--handler`)

You must also specify the location of your .zip file. If your .zip file is located in a folder on your local build machine, use the `--zip-file` option to specify the file path, as shown in the following example command.

```
aws lambda create-function --function-name myFunction \
```



```
--runtime provided.al2023 --handler bootstrap \  
--role arn:aws:iam::111122223333:role/service-role/my-lambda-role \  
--zip-file fileb://myFunction.zip
```

To specify the location of .zip file in an Amazon S3 bucket, use the `--code` option as shown in the following example command. You only need to use the `S3ObjectVersion` parameter for versioned objects.

```
aws lambda create-function --function-name myFunction \  
--runtime provided.al2023 --handler bootstrap \  
--role arn:aws:iam::111122223333:role/service-role/my-lambda-role \  
--code S3Bucket=amzn-s3-demo-  
bucket,S3Key=myFileName.zip,S3ObjectVersion=myObjectVersion
```

To update an existing function using the CLI, you specify the the name of your function using the `--function-name` parameter. You must also specify the location of the .zip file you want to use to update your function code. If your .zip file is located in a folder on your local build machine, use the `--zip-file` option to specify the file path, as shown in the following example command.

```
aws lambda update-function-code --function-name myFunction \  
--zip-file fileb://myFunction.zip
```

To specify the location of .zip file in an Amazon S3 bucket, use the `--s3-bucket` and `--s3-key` options as shown in the following example command. You only need to use the `--s3-object-version` parameter for versioned objects.

```
aws lambda update-function-code --function-name myFunction \  
--s3-bucket amzn-s3-demo-bucket --s3-key myFileName.zip --s3-object-version myObject  
Version
```

Creating and updating functions with .zip files using the Lambda API

To create and update functions using a .zip file archive, use the following API operations:

- [CreateFunction](#)
- [UpdateFunctionCode](#)

Creating and updating functions with .zip files using AWS SAM

The AWS Serverless Application Model (AWS SAM) is a toolkit that helps streamline the process of building and running serverless applications on AWS. You define the resources for your application in a YAML or JSON template and use the AWS SAM command line interface (AWS SAM CLI) to build, package, and deploy your applications. When you build a Lambda function from an AWS SAM template, AWS SAM automatically creates a .zip deployment package or container image with your function code and any dependencies you specify. To learn more about using AWS SAM to build and deploy Lambda functions, see [Getting started with AWS SAM](#) in the *AWS Serverless Application Model Developer Guide*.

You can also use AWS SAM to create a Lambda function using an existing .zip file archive. To create a Lambda function using AWS SAM, you can save your .zip file in an Amazon S3 bucket or in a local folder on your build machine. For instructions on how to upload a file to an Amazon S3 bucket using the AWS CLI, see [Move objects](#) in the *AWS CLI User Guide*.

In your AWS SAM template, the `AWS::Serverless::Function` resource specifies your Lambda function. In this resource, set the following properties to create a function using a .zip file archive:

- `PackageType` - set to `Zip`
- `CodeUri` - set to the function code's Amazon S3 URI, path to local folder, or [FunctionCode](#) object
- `Runtime` - Set to your chosen runtime

With AWS SAM, if your .zip file is larger than 50MB, you don't need to upload it to an Amazon S3 bucket first. AWS SAM can upload .zip packages up to the maximum allowed size of 250MB (unzipped) from a location on your local build machine.

To learn more about deploying functions using .zip file in AWS SAM, see [AWS::Serverless::Function](#) in the *AWS SAM Developer Guide*.

Example: Using AWS SAM to build a Go function with `provided.al2023`

1. Create an AWS SAM template with the following properties:
 - **BuildMethod:** Specifies the compiler for your application. Use `go1.x`.
 - **Runtime:** Use `provided.al2023`.
 - **CodeUri:** Enter the path to your code.

- **Architectures:** Use `[arm64]` for the arm64 architecture. For the x86_64 instruction set architecture, use `[amd64]` or remove the `Architectures` property.

Example template.yaml

```
AWSTemplateFormatVersion: '2010-09-09'
Transform: 'AWS::Serverless-2016-10-31'
Resources:
  HelloWorldFunction:
    Type: AWS::Serverless::Function
    Metadata:
      BuildMethod: go1.x
    Properties:
      CodeUri: hello-world/ # folder where your main program resides
      Handler: bootstrap
      Runtime: provided.al2023
      Architectures: [arm64]
```

2. Use the [sam build](#) command to compile the executable.

```
sam build
```

3. Use the [sam deploy](#) command to deploy the function to Lambda.

```
sam deploy --guided
```

Creating and updating functions with .zip files using AWS CloudFormation

You can use AWS CloudFormation to create a Lambda function using a .zip file archive. To create a Lambda function from a .zip file, you must first upload your file to an Amazon S3 bucket. For instructions on how to upload a file to an Amazon S3 bucket using the AWS CLI, see [Move objects](#) in the *AWS CLI User Guide*.

In your AWS CloudFormation template, the `AWS::Lambda::Function` resource specifies your Lambda function. In this resource, set the following properties to create a function using a .zip file archive:

- `PackageType` - Set to `Zip`

- **Code** - Enter the Amazon S3 bucket name and the .zip file name in the S3Bucket and S3Key fields
- **Runtime** - Set to your chosen runtime

The .zip file that AWS CloudFormation generates cannot exceed 4MB. To learn more about deploying functions using .zip file in AWS CloudFormation, see [AWS::Lambda::Function](#) in the *AWS CloudFormation User Guide*.

Deploy Go Lambda functions with container images

There are two ways to build a container image for a Go Lambda function:

- [Using an AWS OS-only base image](#)

Go is implemented differently than other managed runtimes. Because Go compiles natively to an executable binary, it doesn't require a dedicated language runtime. Use an [OS-only base image](#) to build Go images for Lambda. To make the image compatible with Lambda, you must include the `aws-lambda-go/lambda` package in the image.

- [Using a non-AWS base image](#)

You can use an alternative base image from another container registry, such as Alpine Linux or Debian. You can also use a custom image created by your organization. To make the image compatible with Lambda, you must include the `aws-lambda-go/lambda` package in the image.

Tip

To reduce the time it takes for Lambda container functions to become active, see [Use multi-stage builds](#) in the Docker documentation. To build efficient container images, follow the [Best practices for writing Dockerfiles](#).

This page explains how to build, test, and deploy container images for Lambda.

AWS base images for deploying Go functions

Go is implemented differently than other managed runtimes. Because Go compiles natively to an executable binary, it doesn't require a dedicated language runtime. Use an [OS-only base image](#) to deploy Go functions to Lambda.

Name	Identifier	Operating system	Deprecation date	Block function create	Block function update
OS-only Runtime	provided. a12023	Amazon Linux 2023	Not scheduled	Not scheduled	Not scheduled

Name	Identifier	Operating system	Deprecation date	Block function create	Block function update
OS-only Runtime	provided.a12	Amazon Linux 2	Not scheduled	Not scheduled	Not scheduled

Amazon Elastic Container Registry Public Gallery: gallery.ecr.aws/lambda/provided

Go runtime interface client

The `aws-lambda-go/lambda` package includes an implementation of the runtime interface. For examples of how to use `aws-lambda-go/lambda` in your image, see [Using an AWS OS-only base image](#) or [Using a non-AWS base image](#).

Using an AWS OS-only base image

Go is implemented differently than other managed runtimes. Because Go compiles natively to an executable binary, it doesn't require a dedicated language runtime. Use an [OS-only base image](#) to build container images for Go functions.

Tags	Runtime	Operating system	Dockerfile	Deprecation
al2023	OS-only Runtime	Amazon Linux 2023	Dockerfile for OS-only Runtime on GitHub	Not scheduled
al2	OS-only Runtime	Amazon Linux 2	Dockerfile for OS-only Runtime on GitHub	Not scheduled

For more information about these base images, see [provided](#) in the Amazon ECR public gallery.

You must include the [aws-lambda-go/lambda](#) package with your Go handler. This package implements the programming model for Go, including the runtime interface.

Prerequisites

To complete the steps in this section, you must have the following:

- [Go](#)
- [Docker](#)
- [AWS CLI version 2](#)

Creating an image from the provided.al2023 base image

To build and deploy a Go function with the provided .a12023 base image

1. Create a directory for the project, and then switch to that directory.

```
mkdir hello
cd hello
```

2. Initialize a new Go module.

```
go mod init example.com/hello-world
```

3. Add the **lambda** library as a dependency of your new module.

```
go get github.com/aws/aws-lambda-go/lambda
```

4. Create a file named `main.go` and then open it in a text editor. This is the code for the Lambda function. You can use the following sample code for testing, or replace it with your own.

```
package main

import (
    "context"
    "github.com/aws/aws-lambda-go/events"
    "github.com/aws/aws-lambda-go/lambda"
)

func handler(ctx context.Context, event events.APIGatewayProxyRequest)
(events.APIGatewayProxyResponse, error) {
    response := events.APIGatewayProxyResponse{
        StatusCode: 200,
        Body:       "\"Hello from Lambda!\"",
    }
    return response, nil
}
```

```
func main() {  
    lambda.Start(handler)  
}
```

5. Use a text editor to create a Dockerfile in your project directory.

- The following example Dockerfile uses a [multi-stage build](#). This allows you to use a different base image in each step. You can use one image, such as a [Go base image](#), to compile your code and build the executable binary. You can then use a different image, such as `provided.al2023`, in the final FROM statement to define the image that you deploy to Lambda. The build process is separated from the final deployment image, so the final image only contains the files needed to run the application.
- You can use the optional `lambda.norpc` tag to exclude the Remote Procedure Call (RPC) component of the [lambda](#) library. The RPC component is only required if you are using the deprecated Go 1.x runtime. Excluding the RPC reduces the size of the deployment package.
- Note that the example Dockerfile does not include a [USER instruction](#). When you deploy a container image to Lambda, Lambda automatically defines a default Linux user with least-privileged permissions. This is different from standard Docker behavior which defaults to the root user when no USER instruction is provided.

Example — Multi-stage build Dockerfile

Note

Make sure that the version of Go that you specify in your Dockerfile (for example, `golang:1.20`) is the same version of Go that you used to create your application.

```
FROM golang:1.20 as build  
WORKDIR /helloworld  
# Copy dependencies list  
COPY go.mod go.sum ./  
# Build with optional lambda.norpc tag  
COPY main.go .  
RUN go build -tags lambda.norpc -o main main.go  
# Copy artifacts to a clean image  
FROM public.ecr.aws/lambda/provided:al2023  
COPY --from=build /helloworld/main ./main
```



```
ENTRYPOINT [ "./main" ]
```

- Build the Docker image with the [docker build](#) command. The following example names the image `docker-image` and gives it the test [tag](#).

```
docker build --platform linux/amd64 -t docker-image:test .
```

Note

The command specifies the `--platform linux/amd64` option to ensure that your container is compatible with the Lambda execution environment regardless of the architecture of your build machine. If you intend to create a Lambda function using the ARM64 instruction set architecture, be sure to change the command to use the `--platform linux/arm64` option instead.

(Optional) Test the image locally

Use the [runtime interface emulator](#) to locally test your image. The runtime interface emulator is included in the provided `.al2023` base image.

To run the runtime interface emulator on your local machine

- Start the Docker image with the **docker run** command. Note the following:
 - `docker-image` is the image name and `test` is the tag.
 - `./main` is the ENTRYPOINT from your Dockerfile.

```
docker run -d -p 9000:8080 \  
--entrypoint /usr/local/bin/aws-lambda-rie \  
docker-image:test ./main
```

This command runs the image as a container and creates a local endpoint at `localhost:9000/2015-03-31/functions/function/invocations`.

- From a new terminal window, post an event to the following endpoint using a **curl** command:

```
curl "http://localhost:9000/2015-03-31/functions/function/invocations" -d '{}'
```

This command invokes the function with an empty event and returns a response. Some functions might require a JSON payload. Example:

```
curl "http://localhost:9000/2015-03-31/functions/function/invocations" -d
'{"payload":"hello world!"}'
```

3. Get the container ID.

```
docker ps
```

4. Use the [docker kill](#) command to stop the container. In this command, replace 3766c4ab331c with the container ID from the previous step.

```
docker kill 3766c4ab331c
```

Deploying the image

To upload the image to Amazon ECR and create the Lambda function

1. Run the [get-login-password](#) command to authenticate the Docker CLI to your Amazon ECR registry.
 - Set the `--region` value to the AWS Region where you want to create the Amazon ECR repository.
 - Replace 111122223333 with your AWS account ID.

```
aws ecr get-login-password --region us-east-1 | docker login --username AWS --
password-stdin 111122223333.dkr.ecr.us-east-1.amazonaws.com
```

2. Create a repository in Amazon ECR using the [create-repository](#) command.

```
aws ecr create-repository --repository-name hello-world --region us-east-1 --image-
scanning-configuration scanOnPush=true --image-tag-mutability MUTABLE
```

Note

The Amazon ECR repository must be in the same AWS Region as the Lambda function.

If successful, you see a response like this:

```
{
  "repository": {
    "repositoryArn": "arn:aws:ecr:us-east-1:111122223333:repository/hello-
world",
    "registryId": "111122223333",
    "repositoryName": "hello-world",
    "repositoryUri": "111122223333.dkr.ecr.us-east-1.amazonaws.com/hello-
world",
    "createdAt": "2023-03-09T10:39:01+00:00",
    "imageTagMutability": "MUTABLE",
    "imageScanningConfiguration": {
      "scanOnPush": true
    },
    "encryptionConfiguration": {
      "encryptionType": "AES256"
    }
  }
}
```

3. Copy the `repositoryUri` from the output in the previous step.
4. Run the [docker tag](#) command to tag your local image into your Amazon ECR repository as the latest version. In this command:
 - `docker-image:test` is the name and [tag](#) of your Docker image. This is the image name and tag that you specified in the `docker build` command.
 - Replace `<ECRrepositoryUri>` with the `repositoryUri` that you copied. Make sure to include `:latest` at the end of the URI.

```
docker tag docker-image:test <ECRrepositoryUri>:latest
```

Example:

```
docker tag docker-image:test 111122223333.dkr.ecr.us-east-1.amazonaws.com/hello-world:latest
```

5. Run the [docker push](#) command to deploy your local image to the Amazon ECR repository. Make sure to include `:latest` at the end of the repository URI.

```
docker push 111122223333.dkr.ecr.us-east-1.amazonaws.com/hello-world:latest
```

6. [Create an execution role](#) for the function, if you don't already have one. You need the Amazon Resource Name (ARN) of the role in the next step.
7. Create the Lambda function. For `ImageUri`, specify the repository URI from earlier. Make sure to include `:latest` at the end of the URI.

```
aws lambda create-function \  
  --function-name hello-world \  
  --package-type Image \  
  --code ImageUri=111122223333.dkr.ecr.us-east-1.amazonaws.com/hello-world:latest \  
  --role arn:aws:iam::111122223333:role/lambda-ex
```

Note

You can create a function using an image in a different AWS account, as long as the image is in the same Region as the Lambda function. For more information, see [Amazon ECR cross-account permissions](#).

8. Invoke the function.

```
aws lambda invoke --function-name hello-world response.json
```

You should see a response like this:

```
{  
  "ExecutedVersion": "$LATEST",  
  "StatusCode": 200  
}
```

9. To see the output of the function, check the `response.json` file.

To update the function code, you must build the image again, upload the new image to the Amazon ECR repository, and then use the [update-function-code](#) command to deploy the image to the Lambda function.

Lambda resolves the image tag to a specific image digest. This means that if you point the image tag that was used to deploy the function to a new image in Amazon ECR, Lambda doesn't automatically update the function to use the new image.

To deploy the new image to the same Lambda function, you must use the [update-function-code](#) command, even if the image tag in Amazon ECR remains the same. In the following example, the `--publish` option creates a new version of the function using the updated container image.

```
aws lambda update-function-code \  
  --function-name hello-world \  
  --image-uri 111122223333.dkr.ecr.us-east-1.amazonaws.com/hello-world:latest \  
  --publish
```

Using a non-AWS base image

You can build a container image for Go from a non-AWS base image. The example Dockerfile in the following steps uses an [Alpine base image](#).

You must include the [aws-lambda-go/lambda](#) package with your Go handler. This package implements the programming model for Go, including the runtime interface.

Prerequisites

To complete the steps in this section, you must have the following:

- Go
- [Docker](#)
- [AWS CLI version 2](#)

Creating an image from an alternative base image

To build and deploy a Go function with an Alpine base image

1. Create a directory for the project, and then switch to that directory.

```
mkdir hello
```

```
cd hello
```

2. Initialize a new Go module.

```
go mod init example.com/hello-world
```

3. Add the **lambda** library as a dependency of your new module.

```
go get github.com/aws/aws-lambda-go/lambda
```

4. Create a file named `main.go` and then open it in a text editor. This is the code for the Lambda function. You can use the following sample code for testing, or replace it with your own.

```
package main

import (
    "context"
    "github.com/aws/aws-lambda-go/events"
    "github.com/aws/aws-lambda-go/lambda"
)

func handler(ctx context.Context, event events.APIGatewayProxyRequest)
(event events.APIGatewayProxyResponse, error) {
    response := events.APIGatewayProxyResponse{
        StatusCode: 200,
        Body:       "\"Hello from Lambda!\"",
    }
    return response, nil
}

func main() {
    lambda.Start(handler)
}
```

5. Use a text editor to create a Dockerfile in your project directory. The following example Dockerfile uses an [Alpine base image](#). Note that the example Dockerfile does not include a [USER instruction](#). When you deploy a container image to Lambda, Lambda automatically defines a default Linux user with least-privileged permissions. This is different from standard Docker behavior which defaults to the `root` user when no `USER` instruction is provided.

Example Dockerfile

Note

Make sure that the version of Go that you specify in your Dockerfile (for example, `golang:1.20`) is the same version of Go that you used to create your application.

```
FROM golang:1.20.2-alpine3.16 as build
WORKDIR /helloworld
# Copy dependencies list
COPY go.mod go.sum ./
# Build
COPY main.go .
RUN go build -o main main.go
# Copy artifacts to a clean image
FROM alpine:3.16
COPY --from=build /helloworld/main /main
ENTRYPOINT [ "/main" ]
```

6. Build the Docker image with the [docker build](#) command. The following example names the image `docker-image` and gives it the test [tag](#).

```
docker build --platform linux/amd64 -t docker-image:test .
```

Note

The command specifies the `--platform linux/amd64` option to ensure that your container is compatible with the Lambda execution environment regardless of the architecture of your build machine. If you intend to create a Lambda function using the ARM64 instruction set architecture, be sure to change the command to use the `--platform linux/arm64` option instead.

(Optional) Test the image locally

Use the [runtime interface emulator](#) to locally test the image. You can [build the emulator into your image](#) or use the following procedure to install it on your local machine.

To install and run the runtime interface emulator on your local machine

1. From your project directory, run the following command to download the runtime interface emulator (x86-64 architecture) from GitHub and install it on your local machine.

Linux/macOS

```
mkdir -p ~/.aws-lambda-rie && \  
  curl -Lo ~/.aws-lambda-rie/aws-lambda-rie https://github.com/aws/aws-lambda-  
runtime-interface-emulator/releases/latest/download/aws-lambda-rie && \  
  chmod +x ~/.aws-lambda-rie/aws-lambda-rie
```

To install the arm64 emulator, replace the GitHub repository URL in the previous command with the following:

```
https://github.com/aws/aws-lambda-runtime-interface-emulator/releases/latest/  
download/aws-lambda-rie-arm64
```

PowerShell

```
$dirPath = "$HOME\.aws-lambda-rie"  
if (-not (Test-Path $dirPath)) {  
  New-Item -Path $dirPath -ItemType Directory  
}  
  
$downloadLink = "https://github.com/aws/aws-lambda-runtime-interface-emulator/  
releases/latest/download/aws-lambda-rie"  
$destinationPath = "$HOME\.aws-lambda-rie\aws-lambda-rie"  
Invoke-WebRequest -Uri $downloadLink -OutFile $destinationPath
```

To install the arm64 emulator, replace the `$downloadLink` with the following:

```
https://github.com/aws/aws-lambda-runtime-interface-emulator/releases/latest/  
download/aws-lambda-rie-arm64
```

2. Start the Docker image with the **docker run** command. Note the following:
 - `docker-image` is the image name and `test` is the tag.
 - `/main` is the ENTRYPOINT from your Dockerfile.

Linux/macOS

```
docker run --platform linux/amd64 -d -v ~/.aws-lambda-rie:/aws-lambda -p
9000:8080 \
  --entrypoint /aws-lambda/aws-lambda-rie \
  docker-image:test \
  /main
```

PowerShell

```
docker run --platform linux/amd64 -d -v "$HOME\.aws-lambda-rie:/aws-lambda" -p
9000:8080 `
--entrypoint /aws-lambda/aws-lambda-rie `
docker-image:test `
  /main
```

This command runs the image as a container and creates a local endpoint at `localhost:9000/2015-03-31/functions/function/invocations`.

Note

If you built the Docker image for the ARM64 instruction set architecture, be sure to use the `--platform linux/arm64` option instead of `--platform linux/amd64`.

3. Post an event to the local endpoint.

Linux/macOS

In Linux and macOS, run the following `curl` command:

```
curl "http://localhost:9000/2015-03-31/functions/function/invocations" -d '{}'
```

This command invokes the function with an empty event and returns a response. If you're using your own function code rather than the sample function code, you might want to invoke the function with a JSON payload. Example:

```
curl "http://localhost:9000/2015-03-31/functions/function/invocations" -d
'{"payload":"hello world!"}'
```

PowerShell

In PowerShell, run the following Invoke-WebRequest command:

```
Invoke-WebRequest -Uri "http://localhost:9000/2015-03-31/functions/function/
invocations" -Method Post -Body '{}' -ContentType "application/json"
```

This command invokes the function with an empty event and returns a response. If you're using your own function code rather than the sample function code, you might want to invoke the function with a JSON payload. Example:

```
Invoke-WebRequest -Uri "http://localhost:9000/2015-03-31/functions/function/
invocations" -Method Post -Body '{"payload":"hello world!"}' -ContentType
"application/json"
```

4. Get the container ID.

```
docker ps
```

5. Use the [docker kill](#) command to stop the container. In this command, replace 3766c4ab331c with the container ID from the previous step.

```
docker kill 3766c4ab331c
```

Deploying the image

To upload the image to Amazon ECR and create the Lambda function

1. Run the [get-login-password](#) command to authenticate the Docker CLI to your Amazon ECR registry.
 - Set the `--region` value to the AWS Region where you want to create the Amazon ECR repository.
 - Replace 111122223333 with your AWS account ID.

```
aws ecr get-login-password --region us-east-1 | docker login --username AWS --password-stdin 111122223333.dkr.ecr.us-east-1.amazonaws.com
```

2. Create a repository in Amazon ECR using the [create-repository](#) command.

```
aws ecr create-repository --repository-name hello-world --region us-east-1 --image-scanning-configuration scanOnPush=true --image-tag-mutability MUTABLE
```

Note

The Amazon ECR repository must be in the same AWS Region as the Lambda function.

If successful, you see a response like this:

```
{
  "repository": {
    "repositoryArn": "arn:aws:ecr:us-east-1:111122223333:repository/hello-world",
    "registryId": "111122223333",
    "repositoryName": "hello-world",
    "repositoryUri": "111122223333.dkr.ecr.us-east-1.amazonaws.com/hello-world",
    "createdAt": "2023-03-09T10:39:01+00:00",
    "imageTagMutability": "MUTABLE",
    "imageScanningConfiguration": {
      "scanOnPush": true
    },
    "encryptionConfiguration": {
      "encryptionType": "AES256"
    }
  }
}
```

3. Copy the `repositoryUri` from the output in the previous step.
4. Run the [docker tag](#) command to tag your local image into your Amazon ECR repository as the latest version. In this command:

- `docker-image:test` is the name and [tag](#) of your Docker image. This is the image name and tag that you specified in the `docker build` command.
- Replace `<ECRrepositoryUri>` with the `repositoryUri` that you copied. Make sure to include `:latest` at the end of the URI.

```
docker tag docker-image:test <ECRrepositoryUri>:latest
```

Example:

```
docker tag docker-image:test 111122223333.dkr.ecr.us-east-1.amazonaws.com/hello-world:latest
```

5. Run the [docker push](#) command to deploy your local image to the Amazon ECR repository. Make sure to include `:latest` at the end of the repository URI.

```
docker push 111122223333.dkr.ecr.us-east-1.amazonaws.com/hello-world:latest
```

6. [Create an execution role](#) for the function, if you don't already have one. You need the Amazon Resource Name (ARN) of the role in the next step.
7. Create the Lambda function. For `ImageUri`, specify the repository URI from earlier. Make sure to include `:latest` at the end of the URI.

```
aws lambda create-function \  
  --function-name hello-world \  
  --package-type Image \  
  --code ImageUri=111122223333.dkr.ecr.us-east-1.amazonaws.com/hello-world:latest \  
  --role arn:aws:iam::111122223333:role/lambda-ex
```

Note

You can create a function using an image in a different AWS account, as long as the image is in the same Region as the Lambda function. For more information, see [Amazon ECR cross-account permissions](#).

8. Invoke the function.

```
aws lambda invoke --function-name hello-world response.json
```

You should see a response like this:

```
{
  "ExecutedVersion": "$LATEST",
  "StatusCode": 200
}
```

9. To see the output of the function, check the `response.json` file.

To update the function code, you must build the image again, upload the new image to the Amazon ECR repository, and then use the [update-function-code](#) command to deploy the image to the Lambda function.

Lambda resolves the image tag to a specific image digest. This means that if you point the image tag that was used to deploy the function to a new image in Amazon ECR, Lambda doesn't automatically update the function to use the new image.

To deploy the new image to the same Lambda function, you must use the [update-function-code](#) command, even if the image tag in Amazon ECR remains the same. In the following example, the `--publish` option creates a new version of the function using the updated container image.

```
aws lambda update-function-code \  
  --function-name hello-world \  
  --image-uri 111122223333.dkr.ecr.us-east-1.amazonaws.com/hello-world:latest \  
  --publish
```

Working with layers for Go Lambda functions

A [Lambda layer](#) is a .zip file archive that contains supplementary code or data. Layers usually contain library dependencies, a [custom runtime](#), or configuration files. Creating a layer involves three general steps:

1. Package your layer content. This means creating a .zip file archive that contains the dependencies you want to use in your functions.
2. Create the layer in Lambda.
3. Add the layer to your functions.

We don't recommend using layers to manage dependencies for Lambda functions written in Go. This is because Lambda functions in Go compile into a single executable, which you provide to Lambda when you deploy your function. This executable contains your compiled function code, along with all of its dependencies. Using layers not only complicates this process, but also leads to increased cold start times because your functions need to manually load extra assemblies into memory during the init phase.

To use external dependencies with your Go handlers, include them directly in your deployment package. By doing so, you simplify the deployment process and also take advantage of built-in Go compiler optimizations. For an example of how to import and use a dependency like the AWS SDK for Go in your function, see [the section called "Handler"](#).

Log and monitor Go Lambda functions

AWS Lambda automatically monitors Lambda functions on your behalf and sends logs to Amazon CloudWatch. Your Lambda function comes with a CloudWatch Logs log group and a log stream for each instance of your function. The Lambda runtime environment sends details about each invocation to the log stream, and relays logs and other output from your function's code. For more information, see [Using CloudWatch Logs with Lambda](#).

This page describes how to produce log output from your Lambda function's code, and access logs using the AWS Command Line Interface, the Lambda console, or the CloudWatch console.

Sections

- [Creating a function that returns logs](#)
- [Viewing logs in the Lambda console](#)
- [Viewing logs in the CloudWatch console](#)
- [Viewing logs using the AWS Command Line Interface \(AWS CLI\)](#)
- [Deleting logs](#)

Creating a function that returns logs

To output logs from your function code, you can use methods on [the `fmt` package](#), or any logging library that writes to `stdout` or `stderr`. The following example uses [the `log` package](#).

Example [main.go](#) – Logging

```
func handleRequest(ctx context.Context, event events.SQSEvent) (string, error) {
    // event
    eventJson, _ := json.MarshalIndent(event, "", " ")
    log.Printf("EVENT: %s", eventJson)
    // environment variables
    log.Printf("REGION: %s", os.Getenv("AWS_REGION"))
    log.Println("ALL ENV VARS:")
    for _, element := range os.Environ() {
        log.Println(element)
    }
}
```

Example log format

```
START RequestId: dbda340c-xmpl-4031-8810-11bb609b4c71 Version: $LATEST
```

```

2020/03/27 03:40:05 EVENT: {
  "Records": [
    {
      "messageId": "19dd0b57-b21e-4ac1-bd88-01bbb068cb78",
      "receiptHandle": "MessageReceiptHandle",
      "body": "Hello from SQS!",
      "md5fBody": "7b27xmplb47ff90a553787216d55d91d",
      "md5fMessageAttributes": "",
      "attributes": {
        "ApproximateFirstReceiveTimestamp": "1523232000001",
        "ApproximateReceiveCount": "1",
        "SenderId": "123456789012",
        "SentTimestamp": "1523232000000"
      }
    },
    ...
  ]
}

2020/03/27 03:40:05 AWS_LAMBDA_LOG_STREAM_NAME=2020/03/27/
[$LATEST]569cxmplc3c34c7489e6a97ad08b4419
2020/03/27 03:40:05 AWS_LAMBDA_FUNCTION_NAME=blank-go-function-9DV3XMPL6XBC
2020/03/27 03:40:05 AWS_LAMBDA_FUNCTION_MEMORY_SIZE=128
2020/03/27 03:40:05 AWS_LAMBDA_FUNCTION_VERSION=$LATEST
2020/03/27 03:40:05 AWS_EXECUTION_ENV=AWS_Lambda_go1.x
END RequestId: dbda340c-xmpl-4031-8810-11bb609b4c71
REPORT RequestId: dbda340c-xmpl-4031-8810-11bb609b4c71 Duration: 38.66 ms Billed
Duration: 39 ms Memory Size: 128 MB Max Memory Used: 54 MB Init Duration: 203.69 ms
XRAY TraceId: 1-5e7d7595-212fxmpl9ee07c4884191322 SegmentId: 42ffxmpl0645f474 Sampled:
true

```

The Go runtime logs the START, END, and REPORT lines for each invocation. The report line provides the following details.

REPORT line data fields

- **RequestId** – The unique request ID for the invocation.
- **Duration** – The amount of time that your function's handler method spent processing the event.
- **Billed Duration** – The amount of time billed for the invocation.
- **Memory Size** – The amount of memory allocated to the function.
- **Max Memory Used** – The amount of memory used by the function. When invocations share an execution environment, Lambda reports the maximum memory used across all invocations. This behavior might result in a higher than expected reported value.
- **Init Duration** – For the first request served, the amount of time it took the runtime to load the function and run code outside of the handler method.

- **XRAY TraceId** – For traced requests, the [AWS X-Ray trace ID](#).
- **SegmentId** – For traced requests, the X-Ray segment ID.
- **Sampled** – For traced requests, the sampling result.

Viewing logs in the Lambda console

You can use the Lambda console to view log output after you invoke a Lambda function.

If your code can be tested from the embedded **Code** editor, you will find logs in the **execution results**. When you use the console test feature to invoke a function, you'll find **Log output** in the **Details** section.

Viewing logs in the CloudWatch console

You can use the Amazon CloudWatch console to view logs for all Lambda function invocations.

To view logs on the CloudWatch console

1. Open the [Log groups page](#) on the CloudWatch console.
2. Choose the log group for your function (`/aws/lambda/your-function-name`).
3. Choose a log stream.

Each log stream corresponds to an [instance of your function](#). A log stream appears when you update your Lambda function, and when additional instances are created to handle multiple concurrent invocations. To find logs for a specific invocation, we recommend instrumenting your function with AWS X-Ray. X-Ray records details about the request and the log stream in the trace.

Viewing logs using the AWS Command Line Interface (AWS CLI)

The AWS CLI is an open-source tool that enables you to interact with AWS services using commands in your command line shell. To complete the steps in this section, you must have the [AWS CLI version 2](#).

You can use the [AWS CLI](#) to retrieve logs for an invocation using the `--log-type` command option. The response contains a `LogResult` field that contains up to 4 KB of base64-encoded logs from the invocation.

Example retrieve a log ID

The following example shows how to retrieve a *log ID* from the `LogResult` field for a function named `my-function`.

```
aws lambda invoke --function-name my-function out --log-type Tail
```

You should see the following output:

```
{
  "StatusCode": 200,
  "LogResult":
  "U1RBU1QgUmVxdWVzdElk0iA4N2QwNDRi0C1mMTU0LTExZTgt0GNkYS0y0Tc0YzVlNGZiMjEgVmVyc2l1vb...",
  "ExecutedVersion": "$LATEST"
}
```

Example decode the logs

In the same command prompt, use the `base64` utility to decode the logs. The following example shows how to retrieve base64-encoded logs for `my-function`.

```
aws lambda invoke --function-name my-function out --log-type Tail \
--query 'LogResult' --output text --cli-binary-format raw-in-base64-out | base64 --
decode
```

The `cli-binary-format` option is required if you're using AWS CLI version 2. To make this the default setting, run `aws configure set cli-binary-format raw-in-base64-out`. For more information, see [AWS CLI supported global command line options](#) in the *AWS Command Line Interface User Guide for Version 2*.

You should see the following output:

```
START RequestId: 57f231fb-1730-4395-85cb-4f71bd2b87b8 Version: $LATEST
"AWS_SESSION_TOKEN": "AgoJb3JpZ22luX2VjELj...", "_X_AMZN_TRACE_ID": "Root=1-5d02e5ca-
f5792818b6fe8368e5b51d50;Parent=191db58857df8395;Sampled=0",ask/lib:/opt/lib",
END RequestId: 57f231fb-1730-4395-85cb-4f71bd2b87b8
REPORT RequestId: 57f231fb-1730-4395-85cb-4f71bd2b87b8 Duration: 79.67 ms Billed
Duration: 80 ms Memory Size: 128 MB Max Memory Used: 73 MB
```

The `base64` utility is available on Linux, macOS, and [Ubuntu on Windows](#). macOS users may need to use `base64 -D`.

Example get-logs.sh script

In the same command prompt, use the following script to download the last five log events. The script uses `sed` to remove quotes from the output file, and sleeps for 15 seconds to allow time for the logs to become available. The output includes the response from Lambda and the output from the `get-log-events` command.

Copy the contents of the following code sample and save in your Lambda project directory as `get-logs.sh`.

The **cli-binary-format** option is required if you're using AWS CLI version 2. To make this the default setting, run `aws configure set cli-binary-format raw-in-base64-out`. For more information, see [AWS CLI supported global command line options](#) in the *AWS Command Line Interface User Guide for Version 2*.

```
#!/bin/bash
aws lambda invoke --function-name my-function --cli-binary-format raw-in-base64-out --
payload '{"key": "value"}' out
sed -i'' -e 's/"/ /g' out
sleep 15
aws logs get-log-events --log-group-name /aws/lambda/my-function --log-stream-
name stream1 --limit 5
```

Example macOS and Linux (only)

In the same command prompt, macOS and Linux users may need to run the following command to ensure the script is executable.

```
chmod -R 755 get-logs.sh
```

Example retrieve the last five log events

In the same command prompt, run the following script to get the last five log events.

```
./get-logs.sh
```

You should see the following output:

```
{
  "StatusCode": 200,
  "ExecutedVersion": "$LATEST"
```

```

}
{
  "events": [
    {
      "timestamp": 1559763003171,
      "message": "START RequestId: 4ce9340a-b765-490f-ad8a-02ab3415e2bf Version:
$LATEST\n",
      "ingestionTime": 1559763003309
    },
    {
      "timestamp": 1559763003173,
      "message": "2019-06-05T19:30:03.173Z\t4ce9340a-b765-490f-ad8a-02ab3415e2bf
\tINFO\tENVIRONMENT VARIABLES\r{\r  \"AWS_LAMBDA_FUNCTION_VERSION\": \"\n$LATEST\n",
\r ...",
      "ingestionTime": 1559763018353
    },
    {
      "timestamp": 1559763003173,
      "message": "2019-06-05T19:30:03.173Z\t4ce9340a-b765-490f-ad8a-02ab3415e2bf
\tINFO\tEVENT\r{\r  \"key\": \"value\"\r}\n",
      "ingestionTime": 1559763018353
    },
    {
      "timestamp": 1559763003218,
      "message": "END RequestId: 4ce9340a-b765-490f-ad8a-02ab3415e2bf\n",
      "ingestionTime": 1559763018353
    },
    {
      "timestamp": 1559763003218,
      "message": "REPORT RequestId: 4ce9340a-b765-490f-ad8a-02ab3415e2bf
\tDuration: 26.73 ms\tBilled Duration: 27 ms \tMemory Size: 128 MB\tMax Memory Used: 75
MB\t\n",
      "ingestionTime": 1559763018353
    }
  ],
  "nextForwardToken": "f/34783877304859518393868359594929986069206639495374241795",
  "nextBackwardToken": "b/34783877303811383369537420289090800615709599058929582080"
}

```

Deleting logs

Log groups aren't deleted automatically when you delete a function. To avoid storing logs indefinitely, delete the log group, or [configure a retention period](#) after which logs are deleted automatically.

Instrumenting Go code in AWS Lambda

Lambda integrates with AWS X-Ray to help you trace, debug, and optimize Lambda applications. You can use X-Ray to trace a request as it traverses resources in your application, which may include Lambda functions and other AWS services.

To send tracing data to X-Ray, you can use one of two SDK libraries:

- [AWS Distro for OpenTelemetry \(ADOT\)](#) – A secure, production-ready, AWS-supported distribution of the OpenTelemetry (OTel) SDK.
- [AWS X-Ray SDK for Go](#) – An SDK for generating and sending trace data to X-Ray.

Each of the SDKs offer ways to send your telemetry data to the X-Ray service. You can then use X-Ray to view, filter, and gain insights into your application's performance metrics to identify issues and opportunities for optimization.

Important

The X-Ray and Powertools for AWS Lambda SDKs are part of a tightly integrated instrumentation solution offered by AWS. The ADOT Lambda Layers are part of an industry-wide standard for tracing instrumentation that collect more data in general, but may not be suited for all use cases. You can implement end-to-end tracing in X-Ray using either solution. To learn more about choosing between them, see [Choosing between the AWS Distro for Open Telemetry and X-Ray SDKs](#).

Sections

- [Using ADOT to instrument your Go functions](#)
- [Using the X-Ray SDK to instrument your Go functions](#)
- [Activating tracing with the Lambda console](#)
- [Activating tracing with the Lambda API](#)
- [Activating tracing with AWS CloudFormation](#)
- [Interpreting an X-Ray trace](#)

Using ADOT to instrument your Go functions

ADOT provides fully managed Lambda [layers](#) that package everything you need to collect telemetry data using the OTel SDK. By consuming this layer, you can instrument your Lambda functions without having to modify any function code. You can also configure your layer to do custom initialization of OTel. For more information, see [Custom configuration for the ADOT Collector on Lambda](#) in the ADOT documentation.

For Go runtimes, you can add the **AWS managed Lambda layer for ADOT Go** to automatically instrument your functions. For detailed instructions on how to add this layer, see [AWS Distro for OpenTelemetry Lambda Support for Go](#) in the ADOT documentation.

Using the X-Ray SDK to instrument your Go functions

To record details about calls that your Lambda function makes to other resources in your application, you can also use the AWS X-Ray SDK for Go. To get the SDK, download the SDK from its [GitHub repository](#) with `go get`:

```
go get github.com/aws/aws-xray-sdk-go
```

To instrument AWS SDK clients, pass the client to the `xray.AWS()` method. You can then trace calls by using the `WithContext` version of the method.

```
svc := s3.New(session.New())
xray.AWS(svc.Client)
...
svc.ListBucketsWithContext(ctx aws.Context, input *ListBucketsInput)
```

After you add the correct dependencies and make the necessary code changes, activate tracing in your function's configuration via the Lambda console or the API.

Activating tracing with the Lambda console

To toggle active tracing on your Lambda function with the console, follow these steps:

To turn on active tracing

1. Open the [Functions page](#) of the Lambda console.

2. Choose a function.
3. Choose **Configuration** and then choose **Monitoring and operations tools**.
4. Choose **Edit**.
5. Under **X-Ray**, toggle on **Active tracing**.
6. Choose **Save**.

Activating tracing with the Lambda API

Configure tracing on your Lambda function with the AWS CLI or AWS SDK, use the following API operations:

- [UpdateFunctionConfiguration](#)
- [GetFunctionConfiguration](#)
- [CreateFunction](#)

The following example AWS CLI command enables active tracing on a function named **my-function**.

```
aws lambda update-function-configuration --function-name my-function \  
--tracing-config Mode=Active
```

Tracing mode is part of the version-specific configuration when you publish a version of your function. You can't change the tracing mode on a published version.

Activating tracing with AWS CloudFormation

To activate tracing on an `AWS::Lambda::Function` resource in an AWS CloudFormation template, use the `TracingConfig` property.

Example [function-inline.yml](#) – Tracing configuration

```
Resources:  
  function:  
    Type: AWS::Lambda::Function  
    Properties:  
      TracingConfig:  
        Mode: Active
```

...

For an AWS Serverless Application Model (AWS SAM) `AWS::Serverless::Function` resource, use the `Tracing` property.

Example [template.yml](#) – Tracing configuration

```
Resources:
  function:
    Type: AWS::Serverless::Function
    Properties:
      Tracing: Active
      ...
```

Interpreting an X-Ray trace

Your function needs permission to upload trace data to X-Ray. When you activate tracing in the Lambda console, Lambda adds the required permissions to your function's [execution role](#). Otherwise, add the [AWSXRayDaemonWriteAccess](#) policy to the execution role.

After you've configured active tracing, you can observe specific requests through your application. The [X-Ray service graph](#) shows information about your application and all its components. The following example shows an application with two functions. The primary function processes events and sometimes returns errors. The second function at the top processes errors that appear in the first's log group and uses the AWS SDK to call X-Ray, Amazon Simple Storage Service (Amazon S3), and Amazon CloudWatch Logs.



X-Ray doesn't trace all requests to your application. X-Ray applies a sampling algorithm to ensure that tracing is efficient, while still providing a representative sample of all requests. The sampling rate is 1 request per second and 5 percent of additional requests. You can't configure the X-Ray sampling rate for your functions.

In X-Ray, a *trace* records information about a request that is processed by one or more *services*. Lambda records 2 segments per trace, which creates two nodes on the service graph. The following image highlights these two nodes:

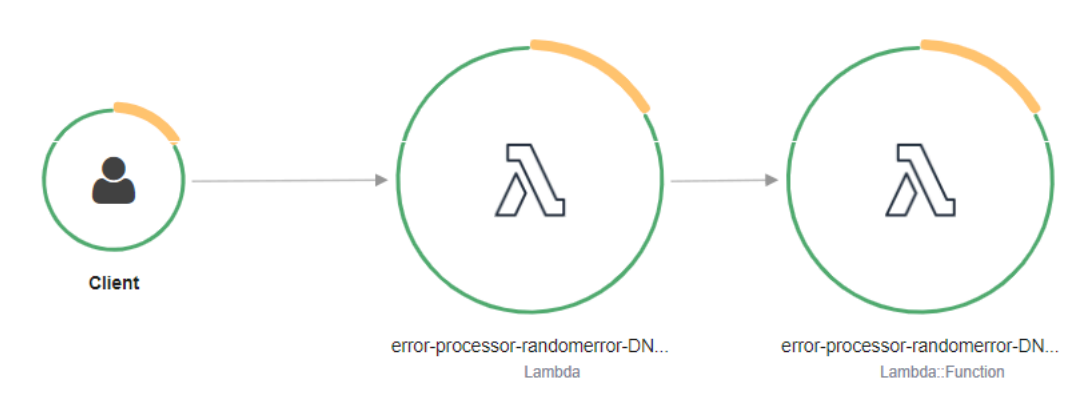

The first node on the left represents the Lambda service, which receives the invocation request. The second node represents your specific Lambda function. The following example shows a trace with these two segments. Both are named **my-function**, but one has an origin of `AWS::Lambda` and the other has an origin of `AWS::Lambda::Function`. If the `AWS::Lambda` segment shows an error, the Lambda service had an issue. If the `AWS::Lambda::Function` segment shows an error, your function had an issue.

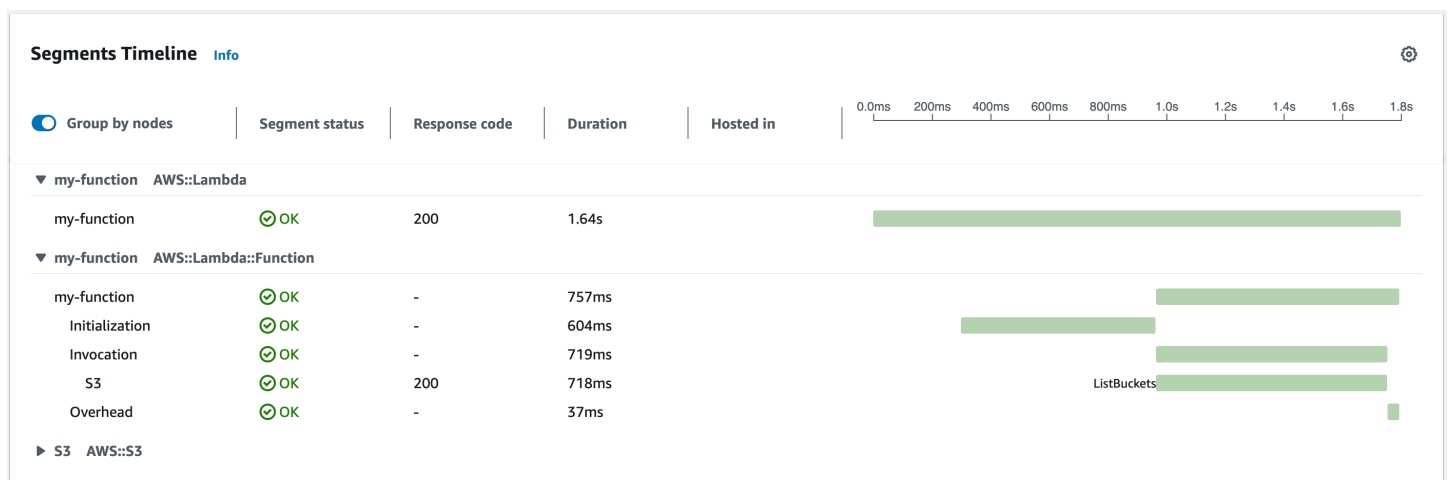

This example expands the `AWS::Lambda::Function` segment to show its three subsegments.

Note

AWS is currently implementing changes to the Lambda service. Due to these changes, you may see minor differences between the structure and content of system log messages and trace segments emitted by different Lambda functions in your AWS account.

The example trace shown here illustrates the old-style function segment. The differences between the old- and new-style segments are described in the following paragraphs.

These changes will be implemented during the coming weeks, and all functions in all AWS Regions except the China and GovCloud regions will transition to use the new-format log messages and trace segments.

The old-style function segment contains the following subsegments:

- **Initialization** – Represents time spent loading your function and running [initialization code](#). This subsegment only appears for the first event that each instance of your function processes.
- **Invocation** – Represents the time spent running your handler code.
- **Overhead** – Represents the time the Lambda runtime spends preparing to handle the next event.

The new-style function segment doesn't contain an `Invocation` subsegment. Instead, customer subsegments are attached directly to the function segment. For more information about the structure of the old- and new-style function segments, see [the section called “Understanding X-Ray traces”](#).

You can also instrument HTTP clients, record SQL queries, and create custom subsegments with annotations and metadata. For more information, see the [AWS X-Ray SDK for Go](#) in the *AWS X-Ray Developer Guide*.

Pricing

You can use X-Ray tracing for free each month up to a certain limit as part of the AWS Free Tier. Beyond that threshold, X-Ray charges for trace storage and retrieval. For more information, see [AWS X-Ray pricing](#).

Building Lambda functions with C#

You can run your .NET application in Lambda using the managed .NET 8 runtime, a custom runtime, or a container image. After your application code is compiled, you can deploy it to Lambda either as a .zip file or a container image. Lambda provides the following runtimes for .NET languages:

Name	Identifier	Operating system	Deprecation date	Block function create	Block function update
.NET 8	dotnet8	Amazon Linux 2023	Not scheduled	Not scheduled	Not scheduled

Setting up your .NET development environment

To develop and build your Lambda functions, you can use any of the commonly available .NET integrated development environments (IDEs), including Microsoft Visual Studio, Visual Studio Code, and JetBrains Rider. To simplify your development experience, AWS provides a set of .NET project templates, as well as the Amazon.Lambda.Tools command line interface (CLI).

Run the following .NET CLI commands to install these project templates and command line tools.

Installing the .NET project templates

To install the project templates, run the following command:

```
dotnet new install Amazon.Lambda.Templates
```

Installing and updating the CLI tools

Run the following commands to install, update, and uninstall the Amazon.Lambda.Tools CLI.

To install the command line tools:

```
dotnet tool install -g Amazon.Lambda.Tools
```

To update the command line tools:

```
dotnet tool update -g Amazon.Lambda.Tools
```

To uninstall the command line tools:

```
dotnet tool uninstall -g Amazon.Lambda.Tools
```

Define Lambda function handler in C#

The Lambda function *handler* is the method in your function code that processes events. When your function is invoked, Lambda runs the handler method. Your function runs until the handler returns a response, exits, or times out.

When your function is invoked and Lambda runs your function's handler method, it passes two arguments to your function. The first argument is the event object. When another AWS service invokes your function, the event object contains data about the event that caused your function to be invoked. For example, an event object from API Gateway contains information about the path, HTTP method, and HTTP headers. The exact event structure varies according to the AWS service invoking your function. See [Integrating other services](#) for more information about event formats for individual services.

Lambda also passes a context object to your function. This object contains information about the invocation, function, and execution environment. For more information, see [the section called "Context"](#).

The native format for all Lambda events is streams of bytes representing the JSON formatted event. Unless your function input and output parameters are of type `System.IO.Stream`, you must serialize them. Specify the serializer you want to use by setting the `LambdaSerializer` assembly attribute. For more information, see [the section called "Serialization in Lambda functions"](#).

Topics

- [.NET execution models for Lambda](#)
- [Class library handlers](#)
- [Executable assembly handlers](#)
- [Serialization in Lambda functions](#)
- [Simplify function code with the Lambda Annotations framework](#)
- [Lambda function handler restrictions](#)
- [Code best practices for C# Lambda functions](#)

.NET execution models for Lambda

There are two different execution models for running Lambda functions in .NET: the **class library** approach and the **executable assembly** approach.

In the **class library** approach, you provide Lambda with a string indicating the `AssemblyName`, `ClassName`, and `Method` of the function to be invoked. For more information about the format of this string, see [the section called "Class library handlers"](#). During the function's initialization phase, your function's class is initialized, and any code in the constructor is run.

In the **executable assembly** approach, you use C# 9's [top-level statements](#) feature. This approach generates an executable assembly which Lambda runs whenever it receives an `invoke` command for your function. You provide Lambda only with the name of the executable assembly to run.

The following sections give example function code for these two approaches.

Class library handlers

The following Lambda function code shows an example of a handler method (`FunctionHandler`) for a Lambda function which uses the class library approach. In this example function, Lambda receives an event from API Gateway that invokes the function. The function reads a record from a database and returns the record as part of the API Gateway response.

```
[assembly:
  LambdaSerializer(typeof(Amazon.Lambda.Serialization.SystemTextJson.DefaultLambdaJsonSerializer))

namespace GetProductHandler;

public class Function
{
    private readonly IDatabaseRepository _repo;

    public Function()
    {
        this._repo = new DatabaseRepository();
    }

    public async Task<APIGatewayProxyResponse> FunctionHandler(APIGatewayProxyRequest
request)
    {
        var id = request.PathParameters["id"];
    }
}
```

```
var databaseRecord = await this._repo.GetById(id);

return new APIGatewayProxyResponse
{
    StatusCode = (int)HttpStatusCode.OK,
    Body = JsonSerializer.Serialize(databaseRecord)
};
}
```

When you create a Lambda function, you need to provide Lambda with information about your function's handler in the form of a *handler string*. This tells Lambda which method in your code to run when your function is invoked. In C#, the format of the handler string when using the class library approach is as follows:

ASSEMBLY::TYPE::METHOD, where:

- ASSEMBLY is the name of the .NET assembly file for your application. If you use the `Amazon.Lambda.Tools` CLI to build your application and you don't set the assembly name using the `AssemblyName` property in the `.csproj` file, then ASSEMBLY is simply the name of your `.csproj` file.
- TYPE is the full name of the handler type, which consists of the Namespace and the ClassName.
- METHOD is the name of the function handler method in your code.

For the example code shown, if the assembly is named `GetProductHandler`, then the handler string would be `GetProductHandler::GetProductHandler.Function::FunctionHandler`.

Executable assembly handlers

In the following example, the Lambda function is defined as an executable assembly. The handler method in this code is named `Handler`. When using executable assemblies, the Lambda runtime must be bootstrapped. To do this, you use the `LambdaBootstrapBuilder.Create` method. This method takes as inputs the method your function uses as the handler and the Lambda serializer to use.

For more information about using top-level statements, see [Introducing the .NET 6 runtime for AWS Lambda](#) on the AWS compute blog.

```
namespace GetProductHandler;
```



```
IDatabaseRepository repo = new DatabaseRepository();

await LambdaBootstrapBuilder.Create<APIGatewayProxyRequest>(Handler, new
    DefaultLambdaJsonSerializer())
    .Build()
    .RunAsync();

async Task<APIGatewayProxyResponse> Handler(APIGatewayProxyRequest apigProxyEvent,
    ILambdaContext context)
{
    var id = apigProxyEvent.PathParameters["id"];

    var databaseRecord = await this.repo.GetById(id);

    return new APIGatewayProxyResponse
    {
        StatusCode = (int)HttpStatusCode.OK,
        Body = JsonSerializer.Serialize(databaseRecord)
    };
};
```

When using executable assemblies, the handler string that tells Lambda how to run your code is the name of the assembly. In this example, that would be `GetProductHandler`.

Serialization in Lambda functions

If your Lambda function uses input or output types other than a `Stream` object, you must add a serialization library to your application. You can implement serialization either using the standard reflection based serialization provided by `System.Text.Json` and `Newtonsoft.Json`, or by using [source generated serialization](#).

Using source generated serialization

Source generated serialization is a feature of .NET versions 6 and later that allows serialization code to be generated at compile time. It removes the need for reflection and can improve the performance of your function. To use source generated serialization in your function, do the following:

- Create a new partial class that inherits from `JsonSerializerContext`, adding `JsonSerializable` attributes for all types that require serialization or deserialization.

- Configure the `LambdaSerializer` to use a `SourceGeneratorLambdaJsonSerializer<T>`.
- Update any manual serialization or deserialization in your application code to use the newly created class.

An example function using source generated serialization is shown in the following code.

```
[assembly:
    LambdaSerializer(typeof(SourceGeneratorLambdaJsonSerializer<CustomSerializer>))]

public class Function
{
    private readonly IDatabaseRepository _repo;

    public Function()
    {
        this._repo = new DatabaseRepository();
    }

    public async Task<APIGatewayProxyResponse> FunctionHandler(APIGatewayProxyRequest
request)
    {
        var id = request.PathParameters["id"];

        var databaseRecord = await this._repo.GetById(id);

        return new APIGatewayProxyResponse
        {
            StatusCode = (int)HttpStatusCode.OK,
            Body = JsonSerializer.Serialize(databaseRecord,
CustomSerializer.Default.Product)
        };
    }
}

[JsonSerializable(typeof(APIGatewayProxyRequest))]
[JsonSerializable(typeof(APIGatewayProxyResponse))]
[JsonSerializable(typeof(Product))]
public partial class CustomSerializer : JsonSerializerContext
{
}
```

Note

If you want to use native ahead of time compilation (AOT) with Lambda, you must use source generated serialization.

Using reflection-based serialization

AWS provides pre-built libraries to let you quickly add serialization to your application. You configure this using either the `Amazon.Lambda.Serialization.SystemTextJson` or `Amazon.Lambda.Serialization.Json` NuGet packages. Behind the scenes, `Amazon.Lambda.Serialization.SystemTextJson` uses `System.Text.Json` to perform serialization tasks, and `Amazon.Lambda.Serialization.Json` uses the `Newtonsoft.Json` package.

You can also create your own serialization library by implementing the `ILambdaSerializer` interface, which is available as part of the `Amazon.Lambda.Core` library. This interface defines two methods:

- `T Deserialize<T>(Stream requestStream);`

You implement this method to deserialize the request payload from the Invoke API into the object that is passed to your Lambda function handler.

- `T Serialize<T>(T response, Stream responseStream);`

You implement this method to serialize the result returned from your Lambda function handler into the response payload that the Invoke API operation returns.

Simplify function code with the Lambda Annotations framework

[Lambda Annotations](#) is a framework for .NET 8 which simplifies writing Lambda functions using C#. With the Annotations framework, you can replace much of the code in a Lambda function written using the regular programming model. Code written using the framework uses simpler expressions that allow you to focus on your business logic.

The following example code shows how using the annotations framework can simplify writing Lambda functions. The first example shows code written using the regular Lambda program model, and the second shows the equivalent using the Annotations framework.

```
public APIGatewayHttpApiV2ProxyResponse LambdaMathAdd(APIGatewayHttpApiV2ProxyRequest
    request, ILambdaContext context)
{
    if (!request.PathParameters.TryGetValue("x", out var xs))
    {
        return new APIGatewayHttpApiV2ProxyResponse
        {
            StatusCode = (int)HttpStatusCode.BadRequest
        };
    }
    if (!request.PathParameters.TryGetValue("y", out var ys))
    {
        return new APIGatewayHttpApiV2ProxyResponse
        {
            StatusCode = (int)HttpStatusCode.BadRequest
        };
    }
    var x = int.Parse(xs);
    var y = int.Parse(ys);
    return new APIGatewayHttpApiV2ProxyResponse
    {
        StatusCode = (int)HttpStatusCode.OK,
        Body = (x + y).ToString(),
        Headers = new Dictionary<string, string> { { "Content-Type", "text/plain" } }
    };
}
```

```
[LambdaFunction]
[HttpApi(LambdaHttpMethod.Get, "/add/{x}/{y}")]
public int Add(int x, int y)
{
    return x + y;
}
```

For another example of how using Lambda Annotations can simplify your code, see this [cross-service example application](#) in the `awsdocs/aws-doc-sdk-examples` GitHub repository. The folder `PamApiAnnotations` uses Lambda Annotations in the `main function.cs` file. For comparison, the `PamApi` folder has equivalent files written using the regular Lambda programming model.

The Annotations framework uses [source generators](#) to generate code that translates from the Lambda programming model to the code seen in the second example.

For more information about how to use Lambda Annotations for .NET, see the following resources:

- The [aws/aws-lambda-dotnet](#) GitHub repository.
- [Introducing .NET Annotations Lambda Framework \(Preview\)](#) on the AWS Developer Tools Blog.
- The [Amazon.Lambda.Annotations](#) NuGet package.

Dependency injection with Lambda Annotations framework

You can also use the Lambda Annotations framework to add dependency injection to your Lambda functions using syntax you are familiar with. When you add a `[LambdaStartup]` attribute to a `Startup.cs` file, the Lambda Annotations framework will generate the required code at compile time.

```
[LambdaStartup]
public class Startup
{
    public void ConfigureServices(IServiceCollection services)
    {
        services.AddSingleton<IDatabaseRepository, DatabaseRepository>();
    }
}
```

Your Lambda function can inject services using either constructor injection or by injecting into individual methods using the `[FromServices]` attribute.

```
[assembly:
    LambdaSerializer(typeof(Amazon.Lambda.Serialization.SystemTextJson.DefaultLambdaJsonSerializer))

namespace GetProductHandler;

public class Function
{
    private readonly IDatabaseRepository _repo;

    public Function(IDatabaseRepository repo)
    {
```

```
        this._repo = repo;
    }

    [LambdaFunction]
    [HttpApi(LambdaHttpMethod.Get, "/product/{id}")]
    public async Task<Product> FunctionHandler([FromServices] IDatabaseRepository
repository, string id)
    {
        return await this._repo.GetById(id);
    }
}
```

Lambda function handler restrictions

Note that there are some restrictions on the handler signature.

- It may not be unsafe and use pointer types in the handler signature, though you can use unsafe context inside the handler method and its dependencies. For more information, see [unsafe \(C# Reference\)](#) on the Microsoft Docs website.
- It may not pass a variable number of parameters using the `params` keyword, or use `ArgIterator` as an input or a return parameter, which is used to support a variable number of parameters.
- The handler may not be a generic method, for example, `IList<T> Sort<T>(IList<T> input)`.
- Async handlers with signature `async void` are not supported.

Code best practices for C# Lambda functions

Adhere to the guidelines in the following list to use best coding practices when building your Lambda functions:

- **Separate the Lambda handler from your core logic.** This allows you to make a more unit-testable function.
- **Control the dependencies in your function's deployment package.** The AWS Lambda execution environment contains a number of libraries. To enable the latest set of features and security updates, Lambda will periodically update these libraries. These updates may introduce subtle changes to the behavior of your Lambda function. To have full control of the dependencies your function uses, package all of your dependencies with your deployment package.

- **Minimize the complexity of your dependencies.** Prefer simpler frameworks that load quickly on [execution environment](#) startup.
- **Minimize your deployment package size to its runtime necessities.** This will reduce the amount of time that it takes for your deployment package to be downloaded and unpacked ahead of invocation. For functions authored in .NET, avoid uploading the entire AWS SDK library as part of your deployment package. Instead, selectively depend on the modules which pick up components of the SDK you need (e.g. DynamoDB, Amazon S3 SDK modules and Lambda core libraries).
- **Take advantage of execution environment reuse to improve the performance of your function.** Initialize SDK clients and database connections outside of the function handler, and cache static assets locally in the /tmp directory. Subsequent invocations processed by the same instance of your function can reuse these resources. This saves cost by reducing function run time.

To avoid potential data leaks across invocations, don't use the execution environment to store user data, events, or other information with security implications. If your function relies on a mutable state that can't be stored in memory within the handler, consider creating a separate function or separate versions of a function for each user.

- **Use a keep-alive directive to maintain persistent connections.** Lambda purges idle connections over time. Attempting to reuse an idle connection when invoking a function will result in a connection error. To maintain your persistent connection, use the keep-alive directive associated with your runtime. For an example, see [Reusing Connections with Keep-Alive in Node.js](#).
- **Use [environment variables](#) to pass operational parameters to your function.** For example, if you are writing to an Amazon S3 bucket, instead of hard-coding the bucket name you are writing to, configure the bucket name as an environment variable.
- **Avoid using recursive invocations** in your Lambda function, where the function invokes itself or initiates a process that may invoke the function again. This could lead to unintended volume of function invocations and escalated costs. If you see an unintended volume of invocations, set the function reserved concurrency to 0 immediately to throttle all invocations to the function, while you update the code.
- **Do not use non-documented, non-public APIs** in your Lambda function code. For AWS Lambda managed runtimes, Lambda periodically applies security and functional updates to Lambda's internal APIs. These internal API updates may be backwards-incompatible, leading to unintended

consequences such as invocation failures if your function has a dependency on these non-public APIs. See [the API reference](#) for a list of publicly available APIs.

- **Write idempotent code.** Writing idempotent code for your functions ensures that duplicate events are handled the same way. Your code should properly validate events and gracefully handle duplicate events. For more information, see [How do I make my Lambda function idempotent?](#).

Build and deploy C# Lambda functions with .zip file archives

A .NET deployment package (.zip file archive) contains your function's compiled assembly along with all of its assembly dependencies. The package also contains a `proj.deps.json` file. This signals to the .NET runtime all of your function's dependencies and a `proj.runtimeconfig.json` file, which is used to configure the runtime.

To deploy individual Lambda functions, you can use the `Amazon.Lambda.Tools` .NET Lambda Global CLI. Using the `dotnet lambda deploy-function` command automatically creates a .zip deployment package and deploys it to Lambda. However, we recommend that you use frameworks like the AWS Serverless Application Model (AWS SAM) or the AWS Cloud Development Kit (AWS CDK) to deploy your .NET applications to AWS.

Serverless applications usually comprise a combination of Lambda functions and other managed AWS services working together to perform a particular business task. AWS SAM and AWS CDK simplify building and deploying Lambda functions with other AWS services at scale. The [AWS SAM template specification](#) provides a simple and clean syntax to describe Lambda functions, APIs, permissions, configurations, and other AWS resources that make up your serverless application. With the [AWS CDK](#) you define cloud infrastructure as code to help you build reliable, scalable, cost-effective applications in the cloud using modern programming languages and frameworks like .NET. Both the AWS CDK and the AWS SAM use the .NET Lambda Global CLI to package your functions.

While it's possible to use [Lambda layers](#) with functions in C# by [using the .NET Core CLI](#), we recommend against it. Functions in C# that use layers manually load the shared assemblies into memory during the [Init phase](#), which can increase cold start times. Instead, include all shared code at compile time to take advantage of the built-in optimizations of the .NET compiler.

You can find instructions for building and deploying .NET Lambda functions using the AWS SAM, the AWS CDK, and the .NET Lambda Global CLI in the following sections.

Topics

- [Using the .NET Lambda Global CLI](#)
- [Deploy C# Lambda functions using AWS SAM](#)
- [Deploy C# Lambda functions using AWS CDK](#)
- [Deploy ASP.NET applications](#)

Using the .NET Lambda Global CLI

The .NET CLI and the .NET Lambda Global Tools extension (`Amazon.Lambda.Tools`) offer a cross-platform way to create .NET-based Lambda applications, package them, and deploy them to Lambda. In this section, you learn how to create new Lambda .NET projects using the .NET CLI and Amazon Lambda templates, and to package and deploy them using `Amazon.Lambda.Tools`

Topics

- [Prerequisites](#)
- [Creating .NET projects using the .NET CLI](#)
- [Deploying .NET projects using the .NET CLI](#)
- [Using Lambda layers with the .NET CLI](#)

Prerequisites

.NET 8 SDK

If you haven't already done so, install the [.NET 8](#) SDK and Runtime.

AWS `Amazon.Lambda.Templates` .NET project templates

To generate your Lambda function code, use the [Amazon.Lambda.Templates](#) NuGet package. To install this template package, run the following command:

```
dotnet new install Amazon.Lambda.Templates
```

AWS `Amazon.Lambda.Tools` .NET Global CLI tools

To create your Lambda functions, you use the [Amazon.Lambda.Tools .NET Global Tools extension](#). To install `Amazon.Lambda.Tools`, run the following command:

```
dotnet tool install -g Amazon.Lambda.Tools
```

For more information about the `Amazon.Lambda.Tools` .NET CLI extension, see the [AWS Extensions for .NET CLI](#) repository on GitHub.

Creating .NET projects using the .NET CLI

In the .NET CLI, you use the `dotnet new` command to create .NET projects from the command line. Lambda offers additional templates using the [Amazon.Lambda.Templates](#) NuGet package.

After installing this package, run the following command to see a list of the available templates.

```
dotnet new list
```

To examine details about a template, use the `help` option. For example, to see details about the `lambda.EmptyFunction` template, run the following command.

```
dotnet new lambda.EmptyFunction --help
```

To create a basic template for a .NET Lambda function, use the `lambda.EmptyFunction` template. This creates a simple function that takes a string as input and converts it to upper case using the `ToUpper` method. This template supports the following options:

- `--name` – The name of the function.
- `--region` – The AWS Region to create the function in.
- `--profile` – The name of a profile in your AWS SDK for .NET credentials file. To learn more about credential profiles in .NET, see [Configure AWS credentials](#) in the *AWS SDK for .NET Developer Guide*.

In this example, we create a new empty function named `myDotnetFunction` using the default profile and AWS Region settings:

```
dotnet new lambda.EmptyFunction --name myDotnetFunction
```

This command creates the following files and directories in your project directory.

```
### myDotnetFunction
### src
#   ### myDotnetFunction
#   ### Function.cs
#   ### Readme.md
#   ### aws-lambda-tools-defaults.json
#   ### myDotnetFunction.csproj
```

```
### test
### myDotnetFunction.Tests
### FunctionTest.cs
### myDotnetFunction.Tests.csproj
```

Under the `src/myDotnetFunction` directory, examine the following files:

- **aws-lambda-tools-defaults.json:** This is where you specify the command line options when deploying your Lambda function. For example:

```
"profile" : "default",
"region" : "us-east-2",
"configuration" : "Release",
"function-architecture": "x86_64",
"function-runtime":"dotnet8",
"function-memory-size" : 256,
"function-timeout" : 30,
"function-handler" : "myDotnetFunction::myDotnetFunction.Function::FunctionHandler"
```

- **Function.cs:** Your Lambda handler function code. It's a C# template that includes the default `Amazon.Lambda.Core` library and a default `LambdaSerializer` attribute. For more information on serialization requirements and options, see [Serialization in Lambda functions](#). It also includes a sample function that you can edit to apply your Lambda function code.

```
using Amazon.Lambda.Core;

// Assembly attribute to enable the Lambda function's JSON input to be converted into
// a .NET class.
[assembly:
    LambdaSerializer(typeof(Amazon.Lambda.Serialization.SystemTextJson.DefaultLambdaJsonSerializer))]

namespace myDotnetFunction;

public class Function
{
    /// <summary>
    /// A simple function that takes a string and does a ToUpper
    /// </summary>
    /// <param name="input"></param>
    /// <param name="context"></param>
    /// <returns></returns>
}
```

```
public string FunctionHandler(string input, ILambdaContext context)
{
    return input.ToUpper();
}
}
```

- **myDotnetFunction.csproj:** An [MSBuild](#) file that lists the files and assemblies that comprise your application.

```
<Project Sdk="Microsoft.NET.Sdk">
  <PropertyGroup>
    <TargetFramework>net8.0</TargetFramework>
    <ImplicitUsings>enable</ImplicitUsings>
    <Nullable>enable</Nullable>
    <GenerateRuntimeConfigurationFiles>true</GenerateRuntimeConfigurationFiles>
    <AWSProjectType>Lambda</AWSProjectType>
    <!-- This property makes the build directory similar to a publish directory and
helps the AWS .NET Lambda Mock Test Tool find project dependencies. -->
    <CopyLocalLockFileAssemblies>true</CopyLocalLockFileAssemblies>
    <!-- Generate ready to run images during publishing to improve cold start time.
-->
    <PublishReadyToRun>true</PublishReadyToRun>
  </PropertyGroup>
  <ItemGroup>
    <PackageReference Include="Amazon.Lambda.Core" Version="2.2.0" />
    <PackageReference Include="Amazon.Lambda.Serialization.SystemTextJson"
Version="2.4.0" />
  </ItemGroup>
</Project>
```

- **Readme:** Use this file to document your Lambda function.

Under the myfunction/test directory, examine the following files:

- **myDotnetFunction.Tests.csproj:** As noted previously, this is an [MSBuild](#) file that lists the files and assemblies that comprise your test project. Note also that it includes the `Amazon.Lambda.Core` library, so you can seamlessly integrate any Lambda templates required to test your function.

```
<Project Sdk="Microsoft.NET.Sdk">
  ...
```

```
<PackageReference Include="Amazon.Lambda.Core" Version="2.2.0" />
...
```

- **FunctionTest.cs:** The same C# code template file that it is included in the `src` directory. Edit this file to mirror your function's production code and test it before uploading your Lambda function to a production environment.

```
using Xunit;
using Amazon.Lambda.Core;
using Amazon.Lambda.TestUtilities;

using MyFunction;

namespace MyFunction.Tests
{
    public class FunctionTest
    {
        [Fact]
        public void TestToUpperFunction()
        {
            // Invoke the lambda function and confirm the string was upper cased.
            var function = new Function();
            var context = new TestLambdaContext();
            var upperCase = function.FunctionHandler("hello world", context);

            Assert.Equal("HELLO WORLD", upperCase);
        }
    }
}
```

Deploying .NET projects using the .NET CLI

To build your deployment package and deploy it to Lambda, you use the `Amazon.Lambda.Tools` CLI tools. To deploy your function from the files you created in the previous steps, first navigate into the folder containing your function's `.csproj` file.

```
cd myDotnetFunction/src/myDotnetFunction
```

To deploy your code to Lambda as a `.zip` deployment package, run the following command. Choose your own function name.

```
dotnet lambda deploy-function myDotnetFunction
```

During the deployment, the wizard asks you to select a [the section called “Execution role \(permissions for functions to access other resources\)”](#). For this example, select the `lambda_basic_role`.

After you have deployed your function, you can test it in the cloud using the `dotnet lambda invoke-function` command. For the example code in the `lambda.EmptyFunction` template, you can test your function by passing in a string using the `--payload` option.

```
dotnet lambda invoke-function myDotnetFunction --payload "Just checking if everything is OK"
```

If your function has been successfully deployed, you should see output similar to the following.

```
dotnet lambda invoke-function myDotnetFunction --payload "Just checking if everything is OK"
Amazon Lambda Tools for .NET Core applications (5.8.0)
Project Home: https://github.com/aws/aws-extensions-for-dotnet-cli, https://github.com/aws/aws-lambda-dotnet

Payload:
"JUST CHECKING IF EVERYTHING IS OK"

Log Tail:
START RequestId: id Version: $LATEST
END RequestId: id
REPORT RequestId: id Duration: 0.99 ms          Billed Duration: 1 ms          Memory
Size: 256 MB          Max Memory Used: 12 MB
```

Using Lambda layers with the .NET CLI

Note

Using layers with functions in a compiled language like C# may not provide the same amount of benefit as with an interpreted language like Python. Since C# is a compiled language, your functions still have to manually load any shared assemblies into memory during the init phase, which can increase cold start times. Instead, we recommend including any shared code at compile time to take advantage of any built-in compiler optimizations.

The .NET CLI supports commands to help you publish layers and deploy C# functions that consume layers. To publish a layer to a specified Amazon S3 bucket, run the following command in the same directory as your `.csproj` file:

```
dotnet lambda publish-layer <layer_name> --layer-type runtime-package-store --s3-bucket <s3_bucket_name>
```

Then, when you deploy your function using the .NET CLI, specify the layer ARN the consume in the following command:

```
dotnet lambda deploy-function <function_name> --function-layers arn:aws:lambda:us-east-1:123456789012:layer:layer-name:1
```

For a complete example of a Hello World function, see the [blank-csharp-with-layer](#) sample.

Deploy C# Lambda functions using AWS SAM

The AWS Serverless Application Model (AWS SAM) is a toolkit that helps streamline the process of building and running serverless applications on AWS. You define the resources for your application in a YAML or JSON template and use the AWS SAM command line interface (AWS SAM CLI) to build, package, and deploy your applications. When you build a Lambda function from an AWS SAM template, AWS SAM automatically creates a .zip deployment package or container image with your function code and any dependencies you specify. AWS SAM then deploys your function using an [AWS CloudFormation stack](#). To learn more about using AWS SAM to build and deploy Lambda functions, see [Getting started with AWS SAM](#) in the *AWS Serverless Application Model Developer Guide*.

The following steps show you how to download, build, and deploy a sample .NET Hello World application using AWS SAM. This sample application uses a Lambda function and an Amazon API Gateway endpoint to implement a basic API backend. When you send an HTTP GET request to your API Gateway endpoint, API Gateway invokes your Lambda function. The function returns a "hello world" message, along with the IP address of the Lambda function instance that processes your request.

When you build and deploy your application using AWS SAM, behind the scenes the AWS SAM CLI uses the `dotnet lambda package` command to package the individual Lambda function code bundles.

Prerequisites

.NET 8 SDK

Install the [.NET 8 SDK](#) and Runtime.

AWS SAM CLI version 1.39 or later

To learn how to install the latest version of the AWS SAM CLI, see [Installing the AWS SAM CLI](#).

Deploy a sample AWS SAM application

1. Initialize the application using the Hello world .NET template using the following command.

```
sam init --app-template hello-world --name sam-app \  
--package-type Zip --runtime dotnet8
```

This command creates the following files and directories in your project directory.

```
### sam-app  
  ### README.md  
  ### events  
  #   ### event.json  
  ### omnisharp.json  
  ### samconfig.toml  
  ### src  
  #   ### HelloWorld  
  #     ### Function.cs  
  #     ### HelloWorld.csproj  
  #     ### aws-lambda-tools-defaults.json  
  ### template.yaml  
  ### test  
    ### HelloWorld.Test  
    ### FunctionTest.cs  
    ### HelloWorld.Tests.csproj
```

2. Navigate into the directory containing the `template.yaml` file. This file is a template that defines the AWS resources for your application, including your Lambda function and an API Gateway API.

```
cd sam-app
```

3. To build the source of your application, run the following command.

```
sam build
```

4. To deploy your application to AWS, run the following command.

```
sam deploy --guided
```

This command packages and deploys your application with the following series of prompts. To accept the default options, press Enter.

 **Note**

For **HelloWorldFunction may not have authorization defined, is this okay?**, be sure to enter y.

- **Stack Name:** The name of the stack to deploy to AWS CloudFormation. This name must be unique to your AWS account and AWS Region.
 - **AWS Region:** The AWS Region you want to deploy your app to.
 - **Confirm changes before deploy:** Select yes to manually review any change sets before AWS SAM deploys application changes. If you select no, the AWS SAM CLI automatically deploys application changes.
 - **Allow SAM CLI IAM role creation:** Many AWS SAM templates, including the Hello world one in this example, create AWS Identity and Access Management (IAM) roles to give your Lambda functions permission to access other AWS services. Select Yes to provide permission to deploy a AWS CloudFormation stack that creates or modifies IAM roles.
 - **Disable rollback:** By default, if AWS SAM encounters an error during creation or deployment of your stack, it rolls the stack back to the previous version. Select No to accept this default.
 - **HelloWorldFunction may not have authorization defined, is this okay:** Enter y.
 - **Save arguments to samconfig.toml:** Select yes to save your configuration choices. In the future, you can re-run `sam deploy` without parameters to deploy changes to your application.
5. When the deployment of your application is complete, the CLI returns the Amazon Resource Name (ARN) of the Hello World Lambda function and the IAM role created for it. It also

displays the endpoint of your API Gateway API. To test your application, open the endpoint in a browser. You should see a response similar to the following.

```
{"message":"hello world","location":"34.244.135.203"}
```

6. To delete your resources, run the following command. Note that the API endpoint you created is a public endpoint accessible over the internet. We recommend that you delete this endpoint after testing.

```
sam delete
```

Next steps

To learn more about using AWS SAM to build and deploy Lambda functions using .NET, see the following resources:

- The [AWS Serverless Application Model \(AWS SAM\) Developer Guide](#)
- [Building Serverless .NET Applications with AWS Lambda and the SAM CLI](#)

Deploy C# Lambda functions using AWS CDK

The AWS Cloud Development Kit (AWS CDK) is an open-source software development framework for defining cloud infrastructure as code with modern programming languages and frameworks like .NET. AWS CDK projects are executed to generate AWS CloudFormation templates which are then used to deploy your code.

To build and deploy an example Hello world .NET application using the AWS CDK, follow the instructions in the following sections. The sample application implements a basic API backend consisting of an API Gateway endpoint and a Lambda function. API Gateway invokes the Lambda function when you send an HTTP GET request to the endpoint. The function returns a Hello world message, along with the IP address of the Lambda instance that processes your request.

Prerequisites

.NET 8 SDK

Install the [.NET 8](#) SDK and Runtime.

AWS CDK version 2

To learn how to install the latest version of the AWS CDK see [Getting started with the AWS CDK](#) in the *AWS Cloud Development Kit (AWS CDK) v2 Developer Guide*.

Deploy a sample AWS CDK application

1. Create a project directory for the sample application and navigate into it.

```
mkdir hello-world
cd hello-world
```

2. Initialize a new AWS CDK application by running the following command.

```
cdk init app --language csharp
```

The command creates the following files and directories in your project directory

```
### README.md
### cdk.json
### src
  ### HelloWorld
  #   ### GlobalSuppressions.cs
  #   ### HelloWorld.csproj
  #   ### HelloWorldStack.cs
  #   ### Program.cs
  ### HelloWorld.sln
```

3. Open the `src` directory and create a new Lambda function using the .NET CLI. This is the function you will deploy using the AWS CDK. In this example, you create a Hello world function named `HelloWorldLambda` using the `lambda.EmptyFunction` template.

```
cd src
dotnet new lambda.EmptyFunction -n HelloWorldLambda
```

After this step, your directory structure inside your project directory should look like the following.

```
### README.md
### cdk.json
```

```

### src
### HelloWorld
#   ### GlobalSuppressions.cs
#   ### HelloWorld.csproj
#   ### HelloWorldStack.cs
#   ### Program.cs
### HelloWorld.sln
### HelloWorldLambda
    ### src
    #   ### HelloWorldLambda
    #   ### Function.cs
    #   ### HelloWorldLambda.csproj
    #   ### Readme.md
    #   ### aws-lambda-tools-defaults.json
    ### test
        ### HelloWorldLambda.Tests
        ### FunctionTest.cs
        ### HelloWorldLambda.Tests.csproj

```

4. Open the `HelloWorldStack.cs` file from the `src/HelloWorld` directory. Replace the contents of the file with the following code.

```

using Amazon.CDK;
using Amazon.CDK.AWS.Lambda;
using Amazon.CDK.AWS.Logs;
using Constructs;

namespace CdkTest
{
    public class HelloWorldStack : Stack
    {
        internal HelloWorldStack(Construct scope, string id, IStackProps props =
null) : base(scope, id, props)
        {
            var buildOption = new BundlingOptions()
            {
                Image = Runtime.DOTNET_8.BundlingImage,
                User = "root",
                OutputType = BundlingOutput.ARCHIVED,
                Command = new string[]{
"/bin/sh",
"-c",
"dotnet tool install -g Amazon.Lambda.Tools"+

```

```
        " && dotnet build"+
        " && dotnet lambda package --output-package /asset-output/
function.zip"
    }
};

    var helloWorldLambdaFunction = new Function(this,
"HelloWorldFunction", new FunctionProps
    {
        Runtime = Runtime.DOTNET_8,
        MemorySize = 1024,
        LogRetention = RetentionDays.ONE_DAY,
        Handler =
"HelloWorldLambda::HelloWorldLambda.Function::FunctionHandler",
        Code = Code.FromAsset("./src/HelloWorldLambda/src/
HelloWorldLambda", new Amazon.CDK.AWS.S3.Assets.AssetOptions
            {
                Bundling = buildOption
            }
        )),
    });
}
}
```

This is the code to compile and bundle the application code, as well as the definition of the Lambda function itself. The `BundlingOptions` object allows a zip file to be created, along with a set of commands that are used to generate the contents of the zip file. In this instance, the `dotnet lambda package` command is used to compile and generate the zip file.

5. To deploy your application, run the following command.

```
cdk deploy
```

6. Invoke your deployed Lambda function using the .NET Lambda CLI.

```
dotnet lambda invoke-function HelloWorldFunction -p "hello world"
```

7. After you've finished testing, you can delete the resources you created, unless you want to retain them. Run the following command to delete your resources.

```
cdk destroy
```

Next steps

To learn more about using AWS CDK to build and deploy Lambda functions using .NET, see the following resources:

- [Working with the AWS CDK in C#](#)
- [Build, package, and publish .NET C# Lambda functions with the AWS CDK](#)

Deploy ASP.NET applications

As well as hosting event-driven functions, you can also use .NET with Lambda to host lightweight ASP.NET applications. You can build and deploy ASP.NET applications using the `Amazon.Lambda.AspNetCoreServer` NuGet package. In this section, you learn how to deploy an ASP.NET web API to Lambda using the .NET Lambda CLI tooling.

Topics

- [Prerequisites](#)
- [Deploying an ASP.NET Web API to Lambda](#)
- [Deploying ASP.NET minimal APIs to Lambda](#)

Prerequisites

.NET 8 SDK

Install the [.NET 8](#) SDK and ASP.NET Core Runtime.

Amazon.Lambda.Tools

To create your Lambda functions, you use the [Amazon.Lambda.Tools .NET Global Tools extension](#). To install `Amazon.Lambda.Tools`, run the following command:

```
dotnet tool install -g Amazon.Lambda.Tools
```

For more information about the `Amazon.Lambda.Tools` .NET CLI extension, see the [AWS Extensions for .NET CLI](#) repository on GitHub.

Amazon.Lambda.Templates

To generate your Lambda function code, use the [Amazon.Lambda.Templates](#) NuGet package. To install this template package, run the following command:

```
dotnet new --install Amazon.Lambda.Templates
```

Deploying an ASP.NET Web API to Lambda

To deploy a web API using ASP.NET, you can use the .NET Lambda templates to create a new web API project. Use the following command to initialize a new ASP.NET web API project. In the example command, we name the project `AspNetOnLambda`.

```
dotnet new serverless.AspNetCoreWebAPI -n AspNetOnLambda
```

This command creates the following files and directories in your project directory.

```
.
### AspNetOnLambda
  ### src
  #   ### AspNetOnLambda
  #     ### AspNetOnLambda.csproj
  #     ### Controllers
  #     #   ### ValuesController.cs
  #     ### LambdaEntryPoint.cs
  #     ### LocalEntryPoint.cs
  #     ### Readme.md
  #     ### Startup.cs
  #     ### appsettings.Development.json
  #     ### appsettings.json
  #     ### aws-lambda-tools-defaults.json
  #     ### serverless.template
  ### test
    ### AspNetOnLambda.Tests
    ### AspNetOnLambda.Tests.csproj
    ### SampleRequests
    #   ### ValuesController-Get.json
    ### ValuesControllerTests.cs
    ### appsettings.json
```

When Lambda invokes your function, the entry point it uses is the `LambdaEntryPoint.cs` file. The file created by the .NET Lambda template contains the following code.

```
namespace AspNetOnLambda;
```



```
public class LambdaEntryPoint : Amazon.Lambda.AspNetCoreServer.APIGatewayProxyFunction
{
    protected override void Init(IWebHostBuilder builder)
    {
        builder
            .UseStartup#Startup#();
    }

    protected override void Init(IHostBuilder builder)
    {
    }
}
```

The entry point used by Lambda must inherit from one of the three base classes in the `Amazon.Lambda.AspNetCoreServer` package. These three base classes are:

- `APIGatewayProxyFunction`
- `APIGatewayHttpApiV2ProxyFunction`
- `ApplicationLoadBalancerFunction`

The default class used when you create your `LambdaEntryPoint.cs` file using the provided .NET Lambda template is `APIGatewayProxyFunction`. The base class you use in your function depends on which API layer sits in front of your Lambda function.

Each of the three base classes contains a public method named `FunctionHandlerAsync`. The name of this method will form part of the [handler string](#) Lambda uses to invoke your function. The `FunctionHandlerAsync` method transforms the inbound event payload into the correct ASP.NET format and the ASP.NET response back to a Lambda response payload. For the example `AspNetOnLambda` project shown, the handler string would be as follows.

```
AspNetOnLambda::AspNetOnLambda.LambdaEntryPoint::FunctionHandlerAsync
```

To deploy the API to Lambda, run the following commands to navigate into the directory containing your source code file and deploy your function using AWS CloudFormation.

```
cd AspNetOnLambda/src/AspNetOnLambda
dotnet lambda deploy-serverless
```

Tip

When you deploy an API using the **dotnet lambda deploy-serverless** command, AWS CloudFormation gives your Lambda function a name based on the stack name you specify during the deployment. To give your Lambda function a custom name, edit the `serverless.template` file to add a `FunctionName` property to the `AWS::Serverless::Function` resource. See [Name type](#) in the *AWS CloudFormation User Guide* to learn more.

Deploying ASP.NET minimal APIs to Lambda

To deploy an ASP.NET minimal API to Lambda, you can use the .NET Lambda templates to create a new minimal API project. Use the following command to initialize a new minimal API project. In this example, we name the project `MinimalApiOnLambda`.

```
dotnet new serverless.AspNetCoreMinimalAPI -n MinimalApiOnLambda
```

The command creates the following files and directories in your project directory.

```
### MinimalApiOnLambda
### src
### MinimalApiOnLambda
### Controllers
# ### CalculatorController.cs
### MinimalApiOnLambda.csproj
### Program.cs
### Readme.md
### appsettings.Development.json
### appsettings.json
### aws-lambda-tools-defaults.json
### serverless.template
```

The `Program.cs` file contains the following code.

```
var builder = WebApplication.CreateBuilder(args);

// Add services to the container.
builder.Services.AddControllers();
```

```
// Add AWS Lambda support. When application is run in Lambda Kestrel is swapped out as
// the web server with Amazon.Lambda.AspNetCoreServer. This
// package will act as the webserver translating request and responses between the
// Lambda event source and ASP.NET Core.
builder.Services.AddAWSLambdaHosting(LambdaEventSource.RestApi);

var app = builder.Build();

app.UseHttpsRedirection();
app.UseAuthorization();
app.MapControllers();

app.MapGet("/", () => "Welcome to running ASP.NET Core Minimal API on AWS Lambda");

app.Run();
```

To configure your minimal API to run on Lambda, you may need to edit this code so that requests and responses between Lambda and ASP.NET Core are properly translated. By default, the function is configured for a REST API event source. For an HTTP API or application load balancer, replace (*LambdaEventSource.RestApi*) with one of the following options:

- (*LambdaEventSource.HttpApi*)
- (*LambdaEventSource.ApplicationLoadBalancer*)

To deploy your minimal API to Lambda, run the following commands to navigate into the directory containing your source code file and deploy your function using AWS CloudFormation.

```
cd MinimalApiOnLambda/src/MinimalApiOnLambda
dotnet lambda deploy-serverless
```

Deploy .NET Lambda functions with container images

There are three ways to build a container image for a .NET Lambda function:

- [Using an AWS base image for .NET](#)

The [AWS base images](#) are preloaded with a language runtime, a runtime interface client to manage the interaction between Lambda and your function code, and a runtime interface emulator for local testing.

- [Using an AWS OS-only base image](#)

[AWS OS-only base images](#) contain an Amazon Linux distribution and the [runtime interface emulator](#). These images are commonly used to create container images for compiled languages, such as [Go](#) and [Rust](#), and for a language or language version that Lambda doesn't provide a base image for, such as Node.js 19. You can also use OS-only base images to implement a [custom runtime](#). To make the image compatible with Lambda, you must include the [the runtime interface client for .NET](#) in the image.

- [Using a non-AWS base image](#)

You can use an alternative base image from another container registry, such as Alpine Linux or Debian. You can also use a custom image created by your organization. To make the image compatible with Lambda, you must include the [the runtime interface client for .NET](#) in the image.

Tip

To reduce the time it takes for Lambda container functions to become active, see [Use multi-stage builds](#) in the Docker documentation. To build efficient container images, follow the [Best practices for writing Dockerfiles](#).

This page explains how to build, test, and deploy container images for Lambda.

Topics

- [AWS base images for .NET](#)
- [Using an AWS base image for .NET](#)
- [Using an alternative base image with the runtime interface client](#)

AWS base images for .NET

AWS provides the following base images for .NET:

Tags	Runtime	Operating system	Dockerfile	Deprecation
8	.NET 8	Amazon Linux 2023	Dockerfile for .NET 8 on GitHub	Not scheduled

Amazon ECR repository: gallery.ecr.aws/lambda/dotnet

Using an AWS base image for .NET

Prerequisites

To complete the steps in this section, you must have the following:

- [.NET SDK](#) – The following steps use the .NET 8 base image. Make sure that your .NET version matches the version of the [base image](#) that you specify in your Dockerfile.
- [Docker](#)

Creating and deploying an image using a base image

In the following steps, you use [Amazon.Lambda.Templates](#) and [Amazon.Lambda.Tools](#) to create a .NET project. Then, you build a Docker image, upload the image to Amazon ECR, and deploy it to a Lambda function.

1. Install the [Amazon.Lambda.Templates](#) NuGet package.

```
dotnet new install Amazon.Lambda.Templates
```

2. Create a .NET project using the `lambda.image.EmptyFunction` template.

```
dotnet new lambda.image.EmptyFunction --name MyFunction --region us-east-1
```

3. Navigate to the `MyFunction/src/MyFunction` directory. This is where the project files are stored. Examine the following files:

- **aws-lambda-tools-defaults.json** – This file is where you specify the command line options when deploying your Lambda function.
 - **Function.cs** – Your Lambda handler function code. This is a C# template that includes the default `Amazon.Lambda.Core` library and a default `LambdaSerializer` attribute. For more information about serialization requirements and options, see [Serialization in Lambda functions](#). You can use the provided code for testing, or replace it with your own.
 - **MyFunction.csproj** – A .NET [project file](#), which lists the files and assemblies that comprise your application.
 - **Readme.md** – This file contains more information about the sample Lambda function.
4. Examine the Dockerfile in the `src/MyFunction` directory. You can use the provided Dockerfile for testing, or replace it with your own. If you use your own, make sure to:
- Set the FROM property to the [URI of the base image](#). Your .NET version must match the version of the base image.
 - Set the CMD argument to the Lambda function handler. This should match the `image-command` in `aws-lambda-tools-defaults.json`.

Note that the example Dockerfile does not include a [USER instruction](#). When you deploy a container image to Lambda, Lambda automatically defines a default Linux user with least-privileged permissions. This is different from standard Docker behavior which defaults to the root user when no USER instruction is provided.

Example Dockerfile

```
# You can also pull these images from DockerHub amazon/aws-lambda-dotnet:8
FROM public.ecr.aws/lambda/dotnet:8

# Copy function code to Lambda-defined environment variable
COPY publish/* ${LAMBDA_TASK_ROOT}

# Set the CMD to your handler (could also be done as a parameter override outside
of the Dockerfile)
CMD [ "MyFunction::MyFunction.Function::FunctionHandler" ]
```

5. Install the Amazon.Lambda.Tools [.NET Global Tool](#).

```
dotnet tool install -g Amazon.Lambda.Tools
```

If Amazon.Lambda.Tools is already installed, make sure that you have the latest version.

```
dotnet tool update -g Amazon.Lambda.Tools
```

6. Change the directory to `MyFunction/src/MyFunction`, if you're not there already.

```
cd src/MyFunction
```

7. Use Amazon.Lambda.Tools to build the Docker image, push it to a new Amazon ECR repository, and deploy the Lambda function.

For `--function-role`, specify the role name—not the Amazon Resource Name (ARN)—of the [execution role](#) for the function. For example, `lambda-role`.

```
dotnet lambda deploy-function MyFunction --function-role lambda-role
```

For more information about the Amazon.Lambda.Tools .NET Global Tool, see the [AWS Extensions for .NET CLI](#) repository on GitHub.

8. Invoke the function.

```
dotnet lambda invoke-function MyFunction --payload "Testing the function"
```

If everything is successful, you see the following:

Payload:

```
"TESTING THE FUNCTION"
```

Log Tail:

```
START RequestId: id Version: $LATEST
```

```
END RequestId: id
```

```
REPORT RequestId: id Duration: 0.99 ms          Billed Duration: 1 ms          Memory  
Size: 256 MB      Max Memory Used: 12 MB
```

9. Delete the Lambda function.

```
dotnet lambda delete-function MyFunction
```

Using an alternative base image with the runtime interface client

If you use an [OS-only base image](#) or an alternative base image, you must include the runtime interface client in your image. The runtime interface client extends the [Using the Lambda runtime API for custom runtimes](#), which manages the interaction between Lambda and your function code.

The following example demonstrates how to build a container image for .NET using a non-AWS base image, and how to add the [Amazon.Lambda.RuntimeSupport package](#), which is the Lambda runtime interface client for .NET. The example Dockerfile uses the Microsoft .NET 8 base image.

Prerequisites

To complete the steps in this section, you must have the following:

- [.NET SDK](#) – The following steps use a .NET 8 base image. Make sure that your .NET version matches the version of the [base image](#) that you specify in your Dockerfile.
- [Docker](#)

Creating and deploying an image using an alternative base image

1. Install the [Amazon.Lambda.Templates](#) NuGet package.

```
dotnet new install Amazon.Lambda.Templates
```

2. Create a .NET project using the `lambda.CustomRuntimeFunction` template. This template includes the [Amazon.Lambda.RuntimeSupport](#) package.

```
dotnet new lambda.CustomRuntimeFunction --name MyFunction --region us-east-1
```

3. Navigate to the `MyFunction/src/MyFunction` directory. This is where the project files are stored. Examine the following files:
 - **aws-lambda-tools-defaults.json** – This file is where you specify the command line options when deploying your Lambda function.
 - **Function.cs** – The code contains a class with a `Main` method that initializes the `Amazon.Lambda.RuntimeSupport` library as the bootstrap. The `Main` method is the entry point for the function's process. The `Main` method wraps the function handler in a wrapper that the bootstrap can work with. For more information, see [Using Amazon.Lambda.RuntimeSupport as a class library](#) in the GitHub repository.

- **MyFunction.csproj** – A .NET [project file](#), which lists the files and assemblies that comprise your application.
 - **Readme.md** – This file contains more information about the sample Lambda function.
4. Open the `aws-lambda-tools-defaults.json` file and Add the following lines:

```
"package-type": "image",  
"docker-host-build-output-dir": "./bin/Release/lambda-publish"
```

- **package-type**: Defines the deployment package as a container image.
- **docker-host-build-output-dir**: Sets the output directory for the build process.

Example `aws-lambda-tools-defaults.json`

```
{  
  "Information": [  
    "This file provides default values for the deployment wizard inside Visual  
    Studio and the AWS Lambda commands added to the .NET Core CLI.",  
    "To learn more about the Lambda commands with the .NET Core CLI execute the  
    following command at the command line in the project root directory.",  
    "dotnet lambda help",  
    "All the command line options for the Lambda command can be specified in this  
    file."  
  ],  
  "profile": "",  
  "region": "us-east-1",  
  "configuration": "Release",  
  "function-runtime": "provided.al2023",  
  "function-memory-size": 256,  
  "function-timeout": 30,  
  "function-handler": "bootstrap",  
  "msbuild-parameters": "--self-contained true",  
  "package-type": "image",  
  "docker-host-build-output-dir": "./bin/Release/lambda-publish"  
}
```

5. Create a Dockerfile in the `MyFunction/src/MyFunction` directory. The following example Dockerfile uses a Microsoft .NET base image instead of an [AWS base image](#).
- Set the FROM property to the base image identifier. Your .NET version must match the version of the base image.

- Use the COPY command to copy the function into the `/var/task` directory.
- Set the ENTRYPOINT to the module that you want the Docker container to run when it starts. In this case, the module is the bootstrap, which initializes the `Amazon.Lambda.RuntimeSupport` library.

Note that the example Dockerfile does not include a [USER instruction](#). When you deploy a container image to Lambda, Lambda automatically defines a default Linux user with least-privileged permissions. This is different from standard Docker behavior which defaults to the root user when no USER instruction is provided.

Example Dockerfile

```
# You can also pull these images from DockerHub amazon/aws-lambda-dotnet:8
FROM mcr.microsoft.com/dotnet/runtime:8.0

# Set the image's internal work directory
WORKDIR /var/task

# Copy function code to Lambda-defined environment variable
COPY "bin/Release/net8.0/linux-x64" .

# Set the entrypoint to the bootstrap
ENTRYPOINT ["/usr/bin/dotnet", "exec", "/var/task/bootstrap.dll"]
```

6. Install the Amazon.Lambda.Tools [.NET Global Tools extension](#).

```
dotnet tool install -g Amazon.Lambda.Tools
```

If Amazon.Lambda.Tools is already installed, make sure that you have the latest version.

```
dotnet tool update -g Amazon.Lambda.Tools
```

7. Use Amazon.Lambda.Tools to build the Docker image, push it to a new Amazon ECR repository, and deploy the Lambda function.

For `--function-role`, specify the role name—not the Amazon Resource Name (ARN)—of the [execution role](#) for the function. For example, `lambda-role`.

```
dotnet lambda deploy-function MyFunction --function-role lambda-role
```

For more information about the Amazon.Lambda.Tools .NET CLI extension, see the [AWS Extensions for .NET CLI](#) repository on GitHub.

8. Invoke the function.

```
dotnet lambda invoke-function MyFunction --payload "Testing the function"
```

If everything is successful, you see the following:

Payload:

```
"TESTING THE FUNCTION"
```

Log Tail:

```
START RequestId: id Version: $LATEST
```

```
END RequestId: id
```

```
REPORT RequestId: id Duration: 0.99 ms          Billed Duration: 1 ms          Memory  
Size: 256 MB      Max Memory Used: 12 MB
```

9. Delete the Lambda function.

```
dotnet lambda delete-function MyFunction
```

Compile .NET Lambda function code to a native runtime format

.NET 8 supports native ahead-of-time (AOT) compilation. With native AOT, you can compile your Lambda function code to a native runtime format, which removes the need to compile .NET code at runtime. Native AOT compilation can reduce the cold start time for Lambda functions that you write in .NET. For more information, see [Introducing the .NET 8 runtime for AWS Lambda](#) on the AWS Compute Blog.

Sections

- [Lambda runtime](#)
- [Prerequisites](#)
- [Getting started](#)
- [Serialization](#)
- [Trimming](#)
- [Troubleshooting](#)

Lambda runtime

To deploy a Lambda function build with native AOT compilation, use the managed .NET 8 Lambda runtime. This runtime supports the use of both x86_64 and arm64 architectures.

When you deploy a .NET Lambda function without using AOT, your application is first compiled into Intermediate Language (IL) code. At runtime, the just-in-time (JIT) compiler in the Lambda runtime takes the IL code and compiles it into machine code as needed. With a Lambda function that is compiled ahead of time with native AOT, you compile your code into machine code when you deploy your function, so you're not dependent on the .NET runtime or SDK in the Lambda runtime to compile your code before it runs.

One limitation of AOT is that your application code must be compiled in an environment with the same Amazon Linux 2023 (AL2023) operating system that the .NET 8 runtime uses. The .NET Lambda CLI provides functionality to compile your application in a Docker container using an AL2023 image.

To avoid potential issues with cross-architecture compatibility, we strongly recommend that you compile your code in an environment with the same processor architecture that you configure for your function. To learn more about the limitations of cross-architecture compilation, see [Cross-compilation](#) in the Microsoft .NET documentation.

Prerequisites

Docker

To use native AOT, your function code must be compiled in an environment with the same AL2023 operating system as the .NET 8 runtime. The .NET CLI commands in the following sections use Docker to develop and build Lambda functions in an AL2023 environment.

.NET 8 SDK

Native AOT compilation is a feature of .NET 8. You must install the [.NET 8 SDK](#) on your build machine, not only the runtime.

Amazon.Lambda.Tools

To create your Lambda functions, you use the [Amazon.Lambda.Tools .NET Global Tools extension](#). To install Amazon.Lambda.Tools, run the following command:

```
dotnet tool install -g Amazon.Lambda.Tools
```

For more information about the Amazon.Lambda.Tools .NET CLI extension, see the [AWS Extensions for .NET CLI](#) repository on GitHub.

Amazon.Lambda.Templates

To generate your Lambda function code, use the [Amazon.Lambda.Templates](#) NuGet package. To install this template package, run the following command:

```
dotnet new install Amazon.Lambda.Templates
```

Getting started

Both the .NET Global CLI and the AWS Serverless Application Model (AWS SAM) provide getting started templates for building applications using native AOT. To build your first native AOT Lambda function, carry out the steps in the following instructions.

To initialize and deploy a native AOT compiled Lambda function

1. Initialize a new project using the native AOT template and then navigate into the directory containing the created .cs and .csproj files. In this example, we name our function NativeAotSample.

```
dotnet new lambda.NativeAOT -n NativeAotSample
cd ./NativeAotSample/src/NativeAotSample
```

The `Function.cs` file created by the native AOT template contains the following function code.

```
using Amazon.Lambda.Core;
using Amazon.Lambda.RuntimeSupport;
using Amazon.Lambda.Serialization.SystemTextJson;
using System.Text.Json.Serialization;

namespace NativeAotSample;

public class Function
{
    /// <summary>
    /// The main entry point for the Lambda function. The main function is called
    /// once during the Lambda init phase. It
    /// initializes the .NET Lambda runtime client passing in the function handler
    /// to invoke for each Lambda event and
    /// the JSON serializer to use for converting Lambda JSON format to the .NET
    /// types.
    /// </summary>
    private static async Task Main()
    {
        Func<string, ILambdaContext, string> handler = FunctionHandler;
        await LambdaBootstrapBuilder.Create(handler, new
        SourceGeneratorLambdaJsonSerializer<LambdaFunctionJsonSerializerContext>())
            .Build()
            .RunAsync();
    }

    /// <summary>
    /// A simple function that takes a string and does a ToUpper.
    ///
    /// To use this handler to respond to an AWS event, reference the appropriate
    /// package from
    /// https://github.com/aws/aws-lambda-dotnet#events
    /// and change the string input parameter to the desired event type. When the
    /// event type
    /// is changed, the handler type registered in the main method needs to be
    /// updated and the LambdaFunctionJsonSerializerContext
```

```

    /// defined below will need the JsonSerializer updated. If the return type
    and event type are different then the
    /// LambdaFunctionJsonSerializerContext must have two JsonSerializer
    attributes, one for each type.
    ///
    // When using Native AOT extra testing with the deployed Lambda functions is
    required to ensure
    // the libraries used in the Lambda function work correctly with Native AOT. If
    a runtime
    // error occurs about missing types or methods the most likely solution will be
    to remove references to trim-unsafe
    // code or configure trimming options. This sample defaults to partial TrimMode
    because currently the AWS
    // SDK for .NET does not support trimming. This will result in a larger
    executable size, and still does not
    // guarantee runtime trimming errors won't be hit.
    /// </summary>
    /// <param name="input"></param>
    /// <param name="context"></param>
    /// <returns></returns>
    public static string FunctionHandler(string input, ILambdaContext context)
    {
        return input.ToUpper();
    }
}

/// <summary>
/// This class is used to register the input event and return type for the
    FunctionHandler method with the System.Text.Json source generator.
/// There must be a JsonSerializer attribute for each type used as the input and
    return type or a runtime error will occur
/// from the JSON serializer unable to find the serialization information for
    unknown types.
/// </summary>
[JsonSerializable(typeof(string))]
public partial class LambdaFunctionJsonSerializerContext : JsonSerializerContext
{
    // By using this partial class derived from JsonSerializerContext, we can
    generate reflection free JSON Serializer code at compile time
    // which can deserialize our class and properties. However, we must attribute
    this class to tell it what types to generate serialization code for.
    // See https://docs.microsoft.com/en-us/dotnet/standard/serialization/system-
    text-json-source-generation

```

Native AOT compiles your application into a single, native binary. The entrypoint of that binary is the `static Main` method. Within `static Main`, the Lambda runtime is bootstrapped and the `FunctionHandler` method set up. As part of the runtime bootstrap, a source generated serializer is configured using `new SourceGeneratorLambdaJsonSerializer<LambdaFunctionJsonSerializerContext>()`

2. To deploy your application to Lambda, ensure that Docker is running in your local environment and run the following command.

```
dotnet lambda deploy-function
```

Behind the scenes, the .NET global CLI downloads an AL2023 Docker image and compiles your application code inside a running container. The compiled binary is output back to your local filesystem before being deployed to Lambda.

3. Test your function by running the following command. Replace `<FUNCTION_NAME>` with the name you chose for your function in the deployment wizard.

```
dotnet lambda invoke-function <FUNCTION_NAME> --payload "hello world"
```

The response from the CLI includes performance details for the cold start (initialization duration) and total run time for your function invocation.

4. To delete the AWS resources you created by following the preceding steps, run the following command. Replace `<FUNCTION_NAME>` with the name you chose for your function in the deployment wizard. By deleting AWS resources that you're no longer using, you prevent unnecessary charges being billed to your AWS account.

```
dotnet lambda delete-function <FUNCTION_NAME>
```

Serialization

To deploy functions to Lambda using native AOT, your function code must use [source generated serialization](#). Instead of using run-time reflection to gather the metadata needed to access object properties for serialization, source generators generate C# source files that are compiled when you build your application. To configure your source generated serializer correctly, ensure that you include any input and output objects your function uses, as well as any custom types. For

example, a Lambda function that receives events from an API Gateway REST API and returns a custom Product type would include a serializer defined as follows.

```
[JsonSerializable(typeof(APIGatewayProxyRequest))]  
[JsonSerializable(typeof(APIGatewayProxyResponse))]  
[JsonSerializable(typeof(Product))]  
public partial class CustomSerializer : JsonSerializerContext  
{  
}
```

Trimming

Native AOT trims your application code as part of the compilation to ensure that the binary is as small as possible. .NET 8 for Lambda provides improved trimming support compared to previous versions of .NET. Support has been added to the [Lambda runtime libraries](#), [AWS .NET SDK](#), [.NET Lambda Annotations](#), and .NET 8 itself.

These improvements offer the potential to eliminate build-time trimming warnings, but .NET will never be completely trim safe. This means that parts of libraries that your function relies on may be trimmed out as part of the compilation step. You can manage this by defining `TrimmerRootAssemblies` as part of your `.csproj` file as shown in the following example.

```
<ItemGroup>  
  <TrimmerRootAssembly Include="AWSSDK.Core" />  
  <TrimmerRootAssembly Include="AWSXRayRecorder.Core" />  
  <TrimmerRootAssembly Include="AWSXRayRecorder.Handlers.AwsSdk" />  
  <TrimmerRootAssembly Include="Amazon.Lambda.APIGatewayEvents" />  
  <TrimmerRootAssembly Include="bootstrap" />  
  <TrimmerRootAssembly Include="Shared" />  
</ItemGroup>
```

Note that when you receive a trim warning, adding the class that generates the warning to `TrimmerRootAssembly` might not resolve the issue. A trim warning indicates that the class is trying to access some other class that can't be determined until runtime. To avoid runtime errors, add this second class to `TrimmerRootAssembly`.

To learn more about managing trim warnings, see [Introduction to trim warnings](#) in the Microsoft .NET documentation.

Troubleshooting

Error: Cross-OS native compilation is not supported.

Your version of the Amazon.Lambda.Tools .NET Core global tool is out of date. Update to the latest version and try again.

Docker: image operating system "linux" cannot be used on this platform.

Docker on your system is configured to use Windows containers. Swap to Linux containers to run the native AOT build environment.

For more information about common errors, see the [AWS NativeAOT for .NET](#) repository on GitHub.

Using the Lambda context object to retrieve C# function information

When Lambda runs your function, it passes a context object to the [handler](#). This object provides properties with information about the invocation, function, and execution environment.

Context properties

- `FunctionName` – The name of the Lambda function.
- `FunctionVersion` – The [version](#) of the function.
- `InvokedFunctionArn` – The Amazon Resource Name (ARN) that's used to invoke the function. Indicates if the invoker specified a version number or alias.
- `MemoryLimitInMB` – The amount of memory that's allocated for the function.
- `AwsRequestId` – The identifier of the invocation request.
- `LogGroupName` – The log group for the function.
- `LogStreamName` – The log stream for the function instance.
- `RemainingTime (TimeSpan)` – The number of milliseconds left before the execution times out.
- `Identity` – (mobile apps) Information about the Amazon Cognito identity that authorized the request.
- `ClientContext` – (mobile apps) Client context that's provided to Lambda by the client application.
- `Logger` The [logger object](#) for the function.

You can use information in the `ILambdaContext` object to output information about your function's invocation for monitoring purposes. The following code provides an example of how to add context information to a structured logging framework. In this example, the function adds `AwsRequestId` to the log outputs. The function also uses the `RemainingTime` property to cancel an inflight task if the Lambda function timeout is about to be reached.

```
[assembly:  
    LambdaSerializer(typeof(Amazon.Lambda.Serialization.SystemTextJson.DefaultLambdaJsonSerializer)  
  
namespace GetProductHandler;  
  
public class Function
```

```
{
    private readonly IDatabaseRepository _repo;

    public Function()
    {
        this._repo = new DatabaseRepository();
    }

    public async Task<APIGatewayProxyResponse> FunctionHandler(APIGatewayProxyRequest
request, ILambdaContext context)
    {
        Logger.AppendKey("AwsRequestId", context.AwsRequestId);

        var id = request.PathParameters["id"];

        using var cts = new CancellationTokenSource();

        try
        {
            cts.CancelAfter(context.RemainingTime.Add(TimeSpan.FromSeconds(-1)));

            var databaseRecord = await this._repo.GetById(id, cts.Token);

            return new APIGatewayProxyResponse
            {
                StatusCode = (int)HttpStatusCode.OK,
                Body = JsonSerializer.Serialize(databaseRecord)
            };
        }
        catch (Exception ex)
        {
            return new APIGatewayProxyResponse
            {
                StatusCode = (int)HttpStatusCode.InternalServerError,
                Body = JsonSerializer.Serialize(new { error = ex.Message })
            };
        }
        finally
        {
            cts.Cancel();
        }
    }
}
```

Log and monitor C# Lambda functions

AWS Lambda automatically monitors Lambda functions and sends log entries to Amazon CloudWatch. Your Lambda function comes with a CloudWatch Logs log group and a log stream for each instance of your function. The Lambda runtime environment sends details about each invocation and other output from your function's code to the log stream. For more information about CloudWatch Logs, see [Using CloudWatch Logs with Lambda](#).

Sections

- [Creating a function that returns logs](#)
- [Using Lambda advanced logging controls with .NET](#)
- [Additional logging tools and libraries](#)
- [Using Powertools for AWS Lambda \(.NET\) and AWS SAM for structured logging](#)
- [Viewing logs in the Lambda console](#)
- [Viewing logs in the CloudWatch console](#)
- [Viewing logs using the AWS Command Line Interface \(AWS CLI\)](#)
- [Deleting logs](#)

Creating a function that returns logs

To output logs from your function code, you can use the [ILambdaLogger](#) on the context object, the methods on the [Console class](#), or any logging library that writes to stdout or stderr.

The .NET runtime logs the START, END, and REPORT lines for each invocation. The report line provides the following details.

REPORT line data fields

- **RequestId** – The unique request ID for the invocation.
- **Duration** – The amount of time that your function's handler method spent processing the event.
- **Billed Duration** – The amount of time billed for the invocation.
- **Memory Size** – The amount of memory allocated to the function.
- **Max Memory Used** – The amount of memory used by the function. When invocations share an execution environment, Lambda reports the maximum memory used across all invocations. This behavior might result in a higher than expected reported value.

- **Init Duration** – For the first request served, the amount of time it took the runtime to load the function and run code outside of the handler method.
- **XRAY TraceId** – For traced requests, the [AWS X-Ray trace ID](#).
- **SegmentId** – For traced requests, the X-Ray segment ID.
- **Sampled** – For traced requests, the sampling result.

Using Lambda advanced logging controls with .NET

To give you more control over how your functions' logs are captured, processed, and consumed, you can configure the following logging options for supported .NET runtimes:

- **Log format** - select between plain text and structured JSON format for your function's logs
- **Log level** - for logs in JSON format, choose the detail level of the logs Lambda sends to CloudWatch, such as ERROR, DEBUG, or INFO
- **Log group** - choose the CloudWatch log group your function sends logs to

For more information about these logging options, and instructions on how to configure your function to use them, see [the section called "Configure function logs"](#).

To use the log format and log level options with your .NET Lambda functions, see the guidance in the following sections.

Using structured JSON log format with .NET

If you select JSON for your function's log format, Lambda will send logs output using [ILambdaLogger](#) as structured JSON. Each JSON log object contains at least five key value pairs with the following keys:

- "timestamp" - the time the log message was generated
- "level" - the log level assigned to the message
- "requestId" - the unique request ID for the function invocation
- "traceId" - the `_X_AMZN_TRACE_ID` environment variable
- "message" - the contents of the log message

The `ILambdaLogger` instance can add additional key value pairs, for example when logging exceptions. You can also supply your own additional parameters as described in the section [the section called “Customer-provided log parameters”](#).

Note

If your code already uses another logging library to produce JSON-formatted logs, ensure that your function's log format is set to plain text. Setting the log format to JSON will result in your log outputs being double-encoded.

The following example logging command shows how to write a log message with the level `INFO`.

Example .NET logging code

```
context.Logger.LogInformation("Fetching cart from database");
```

You can also use a generic log method that takes the log level as an argument as shown in the following example.

```
context.Logger.Log(LogLevel.Information, "Fetching cart from database");
```

The log output by these example code snippets would be captured in CloudWatch Logs as follows:

Example JSON log record

```
{
  "timestamp": "2023-09-07T01:30:06.977Z",
  "level": "Information",
  "requestId": "8f711428-7e55-46f9-ae88-2a65d4f85fc5",
  "traceId": "1-6408af34-50f56f5b5677a7d763973804",
  "message": "Fetching cart from database"
}
```

Note

If you configure your function's log format to use plain text rather than JSON, then the log level captured in the message follows the Microsoft convention of using a four-character label. For example, a log level of `Debug` is represented in the message as `debug`.

When you configure your function to use JSON formatted logs, the log level captured in the log uses the full label as shown in the example JSON log record.

If you don't assign a level to your log output, Lambda will automatically assign it the level INFO.

Logging exceptions in JSON

When using structured JSON logging with `ILambdaLogger`, you can log exceptions in your code as shown in the following example.

Example usage of exception logging

```
try
{
    connection.ExecuteNonQuery(query);
}
catch(Exception e)
{
    context.Logger.LogWarning(e, "Error executing query");
}
```

The log format output by this code is shown in the following example JSON. Note that the message property in the JSON is populated using the message argument provided in the `LogWarning` call, while the `errorMessage` property comes from the Message property of the exception itself.

Example JSON log record

```
{
  "timestamp": "2023-09-07T01:30:06.977Z",
  "level": "Warning",
  "requestId": "8f711428-7e55-46f9-ae88-2a65d4f85fc5",
  "traceId": "1-6408af34-50f56f5b5677a7d763973804",
  "message": "Error executing query",
  "errorType": "System.Data.SqlClient.SqlException",
  "errorMessage": "Connection closed",
  "stackTrace": ["<call exception.StackTrace>"]
}
```

If your function's logging format is set to JSON, Lambda also outputs JSON-formatted log messages when your code throws an uncaught exception. The following example code snippet and log message show how uncaught exceptions are logged.

Example exception code

```
throw new ApplicationException("Invalid data");
```

Example JSON log record

```
{
  "timestamp": "2023-09-07T01:30:06.977Z",
  "level": "Error",
  "requestId": "8f711428-7e55-46f9-ae88-2a65d4f85fc5",
  "traceId": "1-6408af34-50f56f5b5677a7d763973804",
  "message": "Invalid data",
  "errorType": "System.ApplicationException",
  "errorMessage": "Invalid data",
  "stackTrace": ["<call exception.StackTrace>"]
}
```

Customer-provided log parameters

With JSON-formatted log messages, you can supply additional log parameters and include these in the log message. The following code snippet example shows a command to add two user-supplied parameters labeled `retryAttempt` and `uri`. In the example, the value of these parameters come from the `retryAttempt` and `uriDestination` arguments passed into the logging command.

Example JSON logging command with additional parameters

```
context.Logger.LogInformation("Starting retry {retryAttempt} to make GET request to {uri}", retryAttempt, uriDestination);
```

The log message output by this command is shown in the following example JSON.

Example JSON log record

```
{
  "timestamp": "2023-09-07T01:30:06.977Z",
  "level": "Information",
```

```
"requestId": "8f711428-7e55-46f9-ae88-2a65d4f85fc5",
"traceId": "1-6408af34-50f56f5b5677a7d763973804",
"message": "Starting retry 1 to make GET request to http://example.com/",
"retryAttempt": 1,
"uri": "http://example.com/"
}
```

Tip

You can also use positional properties instead of names when specifying additional parameters. For example, the logging command in the previous example could also be written as follows:

```
context.Logger.LogInformation("Starting retry {0} to make GET request to {1}",
    retryAttempt, uriDestination);
```

Note that when you supply additional logging parameters, Lambda captures them as top-level properties in the JSON log record. This approach differs from some popular .NET logging libraries such as Serilog, which captures additional parameters in a separate child object.

If the argument you supply for an additional parameter is a complex object, by default Lambda uses the `ToString()` method to supply the value. To indicate that an argument should be JSON serialized, use the `@` prefix as shown in the following code snippet. In this example, `User` is an object with `FirstName` and `LastName` properties.

Example JSON logging command with JSON serialized object

```
context.Logger.LogInformation("User {@user} logged in", User);
```

The log message output by this command is shown in the following example JSON.

Example JSON log record

```
{
  "timestamp": "2023-09-07T01:30:06.977Z",
  "level": "Information",
  "requestId": "8f711428-7e55-46f9-ae88-2a65d4f85fc5",
  "traceId": "1-6408af34-50f56f5b5677a7d763973804",
  "message": "User {@user} logged in",
```

```
"user":
{
  "FirstName": "John",
  "LastName": "Doe"
}
}
```

If the argument for an additional parameter is an array or implements `IList` or `IDictionary`, then Lambda adds the argument to the JSON log message as an array as shown in the following example JSON log record. In this example, `{users}` takes an `IList` argument containing instances of the `User` property with the same format as the previous example. Lambda converts this `IList` into an array, with each value being created using the `ToString` method.

Example JSON log record with an `IList` argument

```
{
  "timestamp": "2023-09-07T01:30:06.977Z",
  "level": "Information",
  "requestId": "8f711428-7e55-46f9-ae88-2a65d4f85fc5",
  "traceId": "1-6408af34-50f56f5b5677a7d763973804",
  "message": "{users} have joined the group",
  "users":
  [
    "Rosalez, Alejandro",
    "Stiles, John"
  ]
}
```

You can also JSON serialize the list by using the `@` prefix in your logging command. In the following example JSON log record, the `users` property is JSON serialized.

Example JSON log record with a JSON serialized `IList` argument

```
{
  "timestamp": "2023-09-07T01:30:06.977Z",
  "level": "Information",
  "requestId": "8f711428-7e55-46f9-ae88-2a65d4f85fc5",
  "traceId": "1-6408af34-50f56f5b5677a7d763973804",
  "message": "{@users} have joined the group",
  "users":
  [
    {
```

```
        "FirstName": "Alejandro",
        "LastName": "Rosalez"
    },
    {
        "FirstName": "John",
        "LastName": "Stiles"
    }
]
}
```

Using log-level filtering with .NET

By configuring log-level filtering, you can choose to send only logs of a certain detail level or lower to CloudWatch Logs. To learn how to configure log-level filtering for your function, see [the section called “Log-level filtering”](#).

For AWS Lambda to filter your log messages by log level, you can either use JSON formatted logs or use the .NET Console methods to output log messages. To create JSON formatted logs, [configure your function's log type to JSON](#) and use the `ILambdaLogger` instance.

With JSON-formatted logs, Lambda filters your log outputs using the “level” key value pair in the JSON object described in [the section called “Using structured JSON log format with .NET”](#).

If you use the .NET Console methods to write messages to CloudWatch Logs, Lambda applies log levels to your messages as follows:

- **Console.WriteLine method** - Lambda applies a log-level of INFO
- **Console.Error method** - Lambda applies a log-level of ERROR

When you configure your function to use log-level filtering, you must select from the following options for the level of logs you want Lambda to send to CloudWatch Logs. Note the mapping of the log levels used by Lambda with the standard Microsoft levels used by the .NET `ILambdaLogger`.

Lambda log level	Equivalent Microsoft level	Standard usage
TRACE (most detail)	Trace	The most fine-grained information used to trace the path of your code's execution

Lambda log level	Equivalent Microsoft level	Standard usage
DEBUG	Debug	Detailed information for system debugging
INFO	Information	Messages that record the normal operation of your function
WARN	Warning	Messages about potential errors that may lead to unexpected behavior if unaddressed
ERROR	Error	Messages about problems that prevent the code from performing as expected
FATAL (least detail)	Critical	Messages about serious errors that cause the application to stop functioning

Lambda sends logs of the selected detail level and lower to CloudWatch. For example, if you configure a log level of WARN, Lambda will send logs corresponding to the WARN, ERROR, and FATAL levels.

Additional logging tools and libraries

[Powertools for AWS Lambda \(.NET\)](#) is a developer toolkit to implement Serverless best practices and increase developer velocity. The [Logging utility](#) provides a Lambda optimized logger which includes additional information about function context across all your functions with output structured as JSON. Use this utility to do the following:

- Capture key fields from the Lambda context, cold start and structures logging output as JSON
- Log Lambda invocation events when instructed (disabled by default)
- Print all the logs only for a percentage of invocations via log sampling (disabled by default)
- Append additional keys to structured log at any point in time

- Use a custom log formatter (Bring Your Own Formatter) to output logs in a structure compatible with your organization's Logging RFC

Using Powertools for AWS Lambda (.NET) and AWS SAM for structured logging

Follow the steps below to download, build, and deploy a sample Hello World C# application with integrated [Powertools for AWS Lambda \(.NET\)](#) modules using the AWS SAM. This application implements a basic API backend and uses Powertools for emitting logs, metrics, and traces. It consists of an Amazon API Gateway endpoint and a Lambda function. When you send a GET request to the API Gateway endpoint, the Lambda function invokes, sends logs and metrics using Embedded Metric Format to CloudWatch, and sends traces to AWS X-Ray. The function returns a `hello world` message.

Prerequisites

To complete the steps in this section, you must have the following:

- .NET 8
- [AWS CLI version 2](#)
- [AWS SAM CLI version 1.75 or later](#). If you have an older version of the AWS SAM CLI, see [Upgrading the AWS SAM CLI](#).

Deploy a sample AWS SAM application

1. Initialize the application using the Hello World TypeScript template.

```
sam init --app-template hello-world-powertools-dotnet --name sam-app --package-type Zip --runtime dotnet6 --no-tracing
```

2. Build the app.

```
cd sam-app && sam build
```

3. Deploy the app.

```
sam deploy --guided
```

- Follow the on-screen prompts. To accept the default options provided in the interactive experience, press Enter.

 **Note**

For **HelloWorldFunction** may not have authorization defined, **Is this okay?**, make sure to enter **y**.

- Get the URL of the deployed application:

```
aws cloudformation describe-stacks --stack-name sam-app --query
  'Stacks[0].Outputs[?OutputKey=`HelloWorldApi`].OutputValue' --output text
```

- Invoke the API endpoint:

```
curl -X GET <URL_FROM_PREVIOUS_STEP>
```

If successful, you'll see this response:

```
{"message":"hello world"}
```

- To get the logs for the function, run [sam logs](#). For more information, see [Working with logs](#) in the *AWS Serverless Application Model Developer Guide*.

```
sam logs --stack-name sam-app
```

The log output looks like this:

```
2023/02/20/[$LATEST]4eaf8445ba7a4a93b999cb17fbfbecd8
2023-02-20T14:15:27.988000 INIT_START Runtime Version:
dotnet:6.v13 Runtime Version ARN: arn:aws:lambda:ap-
southeast-2::runtime:699f346a05dae24c58c45790bc4089f252bf17dae3997e79b17d939a288aa1ec
2023/02/20/[$LATEST]4eaf8445ba7a4a93b999cb17fbfbecd8 2023-02-20T14:15:28.229000
START RequestId: bed25b38-d012-42e7-ba28-f272535fb80e Version: $LATEST
2023/02/20/[$LATEST]4eaf8445ba7a4a93b999cb17fbfbecd8 2023-02-20T14:15:29.259000
2023-02-20T14:15:29.201Z bed25b38-d012-42e7-ba28-f272535fb80e info
{"_aws":{"Timestamp":1676902528962,"CloudWatchMetrics":[{"Namespace":"sam-
app-logging","Metrics":[{"Name":"ColdStart","Unit":"Count"}],"Dimensions":
[["FunctionName"],["Service"]]}]}, "FunctionName":"sam-app-HelloWorldFunction-
haKIoVeose2p","Service":"PowertoolsHelloWorld","ColdStart":1}
```

```

2023/02/20/[$LATEST]4eaf8445ba7a4a93b999cb17fbfbecd8 2023-02-20T14:15:30.479000
2023-02-20T14:15:30.479Z          bed25b38-d012-42e7-ba28-f272535fb80e    info
{"ColdStart":true,"XrayTraceId":"1-63f3807f-5dbcb9910c96f50742707542","CorrelationId":"d3d
a549-4d67b2fdc015","FunctionName":"sam-app-HelloWorldFunction-
haKIoVeose2p","FunctionVersion":"$LATEST","FunctionMemorySize":256,"FunctionArn":"arn:aws:lam
southeast-2:123456789012:function:sam-app-HelloWorldFunction-
haKIoVeose2p","FunctionRequestId":"bed25b38-d012-42e7-ba28-
f272535fb80e","Timestamp":"2023-02-20T14:15:30.4602970Z","Level":"Information","Service":"P
world API - HTTP 200"}
2023/02/20/[$LATEST]4eaf8445ba7a4a93b999cb17fbfbecd8 2023-02-20T14:15:30.599000
2023-02-20T14:15:30.599Z          bed25b38-d012-42e7-ba28-f272535fb80e    info
{"_aws":{"Timestamp":1676902528922,"CloudWatchMetrics":[{"Namespace":"sam-
app-logging","Metrics":[{"Name":"ApiRequestCount","Unit":"Count"}],"Dimensions":
[["Service"]]}]},"Service":"PowertoolsHelloWorld","ApiRequestCount":1}
2023/02/20/[$LATEST]4eaf8445ba7a4a93b999cb17fbfbecd8 2023-02-20T14:15:30.680000 END
RequestId: bed25b38-d012-42e7-ba28-f272535fb80e
2023/02/20/[$LATEST]4eaf8445ba7a4a93b999cb17fbfbecd8 2023-02-20T14:15:30.680000
REPORT RequestId: bed25b38-d012-42e7-ba28-f272535fb80e  Duration: 2450.99 ms
    Billed Duration: 2451 ms Memory Size: 256 MB    Max Memory Used: 74 MB  Init
Duration: 240.05 ms
XRAY TraceId: 1-63f3807f-5dbcb9910c96f50742707542          SegmentId: 16b362cd5f52cba0

```

- This is a public API endpoint that is accessible over the internet. We recommend that you delete the endpoint after testing.

```
sam delete
```

Managing log retention

Log groups aren't deleted automatically when you delete a function. To avoid storing logs indefinitely, delete the log group, or configure a retention period after which CloudWatch automatically deletes the logs. To set up log retention, add the following to your AWS SAM template:

```

Resources:
  HelloWorldFunction:
    Type: AWS::Serverless::Function
    Properties:
      # Omitting other properties

  LogGroup:

```



```
Type: AWS::Logs::LogGroup
Properties:
  LogGroupName: !Sub "/aws/lambda/${HelloWorldFunction}"
  RetentionInDays: 7
```

Viewing logs in the Lambda console

You can use the Lambda console to view log output after you invoke a Lambda function.

If your code can be tested from the embedded **Code** editor, you will find logs in the **execution results**. When you use the console test feature to invoke a function, you'll find **Log output** in the **Details** section.

Viewing logs in the CloudWatch console

You can use the Amazon CloudWatch console to view logs for all Lambda function invocations.

To view logs on the CloudWatch console

1. Open the [Log groups page](#) on the CloudWatch console.
2. Choose the log group for your function (*/aws/lambda/your-function-name*).
3. Choose a log stream.

Each log stream corresponds to an [instance of your function](#). A log stream appears when you update your Lambda function, and when additional instances are created to handle multiple concurrent invocations. To find logs for a specific invocation, we recommend instrumenting your function with AWS X-Ray. X-Ray records details about the request and the log stream in the trace.

Viewing logs using the AWS Command Line Interface (AWS CLI)

The AWS CLI is an open-source tool that enables you to interact with AWS services using commands in your command line shell. To complete the steps in this section, you must have the [AWS CLI version 2](#).

You can use the [AWS CLI](#) to retrieve logs for an invocation using the `--log-type` command option. The response contains a `LogResult` field that contains up to 4 KB of base64-encoded logs from the invocation.

Example retrieve a log ID

The following example shows how to retrieve a *log ID* from the `LogResult` field for a function named `my-function`.

```
aws lambda invoke --function-name my-function out --log-type Tail
```

You should see the following output:

```
{
  "StatusCode": 200,
  "LogResult":
  "U1RBU1QgUmVxdWVzdElk0iA4N2QwNDRi0C1mMTU0LTExZTgt0GNkYS0y0Tc0YzVlNGZiMjEgVmVyc2lvb...",
  "ExecutedVersion": "$LATEST"
}
```

Example decode the logs

In the same command prompt, use the `base64` utility to decode the logs. The following example shows how to retrieve base64-encoded logs for `my-function`.

```
aws lambda invoke --function-name my-function out --log-type Tail \
--query 'LogResult' --output text --cli-binary-format raw-in-base64-out | base64 --
decode
```

The `cli-binary-format` option is required if you're using AWS CLI version 2. To make this the default setting, run `aws configure set cli-binary-format raw-in-base64-out`. For more information, see [AWS CLI supported global command line options](#) in the *AWS Command Line Interface User Guide for Version 2*.

You should see the following output:

```
START RequestId: 57f231fb-1730-4395-85cb-4f71bd2b87b8 Version: $LATEST
"AWS_SESSION_TOKEN": "AgoJb3JpZ22luX2VjELj...", "_X_AMZN_TRACE_ID": "Root=1-5d02e5ca-
f5792818b6fe8368e5b51d50;Parent=191db58857df8395;Sampled=0\"",ask/lib:/opt/lib",
END RequestId: 57f231fb-1730-4395-85cb-4f71bd2b87b8
REPORT RequestId: 57f231fb-1730-4395-85cb-4f71bd2b87b8 Duration: 79.67 ms Billed
Duration: 80 ms Memory Size: 128 MB Max Memory Used: 73 MB
```

The `base64` utility is available on Linux, macOS, and [Ubuntu on Windows](#). macOS users may need to use `base64 -D`.

Example get-logs.sh script

In the same command prompt, use the following script to download the last five log events. The script uses `sed` to remove quotes from the output file, and sleeps for 15 seconds to allow time for the logs to become available. The output includes the response from Lambda and the output from the `get-log-events` command.

Copy the contents of the following code sample and save in your Lambda project directory as `get-logs.sh`.

The **cli-binary-format** option is required if you're using AWS CLI version 2. To make this the default setting, run `aws configure set cli-binary-format raw-in-base64-out`. For more information, see [AWS CLI supported global command line options](#) in the *AWS Command Line Interface User Guide for Version 2*.

```
#!/bin/bash
aws lambda invoke --function-name my-function --cli-binary-format raw-in-base64-out --
payload '{"key": "value"}' out
sed -i'' -e 's/"//g' out
sleep 15
aws logs get-log-events --log-group-name /aws/lambda/my-function --log-stream-
name stream1 --limit 5
```

Example macOS and Linux (only)

In the same command prompt, macOS and Linux users may need to run the following command to ensure the script is executable.

```
chmod -R 755 get-logs.sh
```

Example retrieve the last five log events

In the same command prompt, run the following script to get the last five log events.

```
./get-logs.sh
```

You should see the following output:

```
{
  "StatusCode": 200,
  "ExecutedVersion": "$LATEST"
```

```

}
{
  "events": [
    {
      "timestamp": 1559763003171,
      "message": "START RequestId: 4ce9340a-b765-490f-ad8a-02ab3415e2bf Version:
$LATEST\n",
      "ingestionTime": 1559763003309
    },
    {
      "timestamp": 1559763003173,
      "message": "2019-06-05T19:30:03.173Z\t4ce9340a-b765-490f-ad8a-02ab3415e2bf
\tINFO\tENVIRONMENT VARIABLES\r{\r  \"AWS_LAMBDA_FUNCTION_VERSION\": \"\n$LATEST\n",
\r ...",
      "ingestionTime": 1559763018353
    },
    {
      "timestamp": 1559763003173,
      "message": "2019-06-05T19:30:03.173Z\t4ce9340a-b765-490f-ad8a-02ab3415e2bf
\tINFO\tEVENT\r{\r  \"key\": \"value\"\r}\n",
      "ingestionTime": 1559763018353
    },
    {
      "timestamp": 1559763003218,
      "message": "END RequestId: 4ce9340a-b765-490f-ad8a-02ab3415e2bf\n",
      "ingestionTime": 1559763018353
    },
    {
      "timestamp": 1559763003218,
      "message": "REPORT RequestId: 4ce9340a-b765-490f-ad8a-02ab3415e2bf
\tDuration: 26.73 ms\tBilled Duration: 27 ms \tMemory Size: 128 MB\tMax Memory Used: 75
MB\t\n",
      "ingestionTime": 1559763018353
    }
  ],
  "nextForwardToken": "f/34783877304859518393868359594929986069206639495374241795",
  "nextBackwardToken": "b/34783877303811383369537420289090800615709599058929582080"
}

```

Deleting logs

Log groups aren't deleted automatically when you delete a function. To avoid storing logs indefinitely, delete the log group, or [configure a retention period](#) after which logs are deleted automatically.

Instrumenting C# code in AWS Lambda

Lambda integrates with AWS X-Ray to help you trace, debug, and optimize Lambda applications. You can use X-Ray to trace a request as it traverses resources in your application, which may include Lambda functions and other AWS services.

To send tracing data to X-Ray, you can use one of three SDK libraries:

- [AWS Distro for OpenTelemetry \(ADOT\)](#) – A secure, production-ready, AWS-supported distribution of the OpenTelemetry (OTel) SDK.
- [AWS X-Ray SDK for .NET](#) – An SDK for generating and sending trace data to X-Ray.
- [Powertools for AWS Lambda \(.NET\)](#) – A developer toolkit to implement Serverless best practices and increase developer velocity.

Each of the SDKs offer ways to send your telemetry data to the X-Ray service. You can then use X-Ray to view, filter, and gain insights into your application's performance metrics to identify issues and opportunities for optimization.

Important

The X-Ray and Powertools for AWS Lambda SDKs are part of a tightly integrated instrumentation solution offered by AWS. The ADOT Lambda Layers are part of an industry-wide standard for tracing instrumentation that collect more data in general, but may not be suited for all use cases. You can implement end-to-end tracing in X-Ray using either solution. To learn more about choosing between them, see [Choosing between the AWS Distro for Open Telemetry and X-Ray SDKs](#).

Sections

- [Using Powertools for AWS Lambda \(.NET\) and AWS SAM for tracing](#)
- [Using the X-Ray SDK to instrument your .NET functions](#)
- [Activating tracing with the Lambda console](#)
- [Activating tracing with the Lambda API](#)
- [Activating tracing with AWS CloudFormation](#)
- [Interpreting an X-Ray trace](#)

Using Powertools for AWS Lambda (.NET) and AWS SAM for tracing

Follow the steps below to download, build, and deploy a sample Hello World C# application with integrated [Powertools for AWS Lambda \(.NET\)](#) modules using the AWS SAM. This application implements a basic API backend and uses Powertools for emitting logs, metrics, and traces. It consists of an Amazon API Gateway endpoint and a Lambda function. When you send a GET request to the API Gateway endpoint, the Lambda function invokes, sends logs and metrics using Embedded Metric Format to CloudWatch, and sends traces to AWS X-Ray. The function returns a hello world message.

Prerequisites

To complete the steps in this section, you must have the following:

- .NET 8
- [AWS CLI version 2](#)
- [AWS SAM CLI version 1.75 or later](#). If you have an older version of the AWS SAM CLI, see [Upgrading the AWS SAM CLI](#).

Deploy a sample AWS SAM application

1. Initialize the application using the Hello World TypeScript template.

```
sam init --app-template hello-world-powertools-dotnet --name sam-app --package-type Zip --runtime dotnet6 --no-tracing
```

2. Build the app.

```
cd sam-app && sam build
```

3. Deploy the app.

```
sam deploy --guided
```

4. Follow the on-screen prompts. To accept the default options provided in the interactive experience, press Enter.

Note

For **HelloWorldFunction** may not have authorization defined, **Is this okay?**, make sure to enter y.

5. Get the URL of the deployed application:

```
aws cloudformation describe-stacks --stack-name sam-app --query
  'Stacks[0].Outputs[?OutputKey=='HelloWorldApi'].OutputValue' --output text
```

6. Invoke the API endpoint:

```
curl <URL_FROM_PREVIOUS_STEP>
```

If successful, you'll see this response:

```
{"message":"hello world"}
```

7. To get the traces for the function, run [sam traces](#).

```
sam traces
```

The trace output looks like this:

```
New XRay Service Graph
  Start time: 2023-02-20 23:05:16+08:00
  End time: 2023-02-20 23:05:16+08:00
  Reference Id: 0 - AWS::Lambda - sam-app-HelloWorldFunction-pNjujb7mEoew - Edges:
  [1]
    Summary_statistics:
      - total requests: 1
      - ok count(2XX): 1
      - error count(4XX): 0
      - fault count(5XX): 0
      - total response time: 2.814
  Reference Id: 1 - AWS::Lambda::Function - sam-app-HelloWorldFunction-pNjujb7mEoew
  - Edges: []
    Summary_statistics:
      - total requests: 1
      - ok count(2XX): 1
```



```

- error count(4XX): 0
- fault count(5XX): 0
- total response time: 2.429
Reference Id: 2 - (Root) AWS::ApiGateway::Stage - sam-app/Prod - Edges: [0]
Summary_statistics:
- total requests: 1
- ok count(2XX): 1
- error count(4XX): 0
- fault count(5XX): 0
- total response time: 2.839
Reference Id: 3 - client - sam-app/Prod - Edges: [2]
Summary_statistics:
- total requests: 0
- ok count(2XX): 0
- error count(4XX): 0
- fault count(5XX): 0
- total response time: 0

XRay Event [revision 3] at (2023-02-20T23:05:16.521000) with id
(1-63f38c2c-270200bf1d292a442c8e8a00) and duration (2.877s)
- 2.839s - sam-app/Prod [HTTP: 200]
- 2.836s - Lambda [HTTP: 200]
- 2.814s - sam-app-HelloWorldFunction-pNjujb7mEoew [HTTP: 200]
- 2.429s - sam-app-HelloWorldFunction-pNjujb7mEoew
- 0.230s - Initialization
- 2.389s - Invocation
- 0.600s - ## FunctionHandler
- 0.517s - Get Calling IP
- 0.039s - Overhead

```

8. This is a public API endpoint that is accessible over the internet. We recommend that you delete the endpoint after testing.

```
sam delete
```

X-Ray doesn't trace all requests to your application. X-Ray applies a sampling algorithm to ensure that tracing is efficient, while still providing a representative sample of all requests. The sampling rate is 1 request per second and 5 percent of additional requests. You can't configure the X-Ray sampling rate for your functions.

Using the X-Ray SDK to instrument your .NET functions

You can instrument your function code to record metadata and trace downstream calls. To record detail about calls that your function makes to other resources and services, use the AWS X-Ray SDK for .NET. To get the SDK, add the `AWSXRayRecorder` packages to your project file.

```
<Project Sdk="Microsoft.NET.Sdk">
  <PropertyGroup>
    <TargetFramework>net8.0</TargetFramework>
    <GenerateRuntimeConfigurationFiles>true</GenerateRuntimeConfigurationFiles>
    <AWSProjectType>Lambda</AWSProjectType>
  </PropertyGroup>
  <ItemGroup>
    <PackageReference Include="Amazon.Lambda.Core" Version="2.1.0" />
    <PackageReference Include="Amazon.Lambda.SQSEvents" Version="2.1.0" />
    <PackageReference Include="Amazon.Lambda.Serialization.Json" Version="2.1.0" />
    <PackageReference Include="AWSSDK.Core" Version="3.7.103.24" />
    <PackageReference Include="AWSSDK.Lambda" Version="3.7.104.3" />
    <PackageReference Include="AWSXRayRecorder.Core" Version="2.13.0" />
    <PackageReference Include="AWSXRayRecorder.Handlers.AwsSdk" Version="2.11.0" />
  </ItemGroup>
</Project>
```

There are a range of Nuget packages that provide auto-instrumentation for AWS SDKs, Entity Framework and HTTP requests. To see the complete set of configuration options refer to [AWS X-Ray SDK for .NET](#) in the *AWS X-Ray Developer Guide*.

Once you have added the desired Nuget packages, configure auto-instrumentation. Best practice is to perform this configuration outside of your function's handler function. This allows you to take advantage of execution environment re-use to improve the performance of your function. In the following code example, the `RegisterXRayForAllServices` method is called in the function constructor to add instrumentation for all AWS SDK calls.

```
[assembly:
  LambdaSerializer(typeof(Amazon.Lambda.Serialization.SystemTextJson.DefaultLambdaJsonSerializer))

namespace GetProductHandler;

public class Function
{
    private readonly IDatabaseRepository _repo;
```

```
public Function()
{
    // Add auto instrumentation for all AWS SDK calls
    // It is important to call this method before initializing any SDK clients
    AWSSDKHandler.RegisterXRayForAllServices();
    this._repo = new DatabaseRepository();
}

public async Task<APIGatewayProxyResponse> FunctionHandler(APIGatewayProxyRequest
request)
{
    var id = request.PathParameters["id"];

    var databaseRecord = await this._repo.GetById(id);

    return new APIGatewayProxyResponse
    {
        StatusCode = (int)HttpStatusCode.OK,
        Body = JsonSerializer.Serialize(databaseRecord)
    };
}
}
```

Activating tracing with the Lambda console

To toggle active tracing on your Lambda function with the console, follow these steps:

To turn on active tracing

1. Open the [Functions page](#) of the Lambda console.
2. Choose a function.
3. Choose **Configuration** and then choose **Monitoring and operations tools**.
4. Choose **Edit**.
5. Under **X-Ray**, toggle on **Active tracing**.
6. Choose **Save**.

Activating tracing with the Lambda API

Configure tracing on your Lambda function with the AWS CLI or AWS SDK, use the following API operations:

- [UpdateFunctionConfiguration](#)
- [GetFunctionConfiguration](#)
- [CreateFunction](#)

The following example AWS CLI command enables active tracing on a function named **my-function**.

```
aws lambda update-function-configuration --function-name my-function \  
--tracing-config Mode=Active
```

Tracing mode is part of the version-specific configuration when you publish a version of your function. You can't change the tracing mode on a published version.

Activating tracing with AWS CloudFormation

To activate tracing on an `AWS::Lambda::Function` resource in an AWS CloudFormation template, use the `TracingConfig` property.

Example [function-inline.yml](#) – Tracing configuration

```
Resources:  
  function:  
    Type: AWS::Lambda::Function  
    Properties:  
      TracingConfig:  
        Mode: Active  
      ...
```

For an AWS Serverless Application Model (AWS SAM) `AWS::Serverless::Function` resource, use the `Tracing` property.

Example [template.yml](#) – Tracing configuration

```
Resources:  
  function:
```

Type: [AWS::Serverless::Function](#)

Properties:

Tracing: Active

...

Interpreting an X-Ray trace

Your function needs permission to upload trace data to X-Ray. When you activate tracing in the Lambda console, Lambda adds the required permissions to your function's [execution role](#). Otherwise, add the [AWSXRayDaemonWriteAccess](#) policy to the execution role.

After you've configured active tracing, you can observe specific requests through your application. The [X-Ray service graph](#) shows information about your application and all its components. The following example shows an application with two functions. The primary function processes events and sometimes returns errors. The second function at the top processes errors that appear in the first's log group and uses the AWS SDK to call X-Ray, Amazon Simple Storage Service (Amazon S3), and Amazon CloudWatch Logs.



X-Ray doesn't trace all requests to your application. X-Ray applies a sampling algorithm to ensure that tracing is efficient, while still providing a representative sample of all requests. The sampling rate is 1 request per second and 5 percent of additional requests. You can't configure the X-Ray sampling rate for your functions.

In X-Ray, a *trace* records information about a request that is processed by one or more *services*. Lambda records 2 segments per trace, which creates two nodes on the service graph. The following image highlights these two nodes:

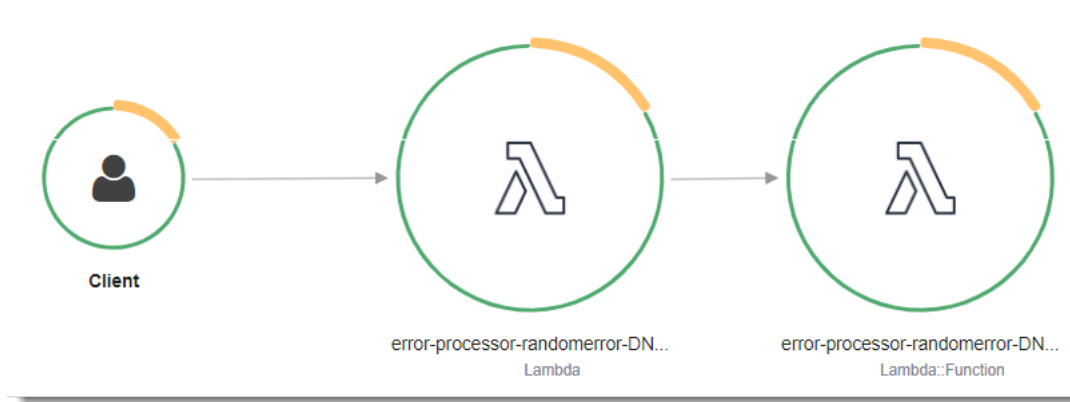

The first node on the left represents the Lambda service, which receives the invocation request. The second node represents your specific Lambda function. The following example shows a trace with these two segments. Both are named **my-function**, but one has an origin of `AWS::Lambda` and the other has an origin of `AWS::Lambda::Function`. If the `AWS::Lambda` segment shows an error, the Lambda service had an issue. If the `AWS::Lambda::Function` segment shows an error, your function had an issue.

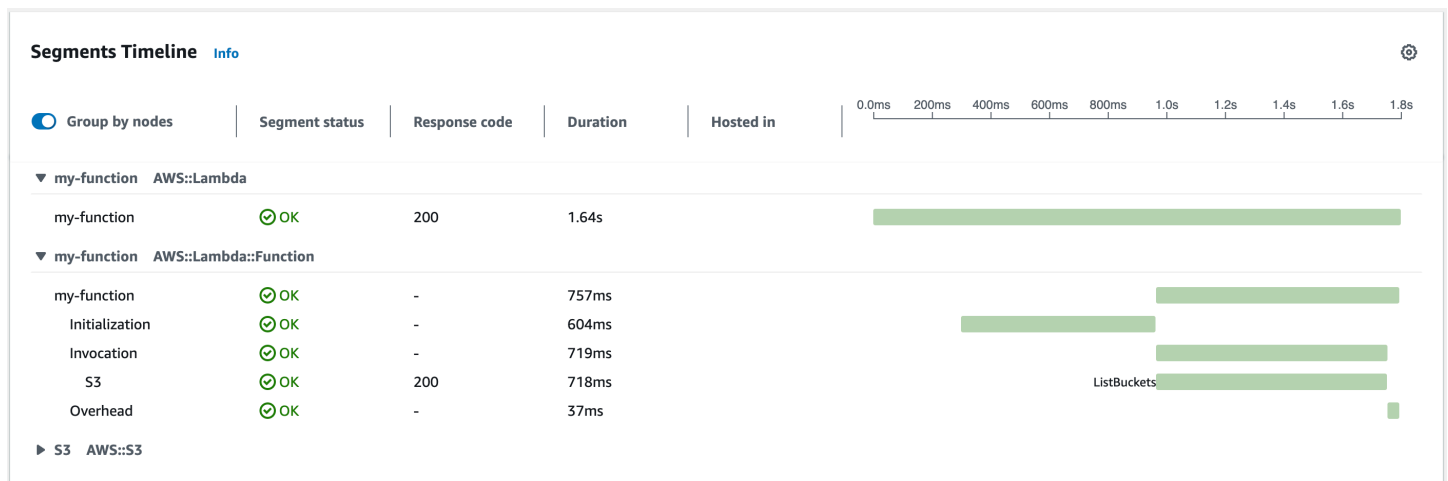

This example expands the `AWS::Lambda::Function` segment to show its three subsegments.

Note

AWS is currently implementing changes to the Lambda service. Due to these changes, you may see minor differences between the structure and content of system log messages and trace segments emitted by different Lambda functions in your AWS account. The example trace shown here illustrates the old-style function segment. The differences between the old- and new-style segments are described in the following paragraphs.

These changes will be implemented during the coming weeks, and all functions in all AWS Regions except the China and GovCloud regions will transition to use the new-format log messages and trace segments.

The old-style function segment contains the following subsegments:

- **Initialization** – Represents time spent loading your function and running [initialization code](#). This subsegment only appears for the first event that each instance of your function processes.
- **Invocation** – Represents the time spent running your handler code.
- **Overhead** – Represents the time the Lambda runtime spends preparing to handle the next event.

The new-style function segment doesn't contain an `Invocation` subsegment. Instead, customer subsegments are attached directly to the function segment. For more information about the structure of the old- and new-style function segments, see [the section called “Understanding X-Ray traces”](#).

You can also instrument HTTP clients, record SQL queries, and create custom subsegments with annotations and metadata. For more information, see the [AWS X-Ray SDK for .NET](#) in the *AWS X-Ray Developer Guide*.

Pricing

You can use X-Ray tracing for free each month up to a certain limit as part of the AWS Free Tier. Beyond that threshold, X-Ray charges for trace storage and retrieval. For more information, see [AWS X-Ray pricing](#).

AWS Lambda function testing in C#

Note

See the [Testing functions](#) chapter for a complete introduction to techniques and best practices for testing serverless solutions.

Testing serverless functions uses traditional test types and techniques, but you must also consider testing serverless applications as a whole. Cloud-based tests will provide the **most accurate** measure of quality of both your functions and serverless applications.

A serverless application architecture includes managed services that provide critical application functionality through API calls. For this reason, your development cycle should include automated tests that verify functionality when your function and services interact.

If you do not create cloud-based tests, you could encounter issues due to differences between your local environment and the deployed environment. Your continuous integration process should run tests against a suite of resources provisioned in the cloud before promoting your code to the next deployment environment, such as QA, Staging, or Production.

Continue reading this short guide to learn about testing strategies for serverless applications, or visit the [Serverless Test Samples repository](#) to dive in with practical examples, specific to your chosen language and runtime.

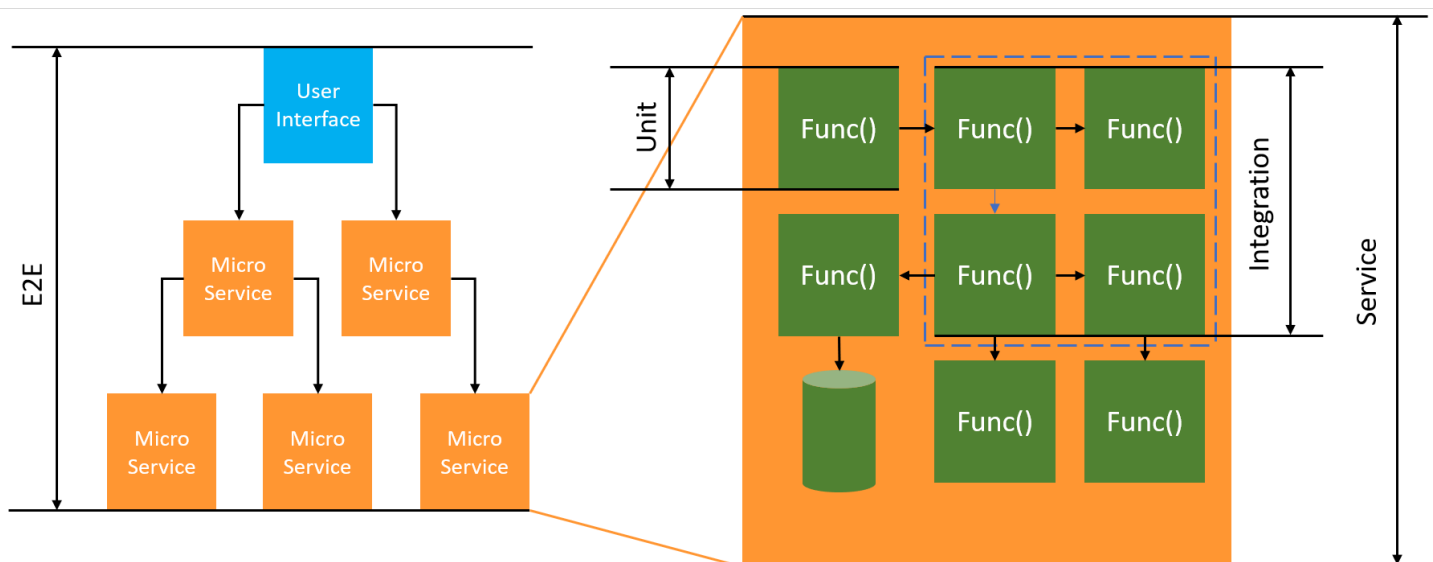

For serverless testing, you will still write *unit*, *integration* and *end-to-end* tests.

- **Unit tests** - Tests that run against an isolated block of code. For example, verifying the business logic to calculate the delivery charge given a particular item and destination.
- **Integration tests** - Tests involving two or more components or services that interact, typically in a cloud environment. For example, verifying a function processes events from a queue.
- **End-to-end tests** - Tests that verify behavior across an entire application. For example, ensuring infrastructure is set up correctly and that events flow between services as expected to record a customer's order.

Testing your serverless applications

You will generally use a mix of approaches to test your serverless application code, including testing in the cloud, testing with mocks, and occasionally testing with emulators.

Testing in the cloud

Testing in the cloud is valuable for all phases of testing, including unit tests, integration tests, and end-to-end tests. You run tests against code deployed in the cloud and interacting with cloud-based services. This approach provides the **most accurate** measure of quality of your code.

A convenient way to debug your Lambda function in the cloud is through the console with a test event. A *test event* is a JSON input to your function. If your function does not require input, the event can be an empty JSON document (`{}`). The console provides sample events for a variety of service integrations. After creating an event in the console, you can share it with your team to make testing easier and consistent.

Note

[Testing a function in the console](#) is a quick way to get started, but automating your test cycles ensures application quality and development speed.

Testing tools

To accelerate your development cycle, there are a number of tools and techniques you can use when testing your functions. For example, [AWS SAM Accelerate](#) and [AWS CDK watch mode](#) both decrease the time required to update cloud environments.

The way you define your Lambda function code makes it simple to add unit tests. Lambda requires a public, parameterless constructor to initialize your class. Introducing a second, internal constructor gives you control of the dependencies your application uses.

```
[assembly:
    LambdaSerializer(typeof(Amazon.Lambda.Serialization.SystemTextJson.DefaultLambdaJsonSerializer))

namespace GetProductHandler;

public class Function
{
    private readonly IDatabaseRepository _repo;

    public Function(): this(null)
    {
    }

    internal Function(IDatabaseRepository repo)
    {
        this._repo = repo ?? new DatabaseRepository();
    }

    public async Task<APIGatewayProxyResponse> FunctionHandler(APIGatewayProxyRequest
request)
    {
        var id = request.PathParameters["id"];

        var databaseRecord = await this._repo.GetById(id);

        return new APIGatewayProxyResponse
        {
            StatusCode = (int)HttpStatusCode.OK,
            Body = JsonSerializer.Serialize(databaseRecord)
        };
    }
}
```

To write a test for this function, you can initialize a new instance of your `Function` class and pass in a mocked implementation of the `IDatabaseRepository`. The below examples uses `XUnit`, `Moq`, and `FluentAssertions` to write a simple test ensuring the `FunctionHandler` returns a 200 status code.

```
using Xunit;
using Moq;
using FluentAssertions;

public class FunctionTests
{
    [Fact]
    public async Task TestLambdaHandler_WhenInputIsValid_ShouldReturn200StatusCode()
    {
        // Arrange
        var mockDatabaseRepository = new Mock<IDatabaseRepository>();

        var functionUnderTest = new Function(mockDatabaseRepository.Object);

        // Act
        var response = await functionUnderTest.FunctionHandler(new
APIGatewayProxyRequest());

        // Assert
        response.StatusCode.Should().Be(200);
    }
}
```

For more detailed examples, including examples of asynchronous tests, see the [.NET testing samples repository](#) on GitHub.

Building Lambda functions with PowerShell

The following sections explain how common programming patterns and core concepts apply when you author Lambda function code in PowerShell.

Lambda provides the following sample applications for PowerShell:

- [blank-powershell](#) – A PowerShell function that shows the use of logging, environment variables, and the AWS SDK.

Before you get started, you must first set up a PowerShell development environment. For instructions on how to do this, see [Setting Up a PowerShell Development Environment](#).

To learn about how to use the AWSLambdaPSCore module to download sample PowerShell projects from templates, create PowerShell deployment packages, and deploy PowerShell functions to the AWS Cloud, see [Deploy PowerShell Lambda functions with .zip file archives](#).

Lambda provides the following runtimes for .NET languages:

Name	Identifier	Operating system	Deprecation date	Block function create	Block function update
.NET 8	dotnet8	Amazon Linux 2023	Not scheduled	Not scheduled	Not scheduled

Topics

- [Setting Up a PowerShell Development Environment](#)
- [Deploy PowerShell Lambda functions with .zip file archives](#)
- [Define Lambda function handler in PowerShell](#)
- [Using the Lambda context object to retrieve PowerShell function information](#)
- [Log and monitor Powershell Lambda functions](#)

Setting Up a PowerShell Development Environment

Lambda provides a set of tools and libraries for the PowerShell runtime. For installation instructions, see [Lambda tools for PowerShell](#) on GitHub.

The AWSLambdaPSCore module includes the following cmdlets to help author and publish PowerShell Lambda functions:

- **Get-AWSPowerShellLambdaTemplate** – Returns a list of getting started templates.
- **New-AWSPowerShellLambda** – Creates an initial PowerShell script based on a template.
- **Publish-AWSPowerShellLambda** – Publishes a given PowerShell script to Lambda.
- **New-AWSPowerShellLambdaPackage** – Creates a Lambda deployment package that you can use in a CI/CD system for deployment.

Deploy PowerShell Lambda functions with .zip file archives

A deployment package for the PowerShell runtime contains your PowerShell script, PowerShell modules that are required for your PowerShell script, and the assemblies needed to host PowerShell Core.

Creating the Lambda function

To get started writing and invoking a PowerShell script with Lambda, you can use the `New-AWSPowerShellLambda` cmdlet to create a starter script based on a template. You can use the `Publish-AWSPowerShellLambda` cmdlet to deploy your script to Lambda. Then you can test your script either through the command line or the Lambda console.

To create a new PowerShell script, upload it, and test it, do the following:

1. To view the list of available templates, run the following command:

```
PS C:\> Get-AWSPowerShellLambdaTemplate

Template          Description
-----          -
Basic             Bare bones script
CodeCommitTrigger Script to process AWS CodeCommit Triggers
...
```

2. To create a sample script based on the Basic template, run the following command:

```
New-AWSPowerShellLambda -ScriptName MyFirstPSScript -Template Basic
```

A new file named `MyFirstPSScript.ps1` is created in a new subdirectory of the current directory. The name of the directory is based on the `-ScriptName` parameter. You can use the `-Directory` parameter to choose an alternative directory.

You can see that the new file has the following contents:

```
# PowerShell script file to run as a Lambda function
#
# When executing in Lambda the following variables are predefined.
# $LambdaInput - A PSObject that contains the Lambda function input data.
# $LambdaContext - An Amazon.Lambda.Core.ILambdaContext object that contains
information about the currently running Lambda environment.
```

```
#  
# The last item in the PowerShell pipeline is returned as the result of the Lambda  
function.  
#  
# To include PowerShell modules with your Lambda function, like the  
AWSPowerShell.NetCore module, add a "#Requires" statement  
# indicating the module and version.  
  
#Requires -Modules @{ModuleName='AWSPowerShell.NetCore';ModuleVersion='3.3.618.0'}  
  
# Uncomment to send the input to CloudWatch Logs  
# Write-Host (ConvertTo-Json -InputObject $LambdaInput -Compress -Depth 5)
```

3. To see how log messages from your PowerShell script are sent to Amazon CloudWatch Logs, uncomment the `Write-Host` line of the sample script.

To demonstrate how you can return data back from your Lambda functions, add a new line at the end of the script with `$PSVersionTable`. This adds the `$PSVersionTable` to the PowerShell pipeline. After the PowerShell script is complete, the last object in the PowerShell pipeline is the return data for the Lambda function. `$PSVersionTable` is a PowerShell global variable that also provides information about the running environment.

After making these changes, the last two lines of the sample script look like this:

```
Write-Host (ConvertTo-Json -InputObject $LambdaInput -Compress -Depth 5)  
$PSVersionTable
```

4. After editing the `MyFirstPSScript.ps1` file, change the directory to the script's location. Then run the following command to publish the script to Lambda:

```
Publish-AWSPowerShellLambda -ScriptPath .\MyFirstPSScript.ps1 -Name  
MyFirstPSScript -Region us-east-2
```

Note that the `-Name` parameter specifies the Lambda function name, which appears in the Lambda console. You can use this function to invoke your script manually.

5. Invoke your function using the AWS Command Line Interface (AWS CLI) `invoke` command.

```
> aws lambda invoke --function-name MyFirstPSScript out
```

Define Lambda function handler in PowerShell

When a Lambda function is invoked, the Lambda handler invokes the PowerShell script.

When the PowerShell script is invoked, the following variables are predefined:

- ***\$LambdaInput*** – A PSObject that contains the input to the handler. This input can be event data (published by an event source) or custom input that you provide, such as a string or any custom data object.
- ***\$LambdaContext*** – An Amazon.Lambda.Core.ILambdaContext object that you can use to access information about the current invocation—such as the name of the current function, the memory limit, execution time remaining, and logging.

For example, consider the following PowerShell example code.

```
#Requires -Modules @{ModuleName='AWSPowerShell.NetCore';ModuleVersion='3.3.618.0'}  
Write-Host 'Function Name:' $LambdaContext.FunctionName
```

This script returns the `FunctionName` property that's obtained from the `$LambdaContext` variable.

Note

You're required to use the `#Requires` statement within your PowerShell scripts to indicate the modules that your scripts depend on. This statement performs two important tasks. 1) It communicates to other developers which modules the script uses, and 2) it identifies the dependent modules that AWS PowerShell tools need to package with the script, as part of the deployment. For more information about the `#Requires` statement in PowerShell, see [About requires](#). For more information about PowerShell deployment packages, see [Deploy PowerShell Lambda functions with .zip file archives](#).

When your PowerShell Lambda function uses the AWS PowerShell cmdlets, be sure to set a `#Requires` statement that references the `AWSPowerShell.NetCore` module, which supports PowerShell Core—and not the `AWSPowerShell` module, which only supports Windows PowerShell. Also, be sure to use version 3.3.270.0 or newer of `AWSPowerShell.NetCore` which optimizes the cmdlet import process. If you use an older version, you'll experience longer cold starts. For more information, see [AWS Tools for PowerShell](#).

Returning data

Some Lambda invocations are meant to return data back to their caller. For example, if an invocation was in response to a web request coming from API Gateway, then our Lambda function needs to return back the response. For PowerShell Lambda, the last object that's added to the PowerShell pipeline is the return data from the Lambda invocation. If the object is a string, the data is returned as is. Otherwise the object is converted to JSON by using the `ConvertTo-Json` cmdlet.

For example, consider the following PowerShell statement, which adds `$PSVersionTable` to the PowerShell pipeline:

```
$PSVersionTable
```

After the PowerShell script is finished, the last object in the PowerShell pipeline is the return data for the Lambda function. `$PSVersionTable` is a PowerShell global variable that also provides information about the running environment.

Using the Lambda context object to retrieve PowerShell function information

When Lambda runs your function, it passes context information by making a `$LambdaContext` variable available to the [handler](#). This variable provides methods and properties with information about the invocation, function, and execution environment.

Context properties

- `FunctionName` – The name of the Lambda function.
- `FunctionVersion` – The [version](#) of the function.
- `InvokedFunctionArn` – The Amazon Resource Name (ARN) that's used to invoke the function. Indicates if the invoker specified a version number or alias.
- `MemoryLimitInMB` – The amount of memory that's allocated for the function.
- `AwsRequestId` – The identifier of the invocation request.
- `LogGroupName` – The log group for the function.
- `LogStreamName` – The log stream for the function instance.
- `RemainingTime` – The number of milliseconds left before the execution times out.
- `Identity` – (mobile apps) Information about the Amazon Cognito identity that authorized the request.
- `ClientContext` – (mobile apps) Client context that's provided to Lambda by the client application.
- `Logger` – The [logger object](#) for the function.

The following PowerShell code snippet shows a simple handler function that prints some of the context information.

```
#Requires -Modules @{ModuleName='AWSPowerShell.NetCore';ModuleVersion='3.3.618.0'}
Write-Host 'Function name:' $LambdaContext.FunctionName
Write-Host 'Remaining milliseconds:' $LambdaContext.RemainingTime.TotalMilliseconds
Write-Host 'Log group name:' $LambdaContext.LogGroupName
Write-Host 'Log stream name:' $LambdaContext.LogStreamName
```

Log and monitor Powershell Lambda functions

AWS Lambda automatically monitors Lambda functions on your behalf and sends logs to Amazon CloudWatch. Your Lambda function comes with a CloudWatch Logs log group and a log stream for each instance of your function. The Lambda runtime environment sends details about each invocation to the log stream, and relays logs and other output from your function's code. For more information, see [Using CloudWatch Logs with Lambda](#).

This page describes how to produce log output from your Lambda function's code, and access logs using the AWS Command Line Interface, the Lambda console, or the CloudWatch console.

Sections

- [Creating a function that returns logs](#)
- [Viewing logs in the Lambda console](#)
- [Viewing logs in the CloudWatch console](#)
- [Viewing logs using the AWS Command Line Interface \(AWS CLI\)](#)
- [Deleting logs](#)

Creating a function that returns logs

To output logs from your function code, you can use cmdlets on [Microsoft.PowerShell.Utility](#), or any logging module that writes to `stdout` or `stderr`. The following example uses `Write-Host`.

Example [function/Handler.ps1](#) – Logging

```
#Requires -Modules @{ModuleName='AWSPowerShell.NetCore';ModuleVersion='3.3.618.0'}
Write-Host `## Environment variables
Write-Host AWS_LAMBDA_FUNCTION_VERSION=$Env:AWS_LAMBDA_FUNCTION_VERSION
Write-Host AWS_LAMBDA_LOG_GROUP_NAME=$Env:AWS_LAMBDA_LOG_GROUP_NAME
Write-Host AWS_LAMBDA_LOG_STREAM_NAME=$Env:AWS_LAMBDA_LOG_STREAM_NAME
Write-Host AWS_EXECUTION_ENV=$Env:AWS_EXECUTION_ENV
Write-Host AWS_LAMBDA_FUNCTION_NAME=$Env:AWS_LAMBDA_FUNCTION_NAME
Write-Host PATH=$Env:PATH
Write-Host `## Event
Write-Host (ConvertTo-Json -InputObject $LambdaInput -Compress -Depth 3)
```

Example log format

```
START RequestId: 56639408-xmpl-435f-9041-ac47ae25ceed Version: $LATEST
```

```

Importing module ./Modules/AWSPowerShell.NetCore/3.3.618.0/AWSPowerShell.NetCore.psd1
[Information] - ## Environment variables
[Information] - AWS_LAMBDA_FUNCTION_VERSION=$LATEST
[Information] - AWS_LAMBDA_LOG_GROUP_NAME=/aws/lambda/blank-powershell-
function-18CIXMPLHFAJJ
[Information] - AWS_LAMBDA_LOG_STREAM_NAME=2020/04/01/
[$LATEST]53c5xmpl152d64ed3a744724d9c201089
[Information] - AWS_EXECUTION_ENV=AWS_Lambda_dotnet6_powershell_1.0.0
[Information] - AWS_LAMBDA_FUNCTION_NAME=blank-powershell-function-18CIXMPLHFAJJ
[Information] - PATH=/var/lang/bin:/usr/local/bin:/usr/bin/./bin:/opt/bin
[Information] - ## Event
[Information] -
{
  "Records": [
    {
      "messageId": "19dd0b57-b21e-4ac1-bd88-01bbb068cb78",
      "receiptHandle": "MessageReceiptHandle",
      "body": "Hello from SQS!",
      "attributes": {
        "ApproximateReceiveCount": "1",
        "SentTimestamp": "1523232000000",
        "SenderId": "123456789012",
        "ApproximateFirstReceiveTimestamp": "1523232000001"
      },
      ...
    }
  ]
}
END RequestId: 56639408-xmpl-435f-9041-ac47ae25ceed
REPORT RequestId: 56639408-xmpl-435f-9041-ac47ae25ceed Duration: 3906.38 ms Billed
Duration: 4000 ms Memory Size: 512 MB Max Memory Used: 367 MB Init Duration: 5960.19
ms
XRAY TraceId: 1-5e843da6-733cxmple7d0c3c020510040 SegmentId: 3913xmpl20999446 Sampled:
true

```

The .NET runtime logs the START, END, and REPORT lines for each invocation. The report line provides the following details.

REPORT line data fields

- **RequestId** – The unique request ID for the invocation.
- **Duration** – The amount of time that your function's handler method spent processing the event.
- **Billed Duration** – The amount of time billed for the invocation.
- **Memory Size** – The amount of memory allocated to the function.

- **Max Memory Used** – The amount of memory used by the function. When invocations share an execution environment, Lambda reports the maximum memory used across all invocations. This behavior might result in a higher than expected reported value.
- **Init Duration** – For the first request served, the amount of time it took the runtime to load the function and run code outside of the handler method.
- **XRAY TraceId** – For traced requests, the [AWS X-Ray trace ID](#).
- **SegmentId** – For traced requests, the X-Ray segment ID.
- **Sampled** – For traced requests, the sampling result.

Viewing logs in the Lambda console

You can use the Lambda console to view log output after you invoke a Lambda function.

If your code can be tested from the embedded **Code** editor, you will find logs in the **execution results**. When you use the console test feature to invoke a function, you'll find **Log output** in the **Details** section.

Viewing logs in the CloudWatch console

You can use the Amazon CloudWatch console to view logs for all Lambda function invocations.

To view logs on the CloudWatch console

1. Open the [Log groups page](#) on the CloudWatch console.
2. Choose the log group for your function (`/aws/lambda/your-function-name`).
3. Choose a log stream.

Each log stream corresponds to an [instance of your function](#). A log stream appears when you update your Lambda function, and when additional instances are created to handle multiple concurrent invocations. To find logs for a specific invocation, we recommend instrumenting your function with AWS X-Ray. X-Ray records details about the request and the log stream in the trace.

Viewing logs using the AWS Command Line Interface (AWS CLI)

The AWS CLI is an open-source tool that enables you to interact with AWS services using commands in your command line shell. To complete the steps in this section, you must have the [AWS CLI version 2](#).

You can use the [AWS CLI](#) to retrieve logs for an invocation using the `--log-type` command option. The response contains a `LogResult` field that contains up to 4 KB of base64-encoded logs from the invocation.

Example retrieve a log ID

The following example shows how to retrieve a *log ID* from the `LogResult` field for a function named `my-function`.

```
aws lambda invoke --function-name my-function out --log-type Tail
```

You should see the following output:

```
{
  "StatusCode": 200,
  "LogResult":
  "U1RBULQgUmVxdWVzdElk0iA4N2QwNDRiOC1mMTU0LTExZTgtOGNkYS0yOTc0YzVlNGZiMjEgVmVyc2lvc21vb... ",
  "ExecutedVersion": "$LATEST"
}
```

Example decode the logs

In the same command prompt, use the `base64` utility to decode the logs. The following example shows how to retrieve base64-encoded logs for `my-function`.

```
aws lambda invoke --function-name my-function out --log-type Tail \
--query 'LogResult' --output text --cli-binary-format raw-in-base64-out | base64 --
decode
```

The `cli-binary-format` option is required if you're using AWS CLI version 2. To make this the default setting, run `aws configure set cli-binary-format raw-in-base64-out`. For more information, see [AWS CLI supported global command line options](#) in the *AWS Command Line Interface User Guide for Version 2*.

You should see the following output:

```
START RequestId: 57f231fb-1730-4395-85cb-4f71bd2b87b8 Version: $LATEST
"AWS_SESSION_TOKEN": "AgoJb3JpZ2luX2VjELj...", "_X_AMZN_TRACE_ID": "Root=1-5d02e5ca-
f5792818b6fe8368e5b51d50;Parent=191db58857df8395;Sampled=0",ask/lib:/opt/lib",
```

```
END RequestId: 57f231fb-1730-4395-85cb-4f71bd2b87b8
REPORT RequestId: 57f231fb-1730-4395-85cb-4f71bd2b87b8  Duration: 79.67 ms      Billed
Duration: 80 ms      Memory Size: 128 MB      Max Memory Used: 73 MB
```

The `base64` utility is available on Linux, macOS, and [Ubuntu on Windows](#). macOS users may need to use `base64 -D`.

Example `get-logs.sh` script

In the same command prompt, use the following script to download the last five log events. The script uses `sed` to remove quotes from the output file, and sleeps for 15 seconds to allow time for the logs to become available. The output includes the response from Lambda and the output from the `get-log-events` command.

Copy the contents of the following code sample and save in your Lambda project directory as `get-logs.sh`.

The `cli-binary-format` option is required if you're using AWS CLI version 2. To make this the default setting, run `aws configure set cli-binary-format raw-in-base64-out`. For more information, see [AWS CLI supported global command line options](#) in the *AWS Command Line Interface User Guide for Version 2*.

```
#!/bin/bash
aws lambda invoke --function-name my-function --cli-binary-format raw-in-base64-out --
payload '{"key": "value"}' out
sed -i'' -e 's/"//g' out
sleep 15
aws logs get-log-events --log-group-name /aws/lambda/my-function --log-stream-
name stream1 --limit 5
```

Example macOS and Linux (only)

In the same command prompt, macOS and Linux users may need to run the following command to ensure the script is executable.

```
chmod -R 755 get-logs.sh
```

Example retrieve the last five log events

In the same command prompt, run the following script to get the last five log events.

```
./get-logs.sh
```

You should see the following output:

```
{
  "statusCode": 200,
  "executedVersion": "$LATEST"
}
{
  "events": [
    {
      "timestamp": 1559763003171,
      "message": "START RequestId: 4ce9340a-b765-490f-ad8a-02ab3415e2bf Version:
$LATEST\n",
      "ingestionTime": 1559763003309
    },
    {
      "timestamp": 1559763003173,
      "message": "2019-06-05T19:30:03.173Z\t4ce9340a-b765-490f-ad8a-02ab3415e2bf
\tINFO\tENVIRONMENT VARIABLES\r{\r  \"AWS_LAMBDA_FUNCTION_VERSION\": \"\n$LATEST\n",
\r ...",
      "ingestionTime": 1559763018353
    },
    {
      "timestamp": 1559763003173,
      "message": "2019-06-05T19:30:03.173Z\t4ce9340a-b765-490f-ad8a-02ab3415e2bf
\tINFO\tEVENT\r{\r  \"key\": \"value\"\r}\n",
      "ingestionTime": 1559763018353
    },
    {
      "timestamp": 1559763003218,
      "message": "END RequestId: 4ce9340a-b765-490f-ad8a-02ab3415e2bf\n",
      "ingestionTime": 1559763018353
    },
    {
      "timestamp": 1559763003218,
      "message": "REPORT RequestId: 4ce9340a-b765-490f-ad8a-02ab3415e2bf
\tDuration: 26.73 ms\tBilled Duration: 27 ms \tMemory Size: 128 MB\tMax Memory Used: 75
MB\t\n",
      "ingestionTime": 1559763018353
    }
  ],
  "nextForwardToken": "f/34783877304859518393868359594929986069206639495374241795",
}
```



```
"nextBackwardToken": "b/34783877303811383369537420289090800615709599058929582080"  
}
```

Deleting logs

Log groups aren't deleted automatically when you delete a function. To avoid storing logs indefinitely, delete the log group, or [configure a retention period](#) after which logs are deleted automatically.

Building Lambda functions with Rust

Because Rust compiles to native code, you don't need a dedicated runtime to run Rust code on Lambda. Instead, use the [Rust runtime client](#) to build your project locally, and then deploy it to Lambda using the `provided.al2023` or `provided.al2` runtime. When you use `provided.al2023` or `provided.al2`, Lambda automatically keeps the operating system up to date with the latest patches.

Note

The [Rust runtime client](#) is an experimental package. It is subject to change and intended only for evaluation purposes.

Tools and libraries for Rust

- [AWS SDK for Rust](#): The AWS SDK for Rust provides Rust APIs to interact with Amazon Web Services infrastructure services.
- [Rust runtime client for Lambda](#): The Rust runtime client is an experimental package. It is subject to breaking changes and not recommended for production.
- [Cargo Lambda](#): This library provides a command line application to work with Lambda functions built with Rust.
- [Lambda HTTP](#): This library provides a wrapper to work with HTTP events.
- [Lambda Extension](#): This library provides support to write Lambda Extensions with Rust.
- [AWS Lambda Events](#): This library provides type definitions for common event source integrations.

Sample Lambda applications for Rust

- [Basic Lambda function](#): A Rust function that shows how to process basic events.
- [Lambda function with error handling](#): A Rust function that shows how to handle custom Rust errors in Lambda.
- [Lambda function with shared resources](#): A Rust project that initializes shared resources before creating the Lambda function.
- [Lambda HTTP events](#): A Rust function that handles HTTP events.

- [Lambda HTTP events with CORS headers](#): A Rust function that uses Tower to inject CORS headers.
- [Lambda REST API](#): A REST API that uses Axum and Diesel to connect to a PostgreSQL database.
- [Serverless Rust demo](#): A Rust project that shows the use of Lambda's Rust libraries, logging, environment variables, and the AWS SDK.
- [Basic Lambda Extension](#): A Rust extension that shows how to process basic extension events.
- [Lambda Logs Amazon Data Firehose Extension](#): A Rust extension that shows how to send Lambda logs to Firehose.

Topics

- [Define Lambda function handler in Rust](#)
- [Using the Lambda context object to retrieve Rust function information](#)
- [Processing HTTP events with Rust](#)
- [Deploy Rust Lambda functions with .zip file archives](#)
- [Log and monitor Rust Lambda functions](#)

Define Lambda function handler in Rust

Note

The [Rust runtime client](#) is an experimental package. It is subject to change and intended only for evaluation purposes.

The Lambda function *handler* is the method in your function code that processes events. When your function is invoked, Lambda runs the handler method. Your function runs until the handler returns a response, exits, or times out.

Topics

- [Rust handler basics](#)
- [Using shared state](#)
- [Code best practices for Rust Lambda functions](#)

Rust handler basics

Write your Lambda function code as a Rust executable. Implement the handler function code and a main function and include the following:

- The [lambda_runtime](#) crate from crates.io, which implements the Lambda programming model for Rust.
- Include [Tokio](#) in your dependencies. The [Rust runtime client for Lambda](#) uses Tokio to handle asynchronous calls.

Example — Rust handler that processes JSON events

The following example uses the [serde_json](#) crate to process basic JSON events:

```
use lambda_runtime::{service_fn, LambdaEvent, Error};
use serde_json::{json, Value};

async fn handler(event: LambdaEvent<Value>) -> Result<Value, Error> {
    let payload = event.payload;
    let first_name = payload["firstName"].as_str().unwrap_or("world");
```

```
Ok(json!({ "message": format!("Hello, {first_name}!") }))
}

#[tokio::main]
async fn main() -> Result<(), Error> {
    lambda_runtime::run(service_fn(handler)).await
}
```

Note the following:

- `use`: Imports the libraries that your Lambda function requires.
- `async fn main`: The entry point that runs the Lambda function code. The Rust runtime client uses [Tokio](#) as an async runtime, so you must annotate the main function with `#[tokio::main]`.
- `async fn handler(event: LambdaEvent<Value>) -> Result<Value, Error>`: This is the Lambda handler signature. It includes the code that runs when the function is invoked.
 - `LambdaEvent<Value>`: This is a generic type that describes the event received by the Lambda runtime as well as the [Lambda function context](#).
 - `Result<Value, Error>`: The function returns a `Result` type. If the function is successful, the result is a JSON value. If the function is not successful, the result is an error.

Using shared state

You can declare shared variables that are independent of your Lambda function's handler code. These variables can help you load state information during the [init phase](#), before your function receives any events.

Example — Share Amazon S3 client across function instances

Note the following:

- `use aws_sdk_s3::Client`: This example requires you to add `aws-sdk-s3 = "0.26.0"` to the list of dependencies in your `Cargo.toml` file.
- `aws_config::from_env`: This example requires you to add `aws-config = "0.55.1"` to the list of dependencies in your `Cargo.toml` file.

```
use aws_sdk_s3::Client;
use lambda_runtime::{service_fn, Error, LambdaEvent};
use serde::{Deserialize, Serialize};
```

```
#[derive(Deserialize)]
struct Request {
    bucket: String,
}

#[derive(Serialize)]
struct Response {
    keys: Vec<String>,
}

async fn handler(client: &Client, event: LambdaEvent<Request>) -> Result<Response,
Error> {
    let bucket = event.payload.bucket;
    let objects = client.list_objects_v2().bucket(bucket).send().await?;
    let keys = objects
        .contents()
        .map(|s| s.iter().flat_map(|o| o.key().map(String::from)).collect())
        .unwrap_or_default();
    Ok(Response { keys })
}

#[tokio::main]
async fn main() -> Result<(), Error> {
    let shared_config = aws_config::from_env().load().await;
    let client = Client::new(&shared_config);
    let shared_client = &client;
    lambda_runtime::run(service_fn(move |event: LambdaEvent<Request>| async move {
        handler(&shared_client, event).await
    })))
    .await
}
```

Code best practices for Rust Lambda functions

Adhere to the guidelines in the following list to use best coding practices when building your Lambda functions:

- **Separate the Lambda handler from your core logic.** This allows you to make a more unit-testable function.
- **Minimize the complexity of your dependencies.** Prefer simpler frameworks that load quickly on [execution environment](#) startup.

- **Minimize your deployment package size to its runtime necessities.** This will reduce the amount of time that it takes for your deployment package to be downloaded and unpacked ahead of invocation.
- **Take advantage of execution environment reuse to improve the performance of your function.** Initialize SDK clients and database connections outside of the function handler, and cache static assets locally in the `/tmp` directory. Subsequent invocations processed by the same instance of your function can reuse these resources. This saves cost by reducing function run time.

To avoid potential data leaks across invocations, don't use the execution environment to store user data, events, or other information with security implications. If your function relies on a mutable state that can't be stored in memory within the handler, consider creating a separate function or separate versions of a function for each user.

- **Use a keep-alive directive to maintain persistent connections.** Lambda purges idle connections over time. Attempting to reuse an idle connection when invoking a function will result in a connection error. To maintain your persistent connection, use the keep-alive directive associated with your runtime. For an example, see [Reusing Connections with Keep-Alive in Node.js](#).
- **Use [environment variables](#) to pass operational parameters to your function.** For example, if you are writing to an Amazon S3 bucket, instead of hard-coding the bucket name you are writing to, configure the bucket name as an environment variable.
- **Avoid using recursive invocations** in your Lambda function, where the function invokes itself or initiates a process that may invoke the function again. This could lead to unintended volume of function invocations and escalated costs. If you see an unintended volume of invocations, set the function reserved concurrency to `0` immediately to throttle all invocations to the function, while you update the code.
- **Do not use non-documented, non-public APIs** in your Lambda function code. For AWS Lambda managed runtimes, Lambda periodically applies security and functional updates to Lambda's internal APIs. These internal API updates may be backwards-incompatible, leading to unintended consequences such as invocation failures if your function has a dependency on these non-public APIs. See [the API reference](#) for a list of publicly available APIs.
- **Write idempotent code.** Writing idempotent code for your functions ensures that duplicate events are handled the same way. Your code should properly validate events and gracefully handle duplicate events. For more information, see [How do I make my Lambda function idempotent?](#)

Using the Lambda context object to retrieve Rust function information

Note

The [Rust runtime client](#) is an experimental package. It is subject to change and intended only for evaluation purposes.

When Lambda runs your function, it adds a context object to the `LambdaEvent` that the [handler](#) receives. This object provides properties with information about the invocation, function, and execution environment.

Context properties

- `request_id`: The AWS request ID generated by the Lambda service.
- `deadline`: The execution deadline for the current invocation in milliseconds.
- `invoked_function_arn`: The Amazon Resource Name (ARN) of the Lambda function being invoked.
- `xray_trace_id`: The AWS X-Ray trace ID for the current invocation.
- `client_content`: The client context object sent by the AWS mobile SDK. This field is empty unless the function is invoked using an AWS mobile SDK.
- `identity`: The Amazon Cognito identity that invoked the function. This field is empty unless the invocation request to the Lambda APIs was made using AWS credentials issued by Amazon Cognito identity pools.
- `env_config`: The Lambda function configuration from the local environment variables. This property includes information such as the function name, memory allocation, version, and log streams.

Accessing invoke context information

Lambda functions have access to metadata about their environment and the invocation request. The `LambdaEvent` object that your function handler receives includes the context metadata:

```
use lambda_runtime::{service_fn, LambdaEvent, Error};
```

```
use serde_json::{json, Value};

async fn handler(event: LambdaEvent<Value>) -> Result<Value, Error> {
    let invoked_function_arn = event.context.invoked_function_arn;
    Ok(json!({ "message": format!("Hello, this is function
{invoked_function_arn}!") }))
}

#[tokio::main]
async fn main() -> Result<(), Error> {
    lambda_runtime::run(service_fn(handler)).await
}
```

Processing HTTP events with Rust

Note

The [Rust runtime client](#) is an experimental package. It is subject to change and intended only for evaluation purposes.

Amazon API Gateway APIs, Application Load Balancers, and [Lambda function URLs](#) can send HTTP events to Lambda. You can use the [aws_lambda_events](#) crate from crates.io to process events from these sources.

Example — Handle API Gateway proxy request

Note the following:

- use `aws_lambda_events::apigw::{ApiGatewayProxyRequest, ApiGatewayProxyResponse}`: The [aws_lambda_events](#) crate includes many Lambda events. To reduce compilation time, use feature flags to activate the events you need. Example:
`aws_lambda_events = { version = "0.8.3", default-features = false, features = ["apigw"] }`.
- use `http::HeaderMap`: This import requires you to add the [http](#) crate to your dependencies.

```
use aws_lambda_events::apigw::{ApiGatewayProxyRequest, ApiGatewayProxyResponse};
use http::HeaderMap;
use lambda_runtime::{service_fn, Error, LambdaEvent};

async fn handler(
    _event: LambdaEvent<ApiGatewayProxyRequest>,
) -> Result<ApiGatewayProxyResponse, Error> {
    let mut headers = HeaderMap::new();
    headers.insert("content-type", "text/html".parse().unwrap());
    let resp = ApiGatewayProxyResponse {
        status_code: 200,
        multi_value_headers: headers.clone(),
        is_base64_encoded: false,
        body: Some("Hello AWS Lambda HTTP request".into()),
        headers,
    };
};
```

```
    Ok(resp)
}

#[tokio::main]
async fn main() -> Result<(), Error> {
    lambda_runtime::run(service_fn(handler)).await
}
```

The [Rust runtime client for Lambda](#) also provides an abstraction over these event types that allows you to work with native HTTP types, regardless of which service sends the events. The following code is equivalent to the previous example, and it works out of the box with Lambda function URLs, Application Load Balancers, and API Gateway.

Note

The [lambda_http](#) crate uses the [lambda_runtime](#) crate underneath. You don't have to import `lambda_runtime` separately.

Example — Handle HTTP requests

```
use lambda_http::{service_fn, Error, IntoResponse, Request, RequestExt, Response};

async fn handler(event: Request) -> Result<impl IntoResponse, Error> {
    let resp = Response::builder()
        .status(200)
        .header("content-type", "text/html")
        .body("Hello AWS Lambda HTTP request")
        .map_err(Box::new)?;
    Ok(resp)
}

#[tokio::main]
async fn main() -> Result<(), Error> {
    lambda_http::run(service_fn(handler)).await
}
```

For another example of how to use `lambda_http`, see the [http-axum code sample](#) on the AWS Labs GitHub repository.

Sample HTTP Lambda events for Rust

- [Lambda HTTP events](#): A Rust function that handles HTTP events.
- [Lambda HTTP events with CORS headers](#): A Rust function that uses Tower to inject CORS headers.
- [Lambda HTTP events with shared resources](#): A Rust function that uses shared resources initialized before the function handler is created.

Deploy Rust Lambda functions with .zip file archives

Note

The [Rust runtime client](#) is an experimental package. It is subject to change and intended only for evaluation purposes.

This page describes how to compile your Rust function, and then deploy the compiled binary to AWS Lambda using [Cargo Lambda](#). It also shows how to deploy the compiled binary with the AWS Command Line Interface and the AWS Serverless Application Model CLI.

Sections

- [Prerequisites](#)
- [Building Rust functions on macOS, Windows, or Linux](#)
- [Deploying the Rust function binary with Cargo Lambda](#)
- [Invoking your Rust function with Cargo Lambda](#)

Prerequisites

- [Rust](#)
- [AWS CLI version 2](#)

Building Rust functions on macOS, Windows, or Linux

The following steps demonstrate how to create the project for your first Lambda function with Rust and compile it with [Cargo Lambda](#).

1. Install Cargo Lambda, a Cargo subcommand, that compiles Rust functions for Lambda on macOS, Windows, and Linux.

To install Cargo Lambda on any system that has Python 3 installed, use pip:

```
pip3 install cargo-lambda
```

To install Cargo Lambda on macOS or Linux, use Homebrew:

```
brew tap cargo-lambda/cargo-lambda
brew install cargo-lambda
```

To install Cargo Lambda on Windows, use [Scoop](#):

```
scoop bucket add cargo-lambda
scoop install cargo-lambda/cargo-lambda
```

For other options, see [Installation](#) in the Cargo Lambda documentation.

2. Create the package structure. This command creates some basic function code in `src/main.rs`. You can use this code for testing or replace it with your own.

```
cargo lambda new my-function
```

3. Inside the package's root directory, run the [build](#) subcommand to compile the code in your function.

```
cargo lambda build --release
```

(Optional) If you want to use AWS Graviton2 on Lambda, add the `--arm64` flag to compile your code for ARM CPUs.

```
cargo lambda build --release --arm64
```

4. Before deploying your Rust function, configure AWS credentials on your machine.

```
aws configure
```

Deploying the Rust function binary with Cargo Lambda

Use the [deploy](#) subcommand to deploy the compiled binary to Lambda. This command creates an [execution role](#) and then creates the Lambda function. To specify an existing execution role, use the [--iam-role flag](#).

```
cargo lambda deploy my-function
```

Deploying your Rust function binary with the AWS CLI

You can also deploy your binary with the AWS CLI.

1. Use the [build](#) subcommand to build the .zip deployment package.

```
cargo lambda build --release --output-format zip
```

2. To deploy the .zip package to Lambda, run the [create-function](#) command.
 - For `--runtime`, specify `provided.al2023`. This is an [OS-only runtime](#). OS-only runtimes are used to deploy compiled binaries and custom runtimes to Lambda.
 - For `--role`, specify the ARN of the [execution role](#).

```
aws lambda create-function \  
  --function-name my-function \  
  --runtime provided.al2023 \  
  --role arn:aws:iam::111122223333:role/lambda-role \  
  --handler rust.handler \  
  --zip-file fileb://target/lambda/my-function/bootstrap.zip
```

Deploying your Rust function binary with the AWS SAM CLI

You can also deploy your binary with the AWS SAM CLI.

1. Create an AWS SAM template with the resource and property definition. For `Runtime`, specify `provided.al2023`. This is an [OS-only runtime](#). OS-only runtimes are used to deploy compiled binaries and custom runtimes to Lambda.

For more information about deploying Lambda functions using AWS SAM, see [AWS::Serverless::Function](#) in the *AWS Serverless Application Model Developer Guide*.

Example SAM resource and property definition for a Rust binary

```
AWSTemplateFormatVersion: '2010-09-09'  
Transform: AWS::Serverless-2016-10-31  
Description: SAM template for Rust binaries  
Resources:  
  RustFunction:
```



```
Type: AWS::Serverless::Function
Properties:
  CodeUri: target/lambda/my-function/
  Handler: rust.handler
  Runtime: provided.al2023
Outputs:
  RustFunction:
    Description: "Lambda Function ARN"
    Value: !GetAtt RustFunction.Arn
```

2. Use the [build](#) subcommand to compile the function.

```
cargo lambda build --release
```

3. Use the [sam deploy](#) command to deploy the function to Lambda.

```
sam deploy --guided
```

For more information about building Rust functions with the AWS SAM CLI, see [Building Rust Lambda functions with Cargo Lambda](#) in the *AWS Serverless Application Model Developer Guide*.

Invoking your Rust function with Cargo Lambda

Use the [invoke](#) subcommand to test your function with a payload.

```
cargo lambda invoke --remote --data-ascii '{"command": "Hello world"}' my-function
```

Invoking your Rust function with the AWS CLI

You can also use the AWS CLI to invoke the function.

```
aws lambda invoke --function-name my-function --cli-binary-format raw-in-base64-out --payload '{"command": "Hello world"}' /tmp/out.txt
```

The **cli-binary-format** option is required if you're using AWS CLI version 2. To make this the default setting, run `aws configure set cli-binary-format raw-in-base64-out`. For more information, see [AWS CLI supported global command line options](#) in the *AWS Command Line Interface User Guide for Version 2*.

Log and monitor Rust Lambda functions

Note

The [Rust runtime client](#) is an experimental package. It is subject to change and intended only for evaluation purposes.

AWS Lambda automatically monitors Lambda functions on your behalf and sends logs to Amazon CloudWatch. Your Lambda function comes with a CloudWatch Logs log group and a log stream for each instance of your function. The Lambda runtime environment sends details about each invocation to the log stream, and relays logs and other output from your function's code. For more information, see [Using CloudWatch Logs with Lambda](#). This page describes how to produce log output from your Lambda function's code.

Creating a function that writes logs

To output logs from your function code, you can use any logging function that writes to `stdout` or `stderr`, such as the `println!` macro. The following example uses `println!` to print a message when the function handler starts and before it finishes.

```
use lambda_runtime::{service_fn, LambdaEvent, Error};
use serde_json::{json, Value};
async fn handler(event: LambdaEvent<Value>) -> Result<Value, Error> {
    println!("Rust function invoked");
    let payload = event.payload;
    let first_name = payload["firstName"].as_str().unwrap_or("world");
    println!("Rust function responds to {}", &first_name);
    Ok(json!({ "message": format!("Hello, {}!", first_name) }))
}

#[tokio::main]
async fn main() -> Result<(), Error> {
    lambda_runtime::run(service_fn(handler)).await
}
```

Implementing advanced logging with the Tracing crate

[Tracing](#) is a framework for instrumenting Rust programs to collect structured, event-based diagnostic information. This framework provides utilities to customize logging output levels and

formats, like creating structured JSON log messages. To use this framework, you must initialize a subscriber before implementing the function handler. Then, you can use tracing macros like `debug`, `info`, and `error`, to specify the level of logging that you want for each scenario.

Example — Using the Tracing crate

Note the following:

- `tracing_subscriber::fmt().json()`: When this option is included, logs are formatted in JSON. To use this option, you must include the `json` feature in the `tracing-subscriber` dependency (for example, `tracing-subscriber = { version = "0.3.11", features = ["json"] }`).
- `#[tracing::instrument(skip(event), fields(req_id = %event.context.request_id))]`: This annotation generates a span every time the handler is invoked. The span adds the request ID to each log line.
- `{ %first_name }`: This construct adds the `first_name` field to the log line where it's used. The value for this field corresponds to the variable with the same name.

```
use lambda_runtime::{service_fn, Error, LambdaEvent};
use serde_json::{json, Value};
#[tracing::instrument(skip(event), fields(req_id = %event.context.request_id))]
async fn handler(event: LambdaEvent<Value>) -> Result<Value, Error> {
    tracing::info!("Rust function invoked");
    let payload = event.payload;
    let first_name = payload["firstName"].as_str().unwrap_or("world");
    tracing::info!({ %first_name }, "Rust function responds to event");
    Ok(json!({ "message": format!("Hello, {first_name}!") }))
}

#[tokio::main]
async fn main() -> Result<(), Error> {
    tracing_subscriber::fmt().json()
        .with_max_level(tracing::Level::INFO)
        // this needs to be set to remove duplicated information in the log.
        .with_current_span(false)
        // this needs to be set to false, otherwise ANSI color codes will
        // show up in a confusing manner in CloudWatch logs.
        .with_ansi(false)
        // disabling time is handy because CloudWatch will add the ingestion time.
        .without_time()
}
```

```
    // remove the name of the function from every log entry
    .with_target(false)
    .init();
    lambda_runtime::run(service_fn(handler)).await
}
```

When this Rust function is invoked, it prints two log lines similar to the following:

```
{"level":"INFO","fields":{"message":"Rust function invoked"},"spans":
[{"req_id":"45daaaa7-1a72-470c-9a62-e79860044bb5","name":"handler"}]}
{"level":"INFO","fields":{"message":"Rust function responds to
event","first_name":"David"},"spans":[{"req_id":"45daaaa7-1a72-470c-9a62-
e79860044bb5","name":"handler"}]}
```

Best practices for working with AWS Lambda functions

The following are recommended best practices for using AWS Lambda:

Topics

- [Function code](#)
- [Function configuration](#)
- [Function scalability](#)
- [Metrics and alarms](#)
- [Working with streams](#)
- [Security best practices](#)

Function code

- **Take advantage of execution environment reuse to improve the performance of your function.** Initialize SDK clients and database connections outside of the function handler, and cache static assets locally in the `/tmp` directory. Subsequent invocations processed by the same instance of your function can reuse these resources. This saves cost by reducing function run time.

To avoid potential data leaks across invocations, don't use the execution environment to store user data, events, or other information with security implications. If your function relies on a mutable state that can't be stored in memory within the handler, consider creating a separate function or separate versions of a function for each user.

- **Use a keep-alive directive to maintain persistent connections.** Lambda purges idle connections over time. Attempting to reuse an idle connection when invoking a function will result in a connection error. To maintain your persistent connection, use the keep-alive directive associated with your runtime. For an example, see [Reusing Connections with Keep-Alive in Node.js](#).
- **Use [environment variables](#) to pass operational parameters to your function.** For example, if you are writing to an Amazon S3 bucket, instead of hard-coding the bucket name you are writing to, configure the bucket name as an environment variable.
- **Avoid using recursive invocations** in your Lambda function, where the function invokes itself or initiates a process that may invoke the function again. This could lead to unintended volume of

function invocations and escalated costs. If you see an unintended volume of invocations, set the function reserved concurrency to 0 immediately to throttle all invocations to the function, while you update the code.

- **Do not use non-documented, non-public APIs** in your Lambda function code. For AWS Lambda managed runtimes, Lambda periodically applies security and functional updates to Lambda's internal APIs. These internal API updates may be backwards-incompatible, leading to unintended consequences such as invocation failures if your function has a dependency on these non-public APIs. See [the API reference](#) for a list of publicly available APIs.
- **Write idempotent code.** Writing idempotent code for your functions ensures that duplicate events are handled the same way. Your code should properly validate events and gracefully handle duplicate events. For more information, see [How do I make my Lambda function idempotent?](#)

For language-specific code best practices, refer to the following sections:

- [the section called "Code best practices for Node.js Lambda functions"](#)
- [the section called "Code best practices for Typescript Lambda functions"](#)
- [the section called "Code best practices for Python Lambda functions"](#)
- [the section called "Code best practices for Ruby Lambda functions"](#)
- [the section called "Code best practices for Java Lambda functions"](#)
- [the section called "Code best practices for Go Lambda functions"](#)
- [the section called "Code best practices for C# Lambda functions"](#)
- [the section called "Code best practices for Rust Lambda functions"](#)

Function configuration

- **Performance testing your Lambda function** is a crucial part in ensuring you pick the optimum memory size configuration. Any increase in memory size triggers an equivalent increase in CPU available to your function. The memory usage for your function is determined per-invoke and can be viewed in [Amazon CloudWatch](#). On each invoke a REPORT : entry will be made, as shown below:

```
REPORT RequestId: 3604209a-e9a3-11e6-939a-754dd98c7be3 Duration: 12.34 ms Billed
Duration: 100 ms Memory Size: 128 MB Max Memory Used: 18 MB
```

By analyzing the `Max Memory Used` field, you can determine if your function needs more memory or if you over-provisioned your function's memory size.

To find the right memory configuration for your functions, we recommend using the open source AWS Lambda Power Tuning project. For more information, see [AWS Lambda Power Tuning](#) on GitHub.

To optimize function performance, we also recommend deploying libraries that can leverage Advanced Vector Extensions 2 (AVX2). This allows you to process demanding workloads, including machine learning inferencing, media processing, high performance computing (HPC), scientific simulations, and financial modeling. For more information, see [Creating faster AWS Lambda functions with AVX2](#).

- **Load test your Lambda function** to determine an optimum timeout value. It is important to analyze how long your function runs so that you can better determine any problems with a dependency service that may increase the concurrency of the function beyond what you expect. This is especially important when your Lambda function makes network calls to resources that may not handle Lambda's scaling. For more information about load testing your application, see [Distributed Load Testing on AWS](#).
- **Use most-restrictive permissions when setting IAM policies.** Understand the resources and operations your Lambda function needs, and limit the execution role to these permissions. For more information, see [Managing permissions in AWS Lambda](#).
- **Be familiar with [Lambda quotas](#).** Payload size, file descriptors and /tmp space are often overlooked when determining runtime resource limits.
- **Delete Lambda functions that you are no longer using.** By doing so, the unused functions won't needlessly count against your deployment package size limit.
- **If you are using Amazon Simple Queue Service** as an event source, make sure the value of the function's expected invocation time does not exceed the [Visibility Timeout](#) value on the queue. This applies both to [CreateFunction](#) and [UpdateFunctionConfiguration](#).
 - In the case of **CreateFunction**, AWS Lambda will fail the function creation process.
 - In the case of **UpdateFunctionConfiguration**, it could result in duplicate invocations of the function.

Function scalability

- **Be familiar with your upstream and downstream throughput constraints.** While Lambda functions scale seamlessly with load, upstream and downstream dependencies may not have the same throughput capabilities. If you need to limit how high your function can scale, you can [configure reserved concurrency](#) on your function.
- **Build in throttle tolerance.** If your synchronous function experiences throttling due to traffic exceeding Lambda's scaling rate, you can use the following strategies to improve throttle tolerance:
 - **Use [timeouts, retries, and backoff with jitter](#).** Implementing these strategies smooth out retried invocations, and helps ensure Lambda can scale up within seconds to minimize end-user throttling.
 - **Use [provisioned concurrency](#).** Provisioned concurrency is the number of pre-initialized execution environments that Lambda allocates to your function. Lambda handles incoming requests using provisioned concurrency when available. Lambda can also scale your function above and beyond your provisioned concurrency setting if required. Configuring provisioned concurrency incurs additional charges to your AWS account.

Metrics and alarms

- **Use [Using CloudWatch metrics with Lambda](#) and [CloudWatch Alarms](#)** instead of creating or updating a metric from within your Lambda function code. It's a much more efficient way to track the health of your Lambda functions, allowing you to catch issues early in the development process. For instance, you can configure an alarm based on the expected duration of your Lambda function invocation in order to address any bottlenecks or latencies attributable to your function code.
- **Leverage your logging library and [AWS Lambda Metrics and Dimensions](#)** to catch app errors (e.g. ERR, ERROR, WARNING, etc.)
- **Use [AWS Cost Anomaly Detection](#)** to detect unusual activity on your account. Cost Anomaly Detection uses machine learning to continuously monitor your cost and usage while minimizing false positive alerts. Cost Anomaly Detection uses data from AWS Cost Explorer, which has a delay of up to 24 hours. As a result, it can take up to 24 hours to detect an anomaly after usage occurs. To get started with Cost Anomaly Detection, you must first [sign up for Cost Explorer](#). Then, [access Cost Anomaly Detection](#).

Working with streams

- **Test with different batch and record sizes** so that the polling frequency of each event source is tuned to how quickly your function is able to complete its task. The [CreateEventSourceMapping](#) `BatchSize` parameter controls the maximum number of records that can be sent to your function with each invoke. A larger batch size can often more efficiently absorb the invoke overhead across a larger set of records, increasing your throughput.

By default, Lambda invokes your function as soon as records are available. If the batch that Lambda reads from the event source has only one record in it, Lambda sends only one record to the function. To avoid invoking the function with a small number of records, you can tell the event source to buffer records for up to 5 minutes by configuring a *batching window*. Before invoking the function, Lambda continues to read records from the event source until it has gathered a full batch, the batching window expires, or the batch reaches the payload limit of 6 MB. For more information, see [Batching behavior](#).

Warning

Lambda event source mappings process each event at least once, and duplicate processing of records can occur. To avoid potential issues related to duplicate events, we strongly recommend that you make your function code idempotent. To learn more, see [How do I make my Lambda function idempotent](#) in the AWS Knowledge Center.

- **Increase Kinesis stream processing throughput by adding shards.** A Kinesis stream is composed of one or more shards. The rate at which Lambda can read data from Kinesis scales linearly with the number of shards. Increasing the number of shards will directly increase the number of maximum concurrent Lambda function invocations and can increase your Kinesis stream processing throughput. For more information about the relationship between shards and function invocations, see [the section called "Polling and batching streams"](#). If you are increasing the number of shards in a Kinesis stream, make sure you have picked a good partition key (see [Partition Keys](#)) for your data, so that related records end up on the same shards and your data is well distributed.
- **Use [Amazon CloudWatch](#)** on `IteratorAge` to determine if your Kinesis stream is being processed. For example, configure a CloudWatch alarm with a maximum setting to 30000 (30 seconds).

Security best practices

- **Monitor your usage of AWS Lambda as it relates to security best practices by using AWS Security Hub.** Security Hub uses security controls to evaluate resource configurations and security standards to help you comply with various compliance frameworks. For more information about using Security Hub to evaluate Lambda resources, see [AWS Lambda controls](#) in the AWS Security Hub User Guide.
- **Monitor Lambda network activity logs using Amazon GuardDuty Lambda Protection.** GuardDuty Lambda protection helps you identify potential security threats when Lambda functions are invoked in your AWS account. For example, if one of your functions queries an IP address that is associated with cryptocurrency-related activity. GuardDuty monitors the network activity logs that are generated when a Lambda function is invoked. To learn more, see [Lambda protection](#) in the *Amazon GuardDuty User Guide*.

How to test serverless functions and applications

Testing serverless functions uses traditional test types and techniques, but you must also consider testing serverless applications as a whole. Cloud-based tests will provide the **most accurate** measure of quality of both your functions and serverless applications.

A serverless application architecture includes managed services that provide critical application functionality through API calls. For this reason, your development cycle should include automated tests that verify functionality when your function and services interact.

If you do not create cloud-based tests, you could encounter issues due to differences between your local environment and the deployed environment. Your continuous integration process should run tests against a suite of resources provisioned in the cloud before promoting your code to the next deployment environment, such as QA, Staging, or Production.

Continue reading this short guide to learn about testing strategies for serverless applications, or visit the [Serverless Test Samples repository](#) to dive in with practical examples, specific to your chosen language and runtime.

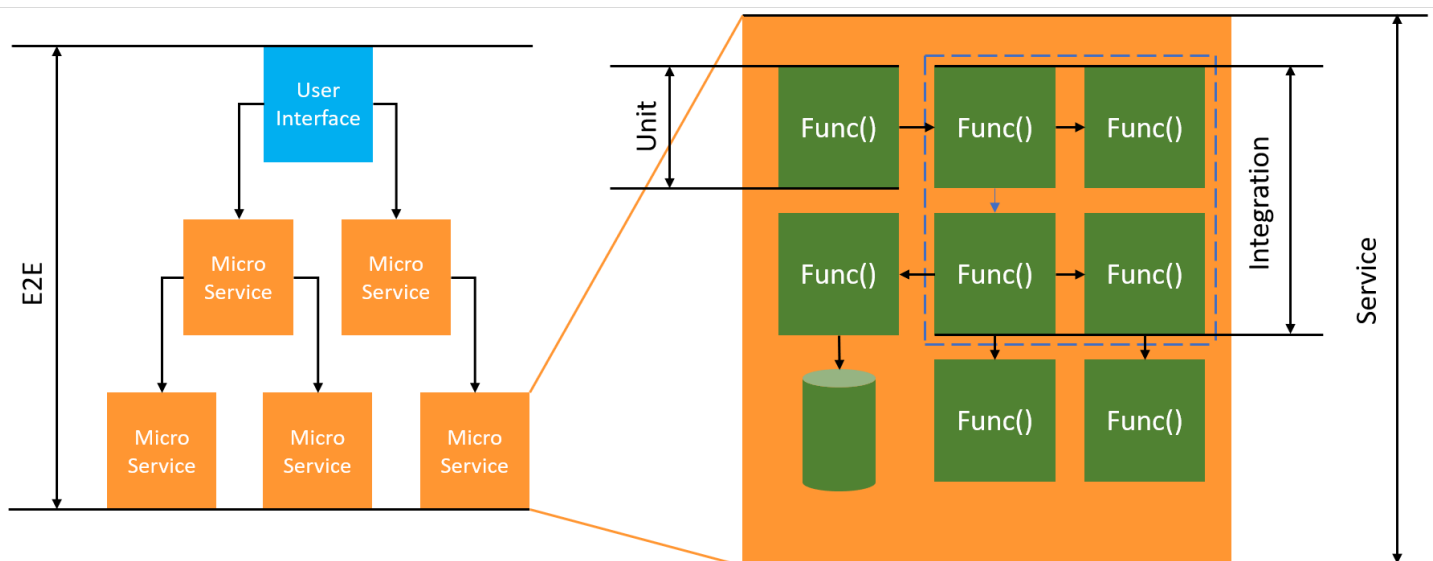

For serverless testing, you will still write *unit*, *integration* and *end-to-end* tests.

- **Unit tests** - Tests that run against an isolated block of code. For example, verifying the business logic to calculate the delivery charge given a particular item and destination.
- **Integration tests** - Tests involving two or more components or services that interact, typically in a cloud environment. For example, verifying a function processes events from a queue.

- **End-to-end tests** - Tests that verify behavior across an entire application. For example, ensuring infrastructure is set up correctly and that events flow between services as expected to record a customer's order.

Targeted business outcomes

Testing serverless solutions may require slightly more time to set up tests that verify event-driven interactions between services. Keep the following practical business reasons in mind as you read this guide:

- Increase the quality of your application
- Decrease time to build features and fix bugs

The quality of an application depends on testing a variety of scenarios to verify functionality. Carefully considering the business scenarios and automating those tests to run against cloud services will raise the quality of your application.

Software bugs and configuration problems have the least impact on cost and schedule when caught during an iterative development cycle. If issues remain undetected during development, finding and fixing in production requires more effort by more people.

A well planned serverless testing strategy will increase software quality and improve iteration time by verifying your Lambda functions and applications perform as expected in a cloud environment.

What to test

We recommend adopting a testing strategy that tests managed service *behaviors*, cloud configuration, security policies, and the integration with your code to improve software quality. *Behavior testing*, also known as black box testing, verifies a system works as expected without knowing all the internals.

- Run unit tests to check business logic inside Lambda functions.
- Verify integrated services are actually invoked, and input parameters are correct.
- Check that an event goes through all expected services end-to-end in a workflow.

In traditional server-based architecture, teams often define a scope for testing to only include code that runs on the application server. Other components, services, or dependencies are often considered external and out of scope for testing.

Serverless applications often consist of small units of work, such as Lambda functions that retrieve products from a database, or process items from a queue, or resize an image in storage. Each component runs in their own environment. Teams will likely be responsible for many of these small units within a single application.

Some application functionality can be delegated entirely to managed services such as Amazon S3, or created without using any internally developed code. There is no need to test these managed services, but you do need to test the integration with these services.

How to test serverless

You are probably familiar with how to test applications deployed locally: You write tests that run against code running entirely on your desktop operating system, or inside containers. For example, you might invoke a local web service component with a request and then make assertions about the response.

Serverless solutions are built from your function code and cloud-based managed services, such as queues, databases, event buses, and messaging systems. These components are all connected through an *event-driven architecture*, where messages, called *events*, flow from one resource to another. These interactions can be synchronous, such as when a web service returns results immediately, or an asynchronous action which completes at a later time, such as placing items in a queue or starting a workflow step. Your testing strategy must include both scenarios and test the interactions between services. For asynchronous interactions, you may need to detect side effects in downstream components that may not be immediately observable.

Replicating an entire cloud environment, including queues, database tables, event buses, security policies, and more, is not practical. You will inevitably encounter issues due to differences between your local environment and your deployed environments in the cloud. The variations between your environments will increase the time to reproduce and fix bugs.

In serverless applications, architecture components commonly exist entirely in the cloud, so testing against code and services in the cloud is necessary to develop features and fix bugs.

Testing techniques

In reality, your testing strategy will likely include a mix of techniques to increase quality of your solutions. You will use quick interactive tests to debug functions in the console, automated unit tests to check isolated business logic, verification of calls to external services with mocks, and occasional testing against emulators that mimic a service.

- **Testing in the cloud** - you deploy infrastructure and code to test with actual services, security policies, configurations and infrastructure specific parameters. Cloud-based tests provide the **most accurate** measure of quality of your code.

Debugging a function in the console is a quick way to test in the cloud. You can choose from a library of sample test events or create a custom event to test a function in isolation. You can also share test events through the console with your team.

To **automate** testing in the development and build lifecycle, you will need to test outside of the console. See the language specific testing sections in this guide for automation strategies and resources.

- **Testing with mocks** (also called *fakes*) - Mocks are objects within your code that simulate and stand-in for an external service. Mocks provide pre-defined behavior to verify service calls and parameters. A *fake* is a mock implementation that takes shortcuts to simplify or improve performance. For example, a fake data access object might return data from an in-memory datastore. Mocks can mimic and simplify complex dependencies, but can also lead to more mocks in order to replace nested dependencies.
- **Testing with emulators** - You can setup applications (sometimes from a third party) to mimic a cloud service in your local environment. Speed is their strength, but setup and parity with production services is their weakness. Use emulators sparingly.

Testing in the cloud

Testing in the cloud is valuable for all phases of testing, including unit tests, integration tests, and end-to-end tests. When you run tests against cloud-based code that also interacts with cloud-based services, you get the **most accurate** measure of quality of your code.

A convenient way to run a Lambda function in the cloud is with a test event in the AWS Management Console. A *test event* is a JSON input to your function. If your function does not require input, the event can be an empty JSON document (`{}`). The console provides sample

events for a variety of service integrations. After creating an event in the console, you can also share it with your team to make testing easier and consistent.

Learn how to [debug a sample function in the console](#).

 **Note**

Although running functions in the console is a quick way to debug, **automating** your test cycles is essential to increase application quality and development speed.

Test automation samples are available in the [Serverless Test Samples repository](#). The following command line runs an automated [Python integration test example](#):

```
python -m pytest -s tests/integration -v
```

Although the test runs locally, it interacts with cloud-based resources. These resources have been deployed using the AWS Serverless Application Model and AWS SAM command line tool. The test code first retrieves the deployed stack outputs, which includes the API endpoint, function ARN, and security role. Next, the test sends a request to the API endpoint, which responds with a list of Amazon S3 buckets. This test runs entirely against cloud-based resources to verify those resources are deployed, secured, and work as expected.

```
===== test session starts =====
platform darwin -- Python 3.10.10, pytest-7.3.1, pluggy-1.0.0
-- /Users/t/code/aws/serverless-test-samples/python-test-samples/apigw-lambda/
venv/bin/python
cachedir: .pytest_cache
rootdir: /Users/t/code/aws/serverless-test-samples/python-test-samples/apigw-
lambda
plugins: mock-3.10.0
collected 1 item

tests/integration/test_api_gateway.py::TestApiGateway::test_api_gateway

--> Stack outputs:

HelloWorldApi
= https://p7teqs3162.execute-api.us-east-2.amazonaws.com/Prod/hello/
> API Gateway endpoint URL for Prod stage for Hello World function
```

```
PythonTestDemo
= arn:aws:lambda:us-east-2:123456789012:function:testing-apigw-lambda-
PythonTestDemo-iSij8evaTdx1
> Hello World Lambda Function ARN

PythonTestDemoIamRole
= arn:aws:iam::123456789012:role/testing-apigw-lambda-PythonTestDemoRole-
IZELQQ9MG4HQ
> Implicit IAM Role created for Hello World function

--> Found API endpoint for "testing-apigw-lambda" stack...
--> https://p7teqs3162.execute-api.us-east-2.amazonaws.com/Prod/hello/
API Gateway response:
amplify-dev-123456789-deployment|myapp-prod-p-loggingbucket-123456|s3-java-
bucket-123456789
PASSED

===== 1 passed in 1.53s =====
```

For cloud-native application development, testing in the cloud provides the following benefits:

- You can test **every** available service.
- You are always using the most recent service APIs and return values.
- A cloud test environment closely resembles your production environment.
- Tests can cover security policies, service quotas, configurations and infrastructure specific parameters.
- Every developer can quickly create one or more testing environments in the cloud.
- Cloud tests increase confidence your code will run correctly in production.

Testing in the cloud does have some disadvantages. The most obvious negative of testing in the cloud is that deployments to cloud environments typically take longer than deployments to a local desktop environments.

Fortunately, tools such as [AWS Serverless Application Model \(AWS SAM\) Accelerate](#), [AWS Cloud Development Kit \(AWS CDK\) watch mode](#), and [SST](#) (3rd party) reduce the latency involved with cloud deployment iterations. These tools can monitor your infrastructure and code and automatically deploy incremental updates into your cloud environment.

Note

See how to [create infrastructure as code](#) in the *Serverless Developer Guide* to learn more about AWS Serverless Application Model, AWS CloudFormation, and AWS Cloud Development Kit (AWS CDK).

Unlike local testing, testing in the cloud requires additional resources which may incur service costs. Creating isolated testing environments may increase the burden on your DevOps teams, especially in organizations with strict controls around accounts and infrastructure. Even so, when working with complex infrastructure scenarios, the cost in developer time to set up and maintain an intricate local environment could be similar (or more costly) than using disposable testing environments created with Infrastructure as Code automation tools.

Testing in the cloud, even with these considerations, is still the **best way** to guarantee the quality of your serverless solutions.

Testing with mocks

Testing with mocks is a technique where you create replacement objects in your code to simulate the behavior of a cloud service.

For example, you could write a test that uses a mock of the Amazon S3 service that returns a specific response whenever the **CreateObject** method is called. When a test runs, the mock returns that programmed response without calling Amazon S3, or any other service endpoints.

Mock objects are often generated by a mock framework to reduce development effort. Some mock frameworks are generic and others are designed specifically for AWS SDKs, such as [Moto](#), a Python library for mocking AWS services and resources.

Note that mock objects differ from emulators in that mocks are typically created or configured by a developer as part of the test code, whereas emulators are standalone applications that expose functionality in the same manner as the systems they emulate.

The advantages of using mocks include the following:

- Mocks can simulate third-party services that are beyond the control of your application, such as APIs and software as a service (SaaS) providers, without needing direct access to those services.
- Mocks are useful for testing failure conditions, especially when such conditions are hard to simulate, like a service outage.

- Mock can provide fast local testing once configured.
- Mocks can provide substitute behavior for virtually any kind of object, so mocking strategies can create coverage for a wider variety of services than emulators.
- When new features or behaviors become available, mock testing can react more quickly. By using a generic mock framework, you can simulate new features as soon as the updated AWS SDK become available.

Mock testing has these disadvantages:

- Mocks generally require a non-trivial amount of setup and configuration effort, specifically when trying to determine return values from different services in order to properly mock responses.
- Mocks are written, configured, and must be maintained by developers, increasing their responsibilities.
- You might need to have access to the cloud in order to understand the APIs and return values of services.
- Mocks can be difficult to maintain. When mocked cloud API signatures change, or return value schemas evolve, you need to update your mocks. Mocks also require updates if you extend your application logic to make calls to new APIs.
- Tests that use mocks might pass in desktop environments but fail in the cloud. Results may not match the current API. Service configuration and quotas cannot be tested.
- Mock frameworks are limited in testing or detecting AWS Identity and Access Management (IAM) policy or quota limitations. Although mocks are better at simulating when authorization fails or a quota is exceeded, testing cannot determine which outcome will actually occur in a production environment.

Testing with emulation

Emulators are typically a locally running application which mimics a production AWS service.

Emulators have APIs that are similar to their cloud counterparts and provide similar return values. They can also simulate state changes that are initiated by API calls. For example, you might use AWS SAM to run a function with AWS SAM local to emulate the Lambda service so that you can quickly invoke a function. See [AWS SAM local](#) in the *AWS Serverless Application Model Developer Guide* for details.

The advantages of test with emulators include the following:

- Emulators can facilitate fast local development iterations and testing.

- Emulators provide a familiar environment for developers used to developing code in a local environment. For example, if you're familiar with the development of an n -tier application, you might have a database engine and web server, similar to those running in production, running on your local machine to provide quick, local, isolated test capability.
- Emulators do not require any changes to cloud infrastructure (such as developer cloud accounts), so it's easy to implement with existing testing patterns.

Testing with emulators has these disadvantages:

- Emulators can be difficult to set up and replicate, especially when used in CI/CD pipelines. This can increase the workload of IT staff or developers who manage their own software.
- Emulated features and APIs typically lag behind service updates. This can lead to errors because tested code does not match the actual API, and impede the adoption of new features.
- Emulators require support, updates, bug fixes, and feature parity enhancements. These are the responsibility of the emulator author, which could be a third-party company.
- Tests that rely on emulators may provide successful results locally, but fail in the cloud due to production security policies, inter-service configurations, or exceeding Lambda quotas.
- Many AWS services do not have emulators available. If you rely on emulation, you may not have a satisfactory testing option for portions of your application.

Best practices

The following sections provide recommendations for successful serverless application testing.

You can find practical examples of tests and test automation in the [Serverless Test Samples repository](#).

Prioritize testing in the cloud

Testing in the cloud provides the most reliable, accurate, and complete test coverage. Performing tests in the context of the cloud will comprehensively test not only business logic but also security policies, service configurations, quotas, and the most up to date API signatures and return values.

Structure your code for testability

Simplify your tests and Lambda functions by separating Lambda-specific code from your core business logic.

Your Lambda function *handler* should be a slim adapter that takes in event data and passes only the details that matter to your business logic method(s). With this strategy, you can wrap comprehensive tests around your business logic without worrying about Lambda-specific details. Your AWS Lambda functions should not require setting up a complex environment or large amount of dependencies to create and initialize the component under test.

Generally speaking, you should write a handler that extracts and validates data from the incoming *event* and *context* objects, then sends that input to methods that perform your business logic.

Accelerate development feedback loops

There are tools and techniques to accelerate development feedback loops. For example, [AWS SAM Accelerate](#) and [AWS CDK watch mode](#) both decrease the time required to update cloud environments.

The samples in the GitHub [Serverless Test Samples repository](#) explore some of these techniques.

We also recommend that you create and test cloud resources as early as possible during development—not only after a check-in to source control. This practice enables quicker exploration and experimentation when developing solutions. In addition, automating deployment from a development machine helps you discover cloud configuration problems more quickly and reduces wasted effort for updates and code review processes.

Focus on integration tests

When building applications with Lambda, testing components together is a best practice.

Tests that run against two or more architectural components are called *integration tests*. The goal of integration tests is to understand not only how your code will execute across components, but how the environment hosting your code will behave. *End-to-end tests* are special types of integration tests that verify behaviors across an entire application.

To build integration tests, deploy your application to a cloud environment. This can be done from a local environment or through a CI/CD pipeline. Then, write tests to exercise the system under test (SUT) and validate expected behavior.

For example, the system under test could be an application that uses API Gateway, Lambda and DynamoDB. A test could make a synthetic HTTP call to an API Gateway endpoint and validate that the response included the expected payload. This test validates that the AWS Lambda code

is correct, and that each service is correctly configured to handle the request, including the IAM permissions between them. Further, you could design the test to write records of various sizes to verify your service quotas, such as max record size in DynamoDB, are set up correctly.

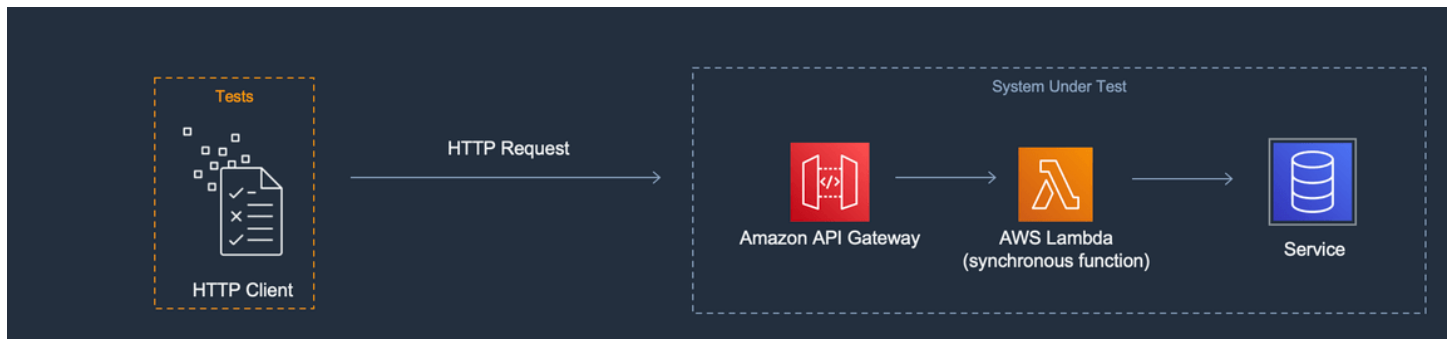

Create isolated test environments

Testing in the cloud typically requires isolated developer environments, so that tests, data, and events do not overlap.

One approach is to provide each developer a dedicated AWS account. This will avoid conflicts with resource naming that can occur when multiple developers working in a shared code base, attempt to deploy resources or invoke an API.

Automated test processes should create uniquely named resources for each stack. For example, you can set up scripts or TOML configuration files so that AWS SAM CLI [sam deploy](#) or [sam sync](#) commands will automatically specify a stack with a unique prefix.

In some cases, developers share an AWS account. This may be due to having resources in your stack that are expensive to operate, or to provision and configure. For example, a database may be shared to make it easier to set up and seed the data properly

If developers share an account, you should set boundaries to identify ownership and eliminate overlap. One way to do this is by prefixing stack names with developer user IDs. Another popular approach is to set up stacks based on **code branches**. With branch boundaries, environments are isolated, but developers can still share resources, such as a relational database. This approach is a best practice when developers work on more than one branch at a time.

Testing in the cloud is valuable for all phases of testing, including unit tests, integration tests, and end-to-end tests. Maintaining proper isolation is essential; but you still want your QA environment to resemble your production environment as closely as possible. For this reason, teams add change control processes for QA environments.

For pre-production and production environments, boundaries are typically drawn at the account level to insulate workloads from noisy neighbor problems and implement least privilege security controls to protect sensitive data. Workloads have quotas. You don't want your testing to consume quotas allocated for production (noisy neighbor) or have access to customer data. Load testing is another activity you should isolate from your production stack.

In all cases, environments should be configured with alerts and controls to avoid unnecessary spending. For example, you can limit the type, tier, or size of resources that can be created, and set up email alerts when estimated costs exceed a given threshold.

Use mocks for isolated business logic

Mock frameworks are a valuable tool for writing fast unit tests. They are especially beneficial when tests cover complex internal business logic, such as mathematical or financial calculations or simulations. Look for unit tests that have a large number of test cases or input variations, where those inputs do not change the pattern or the content of calls to other cloud services.

Code that is covered by unit tests with mocks should also be covered by testing in the cloud. This is recommended because a developer laptop or build machine environment could be configured differently than a production environment in the cloud. For example, your Lambda functions could use more memory or time than allocated when run with certain input parameters. Or your code might include environment variables that are not configured in the same way (or at all), and the differences could cause the code to behave differently or fail.

The benefit of mocks is less for integration tests, because the level of effort to implement the necessary mocks increases with the number of connection points. End-to-end testing should not use mocks, because these tests generally deal with states and complex logic that cannot be easily simulated with mock frameworks.

Lastly, avoid using mocked cloud services to validate the proper implementation of service calls. Instead, make cloud service calls in the cloud to validate behavior, configuration, and functional implementation.

Use emulators sparingly

Emulators can be convenient for some use cases, for example, for a development team with limited, unreliable, or slow internet access. But, in most circumstances, choose to use emulators sparingly.

By avoiding emulators, you will be able to build and innovate with the latest service features and up to date APIs. You will not be stuck waiting on vendor releases to achieve feature parity. You will reduce your upfront and ongoing expenses for purchasing and configuration on multiple development systems and build machines. Moreover, you will avoid the problem that many cloud services simply do not have emulators available. A testing strategy that depends on emulation will make it impossible to use those services (leading to potentially more expensive workarounds) or produce code and configurations that aren't well tested.

When you do use emulation for testing, you must still test in the cloud to verify configuration and to test interactions with cloud services that can only be simulated or mocked in an emulated environment.

Challenges testing locally

When you use emulators and mocked calls to test on your local desktop you might experience testing inconsistencies as your code progresses from environment to environment in your CI/CD pipeline. Unit tests to validate your application's business logic on your desktop may not accurately test critical aspects of the cloud services.

The following examples provide cases to watch out for when testing locally with mocks and emulators:

Example: Lambda function creates an S3 bucket

If a Lambda function's logic depends on creating an S3 bucket, a complete test should confirm that Amazon S3 was called and the bucket was successfully created.

- In a mock testing setup, you might mock a success response and potentially add a test case to handle a failure response.
- In an emulation testing scenario, the **CreateBucket** API might be called, but you need to be aware that the identity making the local call will **not** originate from the Lambda service. The calling identity will not assume a security role as it would in the cloud, so a placeholder authentication will be used instead, possibly with a more permissive role or user identity that will be different when run in the cloud.

The mock and emulation setups will test what the Lambda function will do if it calls Amazon S3; however, those tests will not verify that the Lambda function, as configured, is capable of successfully creating the Amazon S3 bucket. You must make sure the role assigned to the function

has an attached security policy that allows the function to perform the `s3:CreateBucket` action. If not, the function will likely fail when deployed to a cloud environment.

Example: Lambda function processes messages from an Amazon SQS queue

If an Amazon SQS queue is the source of a Lambda function, a complete test should verify that the Lambda function is successfully invoked when a message is put in a queue.

Emulation testing and mock testing are generally set up to run the Lambda function code directly, and to simulate the Amazon SQS integration by passing a JSON event payload (or a deserialized object) as the function handler's input.

Local testing that simulates the Amazon SQS integration will test what the Lambda function will do when it's called by Amazon SQS with a given payload, but the test will not verify that Amazon SQS will successfully invoke the Lambda function when it is deployed to a cloud environment.

Some examples of configuration problems you might encounter with Amazon SQS and Lambda include the following:

- Amazon SQS visibility timeout is too low, resulting in multiple invocations when only one was intended.
- The Lambda function's execution role doesn't allow reading messages from the queue (through `sqs:ReceiveMessage`, `sqs:DeleteMessage`, or `sqs:GetQueueAttributes`).
- The sample event that is passed to the Lambda function exceeds the Amazon SQS message size quota. Therefore, the test is invalid because Amazon SQS would never be able to send a message of that size.

As these examples show, tests that cover business logic but not the configurations between cloud services are likely to provide unreliable results.

FAQ

I have a Lambda function that performs calculations and returns a result without calling any other services. Do I really need to test it in the cloud?

Yes. Lambda functions have configuration parameters that could change the outcome of the test. All Lambda function code has a dependency on [timeout](#) and [memory](#) settings, which could cause the function to fail if those settings are not set properly. Lambda policies also enable standard

output logging to [Amazon CloudWatch](#). Even if your code does not call CloudWatch directly, permission is needed to enable logging. This required permission cannot be accurately mocked or emulated.

How can testing in the cloud help with unit testing? If it's in the cloud and connects to other resources, isn't that an integration test?

We define *unit tests* as tests that operate on architectural components in isolation, but this does not prevent tests from including components that may call other services or use some network communication.

Many serverless applications have architectural components that can be tested in isolation, even in the cloud. One example is a Lambda function that takes input, processes the data, and sends a message to an Amazon SQS queue. A unit test of this function would likely test whether input values result in certain values being present in the queued message.

Consider a test that is written by using the Arrange, Act, Assert pattern:

- *Arrange*: Allocate resources (a queue to receive messages, and the function under test).
- *Act*: Call the function under test.
- *Assert*: Retrieve the message sent by the function, and validate the output.

A mock testing approach would involve mocking the queue with an in-process mock object, and creating an in-process instance of the class or module that contains the Lambda function code. During the Assert phase, the queued message would be retrieved from the mocked object.

In a cloud-based approach, the test would create an Amazon SQS queue for the purposes of the test, and would deploy the Lambda function with environment variables that are configured to use the isolated Amazon SQS queue as the output destination. After running the Lambda function, the test would retrieve the message from the Amazon SQS queue.

The cloud-based test would run the same code, assert the same behavior, and validate the application's functional correctness. However, it would have the added advantage of being able to validate the settings of the Lambda function: the IAM role, IAM policies, and the function's timeout and memory settings.

Next steps and resources

Use the following resources to learn more and explore practical examples of testing.

Sample implementations

The [Serverless Test Samples repository](#) on GitHub contains concrete examples of tests that follow the patterns and best practices described in this guide. The repository contains sample code and guided walkthroughs of the mock, emulation, and cloud testing processes described in previous sections. Use this repository to get up to speed on the latest serverless testing guidance from AWS.

Further reading

Visit [Serverless Land](#) to access the latest blogs, videos, and training for AWS serverless technologies.

The following AWS blog posts are also recommended reading:

- [Accelerating serverless development with AWS SAM Accelerate](#) (AWS blog post)
- [Increasing development speed with CDK Watch](#) (AWS blog post)
- [Mocking service integrations with AWS Step Functions Local](#) (AWS blog post)
- [Getting started with testing serverless applications](#) (AWS blog post)

Tools

- AWS SAM – [Testing and debugging serverless applications](#)
- AWS SAM – [Integrating with automated tests](#)
- Lambda – [Testing Lambda functions in the Lambda console](#)

Improving startup performance with Lambda SnapStart

Lambda SnapStart can provide as low as sub-second startup performance, typically with no changes to your function code. SnapStart makes it easier to build highly responsive and scalable applications without provisioning resources or implementing complex performance optimizations.

The largest contributor to startup latency (often referred to as cold start time) is the time that Lambda spends initializing the function, which includes loading the function's code, starting the runtime, and initializing the function code. With SnapStart, Lambda initializes your function when you publish a function version. Lambda takes a [Firecracker microVM](#) snapshot of the memory and disk state of the initialized [execution environment](#), encrypts the snapshot, and intelligently caches it to optimize retrieval latency.

To ensure resiliency, Lambda maintains several copies of each snapshot. Lambda automatically patches snapshots and their copies with the latest runtime and security updates. When you invoke the function version for the first time, and as the invocations scale up, Lambda resumes new execution environments from the cached snapshot instead of initializing them from scratch, improving startup latency.

Important

If your applications depend on uniqueness of state, you must evaluate your function code and verify that it is resilient to snapshot operations. For more information, see [Handling uniqueness with Lambda SnapStart](#).

Topics

- [When to use SnapStart](#)
- [Supported features and limitations](#)
- [Supported Regions](#)
- [Compatibility considerations](#)
- [SnapStart pricing](#)
- [Activating and managing Lambda SnapStart](#)
- [Handling uniqueness with Lambda SnapStart](#)
- [Implement code before or after Lambda function snapshots](#)
- [Monitoring for Lambda SnapStart](#)

- [Security model for Lambda SnapStart](#)
- [Maximize Lambda SnapStart performance](#)
- [Troubleshooting SnapStart errors for Lambda functions](#)

When to use SnapStart

Lambda SnapStart is designed to address the latency variability introduced by one-time initialization code, such as loading module dependencies or frameworks. These operations can sometimes take several seconds to complete during the initial invocation. Use SnapStart to reduce this latency from several seconds to as low as sub-second, in optimal scenarios. SnapStart works best when used with function invocations at scale. Functions that are invoked infrequently might not experience the same performance improvements.

SnapStart is particularly beneficial for two main types of applications:

- **Latency-sensitive APIs and user flows:** Functions that are part of critical API endpoints or user-facing flows can benefit from SnapStart's reduced latency and improved response times.
- **Latency-sensitive data processing workflows:** Time-bound data processing workflows that use Lambda functions can achieve better throughput by reducing outlier function initialization latency.

[Provisioned concurrency](#) keeps functions initialized and ready to respond in double-digit milliseconds. Use provisioned concurrency if your application has strict cold start latency requirements that can't be adequately addressed by SnapStart.

Supported features and limitations

SnapStart is available for the following [Lambda managed runtimes](#):

- Java 11 and later
- Python 3.12 and later
- .NET 8 and later. If you're using the [Lambda Annotations framework for .NET](#), upgrade to [Amazon.Lambda.Annotations](#) version 1.6.0 or later to ensure compatibility with SnapStart.

Other managed runtimes (such as `nodejs22.x` and `ruby3.3`), [OS-only runtimes](#), and [container images](#) are not supported.

SnapStart does not support [provisioned concurrency](#), [Amazon Elastic File System \(Amazon EFS\)](#), or ephemeral storage greater than 512 MB.

Note

You can use SnapStart only on [published function versions](#) and [aliases](#) that point to versions. You can't use SnapStart on a function's unpublished version (\$LATEST).

Supported Regions

Java

For Java runtimes, Lambda SnapStart is available in all [commercial Regions](#) except Asia Pacific (Malaysia).

Python and .NET

For Python and .NET runtimes, Lambda SnapStart is available in the following AWS Regions:

- US East (N. Virginia)
- US East (Ohio)
- US West (Oregon)
- Asia Pacific (Singapore)
- Asia Pacific (Sydney)
- Asia Pacific (Tokyo)
- Europe (Frankfurt)
- Europe (Ireland)
- Europe (Stockholm)

Compatibility considerations

With SnapStart, Lambda uses a single snapshot as the initial state for multiple execution environments. If your function uses any of the following during the [initialization phase](#), then you might need to make some changes before using SnapStart:

Uniqueness

If your initialization code generates unique content that is included in the snapshot, then the content might not be unique when it is reused across execution environments. To maintain uniqueness when using SnapStart, you must generate unique content after initialization. This includes unique IDs, unique secrets, and entropy that's used to generate pseudorandomness. To learn how to restore uniqueness, see [Handling uniqueness with Lambda SnapStart](#).

Network connections

The state of connections that your function establishes during the initialization phase isn't guaranteed when Lambda resumes your function from a snapshot. Validate the state of your network connections and re-establish them as necessary. In most cases, network connections that an AWS SDK establishes automatically resume. For other connections, review the [best practices](#).

Temporary data

Some functions download or initialize ephemeral data, such as temporary credentials or cached timestamps, during the initialization phase. Refresh ephemeral data in the function handler before using it, even when not using SnapStart.

SnapStart pricing

Note

For Java managed runtimes, there's no additional cost for SnapStart. You're charged based on the number of requests for your functions, the time that it takes your code to run, and the memory configured for your function.

The cost of using SnapStart includes the following:

- **Caching:** For every function version that you publish with SnapStart enabled, you pay for the cost of caching and maintaining the snapshot. The price depends on the amount of [memory](#) that you allocate to your function. You're charged for a minimum of 3 hours. You will continue to be charged as long as your function remains [active](#). Use the [ListVersionsByFunction](#) API action to identify function versions, and then use [DeleteFunction](#) to delete unused versions. To automatically delete unused function versions, see the [Lambda Version Cleanup](#) pattern on Serverless Land.

- **Restoration:** Each time a function instance is restored from a snapshot, you pay a restoration charge. The price depends on the amount of memory you allocate to your function.

As with all Lambda functions, duration charges apply to code that runs in the function handler. For SnapStart functions, duration charges also apply to initialization code that's declared outside of the handler, the time it takes for the runtime to load, and any code that runs in a [runtime hook](#). Duration is calculated from the time that your code begins running until it returns or otherwise ends, rounded up to the nearest 1 ms. Lambda maintains cached copies of your snapshot for resiliency and automatically applies software updates, such as runtime upgrades and security patches to them. Charges apply each time that Lambda re-runs your initialization code to apply software updates.

For more information about the cost of using SnapStart, see [AWS Lambda Pricing](#).

Activating and managing Lambda SnapStart

To use SnapStart, activate SnapStart on a new or existing Lambda function. Then, publish and invoke a function version.

Topics

- [Activating SnapStart \(console\)](#)
- [Activating SnapStart \(AWS CLI\)](#)
- [Activating SnapStart \(API\)](#)
- [Lambda SnapStart and function states](#)
- [Updating a snapshot](#)
- [Using SnapStart with AWS SDKs](#)
- [Using SnapStart with AWS CloudFormation, AWS SAM, and AWS CDK](#)
- [Deleting snapshots](#)

Activating SnapStart (console)

To activate SnapStart for a function

1. Open the [Functions page](#) of the Lambda console.
2. Choose the name of a function.
3. Choose **Configuration**, and then choose **General configuration**.
4. On the **General configuration** pane, choose **Edit**.
5. On the **Edit basic settings** page, for **SnapStart**, choose **Published versions**.
6. Choose **Save**.
7. [Publish a function version](#). Lambda initializes your code, creates a snapshot of the initialized execution environment, and then caches the snapshot for low-latency access.
8. [Invoke the function version](#).

Activating SnapStart (AWS CLI)

To activate SnapStart for an existing function

1. Update the function configuration by running the [update-function-configuration](#) command with the `--snap-start` option.

```
aws lambda update-function-configuration \  
  --function-name my-function \  
  --snap-start ApplyOn=PublishedVersions
```

2. Publish a function version with the [publish-version](#) command.

```
aws lambda publish-version \  
  --function-name my-function
```

3. Confirm that SnapStart is activated for the function version by running the [get-function-configuration](#) command and specifying the version number. The following example specifies version 1.

```
aws lambda get-function-configuration \  
  --function-name my-function:1
```

If the response shows that [OptimizationStatus](#) is On and [State](#) is Active, then SnapStart is activated and a snapshot is available for the specified function version.

```
"SnapStart": {  
  "ApplyOn": "PublishedVersions",  
  "OptimizationStatus": "On"  
},  
"State": "Active",
```

4. Invoke the function version by running the [invoke](#) command and specifying the version. The following example invokes version 1.

```
aws lambda invoke \  
  --cli-binary-format raw-in-base64-out \  
  --function-name my-function:1 \  
  --payload '{ "name": "Bob" }' \  
  response.json
```

The **cli-binary-format** option is required if you're using AWS CLI version 2. To make this the default setting, run `aws configure set cli-binary-format raw-in-base64-out`. For more information, see [AWS CLI supported global command line options](#) in the *AWS Command Line Interface User Guide for Version 2*.

To activate SnapStart when you create a new function

1. Create a function by running the [create-function](#) command with the `--snap-start` option. For `--role`, specify the Amazon Resource Name (ARN) of your [execution role](#).

```
aws lambda create-function \  
  --function-name my-function \  
  --runtime "java21" \  
  --zip-file fileb://my-function.zip \  
  --handler my-function.handler \  
  --role arn:aws:iam::111122223333:role/lambda-ex \  
  --snap-start ApplyOn=PublishedVersions
```

2. Create a version with the [publish-version](#) command.

```
aws lambda publish-version \  
  --function-name my-function
```

3. Confirm that SnapStart is activated for the function version by running the [get-function-configuration](#) command and specifying the version number. The following example specifies version 1.

```
aws lambda get-function-configuration \  
  --function-name my-function:1
```

If the response shows that [OptimizationStatus](#) is On and [State](#) is Active, then SnapStart is activated and a snapshot is available for the specified function version.

```
"SnapStart": {  
  "ApplyOn": "PublishedVersions",  
  "OptimizationStatus": "On"  
},  
"State": "Active",
```

4. Invoke the function version by running the [invoke](#) command and specifying the version. The following example invokes version 1.

```
aws lambda invoke \  
  --cli-binary-format raw-in-base64-out \  
  --function-name my-function:1 \  
  --payload '{ "name": "Bob" }' \  
  response.json
```

The **cli-binary-format** option is required if you're using AWS CLI version 2. To make this the default setting, run `aws configure set cli-binary-format raw-in-base64-out`. For more information, see [AWS CLI supported global command line options](#) in the *AWS Command Line Interface User Guide for Version 2*.

Activating SnapStart (API)

To activate SnapStart

1. Do one of the following:
 - Create a new function with SnapStart activated by using the [CreateFunction](#) API action with the [SnapStart](#) parameter.
 - Activate SnapStart for an existing function by using the [UpdateFunctionConfiguration](#) action with the [SnapStart](#) parameter.
2. Publish a function version with the [PublishVersion](#) action. Lambda initializes your code, creates a snapshot of the initialized execution environment, and then caches the snapshot for low-latency access.
3. Confirm that SnapStart is activated for the function version by using the [GetFunctionConfiguration](#) action. Specify a version number to confirm that SnapStart is activated for that version. If the response shows that [OptimizationStatus](#) is On and [State](#) is Active, then SnapStart is activated and a snapshot is available for the specified function version.

```
"SnapStart": {  
  "ApplyOn": "PublishedVersions",  
  "OptimizationStatus": "On"  
},  
"State": "Active",
```

4. Invoke the function version with the [Invoke](#) action.

Lambda SnapStart and function states

The following function states can occur when you use SnapStart.

Pending

Lambda is initializing your code and taking a snapshot of the initialized execution environment. Any invocations or other API actions that operate on the function version will fail.

Active

Snapshot creation is complete and you can invoke the function. To use SnapStart, you must invoke the published function version, not the unpublished version (\$LATEST).

Inactive

The `Inactive` state can occur when Lambda periodically regenerates function snapshots to apply software updates. In this instance, if your function fails to initialize, the function can enter an `Inactive` state.

For functions using a Java runtime, Lambda deletes snapshots after 14 days without an invocation. If you invoke the function version after 14 days, Lambda returns a `SnapStartNotReadyException` response and begins initializing a new snapshot. Wait until the function version reaches the `Active` state, and then invoke it again.

Failed

Lambda encountered an error when running the initialization code or creating the snapshot.

Updating a snapshot

Lambda creates a snapshot for each published function version. To update a snapshot, publish a new function version.

Using SnapStart with AWS SDKs

To make AWS SDK calls from your function, Lambda generates an ephemeral set of credentials by assuming your function's execution role. These credentials are available as environment variables during your function's invocation. You don't need to provide credentials for the SDK

directly in code. By default, the credential provider chain sequentially checks each place where you can set credentials and chooses the first available—usually the environment variables (`AWS_ACCESS_KEY_ID`, `AWS_SECRET_ACCESS_KEY`, and `AWS_SESSION_TOKEN`).

Note

When SnapStart is activated, the Lambda runtime automatically uses the container credentials (`AWS_CONTAINER_CREDENTIALS_FULL_URI` and `AWS_CONTAINER_AUTHORIZATION_TOKEN`) instead of the access key environment variables. This prevents credentials from expiring before the function is restored.

Using SnapStart with AWS CloudFormation, AWS SAM, and AWS CDK

- **AWS CloudFormation:** Declare the [SnapStart](#) entity in your template.
- **AWS Serverless Application Model (AWS SAM):** Declare the [SnapStart](#) property in your template.
- **AWS Cloud Development Kit (AWS CDK):** Use the [SnapStartProperty](#) type.

Deleting snapshots

Lambda deletes snapshots when:

- You delete the function or function version.
- **Java runtimes only** — You don't invoke the function version for 14 days. After 14 days without an invocation, the function version transitions to the [Inactive](#) state. If you invoke the function version after 14 days, Lambda returns a `SnapStartNotReadyException` response and begins initializing a new snapshot. Wait until the function version reaches the [Active](#) state, and then invoke it again.

Lambda removes all resources associated with deleted snapshots in compliance with the General Data Protection Regulation (GDPR).

Handling uniqueness with Lambda SnapStart

When invocations scale up on a SnapStart function, Lambda uses a single initialized snapshot to resume multiple execution environments. If your initialization code generates unique content that is included in the snapshot, then the content might not be unique when it is reused across execution environments. To maintain uniqueness when using SnapStart, you must generate unique content after initialization. This includes unique IDs, unique secrets, and entropy that's used to generate pseudorandomness.

We recommend the following best practices to help you maintain uniqueness in your code. For Java functions, Lambda also provides an open-source [SnapStart scanning tool](#) to help check for code that assumes uniqueness. If you generate unique data during the initialization phase, then you can use a [runtime hook](#) to restore uniqueness. With runtime hooks, you can run specific code immediately before Lambda takes a snapshot or immediately after Lambda resumes a function from a snapshot.

Avoid saving state that depends on uniqueness during initialization

During the [initialization phase](#) of your function, avoid caching data that's intended to be unique, such as generating a unique ID for logging or setting seeds for random functions. Instead, we recommend that you generate unique data or set seeds for random functions inside your function handler—or use a [runtime hook](#).

The following examples demonstrate how to generate a UUID in the function handler.

Java

Example – Generating a unique ID in function handler

```
import java.util.UUID;
public class Handler implements RequestHandler<String, String> {
    private static UUID uniqueSandboxId = null;
    @Override
    public String handleRequest(String event, Context context) {
        if (uniqueSandboxId == null)
            uniqueSandboxId = UUID.randomUUID();
        System.out.println("Unique Sandbox Id: " + uniqueSandboxId);
        return "Hello, World!";
    }
}
```

Python

Example – Generating a unique ID in function handler

```
import json
import random
import time

unique_number = None

def lambda_handler(event, context):
    seed = int(time.time() * 1000)
    random.seed(seed)
    global unique_number
    if not unique_number:
        unique_number = random.randint(1, 10000)

    print("Unique number: ", unique_number)

    return "Hello, World!"
```

.NET

Example – Generating a unique ID in function handler

```
namespace Example;
public class SnapstartExample
{
    private Guid _myExecutionEnvironmentGuid;
    public SnapstartExample()
    {
        // This GUID is set for non-restore use cases, such as testing or if
        SnapStart is turned off
        _myExecutionEnvironmentGuid = new Guid();
        // Register the method which will run after each restore. You may need to
        update Amazon.Lambda.Core to see this
        Amazon.Lambda.Core.SnapshotRestore.RegisterAfterRestore(MyAfterRestore);
    }

    private ValueTask MyAfterRestore()
    {
        // After restoring this snapshot to a new execution environment, update the
        GUID
```

```
        _myExecutionEnvironmentGuid = new Guid();
        return ValueTask.CompletedTask;
    }

    public string Handler()
    {
        return $"Hello World! My Execution Environment GUID is
{_myExecutionEnvironmentGuid}";
    }
}
```

Use cryptographically secure pseudorandom number generators (CSPRNGs)

If your application depends on randomness, we recommend that you use cryptographically secure random number generators (CSPRNGs). In addition to OpenSSL 1.0.2, the Lambda managed runtimes also include the following built-in CSPRNGs:

- **Java:** `java.security.SecureRandom`
- **Python:** `random.SystemRandom`
- **.NET:** `System.Security.Cryptography.RandomNumberGenerator`

Software that always gets random numbers from `/dev/random` or `/dev/urandom` also maintains randomness with SnapStart.

AWS cryptography libraries automatically maintain randomness with SnapStart beginning with the minimum versions specified in the following table. If you use these libraries with your Lambda functions, make sure that you use the following minimum versions or later versions:

Library	Minimum supported version (x86)	Minimum supported version (ARM)
AWS libcrypto (AWS-LC)	1.16.0	1.30.0
AWS libcrypto FIPS	2.0.13	2.0.13

If you package the preceding cryptographic libraries with your Lambda functions as transitive dependencies through the following libraries, make sure that you use the following minimum versions or later versions:

Library	Minimum supported version (x86)	Minimum supported version (ARM)
AWS SDK for Java 2.x	2.23.20	2.26.12
AWS Common Runtime for Java	0.29.8	0.29.25
Amazon Corretto Crypto Provider	2.4.1	2.4.1
Amazon Corretto Crypto Provider FIPS	2.4.1	2.4.1

The following examples demonstrate how to use CSPRNGs to guarantee unique number sequences even when the function is restored from a snapshot.

Java

Example – `java.security.SecureRandom`

```
import java.security.SecureRandom;
public class Handler implements RequestHandler<String, String> {
    private static SecureRandom rng = new SecureRandom();
    @Override
    public String handleRequest(String event, Context context) {
        for (int i = 0; i < 10; i++) {
            System.out.println(rng.next());
        }
        return "Hello, World!";
    }
}
```

Python

Example – random.SystemRandom

```
import json
import random

secure_rng = random.SystemRandom()

def lambda_handler(event, context):
    random_numbers = [secure_rng.random() for _ in range(10)]

    for number in random_numbers:
        print(number)

    return "Hello, World!"
```

.NET

Example – RandomNumberGenerator

```
using Amazon.Lambda.Core;
using System.Security.Cryptography;
[assembly:
    LambdaSerializer(typeof(Amazon.Lambda.Serialization.SystemTextJson.DefaultLambdaJsonSeriali

namespace DotnetSecureRandom;

public class Function
{
    public string FunctionHandler()
    {
        using (RandomNumberGenerator rng = RandomNumberGenerator.Create())
        {
            byte[] randomUnsignedInteger32Bytes = new byte[4];
            for (int i = 0; i < 10; i++)
            {
                rng.GetBytes(randomUnsignedInteger32Bytes);
                int randomInt32 = BitConverter.ToInt32(randomUnsignedInteger32Bytes,
0);

                Console.WriteLine("{0:G}", randomInt32);
            }
        }
    }
}
```

```
        return "Hello World!";  
    }  
}
```

SnapStart scanning tool (Java only)

Lambda provides a scanning tool for Java to help you check for code that assumes uniqueness. The SnapStart scanning tool is an open-source [SpotBugs](#) plugin that runs a static analysis against a set of rules. The scanning tool helps identify potential code implementations that might break assumptions regarding uniqueness. For installation instructions and a list of checks that the scanning tool performs, see the [aws-lambda-snapstart-java-rules](#) repository on GitHub.

To learn more about handling uniqueness with SnapStart, see [Starting up faster with AWS Lambda SnapStart](#) on the AWS Compute Blog.

Implement code before or after Lambda function snapshots

You can use runtime hooks to implement code before Lambda creates a snapshot or after Lambda resumes a function from a snapshot. Runtime hooks are useful for a variety of purposes, such as:

- **Cleanup and initialization:** Before a snapshot is created, you can use a runtime hook to perform cleanup or resource release operations. After a snapshot is restored, you can use a runtime hook to re-initialize any resources or state that were not captured in the snapshot.
- **Dynamic configuration:** You can use runtime hooks to dynamically update configuration or other metadata before a snapshot is created or after it is restored. This can be useful if your function needs to adapt to changes in the runtime environment.
- **External integrations:** You can use runtime hooks to integrate with external services or systems, such as sending notifications or updating external state, as part of the checkpointing and restoration process.
- **Performance tuning:** You can use runtime hooks to fine-tune your function's startup sequence, such as by preloading dependencies. For more information, see [Performance tuning](#).

The following pages explain how to implement runtime hooks for your preferred runtime.

Topics

- [Lambda SnapStart runtime hooks for Java](#)
- [Lambda SnapStart runtime hooks for Python](#)
- [Lambda SnapStart runtime hooks for .NET](#)

Lambda SnapStart runtime hooks for Java

You can use runtime hooks to implement code before Lambda creates a snapshot or after Lambda resumes a function from a snapshot. Runtime hooks are available as part of the open-source Coordinated Restore at Checkpoint (CRaC) project. CRaC is in development for the [Open Java Development Kit \(OpenJDK\)](#). For an example of how to use CRaC with a reference application, see the [CRaC](#) repository on GitHub. CRaC uses three main elements:

- **Resource** – An interface with two methods, `beforeCheckpoint()` and `afterRestore()`. Use these methods to implement the code that you want to run before a snapshot and after a restore.

- `Context <R extends Resource>` – To receive notifications for checkpoints and restores, a `Resource` must be registered with a `Context`.
- `Core` – The coordination service, which provides the default global `Context` via the static method `Core.getGlobalContext()`.

For more information about `Context` and `Resource`, see [Package org.crac](#) in the CRaC documentation.

Use the following steps to implement runtime hooks with the [org.crac package](#). The Lambda runtime contains a customized CRaC context implementation that calls your runtime hooks before checkpointing and after restoring.

Runtime hook registration and execution

The order that Lambda executes your runtime hooks is determined by the order of registration. Registration order follows the order of import, definition, or execution in your code.

- `beforeCheckpoint()`: Executed in the reverse order of registration
- `afterRestore()`: Executed in the order of registration

Make sure that all registered hooks are properly imported and included in your function's code. If you register runtime hooks in a separate file or module, you must ensure that the module is imported, either directly or as part of a larger package, in your function's handler file. If the file or module is not imported in the function handler, Lambda ignores the runtime hooks.

Note

When Lambda creates a snapshot, your initialization code can run for up to 15 minutes. The time limit is 130 seconds or the [configured function timeout](#) (maximum 900 seconds), whichever is higher. Your `beforeCheckpoint()` runtime hooks count towards the initialization code time limit. When Lambda restores a snapshot, the runtime must load and `afterRestore()` runtime hooks must complete within the timeout limit (10 seconds). Otherwise, you'll get a `SnapStartTimeoutException`.

Step 1: Update the build configuration

Add the `org.crac` dependency to the build configuration. The following example uses Gradle. For examples for other build systems, see the [Apache Maven documentation](#).

```
dependencies {
    compile group: 'com.amazonaws', name: 'aws-lambda-java-core', version: '1.2.1'
    # All other project dependencies go here:
    # ...
    # Then, add the org.crac dependency:
    implementation group: 'org.crac', name: 'crac', version: '1.4.0'
}
```

Step 2: Update the Lambda handler

The Lambda function *handler* is the method in your function code that processes events. When your function is invoked, Lambda runs the handler method. Your function runs until the handler returns a response, exits, or times out.

For more information, see [Define Lambda function handler in Java](#).

The following example handler shows how to run code before checkpointing (`beforeCheckpoint()`) and after restoring (`afterRestore()`). This handler also registers the `Resource` to the runtime-managed global `Context`.

Note

When Lambda creates a snapshot, your initialization code can run for up to 15 minutes. The time limit is 130 seconds or the [configured function timeout](#) (maximum 900 seconds), whichever is higher. Your `beforeCheckpoint()` runtime hooks count towards the initialization code time limit. When Lambda restores a snapshot, the runtime (JVM) must load and `afterRestore()` runtime hooks must complete within the timeout limit (10 seconds). Otherwise, you'll get a `SnapStartTimeoutException`.

```
...
import org.crac.Resource;
import org.crac.Core;
...
```

```
public class CRaCDemo implements RequestStreamHandler, Resource {
    public CRaCDemo() {
        Core.getGlobalContext().register(this);
    }
    public String handleRequest(String name, Context context) throws IOException {
        System.out.println("Handler execution");
        return "Hello " + name;
    }
    @Override
    public void beforeCheckpoint(org.crac.Context<? extends Resource> context)
        throws Exception {
        System.out.println("Before checkpoint");
    }
    @Override
    public void afterRestore(org.crac.Context<? extends Resource> context)
        throws Exception {
        System.out.println("After restore");
    }
}
```

Context maintains only a [WeakReference](#) to the registered object. If a [Resource](#) is garbage collected, runtime hooks do not run. Your code must maintain a strong reference to the Resource to guarantee that the runtime hook runs.

Here are two examples of patterns to avoid:

Example – Object without a strong reference

```
Core.getGlobalContext().register( new MyResource() );
```

Example – Objects of anonymous classes

```
Core.getGlobalContext().register( new Resource() {

    @Override
    public void afterRestore(Context<? extends Resource> context) throws Exception {
        // ...
    }

    @Override
    public void beforeCheckpoint(Context<? extends Resource> context) throws Exception {
        // ...
    }
}
```

```
} );
```

Instead, maintain a strong reference. In the following example, the registered resource isn't garbage collected and runtime hooks run consistently.

Example – Object with a strong reference

```
Resource myResource = new MyResource(); // This reference must be maintained to prevent  
the registered resource from being garbage collected  
Core.getGlobalContext().register( myResource );
```

Lambda SnapStart runtime hooks for Python

You can use runtime hooks to implement code before Lambda creates a snapshot or after Lambda resumes a function from a snapshot. Python runtime hooks are available as part of the open-source [Snapshot Restore for Python library](#), which is included in Python managed runtimes. This library provides two decorators that you can use to define your runtime hooks:

- `@register_before_snapshot`: For functions you want to run before Lambda creates a snapshot.
- `@register_after_restore`: For functions you want to run when Lambda resumes a function from a snapshot.

Alternatively, you can use the following methods to register callables for runtime hooks:

- `register_before_snapshot(func, *args, **kwargs)`
- `register_after_restore(func, *args, **kwargs)`

Runtime hook registration and execution

The order that Lambda executes your runtime hooks is determined by the order of registration:

- Before snapshot: Executed in the reverse order of registration
- After snapshot: Executed in the order of registration

The order of runtime hook registration depends on how you define the hooks. When using decorators (`@register_before_snapshot` and `@register_after_restore`), the

registration order follows the order of import, definition, or execution in your code. If you need more control over the registration order, use the `register_before_snapshot()` and `register_after_restore()` methods instead of decorators.

Make sure that all registered hooks are properly imported and included in your function's code. If you register runtime hooks in a separate file or module, you must ensure that the module is imported, either directly or as part of a larger package, in your function's handler file. If the file or module is not imported in the function handler, Lambda ignores the runtime hooks.

Note

When Lambda creates a snapshot, your initialization code can run for up to 15 minutes. The time limit is 130 seconds or the [configured function timeout](#) (maximum 900 seconds), whichever is higher. Your `@register_before_snapshot` runtime hooks count towards the initialization code time limit. When Lambda restores a snapshot, the runtime must load and `@register_after_restore` runtime hooks must complete within the timeout limit (10 seconds). Otherwise, you'll get a `SnapStartTimeoutException`.

Example

The following example handler shows how to run code before checkpointing (`@register_before_snapshot`) and after restoring (`@register_after_restore`).

```
from snapshot_restore_py import register_before_snapshot, register_after_restore

def lambda_handler(event, context):
    # Handler code

@register_before_snapshot
def before_checkpoint():
    # Logic to be executed before taking snapshots

@register_after_restore
def after_restore():
    # Logic to be executed after restore
```

For more examples, see [Snapshot Restore for Python](#) in the AWS GitHub repository.

Lambda SnapStart runtime hooks for .NET

You can use runtime hooks to implement code before Lambda creates a snapshot or after Lambda resumes a function from a snapshot. .NET runtime hooks are available as part of the [Amazon.Lambda.Core](#) package (version 2.5.0 or later). This library provides two methods that you can use to define your runtime hooks:

- `RegisterBeforeSnapshot()`: Code to run before snapshot creation
- `RegisterAfterSnapshot()`: Code to run after resuming a function from a snapshot

Note

If you're using the [Lambda Annotations framework for .NET](#), upgrade to [Amazon.Lambda.Annotations](#) version 1.6.0 or later to ensure compatibility with SnapStart.

Runtime hook registration and execution

Register your hooks in your initialization code. Consider the following guidelines based on your Lambda function's [execution model](#):

- For the [executable assembly approach](#), register your hooks before you start the Lambda bootstrap with `RunAsync`.
- For the [class library approach](#), register your hooks in the handler class constructor.
- For [ASP.NET Core applications](#), register your hooks before calling the `WebApplications.Run` method.

To register runtime hooks for SnapStart in .NET, use the following methods:

```
Amazon.Lambda.Core.SnapshotRestore.RegisterBeforeSnapshot(BeforeCheckpoint);
Amazon.Lambda.Core.SnapshotRestore.RegisterAfterRestore(AfterCheckpoint);
```

When multiple hook types are registered, the order that Lambda executes your runtime hooks is determined by the order of registration:

- `RegisterBeforeSnapshot()`: Executed in the reverse order of registration

- `RegisterAfterSnapshot()`: Executed in the order of registration

Note

When Lambda creates a snapshot, your initialization code can run for up to 15 minutes. The time limit is 130 seconds or the [configured function timeout](#) (maximum 900 seconds), whichever is higher. Your `RegisterBeforeSnapshot()` runtime hooks count towards the initialization code time limit. When Lambda restores a snapshot, the runtime must load and `RegisterAfterSnapshot()` runtime hooks must complete within the timeout limit (10 seconds). Otherwise, you'll get a `SnapStartTimeoutException`.

Example

The following example function shows how to run code before checkpointing (`RegisterBeforeSnapshot`) and after restoring (`RegisterAfterRestore`).

```
public class SampleClass
{
    public SampleClass()
    {
        Amazon.Lambda.Core.SnapshotRestore.RegisterBeforeSnapshot(BeforeCheckpoint);
        Amazon.Lambda.Core.SnapshotRestore.RegisterAfterRestore(AfterCheckpoint);
    }

    private ValueTask BeforeCheckpoint()
    {
        // Add logic to be executed before taking the snapshot
        return ValueTask.CompletedTask;
    }

    private ValueTask AfterCheckpoint()
    {
        // Add logic to be executed after restoring the snapshot
        return ValueTask.CompletedTask;
    }

    public APIGatewayProxyResponse FunctionHandler(APIGatewayProxyRequest request,
        ILambdaContext context)
    {
        // Add business logic
    }
}
```

```
        return new APIGatewayProxyResponse
        {
            StatusCode = 200
        };
    }
}
```

Monitoring for Lambda SnapStart

You can monitor your Lambda SnapStart functions using Amazon CloudWatch, AWS X-Ray, and the [Accessing real-time telemetry data for extensions using the Telemetry API](#).

Note

The `AWS_LAMBDA_LOG_GROUP_NAME` and `AWS_LAMBDA_LOG_STREAM_NAME` [environment variables](#) are not available in Lambda SnapStart functions.

Understanding logging and billing behavior with SnapStart

There are a few differences with the [CloudWatch log stream](#) format for SnapStart functions:

- **Initialization logs** – When a new execution environment is created, the REPORT doesn't include the `Init Duration` field. That's because Lambda initializes SnapStart functions when you create a version instead of during function invocation. For SnapStart functions, the `Init Duration` field is in the `INIT_REPORT` record. This record shows duration details for the [Init phase](#), including the duration of any `beforeCheckpoint` [runtime hooks](#).
- **Invocation logs** – When a new execution environment is created, the REPORT includes the `Restore Duration` and `Billed Restore Duration` fields:
 - **Restore Duration**: The time it takes for Lambda to restore a snapshot, load the runtime (JVM), and run any `afterRestore` runtime hooks. The process of restoring snapshots can include time spent on activities outside the MicroVM. This time is reported in `Restore Duration`.
 - **Billed Restore Duration**: The time it takes for Lambda to load the runtime (JVM) and run any `afterRestore` hooks.

Note

As with all Lambda functions, duration charges apply to code that runs in the function handler. For SnapStart functions, duration charges also apply to initialization code that's declared outside of the handler, the time it takes for the runtime to load, and any code that runs in a [runtime hook](#).

The cold start duration is the sum of `Restore Duration + Duration`.

The following example is a Lambda Insights query that returns the latency percentiles for SnapStart functions. For more information about Lambda Insights queries, see [Example workflow using queries to troubleshoot a function](#).

```
filter @type = "REPORT"
  | parse @log /\d+:\aws\lambda\(?<function>.*)/
  | parse @message /Restore Duration: (?<restoreDuration>.*?) ms/
  | stats
count(*) as invocations,
pct(@duration+coalesce(@initDuration,0)+coalesce(restoreDuration,0), 50) as p50,
pct(@duration+coalesce(@initDuration,0)+coalesce(restoreDuration,0), 90) as p90,
pct(@duration+coalesce(@initDuration,0)+coalesce(restoreDuration,0), 99) as p99,
pct(@duration+coalesce(@initDuration,0)+coalesce(restoreDuration,0), 99.9) as p99.9
group by function, (ispresent(@initDuration) or ispresent(restoreDuration)) as
coldstart
  | sort by coldstart desc
```

X-Ray active tracing for SnapStart

You can use [X-Ray](#) to trace requests to Lambda SnapStart functions. There are a few differences with the X-Ray subsegments for SnapStart functions:

- There is no `Initialization` subsegment for SnapStart functions.
- The `Restore` subsegment shows the time it takes for Lambda to restore a snapshot, load the runtime (JVM), and run any `afterRestore` [runtime hooks](#). The process of restoring snapshots can include time spent on activities outside the MicroVM. This time is reported in the `Restore` subsegment. You aren't charged for the time spent outside the microVM to restore a snapshot.

Telemetry API events for SnapStart

Lambda sends the following SnapStart events to the [Telemetry API](#):

- [platform.restoreStart](#) – Shows the time when the [Restore phase](#) started.
- [platform.restoreRuntimeDone](#) – Shows whether the `Restore` phase was successful. Lambda sends this message when the runtime sends a `restore/next` runtime API request. There are three possible statuses: `success`, `failure`, and `timeout`.

- [platform.restoreReport](#) – Shows how long the Restore phase lasted and how many milliseconds you were billed for during this phase.

Amazon API Gateway and function URL metrics

If you create a web API [using API Gateway](#), then you can use the [IntegrationLatency](#) metric to measure end-to-end latency (the time between when API Gateway relays a request to the backend and when it receives a response from the backend).

If you're using a [Lambda function URL](#), then you can use the [UrlRequestLatency](#) metric to measure end-to-end latency (the time between when the function URL receives a request and when the function URL returns a response).

Security model for Lambda SnapStart

Lambda SnapStart supports encryption at rest. Lambda encrypts snapshots with an AWS KMS key. By default, Lambda uses an AWS managed key. If this default behavior suits your workflow, then you don't need to set up anything else. Otherwise, you can use the `--kms-key-arn` option in the [create-function](#) or [update-function-configuration](#) command to provide an AWS KMS customer managed key. You might do this to control rotation of the KMS key or to meet the requirements of your organization for managing KMS keys. Customer managed keys incur standard AWS KMS charges. For more information, see [AWS Key Management Service pricing](#).

When you delete a SnapStart function or function version, all Invoke requests to that function or function version fail. Lambda removes all resources associated with deleted snapshots in compliance with the General Data Protection Regulation (GDPR).

Maximize Lambda SnapStart performance

Topics

- [Performance tuning](#)
- [Networking best practices](#)

Performance tuning

To maximize the benefits of SnapStart, consider the following code optimization recommendations for your runtime.

Note

SnapStart works best when used with function invocations at scale. Functions that are invoked infrequently might not experience the same performance improvements.

Java

To maximize the benefits of SnapStart, we recommend that you preload dependencies and initialize resources that contribute to startup latency in your initialization code instead of in the function handler. This moves the latency associated with heavy class loading out of the invocation path, optimizing startup performance with SnapStart.

If you can't preload dependencies or resources during initialization, then we recommend that you preload them with dummy invocations. To do this, update the function handler code, as shown in the following example from the [pet store function](#) on the AWS Labs GitHub repository.

```
private static SpringLambdaContainerHandler<AwsProxyRequest, AwsProxyResponse> handler;
static {
    try {
        handler =
            SpringLambdaContainerHandler.getAwsProxyHandler(PetStoreSpringAppConfig.class);

        // Use the onStartup method of the handler to register the custom filter
        handler.onStartup(servletContext -> {
            FilterRegistration.Dynamic registration =
                servletContext.addFilter("CognitoIdentityFilter", CognitoIdentityFilter.class);
```

```
        registration.addMappingForUrlPatterns(EnumSet.of(DispatcherType.REQUEST),
false, "/*");
    });

    // Send a fake Amazon API Gateway request to the handler to load classes
ahead of time
    ApiGatewayRequestIdentity identity = new ApiGatewayRequestIdentity();
    identity.setApiKey("foo");
    identity.setAccountId("foo");
    identity.setAccessKey("foo");

    AwsProxyRequestContext reqCtx = new AwsProxyRequestContext();
    reqCtx.setPath("/pets");
    reqCtx.setStage("default");
    reqCtx.setAuthorizer(null);
    reqCtx.setIdentity(identity);

    AwsProxyRequest req = new AwsProxyRequest();
    req.setHttpMethod("GET");
    req.setPath("/pets");
    req.setBody("");
    req.setRequestContext(reqCtx);

    Context ctx = new TestContext();
    handler.proxy(req, ctx);

} catch (ContainerInitializationException e) {
    // if we fail here. We re-throw the exception to force another cold start
    e.printStackTrace();
    throw new RuntimeException("Could not initialize Spring framework", e);
}
}
```

Python

To maximize the benefits of SnapStart, focus on efficient code organization and resource management within your Python functions. As a general guideline, perform heavy computational tasks during the [initialization phase](#). This approach moves time-consuming operations out of the invocation path, improving overall function performance. To implement this strategy effectively, we recommend the following best practices:

- Import dependencies outside of the function handler.

- Create boto3 instances outside of the handler.
- Initialize static resources or configurations before the handler is invoked.
- Consider using a before-snapshot [runtime hook](#) for resource-intensive tasks such as downloading external files, pre-loading frameworks like Django, or loading machine learning models.

Example — Optimize Python function for SnapStart

```
# Import all dependencies outside of Lambda handler
from snapshot_restore_py import register_before_snapshot
import boto3
import pandas
import pydantic

# Create S3 and SSM clients outside of Lambda handler
s3_client = boto3.client("s3")

# Register the function to be called before snapshot
@register_before_snapshot
def download_llm_models():
    # Download an object from S3 and save to tmp
    # This files will persist in this snapshot
    with open('/tmp/FILE_NAME', 'wb') as f:
        s3_client.download_fileobj('amzn-s3-demo-bucket', 'OBJECT_NAME', f)
    ...

def lambda_handler(event, context):
    ...
```

.NET

To reduce just-in-time (JIT) compilation and assembly loading time, consider invoking your function handler from a `RegisterBeforeCheckpoint` [runtime hook](#). Because of how .NET tiered compilation works, you'll get optimal results by invoking the handler multiple times, as shown in the following example.

Important

Make sure that your dummy function invocation does not produce unintended side effects, such as initiating business transactions.

Example

```
public class Function
{
    public Function()
    {
        Amazon.Lambda.Core.SnapshotRestore.RegisterBeforeSnapshot(FunctionWarmup);
    }

    // Warmup method that calls the function handler before snapshot to warm up
    the .NET code and runtime.
    // This speeds up future cold starts after restoring from a snapshot.

    private async ValueTask FunctionWarmup()
    {
        var request = new APIGatewayProxyRequest
        {
            Path = "/heathcheck",
            HttpMethod = "GET"
        };

        for (var i = 0; i < 10; i++)
        {
            await FunctionHandler(request, null);
        }
    }

    public async Task<APIGatewayProxyResponse> FunctionHandler(APIGatewayProxyRequest
request, ILambdaContext context)
    {
        //
        // Process HTTP request
        //

        var response = new APIGatewayProxyResponse
        {
            StatusCode = 200
        };

        return await Task.FromResult(response);
    }
}
```

Networking best practices

The state of connections that your function establishes during the initialization phase isn't guaranteed when Lambda resumes your function from a snapshot. In most cases, network connections that an AWS SDK establishes automatically resume. For other connections, we recommend the following best practices.

Re-establish network connections

Always re-establish your network connections when your function resumes from a snapshot. We recommend that you re-establish network connections in the function handler. Alternatively, you can use an after-restore [runtime hook](#).

Don't use hostname as a unique execution environment identifier

We recommend against using `hostname` to identify your execution environment as a unique node or container in your applications. With SnapStart, a single snapshot is used as the initial state for multiple execution environments. All execution environments return the same `hostname` value for `InetAddress.getLocalHost()` (Java), `socket.gethostname()` (Python), and `Dns.GetHostName()` (.NET). For applications that require a unique execution environment identity or `hostname` value, we recommend that you generate a unique ID in the function handler. Or, use an after-restore [runtime hook](#) to generate a unique ID, and then use the unique ID as the identifier for the execution environment.

Avoid binding connections to fixed source ports

We recommend that you avoid binding network connections to fixed source ports. Connections are re-established when a function resumes from a snapshot, and network connections that are bound to a fixed source port might fail.

Avoid using Java DNS cache

Lambda functions already cache DNS responses. If you use another DNS cache with SnapStart, then you might experience connection timeouts when the function resumes from a snapshot.

The `java.util.logging.Logger` class can indirectly enable the JVM DNS cache. To override the default settings, set [networkaddress.cache.ttl](#) to 0 before initializing `logger`. Example:

```
public class MyHandler {
    // first set TTL property
```

```
static{
    java.security.Security.setProperty("networkaddress.cache.ttl" , "0");
}
// then instantiate logger
var logger = org.apache.logging.log4j.LogManager.getLogger(MyHandler.class);
}
```

To prevent `UnknownHostException` failures in the Java 11 runtime, we recommend setting `networkaddress.cache.negative.ttl` to 0. In Java 17 and later runtimes, this step isn't necessary. You can set this property for a Lambda function with the `AWS_LAMBDA_JAVA_NETWORKADDRESS_CACHE_NEGATIVE_TTL=0` environment variable.

Disabling the JVM DNS cache does not disable Lambda's managed DNS caching.

Troubleshooting SnapStart errors for Lambda functions

This page addresses common issues that occur when using Lambda SnapStart, including snapshot creation errors, timeout errors, and internal service errors.

SnapStartNotReadyException

Error: An error occurred (SnapStartNotReadyException) when calling the Invoke20150331 operation: Lambda is initializing your function. It will be ready to invoke once your function state becomes ACTIVE.

Common causes

This error occurs when you try to invoke a function version that is in the `Inactive` [state](#). Your function version becomes `Inactive` when it hasn't been invoked for 14 days or when Lambda periodically recycles the execution environment.

Resolution

Wait until the function version reaches the `Active` state, and then invoke it again.

SnapStartTimeoutException

Issue: You receive a `SnapStartTimeoutException` when you try to invoke a SnapStart function version.

Common cause

During the [Restore](#) phase, Lambda restores the Java runtime and runs any after-restore [runtime hooks](#). If an after-restore runtime hook runs for longer than 10 seconds, the `Restore` phase times out and you get an error when you try to invoke the function. Network connection and credentials issues can also cause `Restore` phase timeouts.

Resolution

Check the function's CloudWatch logs for timeout errors that happened during the [Restore](#) phase. Make sure that all after-restore hooks complete in less than 10 seconds.

Example CloudWatch log

```
{ "cause": "Lambda couldn't restore the snapshot within the timeout limit. (Service: Lambda, Status Code: 408, Request ID: 11a222c3-410f-427c-ab22-931d6bcbf4f2)", "error": "Lambda.SnapStartTimeoutException"}
```

500 Internal Service Error

Error: Lambda was unable to create a new snapshot because you have reached your concurrent snapshot creation limit.

Common cause

A 500 error is an internal error within the Lambda service itself, rather than an issue with your function or code. These errors are often intermittent.

Resolution

Try to publish the function version again.

401 Unauthorized

Error: Bad session token or header key

Common cause

This error occurs when using the [AWS Systems Manager Parameter Store and AWS Secrets Manager extension](#) with Lambda SnapStart.

Resolution

The AWS Systems Manager Parameter Store and AWS Secrets Manager extension isn't compatible with SnapStart. The extension generates credentials for communicating with AWS Secrets Manager during function initialization, which causes expired credential errors when used with SnapStart.

UnknownHostException (Java)

Error: Unable to execute HTTP request: Certificate for abc.us-east-1.amazonaws.com doesn't match any of the subject alternative names.

Common cause

Lambda functions already cache DNS responses. If you use another DNS cache with SnapStart, then you might experience connection timeouts when the function resumes from a snapshot.

Resolution

To prevent `UnknownHostException` failures in the Java 11 runtime, we recommend setting `networkaddress.cache.negative.ttl` to 0. In Java 17 and later runtimes, this step isn't necessary. You can set this property for a Lambda function with the `AWS_LAMBDA_JAVA_NETWORKADDRESS_CACHE_NEGATIVE_TTL=0` environment variable.

Snapshot creation failures

Error: AWS Lambda could not invoke your SnapStart function. If this error persists, check your function's CloudWatch logs for initialization errors.

Resolution

Review your function's Amazon CloudWatch logs for before-checkpoint [runtime hook](#) timeouts. You can also try publishing a new function version, which can sometimes resolve the issue.

Snapshot creation latency

Issue: When you publish a new function version, the function stays in the Pending [state](#) for a long time.

Common cause

When Lambda creates a snapshot, your initialization code can run for up to 15 minutes. The time limit is 130 seconds or the [configured function timeout](#) (maximum 900 seconds), whichever is higher.

If your function is [attached to a VPC](#), Lambda might also need to create network interfaces before the function becomes Active. If you try to invoke the function version while the function is Pending, you might get a `409 ResourceConflictException`. If the function is invoked using an Amazon API Gateway endpoint, you might get a 500 error in API Gateway.

Resolution

Wait at least 15 minutes for the function version to initialize before invoking it.

Invoking Lambda with events from other AWS services

Some AWS services can directly invoke Lambda functions using *triggers*. These services push events to Lambda, and the function is invoked immediately when the specified event occurs. Triggers are suitable for discrete events and real-time processing. When you [create a trigger using the Lambda console](#), the console interacts with the corresponding AWS service to configure the event notification on that service. The trigger is actually stored and managed by the service that generates the events, not by Lambda.

The events are data structured in JSON format. The JSON structure varies depending on the service that generates it and the event type, but they all contain the data that the function needs to process the event.

A function can have multiple triggers. Each trigger acts as a client invoking your function independently, and each event that Lambda passes to your function has data from only one trigger. Lambda converts the event document into an object and passes it to your function handler.

Depending on the service, the event-driven invocation can be [synchronous](#) or [asynchronous](#).

- For synchronous invocation, the service that generates the event waits for the response from your function. That service defines the data that the function needs to return in the response. The service controls the error strategy, such as whether to retry on errors.
- For asynchronous invocation, Lambda queues the event before passing it to your function. When Lambda queues the event, it immediately sends a success response to the service that generated the event. After the function processes the event, Lambda doesn't return a response to the event-generating service.

Creating a trigger

The easiest way to create a trigger is to use the Lambda console. When you create a trigger using the console, Lambda automatically adds the required permissions to the function's [resource-based policy](#).

To create a trigger using the Lambda console

1. Open the [Functions page](#) of the Lambda console.
2. Select the function you want to create a trigger for.

3. In the **Function overview** pane, choose **Add trigger**.
4. Select the AWS service you want to invoke your function.
5. Fill out the options in the **Trigger configuration** pane and choose **Add**. Depending on the AWS service you choose to invoke your function, the trigger configuration options will be different.

Services that can invoke Lambda functions

The following table lists services that can invoke Lambda functions.

Service	Method of invocation
Amazon Managed Streaming for Apache Kafka	Event source mapping
Self-managed Apache Kafka	Event source mapping
Amazon API Gateway	Event-driven; synchronous invocation
AWS CloudFormation	Event-driven; asynchronous invocation
Amazon CloudWatch Logs	Event-driven; asynchronous invocation
AWS CodeCommit	Event-driven; asynchronous invocation
AWS CodePipeline	Event-driven; asynchronous invocation
Amazon Cognito	Event-driven; synchronous invocation
AWS Config	Event-driven; asynchronous invocation
Amazon Connect	Event-driven; synchronous invocation
Amazon DynamoDB	Event source mapping
Amazon Elastic File System	Special integration
Elastic Load Balancing (Application Load Balancer)	Event-driven; synchronous invocation

Service	Method of invocation
Amazon EventBridge (CloudWatch Events)	Event-driven; asynchronous invocation (event buses), synchronous or asynchronous invocation (pipes and schedules)
AWS IoT	Event-driven; asynchronous invocation
Amazon Kinesis	Event source mapping
Amazon Data Firehose	Event-driven; synchronous invocation
Amazon Lex	Event-driven; synchronous invocation
Amazon MQ	Event source mapping
Amazon Simple Email Service	Event-driven; asynchronous invocation
Amazon Simple Notification Service	Event-driven; asynchronous invocation
Amazon Simple Queue Service	Event source mapping
Amazon Simple Storage Service (Amazon S3)	Event-driven; asynchronous invocation
Amazon Simple Storage Service Batch	Event-driven; synchronous invocation
Secrets Manager	Special integration
AWS Step Functions	Event-driven; synchronous or asynchronous invocation
Amazon VPC Lattice	Event-driven; synchronous invocation
AWS X-Ray	Special integration

Using Lambda with self-managed Apache Kafka

Note

If you want to send data to a target other than a Lambda function or enrich the data before sending it, see [Amazon EventBridge Pipes](#).

Lambda supports [Apache Kafka](#) as an [event source](#). Apache Kafka is an open-source event streaming platform that supports workloads such as data pipelines and streaming analytics.

You can use the AWS managed Kafka service Amazon Managed Streaming for Apache Kafka (Amazon MSK), or a self-managed Kafka cluster. For details about using Lambda with Amazon MSK, see [Using Lambda with Amazon MSK](#).

This topic describes how to use Lambda with a self-managed Kafka cluster. In AWS terminology, a self-managed cluster includes non-AWS hosted Kafka clusters. For example, you can host your Kafka cluster with a cloud provider such as [Confluent Cloud](#).

Apache Kafka as an event source operates similarly to using Amazon Simple Queue Service (Amazon SQS) or Amazon Kinesis. Lambda internally polls for new messages from the event source and then synchronously invokes the target Lambda function. Lambda reads the messages in batches and provides these to your function as an event payload. The maximum batch size is configurable (the default is 100 messages). For more information, see [the section called “Batching behavior”](#).

To optimize the throughput of your self-managed Apache Kafka event source mapping, configure provisioned mode. In provisioned mode, you can define the minimum and maximum number of event pollers allocated to your event source mapping. This can improve the ability of your event source mapping to handle unexpected message spikes. For more information, see [provisioned mode](#).

Warning

Lambda event source mappings process each event at least once, and duplicate processing of records can occur. To avoid potential issues related to duplicate events, we strongly recommend that you make your function code idempotent. To learn more, see [How do I make my Lambda function idempotent](#) in the AWS Knowledge Center.

For Kafka-based event sources, Lambda supports processing control parameters, such as batching windows and batch size. For more information, see [Batching behavior](#).

For an example of how to use self-managed Kafka as an event source, see [Using self-hosted Apache Kafka as an event source for AWS Lambda](#) on the AWS Compute Blog.

Topics

- [Example event](#)
- [Configuring self-managed Apache Kafka event sources for Lambda](#)
- [Processing self-managed Apache Kafka messages with Lambda](#)
- [Using event filtering with a self-managed Apache Kafka event source](#)
- [Capturing discarded batches for a self-managed Apache Kafka event source](#)
- [Troubleshooting self-managed Apache Kafka event source mapping errors](#)

Example event

Lambda sends the batch of messages in the event parameter when it invokes your Lambda function. The event payload contains an array of messages. Each array item contains details of the Kafka topic and Kafka partition identifier, together with a timestamp and a base64-encoded message.

```
{
  "eventSource": "SelfManagedKafka",
  "bootstrapServers": "b-2.demo-cluster-1.a1bcde.c1.kafka.us-east-1.amazonaws.com:9092,b-1.demo-cluster-1.a1bcde.c1.kafka.us-east-1.amazonaws.com:9092",
  "records": {
    "mytopic-0": [
      {
        "topic": "mytopic",
        "partition": 0,
        "offset": 15,
        "timestamp": 1545084650987,
        "timestampType": "CREATE_TIME",
        "key": "abcDEFghiJKLmnoPQRstuVWXYZ1234==",
        "value": "SGVsbG8sIHRoaXMgaXMgYSB0ZXN0Lg==",
        "headers": [
          {
            "headerKey": [
```

```
104,  
101,  
97,  
100,  
101,  
114,  
86,  
97,  
108,  
117,  
101  
]  
}  
]  
}  
]  
}  
]  
}
```

Configuring self-managed Apache Kafka event sources for Lambda

Before you create an event source mapping for your self-managed Apache Kafka cluster, you need to ensure that your cluster and the VPC it resides in are correctly configured. You also need to make sure that your Lambda function's [execution role](#) has the necessary IAM permissions.

Follow the instructions in the following sections to configure your self-managed Apache Kafka cluster and Lambda function. To learn how to create the event source mapping, see [the section called "Adding a Kafka cluster as an event source"](#).

Topics

- [Kafka cluster authentication](#)
- [API access and Lambda function permissions](#)
- [Configure network security](#)

Kafka cluster authentication

Lambda supports several methods to authenticate with your self-managed Apache Kafka cluster. Make sure that you configure the Kafka cluster to use one of these supported authentication methods. For more information about Kafka security, see the [Security](#) section of the Kafka documentation.

SASL/SCRAM authentication

Lambda supports Simple Authentication and Security Layer/Salted Challenge Response Authentication Mechanism (SASL/SCRAM) authentication with Transport Layer Security (TLS) encryption (SASL_SSL). Lambda sends the encrypted credentials to authenticate with the cluster. Lambda doesn't support SASL/SCRAM with plaintext (SASL_PLAINTEXT). For more information about SASL/SCRAM authentication, see [RFC 5802](#).

Lambda also supports SASL/PLAIN authentication. Because this mechanism uses clear text credentials, the connection to the server must use TLS encryption to ensure that the credentials are protected.

For SASL authentication, you store the sign-in credentials as a secret in AWS Secrets Manager. For more information about using Secrets Manager, see [Tutorial: Create and retrieve a secret](#) in the *AWS Secrets Manager User Guide*.

Important

To use Secrets Manager for authentication, secrets must be stored in the same AWS region as your Lambda function.

Mutual TLS authentication

Mutual TLS (mTLS) provides two-way authentication between the client and server. The client sends a certificate to the server for the server to verify the client, and the server sends a certificate to the client for the client to verify the server.

In self-managed Apache Kafka, Lambda acts as the client. You configure a client certificate (as a secret in Secrets Manager) to authenticate Lambda with your Kafka brokers. The client certificate must be signed by a CA in the server's trust store.

The Kafka cluster sends a server certificate to Lambda to authenticate the Kafka brokers with Lambda. The server certificate can be a public CA certificate or a private CA/self-signed certificate. The public CA certificate must be signed by a certificate authority (CA) that's in the Lambda trust store. For a private CA/self-signed certificate, you configure the server root CA certificate (as a secret in Secrets Manager). Lambda uses the root certificate to verify the Kafka brokers.

For more information about mTLS, see [Introducing mutual TLS authentication for Amazon MSK as an event source](#).

Configuring the client certificate secret

The `CLIENT_CERTIFICATE_TLS_AUTH` secret requires a certificate field and a private key field. For an encrypted private key, the secret requires a private key password. Both the certificate and private key must be in PEM format.

Note

Lambda supports the [PBES1](#) (but not PBES2) private key encryption algorithms.

The certificate field must contain a list of certificates, beginning with the client certificate, followed by any intermediate certificates, and ending with the root certificate. Each certificate must start on a new line with the following structure:

```
-----BEGIN CERTIFICATE-----  
    <certificate contents>  
-----END CERTIFICATE-----
```

Secrets Manager supports secrets up to 65,536 bytes, which is enough space for long certificate chains.

The private key must be in [PKCS #8](#) format, with the following structure:

```
-----BEGIN PRIVATE KEY-----  
    <private key contents>  
-----END PRIVATE KEY-----
```

For an encrypted private key, use the following structure:

```
-----BEGIN ENCRYPTED PRIVATE KEY-----  
    <private key contents>  
-----END ENCRYPTED PRIVATE KEY-----
```

The following example shows the contents of a secret for mTLS authentication using an encrypted private key. For an encrypted private key, include the private key password in the secret.

```
{"privateKeyPassword":"testpassword",
```

```
"certificate": "-----BEGIN CERTIFICATE-----
MIIE5DCCAsygAwIBAgIRAPJdwaFaNRrytHBto0j5BA0wDQYJKoZIhvcNAQELBQAw
...
j0Lh4/+1HfgyE2KlmII36dg4IMzNjAFEBZiCRoPim040s1cRqtFHxoa10QQbIlxk
cmUuiAii9R0=
-----END CERTIFICATE-----
-----BEGIN CERTIFICATE-----
MIIFgjCCA2qgAwIBAgIQdJnZd6uFf9hbNC5RdfmHrzANBqkqhkiG9w0BAQsFADBB
...
rQoiowbbk5wXCheYSANQIfTZ6weQTgiCHCCbuuMKNVS95FkXm0vqVD/YpXKwA/no
c8PH3PSoAaRwMMgOSA2ALJvbRz8mpg==
-----END CERTIFICATE-----",
"privateKey": "-----BEGIN ENCRYPTED PRIVATE KEY-----
MIIFKzBVBgkqhkiG9w0BBQ0wSDANBgkqhkiG9w0BBQwwGgQUiAFcK5hT/X7Kjmgp
...
QrSekqF+kWzmB6nAfSzg09IaoAaytLvNgGTckWeUkWn/V0Ck+LdGUXzAC4RxZnoQ
zp2mwJn2NYB7AZ7+imp0azDZb+8YG2aUCiyqb6PnnA==
-----END ENCRYPTED PRIVATE KEY-----"
}
```

Configuring the server root CA certificate secret

You create this secret if your Kafka brokers use TLS encryption with certificates signed by a private CA. You can use TLS encryption for VPC, SASL/SCRAM, SASL/PLAIN, or mTLS authentication.

The server root CA certificate secret requires a field that contains the Kafka broker's root CA certificate in PEM format. The following example shows the structure of the secret.

```
{"certificate": "-----BEGIN CERTIFICATE-----
MIID7zCCAtægAwIBAgIBADANBgkqhkiG9w0BAQsFADCBmDELMAkGA1UEBhMCVVMx
EDA0BgNVBAGTB0FyaXpvmExEzARBgNVBAcTC1Njb3R0c2RhbGUxJTAjBgNVBAoT
HFN0YXJmaWVsZCBUZWNobm9sb2dpZXMsIEluYy4x0zA5BgNVBAMTM1N0YXJmaWVs
ZCBTZXJ2aWNlcysBsb290IENlcnRpZmljYXR1IEF1dG...
-----END CERTIFICATE-----"
}
```

API access and Lambda function permissions

In addition to accessing your self-managed Kafka cluster, your Lambda function needs permissions to perform various API actions. You add these permissions to the function's [execution role](#). If your users need access to any API actions, add the required permissions to the identity policy for the AWS Identity and Access Management (IAM) user or role.

Required Lambda function permissions

To create and store logs in a log group in Amazon CloudWatch Logs, your Lambda function must have the following permissions in its execution role:

- [logs:CreateLogGroup](#)
- [logs:CreateLogStream](#)
- [logs:PutLogEvents](#)

Optional Lambda function permissions

Your Lambda function might also need permissions to:

- Describe your Secrets Manager secret.
- Access your AWS Key Management Service (AWS KMS) customer managed key.
- Access your Amazon VPC.
- Send records of failed invocations to a destination.

Secrets Manager and AWS KMS permissions

Depending on the type of access control that you're configuring for your Kafka brokers, your Lambda function might need permission to access your Secrets Manager secret or to decrypt your AWS KMS customer managed key. To access these resources, your function's execution role must have the following permissions:

- [secretsmanager:GetSecretValue](#)
- [kms:Decrypt](#)

VPC permissions

If only users within a VPC can access your self-managed Apache Kafka cluster, your Lambda function must have permission to access your Amazon VPC resources. These resources include your VPC, subnets, security groups, and network interfaces. To access these resources, your function's execution role must have the following permissions:

- [ec2:CreateNetworkInterface](#)
- [ec2:DescribeNetworkInterfaces](#)

- [ec2:DescribeVpcs](#)
- [ec2:DeleteNetworkInterface](#)
- [ec2:DescribeSubnets](#)
- [ec2:DescribeSecurityGroups](#)

Adding permissions to your execution role

To access other AWS services that your self-managed Apache Kafka cluster uses, Lambda uses the permissions policies that you define in your Lambda function's [execution role](#).

By default, Lambda is not permitted to perform the required or optional actions for a self-managed Apache Kafka cluster. You must create and define these actions in an [IAM trust policy](#) for your execution role. This example shows how you might create a policy that allows Lambda to access your Amazon VPC resources.

```
{
  "Version": "2012-10-17",
  "Statement": [
    {
      "Effect": "Allow",
      "Action": [
        "ec2:CreateNetworkInterface",
        "ec2:DescribeNetworkInterfaces",
        "ec2:DescribeVpcs",
        "ec2:DeleteNetworkInterface",
        "ec2:DescribeSubnets",
        "ec2:DescribeSecurityGroups"
      ],
      "Resource": "*"
    }
  ]
}
```

Granting users access with an IAM policy

By default, users and roles don't have permission to perform [event source API operations](#). To grant access to users in your organization or account, you create or update an identity-based policy. For more information, see [Controlling access to AWS resources using policies](#) in the *IAM User Guide*.

Configure network security

To give Lambda full access to self-managed Apache Kafka through your event source mapping, either your cluster must use a public endpoint (public IP address), or you must provide access to the Amazon VPC you created the cluster in.

When you use self-managed Apache Kafka with Lambda, create [AWS PrivateLink VPC endpoints](#) that provide your function access to the resources in your Amazon VPC.

Note

AWS PrivateLink VPC endpoints are required for functions with event source mappings that use the default (on-demand) mode for event pollers. If your event source mapping uses [provisioned mode](#), you don't need to configure AWS PrivateLink VPC endpoints.

Create an endpoint to provide access to the following resources:

- Lambda — Create an endpoint for the Lambda service principal.
- AWS STS — Create an endpoint for the AWS STS in order for a service principal to assume a role on your behalf.
- Secrets Manager — If your cluster uses Secrets Manager to store credentials, create an endpoint for Secrets Manager.

Alternatively, configure a NAT gateway on each public subnet in the Amazon VPC. For more information, see [the section called “Internet access for VPC functions”](#).

When you create an event source mapping for self-managed Apache Kafka, Lambda checks whether Elastic Network Interfaces (ENIs) are already present for the subnets and security groups configured for your Amazon VPC. If Lambda finds existing ENIs, it attempts to re-use them. Otherwise, Lambda creates new ENIs to connect to the event source and invoke your function.

Note

Lambda functions always run inside VPCs owned by the Lambda service. Your function's VPC configuration does not affect the event source mapping. Only the networking configuration of the event source's determines how Lambda connects to your event source.

Configure the security groups for the Amazon VPC containing your cluster. By default, self-managed Apache Kafka uses the following ports: 9092.

- Inbound rules – Allow all traffic on the default cluster port for the security group associated with your event source.
- Outbound rules – Allow all traffic on port 443 for all destinations. Allow all traffic on the default cluster port for the security group associated with your event source.
- Amazon VPC endpoint inbound rules — If you are using an Amazon VPC endpoint, the security group associated with your Amazon VPC endpoint must allow inbound traffic on port 443 from the cluster security group.

If your cluster uses authentication, you can also restrict the endpoint policy for the Secrets Manager endpoint. To call the Secrets Manager API, Lambda uses your function role, not the Lambda service principal.

Example VPC endpoint policy — Secrets Manager endpoint

```
{
  "Statement": [
    {
      "Action": "secretsmanager:GetSecretValue",
      "Effect": "Allow",
      "Principal": {
        "AWS": [
          "arn:aws::iam::123456789012:role/my-role"
        ]
      },
      "Resource": "arn:aws::secretsmanager:us-west-2:123456789012:secret:my-secret"
    }
  ]
}
```

When you use Amazon VPC endpoints, AWS routes your API calls to invoke your function using the endpoint's Elastic Network Interface (ENI). The Lambda service principal needs to call `lambda:InvokeFunction` on any roles and functions that use those ENIs.

By default, Amazon VPC endpoints have open IAM policies that allow broad access to resources. Best practice is to restrict these policies to perform the needed actions using that endpoint.

To ensure that your event source mapping is able to invoke your Lambda function, the VPC endpoint policy must allow the Lambda service principal to call `sts:AssumeRole` and `lambda:InvokeFunction`. Restricting your VPC endpoint policies to allow only API calls originating within your organization prevents the event source mapping from functioning properly, so `"Resource": "*"` is required in these policies.

The following example VPC endpoint policies show how to grant the required access to the Lambda service principal for the AWS STS and Lambda endpoints.

Example VPC Endpoint policy — AWS STS endpoint

```
{
  "Statement": [
    {
      "Action": "sts:AssumeRole",
      "Effect": "Allow",
      "Principal": {
        "Service": [
          "lambda.amazonaws.com"
        ]
      },
      "Resource": "*"
    }
  ]
}
```

Example VPC Endpoint policy — Lambda endpoint

```
{
  "Statement": [
    {
      "Action": "lambda:InvokeFunction",
      "Effect": "Allow",
      "Principal": {
        "Service": [
          "lambda.amazonaws.com"
        ]
      },
      "Resource": "*"
    }
  ]
}
```

Processing self-managed Apache Kafka messages with Lambda

Note

If you want to send data to a target other than a Lambda function or enrich the data before sending it, see [Amazon EventBridge Pipes](#).

Topics

- [Adding a Kafka cluster as an event source](#)
- [Self-managed Apache Kafka configuration parameters](#)
- [Using a Kafka cluster as an event source](#)
- [Polling and stream starting positions](#)
- [Message throughput scaling behavior for self-managed Apache Kafka event source mappings](#)
- [Amazon CloudWatch metrics](#)

Adding a Kafka cluster as an event source

To create an [event source mapping](#), add your Kafka cluster as a Lambda function [trigger](#) using the Lambda console, an [AWS SDK](#), or the [AWS Command Line Interface \(AWS CLI\)](#).

This section describes how to create an event source mapping using the Lambda console and the AWS CLI.

Prerequisites

- A self-managed Apache Kafka cluster. Lambda supports Apache Kafka version 0.10.1.0 and later.
- An [execution role](#) with permission to access the AWS resources that your self-managed Kafka cluster uses.

Customizable consumer group ID

When setting up Kafka as an event source, you can specify a consumer group ID. This consumer group ID is an existing identifier for the Kafka consumer group that you want your Lambda function to join. You can use this feature to seamlessly migrate any ongoing Kafka record processing setups from other consumers to Lambda.

If you specify a consumer group ID and there are other active pollers within that consumer group, Kafka distributes messages across all consumers. In other words, Lambda doesn't receive all message for the Kafka topic. If you want Lambda to handle all messages in the topic, turn off any other pollers in that consumer group.

Additionally, if you specify a consumer group ID, and Kafka finds a valid existing consumer group with the same ID, Lambda ignores the `StartingPosition` parameter for your event source mapping. Instead, Lambda begins processing records according to the committed offset of the consumer group. If you specify a consumer group ID, and Kafka cannot find an existing consumer group, then Lambda configures your event source with the specified `StartingPosition`.

The consumer group ID that you specify must be unique among all your Kafka event sources. After creating a Kafka event source mapping with the consumer group ID specified, you cannot update this value.

Adding a self-managed Kafka cluster (console)

Follow these steps to add your self-managed Apache Kafka cluster and a Kafka topic as a trigger for your Lambda function.

To add an Apache Kafka trigger to your Lambda function (console)

1. Open the [Functions page](#) of the Lambda console.
2. Choose the name of your Lambda function.
3. Under **Function overview**, choose **Add trigger**.
4. Under **Trigger configuration**, do the following:
 - a. Choose the **Apache Kafka** trigger type.
 - b. For **Bootstrap servers**, enter the host and port pair address of a Kafka broker in your cluster, and then choose **Add**. Repeat for each Kafka broker in the cluster.
 - c. For **Topic name**, enter the name of the Kafka topic used to store records in the cluster.
 - d. (Optional) For **Batch size**, enter the maximum number of records to receive in a single batch.
 - e. For **Batch window**, enter the maximum amount of seconds that Lambda spends gathering records before invoking the function.
 - f. (Optional) For **Consumer group ID**, enter the ID of a Kafka consumer group to join.

- g. (Optional) For **Starting position**, choose **Latest** to start reading the stream from the latest record, **Trim horizon** to start at the earliest available record, or **At timestamp** to specify a timestamp to start reading from.
- h. (Optional) For **VPC**, choose the Amazon VPC for your Kafka cluster. Then, choose the **VPC subnets** and **VPC security groups**.

This setting is required if only users within your VPC access your brokers.

- i. (Optional) For **Authentication**, choose **Add**, and then do the following:
 - i. Choose the access or authentication protocol of the Kafka brokers in your cluster.
 - If your Kafka broker uses SASL/PLAIN authentication, choose **BASIC_AUTH**.
 - If your broker uses SASL/SCRAM authentication, choose one of the **SASL_SCRAM** protocols.
 - If you're configuring mTLS authentication, choose the **CLIENT_CERTIFICATE_TLS_AUTH** protocol.
 - ii. For SASL/SCRAM or mTLS authentication, choose the Secrets Manager secret key that contains the credentials for your Kafka cluster.
- j. (Optional) For **Encryption**, choose the Secrets Manager secret containing the root CA certificate that your Kafka brokers use for TLS encryption, if your Kafka brokers use certificates signed by a private CA.

This setting applies to TLS encryption for SASL/SCRAM or SASL/PLAIN, and to mTLS authentication.

- k. To create the trigger in a disabled state for testing (recommended), clear **Enable trigger**. Or, to enable the trigger immediately, select **Enable trigger**.
5. To create the trigger, choose **Add**.

Adding a self-managed Kafka cluster (AWS CLI)

Use the following example AWS CLI commands to create and view a self-managed Apache Kafka trigger for your Lambda function.

Using SASL/SCRAM

If Kafka users access your Kafka brokers over the internet, specify the Secrets Manager secret that you created for SASL/SCRAM authentication. The following example uses the [create-event-source-](#)

[mapping](#) AWS CLI command to map a Lambda function named `my-kafka-function` to a Kafka topic named `AWSKafkaTopic`.

```
aws lambda create-event-source-mapping \
  --topics AWSKafkaTopic \
  --source-access-configuration Type=SASL_SCRAM_512_AUTH,URI=arn:aws:secretsmanager:us-east-1:111122223333:secret:MyBrokerSecretName \
  --function-name arn:aws:lambda:us-east-1:111122223333:function:my-kafka-function \
  --self-managed-event-source '{"Endpoints":{"KAFKA_BOOTSTRAP_SERVERS":  
["abc3.xyz.com:9092", "abc2.xyz.com:9092"]}}'
```

Using a VPC

If only Kafka users within your VPC access your Kafka brokers, you must specify your VPC, subnets, and VPC security group. The following example uses the [create-event-source-mapping](#) AWS CLI command to map a Lambda function named `my-kafka-function` to a Kafka topic named `AWSKafkaTopic`.

```
aws lambda create-event-source-mapping \
  --topics AWSKafkaTopic \
  --source-access-configuration '[{"Type": "VPC_SUBNET", "URI":  
"subnet:subnet-0011001100"}, {"Type": "VPC_SUBNET", "URI":  
"subnet:subnet-0022002200"}, {"Type": "VPC_SECURITY_GROUP", "URI":  
"security_group:sg-0123456789"}]' \
  --function-name arn:aws:lambda:us-east-1:111122223333:function:my-kafka-function \
  --self-managed-event-source '{"Endpoints":{"KAFKA_BOOTSTRAP_SERVERS":  
["abc3.xyz.com:9092", "abc2.xyz.com:9092"]}}'
```

Viewing the status using the AWS CLI

The following example uses the [get-event-source-mapping](#) AWS CLI command to describe the status of the event source mapping that you created.

```
aws lambda get-event-source-mapping
  --uuid dh38738e-992b-343a-1077-3478934hjkfd7
```

Self-managed Apache Kafka configuration parameters

All Lambda event source types share the same [CreateEventSourceMapping](#) and [UpdateEventSourceMapping](#) API operations. However, only some of the parameters apply to Apache Kafka.

Parameter	Required	Default	Notes
BatchSize	N	100	Maximum: 10,000
DestinationConfig	N	N/A	the section called "On-failure destinations"
Enabled	N	True	
FilterCriteria	N	N/A	Control which events Lambda sends to your function
FunctionName	Y	N/A	
KMSKeyArn	N	N/A	the section called "Encryption of filter criteria"
MaximumBatchingWindowInSeconds	N	500 ms	Batching behavior
ProvisionedPollersConfig	N	MinimumPollers : default value of 1 if not specified MaximumPollers : default value of 200 if not specified	the section called "Configuring provisioned mode"
SelfManagedEventSource	Y	N/A	List of Kafka Brokers. Can set only on Create
SelfManagedKafkaEventSourceConfig	N	Contains the ConsumerGroupId	Can set only on Create

Parameter	Required	Default	Notes
		field which defaults to a unique value.	
SourceAccessConfigurations	N	No credentials	VPC information or authentication credentials for the cluster For SASL_PLAIN, set to BASIC_AUTH
StartingPosition	Y	N/A	AT_TIMESTAMP, TRIM_HORIZON, or LATEST Can set only on Create
StartingPositionTimestamp	N	N/A	Required if StartingPosition is set to AT_TIMESTAMP
Tags	N	N/A	the section called "Event source mapping tags"
Topics	Y	N/A	Topic name Can set only on Create

Using a Kafka cluster as an event source

When you add your Apache Kafka or Amazon MSK cluster as a trigger for your Lambda function, the cluster is used as an [event source](#).

Lambda reads event data from the Kafka topics that you specify as `Topics` in a [CreateEventSourceMapping](#) request, based on the `StartingPosition` that you specify. After successful processing, your Kafka topic is committed to your Kafka cluster.

If you specify the `StartingPosition` as `LATEST`, Lambda starts reading from the latest message in each partition belonging to the topic. Because there can be some delay after trigger configuration before Lambda starts reading the messages, Lambda doesn't read any messages produced during this window.

Lambda processes records from one or more Kafka topic partitions that you specify and sends a JSON payload to your function. A single Lambda payload can contain messages from multiple partitions. When more records are available, Lambda continues processing records in batches, based on the `BatchSize` value that you specify in a [CreateEventSourceMapping](#) request, until your function catches up with the topic.

If your function returns an error for any of the messages in a batch, Lambda retries the whole batch of messages until processing succeeds or the messages expire. You can send records that fail all retry attempts to an [on-failure destination](#) for later processing.

Note

While Lambda functions typically have a maximum timeout limit of 15 minutes, event source mappings for Amazon MSK, self-managed Apache Kafka, Amazon DocumentDB, and Amazon MQ for ActiveMQ and RabbitMQ only support functions with maximum timeout limits of 14 minutes. This constraint ensures that the event source mapping can properly handle function errors and retries.

Polling and stream starting positions

Be aware that stream polling during event source mapping creation and updates is eventually consistent.

- During event source mapping creation, it may take several minutes to start polling events from the stream.
- During event source mapping updates, it may take several minutes to stop and restart polling events from the stream.

This behavior means that if you specify LATEST as the starting position for the stream, the event source mapping could miss events during creation or updates. To ensure that no events are missed, specify the stream starting position as TRIM_HORIZON or AT_TIMESTAMP.

Message throughput scaling behavior for self-managed Apache Kafka event source mappings

You can choose between two modes of message throughput scaling behavior for your Amazon MSK event source mapping:

- [the section called “Default \(on-demand\) mode”](#)
- [Provisioned mode](#)

Default (on-demand) mode

When you initially create a self-managed Apache Kafka event source, Lambda allocates a default number of event pollers to process all partitions in the Kafka topic. Lambda automatically scales up or down the number of event pollers based on message load.

In one-minute intervals, Lambda evaluates the consumer offset lag of all the partitions in the topic. If the offset lag is too high, the partition is receiving messages faster than Lambda can process them. If necessary, Lambda adds or removes event pollers from the topic. This autoscaling process of adding or removing event pollers occurs within three minutes of evaluation.

If your target Lambda function is throttled, Lambda reduces the number of event pollers. This action reduces the workload on the function by reducing the number of messages that event pollers can retrieve and send to the function.

To monitor the throughput of your Kafka topic, you can view the Apache Kafka consumer metrics, such as `consumer_lag` and `consumer_offset`.

Configuring provisioned mode

For workloads where you need to fine-tune the throughput of your event source mapping, you can use provisioned mode. In provisioned mode, you define minimum and maximum limits for the amount of provisioned event pollers. These provisioned event pollers are dedicated to your event source mapping, and can handle unexpected message spikes instantly when they occur. We recommend that you use provisioned mode for Kafka workloads that have strict performance requirements.

In Lambda, an event poller is a compute unit capable of handling up to 5 MBps of throughput. For reference, suppose your event source produces an average payload of 1MB, and the average function duration is 1 sec. If the payload doesn't undergo any transformation (such as filtering), a single poller can support 5 MBps throughput, and 5 concurrent Lambda invocations. Using provisioned mode incurs additional costs. For pricing estimates, see [AWS Lambda pricing](#).

In provisioned mode, the range of accepted values for the minimum number of event pollers (`MinimumPollers`) is between 1 and 200, inclusive. The range of accepted values for the maximum number of event pollers (`MaximumPollers`) is between 1 and 2,000, inclusive. `MaximumPollers` must be greater than or equal to `MinimumPollers`. In addition, to maintain ordered processing within partitions, Lambda caps the `MaximumPollers` to the number of partitions in the topic.

For more details about choosing appropriate values for minimum and maximum event pollers, see [the section called "Best practices and considerations when using provisioned mode"](#).

You can configure provisioned mode for your self-managed Apache Kafka event source mapping using the console or the Lambda API.

To configure provisioned mode for an existing self-managed Apache Kafka event source mapping (console)

1. Open the [Functions page](#) of the Lambda console.
2. Choose the function with the self-managed Apache Kafka event source mapping you want to configure provisioned mode for.
3. Choose **Configuration**, then choose **Triggers**.
4. Choose the self-managed Apache Kafka event source mapping that you want to configure provisioned mode for, then choose **Edit**.
5. Under **Event source mapping configuration**, choose **Configure provisioned mode**.
 - For **Minimum event pollers**, enter a value between 1 and 200. If you don't specify a value, Lambda chooses a default value of 1.
 - For **Maximum event pollers**, enter a value between 1 and 2,000. This value must be greater than or equal to your value for **Minimum event pollers**. If you don't specify a value, Lambda chooses a default value of 200.
6. Choose **Save**.

You can configure provisioned mode programmatically using the [ProvisionedPollerConfig](#) object in your [EventSourceMappingConfiguration](#). For example, the following [UpdateEventSourceMapping](#) CLI command configures a `MinimumPollers` value of 5, and a `MaximumPollers` value of 100.

```
aws lambda update-event-source-mapping \  
  --uuid a1b2c3d4-5678-90ab-cdef-EXAMPLE11111 \  
  --provisioned-poller-config '{"MinimumPollers": 5, "MaximumPollers": 100}'
```

After configuring provisioned mode, you can observe the usage of event pollers for your workload by monitoring the `ProvisionedPollers` metric. For more information, see [the section called “Event source mapping metrics”](#).

To disable provisioned mode and return to default (on-demand) mode, you can use the following [UpdateEventSourceMapping](#) CLI command:

```
aws lambda update-event-source-mapping \  
  --uuid a1b2c3d4-5678-90ab-cdef-EXAMPLE11111 \  
  --provisioned-poller-config '{}'
```

Best practices and considerations when using provisioned mode

The optimal configuration of minimum and maximum event pollers for your event source mapping depends on your application's performance requirements. We recommend that you start with the default minimum event pollers to baseline the performance profile. Adjust your configuration based on observed message processing patterns and your desired performance profile.

For workloads with spiky traffic and strict performance needs, increase the minimum event pollers to handle sudden surges in messages. To determine the minimum event pollers required, consider your workload's messages per second and average payload size, and use the throughput capacity of a single event poller (up to 5 MBps) as a reference.

To maintain ordered processing within a partition, Lambda limits the maximum event pollers to the number of partitions in the topic. Additionally, the maximum event pollers your event source mapping can scale to depends on the function's concurrency settings.

When activating provisioned mode, update your network settings to remove AWS PrivateLink VPC endpoints and associated permissions.

Amazon CloudWatch metrics

Lambda emits the `OffsetLag` metric while your function processes records. The value of this metric is the difference in offset between the last record written to the Kafka event source topic and the last record that your function's consumer group processed. You can use `OffsetLag` to estimate the latency between when a record is added and when your consumer group processes it.

An increasing trend in `OffsetLag` can indicate issues with pollers in your function's consumer group. For more information, see [Using CloudWatch metrics with Lambda](#).

Using event filtering with a self-managed Apache Kafka event source

You can use event filtering to control which records from a stream or queue Lambda sends to your function. For general information about how event filtering works, see [the section called "Event filtering"](#).

This section focuses on event filtering for self-managed Apache Kafka event sources.

Topics

- [Self-managed Apache Kafka event filtering basics](#)

Self-managed Apache Kafka event filtering basics

Suppose a producer is writing messages to a topic in your self-managed Apache Kafka cluster, either in valid JSON format or as plain strings. An example record would look like the following, with the message converted to a Base64 encoded string in the `value` field.

```
{
  "mytopic-0": [
    {
      "topic": "mytopic",
      "partition": 0,
      "offset": 15,
      "timestamp": 1545084650987,
      "timestampType": "CREATE_TIME",
      "value": "SGVsbG8sIHRoaXMgaXMgYSB0ZXN0Lg==",
      "headers": []
    }
  ]
}
```

```
}

```

Suppose your Apache Kafka producer is writing messages to your topic in the following JSON format.

```
{
  "device_ID": "AB1234",
  "session":{
    "start_time": "yyyy-mm-ddThh:mm:ss",
    "duration": 162
  }
}
```

You can use the value key to filter records. Suppose you wanted to filter only those records where device_ID begins with the letters AB. The `FilterCriteria` object would be as follows.

```
{
  "Filters": [
    {
      "Pattern": "{ \"value\" : { \"device_ID\" : [ { \"prefix\": \"AB\" } ] } }"
    }
  ]
}
```

For added clarity, here is the value of the filter's `Pattern` expanded in plain JSON.

```
{
  "value": {
    "device_ID": [ { "prefix": "AB" } ]
  }
}
```

You can add your filter using the console, AWS CLI or an AWS SAM template.

Console

To add this filter using the console, follow the instructions in [Attaching filter criteria to an event source mapping \(console\)](#) and enter the following string for the **Filter criteria**.

```
{ "value" : { "device_ID" : [ { "prefix": "AB" } ] } }
```

AWS CLI

To create a new event source mapping with these filter criteria using the AWS Command Line Interface (AWS CLI), run the following command.

```
aws lambda create-event-source-mapping \
  --function-name my-function \
  --event-source-arn arn:aws:kafka:us-east-2:123456789012:cluster/my-cluster/  
b-8ac7cc01-5898-482d-be2f-a6b596050ea8 \
  --filter-criteria '{"Filters": [{"Pattern": "{ \"value\" : { \"device_ID\" :  
[ { \"prefix\": \"AB\" } ] } }"]}'
```

To add these filter criteria to an existing event source mapping, run the following command.

```
aws lambda update-event-source-mapping \
  --uuid "a1b2c3d4-5678-90ab-cdef-1111EXAMPLE" \
  --filter-criteria '{"Filters": [{"Pattern": "{ \"value\" : { \"device_ID\" :  
[ { \"prefix\": \"AB\" } ] } }"]}'
```

AWS SAM

To add this filter using AWS SAM, add the following snippet to the YAML template for your event source.

```
FilterCriteria:
  Filters:
    - Pattern: '{ "value" : { "device_ID" : [ { "prefix": "AB" } ] } }'
```

With self-managed Apache Kafka, you can also filter records where the message is a plain string. Suppose you want to ignore those messages where the string is "error". The `FilterCriteria` object would look as follows.

```
{
  "Filters": [
    {
      "Pattern": "{ \"value\" : [ { \"anything-but\": [ \"error\" ] } ] }"
    }
  ]
}
```

For added clarity, here is the value of the filter's `Pattern` expanded in plain JSON.

```
{
  "value": [
    {
      "anything-but": [ "error" ]
    }
  ]
}
```

You can add your filter using the console, AWS CLI or an AWS SAM template.

Console

To add this filter using the console, follow the instructions in [Attaching filter criteria to an event source mapping \(console\)](#) and enter the following string for the **Filter criteria**.

```
{ "value" : [ { "anything-but": [ "error" ] } ] }
```

AWS CLI

To create a new event source mapping with these filter criteria using the AWS Command Line Interface (AWS CLI), run the following command.

```
aws lambda create-event-source-mapping \
  --function-name my-function \
  --event-source-arn arn:aws:kafka:us-east-2:123456789012:cluster/my-cluster/  
b-8ac7cc01-5898-482d-be2f-a6b596050ea8 \
  --filter-criteria '{"Filters": [{"Pattern": "{ \"value\" : [ { \"anything-but\":  
[ \"error\" ] } ] }"]}'
```

To add these filter criteria to an existing event source mapping, run the following command.

```
aws lambda update-event-source-mapping \
  --uuid "a1b2c3d4-5678-90ab-cdef-11111EXAMPLE" \
  --filter-criteria '{"Filters": [{"Pattern": "{ \"value\" : [ { \"anything-but\":  
[ \"error\" ] } ] }"]}'
```

AWS SAM

To add this filter using AWS SAM, add the following snippet to the YAML template for your event source.

```
FilterCriteria:
  Filters:
    - Pattern: '{ "value" : [ { "anything-but": [ "error" ] } ] }'
```

Self-managed Apache Kafka messages must be UTF-8 encoded strings, either plain strings or in JSON format. That's because Lambda decodes Kafka byte arrays into UTF-8 before applying filter criteria. If your messages use another encoding, such as UTF-16 or ASCII, or if the message format doesn't match the `FilterCriteria` format, Lambda processes metadata filters only. The following table summarizes the specific behavior:

Incoming message format	Filter pattern format for message properties	Resulting action
Plain string	Plain string	Lambda filters based on your filter criteria.
Plain string	No filter pattern for data properties	Lambda filters (on the other metadata properties only) based on your filter criteria.
Plain string	Valid JSON	Lambda filters (on the other metadata properties only) based on your filter criteria.
Valid JSON	Plain string	Lambda filters (on the other metadata properties only) based on your filter criteria.
Valid JSON	No filter pattern for data properties	Lambda filters (on the other metadata properties only) based on your filter criteria.
Valid JSON	Valid JSON	Lambda filters based on your filter criteria.

Incoming message format	Filter pattern format for message properties	Resulting action
Non-UTF-8 encoded string	JSON, plain string, or no pattern	Lambda filters (on the other metadata properties only) based on your filter criteria.

Capturing discarded batches for a self-managed Apache Kafka event source

To retain records of failed event source mapping invocations, add a destination to your function's event source mapping. Each record sent to the destination is a JSON document containing metadata about the failed invocation. For Amazon S3 destinations, Lambda also sends the entire invocation record along with the metadata. You can configure any Amazon SNS topic, Amazon SQS queue, or S3 bucket as a destination.

With Amazon S3 destinations, you can use the [Amazon S3 Event Notifications](#) feature to receive notifications when objects are uploaded to your destination S3 bucket. You can also configure S3 Event Notifications to invoke another Lambda function to perform automated processing on failed batches.

Your execution role must have permissions for the destination:

- **For SQS destinations:** [sqs:SendMessage](#)
- **For SNS destinations:** [sns:Publish](#)
- **For S3 bucket destinations:** [s3:PutObject](#) and [s3:ListBucket](#)

You must deploy a VPC endpoint for your on-failure destination service inside your Apache Kafka cluster VPC.

Additionally, if you configured a KMS key on your destination, Lambda needs the following permissions depending on the destination type:

- If you've enabled encryption with your own KMS key for an S3 destination, [kms:GenerateDataKey](#) is required. If the KMS key and S3 bucket destination are in a different account from your Lambda function and execution role, configure the KMS key to trust the execution role to allow `kms:GenerateDataKey`.

- If you've enabled encryption with your own KMS key for SQS destination, [kms:Decrypt](#) and [kms:GenerateDataKey](#) are required. If the KMS key and SQS queue destination are in a different account from your Lambda function and execution role, configure the KMS key to trust the execution role to allow `kms:Decrypt`, `kms:GenerateDataKey`, [kms:DescribeKey](#), and [kms:ReEncrypt](#).
- If you've enabled encryption with your own KMS key for SNS destination, [kms:Decrypt](#) and [kms:GenerateDataKey](#) are required. If the KMS key and SNS topic destination are in a different account from your Lambda function and execution role, configure the KMS key to trust the execution role to allow `kms:Decrypt`, `kms:GenerateDataKey`, [kms:DescribeKey](#), and [kms:ReEncrypt](#).

Configuring on-failure destinations for an self-managed Apache Kafka event source mapping

To configure an on-failure destination using the console, follow these steps:

1. Open the [Functions page](#) of the Lambda console.
2. Choose a function.
3. Under **Function overview**, choose **Add destination**.
4. For **Source**, choose **Event source mapping invocation**.
5. For **Event source mapping**, choose an event source that's configured for this function.
6. For **Condition**, select **On failure**. For event source mapping invocations, this is the only accepted condition.
7. For **Destination type**, choose the destination type that Lambda sends invocation records to.
8. For **Destination**, choose a resource.
9. Choose **Save**.

You can also configure an on-failure destination using the AWS CLI. For example, the following [create-event-source-mapping](#) command adds an event source mapping with an SQS on-failure destination to `MyFunction`:

```
aws lambda create-event-source-mapping \  
--function-name "MyFunction" \  
--event-source-arn arn:aws:kafka:us-east-1:123456789012:cluster/  
vpc-2priv-2pub/751d2973-a626-431c-9d4e-d7975eb44dd7-2 \  

```



```
--destination-config '{"OnFailure": {"Destination": "arn:aws:sqs:us-east-1:123456789012:dest-queue"}}'
```

The following [update-event-source-mapping](#) command adds an S3 on-failure destination to the event source associated with the input uuid:

```
aws lambda update-event-source-mapping \  
--uuid f89f8514-cdd9-4602-9e1f-01a5b77d449b \  
--destination-config '{"OnFailure": {"Destination": "arn:aws:s3:::dest-bucket"}}'
```

To remove a destination, supply an empty string as the argument to the `destination-config` parameter:

```
aws lambda update-event-source-mapping \  
--uuid f89f8514-cdd9-4602-9e1f-01a5b77d449b \  
--destination-config '{"OnFailure": {"Destination": ""}}'
```

Security best practices for Amazon S3 destinations

Deleting an S3 bucket that's configured as a destination without removing the destination from your function's configuration can create a security risk. If another user knows your destination bucket's name, they can recreate the bucket in their AWS account. Records of failed invocations will be sent to their bucket, potentially exposing data from your function.

Warning

To ensure that invocation records from your function can't be sent to an S3 bucket in another AWS account, add a condition to your function's execution role that limits `s3:PutObject` permissions to buckets in your account.

The following example shows an IAM policy that limits your function's `s3:PutObject` permissions to buckets in your account. This policy also gives Lambda the `s3:ListBucket` permission it needs to use an S3 bucket as a destination.

```
{  
  "Version": "2012-10-17",  
  "Statement": [  
    {  
      "Action": "s3:PutObject",  
      "Effect": "Deny",  
      "Resource": "arn:aws:s3:::*",  
      "Condition": {"StringNotEquals": {"aws:PrincipalOrgID": "o-123456789012"}},  
      "Sid": "DenyPutObjectToOtherAccounts"  
    },  
    {  
      "Action": "s3:ListBucket",  
      "Effect": "Allow",  
      "Resource": "arn:aws:s3:::*",  
      "Condition": {"StringEquals": {"aws:PrincipalOrgID": "o-123456789012"}},  
      "Sid": "AllowListBucketToOwnAccount"  
    }  
  ]  
}
```

```
{
  "Sid": "S3BucketResourceAccountWrite",
  "Effect": "Allow",
  "Action": [
    "s3:PutObject",
    "s3:ListBucket"
  ],
  "Resource": "arn:aws:s3:::*/**",
  "Condition": {
    "StringEquals": {
      "s3:ResourceAccount": "111122223333"
    }
  }
}
```

To add a permissions policy to your function's execution role using the AWS Management Console or AWS CLI, refer to the instructions in the following procedures:

Console

To add a permissions policy to a function's execution role (console)

1. Open the [Functions page](#) of the Lambda console.
2. Select the Lambda function whose execution role you want to modify.
3. In the **Configuration** tab, select **Permissions**.
4. In the **Execution role** tab, select your function's **Role name** to open the role's IAM console page.
5. Add a permissions policy to the role by doing the following:
 - a. In the **Permissions policies** pane, choose **Add permissions** and select **Create inline policy**.
 - b. In **Policy editor**, select **JSON**.
 - c. Paste the policy you want to add into the editor (replacing the existing JSON), and then choose **Next**.
 - d. Under **Policy details**, enter a **Policy name**.
 - e. Choose **Create policy**.

AWS CLI

To add a permissions policy to a function's execution role (CLI)

1. Create a JSON policy document with the required permissions and save it in a local directory.
2. Use the IAM `put-role-policy` CLI command to add the permissions to your function's execution role. Run the following command from the directory you saved your JSON policy document in and replace the role name, policy name, and policy document with your own values.

```
aws iam put-role-policy \  
--role-name my_lambda_role \  
--policy-name LambdaS3DestinationPolicy \  
--policy-document file://my_policy.json
```

SNS and SQS example invocation record

The following example shows what Lambda sends to an SNS topic or SQS queue destination for a failed Kafka event source invocation. Each of the keys under `recordsInfo` contains both the Kafka topic and partition, separated by a hyphen. For example, for the key `"Topic-0"`, `Topic` is the Kafka topic, and `0` is the partition. For each topic and partition, you can use the offsets and timestamp data to find the original invocation records.

```
{  
  "requestContext": {  
    "requestId": "316aa6d0-8154-xmpl-9af7-85d5f4a6bc81",  
    "functionArn": "arn:aws:lambda:us-east-1:123456789012:function:myfunction",  
    "condition": "RetryAttemptsExhausted" | "MaximumPayloadSizeExceeded",  
    "approximateInvokeCount": 1  
  },  
  "responseContext": { // null if record is MaximumPayloadSizeExceeded  
    "statusCode": 200,  
    "executedVersion": "$LATEST",  
    "functionError": "Unhandled"  
  },  
  "version": "1.0",  
  "timestamp": "2019-11-14T00:38:06.021Z",  
  "KafkaBatchInfo": {  
    "batchSize": 500,  

```

```

    "eventSourceArn": "arn:aws:kafka:us-east-1:123456789012:cluster/
vpc-2priv-2pub/751d2973-a626-431c-9d4e-d7975eb44dd7-2",
    "bootstrapServers": "...",
    "payloadSize": 2039086, // In bytes
    "recordsInfo": {
      "Topic-0": {
        "firstRecordOffset":
"49601189658422359378836298521827638475320189012309704722",
        "lastRecordOffset":
"49601189658422359378836298522902373528957594348623495186",
        "firstRecordTimestamp": "2019-11-14T00:38:04.835Z",
        "lastRecordTimestamp": "2019-11-14T00:38:05.580Z",
      },
      "Topic-1": {
        "firstRecordOffset":
"49601189658422359378836298521827638475320189012309704722",
        "lastRecordOffset":
"49601189658422359378836298522902373528957594348623495186",
        "firstRecordTimestamp": "2019-11-14T00:38:04.835Z",
        "lastRecordTimestamp": "2019-11-14T00:38:05.580Z",
      }
    }
  }
}

```

S3 destination example invocation record

For S3 destinations, Lambda sends the entire invocation record along with the metadata to the destination. The following example shows that Lambda sends to an S3 bucket destination for a failed Kafka event source invocation. In addition to all of the fields from the previous example for SQS and SNS destinations, the `payload` field contains the original invocation record as an escaped JSON string.

```

{
  "requestContext": {
    "requestId": "316aa6d0-8154-xmpl-9af7-85d5f4a6bc81",
    "functionArn": "arn:aws:lambda:us-east-1:123456789012:function:myfunction",
    "condition": "RetryAttemptsExhausted | MaximumPayloadSizeExceeded",
    "approximateInvokeCount": 1
  },
  "responseContext": { // null if record is MaximumPayloadSizeExceeded
    "statusCode": 200,
    "executedVersion": "$LATEST",

```

```

    "functionError": "Unhandled"
  },
  "version": "1.0",
  "timestamp": "2019-11-14T00:38:06.021Z",
  "KafkaBatchInfo": {
    "batchSize": 500,
    "eventSourceArn": "arn:aws:kafka:us-east-1:123456789012:cluster/
vpc-2priv-2pub/751d2973-a626-431c-9d4e-d7975eb44dd7-2",
    "bootstrapServers": "...",
    "payloadSize": 2039086, // In bytes
    "recordsInfo": {
      "Topic-0": {
        "firstRecordOffset":
"49601189658422359378836298521827638475320189012309704722",
        "lastRecordOffset":
"49601189658422359378836298522902373528957594348623495186",
        "firstRecordTimestamp": "2019-11-14T00:38:04.835Z",
        "lastRecordTimestamp": "2019-11-14T00:38:05.580Z",
      },
      "Topic-1": {
        "firstRecordOffset":
"49601189658422359378836298521827638475320189012309704722",
        "lastRecordOffset":
"49601189658422359378836298522902373528957594348623495186",
        "firstRecordTimestamp": "2019-11-14T00:38:04.835Z",
        "lastRecordTimestamp": "2019-11-14T00:38:05.580Z",
      }
    }
  },
  "payload": "<Whole Event>" // Only available in S3
}

```

 **Tip**

We recommend enabling S3 versioning on your destination bucket.

Troubleshooting self-managed Apache Kafka event source mapping errors

The following topics provide troubleshooting advice for errors and issues that you might encounter when using self-managed Apache Kafka with Lambda. If you find an issue that is not listed here, you can use the **Feedback** button on this page to report it.

For more help with troubleshooting, visit the [AWS Knowledge Center](#).

Authentication and authorization errors

If any of the permissions required to consume data from the Kafka cluster are missing, Lambda displays one of the following error messages in the event source mapping under **LastProcessingResult**.

Error messages

- [Cluster failed to authorize Lambda](#)
- [SASL authentication failed](#)
- [Server failed to authenticate Lambda](#)
- [Lambda failed to authenticate server](#)
- [Provided certificate or private key is invalid](#)

Cluster failed to authorize Lambda

For SASL/SCRAM or mTLS, this error indicates that the provided user doesn't have all of the following required Kafka access control list (ACL) permissions:

- DescribeConfigs Cluster
- Describe Group
- Read Group
- Describe Topic
- Read Topic

When you create Kafka ACLs with the required `kafka-cluster` permissions, specify the topic and group as resources. The topic name must match the topic in the event source mapping. The group name must match the event source mapping's UUID.

After you add the required permissions to the execution role, it might take several minutes for the changes to take effect.

SASL authentication failed

For SASL/SCRAM or SASL/PLAIN, this error indicates that the provided sign-in credentials aren't valid.

Server failed to authenticate Lambda

This error indicates that the Kafka broker failed to authenticate Lambda. This can occur for any of the following reasons:

- You didn't provide a client certificate for mTLS authentication.
- You provided a client certificate, but the Kafka brokers aren't configured to use mTLS authentication.
- A client certificate isn't trusted by the Kafka brokers.

Lambda failed to authenticate server

This error indicates that Lambda failed to authenticate the Kafka broker. This can occur for any of the following reasons:

- The Kafka brokers use self-signed certificates or a private CA, but didn't provide the server root CA certificate.
- The server root CA certificate doesn't match the root CA that signed the broker's certificate.
- Hostname validation failed because the broker's certificate doesn't contain the broker's DNS name or IP address as a subject alternative name.

Provided certificate or private key is invalid

This error indicates that the Kafka consumer couldn't use the provided certificate or private key. Make sure that the certificate and key use PEM format, and that the private key encryption uses a PBES1 algorithm.

Event source mapping errors

When you add your Apache Kafka cluster as an [event source](#) for your Lambda function, if your function encounters an error, your Kafka consumer stops processing records. Consumers of a topic

partition are those that subscribe to, read, and process your records. Your other Kafka consumers can continue processing records, provided they don't encounter the same error.

To determine the cause of a stopped consumer, check the `StateTransitionReason` field in the response of `EventSourceMapping`. The following list describes the event source errors that you can receive:

ESM_CONFIG_NOT_VALID

The event source mapping configuration isn't valid.

EVENT_SOURCE_AUTHN_ERROR

Lambda couldn't authenticate the event source.

EVENT_SOURCE_AUTHZ_ERROR

Lambda doesn't have the required permissions to access the event source.

FUNCTION_CONFIG_NOT_VALID

The function configuration isn't valid.

Note

If your Lambda event records exceed the allowed size limit of 6 MB, they can go unprocessed.

Invoking a Lambda function using an Amazon API Gateway endpoint

You can create a web API with an HTTP endpoint for your Lambda function by using Amazon API Gateway. API Gateway provides tools for creating and documenting web APIs that route HTTP requests to Lambda functions. You can secure access to your API with authentication and authorization controls. Your APIs can serve traffic over the internet or can be accessible only within your VPC.

Tip

Lambda offers two ways to invoke your function through an HTTP endpoint: API Gateway and Lambda function URLs. If you're not sure which is the best method for your use case, see [the section called "API Gateway vs function URLs"](#).

Resources in your API define one or more methods, such as GET or POST. Methods have an integration that routes requests to a Lambda function or another integration type. You can define each resource and method individually, or use special resource and method types to match all requests that fit a pattern. A [proxy resource](#) catches all paths beneath a resource. The ANY method catches all HTTP methods.

Sections

- [Choosing an API type](#)
- [Adding an endpoint to your Lambda function](#)
- [Proxy integration](#)
- [Event format](#)
- [Response format](#)
- [Permissions](#)
- [Sample application](#)
- [Tutorial: Using Lambda with API Gateway](#)
- [Handling Lambda errors with an API Gateway API](#)
- [Select a method to invoke your Lambda function using an HTTP request](#)

Choosing an API type

API Gateway supports three types of APIs that invoke Lambda functions:

- [HTTP API](#): A lightweight, low-latency RESTful API.
- [REST API](#): A customizable, feature-rich RESTful API.
- [WebSocket API](#): A web API that maintains persistent connections with clients for full-duplex communication.

HTTP APIs and REST APIs are both RESTful APIs that process HTTP requests and return responses. HTTP APIs are newer and are built with the API Gateway version 2 API. The following features are new for HTTP APIs:

HTTP API features

- **Automatic deployments** – When you modify routes or integrations, changes deploy automatically to stages that have automatic deployment enabled.
- **Default stage** – You can create a default stage (`$default`) to serve requests at the root path of your API's URL. For named stages, you must include the stage name at the beginning of the path.
- **CORS configuration** – You can configure your API to add CORS headers to outgoing responses, instead of adding them manually in your function code.

REST APIs are the classic RESTful APIs that API Gateway has supported since launch. REST APIs currently have more customization, integration, and management features.

REST API features

- **Integration types** – REST APIs support custom Lambda integrations. With a custom integration, you can send just the body of the request to the function, or apply a transform template to the request body before sending it to the function.
- **Access control** – REST APIs support more options for authentication and authorization.
- **Monitoring and tracing** – REST APIs support AWS X-Ray tracing and additional logging options.

For a detailed comparison, see [Choose between HTTP APIs and REST APIs](#) in the *API Gateway Developer Guide*.

WebSocket APIs also use the API Gateway version 2 API and support a similar feature set. Use a WebSocket API for applications that benefit from a persistent connection between the client and API. WebSocket APIs provide full-duplex communication, which means that both the client and the API can send messages continuously without waiting for a response.

HTTP APIs support a simplified event format (version 2.0). For an example of an event from an HTTP API, see [Create AWS Lambda proxy integrations for HTTP APIs in API Gateway](#).

For more information, see [Create AWS Lambda proxy integrations for HTTP APIs in API Gateway](#).

Adding an endpoint to your Lambda function

To add a public endpoint to your Lambda function

1. Open the [Functions page](#) of the Lambda console.
2. Choose a function.
3. Under **Function overview**, choose **Add trigger**.
4. Select **API Gateway**.
5. Choose **Create an API** or **Use an existing API**.
 - a. **New API:** For **API type**, choose **HTTP API**. For more information, see [Choosing an API type](#).
 - b. **Existing API:** Select the API from the dropdown list or enter the API ID (for example, r3pmxmplak).
6. For **Security**, choose **Open**.
7. Choose **Add**.

Proxy integration

API Gateway APIs are comprised of stages, resources, methods, and integrations. The stage and resource determine the path of the endpoint:

API path format

- /prod/ – The prod stage and root resource.
- /prod/user – The prod stage and user resource.

- `/dev/{proxy+}` – Any route in the dev stage.
- `/` – (HTTP APIs) The default stage and root resource.

A Lambda integration maps a path and HTTP method combination to a Lambda function. You can configure API Gateway to pass the body of the HTTP request as-is (custom integration), or to encapsulate the request body in a document that includes all of the request information including headers, resource, path, and method.

For more information, see [Lambda proxy integrations in API Gateway](#).

Event format

Amazon API Gateway invokes your function [synchronously](#) with an event that contains a JSON representation of the HTTP request. For a custom integration, the event is the body of the request. For a proxy integration, the event has a defined structure. For an example of a proxy event from an API Gateway REST API, see [Input format of a Lambda function for proxy integration](#) in the *API Gateway Developer Guide*.

Response format

API Gateway waits for a response from your function and relays the result to the caller. For a custom integration, you define an integration response and a method response to convert the output from the function to an HTTP response. For a proxy integration, the function must respond with a representation of the response in a specific format.

The following example shows a response object from a Node.js function. The response object represents a successful HTTP response that contains a JSON document.

Example `index.mjs` – Proxy integration response object (Node.js)

```
var response = {
  "statusCode": 200,
  "headers": {
    "Content-Type": "application/json"
  },
  "isBase64Encoded": false,
  "multiValueHeaders": {
    "X-Custom-Header": ["My value", "My other value"],
  },
}
```

```
"body": "{\n  \"TotalCodeSize\": 104330022,\n  \"FunctionCount\": 26\n}"
```

The Lambda runtime serializes the response object into JSON and sends it to the API. The API parses the response and uses it to create an HTTP response, which it then sends to the client that made the original request.

Example HTTP response

```
< HTTP/1.1 200 OK
< Content-Type: application/json
< Content-Length: 55
< Connection: keep-alive
< x-amzn-RequestId: 32998fea-xmpl-4268-8c72-16138d629356
< X-Custom-Header: My value
< X-Custom-Header: My other value
< X-Amzn-Trace-Id: Root=1-5e6aa925-ccecxmplbae116148e52f036
<
{
  "TotalCodeSize": 104330022,
  "FunctionCount": 26
}
```

Permissions

Amazon API Gateway gets permission to invoke your function from the function's [resource-based policy](#). You can grant invoke permission to an entire API, or grant limited access to a stage, resource, or method.

When you add an API to your function by using the Lambda console, using the API Gateway console, or in an AWS SAM template, the function's resource-based policy is updated automatically. The following is an example function policy.

Example function policy

```
{
  "Version": "2012-10-17",
  "Id": "default",
  "Statement": [
    {
```

```

    "Sid": "nodejs-apig-functiongetEndpointPermissionProd-BWDBXMPLXE2F",
    "Effect": "Allow",
    "Principal": {
      "Service": "apigateway.amazonaws.com"
    },
    "Action": "lambda:InvokeFunction",
    "Resource": "arn:aws:lambda:us-east-2:111122223333:function:nodejs-apig-
function-1G3MXMPLXVXYI",
    "Condition": {
      "StringEquals": {
        "aws:SourceAccount": "111122223333"
      },
      "ArnLike": {
        "aws:SourceArn": "arn:aws:execute-api:us-east-2:111122223333:ktyvxmls1/*/"
GET/"
      }
    }
  }
]
}

```

You can manage function policy permissions manually with the following API operations:

- [AddPermission](#)
- [RemovePermission](#)
- [GetPolicy](#)

To grant invocation permission to an existing API, use the `add-permission` command. Example:

```

aws lambda add-permission \
  --function-name my-function \
  --statement-id apigateway-get --action lambda:InvokeFunction \
  --principal apigateway.amazonaws.com \
  --source-arn "arn:aws:execute-api:us-east-2:123456789012:mnh1xmpli7/default/GET/"

```

You should see the following output:

```

{
  "Statement": "{\"Sid\":\"apigateway-test-2\",\"Effect\":\"Allow\",\"Principal\
\":{\
\"Service\": \"apigateway.amazonaws.com\"},\
\"Action\": \"lambda:InvokeFunction\
\", \"Resource\": \"arn:aws:lambda:us-east-2:123456789012:function:my-function

```

```
\",\"Condition\":{\"ArnLike\":{\"AWS:SourceArn\":\"arn:aws:execute-api:us-east-2:123456789012:mnh1xmpli7/default/GET\"}}}
```

Note

If your function and API are in different AWS Regions, the Region identifier in the source ARN must match the Region of the function, not the Region of the API. When API Gateway invokes a function, it uses a resource ARN that is based on the ARN of the API, but modified to match the function's Region.

The source ARN in this example grants permission to an integration on the GET method of the root resource in the default stage of an API, with ID `mnh1xmpli7`. You can use an asterisk in the source ARN to grant permissions to multiple stages, methods, or resources.

Resource patterns

- `mnh1xmpli7/*/GET/*` – GET method on all resources in all stages.
- `mnh1xmpli7/prod/ANY/user` – ANY method on the `user` resource in the `prod` stage.
- `mnh1xmpli7/*/*/*` – Any method on all resources in all stages.

For details on viewing the policy and removing statements, see [Viewing resource-based IAM policies in Lambda](#).

Sample application

The [API Gateway with Node.js](#) sample app includes a function with an AWS SAM template that creates a REST API that has AWS X-Ray tracing enabled. It also includes scripts for deploying, invoking the function, testing the API, and cleanup.

Tutorial: Using Lambda with API Gateway

In this tutorial, you create a REST API through which you invoke a Lambda function using an HTTP request. Your Lambda function will perform create, read, update, and delete (CRUD) operations on a DynamoDB table. This function is provided here for demonstration, but you will learn to configure an API Gateway REST API that can invoke any Lambda function.

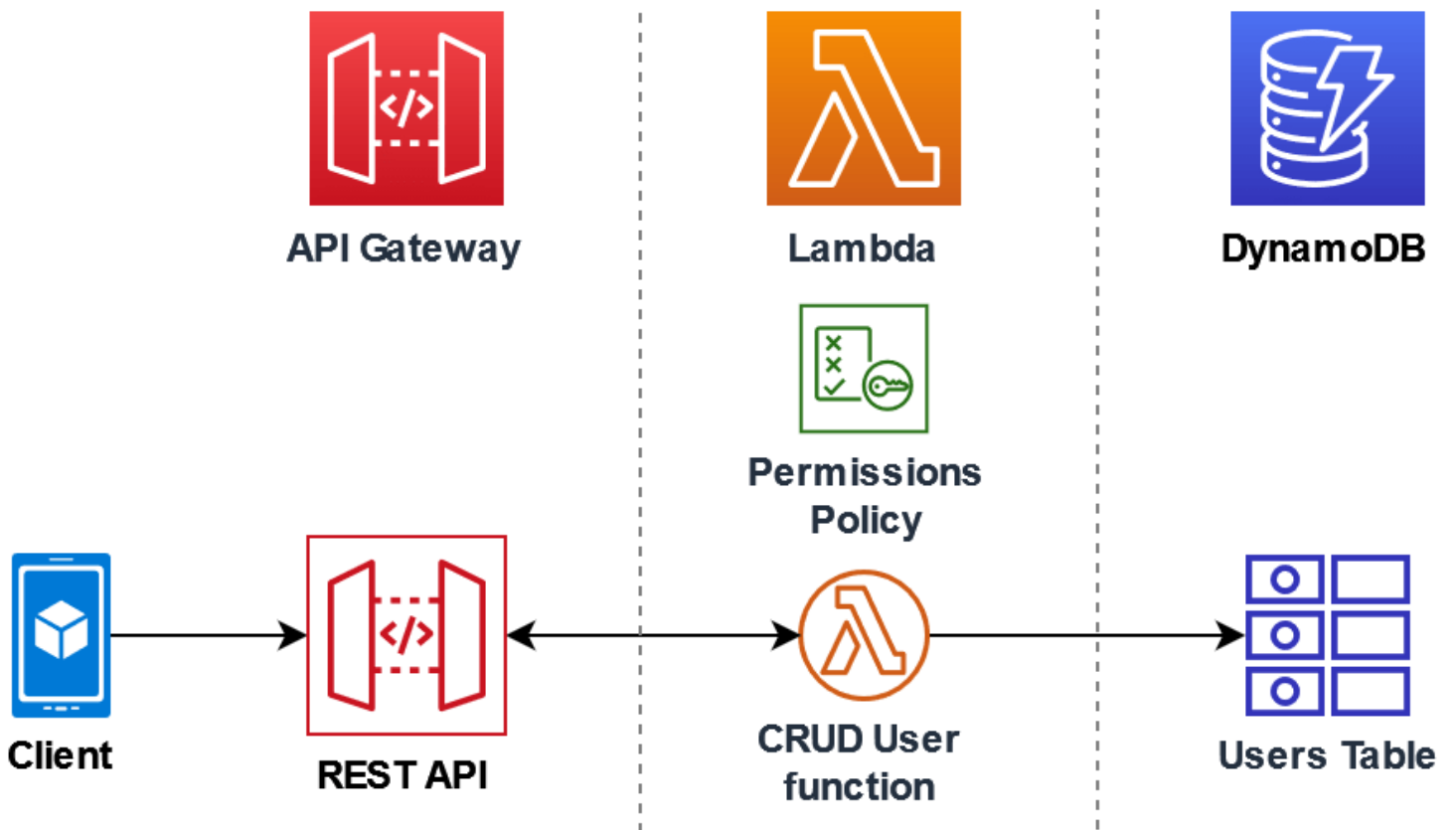

Using API Gateway provides users with a secure HTTP endpoint to invoke your Lambda function and can help manage large volumes of calls to your function by throttling traffic and automatically validating and authorizing API calls. API Gateway also provides flexible security controls using AWS Identity and Access Management (IAM) and Amazon Cognito. This is useful for use cases where advance authorization is required for calls to your application.

Tip

Lambda offers two ways to invoke your function through an HTTP endpoint: API Gateway and Lambda function URLs. If you're not sure which is the best method for your use case, see [the section called "API Gateway vs function URLs"](#).

To complete this tutorial, you will go through the following stages:

1. Create and configure a Lambda function in Python or Node.js to perform operations on a DynamoDB table.
2. Create a REST API in API Gateway to connect to your Lambda function.
3. Create a DynamoDB table and test it with your Lambda function in the console.

4. Deploy your API and test the full setup using curl in a terminal.

By completing these stages, you will learn how to use API Gateway to create an HTTP endpoint that can securely invoke a Lambda function at any scale. You will also learn how to deploy your API, and how to test it in the console and by sending an HTTP request using a terminal.

Sections

- [Prerequisites](#)
- [Create a permissions policy](#)
- [Create an execution role](#)
- [Create the function](#)
- [Invoke the function using the AWS CLI](#)
- [Create a REST API using API Gateway](#)
- [Create a resource on your REST API](#)
- [Create an HTTP POST method](#)
- [Create a DynamoDB table](#)
- [Test the integration of API Gateway, Lambda, and DynamoDB](#)
- [Deploy the API](#)
- [Use curl to invoke your function using HTTP requests](#)
- [Clean up your resources \(optional\)](#)

Prerequisites

Sign up for an AWS account

If you do not have an AWS account, complete the following steps to create one.

To sign up for an AWS account

1. Open <https://portal.aws.amazon.com/billing/signup>.
2. Follow the online instructions.

Part of the sign-up procedure involves receiving a phone call and entering a verification code on the phone keypad.

When you sign up for an AWS account, an *AWS account root user* is created. The root user has access to all AWS services and resources in the account. As a security best practice, assign administrative access to a user, and use only the root user to perform [tasks that require root user access](#).

AWS sends you a confirmation email after the sign-up process is complete. At any time, you can view your current account activity and manage your account by going to <https://aws.amazon.com/> and choosing **My Account**.

Create a user with administrative access

After you sign up for an AWS account, secure your AWS account root user, enable AWS IAM Identity Center, and create an administrative user so that you don't use the root user for everyday tasks.

Secure your AWS account root user

1. Sign in to the [AWS Management Console](#) as the account owner by choosing **Root user** and entering your AWS account email address. On the next page, enter your password.

For help signing in by using root user, see [Signing in as the root user](#) in the *AWS Sign-In User Guide*.

2. Turn on multi-factor authentication (MFA) for your root user.

For instructions, see [Enable a virtual MFA device for your AWS account root user \(console\)](#) in the *IAM User Guide*.

Create a user with administrative access

1. Enable IAM Identity Center.

For instructions, see [Enabling AWS IAM Identity Center](#) in the *AWS IAM Identity Center User Guide*.

2. In IAM Identity Center, grant administrative access to a user.

For a tutorial about using the IAM Identity Center directory as your identity source, see [Configure user access with the default IAM Identity Center directory](#) in the *AWS IAM Identity Center User Guide*.

Sign in as the user with administrative access

- To sign in with your IAM Identity Center user, use the sign-in URL that was sent to your email address when you created the IAM Identity Center user.

For help signing in using an IAM Identity Center user, see [Signing in to the AWS access portal](#) in the *AWS Sign-In User Guide*.

Assign access to additional users

- In IAM Identity Center, create a permission set that follows the best practice of applying least-privilege permissions.

For instructions, see [Create a permission set](#) in the *AWS IAM Identity Center User Guide*.

- Assign users to a group, and then assign single sign-on access to the group.

For instructions, see [Add groups](#) in the *AWS IAM Identity Center User Guide*.

Install the AWS Command Line Interface

If you have not yet installed the AWS Command Line Interface, follow the steps at [Installing or updating the latest version of the AWS CLI](#) to install it.

The tutorial requires a command line terminal or shell to run commands. In Linux and macOS, use your preferred shell and package manager.

Note

In Windows, some Bash CLI commands that you commonly use with Lambda (such as `zip`) are not supported by the operating system's built-in terminals. To get a Windows-integrated version of Ubuntu and Bash, [install the Windows Subsystem for Linux](#).

Create a permissions policy

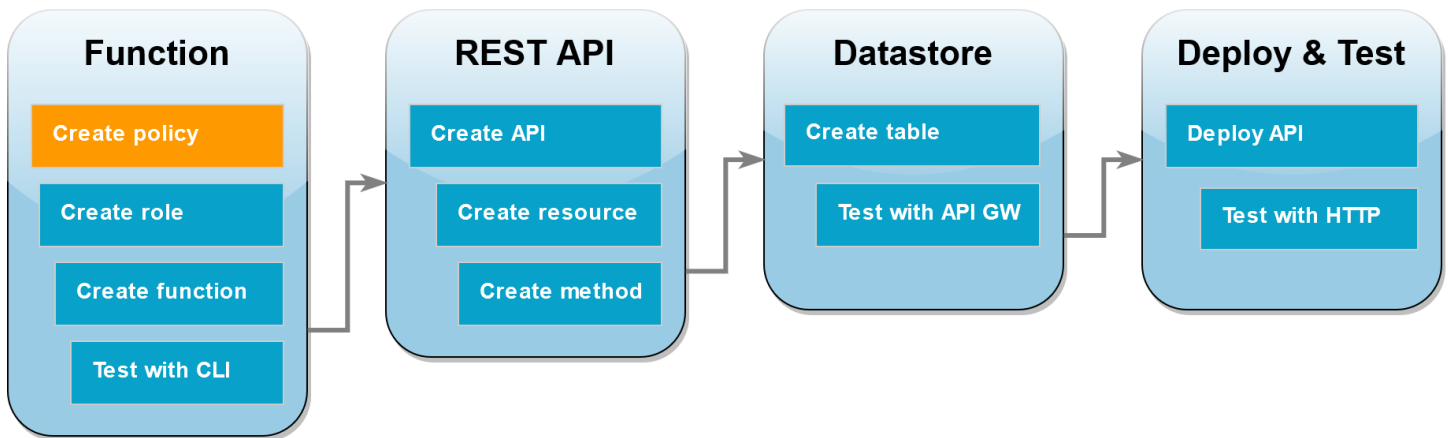

Before you can create an [execution role](#) for your Lambda function, you first need to create a permissions policy to give your function permission to access the required AWS resources. For this tutorial, the policy allows Lambda to perform CRUD operations on a DynamoDB table and write to Amazon CloudWatch Logs.

To create the policy

1. Open the [Policies page](#) of the IAM console.
2. Choose **Create Policy**.
3. Choose the **JSON** tab, and then paste the following custom policy into the JSON editor.

```

{
  "Version": "2012-10-17",
  "Statement": [
    {
      "Sid": "Stmt1428341300017",
      "Action": [
        "dynamodb:DeleteItem",
        "dynamodb:GetItem",
        "dynamodb:PutItem",
        "dynamodb:Query",
        "dynamodb:Scan",
        "dynamodb:UpdateItem"
      ],
      "Effect": "Allow",
      "Resource": "*"
    }
  ],
}
  
```

```

    "Sid": "",
    "Resource": "*",
    "Action": [
      "logs:CreateLogGroup",
      "logs:CreateLogStream",
      "logs:PutLogEvents"
    ],
    "Effect": "Allow"
  }
]
}

```

4. Choose **Next: Tags**.
5. Choose **Next: Review**.
6. Under **Review policy**, for the policy **Name**, enter **lambda-apigateway-policy**.
7. Choose **Create policy**.

Create an execution role

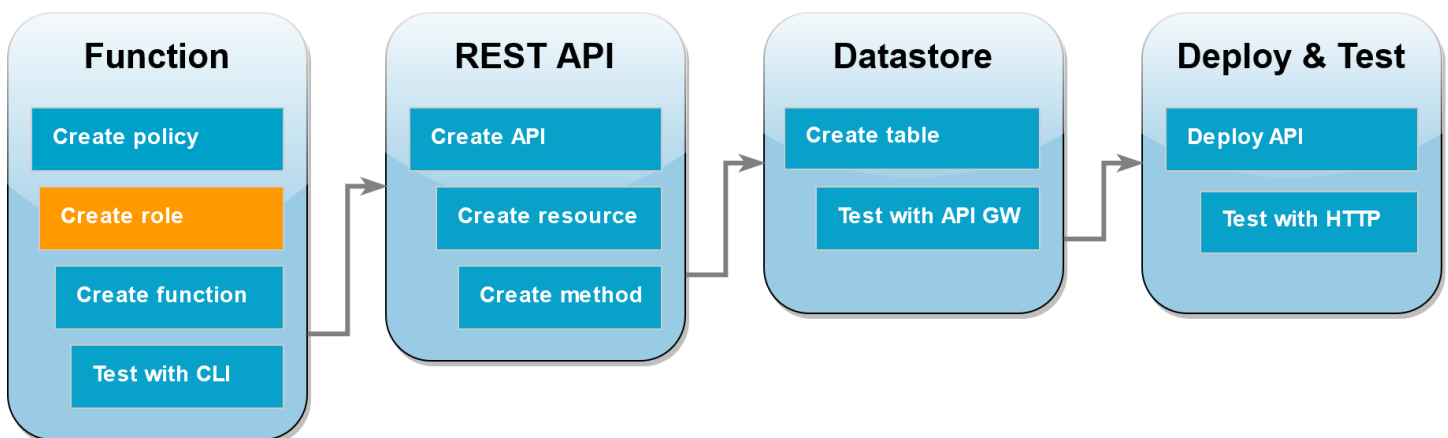

An [execution role](#) is an AWS Identity and Access Management (IAM) role that grants a Lambda function permission to access AWS services and resources. To enable your function to perform operations on a DynamoDB table, you attach the permissions policy you created in the previous step.

To create an execution role and attach your custom permissions policy

1. Open the [Roles page](#) of the IAM console.
2. Choose **Create role**.
3. For the type of trusted entity, choose **AWS service**, then for the use case, choose **Lambda**.

4. Choose **Next**.
5. In the policy search box, enter **lambda-apigateway-policy**.
6. In the search results, select the policy that you created (lambda-apigateway-policy), and then choose **Next**.
7. Under **Role details**, for the **Role name**, enter **lambda-apigateway-role**, then choose **Create role**.

Later in the tutorial, you need the Amazon Resource Name (ARN) of the role you just created. On the **Roles** page of the IAM console, choose the name of your role (lambda-apigateway-role) and copy the **Role ARN** displayed on the **Summary** page.

Create the function

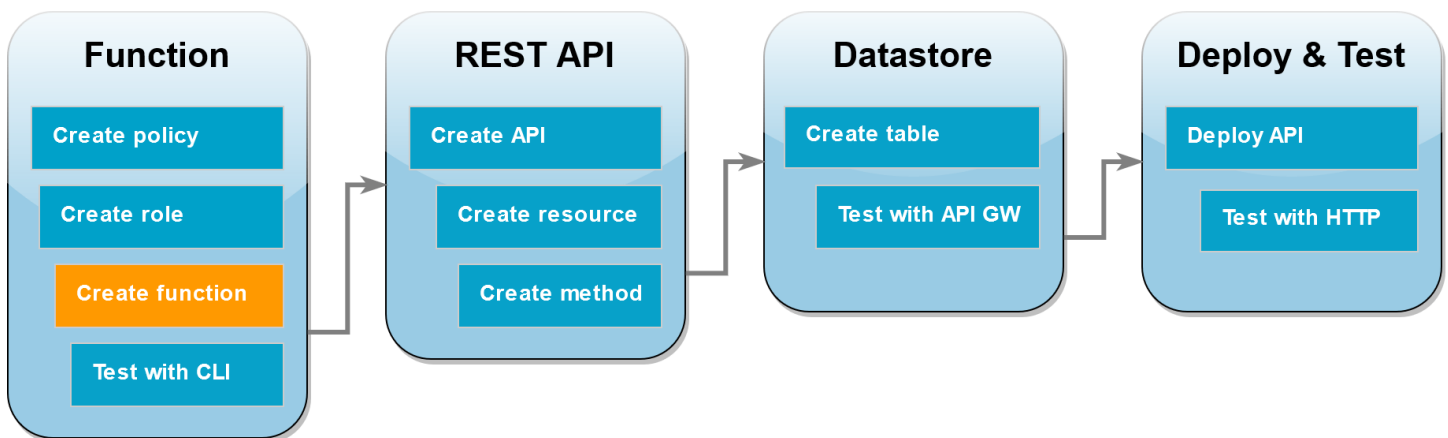

The following code example receives an event input from API Gateway specifying an operation to perform on the DynamoDB table you will create and some payload data. If the parameters the function receives are valid, it performs the requested operation on the table.

Node.js

Example index.mjs

Note the region setting. This must match the AWS Region where you deploy the function and [create the DynamoDB table](#).

```
import { DynamoDBDocumentClient, PutCommand, GetCommand,
        UpdateCommand, DeleteCommand } from "@aws-sdk/lib-dynamodb";
import { DynamoDBClient } from "@aws-sdk/client-dynamodb";

const ddbClient = new DynamoDBClient({ region: "us-east-2" });
```

```
const ddbDocClient = DynamoDBDocumentClient.from(ddbClient);

// Define the name of the DDB table to perform the CRUD operations on
const tablename = "lambda-apigateway";

/**
 * Provide an event that contains the following keys:
 *
 * - operation: one of 'create,' 'read,' 'update,' 'delete,' or 'echo'
 * - payload: a JSON object containing the parameters for the table item
 *   to perform the operation on
 */
export const handler = async (event, context) => {

    const operation = event.operation;

    if (operation == 'echo'){
        return(event.payload);
    }

    else {
        event.payload.TableName = tablename;
        let response;

        switch (operation) {
            case 'create':
                response = await ddbDocClient.send(new PutCommand(event.payload));
                break;
            case 'read':
                response = await ddbDocClient.send(new GetCommand(event.payload));
                break;
            case 'update':
                response = ddbDocClient.send(new UpdateCommand(event.payload));
                break;
            case 'delete':
                response = ddbDocClient.send(new DeleteCommand(event.payload));
                break;
            default:
                response = 'Unknown operation: ${operation}';
        }
        console.log(response);
        return response;
    }
}
```

```
};
```

Note

In this example, the name of the DynamoDB table is defined as a variable in your function code. In a real application, best practice is to pass this parameter as an environment variable and to avoid hardcoding the table name. For more information see [Using AWS Lambda environment variables](#).

To create the function

1. Save the code example as a file named `index.mjs` and, if necessary, edit the AWS region specified in the code. The region specified in the code must be the same as the region in which you create your DynamoDB table later in the tutorial.
2. Create a deployment package using the following `zip` command.

```
zip function.zip index.mjs
```

3. Create a Lambda function using the `create-function` AWS CLI command. For the `role` parameter, enter the execution role's Amazon Resource Name (ARN) that you copied earlier.

```
aws lambda create-function \  
--function-name LambdaFunctionOverHttps \  
--zip-file fileb://function.zip \  
--handler index.handler \  
--runtime nodejs22.x \  
--role arn:aws:iam::123456789012:role/service-role/lambda-apigateway-role
```

Python 3

Example LambdaFunctionOverHttps.py

```
import boto3  
  
# Define the DynamoDB table that Lambda will connect to  
table_name = "lambda-apigateway"  
  
# Create the DynamoDB resource
```



```
dynamo = boto3.resource('dynamodb').Table(table_name)

# Define some functions to perform the CRUD operations
def create(payload):
    return dynamo.put_item(Item=payload['Item'])

def read(payload):
    return dynamo.get_item(Key=payload['Key'])

def update(payload):
    return dynamo.update_item(**{k: payload[k] for k in ['Key', 'UpdateExpression',
    'ExpressionAttributeNames', 'ExpressionAttributeValues'] if k in payload})

def delete(payload):
    return dynamo.delete_item(Key=payload['Key'])

def echo(payload):
    return payload

operations = {
    'create': create,
    'read': read,
    'update': update,
    'delete': delete,
    'echo': echo,
}

def lambda_handler(event, context):
    '''Provide an event that contains the following keys:
    - operation: one of the operations in the operations dict below
    - payload: a JSON object containing parameters to pass to the
    operation being performed
    ...

    operation = event['operation']
    payload = event['payload']

    if operation in operations:
        return operations[operation](payload)

    else:
        raise ValueError(f'Unrecognized operation "{operation}")
```

Note

In this example, the name of the DynamoDB table is defined as a variable in your function code. In a real application, best practice is to pass this parameter as an environment variable and to avoid hardcoding the table name. For more information see [Using AWS Lambda environment variables](#).

To create the function

1. Save the code example as a file named `LambdaFunctionOverHttps.py`.
2. Create a deployment package using the following `zip` command.

```
zip function.zip LambdaFunctionOverHttps.py
```

3. Create a Lambda function using the `create-function` AWS CLI command. For the `role` parameter, enter the execution role's Amazon Resource Name (ARN) that you copied earlier.

```
aws lambda create-function \
--function-name LambdaFunctionOverHttps \
--zip-file fileb://function.zip \
--handler LambdaFunctionOverHttps.lambda_handler \
--runtime python3.12 \
--role arn:aws:iam::123456789012:role/service-role/lambda-apigateway-role
```

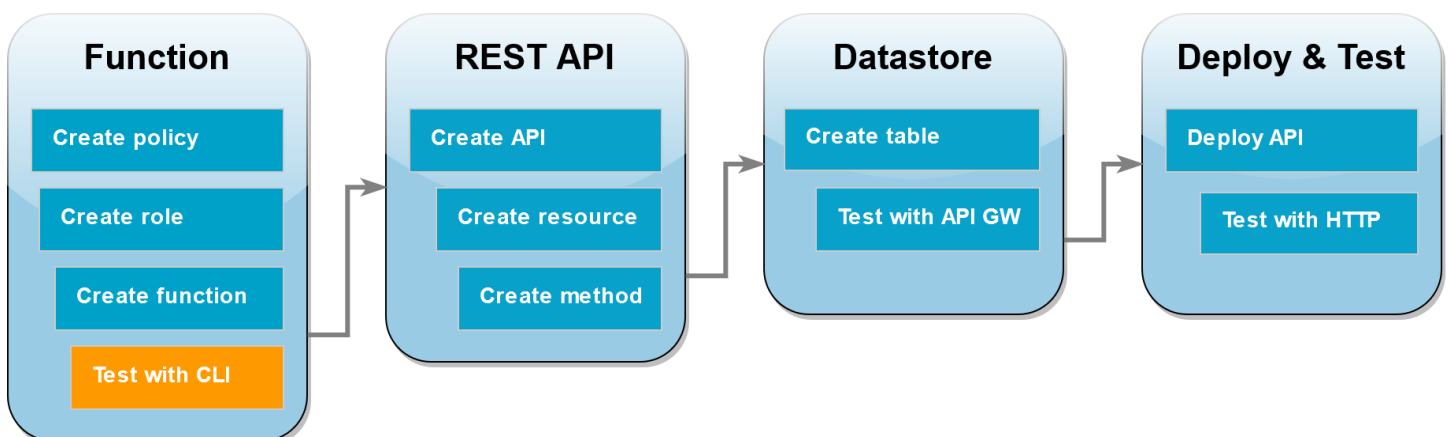
Invoke the function using the AWS CLI

Before integrating your function with API Gateway, confirm that you have deployed the function successfully. Create a test event containing the parameters your API Gateway API will send to Lambda and use the AWS CLI `invoke` command to run your function.

To invoke the Lambda function with the AWS CLI

1. Save the following JSON as a file named `input.txt`.

```
{
  "operation": "echo",
  "payload": {
    "somekey1": "somevalue1",
    "somekey2": "somevalue2"
  }
}
```

2. Run the following `invoke` AWS CLI command.

```
aws lambda invoke \
--function-name LambdaFunctionOverHttps \
--payload file://input.txt outputfile.txt \
--cli-binary-format raw-in-base64-out
```

The `cli-binary-format` option is required if you're using AWS CLI version 2. To make this the default setting, run `aws configure set cli-binary-format raw-in-base64-out`. For more information, see [AWS CLI supported global command line options](#) in the *AWS Command Line Interface User Guide for Version 2*.

You should see the following response:

```
{
  "StatusCode": 200,
  "ExecutedVersion": "LATEST"
}
```

3. Confirm that your function performed the echo operation you specified in the JSON test event. Inspect the `outputfile.txt` file and verify it contains the following:

```
{"somekey1": "somevalue1", "somekey2": "somevalue2"}
```

Create a REST API using API Gateway

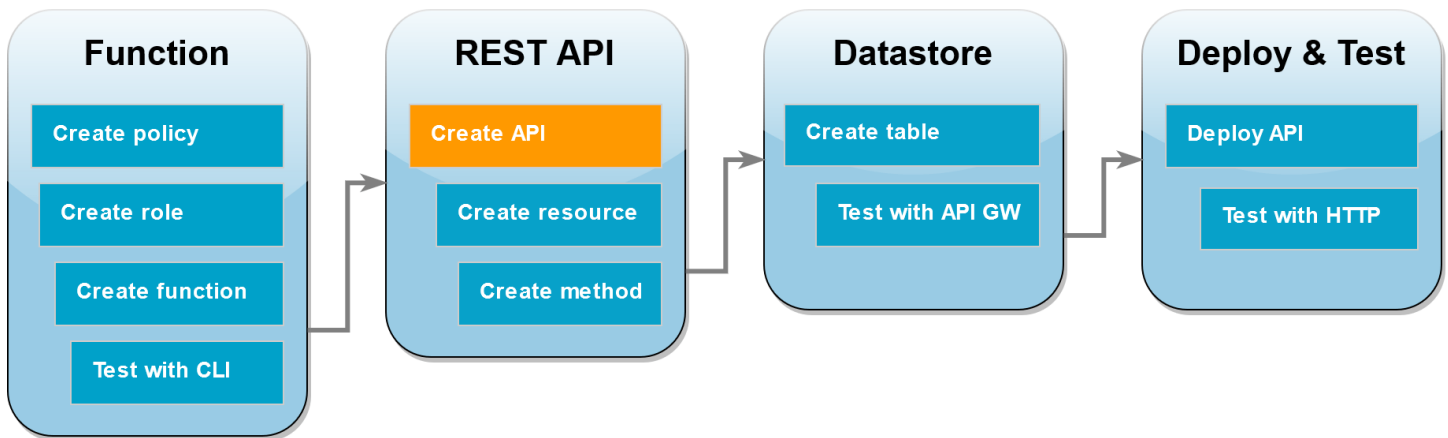

In this step, you create the API Gateway REST API you will use to invoke your Lambda function.

To create the API

1. Open the [API Gateway console](#).
2. Choose **Create API**.
3. In the **REST API** box, choose **Build**.
4. Under **API details**, leave **New API** selected, and for **API Name**, enter **DynamoDBOperations**.
5. Choose **Create API**.

Create a resource on your REST API

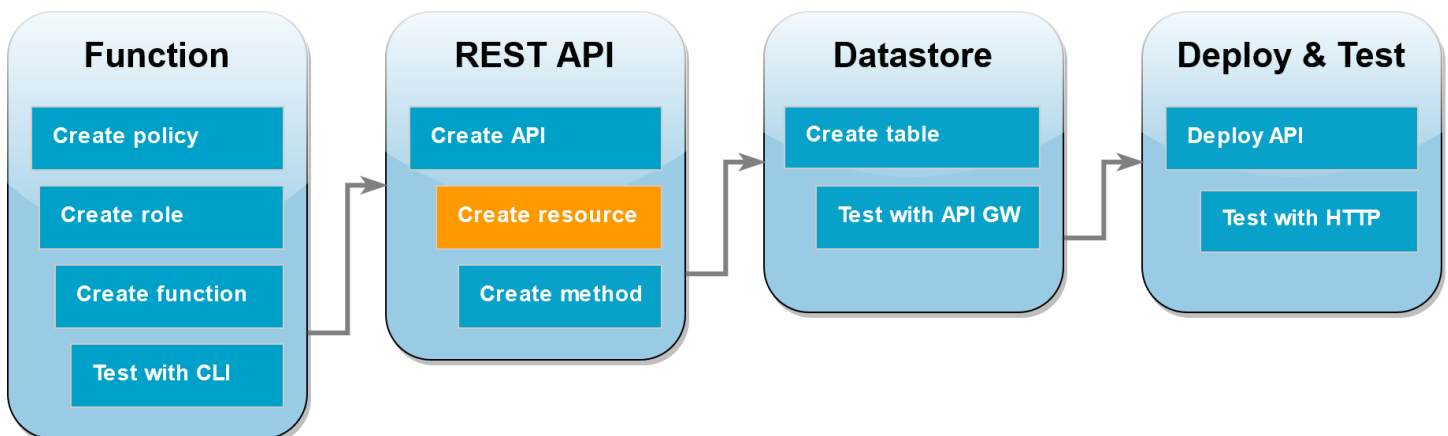

To add an HTTP method to your API, you first need to create a resource for that method to operate on. Here you create the resource to manage your DynamoDB table.

To create the resource

1. In the [API Gateway console](#), on the **Resources** page for your API, choose **Create Resource**.
2. In **Resource details**, for **Resource name** enter **DynamoDBManager**.
3. Choose **Create Resource**.

Create an HTTP POST method

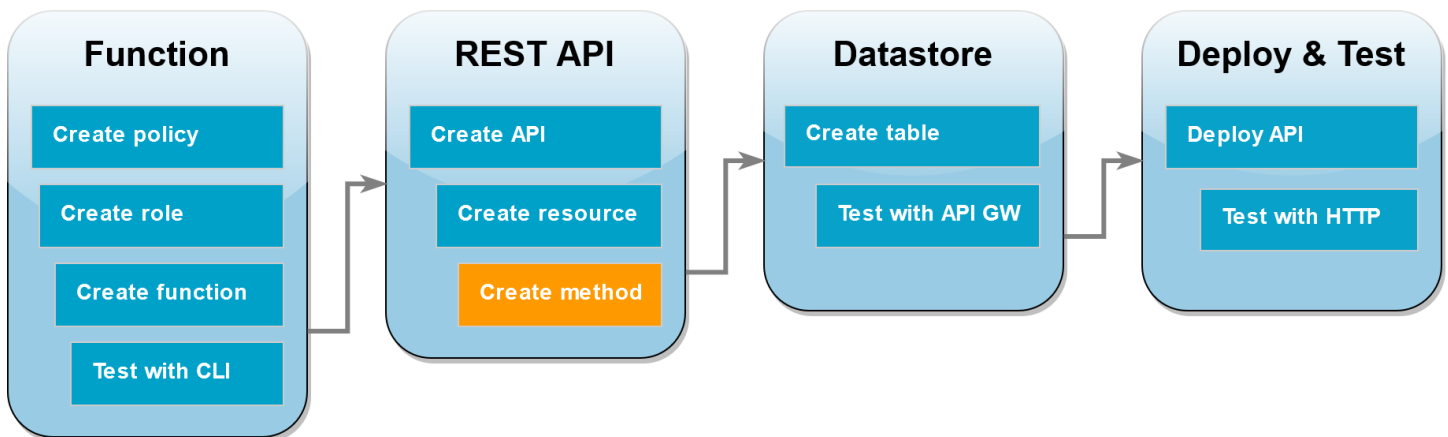

In this step, you create a method (POST) for your `DynamoDBManager` resource. You link this POST method to your Lambda function so that when the method receives an HTTP request, API Gateway invokes your Lambda function.

Note

For the purpose of this tutorial, one HTTP method (POST) is used to invoke a single Lambda function which carries out all of the operations on your DynamoDB table. In a real application, best practice is to use a different Lambda function and HTTP method for each operation. For more information, see [The Lambda monolith](#) in Serverless Land.

To create the POST method

1. On the **Resources** page for your API, ensure that the `/DynamoDBManager` resource is highlighted. Then, in the **Methods** pane, choose **Create method**.
2. For **Method type**, choose **POST**.
3. For **Integration type**, leave **Lambda function** selected.

4. For **Lambda function**, choose the Amazon Resource Name (ARN) for your function (LambdaFunctionOverHttps).
5. Choose **Create method**.

Create a DynamoDB table

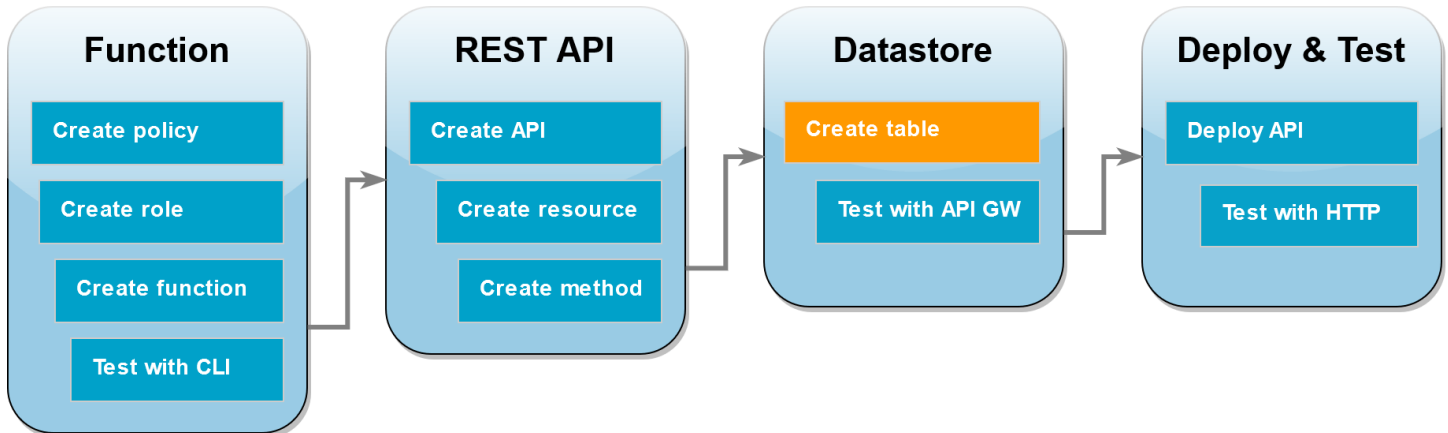

Create an empty DynamoDB table that your Lambda function will perform CRUD operations on.

To create the DynamoDB table

1. Open the [Tables page](#) of the DynamoDB console.
2. Choose **Create table**.
3. Under **Table details**, do the following:
 1. For **Table name**, enter **lambda-apigateway**.
 2. For **Partition key**, enter **id**, and keep the data type set as **String**.
4. Under **Table settings**, keep the **Default settings**.
5. Choose **Create table**.

Test the integration of API Gateway, Lambda, and DynamoDB

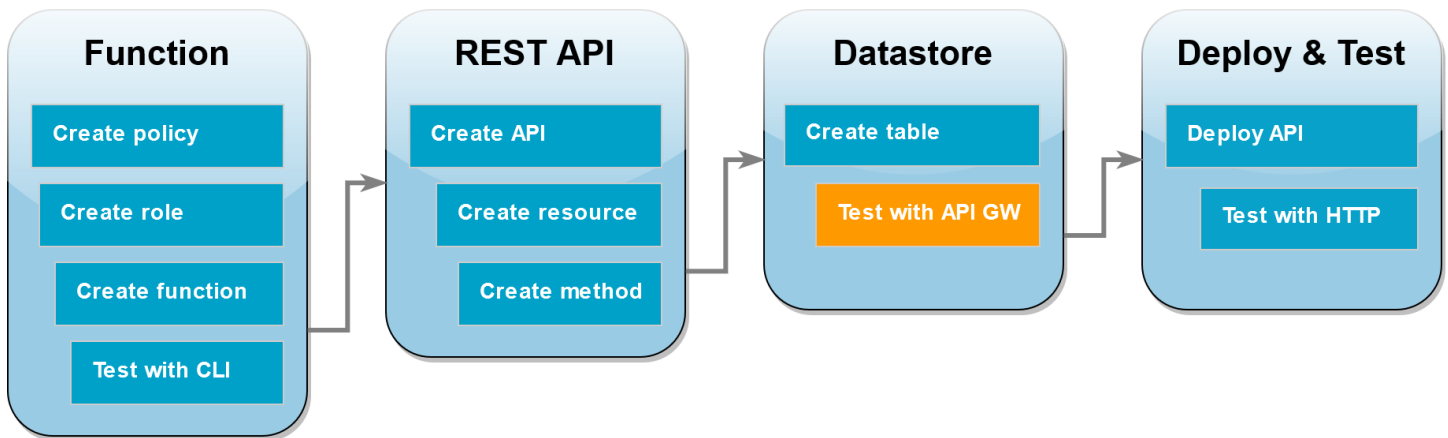

You're now ready to test the integration of your API Gateway API method with your Lambda function and your DynamoDB table. Using the API Gateway console, you send requests directly to your POST method using the console's test function. In this step, you first use a create operation to add a new item to your DynamoDB table, then you use an update operation to modify the item.

Test 1: To create a new item in your DynamoDB table

1. In the [API Gateway console](#), choose your API (DynamoDBOperations).
2. Choose the **POST** method under the DynamoDBManager resource.

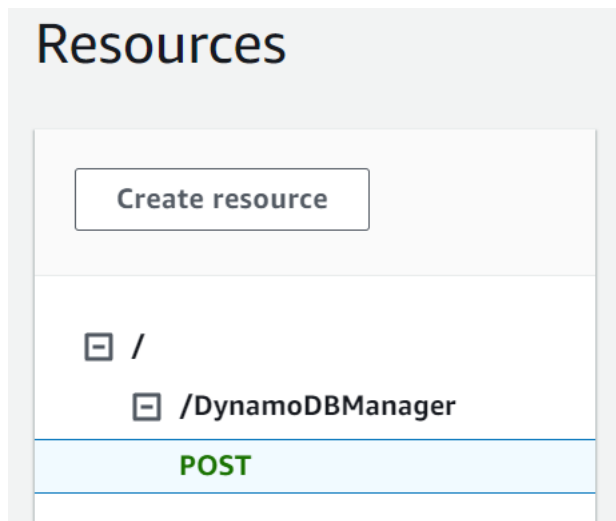

3. Choose the **Test** tab. You might need to choose the right arrow button to show the tab.
4. Under **Test method**, leave **Query strings** and **Headers** empty. For **Request body**, paste the following JSON:

```
{
```

```

"operation": "create",
"payload": {
  "Item": {
    "id": "1234ABCD",
    "number": 5
  }
}
}

```

5. Choose **Test**.

The results that are displayed when the test completes should show status `200`. This status code indicates that the `create` operation was successful.

To confirm, check that your DynamoDB table now contains the new item.

- Open the [Tables page](#) of the DynamoDB console and choose the `lambda-apigateway` table.
- Chose **Explore table items**. In the **Items returned** pane, you should see one item with the **id** `1234ABCD` and the **number** `5`. Example:

Items returned (1)

<input type="checkbox"/>	<i>id (String)</i>	<input type="checkbox"/>	<i>number</i>
<input type="checkbox"/>	1234ABCD		5

Test 2: To update the item in your DynamoDB table

- In the [API Gateway console](#), return to your POST method's **Test** tab.
- Under **Test method**, leave **Query strings** and **Headers** empty. For **Request body**, paste the following JSON:

```

{
  "operation": "update",
  "payload": {
    "Key": {
      "id": "1234ABCD"
    },
    "UpdateExpression": "SET #num = :newNum",

```



```

    "ExpressionAttributeNames": {
      "#num": "number"
    },
    "ExpressionAttributeValues": {
      ":newNum": 10
    }
  }
}

```

3. Choose **Test**.

The results which are displayed when the test completes should show status `200`. This status code indicates that the update operation was successful.

To confirm, check that the item in your DynamoDB table has been modified.

4. Open the [Tables page](#) of the DynamoDB console and choose the `lambda-apigateway` table.
5. Chose **Explore table items**. In the **Items returned** pane, you should see one item with the `id` `1234ABCD` and the `number` `10`.

Items returned (1)

<input type="checkbox"/>	<code>id (String)</code>	<input type="checkbox"/>	<code>number</code>
<input type="checkbox"/>	1234ABCD		10

Deploy the API

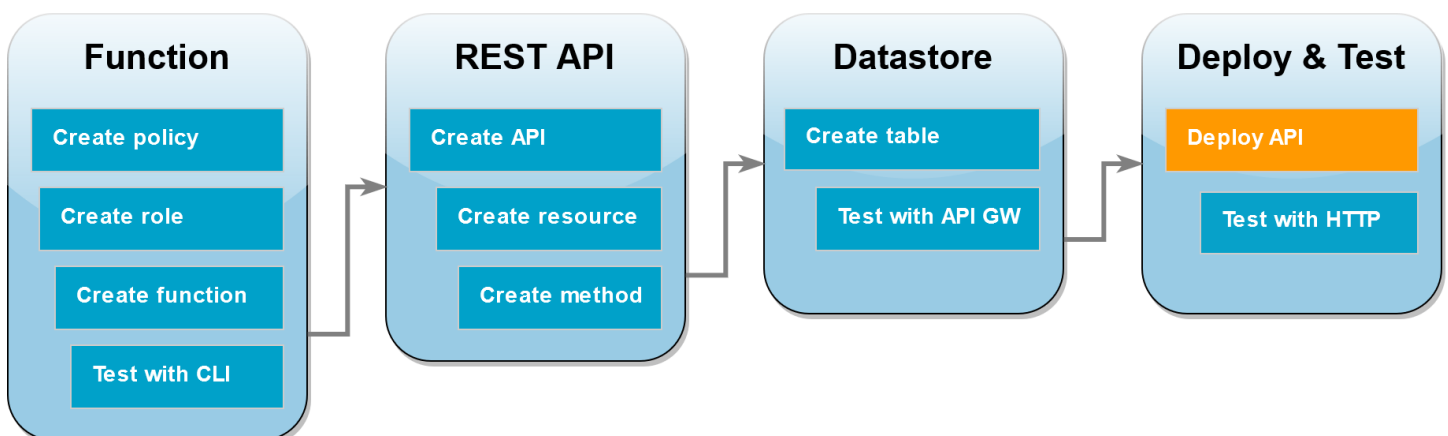

For a client to call the API, you must create a deployment and an associated stage. A stage represents a snapshot of your API including its methods and integrations.

To deploy the API

1. Open the **APIs** page of the [API Gateway console](#) and choose the DynamoDBOperations API.
2. On the **Resources** page for your API choose **Deploy API**.
3. For **Stage**, choose ***New stage***, then for **Stage name**, enter **test**.
4. Choose **Deploy**.
5. In the **Stage details** pane, copy the **Invoke URL**. You will use this in the next step to invoke your function using an HTTP request.

Use curl to invoke your function using HTTP requests

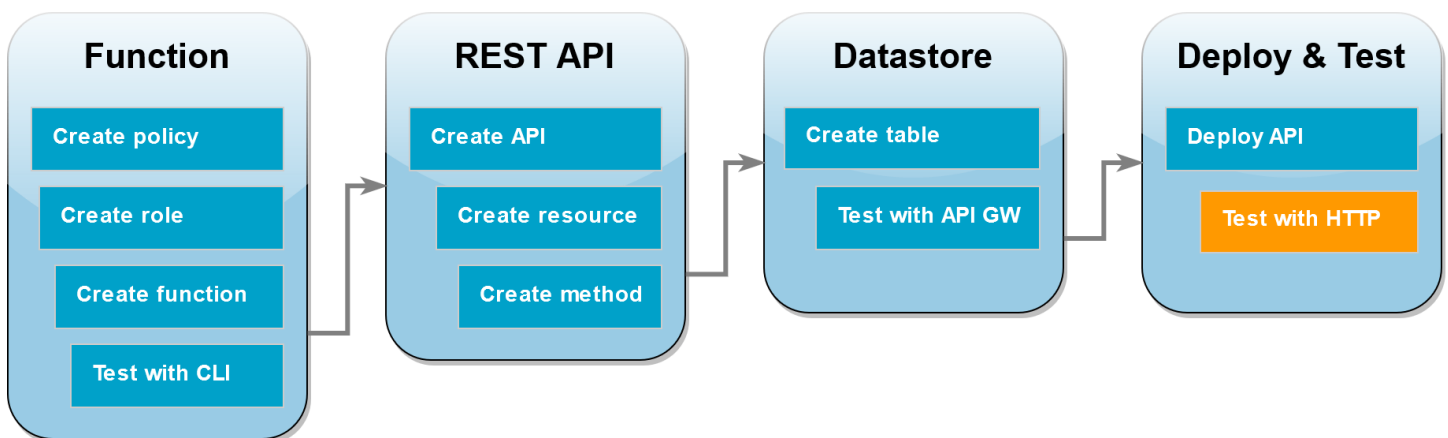

You can now invoke your Lambda function by issuing an HTTP request to your API. In this step, you will create a new item in your DynamoDB table and then perform read, update, and delete operations on that item.

To create an item in your DynamoDB table using curl

1. Run the following `curl` command using the invoke URL you copied in the previous step. When you use `curl` with the `-d` (data) option, it automatically uses the HTTP POST method.

```
curl https://l8togsqxd8.execute-api.us-east-2.amazonaws.com/test/DynamoDBManager \
-d '{"operation": "create", "payload": {"Item": {"id": "5678EFGH", "number": 15}}}'
```

If the operation was successful, you should see a response returned with an HTTP status code of 200.

2. You can also use the DynamoDB console to verify that the new item is in your table by doing the following:
 1. Open the [Tables page](#) of the DynamoDB console and choose the `lambda-apigateway` table.
 2. Choose **Explore table items**. In the **Items returned** pane, you should see an item with the `id` `5678EFGH` and the `number` `15`.

To read the item in your DynamoDB table using curl

- Run the following `curl` command to read the value of the item you just created. Use your own invoke URL.

```
curl https://avos4dr2rk.execute-api.us-east-2.amazonaws.com/test/DynamoDBManager -d \
'{"operation": "read", "payload": {"Key": {"id": "5678EFGH"}}}'
```

You should see output like one of the following depending on whether you chose the Node.js or Python function code:

Node.js

```
{"$metadata": {"statusCode": 200, "requestId": "7BP3G5Q0C001E50FBQI9NS099JVV4KQNS05AEMVJF66Q9ASUAAJG", "attempts": 1, "totalRetryDelay": 0}, "Item": {"id": "5678EFGH", "number": 15}}
```

Python

```
{"Item": {"id": "5678EFGH", "number": 15}, "ResponseMetadata": {"RequestId": "QNDJICE52E86B82VETR6RKBE5BVV4KQNS05AEMVJF66Q9ASUAAJG", "HTTPStatusCode": 200, "HTTPHeaders": {"server": "Server", "date": "Wed, 31 Jul 2024 00:37:01 GMT", "content-type": "application/x-amz-json-1.0", "content-length": "52", "connection": "keep-alive", "x-amzn-requestid": "QNDJICE52E86B82VETR6RKBE5BVV4KQNS05AEMVJF66Q9ASUAAJG", "x-amz-crc32": "2589610852"}, "RetryAttempts": 0}}
```

To update the item in your DynamoDB table using curl

1. Run the following `curl` command to update the item you just created by changing the `number` value. Use your own `invoke` URL.

```
curl https://avos4dr2rk.execute-api.us-east-2.amazonaws.com/test/DynamoDBManager \
-d '{"operation": "update", "payload": {"Key": {"id": "5678EFGH"},
  "UpdateExpression": "SET #num = :new_value", "ExpressionAttributeNames": {"#num":
  "number"}, "ExpressionAttributeValues": {":new_value": 42}}}'
```

2. To confirm that the value of `number` for the item has been updated, run another `read` command:

```
curl https://avos4dr2rk.execute-api.us-east-2.amazonaws.com/test/DynamoDBManager \
-d '{"operation": "read", "payload": {"Key": {"id": "5678EFGH"}}}'
```

To delete the item in your DynamoDB table using curl

1. Run the following `curl` command to delete the item you just created. Use your own `invoke` URL.

```
curl https://l8togsqxd8.execute-api.us-east-2.amazonaws.com/test/DynamoDBManager \
-d '{"operation": "delete", "payload": {"Key": {"id": "5678EFGH"}}}'
```

2. Confirm that the delete operation was successful. In the **Items returned** pane of the DynamoDB console **Explore items** page, verify that the item with `id` 5678EFGH is no longer in the table.

Clean up your resources (optional)

You can now delete the resources that you created for this tutorial, unless you want to retain them. By deleting AWS resources that you're no longer using, you prevent unnecessary charges to your AWS account.

To delete the Lambda function

1. Open the [Functions page](#) of the Lambda console.
2. Select the function that you created.

3. Choose **Actions, Delete**.
4. Type **confirm** in the text input field and choose **Delete**.

To delete the execution role

1. Open the [Roles page](#) of the IAM console.
2. Select the execution role that you created.
3. Choose **Delete**.
4. Enter the name of the role in the text input field and choose **Delete**.

To delete the API

1. Open the [APIs page](#) of the API Gateway console.
2. Select the API you created.
3. Choose **Actions, Delete**.
4. Choose **Delete**.

To delete the DynamoDB table

1. Open the [Tables page](#) of the DynamoDB console.
2. Select the table you created.
3. Choose **Delete**.
4. Enter **delete** in the text box.
5. Choose **Delete table**.

Handling Lambda errors with an API Gateway API

API Gateway treats all invocation and function errors as internal errors. If the Lambda API rejects the invocation request, API Gateway returns a 500 error code. If the function runs but returns an error, or returns a response in the wrong format, API Gateway returns a 502. In both cases, the body of the response from API Gateway is `{"message": "Internal server error"}`.

Note

API Gateway does not retry any Lambda invocations. If Lambda returns an error, API Gateway returns an error response to the client.

The following example shows an X-Ray trace map for a request that resulted in a function error and a 502 from API Gateway. The client receives the generic error message.

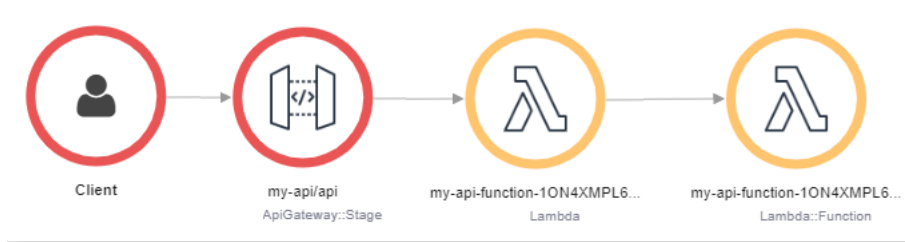

To customize the error response, you must catch errors in your code and format a response in the required format.

Example [index.mjs](#) – Error formatting

```
var formatError = function(error){
  var response = {
    "statusCode": error.statusCode,
    "headers": {
      "Content-Type": "text/plain",
      "x-amzn-ErrorType": error.code
    },
    "isBase64Encoded": false,
    "body": error.code + ": " + error.message
  }
  return response
}
```

API Gateway converts this response into an HTTP error with a custom status code and body. In the trace map, the function node is green because it handled the error.

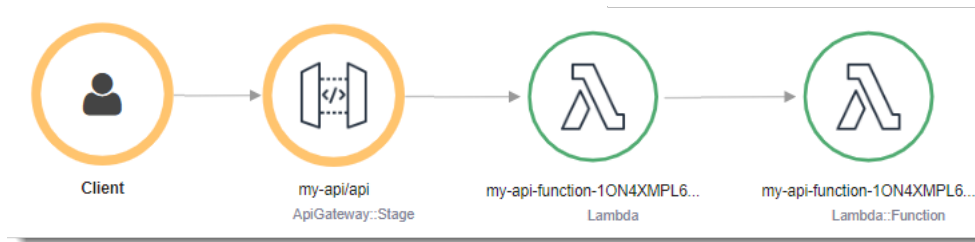

Select a method to invoke your Lambda function using an HTTP request

Many common use cases for Lambda involve invoking your function using an HTTP request. For example, you might want to invoke a function directly from a web browser, or to use a tool like [curl](#) or [Postman](#).

The following sections explain what your choices are for invoking Lambda through HTTP and provide information to help you make the right decision for your particular use case.

What are your choices when selecting an HTTP invoke method?

Lambda offers two main methods to invoke a function using an HTTP request - [function URLs](#) and [API Gateway](#). The key differences between these two options are as follows:

- **Lambda function URLs** provide a simple, direct HTTP endpoint for a Lambda function. They are optimized for simplicity and cost-effectiveness and provide the fastest path to expose a Lambda function via HTTP.
- **API Gateway** is a more advanced service for building fully-featured APIs. API Gateway is optimized for building and managing production APIs at scale and provides comprehensive tools for security, monitoring, and traffic management.

Recommendations if you already know your requirements

If you're already clear on your requirements, here are our basic recommendations:

We recommend [function URLs](#) for simple applications or prototyping where you only need basic authentication methods and request/response handling and where you want to keep costs and complexity to a minimum.

[API Gateway](#) is a better choice for production applications at scale or for cases where you need more advanced features like [OpenAPI Description](#) support, a choice of authentication options,

custom domain names, or rich request/response handling including throttling, caching, and request/response transformation.

What to consider when selecting a method to invoke your Lambda function

When selecting between function URLs and API Gateway, you need to consider the following factors:

- Your authentication needs, such as whether you require OAuth or Amazon Cognito to authenticate users
- Your scaling requirements and the complexity of the API you want to implement
- Whether you need advanced features such as request validation and request/response formatting
- Your monitoring requirements
- Your cost goals

By understanding these factors, you can select the option that best balances your security, complexity, and cost requirements.

The following information summarizes the main differences between the two options.

Authentication

- **Function URLs** provide basic authentication options through AWS Identity and Access Management (IAM). You can configure your endpoints to be either public (no authentication) or to require IAM authentication. With IAM authentication, you can use standard AWS credentials or IAM roles to control access. While straightforward to set up, this approach provides limited options compared with other authentication methods.
- **API Gateway** provides access to a more comprehensive range of authentication options. As well as IAM authentication, you can use [Lambda authorizers](#) (custom authentication logic), [Amazon Cognito](#) user pools, and OAuth2.0 flows. This flexibility allows you to implement complex authentication schemes, including third-party authentication providers, token-based authentication, and multi-factor authentication.

Request/response handling

- **Function URLs** provide basic HTTP request and response handling. They support standard HTTP methods and include built-in cross-origin resource sharing (CORS) support. While they can

handle JSON payloads and query parameters naturally, they don't offer request transformation or validation capabilities. Response handling is similarly straightforward – the client receives the response from your Lambda function exactly as Lambda returns it.

- **API Gateway** provides sophisticated request and response handling capabilities. You can define request validators, transform requests and responses using mapping templates, set up request/response headers, and implement response caching. API Gateway also supports binary payloads and custom domain names and can modify responses before they reach the client. You can set up models for request/response validation and transformation using JSON Schema.

Scaling

- **Function URLs** scale directly with your Lambda function's concurrency limits and handle traffic spikes by scaling your function up to its maximum configured concurrency limit. Once that limit is reached, Lambda responds to additional requests with HTTP 429 responses. There's no built-in queuing mechanism, so handling scaling is entirely dependent on your Lambda function's configuration. By default, Lambda functions have a limit of 1,000 concurrent executions per AWS Region.
- **API Gateway** provides additional scaling capabilities on top of Lambda's own scaling. It includes built-in request queuing and throttling controls, allowing you to manage traffic spikes more gracefully. API Gateway can handle up to 10,000 requests per second per region by default, with a burst capacity of 5,000 requests per second. It also provides tools to throttle requests at different levels (API, stage, or method) to protect your backend.

Monitoring

- **Function URLs** offer basic monitoring through Amazon CloudWatch metrics, including request count, latency, and error rates. You get access to standard Lambda metrics and logs, which show the raw requests coming into your function. While this provides essential operational visibility, the metrics are focused mainly on function execution.
- **API Gateway** provides comprehensive monitoring capabilities including detailed metrics, logging, and tracing options. You can monitor API calls, latency, error rates, and cache hit/miss rates through CloudWatch. API Gateway also integrates with AWS X-Ray for distributed tracing and provides customizable logging formats.

Cost

- **Function URLs** follow the standard Lambda pricing model – you only pay for function invocations and compute time. There are no additional charges for the URL endpoint itself. This makes it a cost-effective choice for simple APIs or low-traffic applications if you don't need the additional features of API Gateway.
- **API Gateway** offers a [free tier](#) that includes one million API calls received for REST APIs and one million API calls received for HTTP APIs. After this, API Gateway charges for API calls, data transfer, and caching (if enabled). Refer to the API Gateway [pricing page](#) to understand the costs for your own use case.

Other features

- **Function URLs** are designed for simplicity and direct Lambda integration. They support both HTTP and HTTPS endpoints, offer built-in CORS support, and provide dual-stack (IPv4 and IPv6) endpoints. While they lack advanced features, they excel in scenarios where you need a quick, straightforward way to expose Lambda functions via HTTP.
- **API Gateway** includes numerous additional features such as API versioning, stage management, API keys for usage plans, API documentation through Swagger/OpenAPI, WebSocket APIs, private APIs within a VPC, and WAF integration for additional security. It also supports canary deployments, mock integrations for testing, and integration with other AWS services beyond Lambda.

Select a method to invoke your Lambda function

Now that you've read about the criteria for selecting between Lambda function URLs and API Gateway and the key differences between them, you can select the option that best meets your needs and use the following resources to help you get started using it.

Function URLs

Get started with function URLs with the following resources

- Follow the tutorial [Creating a Lambda function with a function URL](#)
- Learn more about function URLs in the [the section called "Function URLs"](#) chapter of this guide
- Try the in-console guided tutorial **Create a simple web app** by doing the following:

1. Open the [functions page](#) of the Lambda console.
2. Open the help panel by choosing the icon in the top right corner of the screen.

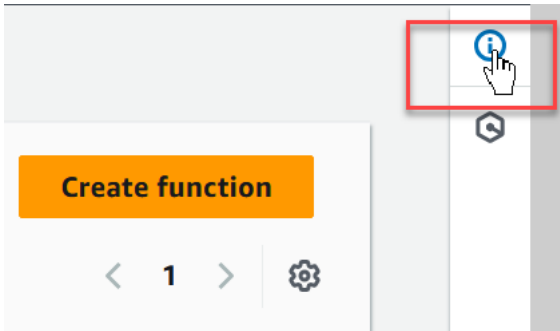

3. Select **Tutorials**.
4. In **Create a simple web app**, choose **Start tutorial**.

API Gateway

Get started with Lambda and API Gateway with the following resources

- Follow the tutorial [Using Lambda with API Gateway](#) to create a REST API integrated with a backend Lambda function.
- Learn more about the different kinds of API offered by API Gateway in the following sections of the *Amazon API Gateway Developer Guide*:
 - [API Gateway REST APIs](#)
 - [API Gateway HTTP APIs](#)
 - [API Gateway WebSocket APIs](#)
- Try one or more of the examples in the [Tutorials and workshops](#) section of the *Amazon API Gateway Developer Guide*.

Using AWS Lambda with AWS Infrastructure Composer

AWS Infrastructure Composer is a visual builder for designing modern applications on AWS. You design your application architecture by dragging, grouping, and connecting AWS services in a visual canvas. Infrastructure Composer creates infrastructure as code (IaC) templates from your design that you can deploy using [AWS SAM](#) or [AWS CloudFormation](#).

Exporting a Lambda function to Infrastructure Composer

You can get started using Infrastructure Composer by creating a new project based on the configuration of an existing Lambda function using the Lambda console. To export your function's configuration and code to Infrastructure Composer to create a new project, do the following:

1. Open the [Functions page](#) of the Lambda console.
2. Select the function you want to use as a basis for your Infrastructure Composer project.
3. In the **Function overview** pane, choose **Export to Infrastructure Composer**.

To export your function's configuration and code to Infrastructure Composer, Lambda creates an Amazon S3 bucket in your account to temporarily store this data.

4. In the dialog box, choose **Confirm and create project** to accept the default name for this bucket and export your function's configuration and code to Infrastructure Composer.
5. (Optional) To choose another name for the Amazon S3 bucket that Lambda creates, enter a new name and choose **Confirm and create project**. Amazon S3 bucket names must be globally unique and follow the [bucket naming rules](#).
6. To save your project and function files in Infrastructure Composer, activate [local sync mode](#).

Note

If you've used the **Export to Application Composer** feature before and created an Amazon S3 bucket using the default name, Lambda can re-use this bucket if it still exists. Accept the default bucket name in the dialog box to re-use the existing bucket.

Amazon S3 transfer bucket configuration

The Amazon S3 bucket that Lambda creates to transfer your function's configuration automatically encrypts objects using the AES 256 encryption standard. Lambda also configures the bucket to use the [bucket owner condition](#) to ensure that only your AWS account is able to add objects to the bucket.

Lambda configures the bucket to automatically delete objects 10 days after they are uploaded. However, Lambda doesn't automatically delete the bucket itself. To delete the bucket from your AWS account, follow the instructions in [Deleting a bucket](#). The default bucket name uses the prefix `lambdasam`, a 10-digit alphanumeric string, and the AWS Region you created your function in:

```
lambdasam-06f22da95b-us-east-1
```

To avoid additional charges being added to your AWS account, we recommend that you delete the Amazon S3 bucket as soon as you have finished exporting your function to Infrastructure Composer.

Standard [Amazon S3 pricing](#) applies.

Required permissions

To use the Lambda integration with Infrastructure Composer feature, you need certain permissions to download an AWS SAM template and to write your function's configuration to Amazon S3.

To download an AWS SAM template, you must have permission to use the following API actions:

- [GetPolicy](#)
- [iam:GetPolicyVersion](#)
- [iam:GetRole](#)
- [iam:GetRolePolicy](#)
- [iam>ListAttachedRolePolicies](#)
- [iam>ListRolePolicies](#)
- [iam>ListRoles](#)

You can grant permission to use all of these actions by adding the [AWSLambda_ReadOnlyAccess](#) AWS managed policy to your IAM user role.

For Lambda to write your function's configuration to Amazon S3, you must have permission to use the following API actions:

- [S3:PutObject](#)
- [S3:CreateBucket](#)
- [S3:PutBucketEncryption](#)
- [S3:PutBucketLifecycleConfiguration](#)

If you are unable to export your function's configuration to Infrastructure Composer, check that your account has the required permissions for these operations. If you have the required

permissions, but still cannot export your function's configuration, check for any [resource-based policies](#) that might limit access to Amazon S3.

Other resources

For a more detailed tutorial on how to design a serverless application in Infrastructure Composer based on an existing Lambda function, see [Infrastructure as code \(IaC\)](#).

To use Infrastructure Composer and AWS SAM to design and deploy a complete serverless application using Lambda, you can also follow the [AWS Infrastructure Composer tutorial](#) in the [AWS Serverless Patterns Workshop](#).

Using AWS Lambda with AWS CloudFormation

In an AWS CloudFormation template, you can specify a Lambda function as the target of a custom resource. Use custom resources to process parameters, retrieve configuration values, or call other AWS services during stack lifecycle events.

The following example invokes a function that's defined elsewhere in the template.

Example – Custom resource definition

```
Resources:
  primerinvoke:
    Type: AWS::CloudFormation::CustomResource
    Version: "1.0"
    Properties:
      ServiceToken: !GetAtt primer.Arn
      FunctionName: !Ref randomerror
```

The service token is the Amazon Resource Name (ARN) of the function that AWS CloudFormation invokes when you create, update, or delete the stack. You can also include additional properties like `FunctionName`, which AWS CloudFormation passes to your function as is.

AWS CloudFormation invokes your Lambda function [asynchronously](#) with an event that includes a callback URL.

Example – AWS CloudFormation message event

```
{
  "RequestType": "Create",
  "ServiceToken": "arn:aws:lambda:us-east-1:123456789012:function:lambda-error-processor-primer-14R0R2T3JKU66",
  "ResponseURL": "https://cloudformation-custom-resource-response-useast1.s3-us-east-1.amazonaws.com/arn%3Aaws%3Acloudformation%3Aus-east-1%3A123456789012%3Astack/lambda-error-processor/1134083a-2608-1e91-9897-022501a2c456%7Cprimerinvoke%7C5d478078-13e9-baf0-464a-7ef285ecc786?AWSAccessKeyId=AKIAIOSFODNN7EXAMPLE&Expires=1555451971&Signature=28UijZePE5I4dvukKQqM%2F9Rf1o4%3D",
  "StackId": "arn:aws:cloudformation:us-east-1:123456789012:stack/lambda-error-processor/1134083a-2608-1e91-9897-022501a2c456",
  "RequestId": "5d478078-13e9-baf0-464a-7ef285ecc786",
  "LogicalResourceId": "primerinvoke",
  "ResourceType": "AWS::CloudFormation::CustomResource",
```

```

    "ResourceProperties": {
      "ServiceToken": "arn:aws:lambda:us-east-1:123456789012:function:lambda-error-processor-primer-14R0R2T3JKU66",
      "FunctionName": "lambda-error-processor-randomerror-ZWUC391MQAJK"
    }
  }
}

```

The function is responsible for returning a response to the callback URL that indicates success or failure. For the full response syntax, see [Custom resource response objects](#).

Example – AWS CloudFormation custom resource response

```

{
  "Status": "SUCCESS",
  "PhysicalResourceId": "2019/04/18/[$LATEST]b3d1bfc65f19ec610654e4d9b9de47a0",
  "StackId": "arn:aws:cloudformation:us-east-1:123456789012:stack/lambda-error-processor/1134083a-2608-1e91-9897-022501a2c456",
  "RequestId": "5d478078-13e9-baf0-464a-7ef285ecc786",
  "LogicalResourceId": "primerinvoke"
}

```

AWS CloudFormation provides a library called `cf-n-response` that handles sending the response. If you define your function within a template, you can require the library by name. AWS CloudFormation then adds the library to the deployment package that it creates for the function.

If your function that a Custom Resource uses has an [Elastic Network Interface](#) attached to it, add the following resources to the VPC policy where **region** is the Region the function is in without the dashes. For example, `us-east-1` is `useast1`. This will allow the Custom Resource to respond to the callback URL that sends a signal back to the AWS CloudFormation stack.

```

arn:aws:s3:::cloudformation-custom-resource-response-region",
"arn:aws:s3:::cloudformation-custom-resource-response-region/*",

```

The following example function invokes a second function. If the call succeeds, the function sends a success response to AWS CloudFormation, and the stack update continues. The template uses the [AWS::Serverless::Function](#) resource type provided by AWS Serverless Application Model.

Example – Custom resource function

```

Transform: 'AWS::Serverless-2016-10-31'

```

Resources:

primer:

Type: [AWS::Serverless::Function](#)

Properties:

Handler: index.handler

Runtime: nodejs16.x

InlineCode: |

```
var aws = require('aws-sdk');
```

```
var response = require('cfn-response');
```

```
exports.handler = function(event, context) {
```

```
    // For Delete requests, immediately send a SUCCESS response.
```

```
    if (event.RequestType == "Delete") {
```

```
        response.send(event, context, "SUCCESS");
```

```
        return;
```

```
    }
```

```
    var responseStatus = "FAILED";
```

```
    var responseData = {};
```

```
    var functionName = event.ResourceProperties.FunctionName
```

```
    var lambda = new aws.Lambda();
```

```
    lambda.invoke({ FunctionName: functionName }, function(err, invokeResult) {
```

```
        if (err) {
```

```
            responseData = {Error: "Invoke call failed"};
```

```
            console.log(responseData.Error + ":\n", err);
```

```
        }
```

```
        else responseStatus = "SUCCESS";
```

```
        response.send(event, context, responseStatus, responseData);
```

```
    });
```

```
};
```

Description: Invoke a function to create a log stream.

MemorySize: 128

Timeout: 8

Role: !GetAtt role.Arn

Tracing: Active

If the function that the custom resource invokes isn't defined in a template, you can get the source code for `cfn-response` from [cfn-response module](#) in the AWS CloudFormation User Guide.

For more information about custom resources, see [Custom resources](#) in the *AWS CloudFormation User Guide*.

Process Amazon DocumentDB events with Lambda

You can use a Lambda function to process events in an [Amazon DocumentDB \(with MongoDB compatibility\) change stream](#) by configuring an Amazon DocumentDB cluster as an event source. Then, you can automate event-driven workloads by invoking your Lambda function each time that data changes with your Amazon DocumentDB cluster.

Note

Lambda supports version 4.0 and 5.0 of Amazon DocumentDB only. Lambda doesn't support version 3.6.

Also, for event source mappings, Lambda supports instance-based clusters and regional clusters only. Lambda doesn't support [elastic clusters](#) or [global clusters](#). This limitation doesn't apply when using Lambda as a client to connect to Amazon DocumentDB. Lambda can connect to all cluster types to perform CRUD operations.

Lambda processes events from Amazon DocumentDB change streams sequentially in the order in which they arrive. Because of this, your function can handle only one concurrent invocation from Amazon DocumentDB at a time. To monitor your function, you can track its [concurrency metrics](#).

Warning

Lambda event source mappings process each event at least once, and duplicate processing of records can occur. To avoid potential issues related to duplicate events, we strongly recommend that you make your function code idempotent. To learn more, see [How do I make my Lambda function idempotent](#) in the AWS Knowledge Center.

Topics

- [Example Amazon DocumentDB event](#)
- [Prerequisites and permissions](#)
- [Configure network security](#)
- [Creating an Amazon DocumentDB event source mapping \(console\)](#)
- [Creating an Amazon DocumentDB event source mapping \(SDK or CLI\)](#)
- [Polling and stream starting positions](#)

- [Monitoring your Amazon DocumentDB event source](#)
- [Tutorial: Using AWS Lambda with Amazon DocumentDB Streams](#)

Example Amazon DocumentDB event

```
{
  "eventSourceArn": "arn:aws:rds:us-east-1:123456789012:cluster:canaryclusterb2a659a2-qo5tcmqkc103",
  "events": [
    {
      "event": {
        "_id": {
          "_data": "0163eeb6e7000000090100000009000041e1"
        },
        "clusterTime": {
          "$timestamp": {
            "t": 1676588775,
            "i": 9
          }
        },
        "documentKey": {
          "_id": {
            "$oid": "63eeb6e7d418cd98afb1c1d7"
          }
        },
        "fullDocument": {
          "_id": {
            "$oid": "63eeb6e7d418cd98afb1c1d7"
          },
          "anyField": "sampleValue"
        },
        "ns": {
          "db": "test_database",
          "coll": "test_collection"
        },
        "operationType": "insert"
      }
    }
  ],
  "eventSource": "aws:docdb"
}
```

For more information about the events in this example and their shapes, see [Change Events](#) on the MongoDB Documentation website.

Prerequisites and permissions

Before you can use Amazon DocumentDB as an event source for your Lambda function, note the following prerequisites. You must:

- **Have an existing Amazon DocumentDB cluster in the same AWS account and AWS Region as your function.** If you don't have an existing cluster, you can create one by following the steps in [Get Started with Amazon DocumentDB](#) in the *Amazon DocumentDB Developer Guide*. Alternatively, the first set of steps in [Tutorial: Using AWS Lambda with Amazon DocumentDB Streams](#) guide you through creating an Amazon DocumentDB cluster with all the necessary prerequisites.
- **Allow Lambda to access the Amazon Virtual Private Cloud (Amazon VPC) resources associated with your Amazon DocumentDB cluster.** For more information, see [Configure network security](#).
- **Enable TLS on your Amazon DocumentDB cluster.** This is the default setting. If you disable TLS, then Lambda cannot communicate with your cluster.
- **Activate change streams on your Amazon DocumentDB cluster.** For more information, see [Using Change Streams with Amazon DocumentDB](#) in the *Amazon DocumentDB Developer Guide*.
- **Provide Lambda with credentials to access your Amazon DocumentDB cluster.** When setting up the event source, provide the [AWS Secrets Manager](#) key that contains the authentication details (username and password) required to access your cluster. To provide this key during setup, do either of the following:
 - If you're using the Lambda console for setup, then provide the key in the **Secrets manager key** field.
 - If you're using the AWS Command Line Interface (AWS CLI) for setup, then provide this key in the `source-access-configurations` option. You can include this option with either the [create-event-source-mapping](#) command or the [update-event-source-mapping](#) command. For example:

```
aws lambda create-event-source-mapping \  
    ...  
    --source-access-configurations  
    '[{"Type":"BASIC_AUTH","URI":"arn:aws:secretsmanager:us-  
west-2:123456789012:secret:DocDBSecret-AbC4E6"}]' \  
    ...
```

- **Grant Lambda permissions to manage resources related to your Amazon DocumentDB stream.** Manually add the following permissions to your function's [execution role](#):
 - [rds:DescribeDBClusters](#)
 - [rds:DescribeDBClusterParameters](#)
 - [rds:DescribeDBSubnetGroups](#)
 - [ec2:CreateNetworkInterface](#)
 - [ec2:DescribeNetworkInterfaces](#)
 - [ec2:DescribeVpcs](#)
 - [ec2>DeleteNetworkInterface](#)
 - [ec2:DescribeSubnets](#)
 - [ec2:DescribeSecurityGroups](#)
 - [kms:Decrypt](#)
 - [secretsmanager:GetSecretValue](#)
- **Keep the size of Amazon DocumentDB change stream events that you send to Lambda under 6 MB.** Lambda supports payload sizes of up to 6 MB. If your change stream tries to send Lambda an event larger than 6 MB, then Lambda drops the message and emits the `OversizedRecordCount` metric. Lambda emits all metrics on a best-effort basis.

Note

While Lambda functions typically have a maximum timeout limit of 15 minutes, event source mappings for Amazon MSK, self-managed Apache Kafka, Amazon DocumentDB, and Amazon MQ for ActiveMQ and RabbitMQ only support functions with maximum timeout limits of 14 minutes. This constraint ensures that the event source mapping can properly handle function errors and retries.

Configure network security

To give Lambda full access to Amazon DocumentDB through your event source mapping, either your cluster must use a public endpoint (public IP address), or you must provide access to the Amazon VPC you created the cluster in.

When you use Amazon DocumentDB with Lambda, create [AWS PrivateLink VPC endpoints](#) that provide your function access to the resources in your Amazon VPC.

Note

AWS PrivateLink VPC endpoints are required for functions with event source mappings that use the default (on-demand) mode for event pollers. If your event source mapping uses [provisioned mode](#), you don't need to configure AWS PrivateLink VPC endpoints.

Create an endpoint to provide access to the following resources:

- Lambda — Create an endpoint for the Lambda service principal.
- AWS STS — Create an endpoint for the AWS STS in order for a service principal to assume a role on your behalf.
- Secrets Manager — If your cluster uses Secrets Manager to store credentials, create an endpoint for Secrets Manager.

Alternatively, configure a NAT gateway on each public subnet in the Amazon VPC. For more information, see [the section called “Internet access for VPC functions”](#).

When you create an event source mapping for Amazon DocumentDB, Lambda checks whether Elastic Network Interfaces (ENIs) are already present for the subnets and security groups configured for your Amazon VPC. If Lambda finds existing ENIs, it attempts to re-use them. Otherwise, Lambda creates new ENIs to connect to the event source and invoke your function.

Note

Lambda functions always run inside VPCs owned by the Lambda service. Your function's VPC configuration does not affect the event source mapping. Only the networking configuration of the event source's determines how Lambda connects to your event source.

Configure the security groups for the Amazon VPC containing your cluster. By default, Amazon DocumentDB uses the following ports: 27017.

- Inbound rules – Allow all traffic on the default cluster port for the security group associated with your event source.

- Outbound rules – Allow all traffic on port 443 for all destinations. Allow all traffic on the default cluster port for the security group associated with your event source.
- Amazon VPC endpoint inbound rules — If you are using an Amazon VPC endpoint, the security group associated with your Amazon VPC endpoint must allow inbound traffic on port 443 from the cluster security group.

If your cluster uses authentication, you can also restrict the endpoint policy for the Secrets Manager endpoint. To call the Secrets Manager API, Lambda uses your function role, not the Lambda service principal.

Example VPC endpoint policy — Secrets Manager endpoint

```
{
  "Statement": [
    {
      "Action": "secretsmanager:GetSecretValue",
      "Effect": "Allow",
      "Principal": {
        "AWS": [
          "arn:aws::iam::123456789012:role/my-role"
        ]
      },
      "Resource": "arn:aws::secretsmanager:us-west-2:123456789012:secret:my-secret"
    }
  ]
}
```

When you use Amazon VPC endpoints, AWS routes your API calls to invoke your function using the endpoint's Elastic Network Interface (ENI). The Lambda service principal needs to call `lambda:InvokeFunction` on any roles and functions that use those ENIs.

By default, Amazon VPC endpoints have open IAM policies that allow broad access to resources. Best practice is to restrict these policies to perform the needed actions using that endpoint. To ensure that your event source mapping is able to invoke your Lambda function, the VPC endpoint policy must allow the Lambda service principal to call `sts:AssumeRole` and `lambda:InvokeFunction`. Restricting your VPC endpoint policies to allow only API calls originating within your organization prevents the event source mapping from functioning properly, so `"Resource": "*" is required in these policies.`

The following example VPC endpoint policies show how to grant the required access to the Lambda service principal for the AWS STS and Lambda endpoints.

Example VPC Endpoint policy — AWS STS endpoint

```
{
  "Statement": [
    {
      "Action": "sts:AssumeRole",
      "Effect": "Allow",
      "Principal": {
        "Service": [
          "lambda.amazonaws.com"
        ]
      },
      "Resource": "*"
    }
  ]
}
```

Example VPC Endpoint policy — Lambda endpoint

```
{
  "Statement": [
    {
      "Action": "lambda:InvokeFunction",
      "Effect": "Allow",
      "Principal": {
        "Service": [
          "lambda.amazonaws.com"
        ]
      },
      "Resource": "*"
    }
  ]
}
```

Creating an Amazon DocumentDB event source mapping (console)

For a Lambda function to read from an Amazon DocumentDB cluster's change stream, create an [event source mapping](#). This section describes how to do this from the Lambda console. For AWS

SDK and AWS CLI instructions, see [the section called “Creating an Amazon DocumentDB event source mapping \(SDK or CLI\)”](#).

To create an Amazon DocumentDB event source mapping (console)

1. Open the [Functions page](#) of the Lambda console.
2. Choose the name of a function.
3. Under **Function overview**, choose **Add trigger**.
4. Under **Trigger configuration**, in the dropdown list, choose **DocumentDB**.
5. Configure the required options, and then choose **Add**.

Lambda supports the following options for Amazon DocumentDB event sources:

- **DocumentDB cluster** – Select an Amazon DocumentDB cluster.
- **Activate trigger** – Choose whether you want to activate the trigger immediately. If you select this check box, then your function immediately starts receiving traffic from the specified Amazon DocumentDB change stream upon creation of the event source mapping. We recommend that you clear the check box to create the event source mapping in a deactivated state for testing. After creation, you can activate the event source mapping at any time.
- **Database name** – Enter the name of a database within the cluster to consume.
- (Optional) **Collection name** – Enter the name of a collection within the database to consume. If you don't specify a collection, then Lambda listens to all events from each collection in the database.
- **Batch size** – Set the maximum number of messages to retrieve in a single batch, up to 10,000. The default batch size is 100.
- **Starting position** – Choose the position in the stream to start reading records from.
 - **Latest** – Process only new records that are added to the stream. Your function starts processing records only after Lambda finishes creating your event source. This means that some records may be dropped until your event source is created successfully.
 - **Trim horizon** – Process all records in the stream. Lambda uses the log retention duration of your cluster to determine where to start reading events from. Specifically, Lambda starts reading from `current_time - log_retention_duration`. Your change stream must already be active before this timestamp for Lambda to read all events properly.
 - **At timestamp** – Process records starting from a specific time. Your change stream must already be active before the specified timestamp for Lambda to read all events properly.

- **Authentication** – Choose the authentication method for accessing the brokers in your cluster.
 - **BASIC_AUTH** – With basic authentication, you must provide the Secrets Manager key that contains the credentials to access your cluster.
- **Secrets Manager key** – Choose the Secrets Manager key that contains the authentication details (username and password) required to access your Amazon DocumentDB cluster.
- (Optional) **Batch window** – Set the maximum amount of time in seconds to gather records before invoking your function, up to 300.
- (Optional) **Full document configuration** – For document update operations, choose what you want to send to the stream. The default value is `Default`, which means that for each change stream event, Amazon DocumentDB sends only a delta describing the changes made. For more information about this field, see [FullDocument](#) in the MongoDB Javadoc API documentation.
 - **Default** – Lambda sends only a partial document describing the changes made.
 - **UpdateLookup** – Lambda sends a delta describing the changes, along with a copy of the entire document.

Creating an Amazon DocumentDB event source mapping (SDK or CLI)

To create or manage an Amazon DocumentDB event source mapping with an [AWS SDK](#), you can use the following API operations:

- [CreateEventSourceMapping](#)
- [ListEventSourceMappings](#)
- [GetEventSourceMapping](#)
- [UpdateEventSourceMapping](#)
- [DeleteEventSourceMapping](#)

To create the event source mapping with the AWS CLI, use the [create-event-source-mapping](#) command. The following example uses this command to map a function named `my-function` to an Amazon DocumentDB change stream. The event source is specified by an Amazon Resource Name (ARN), with a batch size of 500, starting from the timestamp in Unix time. The command also specifies the Secrets Manager key that Lambda uses to connect to Amazon DocumentDB. Additionally, it includes `document-db-event-source-config` parameters that specify the database and the collection to read from.

```
aws lambda create-event-source-mapping --function-name my-function \  
  --event-source-arn arn:aws:rds:us-west-2:123456789012:cluster:privatecluster7de2-  
epzcyvu4pjjoy \  
  --batch-size 500 \  
  --starting-position AT_TIMESTAMP \  
  --starting-position-timestamp 1541139109 \  
  --source-access-configurations \  
  '[{"Type":"BASIC_AUTH","URI":"arn:aws:secretsmanager:us-  
east-1:123456789012:secret:DocDBSecret-BAtjxi"}]' \  
  --document-db-event-source-config '{"DatabaseName":"test_database",  
"CollectionName": "test_collection"}' \  

```

You should see output that looks like this:

```
{  
  "UUID": "2b733gdc-8ac3-cdf5-af3a-1827b3b11284",  
  "BatchSize": 500,  
  "DocumentDBEventSourceConfig": {  
    "CollectionName": "test_collection",  
    "DatabaseName": "test_database",  
    "FullDocument": "Default"  
  },  
  "MaximumBatchingWindowInSeconds": 0,  
  "EventSourceArn": "arn:aws:rds:us-west-2:123456789012:cluster:privatecluster7de2-  
epzcyvu4pjjoy",  
  "FunctionArn": "arn:aws:lambda:us-west-2:123456789012:function:my-function",  
  "LastModified": 1541348195.412,  
  "LastProcessingResult": "No records processed",  
  "State": "Creating",  
  "StateTransitionReason": "User action"  
}
```

After creation, you can use the [update-event-source-mapping](#) command to update the settings for your Amazon DocumentDB event source. The following example updates the batch size to 1,000 and the batch window to 10 seconds. For this command, you need the UUID of your event source mapping, which you can retrieve using the `list-event-source-mapping` command or the Lambda console.

```
aws lambda update-event-source-mapping --function-name my-function \  
  --uuid f89f8514-cdd9-4602-9e1f-01a5b77d449b \  
  --batch-size 1000 \  

```

```
--batch-window 10
```

You should see this output that looks like this:

```
{
  "UUID": "2b733gdc-8ac3-cdf5-af3a-1827b3b11284",
  "BatchSize": 500,
  "DocumentDBEventSourceConfig": {
    "CollectionName": "test_collection",
    "DatabaseName": "test_database",
    "FullDocument": "Default"
  },
  "MaximumBatchingWindowInSeconds": 0,
  "EventSourceArn": "arn:aws:rds:us-west-2:123456789012:cluster:privatecluster7de2-epzcyvu4pjoy",
  "FunctionArn": "arn:aws:lambda:us-west-2:123456789012:function:my-function",
  "LastModified": 1541359182.919,
  "LastProcessingResult": "OK",
  "State": "Updating",
  "StateTransitionReason": "User action"
}
```

Lambda updates settings asynchronously, so you may not see these changes in the output until the process completes. To view the current settings of your event source mapping, use the [get-event-source-mapping](#) command.

```
aws lambda get-event-source-mapping --uuid f89f8514-cdd9-4602-9e1f-01a5b77d449b
```

You should see this output that looks like this:

```
{
  "UUID": "2b733gdc-8ac3-cdf5-af3a-1827b3b11284",
  "DocumentDBEventSourceConfig": {
    "CollectionName": "test_collection",
    "DatabaseName": "test_database",
    "FullDocument": "Default"
  },
  "BatchSize": 1000,
  "MaximumBatchingWindowInSeconds": 10,
  "EventSourceArn": "arn:aws:rds:us-west-2:123456789012:cluster:privatecluster7de2-epzcyvu4pjoy",
  "FunctionArn": "arn:aws:lambda:us-west-2:123456789012:function:my-function",
}
```

```
"LastModified": 1541359182.919,  
"LastProcessingResult": "OK",  
"State": "Enabled",  
"StateTransitionReason": "User action"  
}
```

To delete your Amazon DocumentDB event source mapping, use the [delete-event-source-mapping](#) command.

```
aws lambda delete-event-source-mapping \  
  --uuid 2b733gdc-8ac3-cdf5-af3a-1827b3b11284
```

Polling and stream starting positions

Be aware that stream polling during event source mapping creation and updates is eventually consistent.

- During event source mapping creation, it may take several minutes to start polling events from the stream.
- During event source mapping updates, it may take several minutes to stop and restart polling events from the stream.

This behavior means that if you specify LATEST as the starting position for the stream, the event source mapping could miss events during creation or updates. To ensure that no events are missed, specify the stream starting position as TRIM_HORIZON or AT_TIMESTAMP.

Monitoring your Amazon DocumentDB event source

To help you monitor your Amazon DocumentDB event source, Lambda emits the `IteratorAge` metric when your function finishes processing a batch of records. *Iterator age* is the difference between the timestamp of the most recent event and the current timestamp. Essentially, the `IteratorAge` metric indicates how old the last processed record in the batch is. If your function is currently processing new events, then you can use the iterator age to estimate the latency between when a record is added and when your function processes it. An increasing trend in `IteratorAge` can indicate issues with your function. For more information, see [Using CloudWatch metrics with Lambda](#).

Amazon DocumentDB change streams aren't optimized to handle large time gaps between events. If your Amazon DocumentDB event source doesn't receive any events for an extended period of

time, Lambda may disable the event source mapping. The length of this time period can vary from a few weeks to a few months depending on cluster size and other workloads.

Lambda supports payloads of up to 6 MB. However, Amazon DocumentDB change stream events can be up to 16 MB in size. If your change stream tries to send Lambda a change stream event larger than 6 MB, then Lambda drops the message and emits the `OversizedRecordCount` metric. Lambda emits all metrics on a best-effort basis.

Tutorial: Using AWS Lambda with Amazon DocumentDB Streams

In this tutorial, you create a basic Lambda function that consumes events from an Amazon DocumentDB (with MongoDB compatibility) change stream. To complete this tutorial, you will go through the following stages:

- Set up your Amazon DocumentDB cluster, connect to it, and activate change streams on it.
- Create your Lambda function, and configure your Amazon DocumentDB cluster as an event source for your function.
- Test the end-to-end setup by inserting items into your Amazon DocumentDB database.

Topics

- [Prerequisites](#)
- [Create the AWS Cloud9 environment](#)
- [Create the Amazon EC2 security group](#)
- [Create the Amazon DocumentDB cluster](#)
- [Create the secret in Secrets Manager](#)
- [Install the mongo shell](#)
- [Connect to the Amazon DocumentDB cluster](#)
- [Activate change streams](#)
- [Create interface VPC endpoints](#)
- [Create the execution role](#)
- [Create the Lambda function](#)
- [Create the Lambda event source mapping](#)
- [Test your function - manual invoke](#)
- [Test your function - insert a record](#)
- [Test your function - update a record](#)

- [Test your function - delete a record](#)
- [Clean up your resources](#)

Prerequisites

Sign up for an AWS account

If you do not have an AWS account, complete the following steps to create one.

To sign up for an AWS account

1. Open <https://portal.aws.amazon.com/billing/signup>.
2. Follow the online instructions.

Part of the sign-up procedure involves receiving a phone call and entering a verification code on the phone keypad.

When you sign up for an AWS account, an *AWS account root user* is created. The root user has access to all AWS services and resources in the account. As a security best practice, assign administrative access to a user, and use only the root user to perform [tasks that require root user access](#).

AWS sends you a confirmation email after the sign-up process is complete. At any time, you can view your current account activity and manage your account by going to <https://aws.amazon.com/> and choosing **My Account**.

Create a user with administrative access

After you sign up for an AWS account, secure your AWS account root user, enable AWS IAM Identity Center, and create an administrative user so that you don't use the root user for everyday tasks.

Secure your AWS account root user

1. Sign in to the [AWS Management Console](#) as the account owner by choosing **Root user** and entering your AWS account email address. On the next page, enter your password.

For help signing in by using root user, see [Signing in as the root user](#) in the *AWS Sign-In User Guide*.

2. Turn on multi-factor authentication (MFA) for your root user.

For instructions, see [Enable a virtual MFA device for your AWS account root user \(console\)](#) in the *IAM User Guide*.

Create a user with administrative access

1. Enable IAM Identity Center.

For instructions, see [Enabling AWS IAM Identity Center](#) in the *AWS IAM Identity Center User Guide*.

2. In IAM Identity Center, grant administrative access to a user.

For a tutorial about using the IAM Identity Center directory as your identity source, see [Configure user access with the default IAM Identity Center directory](#) in the *AWS IAM Identity Center User Guide*.

Sign in as the user with administrative access

- To sign in with your IAM Identity Center user, use the sign-in URL that was sent to your email address when you created the IAM Identity Center user.

For help signing in using an IAM Identity Center user, see [Signing in to the AWS access portal](#) in the *AWS Sign-In User Guide*.

Assign access to additional users

1. In IAM Identity Center, create a permission set that follows the best practice of applying least-privilege permissions.

For instructions, see [Create a permission set](#) in the *AWS IAM Identity Center User Guide*.

2. Assign users to a group, and then assign single sign-on access to the group.

For instructions, see [Add groups](#) in the *AWS IAM Identity Center User Guide*.

Install the AWS Command Line Interface

If you have not yet installed the AWS Command Line Interface, follow the steps at [Installing or updating the latest version of the AWS CLI](#) to install it.

The tutorial requires a command line terminal or shell to run commands. In Linux and macOS, use your preferred shell and package manager.

Note

In Windows, some Bash CLI commands that you commonly use with Lambda (such as `zip`) are not supported by the operating system's built-in terminals. To get a Windows-integrated version of Ubuntu and Bash, [install the Windows Subsystem for Linux](#).

Create the AWS Cloud9 environment

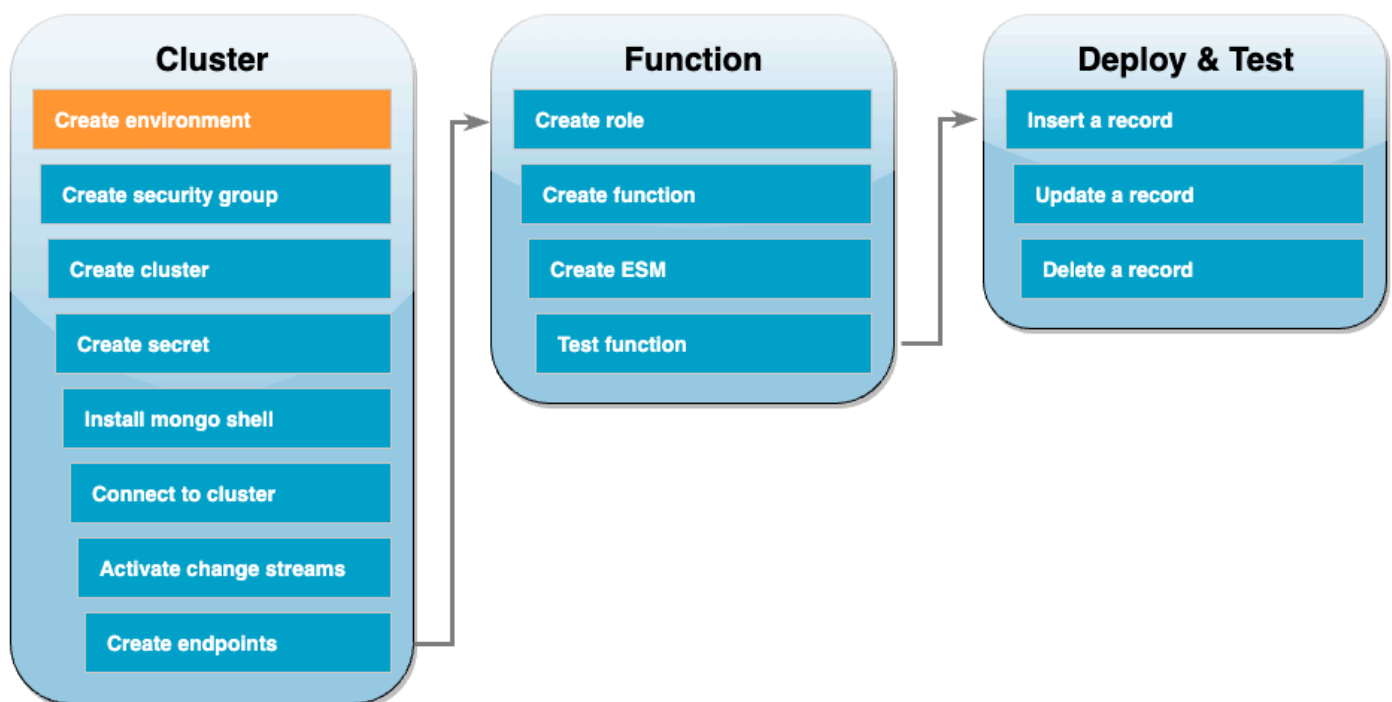

Before creating the Lambda function, you need to create and configure your Amazon DocumentDB cluster. The steps to set up your cluster in this tutorial is based on the procedure in [Get Started with Amazon DocumentDB](#).

Note

If you already have an Amazon DocumentDB cluster set up, ensure that you activate change streams and create the necessary interface VPC endpoints. Then, you can skip directly to the function creation steps.

First, create an AWS Cloud9 environment. You'll use this environment throughout this tutorial to connect to and query your Amazon DocumentDB cluster.

To create an AWS Cloud9 environment

1. Open the [AWS Cloud9 console](#) and choose **Create environment**.
2. Create an environment with the following configuration:
 - Under **Details**:
 - **Name**: DocumentDBCloud9Environment
 - **Environment type**: New EC2 instance
 - Under **New EC2 instance**:
 - **Instance type**: t2.micro (1 GiB RAM + 1 vCPU)
 - **Platform**: Amazon Linux 2
 - **Timeout**: 30 minutes
 - Under **Network settings**:
 - **Connection**: AWS Systems Manager (SSM)
 - Expand the **VPC settings** dropdown.
 - **Amazon Virtual Private Cloud (VPC)**: Choose your [default VPC](#).
 - **Subnet**: No preference
 - Keep all other default settings.
3. Choose **Create**. Provisioning your new AWS Cloud9 environment can take several minutes.

Create the Amazon EC2 security group

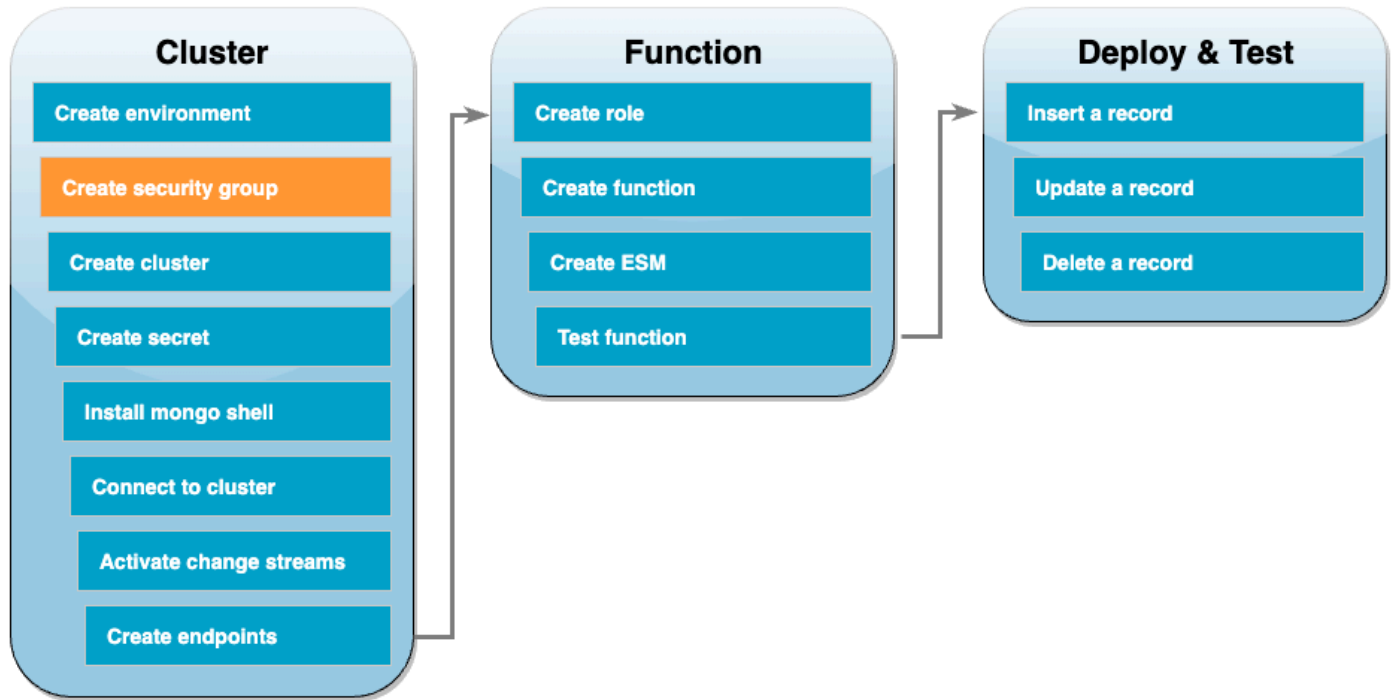

Next, create an [Amazon EC2 security group](#) with rules that allow traffic between your Amazon DocumentDB cluster and your AWS Cloud9 environment.

To create an EC2 security group

1. Open the [EC2 console](#). Under **Network and Security**, choose **Security groups**.
2. Choose **Create security group**.
3. Create a security group with the following configuration:
 - Under **Basic details**:
 - **Security group name**: DocDBTutorial
 - **Description**: Security group for traffic between AWS Cloud9 and Amazon DocumentDB.
 - **VPC**: Choose your [default VPC](#).
 - Under **Inbound rules**, choose **Add rule**. Create a rule with the following configuration:
 - **Type**: Custom TCP
 - **Port range**: 27017
 - **Source**: Custom

- In the search box next to **Source**, choose the security group for the AWS Cloud9 environment you created in the previous step. To see a list of available security groups, enter `c9cloud9` in the search box. Choose the security group with the name `aws-c9cloud9-
<environment_name>`.
 - Keep all other default settings.
4. Choose **Create security group**.

Create the Amazon DocumentDB cluster

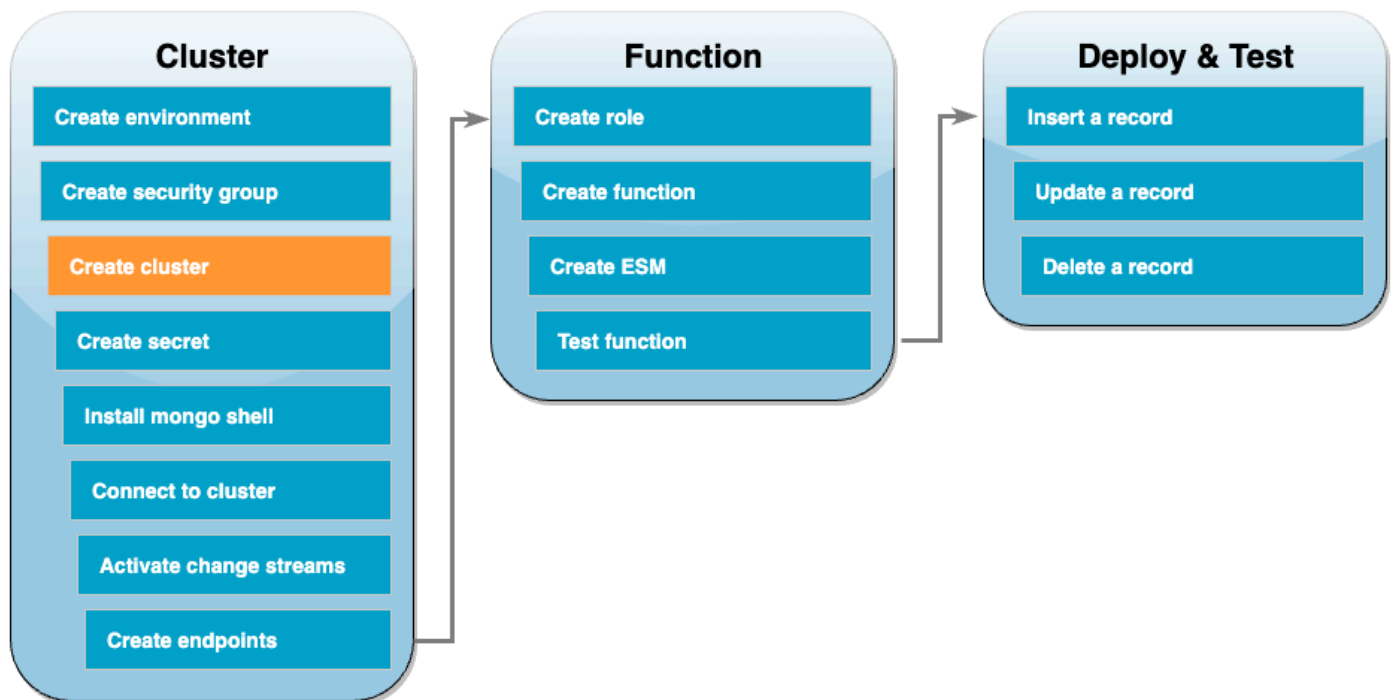

In this step, you'll create an Amazon DocumentDB cluster using the security group from the previous step.

To create an Amazon DocumentDB cluster

1. Open the [Amazon DocumentDB console](#). Under **Clusters**, choose **Create**.
2. Create a cluster with the following configuration:
 - For **Cluster type**, choose Instance Based Cluster.
 - Under **Configuration**:
 - **Engine version**: 5.0.0

- **Instance class:** db.t3.medium (free trial eligible)
 - **Number of instances:** 1
 - Under **Authentication:**
 - Enter the **Username** and **Password** needed to connect to your cluster (same credentials as you used to create the secret in the previous step). In **Confirm password**, confirm your password.
 - Toggle on **Show advanced settings**.
 - Under **Network settings:**
 - **Virtual Private Cloud (VPC):** Choose your [default VPC](#).
 - **Subnet group:** default
 - **VPC security groups:** In addition to default (VPC), choose the DocDBTutorial (VPC) security group you created in the previous step.
 - Keep all other default settings.
3. Choose **Create cluster**. Provisioning your Amazon DocumentDB cluster can take several minutes.

Create the secret in Secrets Manager

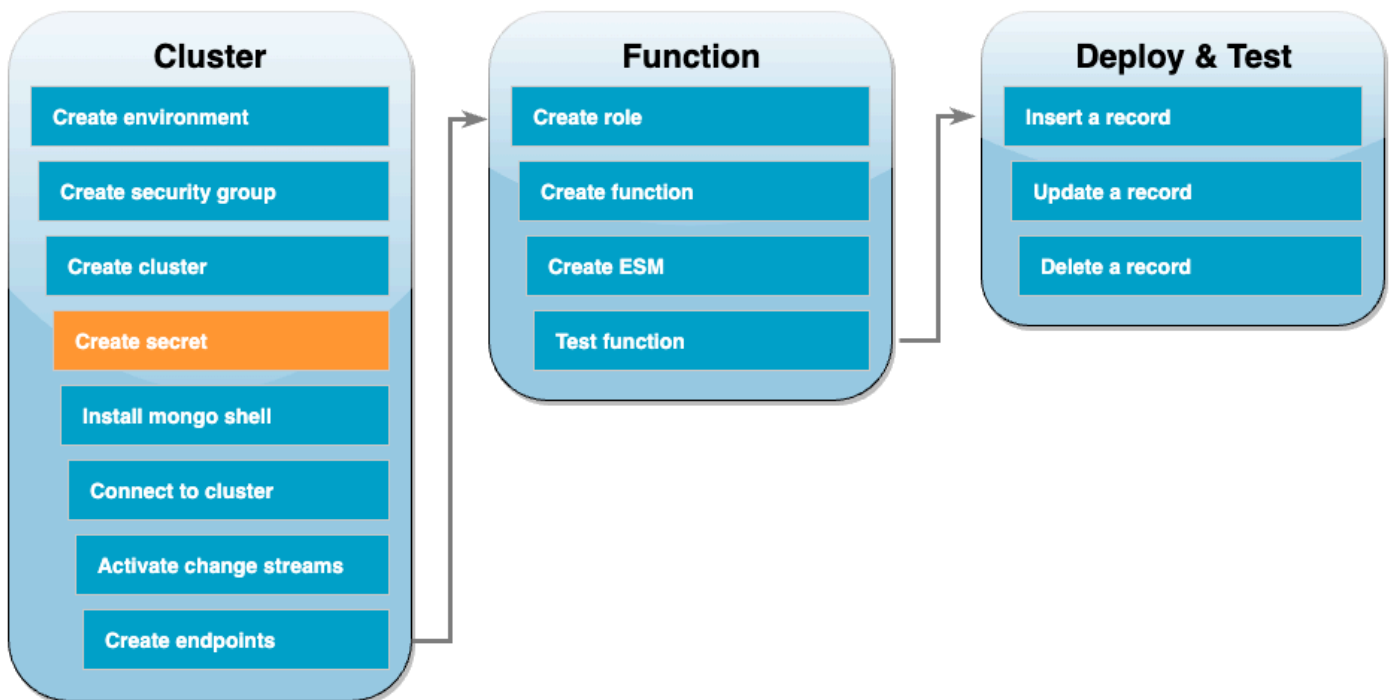

To access your Amazon DocumentDB cluster manually, you must provide username and password credentials. For Lambda to access your cluster, you must provide a Secrets Manager secret that contains these same access credentials when setting up your event source mapping. In this step, you'll create this secret.

To create the secret in Secrets Manager

1. Open the [Secrets Manager](#) console and choose **Store a new secret**.
2. For **Choose secret type**, choose the following options:
 - Under **Basic details**:
 - **Secret type**: Credentials for your Amazon DocumentDB database
 - Under **Credentials**, enter the username and password you'll use to access your Amazon DocumentDB cluster.
 - **Database**: Choose your Amazon DocumentDB cluster.
 - Choose **Next**.
3. For **Configure secret**, choose the following options:
 - **Secret name**– DocumentDBSecret
 - Choose **Next**.
4. Choose **Next**.
5. Choose **Store**.
6. Refresh the console to verify that you successfully stored the DocumentDBSecret secret.

Note down the **Secret ARN** of your secret. You'll need it in a later step.

Install the mongo shell

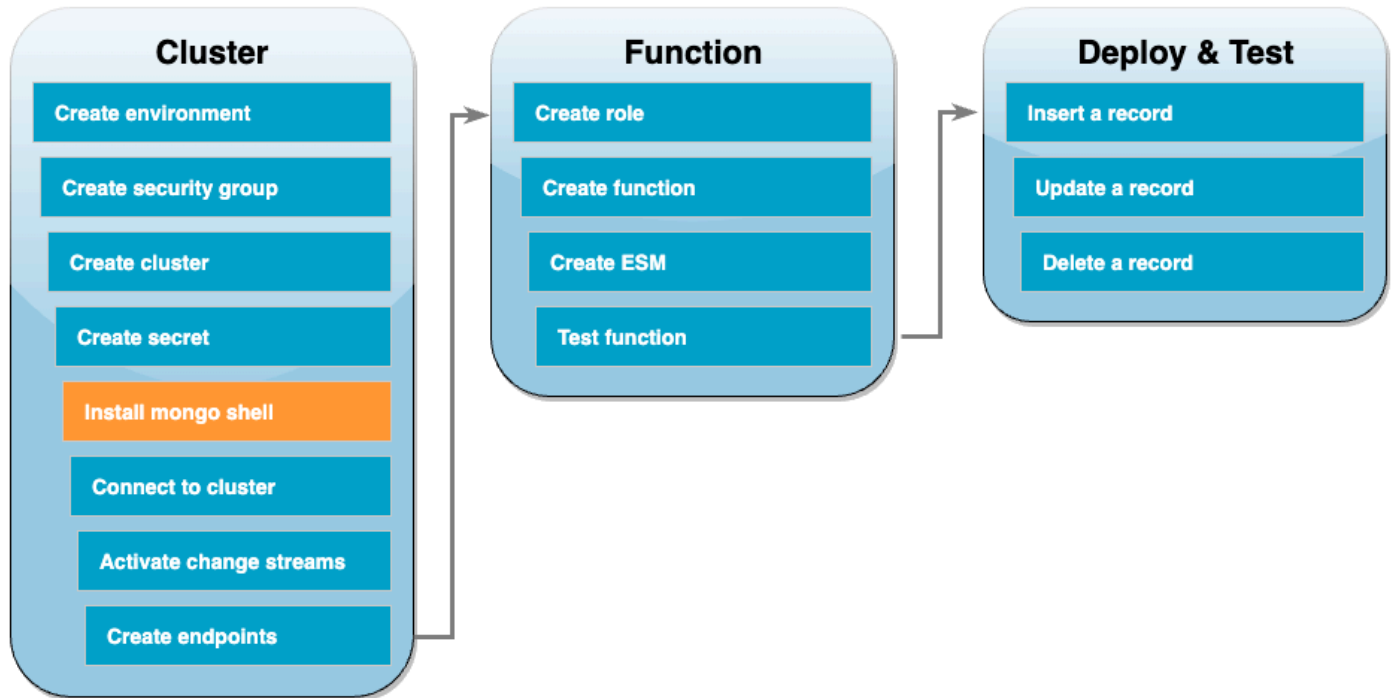

In this step, you'll install the mongo shell in your AWS Cloud9 environment. The mongo shell is a command-line utility that you use to connect to and query your Amazon DocumentDB cluster.

To install the mongo shell on your AWS Cloud9 environment

1. Open the [AWS Cloud9 console](#). Next to the DocumentDBCloud9Environment environment you created earlier, click on the **Open** link under the **AWS Cloud9 IDE** column.
2. In the terminal window, create the MongoDB repository file with the following command:

```
echo -e "[mongodb-org-5.0] \nname=MongoDB Repository\nbaseurl=https://
repo.mongodb.org/yum/amazon/2/mongodb-org/5.0/x86_64/\npgpcheck=1 \nenabled=1
\npgpkey=https://www.mongodb.org/static/pgp/server-5.0.asc" | sudo tee /etc/
yum.repos.d/mongodb-org-5.0.repo
```

3. Then, install the mongo shell with the following command:

```
sudo yum install -y mongodb-org-shell
```

4. To encrypt data in transit, download the [public key for Amazon DocumentDB](#). The following command downloads a file named `global-bundle.pem`:

```
wget https://truststore.pki.rds.amazonaws.com/global/global-bundle.pem
```

Connect to the Amazon DocumentDB cluster

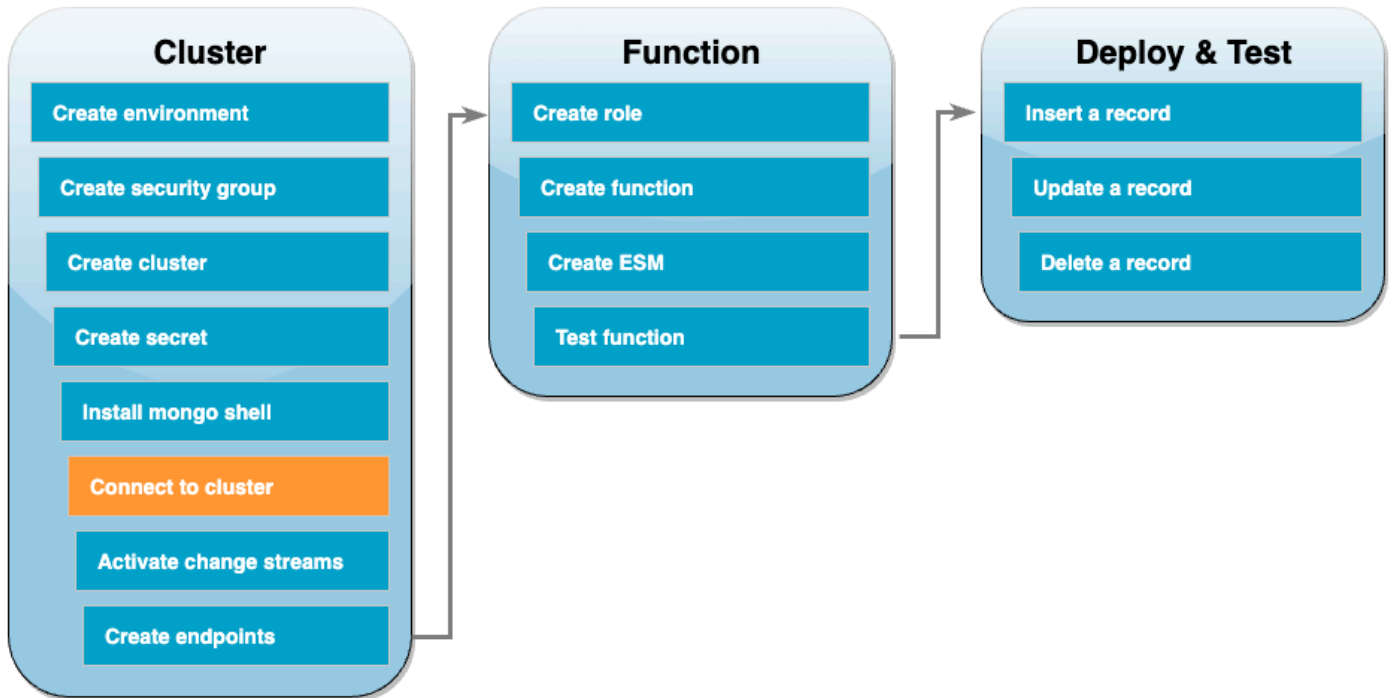

You're now ready to connect to your Amazon DocumentDB cluster using the mongo shell.

To connect to your Amazon DocumentDB cluster

1. Open the [Amazon DocumentDB console](#). Under **Clusters**, choose your cluster by choosing its cluster identifier.
2. In the **Connectivity & security** tab, under **Connect to this cluster with the mongo shell**, choose **Copy**.
3. In your AWS Cloud9 environment, paste this command into the terminal. Replace `<insertYourPassword>` with the correct password.

After entering this command, if the command prompt becomes `rs0:PRIMARY>`, then you're connected to your Amazon DocumentDB cluster.

Activate change streams

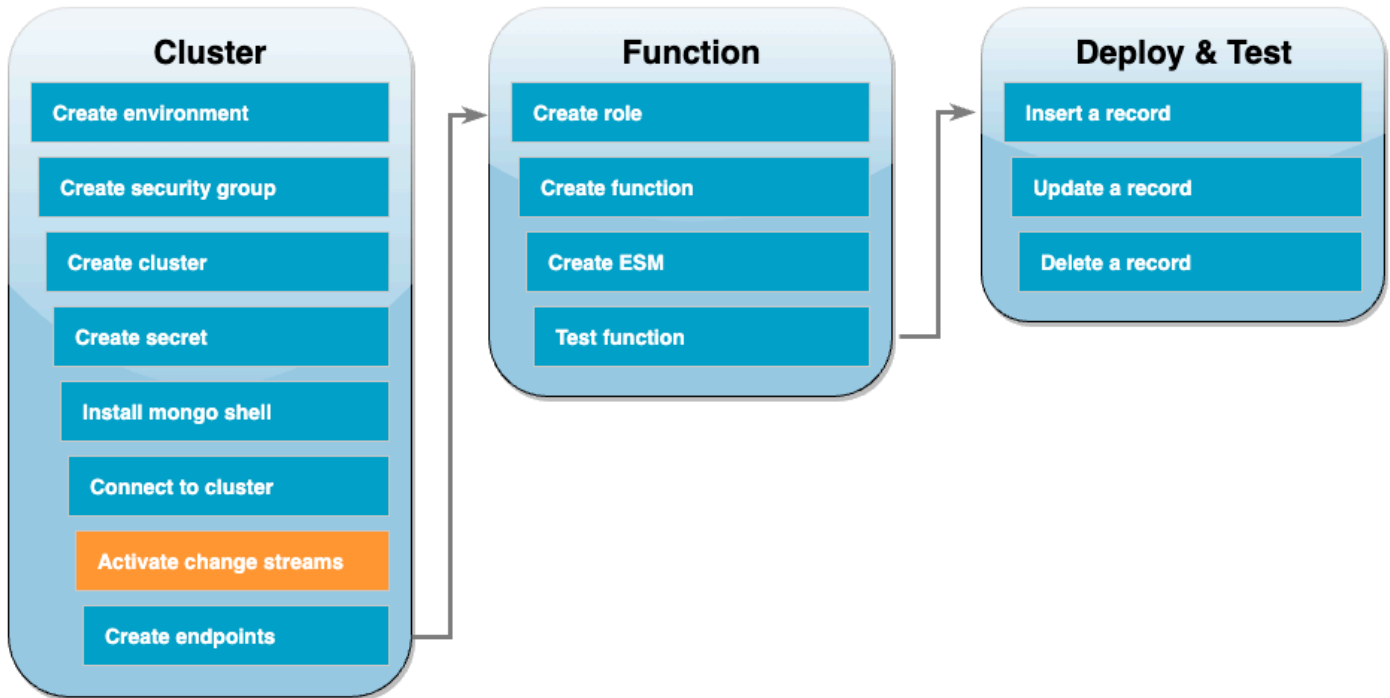

For this tutorial, you'll track changes to the `products` collection of the `docdbdemo` database in your Amazon DocumentDB cluster. You do this by activating [change streams](#). First, create the `docdbdemo` database and test it by inserting a record.

To create a new database within your cluster

1. In your AWS Cloud9 environment, ensure that you're still [connected to your Amazon DocumentDB cluster](#).
2. In the terminal window, use the following command to create a new database called `docdbdemo`:

```
use docdbdemo
```

3. Then, use the following command to insert a record into `docdbdemo`:

```
db.products.insert({"hello":"world"})
```

You should see output that looks like this:

```
WriteResult({ "nInserted" : 1 })
```

4. Use the following command to list all databases:

```
show dbs
```

Ensure that your output contains the docdbdemo database:

```
docdbdemo 0.000GB
```

Next, activate change streams on the `products` collection of the `docdbdemo` database using the following command:

```
db.adminCommand({modifyChangeStreams: 1,  
  database: "docdbdemo",  
  collection: "products",  
  enable: true});
```

You should see output that looks like this:

```
{ "ok" : 1, "operationTime" : Timestamp(1680126165, 1) }
```

Create interface VPC endpoints

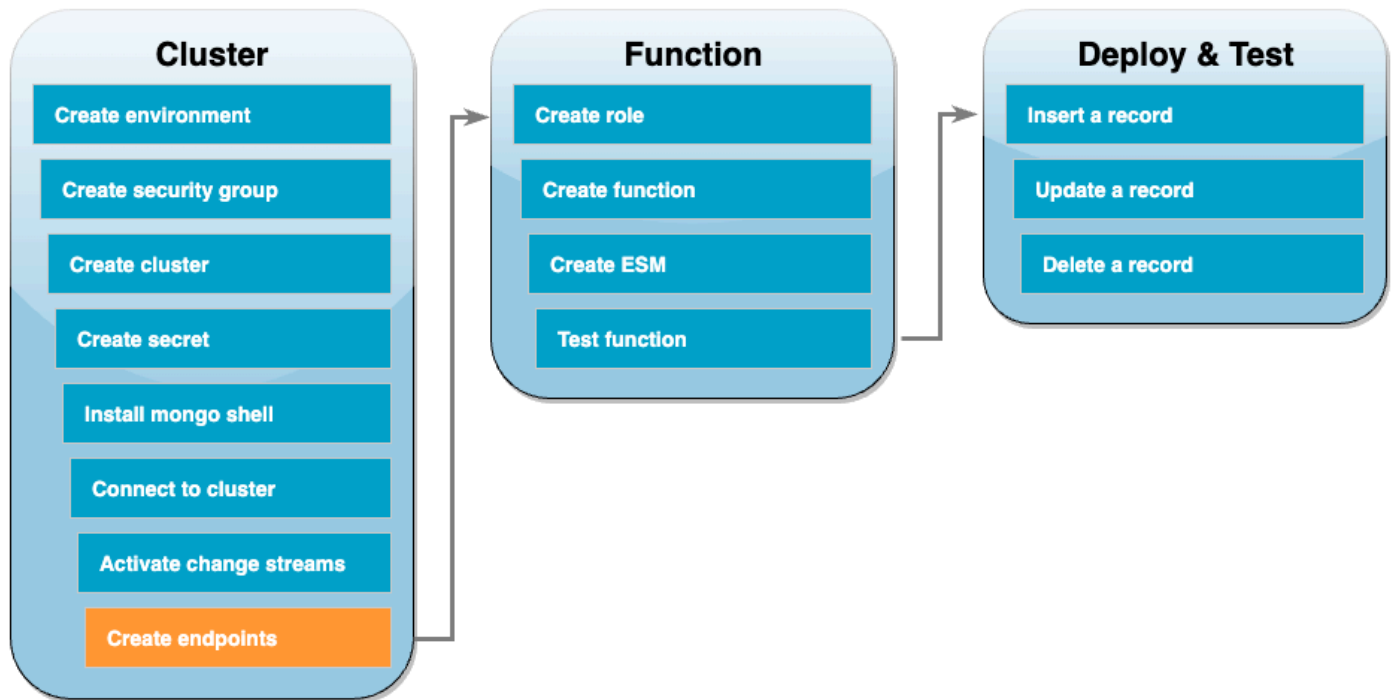

Next, create [interface VPC endpoints](#) to ensure that Lambda and Secrets Manager (used later to store our cluster access credentials) can connect to your default VPC.

To create interface VPC endpoints

1. Open the [VPC console](#). In the left menu, under **Virtual private cloud**, choose **Endpoints**.
2. Choose **Create endpoint**. Create an endpoint with the following configuration:
 - For **Name tag**, enter `lambda-default-vpc`.
 - For **Service category**, choose AWS services.
 - For **Services**, enter `lambda` in the search box. Choose the service with format `com.amazonaws.<region>.lambda`.
 - For **VPC**, choose your [default VPC](#).
 - For **Subnets**, check the boxes next to each availability zone. Choose the correct subnet ID for each availability zone.
 - For **IP address type**, select IPv4.
 - For **Security groups**, choose the default VPC security group (Group name of `default`), and the security group you created earlier (Group name of `DocDBTutorial`).

- Keep all other default settings.
 - Choose **Create endpoint**.
3. Again, choose **Create endpoint**. Create an endpoint with the following configuration:
- For **Name tag**, enter `secretsmanager-default-vpc`.
 - For **Service category**, choose AWS services.
 - For **Services**, enter `secretsmanager` in the search box. Choose the service with format `com.amazonaws.<region>.secretsmanager`.
 - For **VPC**, choose your [default VPC](#).
 - For **Subnets**, check the boxes next to each availability zone. Choose the correct subnet ID for each availability zone.
 - For **IP address type**, select IPv4.
 - For **Security groups**, choose the default VPC security group (Group name of `default`), and the security group you created earlier (Group name of `DocDBTutorial`).
 - Keep all other default settings.
 - Choose **Create endpoint**.

This completes the cluster setup portion of this tutorial.

Create the execution role

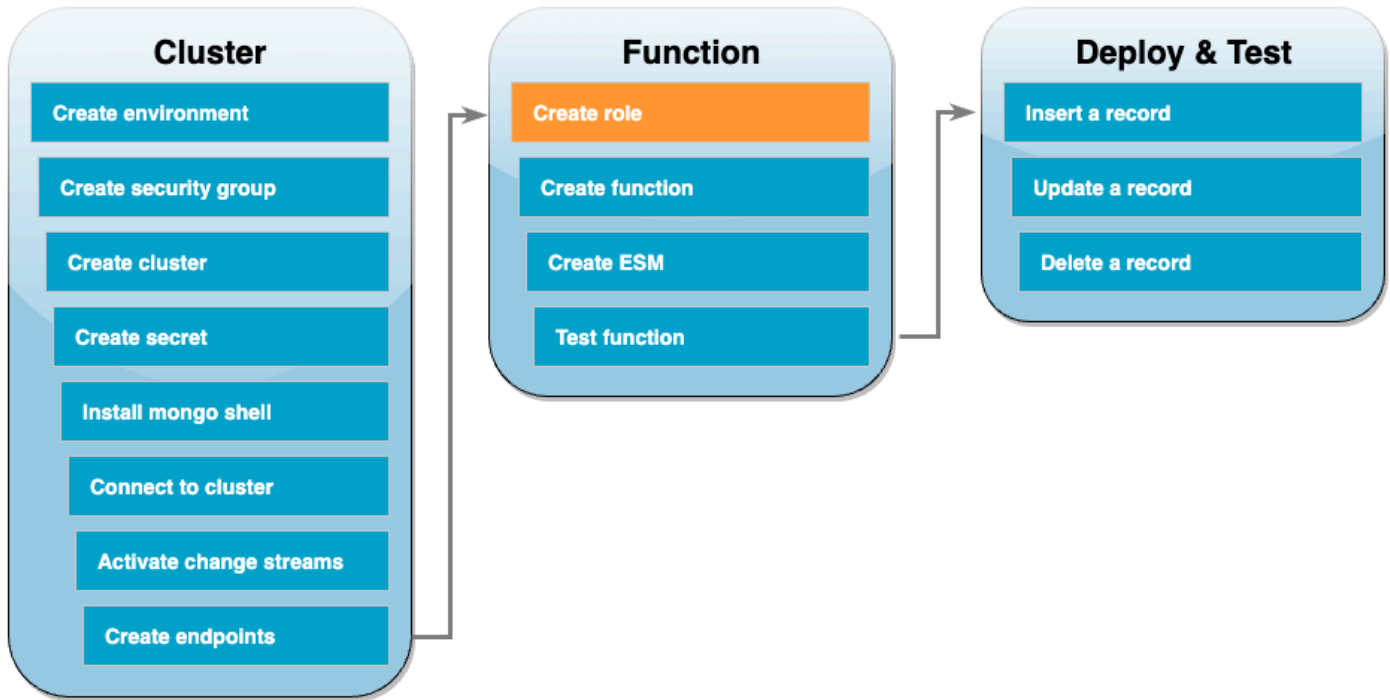

In the next set of steps, you'll create your Lambda function. First, you need to create the execution role that gives your function permission to access your cluster. You do this by creating an IAM policy first, then attaching this policy to an IAM role.

To create IAM policy

1. Open the [Policies page](#) in the IAM console and choose **Create policy**.
2. Choose the **JSON** tab. In the following policy, replace the Secrets Manager resource ARN in the final line of the statement with your secret ARN from earlier, and copy the policy into the editor.

```

{
  "Version": "2012-10-17",
  "Statement": [
    {
      "Sid": "LambdaESMNetworkingAccess",
      "Effect": "Allow",
      "Action": [
        "ec2:CreateNetworkInterface",
        "ec2:DescribeNetworkInterfaces",
        "ec2:DescribeVpcs",

```

```

        "ec2:DeleteNetworkInterface",
        "ec2:DescribeSubnets",
        "ec2:DescribeSecurityGroups",
        "kms:Decrypt"
    ],
    "Resource": "*"
},
{
    "Sid": "LambdaDocDBESMAccess",
    "Effect": "Allow",
    "Action": [
        "rds:DescribeDBClusters",
        "rds:DescribeDBClusterParameters",
        "rds:DescribeDBSubnetGroups"
    ],
    "Resource": "*"
},
{
    "Sid": "LambdaDocDBESMGetSecretValueAccess",
    "Effect": "Allow",
    "Action": [
        "secretsmanager:GetSecretValue"
    ],
    "Resource": "arn:aws:secretsmanager:us-
east-1:123456789012:secret:DocumentDBSecret"
}
]
}

```

3. Choose **Next: Tags**, then choose **Next: Review**.
4. For **Name**, enter `AWSDocumentDBLambdaPolicy`.
5. Choose **Create policy**.

To create the IAM role

1. Open the [Roles page](#) in the IAM console and choose **Create role**.
2. For **Select trusted entity**, choose the following options:
 - **Trusted entity type**– AWS service
 - **Use case**– Lambda
 - Choose **Next**.

3. For **Add permissions**, choose the `AWSDocumentDBLambdaPolicy` policy you just created, as well as the `AWSLambdaBasicExecutionRole` to give your function permissions to write to Amazon CloudWatch Logs.
4. Choose **Next**.
5. For **Role name**, enter `AWSDocumentDBLambdaExecutionRole`.
6. Choose **Create role**.

Create the Lambda function

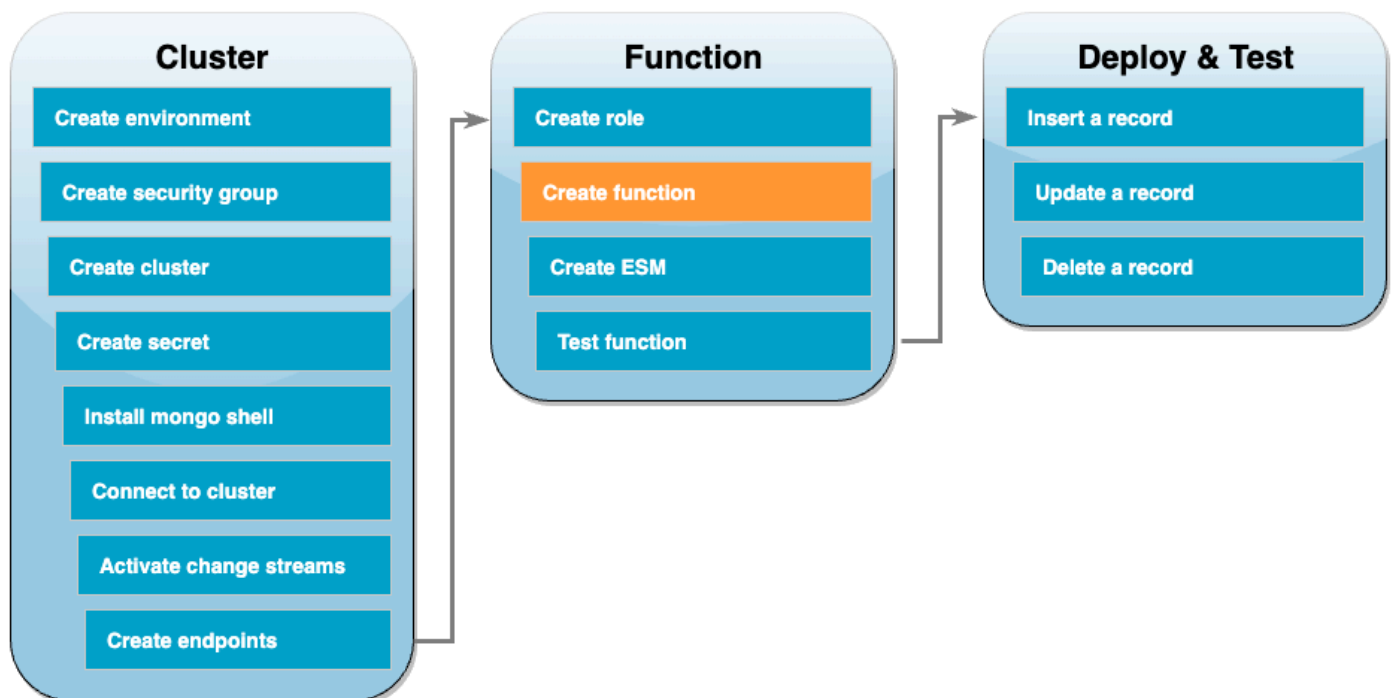

The following example code receives an Amazon DocumentDB event input and processes the message that it contains.

.NET

AWS SDK for .NET

Note

There's more on GitHub. Find the complete example and learn how to set up and run in the [Serverless examples](#) repository.

Consuming a Amazon DocumentDB event with Lambda using .NET.

```
using Amazon.Lambda.Core;
using System.Text.Json;
using System;
using System.Collections.Generic;
using System.Text.Json.Serialization;
//Assembly attribute to enable the Lambda function's JSON input to be converted
into a .NET class.
[assembly:
    LambdaSerializer(typeof(Amazon.Lambda.Serialization.SystemTextJson.DefaultLambdaJsonSerializer))]

namespace LambdaDocDb;

public class Function
{
    /// <summary>
    /// Lambda function entry point to process Amazon DocumentDB events.
    /// </summary>
    /// <param name="event">The Amazon DocumentDB event.</param>
    /// <param name="context">The Lambda context object.</param>
    /// <returns>A string to indicate successful processing.</returns>
    public string FunctionHandler(Event evnt, ILambdaContext context)
    {
        foreach (var record in evnt.Events)
        {
            ProcessDocumentDBEvent(record, context);
        }

        return "OK";
    }

    private void ProcessDocumentDBEvent(DocumentDBEventRecord record,
        ILambdaContext context)
    {
        var eventData = record.Event;
        var operationType = eventData.OperationType;
        var databaseName = eventData.Ns.Db;
        var collectionName = eventData.Ns.Coll;
        var fullDocument = JsonSerializer.Serialize(eventData.FullDocument, new
        JsonSerializerOptions { WriteIndented = true });
    }
}
```



```
context.Logger.LogLine($"Operation type: {operationType}");
context.Logger.LogLine($"Database: {databaseName}");
context.Logger.LogLine($"Collection: {collectionName}");
context.Logger.LogLine($"Full document:\n{fullDocument}");
}

public class Event
{
    [JsonPropertyName("eventSourceArn")]
    public string EventSourceArn { get; set; }

    [JsonPropertyName("events")]
    public List<DocumentDBEventRecord> Events { get; set; }

    [JsonPropertyName("eventSource")]
    public string EventSource { get; set; }
}

public class DocumentDBEventRecord
{
    [JsonPropertyName("event")]
    public EventData Event { get; set; }
}

public class EventData
{
    [JsonPropertyName("_id")]
    public IdData Id { get; set; }

    [JsonPropertyName("clusterTime")]
    public ClusterTime ClusterTime { get; set; }

    [JsonPropertyName("documentKey")]
    public DocumentKey DocumentKey { get; set; }

    [JsonPropertyName("fullDocument")]
    public Dictionary<string, object> FullDocument { get; set; }

    [JsonPropertyName("ns")]
    public Namespace Ns { get; set; }
}
```

```
        [JsonPropertyName("operationType")]
        public string OperationType { get; set; }
    }

    public class IdData
    {
        [JsonPropertyName("_data")]
        public string Data { get; set; }
    }

    public class ClusterTime
    {
        [JsonPropertyName("$timestamp")]
        public Timestamp Timestamp { get; set; }
    }

    public class Timestamp
    {
        [JsonPropertyName("t")]
        public long T { get; set; }

        [JsonPropertyName("i")]
        public int I { get; set; }
    }

    public class DocumentKey
    {
        [JsonPropertyName("_id")]
        public Id Id { get; set; }
    }

    public class Id
    {
        [JsonPropertyName("$oid")]
        public string Oid { get; set; }
    }

    public class Namespace
    {
        [JsonPropertyName("db")]
        public string Db { get; set; }

        [JsonPropertyName("coll")]
        public string Coll { get; set; }
    }
}
```

```
}  
}
```

Go

SDK for Go V2

Note

There's more on GitHub. Find the complete example and learn how to set up and run in the [Serverless examples](#) repository.

Consuming a Amazon DocumentDB event with Lambda using Go.

```
package main  
  
import (  
    "context"  
    "encoding/json"  
    "fmt"  
  
    "github.com/aws/aws-lambda-go/lambda"  
)  
  
type Event struct {  
    Events []Record `json:"events"`  
}  
  
type Record struct {  
    Event struct {  
        OperationType string `json:"operationType"`  
        NS              struct {  
            DB string `json:"db"`  
            Coll string `json:"coll"`  
        } `json:"ns"`  
        FullDocument interface{} `json:"fullDocument"`  
    } `json:"event"`  
}
```

```
func main() {
    lambda.Start(handler)
}

func handler(ctx context.Context, event Event) (string, error) {
    fmt.Println("Loading function")
    for _, record := range event.Events {
        logDocumentDBEvent(record)
    }

    return "OK", nil
}

func logDocumentDBEvent(record Record) {
    fmt.Printf("Operation type: %s\n", record.Event.OperationType)
    fmt.Printf("db: %s\n", record.Event.NS.DB)
    fmt.Printf("collection: %s\n", record.Event.NS.Coll)
    docBytes, _ := json.MarshalIndent(record.Event.FullDocument, "", " ")
    fmt.Printf("Full document: %s\n", string(docBytes))
}
```

Java

SDK for Java 2.x

Note

There's more on GitHub. Find the complete example and learn how to set up and run in the [Serverless examples](#) repository.

Consuming a Amazon DocumentDB event with Lambda using Java.

```
import java.util.List;
import java.util.Map;

import com.amazonaws.services.lambda.runtime.Context;
import com.amazonaws.services.lambda.runtime.RequestHandler;

public class Example implements RequestHandler<Map<String, Object>, String> {
```

```
@SuppressWarnings("unchecked")
@Override
public String handleRequest(Map<String, Object> event, Context context) {
    List<Map<String, Object>> events = (List<Map<String, Object>>)
event.get("events");
    for (Map<String, Object> record : events) {
        Map<String, Object> eventData = (Map<String, Object>)
record.get("event");
        processEventData(eventData);
    }

    return "OK";
}

@SuppressWarnings("unchecked")
private void processEventData(Map<String, Object> eventData) {
    String operationType = (String) eventData.get("operationType");
    System.out.println("operationType: %s".formatted(operationType));

    Map<String, Object> ns = (Map<String, Object>) eventData.get("ns");

    String db = (String) ns.get("db");
    System.out.println("db: %s".formatted(db));
    String coll = (String) ns.get("coll");
    System.out.println("coll: %s".formatted(coll));

    Map<String, Object> fullDocument = (Map<String, Object>)
eventData.get("fullDocument");
    System.out.println("fullDocument: %s".formatted(fullDocument));
}
}
```

JavaScript

SDK for JavaScript (v3)

Note

There's more on GitHub. Find the complete example and learn how to set up and run in the [Serverless examples](#) repository.

Consuming a Amazon DocumentDB event with Lambda using JavaScript.

```
console.log('Loading function');
exports.handler = async (event, context) => {
  event.events.forEach(record => {
    logDocumentDBEvent(record);
  });
  return 'OK';
};

const logDocumentDBEvent = (record) => {
  console.log('Operation type: ' + record.event.operationType);
  console.log('db: ' + record.event.ns.db);
  console.log('collection: ' + record.event.ns.coll);
  console.log('Full document:', JSON.stringify(record.event.fullDocument, null,
    2));
};
```

Consuming a Amazon DocumentDB event with Lambda using TypeScript

```
import { DocumentDBEventRecord, DocumentDBEventSubscriptionContext } from 'aws-lambda';

console.log('Loading function');

export const handler = async (
  event: DocumentDBEventSubscriptionContext,
  context: any
): Promise<string> => {
  event.events.forEach((record: DocumentDBEventRecord) => {
```

```
        logDocumentDBEvent(record);
    });
    return 'OK';
};

const logDocumentDBEvent = (record: DocumentDBEventRecord): void => {
    console.log('Operation type: ' + record.event.operationType);
    console.log('db: ' + record.event.ns.db);
    console.log('collection: ' + record.event.ns.coll);
    console.log('Full document:', JSON.stringify(record.event.fullDocument, null,
        2));
};
```

PHP

SDK for PHP

Note

There's more on GitHub. Find the complete example and learn how to set up and run in the [Serverless examples](#) repository.

Consuming a Amazon DocumentDB event with Lambda using PHP.

```
<?php

require __DIR__.'./vendor/autoload.php';

use Bref\Context\Context;
use Bref\Event\Handler;

class DocumentDBEventHandler implements Handler
{
    public function handle($event, Context $context): string
    {
        $events = $event['events'] ?? [];
        foreach ($events as $record) {
            $this->logDocumentDBEvent($record['event']);
        }
    }
}
```

```
        return 'OK';
    }

    private function logDocumentDBEvent($event): void
    {
        // Extract information from the event record

        $operationType = $event['operationType'] ?? 'Unknown';
        $db = $event['ns']['db'] ?? 'Unknown';
        $collection = $event['ns']['coll'] ?? 'Unknown';
        $fullDocument = $event['fullDocument'] ?? [];

        // Log the event details

        echo "Operation type: $operationType\n";
        echo "Database: $db\n";
        echo "Collection: $collection\n";
        echo "Full document: " . json_encode($fullDocument, JSON_PRETTY_PRINT) .
"\n";
    }
}
return new DocumentDBEventHandler();
```

Python

SDK for Python (Boto3)

Note

There's more on GitHub. Find the complete example and learn how to set up and run in the [Serverless examples](#) repository.

Consuming a Amazon DocumentDB event with Lambda using Python.

```
import json

def lambda_handler(event, context):
    for record in event.get('events', []):
        log_document_db_event(record)
    return 'OK'
```



```
def log_document_db_event(record):
    event_data = record.get('event', {})
    operation_type = event_data.get('operationType', 'Unknown')
    db = event_data.get('ns', {}).get('db', 'Unknown')
    collection = event_data.get('ns', {}).get('coll', 'Unknown')
    full_document = event_data.get('fullDocument', {})

    print(f"Operation type: {operation_type}")
    print(f"db: {db}")
    print(f"collection: {collection}")
    print("Full document:", json.dumps(full_document, indent=2))
```

Ruby

SDK for Ruby

Note

There's more on GitHub. Find the complete example and learn how to set up and run in the [Serverless examples](#) repository.

Consuming a Amazon DocumentDB event with Lambda using Ruby.

```
require 'json'

def lambda_handler(event:, context:)
  event['events'].each do |record|
    log_document_db_event(record)
  end
  'OK'
end

def log_document_db_event(record)
  event_data = record['event'] || {}
  operation_type = event_data['operationType'] || 'Unknown'
  db = event_data.dig('ns', 'db') || 'Unknown'
  collection = event_data.dig('ns', 'coll') || 'Unknown'
  full_document = event_data['fullDocument'] || {}

  puts "Operation type: #{operation_type}"
  puts "db: #{db}"
```

```
puts "collection: #{collection}"
puts "Full document: #{JSON.pretty_generate(full_document)}"
end
```

Rust

SDK for Rust

Note

There's more on GitHub. Find the complete example and learn how to set up and run in the [Serverless examples](#) repository.

Consuming a Amazon DocumentDB event with Lambda using Rust.

```
use lambda_runtime::{service_fn, tracing, Error, LambdaEvent};
use aws_lambda_events::{
    event::documentdb::{DocumentDbEvent, DocumentDbInnerEvent},
};

// Built with the following dependencies:
//lambda_runtime = "0.11.1"
//serde_json = "1.0"
//tokio = { version = "1", features = ["macros"] }
//tracing = { version = "0.1", features = ["log"] }
//tracing-subscriber = { version = "0.3", default-features = false, features =
    ["fmt"] }
//aws_lambda_events = "0.15.0"

async fn function_handler(event: LambdaEvent<DocumentDbEvent>) ->Result<(),
    Error> {

    tracing::info!("Event Source ARN: {:?}", event.payload.event_source_arn);
    tracing::info!("Event Source: {:?}", event.payload.event_source);

    let records = &event.payload.events;

    if records.is_empty() {
        tracing::info!("No records found. Exiting.");
    }
}
```

```
        return Ok(());
    }

    for record in records{
        log_document_db_event(record);
    }

    tracing::info!("Document db records processed");

    // Prepare the response
    Ok(())
}

fn log_document_db_event(record: &DocumentDbInnerEvent)-> Result<(), Error>{
    tracing::info!("Change Event: {:?}" , record.event);

    Ok(())
}

#[tokio::main]
async fn main() -> Result<(), Error> {
    tracing_subscriber::fmt()
        .with_max_level(tracing::Level::INFO)
        .with_target(false)
        .without_time()
        .init();

    let func = service_fn(function_handler);
    lambda_runtime::run(func).await?;
    Ok(())
}
```

To create the Lambda function

1. Copy the sample code into a file named `index.js`.
2. Create a deployment package with the following command.

```
zip function.zip index.js
```

- Use the following CLI command to create the function. Replace `us-east-1` with the AWS Region, and `123456789012` with your account ID.

```
aws lambda create-function \
  --function-name ProcessDocumentDBRecords \
  --zip-file fileb://function.zip --handler index.handler --runtime nodejs22.x \
  --region us-east-1 \
  --role arn:aws:iam::123456789012:role/AWSDocumentDBLambdaExecutionRole
```

Create the Lambda event source mapping

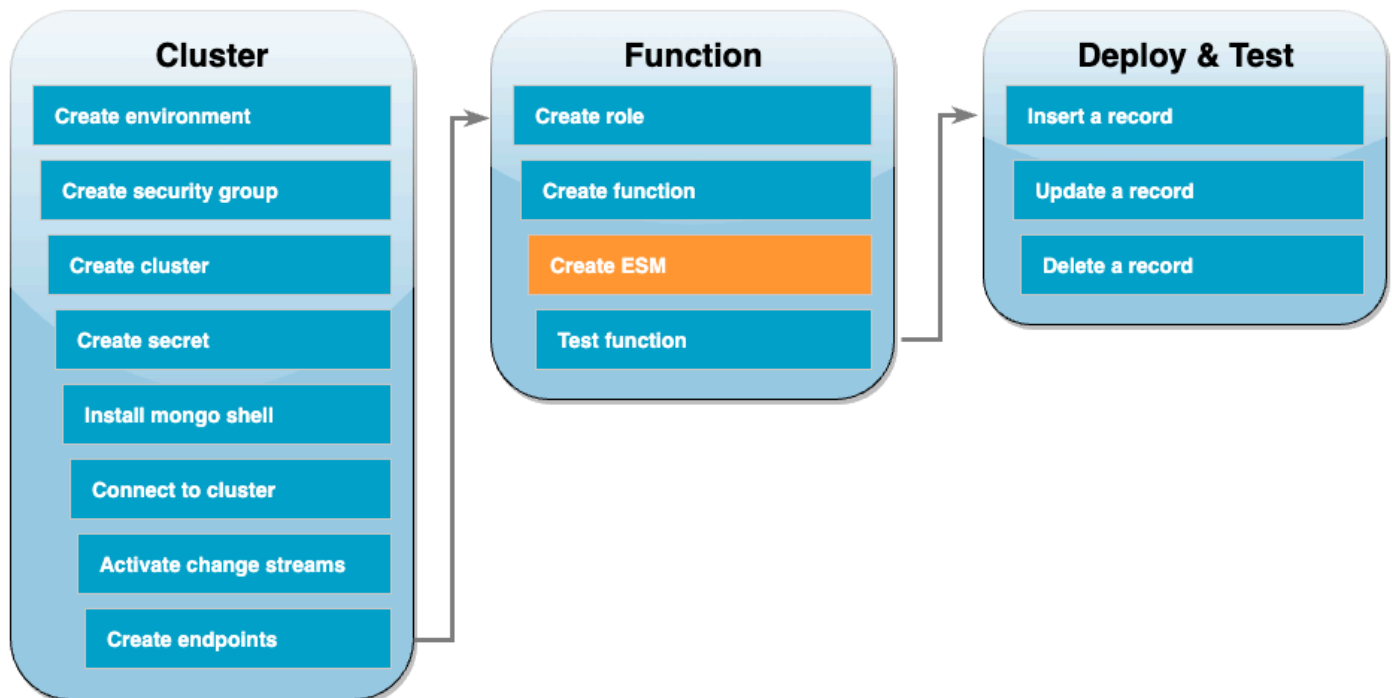

Create the event source mapping that associates your Amazon DocumentDB change stream with your Lambda function. After you create this event source mapping, AWS Lambda immediately starts polling the stream.

To create the event source mapping

- Open the [Functions page](#) in the Lambda console.
- Choose the `ProcessDocumentDBRecords` function you created earlier.

3. Choose the **Configuration** tab, then choose **Triggers** in the left menu.
4. Choose **Add trigger**.
5. Under **Trigger configuration**, for the source, select **Amazon DocumentDB**.
6. Create the event source mapping with the following configuration:
 - **Amazon DocumentDB cluster**– Choose the cluster you created earlier.
 - **Database name**– docdbdemo
 - **Collection name**– products
 - **Batch size**– 1
 - **Starting position**– Latest
 - **Authentication**– BASIC_AUTH
 - **Secrets Manager key**– Choose the DocumentDBSecret you just created.
 - **Batch window**– 1
 - **Full document configuration**– UpdateLookup
7. Choose **Add**. Creating your event source mapping can take a few minutes.

Test your function - manual invoke

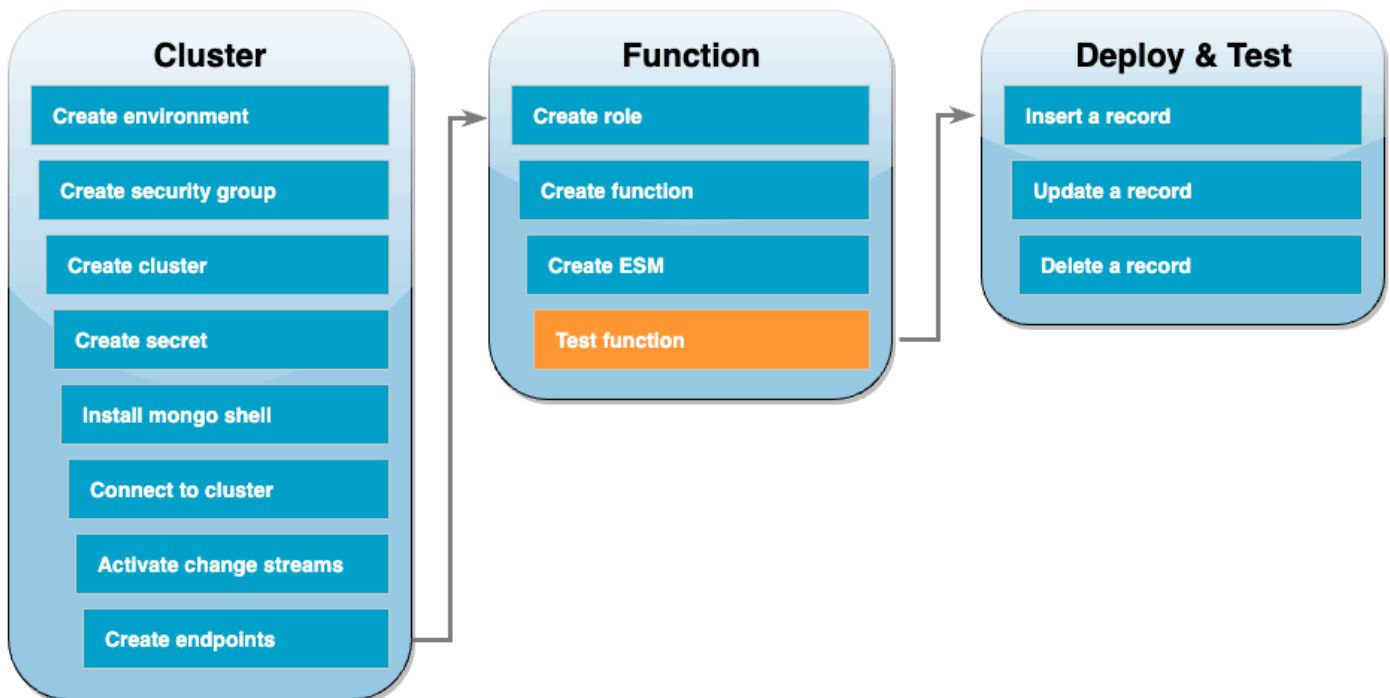

To test that you created your function and event source mapping correctly, invoke your function using the `invoke` command. To do this, first copy the following event JSON into a file called `input.txt`:

```
{
  "eventSourceArn": "arn:aws:rds:us-east-1:123456789012:cluster:canaryclusterb2a659a2-
qo5tcmqkcl03",
  "events": [
    {
      "event": {
        "_id": {
          "_data": "0163eeb6e7000000090100000009000041e1"
        },
        "clusterTime": {
          "$timestamp": {
            "t": 1676588775,
            "i": 9
          }
        },
        "documentKey": {
          "_id": {
            "$oid": "63eeb6e7d418cd98afb1c1d7"
          }
        },
        "fullDocument": {
          "_id": {
            "$oid": "63eeb6e7d418cd98afb1c1d7"
          },
          "anyField": "sampleValue"
        },
        "ns": {
          "db": "docdbdemo",
          "coll": "products"
        },
        "operationType": "insert"
      }
    }
  ],
  "eventSource": "aws:docdb"
}
```

Then, use the following command to invoke your function with this event:

```
aws lambda invoke \  
  --function-name ProcessDocumentDBRecords \  
  --cli-binary-format raw-in-base64-out \  
  --region us-east-1 \  
  --payload file://input.txt out.txt
```

You should see a response that looks like the following:

```
{  
  "StatusCode": 200,  
  "ExecutedVersion": "$LATEST"  
}
```

You can verify that your function successfully processed the event by checking CloudWatch Logs.

To verify manual invocation via CloudWatch Logs

1. Open the [Functions page](#) in the Lambda console.
2. Choose the **Monitor** tab, then choose **View CloudWatch logs**. This takes you to the specific log group associated with your function in the CloudWatch console.
3. Choose the most recent log stream. Within the log messages, you should see the event JSON.

Test your function - insert a record

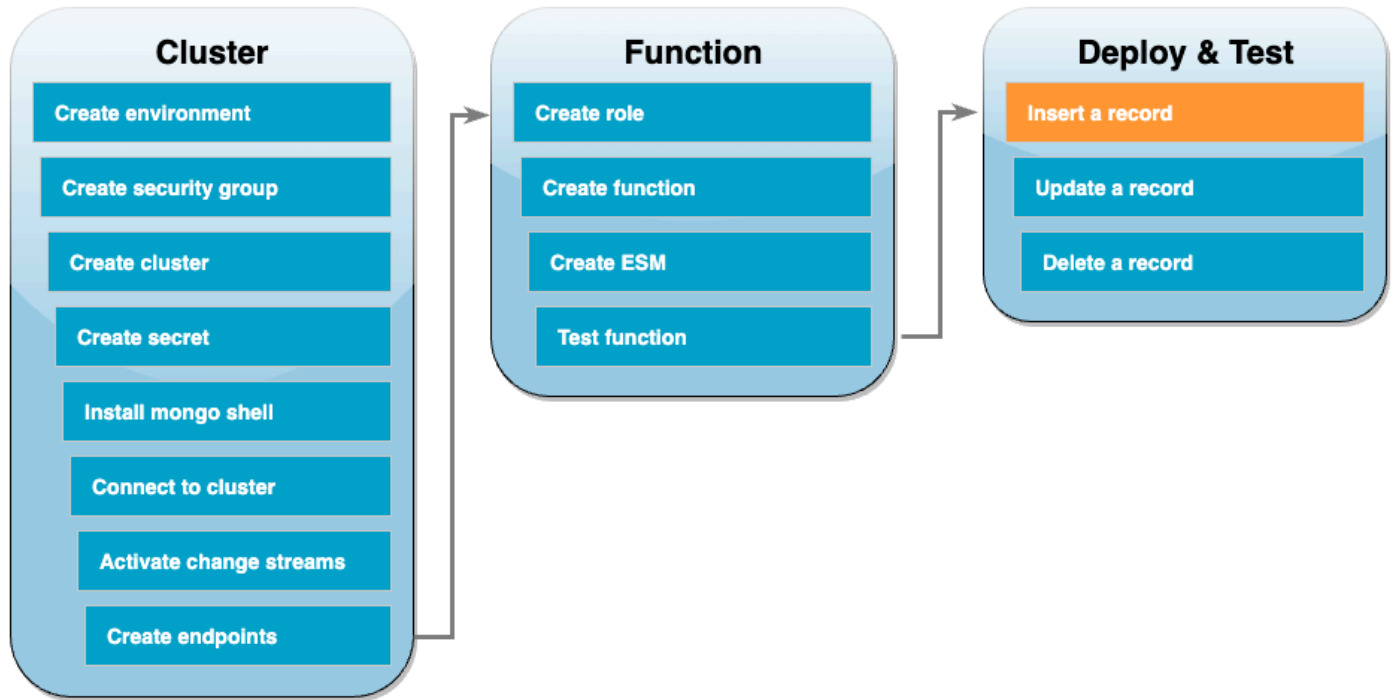

Test your end-to-end setup by interacting directly with your Amazon DocumentDB database. In the next set of steps, you'll insert a record, update it, then delete it.

To insert a record

1. [Reconnect to your Amazon DocumentDB cluster](#) in your AWS Cloud9 environment.
2. Use this command to ensure that you're currently using the docdbdemo database:

```
use docdbdemo
```

3. Insert a record into the products collection of the docdbdemo database:

```
db.products.insert({"name":"Pencil", "price": 1.00})
```

Test your function - update a record

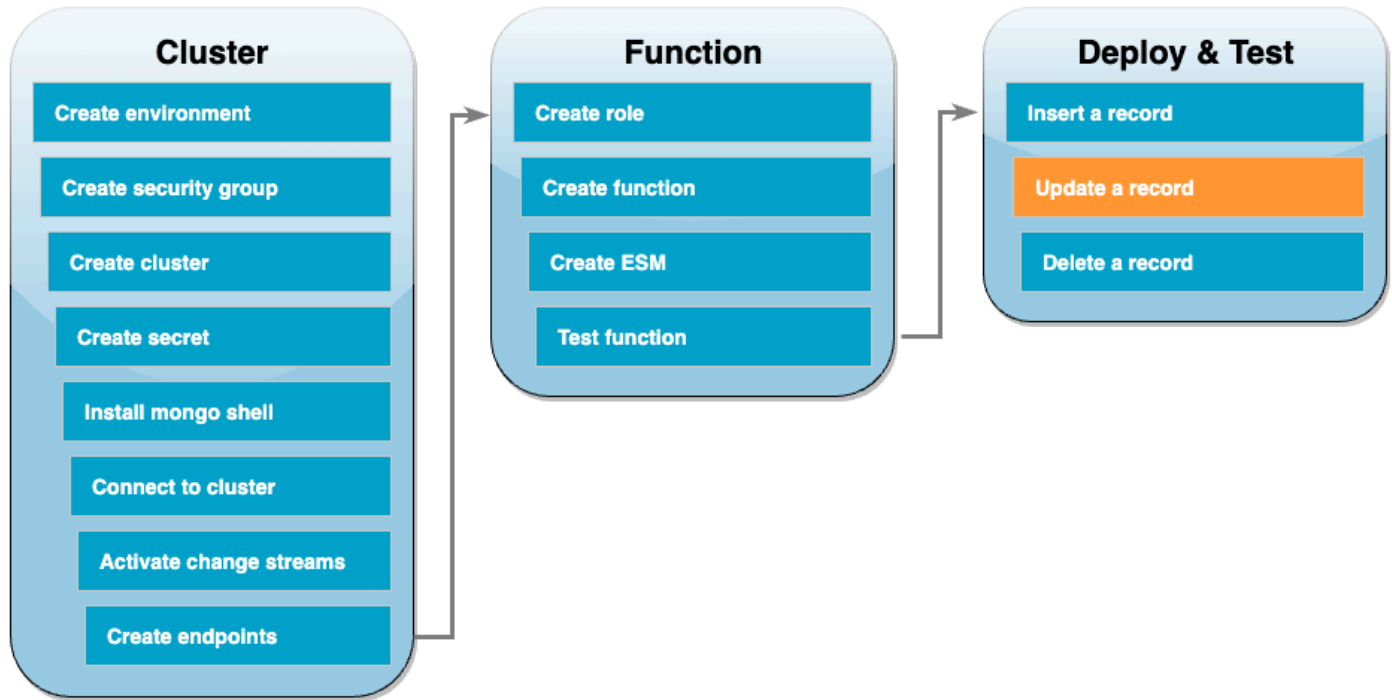

Next, update the record you just inserted with the following command:

```
db.products.update(  
  { "name": "Pencil" },  
  { $set: { "price": 0.50 } }  
)
```

Verify that your function successfully processed this event by checking CloudWatch Logs.

Test your function - delete a record

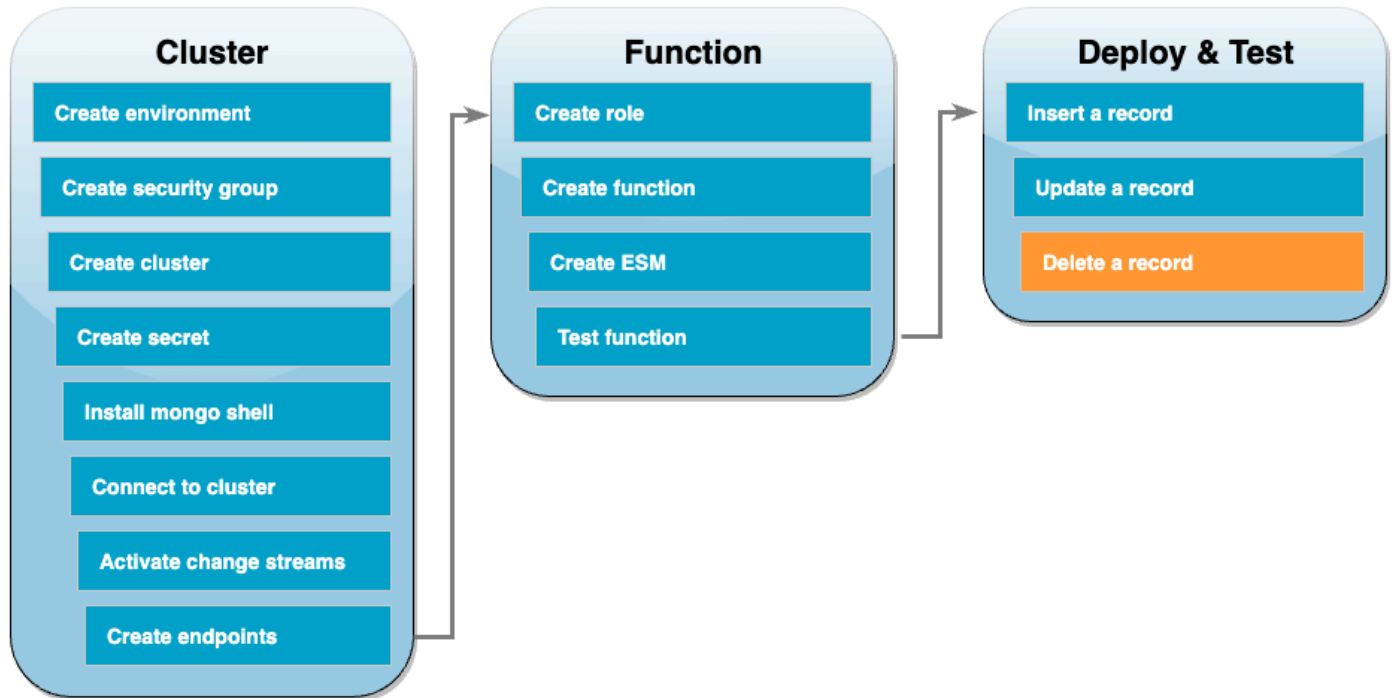

Finally, delete the record you just updated with the following command:

```
db.products.remove( { "name": "Pencil" } )
```

Verify that your function successfully processed this event by checking CloudWatch Logs.

Clean up your resources

You can now delete the resources that you created for this tutorial, unless you want to retain them. By deleting AWS resources that you're no longer using, you prevent unnecessary charges to your AWS account.

To delete the Lambda function

1. Open the [Functions page](#) of the Lambda console.
2. Select the function that you created.
3. Choose **Actions, Delete**.
4. Type **confirm** in the text input field and choose **Delete**.

To delete the execution role

1. Open the [Roles page](#) of the IAM console.
2. Select the execution role that you created.
3. Choose **Delete**.
4. Enter the name of the role in the text input field and choose **Delete**.

To delete the VPC endpoints

1. Open the [VPC console](#). In the left menu, under **Virtual private cloud**, choose **Endpoints**.
2. Select the endpoints you created.
3. Choose **Actions, Delete VPC endpoints**.
4. Enter **delete** in the text input field.
5. Choose **Delete**.

To delete the Amazon DocumentDB cluster

1. Open the [Amazon DocumentDB console](#).
2. Choose the Amazon DocumentDB cluster you created for this tutorial, and disable deletion protection.
3. In the main **Clusters** page, choose your Amazon DocumentDB cluster again.
4. Choose **Actions, Delete**.
5. For **Create final cluster snapshot**, select **No**.
6. Enter **delete** in the text input field.
7. Choose **Delete**.

To delete the secret in Secrets Manager

1. Open the [Secrets Manager console](#).
2. Choose the secret you created for this tutorial.
3. Choose **Actions, Delete secret**.
4. Choose **Schedule deletion**.

To delete the Amazon EC2 security group

1. Open the [EC2 console](#). Under **Network and Security**, choose **Security groups**.
2. Select the security group you created for this tutorial.
3. Choose **Actions, Delete security groups**.
4. Choose **Delete**.

To delete the AWS Cloud9 environment

1. Open the [AWS Cloud9 console](#).
2. Select the environment you created for this tutorial.
3. Choose **Delete**.
4. Enter **delete** in the text input field.
5. Choose **Delete**.

Using AWS Lambda with Amazon DynamoDB

Note

If you want to send data to a target other than a Lambda function or enrich the data before sending it, see [Amazon EventBridge Pipes](#).

You can use an AWS Lambda function to process records in an [Amazon DynamoDB stream](#). With DynamoDB Streams, you can trigger a Lambda function to perform additional work each time a DynamoDB table is updated.

Topics

- [Polling and batching streams](#)
- [Polling and stream starting positions](#)
- [Simultaneous readers of a shard in DynamoDB Streams](#)
- [Example event](#)
- [Process DynamoDB records with Lambda](#)
- [Configuring partial batch response with DynamoDB and Lambda](#)
- [Retain discarded records for a DynamoDB event source in Lambda](#)
- [Implementing stateful DynamoDB stream processing in Lambda](#)
- [Lambda parameters for Amazon DynamoDB event source mappings](#)
- [Using event filtering with a DynamoDB event source](#)
- [Tutorial: Using AWS Lambda with Amazon DynamoDB streams](#)

Polling and batching streams

Lambda polls shards in your DynamoDB stream for records at a base rate of 4 times per second. When records are available, Lambda invokes your function and waits for the result. If processing succeeds, Lambda resumes polling until it receives more records.

By default, Lambda invokes your function as soon as records are available. If the batch that Lambda reads from the event source has only one record in it, Lambda sends only one record to the function. To avoid invoking the function with a small number of records, you can tell the event

source to buffer records for up to 5 minutes by configuring a *batching window*. Before invoking the function, Lambda continues to read records from the event source until it has gathered a full batch, the batching window expires, or the batch reaches the payload limit of 6 MB. For more information, see [Batching behavior](#).

Warning

Lambda event source mappings process each event at least once, and duplicate processing of records can occur. To avoid potential issues related to duplicate events, we strongly recommend that you make your function code idempotent. To learn more, see [How do I make my Lambda function idempotent](#) in the AWS Knowledge Center.

Lambda doesn't wait for any configured [extensions](#) to complete before sending the next batch for processing. In other words, your extensions may continue to run as Lambda processes the next batch of records. This can cause throttling issues if you breach any of your account's [concurrency](#) settings or limits. To detect whether this is a potential issue, monitor your functions and check whether you're seeing higher [concurrency metrics](#) than expected for your event source mapping. Due to short times in between invokes, Lambda may briefly report higher concurrency usage than the number of shards. This can be true even for Lambda functions without extensions.

Configure the [ParallelizationFactor](#) setting to process one shard of a DynamoDB stream with more than one Lambda invocation simultaneously. You can specify the number of concurrent batches that Lambda polls from a shard via a parallelization factor from 1 (default) to 10. For example, when you set `ParallelizationFactor` to 2, you can have 200 concurrent Lambda invocations at maximum to process 100 DynamoDB stream shards (though in practice, you may see different values for the `ConcurrentExecutions` metric). This helps scale up the processing throughput when the data volume is volatile and the [IteratorAge](#) is high. When you increase the number of concurrent batches per shard, Lambda still ensures in-order processing at the item (partition and sort key) level.

Polling and stream starting positions

Be aware that stream polling during event source mapping creation and updates is eventually consistent.

- During event source mapping creation, it may take several minutes to start polling events from the stream.

- During event source mapping updates, it may take several minutes to stop and restart polling events from the stream.

This behavior means that if you specify LATEST as the starting position for the stream, the event source mapping could miss events during creation or updates. To ensure that no events are missed, specify the stream starting position as TRIM_HORIZON.

Simultaneous readers of a shard in DynamoDB Streams

For single-Region tables that are not global tables, you can design for up to two Lambda functions to read from the same DynamoDB Streams shard at the same time. Exceeding this limit can result in request throttling. For global tables, we recommend you limit the number of simultaneous functions to one to avoid request throttling.

Example event

Example

```
{
  "Records": [
    {
      "eventID": "1",
      "eventVersion": "1.0",
      "dynamodb": {
        "Keys": {
          "Id": {
            "N": "101"
          }
        }
      },
      "NewImage": {
        "Message": {
          "S": "New item!"
        }
      },
      "Id": {
        "N": "101"
      }
    },
    "StreamViewType": "NEW_AND_OLD_IMAGES",
    "SequenceNumber": "111",
    "SizeBytes": 26
  },
}
```

```
    "awsRegion": "us-west-2",
    "eventName": "INSERT",
    "eventSourceARN": "arn:aws:dynamodb:us-east-2:123456789012:table/my-table/
stream/2024-06-10T19:26:16.525",
    "eventSource": "aws:dynamodb"
  },
  {
    "eventID": "2",
    "eventVersion": "1.0",
    "dynamodb": {
      "OldImage": {
        "Message": {
          "S": "New item!"
        },
        "Id": {
          "N": "101"
        }
      },
      "SequenceNumber": "222",
      "Keys": {
        "Id": {
          "N": "101"
        }
      },
      "SizeBytes": 59,
      "NewImage": {
        "Message": {
          "S": "This item has changed"
        },
        "Id": {
          "N": "101"
        }
      },
      "StreamViewType": "NEW_AND_OLD_IMAGES"
    },
    "awsRegion": "us-west-2",
    "eventName": "MODIFY",
    "eventSourceARN": "arn:aws:dynamodb:us-east-2:123456789012:table/my-table/
stream/2024-06-10T19:26:16.525",
    "eventSource": "aws:dynamodb"
  }
]}
```



Process DynamoDB records with Lambda

Create an event source mapping to tell Lambda to send records from your stream to a Lambda function. You can create multiple event source mappings to process the same data with multiple Lambda functions, or to process items from multiple streams with a single function.

To configure your function to read from DynamoDB Streams, attach the [AWSLambdaDynamoDBExecutionRole](#) AWS managed policy to your execution role and then create a **DynamoDB** trigger.

To add permissions and create a trigger

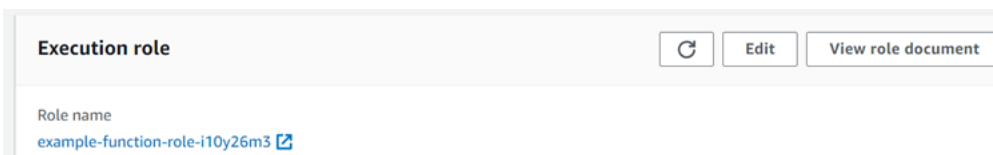
1. Open the [Functions page](#) of the Lambda console.
2. Choose the name of a function.
3. Choose the **Configuration** tab, and then choose **Permissions**.
4. Under **Role name**, choose the link to your execution role. This link opens the role in the IAM console.



5. Choose **Add permissions**, and then choose **Attach policies**.

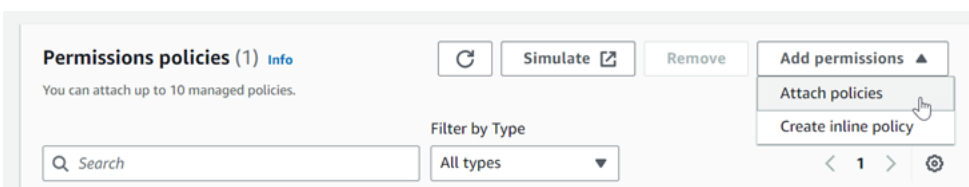

6. In the search field, enter `AWSLambdaDynamoDBExecutionRole`. Add this policy to your execution role. This is an AWS managed policy that contains the permissions your function needs to read from the DynamoDB stream. For more information about this policy, see [AWSLambdaDynamoDBExecutionRole](#) in the *AWS Managed Policy Reference*.
7. Go back to your function in the Lambda console. Under **Function overview**, choose **Add trigger**.

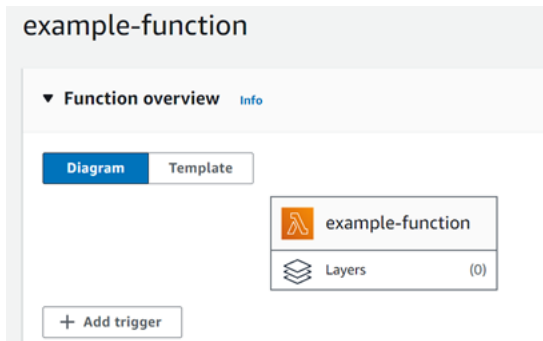

8. Choose a trigger type.
9. Configure the required options, and then choose **Add**.

Lambda supports the following options for DynamoDB event sources:

Event source options

- **DynamoDB table** – The DynamoDB table to read records from.
- **Batch size** – The number of records to send to the function in each batch, up to 10,000. Lambda passes all of the records in the batch to the function in a single call, as long as the total size of the events doesn't exceed the [payload limit](#) for synchronous invocation (6 MB).
- **Batch window** – Specify the maximum amount of time to gather records before invoking the function, in seconds.
- **Starting position** – Process only new records, or all existing records.
 - **Latest** – Process new records that are added to the stream.
 - **Trim horizon** – Process all records in the stream.

After processing any existing records, the function is caught up and continues to process new records.

- **On-failure destination** – A standard SQS queue or standard SNS topic for records that can't be processed. When Lambda discards a batch of records that's too old or has exhausted all retries, Lambda sends details about the batch to the queue or topic.
- **Retry attempts** – The maximum number of times that Lambda retries when the function returns an error. This doesn't apply to service errors or throttles where the batch didn't reach the function.
- **Maximum age of record** – The maximum age of a record that Lambda sends to your function.
- **Split batch on error** – When the function returns an error, split the batch into two before retrying. Your original batch size setting remains unchanged.

- **Concurrent batches per shard** – Concurrently process multiple batches from the same shard.
- **Enabled** – Set to true to enable the event source mapping. Set to false to stop processing records. Lambda keeps track of the last record processed and resumes processing from that point when the mapping is reenabled.

Note

You are not charged for GetRecords API calls invoked by Lambda as part of DynamoDB triggers.

To manage the event source configuration later, choose the trigger in the designer.

Configuring partial batch response with DynamoDB and Lambda

When consuming and processing streaming data from an event source, by default Lambda checkpoints to the highest sequence number of a batch only when the batch is a complete success. Lambda treats all other results as a complete failure and retries processing the batch up to the retry limit. To allow for partial successes while processing batches from a stream, turn on `ReportBatchItemFailures`. Allowing partial successes can help to reduce the number of retries on a record, though it doesn't entirely prevent the possibility of retries in a successful record.

To turn on `ReportBatchItemFailures`, include the enum value **ReportBatchItemFailures** in the [FunctionResponseTypes](#) list. This list indicates which response types are enabled for your function. You can configure this list when you [create](#) or [update](#) an event source mapping.

Report syntax

When configuring reporting on batch item failures, the `StreamsEventResponse` class is returned with a list of batch item failures. You can use a `StreamsEventResponse` object to return the sequence number of the first failed record in the batch. You can also create your own custom class using the correct response syntax. The following JSON structure shows the required response syntax:

```
{
  "batchItemFailures": [
    {
      "itemIdentifier": "<SequenceNumber>"
    }
  ]
}
```

```
    }  
  ]  
}
```

Note

If the `batchItemFailures` array contains multiple items, Lambda uses the record with the lowest sequence number as the checkpoint. Lambda then retries all records starting from that checkpoint.

Success and failure conditions

Lambda treats a batch as a complete success if you return any of the following:

- An empty `batchItemFailure` list
- A null `batchItemFailure` list
- An empty `EventResponse`
- A null `EventResponse`

Lambda treats a batch as a complete failure if you return any of the following:

- An empty string `itemIdentifier`
- A null `itemIdentifier`
- An `itemIdentifier` with a bad key name

Lambda retries failures based on your retry strategy.

Bisecting a batch

If your invocation fails and `BisectBatchOnFunctionError` is turned on, the batch is bisected regardless of your `ReportBatchItemFailures` setting.

When a partial batch success response is received and both `BisectBatchOnFunctionError` and `ReportBatchItemFailures` are turned on, the batch is bisected at the returned sequence number and Lambda retries only the remaining records.

Here are some examples of function code that return the list of failed message IDs in the batch:

.NET

AWS SDK for .NET

Note

There's more on GitHub. Find the complete example and learn how to set up and run in the [Serverless examples](#) repository.

Reporting DynamoDB batch item failures with Lambda using .NET.

```
// Copyright Amazon.com, Inc. or its affiliates. All Rights Reserved.
// SPDX-License-Identifier: Apache-2.0
using System.Text.Json;
using System.Text;
using Amazon.Lambda.Core;
using Amazon.Lambda.DynamoDBEvents;

// Assembly attribute to enable the Lambda function's JSON input to be converted
// into a .NET class.
[assembly: LambdaSerializer(typeof(Amazon.Lambda.Serialization.SystemTextJson.DefaultLambdaJsonSerializer))]

namespace AWSLambda_DDB;

public class Function
{
    public StreamsEventResponse FunctionHandler(DynamoDBEvent dynamoEvent,
        ILambdaContext context)
    {
        context.Logger.LogInformation($"Beginning to process
        {dynamoEvent.Records.Count} records...");
        List<StreamsEventResponse.BatchItemFailure> batchItemFailures = new
        List<StreamsEventResponse.BatchItemFailure>();
        StreamsEventResponse streamsEventResponse = new StreamsEventResponse();

        foreach (var record in dynamoEvent.Records)
        {
            try
            {
                var sequenceNumber = record.Dynamodb.SequenceNumber;
```

```
        context.Logger.LogInformation(sequenceNumber);
    }
    catch (Exception ex)
    {
        context.Logger.LogError(ex.Message);
        batchItemFailures.Add(new StreamsEventResponse.BatchItemFailure()
{ ItemIdentifier = record.Dynamodb.SequenceNumber });
    }
}

if (batchItemFailures.Count > 0)
{
    streamsEventResponse.BatchItemFailures = batchItemFailures;
}

context.Logger.LogInformation("Stream processing complete.");
return streamsEventResponse;
}
}
```

Go

SDK for Go V2

Note

There's more on GitHub. Find the complete example and learn how to set up and run in the [Serverless examples](#) repository.

Reporting DynamoDB batch item failures with Lambda using Go.

```
// Copyright Amazon.com, Inc. or its affiliates. All Rights Reserved.
// SPDX-License-Identifier: Apache-2.0
package main

import (
    "context"
    "github.com/aws/aws-lambda-go/events"
    "github.com/aws/aws-lambda-go/lambda"
)
```

```
type BatchItemFailure struct {
    ItemIdentifier string `json:"ItemIdentifier"`
}

type BatchResult struct {
    BatchItemFailures []BatchItemFailure `json:"BatchItemFailures"`
}

func HandleRequest(ctx context.Context, event events.DynamoDBEvent)
(*BatchResult, error) {
    var batchItemFailures []BatchItemFailure
    curRecordSequenceNumber := ""

    for _, record := range event.Records {
        // Process your record
        curRecordSequenceNumber = record.Change.SequenceNumber
    }

    if curRecordSequenceNumber != "" {
        batchItemFailures = append(batchItemFailures, BatchItemFailure{ItemIdentifier:
curRecordSequenceNumber})
    }

    batchResult := BatchResult{
        BatchItemFailures: batchItemFailures,
    }

    return &batchResult, nil
}

func main() {
    lambda.Start(HandleRequest)
}
```

Java

SDK for Java 2.x

 **Note**

There's more on GitHub. Find the complete example and learn how to set up and run in the [Serverless examples](#) repository.

Reporting DynamoDB batch item failures with Lambda using Java.

```
// Copyright Amazon.com, Inc. or its affiliates. All Rights Reserved.
// SPDX-License-Identifier: Apache-2.0
import com.amazonaws.services.lambda.runtime.Context;
import com.amazonaws.services.lambda.runtime.RequestHandler;
import com.amazonaws.services.lambda.runtime.events.DynamodbEvent;
import com.amazonaws.services.lambda.runtime.events.StreamsEventResponse;
import com.amazonaws.services.lambda.runtime.events.models.dynamodb.StreamRecord;

import java.io.Serializable;
import java.util.ArrayList;
import java.util.List;

public class ProcessDynamodbRecords implements RequestHandler<DynamodbEvent,
    Serializable> {

    @Override
    public StreamsEventResponse handleRequest(DynamodbEvent input, Context
    context) {

        List<StreamsEventResponse.BatchItemFailure> batchItemFailures = new
        ArrayList<>();
        String curRecordSequenceNumber = "";

        for (DynamodbEvent.DynamodbStreamRecord dynamodbStreamRecord :
        input.getRecords()) {
            try {
                //Process your record
                StreamRecord dynamodbRecord = dynamodbStreamRecord.getDynamodb();
                curRecordSequenceNumber = dynamodbRecord.getSequenceNumber();

            } catch (Exception e) {
```



```
        /* Since we are working with streams, we can return the failed
        item immediately.
           Lambda will immediately begin to retry processing from this
        failed item onwards. */
        batchItemFailures.add(new
StreamsEventResponse.BatchItemFailure(curRecordSequenceNumber));
        return new StreamsEventResponse(batchItemFailures);
    }
}

return new StreamsEventResponse();
}
```

JavaScript

SDK for JavaScript (v3)

Note

There's more on GitHub. Find the complete example and learn how to set up and run in the [Serverless examples](#) repository.

Reporting DynamoDB batch item failures with Lambda using JavaScript.

```
export const handler = async (event) => {
    const records = event.Records;
    let curRecordSequenceNumber = "";

    for (const record of records) {
        try {
            // Process your record
            curRecordSequenceNumber = record.dynamodb.SequenceNumber;
        } catch (e) {
            // Return failed record's sequence number
            return { batchItemFailures: [{ itemIdentifier:
curRecordSequenceNumber }] };
        }
    }
}
```

```
    return { batchItemFailures: [] };  
};
```

Reporting DynamoDB batch item failures with Lambda using TypeScript.

```
import {  
    DynamoDBBatchResponse,  
    DynamoDBBatchItemFailure,  
    DynamoDBStreamEvent,  
} from "aws-lambda";  
  
export const handler = async (  
    event: DynamoDBStreamEvent  
): Promise<DynamoDBBatchResponse> => {  
    const batchItemFailures: DynamoDBBatchItemFailure[] = [];  
    let curRecordSequenceNumber;  
  
    for (const record of event.Records) {  
        curRecordSequenceNumber = record.dynamodb?.SequenceNumber;  
  
        if (curRecordSequenceNumber) {  
            batchItemFailures.push({  
                itemIdentifier: curRecordSequenceNumber,  
            });  
        }  
    }  
  
    return { batchItemFailures: batchItemFailures };  
};
```

PHP

SDK for PHP

Note

There's more on GitHub. Find the complete example and learn how to set up and run in the [Serverless examples](#) repository.

Reporting DynamoDB batch item failures with Lambda using PHP.

```
<?php

# using bref/bref and bref/logger for simplicity

use Bref\Context\Context;
use Bref\Event\DynamoDb\DynamoDbEvent;
use Bref\Event\Handler as StdHandler;
use Bref\Logger\StderrLogger;

require __DIR__ . '/vendor/autoload.php';

class Handler implements StdHandler
{
    private StderrLogger $logger;
    public function __construct(StderrLogger $logger)
    {
        $this->logger = $logger;
    }

    /**
     * @throws JsonException
     * @throws \Bref\Event\InvalidLambdaEvent
     */
    public function handle(mixed $event, Context $context): array
    {
        $dynamoDbEvent = new DynamoDbEvent($event);
        $this->logger->info("Processing records");

        $records = $dynamoDbEvent->getRecords();
        $failedRecords = [];
        foreach ($records as $record) {
            try {
                $data = $record->getData();
                $this->logger->info(json_encode($data));
                // TODO: Do interesting work based on the new data
            } catch (Exception $e) {
                $this->logger->error($e->getMessage());
                // failed processing the record
                $failedRecords[] = $record->getSequenceNumber();
            }
        }
        $totalRecords = count($records);
    }
}
```

```
$this->logger->info("Successfully processed $totalRecords records");

// change format for the response
$failures = array_map(
    fn(string $sequenceNumber) => ['itemIdentifier' => $sequenceNumber],
    $failedRecords
);

return [
    'batchItemFailures' => $failures
];
}
}

$logger = new StderrLogger();
return new Handler($logger);
```

Python

SDK for Python (Boto3)

Note

There's more on GitHub. Find the complete example and learn how to set up and run in the [Serverless examples](#) repository.

Reporting DynamoDB batch item failures with Lambda using Python.

```
# Copyright Amazon.com, Inc. or its affiliates. All Rights Reserved.
# SPDX-License-Identifier: Apache-2.0
def handler(event, context):
    records = event.get("Records")
    curRecordSequenceNumber = ""

    for record in records:
        try:
            # Process your record
            curRecordSequenceNumber = record["dynamodb"]["SequenceNumber"]
        except Exception as e:
            # Return failed record's sequence number
```

```
        return {"batchItemFailures":[{"itemIdentifier":
curRecordSequenceNumber}]}

    return {"batchItemFailures":[]}
```

Ruby

SDK for Ruby

Note

There's more on GitHub. Find the complete example and learn how to set up and run in the [Serverless examples](#) repository.

Reporting DynamoDB batch item failures with Lambda using Ruby.

```
def lambda_handler(event:, context:)
  records = event["Records"]
  cur_record_sequence_number = ""

  records.each do |record|
    begin
      # Process your record
      cur_record_sequence_number = record["dynamodb"]["SequenceNumber"]
      rescue StandardError => e
      # Return failed record's sequence number
      return {"batchItemFailures" => [{"itemIdentifier" =>
cur_record_sequence_number}]}
    end
  end

  {"batchItemFailures" => []}
end
```

Rust

SDK for Rust

Note

There's more on GitHub. Find the complete example and learn how to set up and run in the [Serverless examples](#) repository.

Reporting DynamoDB batch item failures with Lambda using Rust.

```
use aws_lambda_events::{
    event::dynamodb::{Event, EventRecord, StreamRecord},
    streams::{DynamoDbBatchItemFailure, DynamoDbEventResponse},
};
use lambda_runtime::{run, service_fn, Error, LambdaEvent};

/// Process the stream record
fn process_record(record: &EventRecord) -> Result<(), Error> {
    let stream_record: &StreamRecord = &record.change;

    // process your stream record here...
    tracing::info!("Data: {:?}", stream_record);

    Ok(())
}

/// Main Lambda handler here...
async fn function_handler(event: LambdaEvent<Event>) ->
Result<DynamoDbEventResponse, Error> {
    let mut response = DynamoDbEventResponse {
        batch_item_failures: vec![],
    };

    let records = &event.payload.records;

    if records.is_empty() {
        tracing::info!("No records found. Exiting.");
        return Ok(response);
    }

    for record in records {
```

```

    tracing::info!("EventId: {}", record.event_id);

    // Couldn't find a sequence number
    if record.change.sequence_number.is_none() {
        response.batch_item_failures.push(DynamoDbBatchItemFailure {
            item_identifier: Some("").to_string(),
        });
        return Ok(response);
    }

    // Process your record here...
    if process_record(record).is_err() {
        response.batch_item_failures.push(DynamoDbBatchItemFailure {
            item_identifier: record.change.sequence_number.clone(),
        });
        /* Since we are working with streams, we can return the failed item
immediately.
        Lambda will immediately begin to retry processing from this failed
item onwards. */
        return Ok(response);
    }
}

tracing::info!("Successfully processed {} record(s)", records.len());

Ok(response)
}

#[tokio::main]
async fn main() -> Result<(), Error> {
    tracing_subscriber::fmt()
        .with_max_level(tracing::Level::INFO)
        // disable printing the name of the module in every log line.
        .with_target(false)
        // disabling time is handy because CloudWatch will add the ingestion
time.
        .without_time()
        .init();

    run(service_fn(function_handler)).await
}

```

Retain discarded records for a DynamoDB event source in Lambda

Error handling for DynamoDB event source mappings depends on whether the error occurs before the function is invoked or during function invocation:

- **Before invocation:** If a Lambda event source mapping is unable to invoke the function due to throttling or other issues, it retries until the records expire or exceed the maximum age configured on the event source mapping ([MaximumRecordAgeInSeconds](#)).
- **During invocation:** If the function is invoked but returns an error, Lambda retries until the records expire, exceed the maximum age ([MaximumRecordAgeInSeconds](#)), or reach the configured retry quota ([MaximumRetryAttempts](#)). For function errors, you can also configure [BisectBatchOnFunctionError](#), which splits a failed batch into two smaller batches, isolating bad records and avoiding timeouts. Splitting batches doesn't consume the retry quota.

If the error handling measures fail, Lambda discards the records and continues processing batches from the stream. With the default settings, this means that a bad record can block processing on the affected shard for up to one day. To avoid this, configure your function's event source mapping with a reasonable number of retries and a maximum record age that fits your use case.

Configuring destinations for failed invocations

To retain records of failed event source mapping invocations, add a destination to your function's event source mapping. Each record sent to the destination is a JSON document containing metadata about the failed invocation. For Amazon S3 destinations, Lambda also sends the entire invocation record along with the metadata. You can configure any Amazon SNS topic, Amazon SQS queue, or S3 bucket as a destination.

With Amazon S3 destinations, you can use the [Amazon S3 Event Notifications](#) feature to receive notifications when objects are uploaded to your destination S3 bucket. You can also configure S3 Event Notifications to invoke another Lambda function to perform automated processing on failed batches.

Your execution role must have permissions for the destination:

- **For SQS destinations:** [sqs:SendMessage](#)
- **For SNS destinations:** [sns:Publish](#)
- **For S3 bucket destinations:** [s3:PutObject](#) and [s3:ListBucket](#)

If you've enabled encryption with your own KMS key for an S3 destination, your function's execution role must also have permission to call [kms:GenerateDataKey](#). If the KMS key and S3 bucket destination are in a different account from your Lambda function and execution role, configure the KMS key to trust the execution role to allow `kms:GenerateDataKey`.

To configure an on-failure destination using the console, follow these steps:

1. Open the [Functions page](#) of the Lambda console.
2. Choose a function.
3. Under **Function overview**, choose **Add destination**.
4. For **Source**, choose **Event source mapping invocation**.
5. For **Event source mapping**, choose an event source that's configured for this function.
6. For **Condition**, select **On failure**. For event source mapping invocations, this is the only accepted condition.
7. For **Destination type**, choose the destination type that Lambda sends invocation records to.
8. For **Destination**, choose a resource.
9. Choose **Save**.

You can also configure an on-failure destination using the AWS Command Line Interface (AWS CLI). For example, the following [create-event-source-mapping](#) command adds an event source mapping with an SQS on-failure destination to MyFunction:

```
aws lambda create-event-source-mapping \  
--function-name "MyFunction" \  
--event-source-arn arn:aws:dynamodb:us-east-2:123456789012:table/my-table/  
stream/2024-06-10T19:26:16.525 \  
--destination-config '{"OnFailure": {"Destination": "arn:aws:sqs:us-  
east-1:123456789012:dest-queue"}}'
```

The following [update-event-source-mapping](#) command updates an event source mapping to send failed invocation records to an SNS destination after two retry attempts, or if the records are more than an hour old.

```
aws lambda update-event-source-mapping \  
--uuid f89f8514-cdd9-4602-9e1f-01a5b77d449b \  
--maximum-retry-attempts 2 \  
--maximum-record-age-in-seconds 3600 \  

```

```
--destination-config '{"OnFailure": {"Destination": "arn:aws:sns:us-east-1:123456789012:dest-topic"}}'
```

Updated settings are applied asynchronously and aren't reflected in the output until the process completes. Use the [get-event-source-mapping](#) command to view the current status.

To remove a destination, supply an empty string as the argument to the `destination-config` parameter:

```
aws lambda update-event-source-mapping \  
--uuid f89f8514-cdd9-4602-9e1f-01a5b77d449b \  
--destination-config '{"OnFailure": {"Destination": ""}}'
```

Security best practices for Amazon S3 destinations

Deleting an S3 bucket that's configured as a destination without removing the destination from your function's configuration can create a security risk. If another user knows your destination bucket's name, they can recreate the bucket in their AWS account. Records of failed invocations will be sent to their bucket, potentially exposing data from your function.

Warning

To ensure that invocation records from your function can't be sent to an S3 bucket in another AWS account, add a condition to your function's execution role that limits `s3:PutObject` permissions to buckets in your account.

The following example shows an IAM policy that limits your function's `s3:PutObject` permissions to buckets in your account. This policy also gives Lambda the `s3:ListBucket` permission it needs to use an S3 bucket as a destination.

```
{  
  "Version": "2012-10-17",  
  "Statement": [  
    {  
      "Sid": "S3BucketResourceAccountWrite",  
      "Effect": "Allow",  
      "Action": [  
        "s3:PutObject",  
        "s3:ListBucket"  
      ],  
    },  
  ],  
}
```

```
    "Resource": "arn:aws:s3:::*/*",
    "Condition": {
      "StringEquals": {
        "s3:ResourceAccount": "111122223333"
      }
    }
  }
]
```

To add a permissions policy to your function's execution role using the AWS Management Console or AWS CLI, refer to the instructions in the following procedures:

Console

To add a permissions policy to a function's execution role (console)

1. Open the [Functions page](#) of the Lambda console.
2. Select the Lambda function whose execution role you want to modify.
3. In the **Configuration** tab, select **Permissions**.
4. In the **Execution role** tab, select your function's **Role name** to open the role's IAM console page.
5. Add a permissions policy to the role by doing the following:
 - a. In the **Permissions policies** pane, choose **Add permissions** and select **Create inline policy**.
 - b. In **Policy editor**, select **JSON**.
 - c. Paste the policy you want to add into the editor (replacing the existing JSON), and then choose **Next**.
 - d. Under **Policy details**, enter a **Policy name**.
 - e. Choose **Create policy**.

AWS CLI

To add a permissions policy to a function's execution role (CLI)

1. Create a JSON policy document with the required permissions and save it in a local directory.

2. Use the IAM `put-role-policy` CLI command to add the permissions to your function's execution role. Run the following command from the directory you saved your JSON policy document in and replace the role name, policy name, and policy document with your own values.

```
aws iam put-role-policy \  
--role-name my_lambda_role \  
--policy-name LambdaS3DestinationPolicy \  
--policy-document file://my_policy.json
```

Example Amazon SNS and Amazon SQS invocation record

The following example shows an invocation record Lambda sends to an SQS or SNS destination for a DynamoDB stream.

```
{  
  "requestContext": {  
    "requestId": "316aa6d0-8154-xmpl-9af7-85d5f4a6bc81",  
    "functionArn": "arn:aws:lambda:us-east-2:123456789012:function:myfunction",  
    "condition": "RetryAttemptsExhausted",  
    "approximateInvokeCount": 1  
  },  
  "responseContext": {  
    "statusCode": 200,  
    "executedVersion": "$LATEST",  
    "functionError": "Unhandled"  
  },  
  "version": "1.0",  
  "timestamp": "2019-11-14T00:13:49.717Z",  
  "DDBStreamBatchInfo": {  
    "shardId": "shardId-00000001573689847184-864758bb",  
    "startSequenceNumber": "800000000003126276362",  
    "endSequenceNumber": "800000000003126276362",  
    "approximateArrivalOfFirstRecord": "2019-11-14T00:13:19Z",  
    "approximateArrivalOfLastRecord": "2019-11-14T00:13:19Z",  
    "batchSize": 1,  
    "streamArn": "arn:aws:dynamodb:us-east-2:123456789012:table/mytable/  
stream/2019-11-14T00:04:06.388"  
  }  
}
```

You can use this information to retrieve the affected records from the stream for troubleshooting. The actual records aren't included, so you must process this record and retrieve them from the stream before they expire and are lost.

Example Amazon S3 invocation record

The following example shows an invocation record Lambda sends to an S3 bucket for a DynamoDB stream. In addition to all of the fields from the previous example for SQS and SNS destinations, the `payload` field contains the original invocation record as an escaped JSON string.

```
{
  "requestContext": {
    "requestId": "316aa6d0-8154-xmpl-9af7-85d5f4a6bc81",
    "functionArn": "arn:aws:lambda:us-east-2:123456789012:function:myfunction",
    "condition": "RetryAttemptsExhausted",
    "approximateInvokeCount": 1
  },
  "responseContext": {
    "statusCode": 200,
    "executedVersion": "$LATEST",
    "functionError": "Unhandled"
  },
  "version": "1.0",
  "timestamp": "2019-11-14T00:13:49.717Z",
  "DDBStreamBatchInfo": {
    "shardId": "shardId-00000001573689847184-864758bb",
    "startSequenceNumber": "800000000003126276362",
    "endSequenceNumber": "800000000003126276362",
    "approximateArrivalOfFirstRecord": "2019-11-14T00:13:19Z",
    "approximateArrivalOfLastRecord": "2019-11-14T00:13:19Z",
    "batchSize": 1,
    "streamArn": "arn:aws:dynamodb:us-east-2:123456789012:table/mytable/stream/2019-11-14T00:04:06.388"
  },
  "payload": "<Whole Event>" // Only available in S3
}
```

The S3 object containing the invocation record uses the following naming convention:

```
aws/lambda/<ESM-UUID>/<shardID>/YYYY/MM/DD/YYYY-MM-DDTHH.MM.SS-<Random UUID>
```

Implementing stateful DynamoDB stream processing in Lambda

Lambda functions can run continuous stream processing applications. A stream represents unbounded data that flows continuously through your application. To analyze information from this continuously updating input, you can bound the included records using a window defined in terms of time.

Tumbling windows are distinct time windows that open and close at regular intervals. By default, Lambda invocations are stateless—you cannot use them for processing data across multiple continuous invocations without an external database. However, with tumbling windows, you can maintain your state across invocations. This state contains the aggregate result of the messages previously processed for the current window. Your state can be a maximum of 1 MB per shard. If it exceeds that size, Lambda terminates the window early.

Each record in a stream belongs to a specific window. Lambda will process each record at least once, but doesn't guarantee that each record will be processed only once. In rare cases, such as error handling, some records might be processed more than once. Records are always processed in order the first time. If records are processed more than once, they might be processed out of order.

Aggregation and processing

Your user managed function is invoked both for aggregation and for processing the final results of that aggregation. Lambda aggregates all records received in the window. You can receive these records in multiple batches, each as a separate invocation. Each invocation receives a state. Thus, when using tumbling windows, your Lambda function response must contain a `state` property. If the response does not contain a `state` property, Lambda considers this a failed invocation. To satisfy this condition, your function can return a `TimeWindowEventResponse` object, which has the following JSON shape:

Example `TimeWindowEventResponse` values

```
{
  "state": {
    "1": 282,
    "2": 715
  },
  "batchItemFailures": []
}
```

Note

For Java functions, we recommend using a `Map<String, String>` to represent the state.

At the end of the window, the flag `isFinalInvokeForWindow` is set to `true` to indicate that this is the final state and that it's ready for processing. After processing, the window completes and your final invocation completes, and then the state is dropped.

At the end of your window, Lambda uses final processing for actions on the aggregation results. Your final processing is synchronously invoked. After successful invocation, your function checkpoints the sequence number and stream processing continues. If invocation is unsuccessful, your Lambda function suspends further processing until a successful invocation.

Example `DynamodbTimeWindowEvent`

```
{
  "Records": [
    {
      "eventID": "1",
      "eventName": "INSERT",
      "eventVersion": "1.0",
      "eventSource": "aws:dynamodb",
      "awsRegion": "us-east-1",
      "dynamodb": {
        "Keys": {
          "Id": {
            "N": "101"
          }
        },
        "NewImage": {
          "Message": {
            "S": "New item!"
          },
          "Id": {
            "N": "101"
          }
        },
        "SequenceNumber": "111",
        "SizeBytes": 26,
        "StreamViewType": "NEW_AND_OLD_IMAGES"
      }
    }
  ]
}
```

```
    },
    "eventSourceARN":"stream-ARN"
  },
  {
    "eventID":"2",
    "eventName":"MODIFY",
    "eventVersion":"1.0",
    "eventSource":"aws:dynamodb",
    "awsRegion":"us-east-1",
    "dynamodb":{
      "Keys":{
        "Id":{
          "N":"101"
        }
      },
      "NewImage":{
        "Message":{
          "S":"This item has changed"
        },
        "Id":{
          "N":"101"
        }
      },
      "OldImage":{
        "Message":{
          "S":"New item!"
        },
        "Id":{
          "N":"101"
        }
      },
      "SequenceNumber":"222",
      "SizeBytes":59,
      "StreamViewType":"NEW_AND_OLD_IMAGES"
    },
    "eventSourceARN":"stream-ARN"
  },
  {
    "eventID":"3",
    "eventName":"REMOVE",
    "eventVersion":"1.0",
    "eventSource":"aws:dynamodb",
    "awsRegion":"us-east-1",
    "dynamodb":{
```



```

        "Keys":{
            "Id":{
                "N":"101"
            }
        },
        "OldImage":{
            "Message":{
                "S":"This item has changed"
            },
            "Id":{
                "N":"101"
            }
        },
        "SequenceNumber":"333",
        "SizeBytes":38,
        "StreamViewType":"NEW_AND_OLD_IMAGES"
    },
    "eventSourceARN":"stream-ARN"
}
],
"window": {
    "start": "2020-07-30T17:00:00Z",
    "end": "2020-07-30T17:05:00Z"
},
"state": {
    "1": "state1"
},
"shardId": "shard123456789",
"eventSourceARN": "stream-ARN",
"isFinalInvokeForWindow": false,
"isWindowTerminatedEarly": false
}

```

Configuration

You can configure tumbling windows when you create or update an event source mapping. To configure a tumbling window, specify the window in seconds ([TumblingWindowInSeconds](#)). The following example AWS Command Line Interface (AWS CLI) command creates a streaming event source mapping that has a tumbling window of 120 seconds. The Lambda function defined for aggregation and processing is named `tumbling-window-example-function`.

```
aws lambda create-event-source-mapping \
```

```
--event-source-arn arn:aws:dynamodb:us-east-2:123456789012:table/my-table/
stream/2024-06-10T19:26:16.525 \
--function-name tumbling-window-example-function \
--starting-position TRIM_HORIZON \
--tumbling-window-in-seconds 120
```

Lambda determines tumbling window boundaries based on the time when records were inserted into the stream. All records have an approximate timestamp available that Lambda uses in boundary determinations.

Tumbling window aggregations do not support resharding. When the shard ends, Lambda considers the window closed, and the child shards start their own window in a fresh state.

Tumbling windows fully support the existing retry policies `maxRetryAttempts` and `maxRecordAge`.

Example Handler.py – Aggregation and processing

The following Python function demonstrates how to aggregate and then process your final state:

```
def lambda_handler(event, context):
    print('Incoming event: ', event)
    print('Incoming state: ', event['state'])

    #Check if this is the end of the window to either aggregate or process.
    if event['isFinalInvokeForWindow']:
        # logic to handle final state of the window
        print('Destination invoke')
    else:
        print('Aggregate invoke')

    #Check for early terminations
    if event['isWindowTerminatedEarly']:
        print('Window terminated early')

    #Aggregation logic
    state = event['state']
    for record in event['Records']:
        state[record['dynamodb']['NewImage']['Id']] = state.get(record['dynamodb']
['NewImage']['Id'], 0) + 1

    print('Returning state: ', state)
    return {'state': state}
```

Lambda parameters for Amazon DynamoDB event source mappings

All Lambda event source types share the same [CreateEventSourceMapping](#) and [UpdateEventSourceMapping](#) API operations. However, only some of the parameters apply to DynamoDB Streams.

Parameter	Required	Default	Notes
BatchSize	N	100	Maximum: 10,000
BisectBatchOnFunctionError	N	false	none
DestinationConfig	N	N/A	Standard Amazon SQS queue or standard Amazon SNS topic destination for discarded records
Enabled	N	true	none
EventSourceArn	Y	N/A	ARN of the data stream or a stream consumer
FilterCriteria	N	N/A	Control which events Lambda sends to your function
FunctionName	Y	N/A	none
FunctionResponseType	N	N/A	To let your function report specific failures in a batch, include the value <code>ReportBatchItemFailures</code> in <code>FunctionResponseType</code> .

Parameter	Required	Default	Notes
			For more information, see Configuring partial batch response with DynamoDB and Lambda .
MaximumBatchingWindowInSeconds	N	0	none
MaximumRecordAgeInSeconds	N	-1	-1 means infinite: failed records are retried until the record expires. The data retention limit for DynamoDB Streams is 24 hours. Minimum: -1 Maximum: 604,800
MaximumRetryAttempts	N	-1	-1 means infinite: failed records are retried until the record expires Minimum: 0 Maximum: 10,000
ParallelizationFactor	N	1	Maximum: 10
StartingPosition	Y	N/A	TRIM_HORIZON or LATEST

Parameter	Required	Default	Notes
TumblingWindowInSeconds	N	N/A	Minimum: 0 Maximum: 900

Using event filtering with a DynamoDB event source

You can use event filtering to control which records from a stream or queue Lambda sends to your function. For general information about how event filtering works, see [the section called “Event filtering”](#).

This section focuses on event filtering for DynamoDB event sources.

Topics

- [DynamoDB event](#)
- [Filtering with table attributes](#)
- [Filtering with Boolean expressions](#)
- [Using the Exists operator](#)
- [JSON format for DynamoDB filtering](#)

DynamoDB event

Suppose you have a DynamoDB table with the primary key `CustomerName` and attributes `AccountManager` and `PaymentTerms`. The following shows an example record from your DynamoDB table’s stream.

```
{
  "eventID": "1",
  "eventVersion": "1.0",
  "dynamodb": {
    "ApproximateCreationDateTime": "1678831218.0",
    "Keys": {
      "CustomerName": {
        "S": "AnyCompany Industries"
      },
      "NewImage": {
        "AccountManager": {
```

```

        "S": "Pat Candella"
    },
    "PaymentTerms": {
        "S": "60 days"
    },
    "CustomerName": {
        "S": "AnyCompany Industries"
    }
},
"SequenceNumber": "111",
"SizeBytes": 26,
"StreamViewType": "NEW_IMAGE"
}
}
}

```

To filter based on the key and attribute values in your DynamoDB table, use the dynamodb key in the record. The following sections provide examples for different filter types.

Filtering with table keys

Suppose you want your function to process only those records where the primary key `CustomerName` is "AnyCompany Industries." The `FilterCriteria` object would be as follows.

```

{
  "Filters": [
    {
      "Pattern": "{ \"dynamodb\" : { \"Keys\" : { \"CustomerName\" : { \"S\" : [ \"AnyCompany Industries\" ] } } } }"
    }
  ]
}

```

For added clarity, here is the value of the filter's `Pattern` expanded in plain JSON.

```

{
  "dynamodb": {
    "Keys": {
      "CustomerName": {
        "S": [ "AnyCompany Industries" ]
      }
    }
  }
}

```

```
    }
  }
}
```

You can add your filter using the console, AWS CLI or an AWS SAM template.

Console

To add this filter using the console, follow the instructions in [Attaching filter criteria to an event source mapping \(console\)](#) and enter the following string for the **Filter criteria**.

```
{ "dynamodb" : { "Keys" : { "CustomerName" : { "S" : [ "AnyCompany Industries" ] } } } }
```

AWS CLI

To create a new event source mapping with these filter criteria using the AWS Command Line Interface (AWS CLI), run the following command.

```
aws lambda create-event-source-mapping \
  --function-name my-function \
  --event-source-arn arn:aws:dynamodb:us-east-2:123456789012:table/my-table \
  --filter-criteria '{"Filters": [{"Pattern": "{ \"dynamodb\" : { \"Keys\" : { \"CustomerName\" : { \"S\" : [ \"AnyCompany Industries\" ] } } } }"]}]'
```

To add these filter criteria to an existing event source mapping, run the following command.

```
aws lambda update-event-source-mapping \
  --uuid "a1b2c3d4-5678-90ab-cdef-1111EXAMPLE" \
  --filter-criteria '{"Filters": [{"Pattern": "{ \"dynamodb\" : { \"Keys\" : { \"CustomerName\" : { \"S\" : [ \"AnyCompany Industries\" ] } } } }"]}]'
```

AWS SAM

To add this filter using AWS SAM, add the following snippet to the YAML template for your event source.

```
FilterCriteria:
  Filters:
    - Pattern: '{ "dynamodb" : { "Keys" : { "CustomerName" : { "S" : [ "AnyCompany Industries" ] } } } }'
```

Filtering with table attributes

With DynamoDB, you can also use the `NewImage` and `OldImage` keys to filter for attribute values. Suppose you want to filter records where the `AccountManager` attribute in the latest table image is "Pat Candella" or "Shirley Rodriguez." The `FilterCriteria` object would be as follows.

```
{
  "Filters": [
    {
      "Pattern": "{ \"dynamodb\" : { \"NewImage\" : { \"AccountManager\" : { \"S\" : [ \"Pat Candella\", \"Shirley Rodriguez\" ] } } } }"
    }
  ]
}
```

For added clarity, here is the value of the filter's `Pattern` expanded in plain JSON.

```
{
  "dynamodb": {
    "NewImage": {
      "AccountManager": {
        "S": [ "Pat Candella", "Shirley Rodriguez" ]
      }
    }
  }
}
```

You can add your filter using the console, AWS CLI or an AWS SAM template.

Console

To add this filter using the console, follow the instructions in [Attaching filter criteria to an event source mapping \(console\)](#) and enter the following string for the **Filter criteria**.

```
{ "dynamodb" : { "NewImage" : { "AccountManager" : { "S" : [ "Pat Candella",
"Shirley Rodriguez" ] } } } }
```

AWS CLI

To create a new event source mapping with these filter criteria using the AWS Command Line Interface (AWS CLI), run the following command.

```
aws lambda create-event-source-mapping \
  --function-name my-function \
  --event-source-arn arn:aws:dynamodb:us-east-2:123456789012:table/my-table \
  --filter-criteria '{"Filters": [{"Pattern": "{ \"dynamodb\" : { \"NewImage\" : { \"AccountManager\" : { \"S\" : [ \"Pat Candella\", \"Shirley Rodriguez\" ] } } } }"]}]'
```

To add these filter criteria to an existing event source mapping, run the following command.

```
aws lambda update-event-source-mapping \
  --uuid "a1b2c3d4-5678-90ab-cdef-11111EXAMPLE" \
  --filter-criteria '{"Filters": [{"Pattern": "{ \"dynamodb\" : { \"NewImage\" : { \"AccountManager\" : { \"S\" : [ \"Pat Candella\", \"Shirley Rodriguez\" ] } } } }"]}]'
```

AWS SAM

To add this filter using AWS SAM, add the following snippet to the YAML template for your event source.

```
FilterCriteria:
  Filters:
    - Pattern: '{ "dynamodb" : { "NewImage" : { "AccountManager" : { "S" : [ "Pat Candella", "Shirley Rodriguez" ] } } } }'
```

Filtering with Boolean expressions

You can also create filters using Boolean AND expressions. These expressions can include both your table's key and attribute parameters. Suppose you want to filter records where the `NewImage` value of `AccountManager` is "Pat Candella" and the `OldImage` value is "Terry Whitlock". The `FilterCriteria` object would be as follows.

```
{
  "Filters": [
    {
      "Pattern": "{ \"dynamodb\" : { \"NewImage\" : { \"AccountManager\" : { \"S\" : [ \"Pat Candella\" ] } } } , \"dynamodb\" : { \"OldImage\" : { \"AccountManager\" : { \"S\" : [ \"Terry Whitlock\" ] } } } }"
    }
  ]
}
```

```
}
```

For added clarity, here is the value of the filter's `Pattern` expanded in plain JSON.

```
{
  "dynamodb" : {
    "NewImage" : {
      "AccountManager" : {
        "S" : [
          "Pat Candella"
        ]
      }
    }
  },
  "dynamodb": {
    "OldImage": {
      "AccountManager": {
        "S": [
          "Terry Whitlock"
        ]
      }
    }
  }
}
```

You can add your filter using the console, AWS CLI or an AWS SAM template.

Console

To add this filter using the console, follow the instructions in [Attaching filter criteria to an event source mapping \(console\)](#) and enter the following string for the **Filter criteria**.

```
{ "dynamodb" : { "NewImage" : { "AccountManager" : { "S" : [ "Pat
Candella" ] } } } , "dynamodb" : { "OldImage" : { "AccountManager" : { "S" :
[ "Terry Whitlock" ] } } } }
```

AWS CLI

To create a new event source mapping with these filter criteria using the AWS Command Line Interface (AWS CLI), run the following command.

```
aws lambda create-event-source-mapping \
```

```
--function-name my-function \
--event-source-arn arn:aws:dynamodb:us-east-2:123456789012:table/my-table \
--filter-criteria '{"Filters": [{"Pattern": "{ \"dynamodb\" : { \"NewImage\" : { \"AccountManager\" : { \"S\" : [ \"Pat Candella\" ] } } } , \"dynamodb\" : { \"OldImage\" : { \"AccountManager\" : { \"S\" : [ \"Terry Whitlock\" ] } } } } ]}]'
```

To add these filter criteria to an existing event source mapping, run the following command.

```
aws lambda update-event-source-mapping \
--uuid "a1b2c3d4-5678-90ab-cdef-11111EXAMPLE" \
--filter-criteria '{"Filters": [{"Pattern": "{ \"dynamodb\" : { \"NewImage\" : { \"AccountManager\" : { \"S\" : [ \"Pat Candella\" ] } } } , \"dynamodb\" : { \"OldImage\" : { \"AccountManager\" : { \"S\" : [ \"Terry Whitlock\" ] } } } } ]}]'
```

AWS SAM

To add this filter using AWS SAM, add the following snippet to the YAML template for your event source.

```
FilterCriteria:
  Filters:
    - Pattern: '{ "dynamodb" : { "NewImage" : { "AccountManager" : { "S" : [ "Pat Candella" ] } } } , "dynamodb" : { "OldImage" : { "AccountManager" : { "S" : [ "Terry Whitlock" ] } } } }'
```

Note

DynamoDB event filtering doesn't support the use of numeric operators (numeric equals and numeric range). Even if items in your table are stored as numbers, these parameters are converted to strings in the JSON record object.

Using the Exists operator

Because of the way that JSON event objects from DynamoDB are structured, using the Exists operator requires special care. The Exists operator only works on leaf nodes in the event JSON, so if your filter pattern uses Exists to test for an intermediate node, it won't work. Consider the following DynamoDB table item:

```
{
  "UserID": {"S": "12345"},
  "Name": {"S": "John Doe"},
  "Organizations": {"L": [
    {"S": "Sales"},
    {"S": "Marketing"},
    {"S": "Support"}
  ]}
}
```

You might want to create a filter pattern like the following that would test for events containing "Organizations":

```
{ "dynamodb" : { "NewImage" : { "Organizations" : [ { "exists": true } ] } } }
```

However, this filter pattern would never return a match because "Organizations" is not a leaf node. The following example shows how to properly use the Exists operator to construct the desired filter pattern:

```
{ "dynamodb" : { "NewImage" : { "Organizations": {"L": {"S": [ {"exists":
  true } ] } } } } }
```

JSON format for DynamoDB filtering

To properly filter events from DynamoDB sources, both the data field and your filter criteria for the data field (dynamodb) must be in valid JSON format. If either field isn't in a valid JSON format, Lambda drops the message or throws an exception. The following table summarizes the specific behavior:

Incoming data format	Filter pattern format for data properties	Resulting action
Valid JSON	Valid JSON	Lambda filters based on your filter criteria.
Valid JSON	No filter pattern for data properties	Lambda filters (on the other metadata properties only) based on your filter criteria.

Incoming data format	Filter pattern format for data properties	Resulting action
Valid JSON	Non-JSON	Lambda throws an exception at the time of the event source mapping creation or update. The filter pattern for data properties must be in a valid JSON format.
Non-JSON	Valid JSON	Lambda drops the record.
Non-JSON	No filter pattern for data properties	Lambda filters (on the other metadata properties only) based on your filter criteria.
Non-JSON	Non-JSON	Lambda throws an exception at the time of the event source mapping creation or update. The filter pattern for data properties must be in a valid JSON format.

Tutorial: Using AWS Lambda with Amazon DynamoDB streams

In this tutorial, you create a Lambda function to consume events from an Amazon DynamoDB stream.

Prerequisites

This tutorial assumes that you have some knowledge of basic Lambda operations and the Lambda console. If you haven't already, follow the instructions in [Create a Lambda function with the console](#) to create your first Lambda function.

To complete the following steps, you need the [AWS CLI version 2](#). Commands and the expected output are listed in separate blocks:

```
aws --version
```

You should see the following output:

```
aws-cli/2.13.27 Python/3.11.6 Linux/4.14.328-248.540.amzn2.x86_64 exe/x86_64.amzn.2
```

For long commands, an escape character (\) is used to split a command over multiple lines.

On Linux and macOS, use your preferred shell and package manager.

Note

In Windows, some Bash CLI commands that you commonly use with Lambda (such as `zip`) are not supported by the operating system's built-in terminals. To get a Windows-integrated version of Ubuntu and Bash, [install the Windows Subsystem for Linux](#). Example CLI commands in this guide use Linux formatting. Commands which include inline JSON documents must be reformatted if you are using the Windows CLI.

Create the execution role

Create the [execution role](#) that gives your function permission to access AWS resources.

To create an execution role

1. Open the [roles page](#) in the IAM console.
2. Choose **Create role**.
3. Create a role with the following properties.
 - **Trusted entity** – Lambda.
 - **Permissions** – **AWSLambdaDynamoDBExecutionRole**.
 - **Role name** – **lambda-dynamodb-role**.

The **AWSLambdaDynamoDBExecutionRole** has the permissions that the function needs to read items from DynamoDB and write logs to CloudWatch Logs.

Create the function

Create a Lambda function that processes your DynamoDB events. The function code writes some of the incoming event data to CloudWatch Logs.

.NET

AWS SDK for .NET

Note

There's more on GitHub. Find the complete example and learn how to set up and run in the [Serverless examples](#) repository.

Consuming a DynamoDB event with Lambda using .NET.

```
// Copyright Amazon.com, Inc. or its affiliates. All Rights Reserved.
// SPDX-License-Identifier: Apache-2.0
using System.Text.Json;
using System.Text;
using Amazon.Lambda.Core;
using Amazon.Lambda.DynamoDBEvents;

// Assembly attribute to enable the Lambda function's JSON input to be converted
// into a .NET class.
[assembly: LambdaSerializer(typeof(Amazon.Lambda.Serialization.SystemTextJson.DefaultLambdaJsonSerializer))]

namespace AWSLambda_DDB;

public class Function
{
    public void FunctionHandler(DynamoDBEvent dynamoEvent, ILambdaContext context)
    {
        context.Logger.LogInformation($"Beginning to process {dynamoEvent.Records.Count} records...");

        foreach (var record in dynamoEvent.Records)
        {
            context.Logger.LogInformation($"Event ID: {record.EventID}");
            context.Logger.LogInformation($"Event Name: {record.EventName}");

            context.Logger.LogInformation(JsonSerializer.Serialize(record));
        }

        context.Logger.LogInformation("Stream processing complete.");
    }
}
```

```
}  
}
```

Go

SDK for Go V2

Note

There's more on GitHub. Find the complete example and learn how to set up and run in the [Serverless examples](#) repository.

Consuming a DynamoDB event with Lambda using Go.

```
// Copyright Amazon.com, Inc. or its affiliates. All Rights Reserved.  
// SPDX-License-Identifier: Apache-2.0  
package main  
  
import (  
    "context"  
    "github.com/aws/aws-lambda-go/lambda"  
    "github.com/aws/aws-lambda-go/events"  
    "fmt"  
)  
  
func HandleRequest(ctx context.Context, event events.DynamoDBEvent) (*string,  
error) {  
    if len(event.Records) == 0 {  
        return nil, fmt.Errorf("received empty event")  
    }  
  
    for _, record := range event.Records {  
        LogDynamoDBRecord(record)  
    }  
  
    message := fmt.Sprintf("Records processed: %d", len(event.Records))  
    return &message, nil  
}  
  
func main() {
```



```
lambda.Start(HandleRequest)
}

func LogDynamoDBRecord(record events.DynamoDBEventRecord){
    fmt.Println(record.EventID)
    fmt.Println(record.EventName)
    fmt.Printf("%+v\n", record.Change)
}
```

Java

SDK for Java 2.x

Note

There's more on GitHub. Find the complete example and learn how to set up and run in the [Serverless examples](#) repository.

Consuming a DynamoDB event with Lambda using Java.

```
import com.amazonaws.services.lambda.runtime.Context;
import com.amazonaws.services.lambda.runtime.RequestHandler;
import com.amazonaws.services.lambda.runtime.events.DynamodbEvent;
import
    com.amazonaws.services.lambda.runtime.events.DynamodbEvent.DynamodbStreamRecord;
import com.google.gson.Gson;
import com.google.gson.GsonBuilder;

public class example implements RequestHandler<DynamodbEvent, Void> {

    private static final Gson GSON = new
        GsonBuilder().setPrettyPrinting().create();

    @Override
    public Void handleRequest(DynamodbEvent event, Context context) {
        System.out.println(GSON.toJson(event));
        event.getRecords().forEach(this::logDynamoDBRecord);
        return null;
    }

    private void logDynamoDBRecord(DynamodbStreamRecord record) {
```

```
        System.out.println(record.getEventID());
        System.out.println(record.getEventName());
        System.out.println("DynamoDB Record: " +
    GSON.toJson(record.getDynamodb()));
    }
}
```

JavaScript

SDK for JavaScript (v3)

Note

There's more on GitHub. Find the complete example and learn how to set up and run in the [Serverless examples](#) repository.

Consuming a DynamoDB event with Lambda using JavaScript.

```
// Copyright Amazon.com, Inc. or its affiliates. All Rights Reserved.
// SPDX-License-Identifier: Apache-2.0
exports.handler = async (event, context) => {
    console.log(JSON.stringify(event, null, 2));
    event.Records.forEach(record => {
        logDynamoDBRecord(record);
    });
};

const logDynamoDBRecord = (record) => {
    console.log(record.eventID);
    console.log(record.eventName);
    console.log(`DynamoDB Record: ${JSON.stringify(record.dynamodb)}`);
};
```

Consuming a DynamoDB event with Lambda using TypeScript.

```
export const handler = async (event, context) => {
    console.log(JSON.stringify(event, null, 2));
    event.Records.forEach(record => {
        logDynamoDBRecord(record);
    });
};
```

```
});  
}  
const logDynamoDBRecord = (record) => {  
  console.log(record.eventID);  
  console.log(record.eventName);  
  console.log(`DynamoDB Record: ${JSON.stringify(record.dynamodb)}`);  
};
```

PHP

SDK for PHP

Note

There's more on GitHub. Find the complete example and learn how to set up and run in the [Serverless examples](#) repository.

Consuming a DynamoDB event with Lambda using PHP.

```
<?php  
  
# using bref/bref and bref/logger for simplicity  
  
use Bref\Context\Context;  
use Bref\Event\DynamoDb\DynamoDbEvent;  
use Bref\Event\DynamoDb\DynamoDbHandler;  
use Bref\Logger\StderrLogger;  
  
require __DIR__ . '/vendor/autoload.php';  
  
class Handler extends DynamoDbHandler  
{  
  private StderrLogger $logger;  
  
  public function __construct(StderrLogger $logger)  
  {  
    $this->logger = $logger;  
  }  
  
  /**  
   * @throws JsonException
```

```
* @throws \Bref\Event\InvalidLambdaEvent
*/
public function handleDynamoDb(DynamoDbEvent $event, Context $context): void
{
    $this->logger->info("Processing DynamoDb table items");
    $records = $event->getRecords();

    foreach ($records as $record) {
        $eventName = $record->getEventName();
        $keys = $record->getKeys();
        $old = $record->getOldImage();
        $new = $record->getNewImage();

        $this->logger->info("Event Name:". $eventName. "\n");
        $this->logger->info("Keys:". json_encode($keys). "\n");
        $this->logger->info("Old Image:". json_encode($old). "\n");
        $this->logger->info("New Image:". json_encode($new));

        // TODO: Do interesting work based on the new data

        // Any exception thrown will be logged and the invocation will be
        marked as failed
    }

    $totalRecords = count($records);
    $this->logger->info("Successfully processed $totalRecords items");
}

}

$logger = new StderrLogger();
return new Handler($logger);
```

Python

SDK for Python (Boto3)

Note

There's more on GitHub. Find the complete example and learn how to set up and run in the [Serverless examples](#) repository.

Consuming a DynamoDB event with Lambda using Python.

```
import json

def lambda_handler(event, context):
    print(json.dumps(event, indent=2))

    for record in event['Records']:
        log_dynamodb_record(record)

def log_dynamodb_record(record):
    print(record['eventID'])
    print(record['eventName'])
    print(f"DynamoDB Record: {json.dumps(record['dynamodb'])}")
```

Ruby

SDK for Ruby

Note

There's more on GitHub. Find the complete example and learn how to set up and run in the [Serverless examples](#) repository.

Consuming a DynamoDB event with Lambda using Ruby.

```
def lambda_handler(event:, context:)
  return 'received empty event' if event['Records'].empty?

  event['Records'].each do |record|
    log_dynamodb_record(record)
  end

  "Records processed: #{event['Records'].length}"
end

def log_dynamodb_record(record)
```

```
puts record['eventID']
puts record['eventName']
puts "DynamoDB Record: #{JSON.generate(record['dynamodb'])}"
end
```

Rust

SDK for Rust

Note

There's more on GitHub. Find the complete example and learn how to set up and run in the [Serverless examples](#) repository.

Consuming a DynamoDB event with Lambda using Rust.

```
use lambda_runtime::{service_fn, tracing, Error, LambdaEvent};
use aws_lambda_events::{
    event::dynamodb::{Event, EventRecord},
};

// Built with the following dependencies:
//lambda_runtime = "0.11.1"
//serde_json = "1.0"
//tokio = { version = "1", features = ["macros"] }
//tracing = { version = "0.1", features = ["log"] }
//tracing-subscriber = { version = "0.3", default-features = false, features =
    ["fmt"] }
//aws_lambda_events = "0.15.0"

async fn function_handler(event: LambdaEvent<Event>) ->Result<(), Error> {

    let records = &event.payload.records;
    tracing::info!("event payload: {:?}",records);
    if records.is_empty() {
        tracing::info!("No records found. Exiting.");
        return Ok(());
    }
}
```

```
    for record in records{
        log_dynamo_dbrecord(record);
    }

    tracing::info!("Dynamo db records processed");

    // Prepare the response
    Ok(())
}

fn log_dynamo_dbrecord(record: &EventRecord)-> Result<(), Error>{
    tracing::info!("EventId: {}", record.event_id);
    tracing::info!("EventName: {}", record.event_name);
    tracing::info!("DynamoDB Record: {:?}", record.change );
    Ok(())
}

#[tokio::main]
async fn main() -> Result<(), Error> {
    tracing_subscriber::fmt()
        .with_max_level(tracing::Level::INFO)
        .with_target(false)
        .without_time()
        .init();

    let func = service_fn(function_handler);
    lambda_runtime::run(func).await?;
    Ok(())
}
```

To create the function

1. Copy the sample code into a file named `example.js`.
2. Create a deployment package.

```
zip function.zip example.js
```

3. Create a Lambda function with the `create-function` command.

```
aws lambda create-function --function-name ProcessDynamoDBRecords \  
  --zip-file fileb://function.zip --handler example.handler --runtime nodejs18.x \  
  \  
  --role arn:aws:iam::111122223333:role/lambda-dynamodb-role
```

Test the Lambda function

In this step, you invoke your Lambda function manually using the `invoke` AWS Lambda CLI command and the following sample DynamoDB event. Copy the following into a file named `input.txt`.

Example `input.txt`

```
{  
  "Records": [  
    {  
      "eventID": "1",  
      "eventName": "INSERT",  
      "eventVersion": "1.0",  
      "eventSource": "aws:dynamodb",  
      "awsRegion": "us-east-1",  
      "dynamodb": {  
        "Keys": {  
          "Id": {  
            "N": "101"  
          }  
        },  
        "NewImage": {  
          "Message": {  
            "S": "New item!"  
          },  
          "Id": {  
            "N": "101"  
          }  
        },  
        "SequenceNumber": "111",  
        "SizeBytes": 26,  
        "StreamViewType": "NEW_AND_OLD_IMAGES"  
      },  
      "eventSourceARN": "stream-ARN"  
    }  
  ]  
}
```



```
  },
  {
    "eventID": "2",
    "eventName": "MODIFY",
    "eventVersion": "1.0",
    "eventSource": "aws:dynamodb",
    "awsRegion": "us-east-1",
    "dynamodb": {
      "Keys": {
        "Id": {
          "N": "101"
        }
      },
    },
    "NewImage": {
      "Message": {
        "S": "This item has changed"
      },
      "Id": {
        "N": "101"
      }
    },
    "OldImage": {
      "Message": {
        "S": "New item!"
      },
      "Id": {
        "N": "101"
      }
    },
    "SequenceNumber": "222",
    "SizeBytes": 59,
    "StreamViewType": "NEW_AND_OLD_IMAGES"
  },
  "eventSourceARN": "stream-ARN"
},
{
  "eventID": "3",
  "eventName": "REMOVE",
  "eventVersion": "1.0",
  "eventSource": "aws:dynamodb",
  "awsRegion": "us-east-1",
  "dynamodb": {
    "Keys": {
      "Id": {
```

```
        "N": "101"
      }
    },
    "OldImage": {
      "Message": {
        "S": "This item has changed"
      },
      "Id": {
        "N": "101"
      }
    },
    "SequenceNumber": "333",
    "SizeBytes": 38,
    "StreamViewType": "NEW_AND_OLD_IMAGES"
  },
  "eventSourceARN": "stream-ARN"
}
]
```

Run the following `invoke` command.

```
aws lambda invoke --function-name ProcessDynamoDBRecords \  
  --cli-binary-format raw-in-base64-out \  
  --payload file://input.txt outputfile.txt
```

The **cli-binary-format** option is required if you're using AWS CLI version 2. To make this the default setting, run `aws configure set cli-binary-format raw-in-base64-out`. For more information, see [AWS CLI supported global command line options](#) in the *AWS Command Line Interface User Guide for Version 2*.

The function returns the string message in the response body.

Verify the output in the `outputfile.txt` file.

Create a DynamoDB table with a stream enabled

Create an Amazon DynamoDB table with a stream enabled.

To create a DynamoDB table

1. Open the [DynamoDB console](#).

2. Choose **Create table**.
3. Create a table with the following settings.
 - **Table name** – **lambda-dynamodb-stream**
 - **Primary key** – **id** (string)
4. Choose **Create**.

To enable streams

1. Open the [DynamoDB console](#).
2. Choose **Tables**.
3. Choose the **lambda-dynamodb-stream** table.
4. Under **Exports and streams**, choose **DynamoDB stream details**.
5. Choose **Turn on**.
6. For **View type**, choose **Key attributes only**.
7. Choose **Turn on stream**.

Write down the stream ARN. You need this in the next step when you associate the stream with your Lambda function. For more information on enabling streams, see [Capturing table activity with DynamoDB Streams](#).

Add an event source in AWS Lambda

Create an event source mapping in AWS Lambda. This event source mapping associates the DynamoDB stream with your Lambda function. After you create this event source mapping, AWS Lambda starts polling the stream.

Run the following AWS CLI `create-event-source-mapping` command. After the command runs, note down the UUID. You'll need this UUID to refer to the event source mapping in any commands, for example, when deleting the event source mapping.

```
aws lambda create-event-source-mapping --function-name ProcessDynamoDBRecords \  
--batch-size 100 --starting-position LATEST --event-source DynamoDB-stream-arn
```

This creates a mapping between the specified DynamoDB stream and the Lambda function. You can associate a DynamoDB stream with multiple Lambda functions, and associate the same

Lambda function with multiple streams. However, the Lambda functions will share the read throughput for the stream they share.

You can get the list of event source mappings by running the following command.

```
aws lambda list-event-source-mappings
```

The list returns all of the event source mappings you created, and for each mapping it shows the `LastProcessingResult`, among other things. This field is used to provide an informative message if there are any problems. Values such as `No records processed` (indicates that AWS Lambda has not started polling or that there are no records in the stream) and `OK` (indicates AWS Lambda successfully read records from the stream and invoked your Lambda function) indicate that there are no issues. If there are issues, you receive an error message.

If you have a lot of event source mappings, use the `function-name` parameter to narrow down the results.

```
aws lambda list-event-source-mappings --function-name ProcessDynamoDBRecords
```

Test the setup

Test the end-to-end experience. As you perform table updates, DynamoDB writes event records to the stream. As AWS Lambda polls the stream, it detects new records in the stream and invokes your Lambda function on your behalf by passing events to the function.

1. In the DynamoDB console, add, update, and delete items to the table. DynamoDB writes records of these actions to the stream.
2. AWS Lambda polls the stream and when it detects updates to the stream, it invokes your Lambda function by passing in the event data it finds in the stream.
3. Your function runs and creates logs in Amazon CloudWatch. You can verify the logs reported in the Amazon CloudWatch console.

Clean up your resources

You can now delete the resources that you created for this tutorial, unless you want to retain them. By deleting AWS resources that you're no longer using, you prevent unnecessary charges to your AWS account.

To delete the Lambda function

1. Open the [Functions page](#) of the Lambda console.
2. Select the function that you created.
3. Choose **Actions, Delete**.
4. Type **confirm** in the text input field and choose **Delete**.

To delete the execution role

1. Open the [Roles page](#) of the IAM console.
2. Select the execution role that you created.
3. Choose **Delete**.
4. Enter the name of the role in the text input field and choose **Delete**.

To delete the DynamoDB table

1. Open the [Tables page](#) of the DynamoDB console.
2. Select the table you created.
3. Choose **Delete**.
4. Enter **delete** in the text box.
5. Choose **Delete table**.

Process Amazon EC2 lifecycle events with a Lambda function

You can use AWS Lambda to process lifecycle events from Amazon Elastic Compute Cloud and manage Amazon EC2 resources. Amazon EC2 sends events to [Amazon EventBridge \(CloudWatch Events\)](#) for [lifecycle events](#) such as when an instance changes state, when an Amazon Elastic Block Store volume snapshot completes, or when a spot instance is scheduled to be terminated. You configure EventBridge (CloudWatch Events) to forward those events to a Lambda function for processing.

EventBridge (CloudWatch Events) invokes your Lambda function asynchronously with the event document from Amazon EC2.

Example instance lifecycle event

```
{
  "version": "0",
  "id": "b6ba298a-7732-2226-xmpl-976312c1a050",
  "detail-type": "EC2 Instance State-change Notification",
  "source": "aws.ec2",
  "account": "111122223333",
  "time": "2019-10-02T17:59:30Z",
  "region": "us-east-1",
  "resources": [
    "arn:aws:ec2:us-east-1:111122223333:instance/i-0c314xmplcd5b8173"
  ],
  "detail": {
    "instance-id": "i-0c314xmplcd5b8173",
    "state": "running"
  }
}
```

For details on configuring events, see [Invoke a Lambda function on a schedule](#). For an example function that processes Amazon EBS snapshot notifications, see [EventBridge Scheduler for Amazon EBS](#).

You can also use the AWS SDK to manage instances and other resources with the Amazon EC2 API.

Granting permissions to EventBridge (CloudWatch Events)

To process lifecycle events from Amazon EC2, EventBridge (CloudWatch Events) needs permission to invoke your function. This permission comes from the function's [resource-based policy](#). If

you use the EventBridge (CloudWatch Events) console to configure an event trigger, the console updates the resource-based policy on your behalf. Otherwise, add a statement like the following:

Example resource-based policy statement for Amazon EC2 lifecycle notifications

```
{
  "Sid": "ec2-events",
  "Effect": "Allow",
  "Principal": {
    "Service": "events.amazonaws.com"
  },
  "Action": "lambda:InvokeFunction",
  "Resource": "arn:aws:lambda:us-east-1:12456789012:function:my-function",
  "Condition": {
    "ArnLike": {
      "AWS:SourceArn": "arn:aws:events:us-east-1:12456789012:rule/*"
    }
  }
}
```

To add a statement, use the `add-permission` AWS CLI command.

```
aws lambda add-permission --action lambda:InvokeFunction --statement-id ec2-events \
--principal events.amazonaws.com --function-name my-function --source-arn
'arn:aws:events:us-east-1:12456789012:rule/*'
```

If your function uses the AWS SDK to manage Amazon EC2 resources, add Amazon EC2 permissions to the function's [execution role](#).

Process Application Load Balancer requests with Lambda

You can use a Lambda function to process requests from an Application Load Balancer. Elastic Load Balancing supports Lambda functions as a target for an Application Load Balancer. Use load balancer rules to route HTTP requests to a function, based on path or header values. Process the request and return an HTTP response from your Lambda function.

Elastic Load Balancing invokes your Lambda function synchronously with an event that contains the request body and metadata.

Example Application Load Balancer request event

```
{
  "requestContext": {
    "elb": {
      "targetGroupArn": "arn:aws:elasticloadbalancing:us-
east-1:123456789012:targetgroup/lambda-279XGJDqGZ5rsrHC2Fjr/49e9d65c45c6791a"
    }
  },
  "httpMethod": "GET",
  "path": "/lambda",
  "queryStringParameters": {
    "query": "1234ABCD"
  },
  "headers": {
    "accept": "text/html,application/xhtml+xml,application/xml;q=0.9,image/
webp,image/apng,*/*;q=0.8",
    "accept-encoding": "gzip",
    "accept-language": "en-US,en;q=0.9",
    "connection": "keep-alive",
    "host": "lambda-alb-123578498.us-east-1.elb.amazonaws.com",
    "upgrade-insecure-requests": "1",
    "user-agent": "Mozilla/5.0 (Windows NT 10.0; Win64; x64) AppleWebKit/537.36
(KHTML, like Gecko) Chrome/71.0.3578.98 Safari/537.36",
    "x-amzn-trace-id": "Root=1-5c536348-3d683b8b04734faae651f476",
    "x-forwarded-for": "72.12.164.125",
    "x-forwarded-port": "80",
    "x-forwarded-proto": "http",
    "x-imforwards": "20"
  },
  "body": "",
  "isBase64Encoded": False
}
```



```
}
```

Your function processes the event and returns a response document to the load balancer in JSON. Elastic Load Balancing converts the document to an HTTP success or error response and returns it to the user.

Example response document format

```
{
  "statusCode": 200,
  "statusDescription": "200 OK",
  "isBase64Encoded": False,
  "headers": {
    "Content-Type": "text/html"
  },
  "body": "<h1>Hello from Lambda!</h1>"
}
```

To configure an Application Load Balancer as a function trigger, grant Elastic Load Balancing permission to run the function, create a target group that routes requests to the function, and add a rule to the load balancer that sends requests to the target group.

Use the `add-permission` command to add a permission statement to your function's resource-based policy.

```
aws lambda add-permission --function-name alb-function \
--statement-id load-balancer --action "lambda:InvokeFunction" \
--principal elasticloadbalancing.amazonaws.com
```

You should see the following output:

```
{
  "Statement": [{"Sid": "load-balancer", "Effect": "Allow", "Principal":
{"Service": "elasticloadbalancing.amazonaws.com"}, "Action": "lambda:InvokeFunction", "Resource": "arn:aws:lambda:us-west-2:123456789012:function:alb-function"}]
```

For instructions on configuring the Application Load Balancer listener and target group, see [Lambda functions as a target](#) in the *User Guide for Application Load Balancers*.

Invoke a Lambda function on a schedule

[Amazon EventBridge Scheduler](#) is a serverless scheduler that allows you to create, run, and manage tasks from one central, managed service. With EventBridge Scheduler, you can create schedules using cron and rate expressions for recurring patterns, or configure one-time invocations. You can set up flexible time windows for delivery, define retry limits, and set the maximum retention time for unprocessed events.

When you set up EventBridge Scheduler with Lambda, EventBridge Scheduler invokes your Lambda function asynchronously. This page explains how to use EventBridge Scheduler to invoke a Lambda function on a schedule.

Set up the execution role

When you create a new schedule, EventBridge Scheduler must have permission to invoke its target API operation on your behalf. You grant these permissions to EventBridge Scheduler using an *execution role*. The permission policy you attach to your schedule's execution role defines the required permissions. These permissions depend on the target API you want EventBridge Scheduler to invoke.

When you use the EventBridge Scheduler console to create a schedule, as in the following procedure, EventBridge Scheduler automatically sets up an execution role based on your selected target. If you want to create a schedule using one of the EventBridge Scheduler SDKs, the AWS CLI, or AWS CloudFormation, you must have an existing execution role that grants the permissions EventBridge Scheduler requires to invoke a target. For more information about manually setting up an execution role for your schedule, see [Setting up an execution role](#) in the *EventBridge Scheduler User Guide*.

Create a schedule

To create a schedule by using the console

1. Open the Amazon EventBridge Scheduler console at <https://console.aws.amazon.com/scheduler/home>.
2. On the **Schedules** page, choose **Create schedule**.
3. On the **Specify schedule detail** page, in the **Schedule name and description** section, do the following:

- a. For **Schedule name**, enter a name for your schedule. For example, **MyTestSchedule**.
- b. (Optional) For **Description**, enter a description for your schedule. For example, **My first schedule**.
- c. For **Schedule group**, choose a schedule group from the dropdown list. If you don't have a group, choose **default**. To create a schedule group, choose **create your own schedule**.

You use schedule groups to add tags to groups of schedules.

4. • Choose your schedule options.

Occurrence	Do this...
<p>One-time schedule</p> <p>A one-time schedule invokes a target only once at the date and time that you specify.</p>	<p>For Date and time, do the following:</p> <ul style="list-style-type: none"> • Enter a valid date in YYYY/MM/DD format. • Enter a timestamp in 24-hour hh:mm format. • For Timezone, choose the timezone.
<p>Recurring schedule</p> <p>A recurring schedule invokes a target at a rate that you specify using a cron expression or rate expression.</p>	<p>a. For Schedule type, do one of the following:</p> <ul style="list-style-type: none"> • To use a cron expression to define the schedule, choose Cron-based schedule and enter the cron expression. • To use a rate expression to define the schedule, choose Rate-based schedule and enter the rate expression.

Occurrence	Do this...	
	<p>For more information about cron and rate expressions, see Schedule types on EventBridge Scheduler in the <i>Amazon EventBridge Scheduler User Guide</i>.</p> <p>b. For Flexible time window, choose Off to turn off the option, or choose one of the pre-defined time windows. For example, if you choose 15 minutes and you set a recurring schedule to invoke its target once every hour, the schedule runs within 15 minutes after the start of every hour.</p>	

5. (Optional) If you chose **Recurring schedule** in the previous step, in the **Timeframe** section, do the following:
 - a. For **Timezone**, choose a timezone.
 - b. For **Start date and time**, enter a valid date in YYYY/MM/DD format, and then specify a timestamp in 24-hour hh:mm format.
 - c. For **End date and time**, enter a valid date in YYYY/MM/DD format, and then specify a timestamp in 24-hour hh:mm format.
6. Choose **Next**.
7. On the **Select target** page, choose the AWS API operation that EventBridge Scheduler invokes:
 - a. Choose **AWS Lambda Invoke**.

- b. In the **Invoke** section, select a function or choose **Create new Lambda function**.
 - c. (Optional) Enter a JSON payload. If you don't enter a payload, EventBridge Scheduler uses an empty event to invoke the function.
8. Choose **Next**.
 9. On the **Settings** page, do the following:
 - a. To turn on the schedule, under **Schedule state**, toggle **Enable schedule**.
 - b. To configure a retry policy for your schedule, under **Retry policy and dead-letter queue (DLQ)**, do the following:
 - Toggle **Retry**.
 - For **Maximum age of event**, enter the maximum **hour(s)** and **min(s)** that EventBridge Scheduler must keep an unprocessed event.
 - The maximum time is 24 hours.
 - For **Maximum retries**, enter the maximum number of times EventBridge Scheduler retries the schedule if the target returns an error.

The maximum value is 185 retries.

With retry policies, if a schedule fails to invoke its target, EventBridge Scheduler re-runs the schedule. If configured, you must set the maximum retention time and retries for the schedule.

- c. Choose where EventBridge Scheduler stores undelivered events.

Dead-letter queue (DLQ) option	Do this...	
Don't store	Choose None .	
Store the event in the same AWS account where you're creating the schedule	a. Choose Select an Amazon SQS queue in my AWS account as a DLQ .	

Dead-letter queue (DLQ) option	Do this...	
	b. Choose the Amazon Resource Name (ARN) of the Amazon SQS queue.	
Store the event in a different AWS account from where you're creating the schedule	a. Choose Specify an Amazon SQS queue in other AWS accounts as a DLQ . b. Enter the Amazon Resource Name (ARN) of the Amazon SQS queue.	

- d. To use a customer managed key to encrypt your target input, under **Encryption**, choose **Customize encryption settings (advanced)**.

If you choose this option, enter an existing KMS key ARN or choose **Create an AWS KMS key** to navigate to the AWS KMS console. For more information about how EventBridge Scheduler encrypts your data at rest, see [Encryption at rest](#) in the *Amazon EventBridge Scheduler User Guide*.

- e. To have EventBridge Scheduler create a new execution role for you, choose **Create new role for this schedule**. Then, enter a name for **Role name**. If you choose this option, EventBridge Scheduler attaches the required permissions necessary for your templated target to the role.

10. Choose **Next**.

11. In the **Review and create schedule** page, review the details of your schedule. In each section, choose **Edit** to go back to that step and edit its details.

12. Choose **Create schedule**.

You can view a list of your new and existing schedules on the **Schedules** page. Under the **Status** column, verify that your new schedule is **Enabled**.

To confirm that EventBridge Scheduler invoked the function, [check the function's Amazon CloudWatch logs](#).

Related resources

For more information about EventBridge Scheduler, see the following:

- [EventBridge Scheduler User Guide](#)
- [EventBridge Scheduler API Reference](#)
- [EventBridge Scheduler Pricing](#)

Using AWS Lambda with AWS IoT

AWS IoT provides secure communication between internet-connected devices (such as sensors) and the AWS Cloud. This makes it possible for you to collect, store, and analyze telemetry data from multiple devices.

You can create AWS IoT rules for your devices to interact with AWS services. The AWS IoT [Rules Engine](#) provides a SQL-based language to select data from message payloads and send the data to other services, such as Amazon S3, Amazon DynamoDB, and AWS Lambda. You define a rule to invoke a Lambda function when you want to invoke another AWS service or a third-party service.

When an incoming IoT message triggers the rule, AWS IoT invokes your Lambda function [asynchronously](#) and passes data from the IoT message to the function.

The following example shows a moisture reading from a greenhouse sensor. The **row** and **pos** values identify the location of the sensor. This example event is based on the greenhouse type in the [AWS IoT Rules tutorials](#).

Example AWS IoT message event

```
{
  "row" : "10",
  "pos" : "23",
  "moisture" : "75"
}
```

For asynchronous invocation, Lambda queues the message and [retries](#) if your function returns an error. Configure your function with a [destination](#) to retain events that your function could not process.

You need to grant permission for the AWS IoT service to invoke your Lambda function. Use the `add-permission` command to add a permission statement to your function's resource-based policy.

```
aws lambda add-permission --function-name my-function \  
--statement-id iot-events --action "lambda:InvokeFunction" --principal  
iot.amazonaws.com
```

You should see the following output:

```
{
  "Statement": "{\\"Sid\\":\\"iot-events\\",\\"Effect\\":\\"Allow\\",\\"Principal\\":
{\\"Service\\":\\"iot.amazonaws.com\\"},\\"Action\\":\\"lambda:InvokeFunction\\",\\"Resource\\":
\\"arn:aws:lambda:us-east-1:123456789012:function:my-function\\"}"
}
```

For more information about how to use Lambda with AWS IoT, see [Creating an AWS Lambda rule](#).

How Lambda processes records from Amazon Kinesis Data Streams

You can use a Lambda function to process records in an [Amazon Kinesis data stream](#). You can map a Lambda function to a Kinesis Data Streams shared-throughput consumer (standard iterator), or to a dedicated-throughput consumer with [enhanced fan-out](#). For standard iterators, Lambda polls each shard in your Kinesis stream for records using HTTP protocol. The event source mapping shares read throughput with other consumers of the shard.

For details about Kinesis data streams, see [Reading Data from Amazon Kinesis Data Streams](#).

Note

Kinesis charges for each shard and, for enhanced fan-out, data read from the stream. For pricing details, see [Amazon Kinesis pricing](#).

Topics

- [Polling and batching streams](#)
- [Example event](#)
- [Process Amazon Kinesis Data Streams records with Lambda](#)
- [Configuring partial batch response with Kinesis Data Streams and Lambda](#)
- [Retain discarded batch records for a Kinesis Data Streams event source in Lambda](#)
- [Implementing stateful Kinesis Data Streams processing in Lambda](#)
- [Lambda parameters for Amazon Kinesis Data Streams event source mappings](#)
- [Using event filtering with a Kinesis event source](#)
- [Tutorial: Using Lambda with Kinesis Data Streams](#)

Polling and batching streams

Lambda reads records from the data stream and invokes your function [synchronously](#) with an event that contains stream records. Lambda reads records in batches and invokes your function to process records from the batch. Each batch contains records from a single shard/data stream.

For standard Kinesis data streams, Lambda polls shards in your stream for records at a rate of once per second for each shard. For [Kinesis enhanced fan-out](#), Lambda uses an HTTP/2 connection to listen for records being pushed from Kinesis. When records are available, Lambda invokes your function and waits for the result.

By default, Lambda invokes your function as soon as records are available. If the batch that Lambda reads from the event source has only one record in it, Lambda sends only one record to the function. To avoid invoking the function with a small number of records, you can tell the event source to buffer records for up to 5 minutes by configuring a *batching window*. Before invoking the function, Lambda continues to read records from the event source until it has gathered a full batch, the batching window expires, or the batch reaches the payload limit of 6 MB. For more information, see [Batching behavior](#).

Warning

Lambda event source mappings process each event at least once, and duplicate processing of records can occur. To avoid potential issues related to duplicate events, we strongly recommend that you make your function code idempotent. To learn more, see [How do I make my Lambda function idempotent](#) in the AWS Knowledge Center.

Lambda doesn't wait for any configured [extensions](#) to complete before sending the next batch for processing. In other words, your extensions may continue to run as Lambda processes the next batch of records. This can cause throttling issues if you breach any of your account's [concurrency](#) settings or limits. To detect whether this is a potential issue, monitor your functions and check whether you're seeing higher [concurrency metrics](#) than expected for your event source mapping. Due to short times in between invokes, Lambda may briefly report higher concurrency usage than the number of shards. This can be true even for Lambda functions without extensions.

Configure the [ParallelizationFactor](#) setting to process one shard of a Kinesis data stream with more than one Lambda invocation simultaneously. You can specify the number of concurrent batches that Lambda polls from a shard via a parallelization factor from 1 (default) to 10. For example, when you set `ParallelizationFactor` to 2, you can have 200 concurrent Lambda invocations at maximum to process 100 Kinesis data shards (though in practice, you may see different values for the `ConcurrentExecutions` metric). This helps scale up the processing throughput when the data volume is volatile and the `IteratorAge` is high. When you increase the number of concurrent batches per shard, Lambda still ensures in-order processing at the partition-key level.

You can also use `ParallelizationFactor` with Kinesis aggregation. The behavior of the event source mapping depends on whether you're using [enhanced fan-out](#):

- **Without enhanced fan-out:** All of the events inside an aggregated event must have the same partition key. The partition key must also match that of the aggregated event. If the events inside the aggregated event have different partition keys, Lambda cannot guarantee in-order processing of the events by partition key.
- **With enhanced fan-out:** First, Lambda decodes the aggregated event into its individual events. The aggregated event can have a different partition key than events it contains. However, events that don't correspond to the partition key are [dropped and lost](#). Lambda doesn't process these events, and doesn't send them to a configured failure destination.

Example event

Example

```
{
  "Records": [
    {
      "kinesis": {
        "kinesisSchemaVersion": "1.0",
        "partitionKey": "1",
        "sequenceNumber":
"49590338271490256608559692538361571095921575989136588898",
        "data": "SGVsbG8sIHRoaXMgaXMgYSB0ZXN0Lg==",
        "approximateArrivalTimestamp": 1545084650.987
      },
      "eventSource": "aws:kinesis",
      "eventVersion": "1.0",
      "eventID":
"shardId-000000000006:49590338271490256608559692538361571095921575989136588898",
      "eventName": "aws:kinesis:record",
      "invokeIdentityArn": "arn:aws:iam::123456789012:role/lambda-role",
      "awsRegion": "us-east-2",
      "eventSourceARN": "arn:aws:kinesis:us-east-2:123456789012:stream/lambda-
stream"
    },
    {
      "kinesis": {
        "kinesisSchemaVersion": "1.0",
        "partitionKey": "1",
```

```
        "sequenceNumber":
          "49590338271490256608559692540925702759324208523137515618",
        "data": "VGhpcyBpcyBvbmx5IGEdGVzdC4=",
        "approximateArrivalTimestamp": 1545084711.166
      },
      "eventSource": "aws:kinesis",
      "eventVersion": "1.0",
      "eventID":
        "shardId-000000000006:49590338271490256608559692540925702759324208523137515618",
      "eventName": "aws:kinesis:record",
      "invokeIdentityArn": "arn:aws:iam::123456789012:role/lambda-role",
      "awsRegion": "us-east-2",
      "eventSourceARN": "arn:aws:kinesis:us-east-2:123456789012:stream/lambda-
stream"
    }
  ]
}
```

Process Amazon Kinesis Data Streams records with Lambda

To process Amazon Kinesis Data Streams records with Lambda, create a consumer for your stream and then create a Lambda event source mapping.

Configuring your data stream and function

Your Lambda function is a consumer application for your data stream. It processes one batch of records at a time from each shard. You can map a Lambda function to a shared-throughput consumer (standard iterator), or to a dedicated-throughput consumer with enhanced fan-out.

- **Standard iterator:** Lambda polls each shard in your Kinesis stream for records at a base rate of once per second. When more records are available, Lambda keeps processing batches until the function catches up with the stream. The event source mapping shares read throughput with other consumers of the shard.
- **Enhanced fan-out:** To minimize latency and maximize read throughput, create a data stream consumer with [enhanced fan-out](#). Enhanced fan-out consumers get a dedicated connection to each shard that doesn't impact other applications reading from the stream. Stream consumers use HTTP/2 to reduce latency by pushing records to Lambda over a long-lived connection and by compressing request headers. You can create a stream consumer with the [RegisterStreamConsumer](#) API.

```
aws kinesis register-stream-consumer \  
--consumer-name con1 \  
--stream-arn arn:aws:kinesis:us-east-2:123456789012:stream/lambda-stream
```

You should see the following output:

```
{  
  "Consumer": {  
    "ConsumerName": "con1",  
    "ConsumerARN": "arn:aws:kinesis:us-east-2:123456789012:stream/lambda-stream/  
consumer/con1:1540591608",  
    "ConsumerStatus": "CREATING",  
    "ConsumerCreationTimestamp": 1540591608.0  
  }  
}
```

To increase the speed at which your function processes records, [add shards to your data stream](#). Lambda processes records in each shard in order. It stops processing additional records in a shard if your function returns an error. With more shards, there are more batches being processed at once, which lowers the impact of errors on concurrency.

If your function can't scale up to handle the total number of concurrent batches, [request a quota increase](#) or [reserve concurrency](#) for your function.

Create an event source mapping to invoke a Lambda function

To invoke your Lambda function with records from your data stream, create an [event source mapping](#). You can create multiple event source mappings to process the same data with multiple Lambda functions, or to process items from multiple data streams with a single function. When processing items from multiple streams, each batch contains records from only a single shard or stream.

You can configure event source mappings to process records from a stream in a different AWS account. To learn more, see [the section called "Cross-account mappings"](#).

Before you create an event source mapping, you need to give your Lambda function permission to read from a Kinesis data stream. Lambda needs the following permissions to manage resources related to your Kinesis data stream:

- [kinesis:DescribeStream](#)

- [kinesis:DescribeStreamSummary](#)
- [kinesis:GetRecords](#)
- [kinesis:GetShardIterator](#)
- [kinesis:ListShards](#)
- [kinesis:ListStreams](#)
- [kinesis:SubscribeToShard](#)

The AWS managed policy [AWSLambdaKinesisExecutionRole](#) includes these permissions. Add this managed policy to your function as described in the following procedure.

AWS Management Console

To add Kinesis permissions to your function

1. Open the [Functions page](#) of the Lambda console and select your function.
2. In the **Configuration** tab, select **Permissions**.
3. In the **Execution role** pane, under **Role name**, choose the link to your function's execution role. This link opens the page for that role in the IAM console.
4. In the **Permissions policies** pane, choose **Add permissions**, then select **Attach policies**.
5. In the search field, enter **AWSLambdaKinesisExecutionRole**.
6. Select the checkbox next to the policy and choose **Add permission**.

AWS CLI

To add Kinesis permissions to your function

- Run the following CLI command to add the `AWSLambdaKinesisExecutionRole` policy to your function's execution role:

```
aws iam attach-role-policy \  
--role-name MyFunctionRole \  
--policy-arn arn:aws:iam::aws:policy/service-role/AWSLambdaKinesisExecutionRole
```

AWS SAM

To add Kinesis permissions to your function

- In your function's definition, add the `Policies` property as shown in the following example:

```
Resources:
  MyFunction:
    Type: AWS::Serverless::Function
    Properties:
      CodeUri: ./my-function/
      Handler: index.handler
      Runtime: nodejs22.x
      Policies:
        - AWSLambdaKinesisExecutionRole
```

After configuring the required permissions, create the event source mapping.

AWS Management Console

To create the Kinesis event source mapping

1. Open the [Functions page](#) of the Lambda console and select your function.
2. In the **Function overview** pane, choose **Add trigger**.
3. Under **Trigger configuration**, for the source, select **Kinesis**.
4. Select the Kinesis stream you want to create the event source mapping for and, optionally, a consumer of your stream.
5. (Optional) edit the **Batch size**, **Starting position**, and **Batch window** for your event source mapping.
6. Choose **Add**.

When creating your event source mapping from the console, your IAM role must have the [kinesis:ListStreams](#) and [kinesis:ListStreamConsumers](#) permissions.

AWS CLI

To create the Kinesis event source mapping

- Run the following CLI command to create a Kinesis event source mapping. Choose your own batch size and starting position according to your use case.

```
aws lambda create-event-source-mapping \  
--function-name MyFunction \  
--event-source-arn arn:aws:kinesis:us-east-2:123456789012:stream/lambda-stream \  
--starting-position LATEST \  
--batch-size 100
```

To specify a batching window, add the `--maximum-batching-window-in-seconds` option. For more information about using this and other parameters, see [create-event-source-mapping](#) in the *AWS CLI Command Reference*.

AWS SAM

To create the Kinesis event source mapping

- In your function's definition, add the `KinesisEvent` property as shown in the following example:

```
Resources:  
  MyFunction:  
    Type: AWS::Serverless::Function  
    Properties:  
      CodeUri: ./my-function/  
      Handler: index.handler  
      Runtime: nodejs22.x  
      Policies:  
        - AWSLambdaKinesisExecutionRole  
    Events:  
      KinesisEvent:  
        Type: Kinesis  
        Properties:  
          Stream: !GetAtt MyKinesisStream.Arn  
          StartingPosition: LATEST  
          BatchSize: 100  
  
  MyKinesisStream:
```

```
Type: AWS::Kinesis::Stream
Properties:
  ShardCount: 1
```

To learn more about creating an event source mapping for Kinesis Data Streams in AWS SAM, see [Kinesis](#) in the *AWS Serverless Application Model Developer Guide*.

Polling and stream starting position

Be aware that stream polling during event source mapping creation and updates is eventually consistent.

- During event source mapping creation, it may take several minutes to start polling events from the stream.
- During event source mapping updates, it may take several minutes to stop and restart polling events from the stream.

This behavior means that if you specify LATEST as the starting position for the stream, the event source mapping could miss events during creation or updates. To ensure that no events are missed, specify the stream starting position as TRIM_HORIZON or AT_TIMESTAMP.

Creating a cross-account event source mapping

Amazon Kinesis Data Streams supports [resource-based policies](#). Because of this, you can process data ingested into a stream in one AWS account with a Lambda function in another account.

To create an event source mapping for your Lambda function using a Kinesis stream in a different AWS account, you must configure the stream using a resource-based policy to give your Lambda function permission to read items. To learn how to configure your stream to allow cross-account access, see [Sharing access with cross-account AWS Lambda functions](#) in the *Amazon Kinesis Streams Developer guide*.

Once you've configured your stream with a resource-based policy that gives your Lambda function the required permissions, create the event source mapping using any of the methods described in the previous section.

If you choose to create your event source mapping using the Lambda console, paste the ARN of your stream directly into the input field. If you want to specify a consumer for your stream, pasting the ARN of the consumer automatically populates the stream field.

Configuring partial batch response with Kinesis Data Streams and Lambda

When consuming and processing streaming data from an event source, by default Lambda checkpoints to the highest sequence number of a batch only when the batch is a complete success. Lambda treats all other results as a complete failure and retries processing the batch up to the retry limit. To allow for partial successes while processing batches from a stream, turn on `ReportBatchItemFailures`. Allowing partial successes can help to reduce the number of retries on a record, though it doesn't entirely prevent the possibility of retries in a successful record.

To turn on `ReportBatchItemFailures`, include the enum value **ReportBatchItemFailures** in the [FunctionResponseTypes](#) list. This list indicates which response types are enabled for your function. You can configure this list when you [create](#) or [update](#) an event source mapping.

Report syntax

When configuring reporting on batch item failures, the `StreamsEventResponse` class is returned with a list of batch item failures. You can use a `StreamsEventResponse` object to return the sequence number of the first failed record in the batch. You can also create your own custom class using the correct response syntax. The following JSON structure shows the required response syntax:

```
{
  "batchItemFailures": [
    {
      "itemIdentifier": "<SequenceNumber>"
    }
  ]
}
```

Note

If the `batchItemFailures` array contains multiple items, Lambda uses the record with the lowest sequence number as the checkpoint. Lambda then retries all records starting from that checkpoint.

Success and failure conditions

Lambda treats a batch as a complete success if you return any of the following:

- An empty `batchItemFailure` list
- A null `batchItemFailure` list
- An empty `EventResponse`
- A null `EventResponse`

Lambda treats a batch as a complete failure if you return any of the following:

- An empty string `itemIdentifier`
- A null `itemIdentifier`
- An `itemIdentifier` with a bad key name

Lambda retries failures based on your retry strategy.

Bisecting a batch

If your invocation fails and `BisectBatchOnFunctionError` is turned on, the batch is bisected regardless of your `ReportBatchItemFailures` setting.

When a partial batch success response is received and both `BisectBatchOnFunctionError` and `ReportBatchItemFailures` are turned on, the batch is bisected at the returned sequence number and Lambda retries only the remaining records.

Here are some examples of function code that return the list of failed message IDs in the batch:

.NET

AWS SDK for .NET

Note

There's more on GitHub. Find the complete example and learn how to set up and run in the [Serverless examples](#) repository.

Reporting Kinesis batch item failures with Lambda using .NET.

```
// Copyright Amazon.com, Inc. or its affiliates. All Rights Reserved.
// SPDX-License-Identifier: Apache-2.0
using System.Text;
using System.Text.Json.Serialization;
using Amazon.Lambda.Core;
using Amazon.Lambda.KinesisEvents;
using AWS.Lambda.Powertools.Logging;

// Assembly attribute to enable the Lambda function's JSON input to be converted
// into a .NET class.
[assembly: LambdaSerializer(typeof(Amazon.Lambda.Serialization.SystemTextJson.DefaultLambdaJsonSerializer))]

namespace KinesisIntegration;

public class Function
{
    // Powertools Logger requires an environment variables against your function
    // POWERTOOLS_SERVICE_NAME
    [Logging(LogEvent = true)]
    public async Task<StreamsEventResponse> FunctionHandler(KinesisEvent evnt,
        ILambdaContext context)
    {
        if (evnt.Records.Count == 0)
        {
            Logger.LogInformation("Empty Kinesis Event received");
            return new StreamsEventResponse();
        }

        foreach (var record in evnt.Records)
        {
            try
            {
                Logger.LogInformation($"Processed Event with EventId:
{record.EventId}");
                string data = await GetRecordDataAsync(record.Kinesis, context);
                Logger.LogInformation($"Data: {data}");
                // TODO: Do interesting work based on the new data
            }
            catch (Exception ex)
            {
                Logger.LogError($"An error occurred {ex.Message}");
            }
        }
    }
}
```

```

        /* Since we are working with streams, we can return the failed
        item immediately.
           Lambda will immediately begin to retry processing from this
        failed item onwards. */
        return new StreamsEventResponse
        {
            BatchItemFailures = new
List<StreamsEventResponse.BatchItemFailure>
            {
                new StreamsEventResponse.BatchItemFailure
{ ItemIdentifier = record.Kinesis.SequenceNumber }
            }
        };
    }
}
    Logger.LogInformation($"Successfully processed {evnt.Records.Count}
records.");
    return new StreamsEventResponse();
}

private async Task<string> GetRecordDataAsync(KinesisEvent.Record record,
ILambdaContext context)
{
    byte[] bytes = record.Data.ToArray();
    string data = Encoding.UTF8.GetString(bytes);
    await Task.CompletedTask; //Placeholder for actual async work
    return data;
}
}

public class StreamsEventResponse
{
    [JsonPropertyName("batchItemFailures")]
    public IList<BatchItemFailure> BatchItemFailures { get; set; }
    public class BatchItemFailure
    {
        [JsonPropertyName("itemIdentifier")]
        public string ItemIdentifier { get; set; }
    }
}
}

```

Go

SDK for Go V2

 **Note**

There's more on GitHub. Find the complete example and learn how to set up and run in the [Serverless examples](#) repository.

Reporting Kinesis batch item failures with Lambda using Go.

```
// Copyright Amazon.com, Inc. or its affiliates. All Rights Reserved.
// SPDX-License-Identifier: Apache-2.0
package main

import (
    "context"
    "fmt"
    "github.com/aws/aws-lambda-go/events"
    "github.com/aws/aws-lambda-go/lambda"
)

func handler(ctx context.Context, kinesisEvent events.KinesisEvent)
    (map[string]interface{}, error) {
    batchItemFailures := []map[string]interface{}{}

    for _, record := range kinesisEvent.Records {
        curRecordSequenceNumber := ""

        // Process your record
        if /* Your record processing condition here */ {
            curRecordSequenceNumber = record.Kinesis.SequenceNumber
        }

        // Add a condition to check if the record processing failed
        if curRecordSequenceNumber != "" {
            batchItemFailures = append(batchItemFailures, map[string]interface{}{
                "itemIdentifier": curRecordSequenceNumber})
        }
    }

    kinesisBatchResponse := map[string]interface{}{
```

```
"batchItemFailures": batchItemFailures,
}
return kinesisBatchResponse, nil
}

func main() {
    lambda.Start(handler)
}
```

Java

SDK for Java 2.x

Note

There's more on GitHub. Find the complete example and learn how to set up and run in the [Serverless examples](#) repository.

Reporting Kinesis batch item failures with Lambda using Java.

```
// Copyright Amazon.com, Inc. or its affiliates. All Rights Reserved.
// SPDX-License-Identifier: Apache-2.0
import com.amazonaws.services.lambda.runtime.Context;
import com.amazonaws.services.lambda.runtime.RequestHandler;
import com.amazonaws.services.lambda.runtime.events.KinesisEvent;
import com.amazonaws.services.lambda.runtime.events.StreamsEventResponse;

import java.io.Serializable;
import java.util.ArrayList;
import java.util.List;

public class ProcessKinesisRecords implements RequestHandler<KinesisEvent,
StreamsEventResponse> {

    @Override
    public StreamsEventResponse handleRequest(KinesisEvent input, Context
context) {

        List<StreamsEventResponse.BatchItemFailure> batchItemFailures = new
ArrayList<>();
```



```

        String curRecordSequenceNumber = "";

        for (KinesisEvent.KinesisEventRecord kinesisEventRecord :
input.getRecords()) {
            try {
                //Process your record
                KinesisEvent.Record kinesisRecord =
kinesisEventRecord.getKinesis();
                curRecordSequenceNumber = kinesisRecord.getSequenceNumber();

            } catch (Exception e) {
                /* Since we are working with streams, we can return the failed
item immediately.
                Lambda will immediately begin to retry processing from this
failed item onwards. */
                batchItemFailures.add(new
StreamsEventResponse.BatchItemFailure(curRecordSequenceNumber));
                return new StreamsEventResponse(batchItemFailures);
            }
        }

        return new StreamsEventResponse(batchItemFailures);
    }
}

```

JavaScript

SDK for JavaScript (v3)

Note

There's more on GitHub. Find the complete example and learn how to set up and run in the [Serverless examples](#) repository.

Reporting Kinesis batch item failures with Lambda using Javascript.

```

// Copyright Amazon.com, Inc. or its affiliates. All Rights Reserved.
// SPDX-License-Identifier: Apache-2.0
exports.handler = async (event, context) => {
    for (const record of event.Records) {

```

```

    try {
      console.log(`Processed Kinesis Event - EventID: ${record.eventID}`);
      const recordData = await getRecordDataAsync(record.kinesis);
      console.log(`Record Data: ${recordData}`);
      // TODO: Do interesting work based on the new data
    } catch (err) {
      console.error(`An error occurred ${err}`);
      /* Since we are working with streams, we can return the failed item
      immediately.
         Lambda will immediately begin to retry processing from this failed
      item onwards. */
      return {
        batchItemFailures: [{ itemIdentifier: record.kinesis.sequenceNumber }],
      };
    }
  }
  console.log(`Successfully processed ${event.Records.length} records.`);
  return { batchItemFailures: [] };
};

async function getRecordDataAsync(payload) {
  var data = Buffer.from(payload.data, "base64").toString("utf-8");
  await Promise.resolve(1); //Placeholder for actual async work
  return data;
}

```

Reporting Kinesis batch item failures with Lambda using TypeScript.

```

// Copyright Amazon.com, Inc. or its affiliates. All Rights Reserved.
// SPDX-License-Identifier: Apache-2.0
import {
  KinesisStreamEvent,
  Context,
  KinesisStreamHandler,
  KinesisStreamRecordPayload,
  KinesisStreamBatchResponse,
} from "aws-lambda";
import { Buffer } from "buffer";
import { Logger } from "@aws-lambda-powertools/logger";

const logger = new Logger({
  logLevel: "INFO",

```

```
    serviceName: "kinesis-stream-handler-sample",
  });

export const functionHandler: KinesisStreamHandler = async (
  event: KinesisStreamEvent,
  context: Context
): Promise<KinesisStreamBatchResponse> => {
  for (const record of event.Records) {
    try {
      logger.info(`Processed Kinesis Event - EventID: ${record.eventID}`);
      const recordData = await getRecordDataAsync(record.kinesis);
      logger.info(`Record Data: ${recordData}`);
      // TODO: Do interesting work based on the new data
    } catch (err) {
      logger.error(`An error occurred ${err}`);
      /* Since we are working with streams, we can return the failed item
      immediately.
         Lambda will immediately begin to retry processing from this failed
      item onwards. */
      return {
        batchItemFailures: [{ itemIdentifier: record.kinesis.sequenceNumber }],
      };
    }
  }
  logger.info(`Successfully processed ${event.Records.length} records.`);
  return { batchItemFailures: [] };
};

async function getRecordDataAsync(
  payload: KinesisStreamRecordPayload
): Promise<string> {
  var data = Buffer.from(payload.data, "base64").toString("utf-8");
  await Promise.resolve(1); //Placeholder for actual async work
  return data;
}
```

PHP

SDK for PHP

 **Note**

There's more on GitHub. Find the complete example and learn how to set up and run in the [Serverless examples](#) repository.

Reporting Kinesis batch item failures with Lambda using PHP.

```
// Copyright Amazon.com, Inc. or its affiliates. All Rights Reserved.
// SPDX-License-Identifier: Apache-2.0
<?php

# using bref/bref and bref/logger for simplicity

use Bref\Context\Context;
use Bref\Event\Kinesis\KinesisEvent;
use Bref\Event\Handler as StdHandler;
use Bref\Logger\StderrLogger;

require __DIR__ . '/vendor/autoload.php';

class Handler implements StdHandler
{
    private StderrLogger $logger;
    public function __construct(StderrLogger $logger)
    {
        $this->logger = $logger;
    }

    /**
     * @throws JsonException
     * @throws \Bref\Event\InvalidLambdaEvent
     */
    public function handle(mixed $event, Context $context): array
    {
        $kinesisEvent = new KinesisEvent($event);
        $this->logger->info("Processing records");
        $records = $kinesisEvent->getRecords();
    }
}
```

```
$failedRecords = [];
foreach ($records as $record) {
    try {
        $data = $record->getData();
        $this->logger->info(json_encode($data));
        // TODO: Do interesting work based on the new data
    } catch (Exception $e) {
        $this->logger->error($e->getMessage());
        // failed processing the record
        $failedRecords[] = $record->getSequenceNumber();
    }
}
$totalRecords = count($records);
$this->logger->info("Successfully processed $totalRecords records");

// change format for the response
$failures = array_map(
    fn(string $sequenceNumber) => ['itemIdentifier' => $sequenceNumber],
    $failedRecords
);

return [
    'batchItemFailures' => $failures
];
}

$logger = new StderrLogger();
return new Handler($logger);
```

Python

SDK for Python (Boto3)

Note

There's more on GitHub. Find the complete example and learn how to set up and run in the [Serverless examples](#) repository.

Reporting Kinesis batch item failures with Lambda using Python.

```
# Copyright Amazon.com, Inc. or its affiliates. All Rights Reserved.
# SPDX-License-Identifier: Apache-2.0
def handler(event, context):
    records = event.get("Records")
    curRecordSequenceNumber = ""

    for record in records:
        try:
            # Process your record
            curRecordSequenceNumber = record["kinesis"]["sequenceNumber"]
        except Exception as e:
            # Return failed record's sequence number
            return {"batchItemFailures":[{"itemIdentifier":
curRecordSequenceNumber}]}

    return {"batchItemFailures":[]}
```

Ruby

SDK for Ruby

Note

There's more on GitHub. Find the complete example and learn how to set up and run in the [Serverless examples](#) repository.

Reporting Kinesis batch item failures with Lambda using Ruby.

```
# Copyright Amazon.com, Inc. or its affiliates. All Rights Reserved.
# SPDX-License-Identifier: Apache-2.0
require 'aws-sdk'

def lambda_handler(event:, context:)
    batch_item_failures = []

    event['Records'].each do |record|
        begin
            puts "Processed Kinesis Event - EventID: #{record['eventID']}"
            record_data = get_record_data_async(record['kinesis'])
```

```

    puts "Record Data: #{record_data}"
    # TODO: Do interesting work based on the new data
  rescue StandardError => err
    puts "An error occurred #{err}"
    # Since we are working with streams, we can return the failed item
    immediately.
    # Lambda will immediately begin to retry processing from this failed item
    onwards.
    return { batchItemFailures: [{ itemIdentifier: record['kinesis']
['sequenceNumber'] }] }
  end
end

puts "Successfully processed #{event['Records'].length} records."
{ batchItemFailures: batch_item_failures }
end

def get_record_data_async(payload)
  data = Base64.decode64(payload['data']).force_encoding('utf-8')
  # Placeholder for actual async work
  sleep(1)
  data
end
end

```

Rust

SDK for Rust

Note

There's more on GitHub. Find the complete example and learn how to set up and run in the [Serverless examples](#) repository.

Reporting Kinesis batch item failures with Lambda using Rust.

```

// Copyright Amazon.com, Inc. or its affiliates. All Rights Reserved.
// SPDX-License-Identifier: Apache-2.0
use aws_lambda_events::{
    event::kinesis::KinesisEvent,
    kinesis::KinesisEventRecord,
    streams::{KinesisBatchItemFailure, KinesisEventResponse},

```

```

};
use lambda_runtime::{run, service_fn, Error, LambdaEvent};

async fn function_handler(event: LambdaEvent<KinesisEvent>) ->
Result<KinesisEventResponse, Error> {
    let mut response = KinesisEventResponse {
        batch_item_failures: vec![],
    };

    if event.payload.records.is_empty() {
        tracing::info!("No records found. Exiting.");
        return Ok(response);
    }

    for record in &event.payload.records {
        tracing::info!(
            "EventId: {}",
            record.event_id.as_deref().unwrap_or_default()
        );

        let record_processing_result = process_record(record);

        if record_processing_result.is_err() {
            response.batch_item_failures.push(KinesisBatchItemFailure {
                item_identifier: record.kinesis.sequence_number.clone(),
            });
            /* Since we are working with streams, we can return the failed item
            immediately.
            Lambda will immediately begin to retry processing from this failed
            item onwards. */
            return Ok(response);
        }
    }

    tracing::info!(
        "Successfully processed {} records",
        event.payload.records.len()
    );

    Ok(response)
}

fn process_record(record: &KinesisEventRecord) -> Result<(), Error> {
    let record_data = std::str::from_utf8(record.kinesis.data.as_slice());

```



```

    if let Some(err) = record_data.err() {
        tracing::error!("Error: {}", err);
        return Err(Error::from(err));
    }

    let record_data = record_data.unwrap_or_default();

    // do something interesting with the data
    tracing::info!("Data: {}", record_data);

    Ok(())
}

#[tokio::main]
async fn main() -> Result<(), Error> {
    tracing_subscriber::fmt()
        .with_max_level(tracing::Level::INFO)
        // disable printing the name of the module in every log line.
        .with_target(false)
        // disabling time is handy because CloudWatch will add the ingestion
        time.
        .without_time()
        .init();

    run(service_fn(function_handler)).await
}

```

Retain discarded batch records for a Kinesis Data Streams event source in Lambda

Error handling for Kinesis event source mappings depends on whether the error occurs before the function is invoked or during function invocation:

- **Before invocation:** If a Lambda event source mapping is unable to invoke the function due to throttling or other issues, it retries until the records expire or exceed the maximum age configured on the event source mapping ([MaximumRecordAgeInSeconds](#)).
- **During invocation:** If the function is invoked but returns an error, Lambda retries until the records expire, exceed the maximum age ([MaximumRecordAgeInSeconds](#)), or reach the configured retry quota ([MaximumRetryAttempts](#)). For function errors, you can also configure

[BisectBatchOnFunctionError](#), which splits a failed batch into two smaller batches, isolating bad records and avoiding timeouts. Splitting batches doesn't consume the retry quota.

If the error handling measures fail, Lambda discards the records and continues processing batches from the stream. With the default settings, this means that a bad record can block processing on the affected shard for up to one week. To avoid this, configure your function's event source mapping with a reasonable number of retries and a maximum record age that fits your use case.

Configuring destinations for failed invocations

To retain records of failed event source mapping invocations, add a destination to your function's event source mapping. Each record sent to the destination is a JSON document containing metadata about the failed invocation. For Amazon S3 destinations, Lambda also sends the entire invocation record along with the metadata. You can configure any Amazon SNS topic, Amazon SQS queue, or S3 bucket as a destination.

With Amazon S3 destinations, you can use the [Amazon S3 Event Notifications](#) feature to receive notifications when objects are uploaded to your destination S3 bucket. You can also configure S3 Event Notifications to invoke another Lambda function to perform automated processing on failed batches.

Your execution role must have permissions for the destination:

- **For SQS destinations:** [sqs:SendMessage](#)
- **For SNS destinations:** [sns:Publish](#)
- **For S3 bucket destinations:** [s3:PutObject](#) and [s3:ListBucket](#)

If you've enabled encryption with your own KMS key for an S3 destination, your function's execution role must also have permission to call [kms:GenerateDataKey](#). If the KMS key and S3 bucket destination are in a different account from your Lambda function and execution role, configure the KMS key to trust the execution role to allow `kms:GenerateDataKey`.

To configure an on-failure destination using the console, follow these steps:

1. Open the [Functions page](#) of the Lambda console.
2. Choose a function.
3. Under **Function overview**, choose **Add destination**.

4. For **Source**, choose **Event source mapping invocation**.
5. For **Event source mapping**, choose an event source that's configured for this function.
6. For **Condition**, select **On failure**. For event source mapping invocations, this is the only accepted condition.
7. For **Destination type**, choose the destination type that Lambda sends invocation records to.
8. For **Destination**, choose a resource.
9. Choose **Save**.

You can also configure an on-failure destination using the AWS Command Line Interface (AWS CLI). For example, the following [create-event-source-mapping](#) command adds an event source mapping with an SQS on-failure destination to MyFunction:

```
aws lambda create-event-source-mapping \  
--function-name "MyFunction" \  
--event-source-arn arn:aws:kinesis:us-east-2:123456789012:stream/lambda-stream \  
--destination-config '{"OnFailure": {"Destination": "arn:aws:sqs:us-  
east-1:123456789012:dest-queue"}}'
```

The following [update-event-source-mapping](#) command updates an event source mapping to send failed invocation records to an SNS destination after two retry attempts, or if the records are more than an hour old.

```
aws lambda update-event-source-mapping \  
--uuid f89f8514-cdd9-4602-9e1f-01a5b77d449b \  
--maximum-retry-attempts 2 \  
--maximum-record-age-in-seconds 3600 \  
--destination-config '{"OnFailure": {"Destination": "arn:aws:sns:us-  
east-1:123456789012:dest-topic"}}'
```

Updated settings are applied asynchronously and aren't reflected in the output until the process completes. Use the [get-event-source-mapping](#) command to view the current status.

To remove a destination, supply an empty string as the argument to the `destination-config` parameter:

```
aws lambda update-event-source-mapping \  
--uuid f89f8514-cdd9-4602-9e1f-01a5b77d449b \  
--destination-config '{"OnFailure": {"Destination": ""}}'
```

Security best practices for Amazon S3 destinations

Deleting an S3 bucket that's configured as a destination without removing the destination from your function's configuration can create a security risk. If another user knows your destination bucket's name, they can recreate the bucket in their AWS account. Records of failed invocations will be sent to their bucket, potentially exposing data from your function.

Warning

To ensure that invocation records from your function can't be sent to an S3 bucket in another AWS account, add a condition to your function's execution role that limits `s3:PutObject` permissions to buckets in your account.

The following example shows an IAM policy that limits your function's `s3:PutObject` permissions to buckets in your account. This policy also gives Lambda the `s3:ListBucket` permission it needs to use an S3 bucket as a destination.

```
{
  "Version": "2012-10-17",
  "Statement": [
    {
      "Sid": "S3BucketResourceAccountWrite",
      "Effect": "Allow",
      "Action": [
        "s3:PutObject",
        "s3:ListBucket"
      ],
      "Resource": "arn:aws:s3:::*/*",
      "Condition": {
        "StringEquals": {
          "s3:ResourceAccount": "111122223333"
        }
      }
    }
  ]
}
```

To add a permissions policy to your function's execution role using the AWS Management Console or AWS CLI, refer to the instructions in the following procedures:

Console

To add a permissions policy to a function's execution role (console)

1. Open the [Functions page](#) of the Lambda console.
2. Select the Lambda function whose execution role you want to modify.
3. In the **Configuration** tab, select **Permissions**.
4. In the **Execution role** tab, select your function's **Role name** to open the role's IAM console page.
5. Add a permissions policy to the role by doing the following:
 - a. In the **Permissions policies** pane, choose **Add permissions** and select **Create inline policy**.
 - b. In **Policy editor**, select **JSON**.
 - c. Paste the policy you want to add into the editor (replacing the existing JSON), and then choose **Next**.
 - d. Under **Policy details**, enter a **Policy name**.
 - e. Choose **Create policy**.

AWS CLI

To add a permissions policy to a function's execution role (CLI)

1. Create a JSON policy document with the required permissions and save it in a local directory.
2. Use the IAM `put-role-policy` CLI command to add the permissions to your function's execution role. Run the following command from the directory you saved your JSON policy document in and replace the role name, policy name, and policy document with your own values.

```
aws iam put-role-policy \  
--role-name my_lambda_role \  
--policy-name LambdaS3DestinationPolicy \  
--policy-document file://my_policy.json
```

Example Amazon SNS and Amazon SQS invocation record

The following example shows what Lambda sends to an SQS queue or SNS topic for a failed Kinesis event source invocation. Because Lambda sends only the metadata for these destination types, use the `streamArn`, `shardId`, `startSequenceNumber`, and `endSequenceNumber` fields to obtain the full original record. All of the fields shown in the `KinesisBatchInfo` property will always be present.

```
{
  "requestContext": {
    "requestId": "c9b8fa9f-5a7f-xmpl-af9c-0c604cde93a5",
    "functionArn": "arn:aws:lambda:us-east-2:123456789012:function:myfunction",
    "condition": "RetryAttemptsExhausted",
    "approximateInvokeCount": 1
  },
  "responseContext": {
    "statusCode": 200,
    "executedVersion": "$LATEST",
    "functionError": "Unhandled"
  },
  "version": "1.0",
  "timestamp": "2019-11-14T00:38:06.021Z",
  "KinesisBatchInfo": {
    "shardId": "shardId-000000000001",
    "startSequenceNumber":
"49601189658422359378836298521827638475320189012309704722",
    "endSequenceNumber":
"49601189658422359378836298522902373528957594348623495186",
    "approximateArrivalOfFirstRecord": "2019-11-14T00:38:04.835Z",
    "approximateArrivalOfLastRecord": "2019-11-14T00:38:05.580Z",
    "batchSize": 500,
    "streamArn": "arn:aws:kinesis:us-east-2:123456789012:stream/mystream"
  }
}
```

You can use this information to retrieve the affected records from the stream for troubleshooting. The actual records aren't included, so you must process this record and retrieve them from the stream before they expire and are lost.

Example Amazon S3 invocation record

The following example shows what Lambda sends to an Amazon S3 bucket for a failed Kinesis event source invocation. In addition to all of the fields from the previous example for SQS and SNS destinations, the `payload` field contains the original invocation record as an escaped JSON string.

```
{
  "requestContext": {
    "requestId": "c9b8fa9f-5a7f-xmpl-af9c-0c604cde93a5",
    "functionArn": "arn:aws:lambda:us-east-2:123456789012:function:myfunction",
    "condition": "RetryAttemptsExhausted",
    "approximateInvokeCount": 1
  },
  "responseContext": {
    "statusCode": 200,
    "executedVersion": "$LATEST",
    "functionError": "Unhandled"
  },
  "version": "1.0",
  "timestamp": "2019-11-14T00:38:06.021Z",
  "KinesisBatchInfo": {
    "shardId": "shardId-000000000001",
    "startSequenceNumber":
"49601189658422359378836298521827638475320189012309704722",
    "endSequenceNumber":
"49601189658422359378836298522902373528957594348623495186",
    "approximateArrivalOfFirstRecord": "2019-11-14T00:38:04.835Z",
    "approximateArrivalOfLastRecord": "2019-11-14T00:38:05.580Z",
    "batchSize": 500,
    "streamArn": "arn:aws:kinesis:us-east-2:123456789012:stream/mystream"
  },
  "payload": "<Whole Event>" // Only available in S3
}
```

The S3 object containing the invocation record uses the following naming convention:

```
aws/lambda/<ESM-UUID>/<shardID>/YYYY/MM/DD/YYYY-MM-DDTHH.MM.SS-<Random UUID>
```

Implementing stateful Kinesis Data Streams processing in Lambda

Lambda functions can run continuous stream processing applications. A stream represents unbounded data that flows continuously through your application. To analyze information from

this continuously updating input, you can bound the included records using a window defined in terms of time.

Tumbling windows are distinct time windows that open and close at regular intervals. By default, Lambda invocations are stateless—you cannot use them for processing data across multiple continuous invocations without an external database. However, with tumbling windows, you can maintain your state across invocations. This state contains the aggregate result of the messages previously processed for the current window. Your state can be a maximum of 1 MB per shard. If it exceeds that size, Lambda terminates the window early.

Each record in a stream belongs to a specific window. Lambda will process each record at least once, but doesn't guarantee that each record will be processed only once. In rare cases, such as error handling, some records might be processed more than once. Records are always processed in order the first time. If records are processed more than once, they might be processed out of order.

Aggregation and processing

Your user managed function is invoked both for aggregation and for processing the final results of that aggregation. Lambda aggregates all records received in the window. You can receive these records in multiple batches, each as a separate invocation. Each invocation receives a state. Thus, when using tumbling windows, your Lambda function response must contain a state property. If the response does not contain a state property, Lambda considers this a failed invocation. To satisfy this condition, your function can return a `TimeWindowEventResponse` object, which has the following JSON shape:

Example `TimeWindowEventResponse` values

```
{
  "state": {
    "1": 282,
    "2": 715
  },
  "batchItemFailures": []
}
```

Note

For Java functions, we recommend using a `Map<String, String>` to represent the state.

At the end of the window, the flag `isFinalInvokeForWindow` is set to `true` to indicate that this is the final state and that it's ready for processing. After processing, the window completes and your final invocation completes, and then the state is dropped.

At the end of your window, Lambda uses final processing for actions on the aggregation results. Your final processing is synchronously invoked. After successful invocation, your function checkpoints the sequence number and stream processing continues. If invocation is unsuccessful, your Lambda function suspends further processing until a successful invocation.

Example `KinesisTimeWindowEvent`

```
{
  "Records": [
    {
      "kinesis": {
        "kinesisSchemaVersion": "1.0",
        "partitionKey": "1",
        "sequenceNumber":
"49590338271490256608559692538361571095921575989136588898",
        "data": "SGVsbG8sIHRoaXMgaXMgYSB0ZXN0Lg==",
        "approximateArrivalTimestamp": 1607497475.000
      },
      "eventSource": "aws:kinesis",
      "eventVersion": "1.0",
      "eventID":
"shardId-000000000006:49590338271490256608559692538361571095921575989136588898",
      "eventName": "aws:kinesis:record",
      "invokeIdentityArn": "arn:aws:iam::123456789012:role/lambda-kinesis-role",
      "awsRegion": "us-east-1",
      "eventSourceARN": "arn:aws:kinesis:us-east-1:123456789012:stream/lambda-
stream"
    }
  ],
  "window": {
    "start": "2020-12-09T07:04:00Z",
    "end": "2020-12-09T07:06:00Z"
  },
  "state": {
    "1": 282,
    "2": 715
  },
  "shardId": "shardId-000000000006",
}
```

```
"eventSourceARN": "arn:aws:kinesis:us-east-1:123456789012:stream/lambda-stream",
"isFinalInvokeForWindow": false,
"isWindowTerminatedEarly": false
}
```

Configuration

You can configure tumbling windows when you create or update an event source mapping. To configure a tumbling window, specify the window in seconds ([TumblingWindowInSeconds](#)). The following example AWS Command Line Interface (AWS CLI) command creates a streaming event source mapping that has a tumbling window of 120 seconds. The Lambda function defined for aggregation and processing is named `tumbling-window-example-function`.

```
aws lambda create-event-source-mapping \
--event-source-arn arn:aws:kinesis:us-east-1:123456789012:stream/lambda-stream \
--function-name tumbling-window-example-function \
--starting-position TRIM_HORIZON \
--tumbling-window-in-seconds 120
```

Lambda determines tumbling window boundaries based on the time when records were inserted into the stream. All records have an approximate timestamp available that Lambda uses in boundary determinations.

Tumbling window aggregations do not support resharding. When a shard ends, Lambda considers the current window to be closed, and any child shards will start their own window in a fresh state. When no new records are being added to the current window, Lambda waits for up to 2 minutes before assuming that the window is over. This helps ensure that the function reads all records in the current window, even if the records are added intermittently.

Tumbling windows fully support the existing retry policies `maxRetryAttempts` and `maxRecordAge`.

Example Handler.py – Aggregation and processing

The following Python function demonstrates how to aggregate and then process your final state:

```
def lambda_handler(event, context):
    print('Incoming event: ', event)
    print('Incoming state: ', event['state'])
```

```

#Check if this is the end of the window to either aggregate or process.
    if event['isFinalInvokeForWindow']:
        # logic to handle final state of the window
        print('Destination invoke')
    else:
        print('Aggregate invoke')

#Check for early terminations
    if event['isWindowTerminatedEarly']:
        print('Window terminated early')

#Aggregation logic
    state = event['state']
    for record in event['Records']:
        state[record['kinesis']['partitionKey']] = state.get(record['kinesis']
['partitionKey'], 0) + 1

    print('Returning state: ', state)
    return {'state': state}

```

Lambda parameters for Amazon Kinesis Data Streams event source mappings

All Lambda event source mappings share the same [CreateEventSourceMapping](#) and [UpdateEventSourceMapping](#) API operations. However, only some of the parameters apply to Kinesis.

Parameter	Required	Default	Notes
BatchSize	N	100	Maximum: 10,000
BisectBatchOnFunctionError	N	false	none
DestinationConfig	N	N/A	Amazon SQS queue or Amazon SNS topic destination for discarded records. For more information, see Configuring

Parameter	Required	Default	Notes
			destinations for failed invocations.
Enabled	N	true	none
EventSourceArn	Y	N/A	ARN of the data stream or a stream consumer
FunctionName	Y	N/A	none
FunctionResponseTypes	N	N/A	To let your function report specific failures in a batch, include the value <code>ReportBatchItemFailures</code> in <code>FunctionResponseTypes</code> . For more information, see Configuring partial batch response with Kinesis Data Streams and Lambda.
MaximumBatchingWindowInSeconds	N	0	none

Parameter	Required	Default	Notes
MaximumRecordAgeInSeconds	N	-1	-1 means infinite: Lambda doesn't discard records (Kinesis Data Streams data retention settings still apply) Minimum: -1 Maximum: 604,800
MaximumRetryAttempts	N	-1	-1 means infinite: failed records are retried until the record expires Minimum: -1 Maximum: 10,000
ParallelizationFactor	N	1	Maximum: 10
StartingPosition	Y	N/A	AT_TIMESTAMP, TRIM_HORIZON, or LATEST
StartingPositionTimestamp	N	N/A	Only valid if StartingPosition is set to AT_TIMESTAMP. The time from which to start reading, in Unix time seconds
TumblingWindowInSeconds	N	N/A	Minimum: 0 Maximum: 900

Using event filtering with a Kinesis event source

You can use event filtering to control which records from a stream or queue Lambda sends to your function. For general information about how event filtering works, see [the section called “Event filtering”](#).

This section focuses on event filtering for Kinesis event sources.

Topics

- [Kinesis event filtering basics](#)
- [Filtering Kinesis aggregated records](#)

Kinesis event filtering basics

Suppose a producer is putting JSON formatted data into your Kinesis data stream. An example record would look like the following, with the JSON data converted to a Base64 encoded string in the data field.

```
{
  "kinesis": {
    "kinesisSchemaVersion": "1.0",
    "partitionKey": "1",
    "sequenceNumber": "49590338271490256608559692538361571095921575989136588898",
    "data":
      "eyJJSZWNvcnR0dWliZXIiOiAiMDAwMSIsICJJaW1lU3RhbXAiOiAiAieXl5eS1tbS1kZFRoaDptbTpozcyIsICJSZXF1ZXN0",
    "approximateArrivalTimestamp": 1545084650.987
  },
  "eventSource": "aws:kinesis",
  "eventVersion": "1.0",
  "eventID":
    "shardId-000000000006:49590338271490256608559692538361571095921575989136588898",
  "eventName": "aws:kinesis:record",
  "invokeIdentityArn": "arn:aws:iam::123456789012:role/lambda-role",
  "awsRegion": "us-east-2",
  "eventSourceARN": "arn:aws:kinesis:us-east-2:123456789012:stream/lambda-stream"
}
```

As long as the data the producer puts into the stream is valid JSON, you can use event filtering to filter records using the data key. Suppose a producer is putting records into your Kinesis stream in the following JSON format.

```
{
  "record": 12345,
  "order": {
    "type": "buy",
    "stock": "ANYCO",
    "quantity": 1000
  }
}
```

To filter only those records where the order type is “buy,” the `FilterCriteria` object would be as follows.

```
{
  "Filters": [
    {
      "Pattern": "{ \"data\" : { \"order\" : { \"type\" : [ \"buy\" ] } } }"
    }
  ]
}
```

For added clarity, here is the value of the filter's `Pattern` expanded in plain JSON.

```
{
  "data": {
    "order": {
      "type": [ "buy" ]
    }
  }
}
```

You can add your filter using the console, AWS CLI or an AWS SAM template.

Console

To add this filter using the console, follow the instructions in [Attaching filter criteria to an event source mapping \(console\)](#) and enter the following string for the **Filter criteria**.

```
{ "data" : { "order" : { "type" : [ "buy" ] } } }
```

AWS CLI

To create a new event source mapping with these filter criteria using the AWS Command Line Interface (AWS CLI), run the following command.

```
aws lambda create-event-source-mapping \
  --function-name my-function \
  --event-source-arn arn:aws:kinesis:us-east-2:123456789012:stream/my-stream \
  --filter-criteria '{"Filters": [{"Pattern": "{ \"data\" : { \"order\" : { \"type\" : [ \"buy\" ] } } }"}]}'
```

To add these filter criteria to an existing event source mapping, run the following command.

```
aws lambda update-event-source-mapping \
  --uuid "a1b2c3d4-5678-90ab-cdef-11111EXAMPLE" \
  --filter-criteria '{"Filters": [{"Pattern": "{ \"data\" : { \"order\" : { \"type\" : [ \"buy\" ] } } }"}]}'
```

AWS SAM

To add this filter using AWS SAM, add the following snippet to the YAML template for your event source.

```
FilterCriteria:
  Filters:
    - Pattern: '{ "data" : { "order" : { "type" : [ "buy" ] } } }'
```

To properly filter events from Kinesis sources, both the data field and your filter criteria for the data field must be in valid JSON format. If either field isn't in a valid JSON format, Lambda drops the message or throws an exception. The following table summarizes the specific behavior:

Incoming data format	Filter pattern format for data properties	Resulting action
Valid JSON	Valid JSON	Lambda filters based on your filter criteria.

Incoming data format	Filter pattern format for data properties	Resulting action
Valid JSON	No filter pattern for data properties	Lambda filters (on the other metadata properties only) based on your filter criteria.
Valid JSON	Non-JSON	Lambda throws an exception at the time of the event source mapping creation or update. The filter pattern for data properties must be in a valid JSON format.
Non-JSON	Valid JSON	Lambda drops the record.
Non-JSON	No filter pattern for data properties	Lambda filters (on the other metadata properties only) based on your filter criteria.
Non-JSON	Non-JSON	Lambda throws an exception at the time of the event source mapping creation or update. The filter pattern for data properties must be in a valid JSON format.

Filtering Kinesis aggregated records

With Kinesis, you can aggregate multiple records into a single Kinesis Data Streams record to increase your data throughput. Lambda can only apply filter criteria to aggregated records when you use Kinesis [enhanced fan-out](#). Filtering aggregated records with standard Kinesis isn't supported. When using enhanced fan-out, you configure a Kinesis dedicated-throughput consumer to act as the trigger for your Lambda function. Lambda then filters the aggregated records and passes only those records that meet your filter criteria.

To learn more about Kinesis record aggregation, refer to the [Aggregation](#) section on the Kinesis Producer Library (KPL) Key Concepts page. To learn more about using Lambda with Kinesis

enhanced fan-out, see [Increasing real-time stream processing performance with Amazon Kinesis Data Streams enhanced fan-out and AWS Lambda](#) on the AWS compute blog.

Tutorial: Using Lambda with Kinesis Data Streams

In this tutorial, you create a Lambda function to consume events from a Amazon Kinesis data stream.

1. Custom app writes records to the stream.
2. AWS Lambda polls the stream and, when it detects new records in the stream, invokes your Lambda function.
3. AWS Lambda runs the Lambda function by assuming the execution role you specified at the time you created the Lambda function.

Prerequisites

This tutorial assumes that you have some knowledge of basic Lambda operations and the Lambda console. If you haven't already, follow the instructions in [Create a Lambda function with the console](#) to create your first Lambda function.

To complete the following steps, you need the [AWS CLI version 2](#). Commands and the expected output are listed in separate blocks:

```
aws --version
```

You should see the following output:

```
aws-cli/2.13.27 Python/3.11.6 Linux/4.14.328-248.540.amzn2.x86_64 exe/x86_64.amzn.2
```

For long commands, an escape character (\) is used to split a command over multiple lines.

On Linux and macOS, use your preferred shell and package manager.

Note

In Windows, some Bash CLI commands that you commonly use with Lambda (such as `zip`) are not supported by the operating system's built-in terminals. To get a Windows-integrated version of Ubuntu and Bash, [install the Windows Subsystem for Linux](#). Example

CLI commands in this guide use Linux formatting. Commands which include inline JSON documents must be reformatted if you are using the Windows CLI.

Create the execution role

Create the [execution role](#) that gives your function permission to access AWS resources.

To create an execution role

1. Open the [roles page](#) in the IAM console.
2. Choose **Create role**.
3. Create a role with the following properties.
 - **Trusted entity** – **AWS Lambda**.
 - **Permissions** – **AWSLambdaKinesisExecutionRole**.
 - **Role name** – **lambda-kinesis-role**.

The **AWSLambdaKinesisExecutionRole** policy has the permissions that the function needs to read items from Kinesis and write logs to CloudWatch Logs.

Create the function

Create a Lambda function that processes your Kinesis messages. The function code logs the event ID and event data of the Kinesis record to CloudWatch Logs.

This tutorial uses the Node.js 18.x runtime, but we've also provided example code in other runtime languages. You can select the tab in the following box to see code for the runtime you're interested in. The JavaScript code you'll use in this step is in the first example shown in the **JavaScript** tab.

.NET

AWS SDK for .NET

Note

There's more on GitHub. Find the complete example and learn how to set up and run in the [Serverless examples](#) repository.

Consuming a Kinesis event with Lambda using .NET.

```
// Copyright Amazon.com, Inc. or its affiliates. All Rights Reserved.
// SPDX-License-Identifier: Apache-2.0
using System.Text;
using Amazon.Lambda.Core;
using Amazon.Lambda.KinesisEvents;
using AWS.Lambda.Powertools.Logging;

// Assembly attribute to enable the Lambda function's JSON input to be converted
// into a .NET class.
[assembly: LambdaSerializer(typeof(Amazon.Lambda.Serialization.SystemTextJson.DefaultLambdaJsonSerializer))]

namespace KinesisIntegrationSampleCode;

public class Function
{
    // Powertools Logger requires an environment variables against your function
    // POWERTOOLS_SERVICE_NAME
    [Logging(LogEvent = true)]
    public async Task FunctionHandler(KinesisEvent evnt, ILambdaContext context)
    {
        if (evnt.Records.Count == 0)
        {
            Logger.LogInformation("Empty Kinesis Event received");
            return;
        }

        foreach (var record in evnt.Records)
        {
            try
            {
                Logger.LogInformation($"Processed Event with EventId:
{record.EventId}");
                string data = await GetRecordDataAsync(record.Kinesis, context);
                Logger.LogInformation($"Data: {data}");
                // TODO: Do interesting work based on the new data
            }
            catch (Exception ex)
            {
                Logger.LogError($"An error occurred {ex.Message}");
                throw;
            }
        }
    }
}
```

```
    }
    Logger.LogInformation($"Successfully processed {evnt.Records.Count}
records.");
}

private async Task<string> GetRecordDataAsync(KinesisEvent.Record record,
ILambdaContext context)
{
    byte[] bytes = record.Data.ToArray();
    string data = Encoding.UTF8.GetString(bytes);
    await Task.CompletedTask; //Placeholder for actual async work
    return data;
}
}
```

Go

SDK for Go V2

Note

There's more on GitHub. Find the complete example and learn how to set up and run in the [Serverless examples](#) repository.

Consuming a Kinesis event with Lambda using Go.

```
// Copyright Amazon.com, Inc. or its affiliates. All Rights Reserved.
// SPDX-License-Identifier: Apache-2.0
package main

import (
    "context"
    "log"

    "github.com/aws/aws-lambda-go/events"
    "github.com/aws/aws-lambda-go/lambda"
)

func handler(ctx context.Context, kinesisEvent events.KinesisEvent) error {
    if len(kinesisEvent.Records) == 0 {
        log.Printf("empty Kinesis event received")
    }
}
```

```
    return nil
}

for _, record := range kinesisEvent.Records {
    log.Printf("processed Kinesis event with EventId: %v", record.EventID)
    recordDataBytes := record.Kinesis.Data
    recordDataText := string(recordDataBytes)
    log.Printf("record data: %v", recordDataText)
    // TODO: Do interesting work based on the new data
}
log.Printf("successfully processed %v records", len(kinesisEvent.Records))
return nil
}

func main() {
    lambda.Start(handler)
}
```

Java

SDK for Java 2.x

Note

There's more on GitHub. Find the complete example and learn how to set up and run in the [Serverless examples](#) repository.

Consuming a Kinesis event with Lambda using Java.

```
// Copyright Amazon.com, Inc. or its affiliates. All Rights Reserved.
// SPDX-License-Identifier: Apache-2.0
package example;

import com.amazonaws.services.lambda.runtime.Context;
import com.amazonaws.services.lambda.runtime.LambdaLogger;
import com.amazonaws.services.lambda.runtime.RequestHandler;
import com.amazonaws.services.lambda.runtime.events.KinesisEvent;

public class Handler implements RequestHandler<KinesisEvent, Void> {
    @Override
```

```
public Void handleRequest(final KinesisEvent event, final Context context) {
    LambdaLogger logger = context.getLogger();
    if (event.getRecords().isEmpty()) {
        logger.log("Empty Kinesis Event received");
        return null;
    }
    for (KinesisEvent.KinesisEventRecord record : event.getRecords()) {
        try {
            logger.log("Processed Event with EventId: "+record.getEventID());
            String data = new String(record.getKinesis().getData().array());
            logger.log("Data:"+ data);
            // TODO: Do interesting work based on the new data
        }
        catch (Exception ex) {
            logger.log("An error occurred:"+ex.getMessage());
            throw ex;
        }
    }
    logger.log("Successfully processed:"+event.getRecords().size()+"
records");
    return null;
}
}
```

JavaScript

SDK for JavaScript (v3)

Note

There's more on GitHub. Find the complete example and learn how to set up and run in the [Serverless examples](#) repository.

Consuming a Kinesis event with Lambda using JavaScript.

```
// Copyright Amazon.com, Inc. or its affiliates. All Rights Reserved.
// SPDX-License-Identifier: Apache-2.0
exports.handler = async (event, context) => {
    for (const record of event.Records) {
```

```

    try {
      console.log(`Processed Kinesis Event - EventID: ${record.eventID}`);
      const recordData = await getRecordDataAsync(record.kinesis);
      console.log(`Record Data: ${recordData}`);
      // TODO: Do interesting work based on the new data
    } catch (err) {
      console.error(`An error occurred ${err}`);
      throw err;
    }
  }
  console.log(`Successfully processed ${event.Records.length} records.`);
};

async function getRecordDataAsync(payload) {
  var data = Buffer.from(payload.data, "base64").toString("utf-8");
  await Promise.resolve(1); //Placeholder for actual async work
  return data;
}

```

Consuming a Kinesis event with Lambda using TypeScript.

```

// Copyright Amazon.com, Inc. or its affiliates. All Rights Reserved.
// SPDX-License-Identifier: Apache-2.0
import {
  KinesisStreamEvent,
  Context,
  KinesisStreamHandler,
  KinesisStreamRecordPayload,
} from "aws-lambda";
import { Buffer } from "buffer";
import { Logger } from "@aws-lambda-powertools/logger";

const logger = new Logger({
  logLevel: "INFO",
  serviceName: "kinesis-stream-handler-sample",
});

export const functionHandler: KinesisStreamHandler = async (
  event: KinesisStreamEvent,
  context: Context
): Promise<void> => {
  for (const record of event.Records) {

```



```
try {
    logger.info(`Processed Kinesis Event - EventID: ${record.eventID}`);
    const recordData = await getRecordDataAsync(record.kinesis);
    logger.info(`Record Data: ${recordData}`);
    // TODO: Do interesting work based on the new data
} catch (err) {
    logger.error(`An error occurred ${err}`);
    throw err;
}
logger.info(`Successfully processed ${event.Records.length} records.`);
};

async function getRecordDataAsync(
    payload: KinesisStreamRecordPayload
): Promise<string> {
    var data = Buffer.from(payload.data, "base64").toString("utf-8");
    await Promise.resolve(1); //Placeholder for actual async work
    return data;
}
```

PHP

SDK for PHP

Note

There's more on GitHub. Find the complete example and learn how to set up and run in the [Serverless examples](#) repository.

Consuming an Kinesis event with Lambda using PHP.

```
// Copyright Amazon.com, Inc. or its affiliates. All Rights Reserved.
// SPDX-License-Identifier: Apache-2.0
<?php

# using bref/bref and bref/logger for simplicity

use Bref\Context\Context;
use Bref\Event\Kinesis\KinesisEvent;
```

```
use Bref\Event\Kinesis\KinesisHandler;
use Bref\Logger\StderrLogger;

require __DIR__ . '/vendor/autoload.php';

class Handler extends KinesisHandler
{
    private StderrLogger $logger;
    public function __construct(StderrLogger $logger)
    {
        $this->logger = $logger;
    }

    /**
     * @throws JsonException
     * @throws \Bref\Event\InvalidLambdaEvent
     */
    public function handleKinesis(KinesisEvent $event, Context $context): void
    {
        $this->logger->info("Processing records");
        $records = $event->getRecords();
        foreach ($records as $record) {
            $data = $record->getData();
            $this->logger->info(json_encode($data));
            // TODO: Do interesting work based on the new data

            // Any exception thrown will be logged and the invocation will be
            marked as failed
        }
        $totalRecords = count($records);
        $this->logger->info("Successfully processed $totalRecords records");
    }
}

$logger = new StderrLogger();
return new Handler($logger);
```

Python

SDK for Python (Boto3)

Note

There's more on GitHub. Find the complete example and learn how to set up and run in the [Serverless examples](#) repository.

Consuming a Kinesis event with Lambda using Python.

```
# Copyright Amazon.com, Inc. or its affiliates. All Rights Reserved.
# SPDX-License-Identifier: Apache-2.0
import base64
def lambda_handler(event, context):

    for record in event['Records']:
        try:
            print(f"Processed Kinesis Event - EventID: {record['eventID']}")
            record_data = base64.b64decode(record['kinesis']
['data']).decode('utf-8')
            print(f"Record Data: {record_data}")
            # TODO: Do interesting work based on the new data
        except Exception as e:
            print(f"An error occurred {e}")
            raise e
    print(f"Successfully processed {len(event['Records'])} records.")
```

Ruby

SDK for Ruby

Note

There's more on GitHub. Find the complete example and learn how to set up and run in the [Serverless examples](#) repository.

Consuming an Kinesis event with Lambda using Ruby.

```
# Copyright Amazon.com, Inc. or its affiliates. All Rights Reserved.
# SPDX-License-Identifier: Apache-2.0
require 'aws-sdk'

def lambda_handler(event:, context:)
  event['Records'].each do |record|
    begin
      puts "Processed Kinesis Event - EventID: #{record['eventID']}"
      record_data = get_record_data_async(record['kinesis'])
      puts "Record Data: #{record_data}"
      # TODO: Do interesting work based on the new data
    rescue => err
      $stderr.puts "An error occurred #{err}"
      raise err
    end
  end
  puts "Successfully processed #{event['Records'].length} records."
end

def get_record_data_async(payload)
  data = Base64.decode64(payload['data']).force_encoding('UTF-8')
  # Placeholder for actual async work
  # You can use Ruby's asynchronous programming tools like async/await or fibers
  here.
  return data
end
```

Rust

SDK for Rust

Note

There's more on GitHub. Find the complete example and learn how to set up and run in the [Serverless examples](#) repository.

Consuming an Kinesis event with Lambda using Rust.

```
// Copyright Amazon.com, Inc. or its affiliates. All Rights Reserved.
// SPDX-License-Identifier: Apache-2.0
use aws_lambda_events::event::kinesis::KinesisEvent;
use lambda_runtime::{run, service_fn, Error, LambdaEvent};

async fn function_handler(event: LambdaEvent<KinesisEvent>) -> Result<(), Error>
{
    if event.payload.records.is_empty() {
        tracing::info!("No records found. Exiting.");
        return Ok(());
    }

    event.payload.records.iter().for_each(|record| {
        tracing::info!("EventId:
{}", record.event_id.as_deref().unwrap_or_default());

        let record_data = std::str::from_utf8(&record.kinesis.data);

        match record_data {
            Ok(data) => {
                // log the record data
                tracing::info!("Data: {}", data);
            }
            Err(e) => {
                tracing::error!("Error: {}", e);
            }
        }
    });

    tracing::info!(
        "Successfully processed {} records",
        event.payload.records.len()
    );

    Ok(())
}

#[tokio::main]
async fn main() -> Result<(), Error> {
    tracing_subscriber::fmt()
        .with_max_level(tracing::Level::INFO)
        // disable printing the name of the module in every log line.
        .with_target(false)
}
```

```
        // disabling time is handy because CloudWatch will add the ingestion
time.
        .without_time()
        .init();

    run(service_fn(function_handler)).await
}
```

To create the function

1. Create a directory for the project, and then switch to that directory.

```
mkdir kinesis-tutorial
cd kinesis-tutorial
```

2. Copy the sample JavaScript code into a new file named `index.js`.
3. Create a deployment package.

```
zip function.zip index.js
```

4. Create a Lambda function with the `create-function` command.

```
aws lambda create-function --function-name ProcessKinesisRecords \
--zip-file fileb://function.zip --handler index.handler --runtime nodejs18.x \
--role arn:aws:iam::111122223333:role/lambda-kinesis-role
```

Test the Lambda function

Invoke your Lambda function manually using the `invoke` AWS Lambda CLI command and a sample Kinesis event.

To test the Lambda function

1. Copy the following JSON into a file and save it as `input.txt`.

```
{
  "Records": [
    {
      "kinesis": {
        "kinesisSchemaVersion": "1.0",
```

```

        "partitionKey": "1",
        "sequenceNumber":
"49590338271490256608559692538361571095921575989136588898",
        "data": "SGVsbG8sIHRoaXMgaXMgYSB0ZXN0Lg==",
        "approximateArrivalTimestamp": 1545084650.987
    },
    "eventSource": "aws:kinesis",
    "eventVersion": "1.0",
    "eventID":
"shardId-000000000006:49590338271490256608559692538361571095921575989136588898",
    "eventName": "aws:kinesis:record",
    "invokeIdentityArn": "arn:aws:iam::111122223333:role/lambda-kinesis-
role",
    "awsRegion": "us-east-2",
    "eventSourceARN": "arn:aws:kinesis:us-east-2:111122223333:stream/
lambda-stream"
    }
]
}

```

2. Use the `invoke` command to send the event to the function.

```

aws lambda invoke --function-name ProcessKinesisRecords \
--cli-binary-format raw-in-base64-out \
--payload file://input.txt outputfile.txt

```

The `cli-binary-format` option is required if you're using AWS CLI version 2. To make this the default setting, run `aws configure set cli-binary-format raw-in-base64-out`. For more information, see [AWS CLI supported global command line options](#) in the *AWS Command Line Interface User Guide for Version 2*.

The response is saved to `out.txt`.

Create a Kinesis stream

Use the `create-stream` command to create a stream.

```

aws kinesis create-stream --stream-name lambda-stream --shard-count 1

```

Run the following `describe-stream` command to get the stream ARN.

```
aws kinesis describe-stream --stream-name lambda-stream
```

You should see the following output:

```
{
  "StreamDescription": {
    "Shards": [
      {
        "ShardId": "shardId-000000000000",
        "HashKeyRange": {
          "StartingHashKey": "0",
          "EndingHashKey": "340282366920746074317682119384634633455"
        },
        "SequenceNumberRange": {
          "StartingSequenceNumber":
"49591073947768692513481539594623130411957558361251844610"
        }
      }
    ],
    "StreamARN": "arn:aws:kinesis:us-east-1:111122223333:stream/lambda-stream",
    "StreamName": "lambda-stream",
    "StreamStatus": "ACTIVE",
    "RetentionPeriodHours": 24,
    "EnhancedMonitoring": [
      {
        "ShardLevelMetrics": []
      }
    ],
    "EncryptionType": "NONE",
    "KeyId": null,
    "StreamCreationTimestamp": 1544828156.0
  }
}
```

You use the stream ARN in the next step to associate the stream with your Lambda function.

Add an event source in AWS Lambda

Run the following AWS CLI `add-event-source` command.

```
aws lambda create-event-source-mapping --function-name ProcessKinesisRecords \  
--event-source arn:aws:kinesis:us-east-1:111122223333:stream/lambda-stream \  
--event-source-arn arn:aws:kinesis:us-east-1:111122223333:stream/lambda-stream
```



```
--batch-size 100 --starting-position LATEST
```

Note the mapping ID for later use. You can get a list of event source mappings by running the `list-event-source-mappings` command.

```
aws lambda list-event-source-mappings --function-name ProcessKinesisRecords \  
--event-source arn:aws:kinesis:us-east-1:111122223333:stream/lambda-stream
```

In the response, you can verify the status value is enabled. Event source mappings can be disabled to pause polling temporarily without losing any records.

Test the setup

To test the event source mapping, add event records to your Kinesis stream. The `--data` value is a string that the CLI encodes to base64 prior to sending it to Kinesis. You can run the same command more than once to add multiple records to the stream.

```
aws kinesis put-record --stream-name lambda-stream --partition-key 1 \  
--data "Hello, this is a test."
```

Lambda uses the execution role to read records from the stream. Then it invokes your Lambda function, passing in batches of records. The function decodes data from each record and logs it, sending the output to CloudWatch Logs. View the logs in the [CloudWatch console](#).

Clean up your resources

You can now delete the resources that you created for this tutorial, unless you want to retain them. By deleting AWS resources that you're no longer using, you prevent unnecessary charges to your AWS account.

To delete the execution role

1. Open the [Roles page](#) of the IAM console.
2. Select the execution role that you created.
3. Choose **Delete**.
4. Enter the name of the role in the text input field and choose **Delete**.

To delete the Lambda function

1. Open the [Functions page](#) of the Lambda console.
2. Select the function that you created.
3. Choose **Actions, Delete**.
4. Type **confirm** in the text input field and choose **Delete**.

To delete the Kinesis stream

1. Sign in to the AWS Management Console and open the Kinesis console at <https://console.aws.amazon.com/kinesis>.
2. Select the stream you created.
3. Choose **Actions, Delete**.
4. Enter **delete** in the text input field.
5. Choose **Delete**.

Using Lambda with Kubernetes

You can deploy and manage Lambda functions with the Kubernetes API using [AWS Controllers for Kubernetes \(ACK\)](#) or [Crossplane](#).

AWS Controllers for Kubernetes (ACK)

You can use ACK to deploy and manage AWS resources from the Kubernetes API. Through ACK, AWS provides open-source custom controllers for AWS services such as Lambda, Amazon Elastic Container Registry (Amazon ECR), Amazon Simple Storage Service (Amazon S3), and Amazon SageMaker AI. Each supported AWS service has its own custom controller. In your Kubernetes cluster, install a controller for each AWS service that you want to use. Then, create a [Custom Resource Definition \(CRD\)](#) to define the AWS resources.

We recommend that you use [Helm 3.8 or later](#) to install ACK controllers. Every ACK controller comes with its own Helm chart, which installs the controller, CRDs, and Kubernetes RBAC rules. For more information, see [Install an ACK Controller](#) in the ACK documentation.

After you create the ACK custom resource, you can use it like any other built-in Kubernetes object. For example, you can deploy and manage Lambda functions with your preferred Kubernetes toolchains, including [kubectrl](#).

Here are some example use cases for provisioning Lambda functions through ACK:

- Your organization uses [role-based access control \(RBAC\)](#) and [IAM roles for service accounts](#) to create permissions boundaries. With ACK, you can reuse this security model for Lambda without having to create new users and policies.
- Your organization has a DevOps process to deploy resources into an Amazon Elastic Kubernetes Service (Amazon EKS) cluster using Kubernetes manifests. With ACK, you can use a manifest to provision Lambda functions without creating separate infrastructure as code templates.

For more information about using ACK, see the [Lambda tutorial in the ACK documentation](#).

Crossplane

[Crossplane](#) is an open-source Cloud Native Computing Foundation (CNCF) project that uses Kubernetes to manage cloud infrastructure resources. With Crossplane, developers can request infrastructure without needing to understand its complexities. Platform teams retain control over how the infrastructure is provisioned and managed.

Using Crossplane, you can deploy and manage Lambda functions with your preferred Kubernetes toolchains such as [kubectrl](#), and any CI/CD pipeline that can deploy manifests to Kubernetes. Here are some example use cases for provisioning Lambda functions through Crossplane:

- Your organization wants to enforce compliance by ensuring that Lambda functions have the correct [tags](#). Platform teams can use [Crossplane Compositions](#) to define this policy through API abstractions. Developers can then use these abstractions to deploy Lambda functions with tags.
- Your project uses GitOps with Kubernetes. In this model, Kubernetes continuously reconciles the git repository (desired state) with the resources running inside the cluster (current state). If there are differences, the GitOps process automatically makes changes to the cluster. You can use GitOps with Kubernetes for deploying and managing Lambda functions through Crossplane, using familiar Kubernetes tools and concepts such as [CRDs](#) and [Controllers](#).

To learn more about using Crossplane with Lambda, see the following:

- [AWS Blueprints for Crossplane](#): This repository includes examples of how to use Crossplane to deploy AWS resources, including Lambda functions.

 **Note**

AWS Blueprints for Crossplane are under active development and should not be used in production.

- [Deploying Lambda with Amazon EKS and Crossplane](#): This video demonstrates an advanced example of deploying an AWS serverless architecture with Crossplane, exploring the design from both the developer and platform perspectives.

Using Lambda with Amazon MQ

Note

If you want to send data to a target other than a Lambda function or enrich the data before sending it, see [Amazon EventBridge Pipes](#).

Amazon MQ is a managed message broker service for [Apache ActiveMQ](#) and [RabbitMQ](#). A *message broker* enables software applications and components to communicate using various programming languages, operating systems, and formal messaging protocols through either topic or queue event destinations.

Amazon MQ can also manage Amazon Elastic Compute Cloud (Amazon EC2) instances on your behalf by installing ActiveMQ or RabbitMQ brokers and by providing different network topologies and other infrastructure needs.

You can use a Lambda function to process records from your Amazon MQ message broker. Lambda invokes your function through an [event source mapping](#), a Lambda resource that reads messages from your broker and invokes the function [synchronously](#).

Warning

Lambda event source mappings process each event at least once, and duplicate processing of records can occur. To avoid potential issues related to duplicate events, we strongly recommend that you make your function code idempotent. To learn more, see [How do I make my Lambda function idempotent](#) in the AWS Knowledge Center.

The Amazon MQ event source mapping has the following configuration restrictions:

- **Concurrency** – Lambda functions that use an Amazon MQ event source mapping have a default maximum [concurrency](#) setting. For ActiveMQ, the Lambda service limits the number of concurrent execution environments to five per Amazon MQ event source mapping. For RabbitMQ, the number of concurrent execution environments is limited to 1 per Amazon MQ event source mapping. Even if you change your function's reserved or provisioned concurrency settings, the Lambda service won't make more execution environments available. To request an increase in the default maximum concurrency for a single Amazon MQ event source mapping,

contact Support with the event source mapping UUID, as well as the region. Because increases are applied at the specific event source mapping level, not the account or region level, you need to manually request a scaling increase for each event source mapping.

- Cross account – Lambda does not support cross-account processing. You cannot use Lambda to process records from an Amazon MQ message broker that is in a different AWS account.
- Authentication – For ActiveMQ, only the ActiveMQ [SimpleAuthenticationPlugin](#) is supported. For RabbitMQ, only the [PLAIN](#) authentication mechanism is supported. Users must use AWS Secrets Manager to manage their credentials. For more information about ActiveMQ authentication, see [Integrating ActiveMQ brokers with LDAP](#) in the *Amazon MQ Developer Guide*.
- Connection quota – Brokers have a maximum number of allowed connections per wire-level protocol. This quota is based on the broker instance type. For more information, see the [Brokers](#) section of **Quotas in Amazon MQ** in the *Amazon MQ Developer Guide*.
- Connectivity – You can create brokers in a public or private virtual private cloud (VPC). For private VPCs, your Lambda function needs access to the VPC to receive messages. For more information, see [the section called “Configure network security”](#) later in this section.
- Event destinations – Only queue destinations are supported. However, you can use a virtual topic, which behaves as a topic internally while interacting with Lambda as a queue. For more information, see [Virtual Destinations](#) on the Apache ActiveMQ website, and [Virtual Hosts](#) on the RabbitMQ website.
- Network topology – For ActiveMQ, only one single-instance or standby broker is supported per event source mapping. For RabbitMQ, only one single-instance broker or cluster deployment is supported per event source mapping. Single-instance brokers require a failover endpoint. For more information about these broker deployment modes, see [Active MQ Broker Architecture](#) and [Rabbit MQ Broker Architecture](#) in the *Amazon MQ Developer Guide*.
- Protocols – Supported protocols depend on the type of Amazon MQ integration.
 - For ActiveMQ integrations, Lambda consumes messages using the OpenWire/Java Message Service (JMS) protocol. No other protocols are supported for consuming messages. Within the JMS protocol, only [TextMessage](#) and [BytesMessage](#) are supported. Lambda also supports JMS custom properties. For more information about the OpenWire protocol, see [OpenWire](#) on the Apache ActiveMQ website.
 - For RabbitMQ integrations, Lambda consumes messages using the AMQP 0-9-1 protocol. No other protocols are supported for consuming messages. For more information about RabbitMQ's implementation of the AMQP 0-9-1 protocol, see [AMQP 0-9-1 Complete Reference Guide](#) on the RabbitMQ website.

Lambda automatically supports the latest versions of ActiveMQ and RabbitMQ that Amazon MQ supports. For the latest supported versions, see [Amazon MQ release notes](#) in the *Amazon MQ Developer Guide*.

Note

By default, Amazon MQ has a weekly maintenance window for brokers. During that window of time, brokers are unavailable. For brokers without standby, Lambda cannot process any messages during that window.

Topics

- [Understanding the Lambda consumer group for Amazon MQ](#)
- [Configuring Amazon MQ event source for Lambda](#)
- [Event source mapping parameters](#)
- [Filter events from an Amazon MQ event source](#)
- [Troubleshoot Amazon MQ event source mapping errors](#)

Understanding the Lambda consumer group for Amazon MQ

To interact with Amazon MQ, Lambda creates a consumer group which can read from your Amazon MQ brokers. The consumer group is created with the same ID as the event source mapping UUID.

For Amazon MQ event sources, Lambda batches records together and sends them to your function in a single payload. To control behavior, you can configure the batching window and batch size. Lambda pulls messages until it processes the payload size maximum of 6 MB, the batching window expires, or the number of records reaches the full batch size. For more information, see [Batching behavior](#).

The consumer group retrieves the messages as a BLOB of bytes, base64-encodes them into a single JSON payload, and then invokes your function. If your function returns an error for any of the messages in a batch, Lambda retries the whole batch of messages until processing succeeds or the messages expire.

Note

While Lambda functions typically have a maximum timeout limit of 15 minutes, event source mappings for Amazon MSK, self-managed Apache Kafka, Amazon DocumentDB, and Amazon MQ for ActiveMQ and RabbitMQ only support functions with maximum timeout limits of 14 minutes. This constraint ensures that the event source mapping can properly handle function errors and retries.

You can monitor a given function's concurrency usage using the `ConcurrentExecutions` metric in Amazon CloudWatch. For more information about concurrency, see [the section called "Configuring reserved concurrency"](#).

Example Amazon MQ record events**ActiveMQ**

```
{
  "eventSource": "aws:mq",
  "eventSourceArn": "arn:aws:mq:us-east-2:111122223333:broker:test:b-9bcfa592-423a-4942-879d-eb284b418fc8",
  "messages": [
    {
      "messageID": "ID:b-9bcfa592-423a-4942-879d-eb284b418fc8-1.mq.us-east-2.amazonaws.com-37557-1234520418293-4:1:1:1:1",
      "messageType": "jms/text-message",
      "deliveryMode": 1,
      "replyTo": null,
      "type": null,
      "expiration": "60000",
      "priority": 1,
      "correlationId": "myJMScoID",
      "redelivered": false,
      "destination": {
        "physicalName": "testQueue"
      },
      "data": "QUJD0kFBQUE=",
      "timestamp": 1598827811958,
      "brokerInTime": 1598827811958,
      "brokerOutTime": 1598827811959,
      "properties": {
        "index": "1",

```



```

        "doAlarm": "false",
        "myCustomProperty": "value"
    }
},
{
    "messageID": "ID:b-9bcfa592-423a-4942-879d-eb284b418fc8-1.mq.us-
east-2.amazonaws.com-37557-1234520418293-4:1:1:1:1",
    "messageType": "jms/bytes-message",
    "deliveryMode": 1,
    "replyTo": null,
    "type": null,
    "expiration": "60000",
    "priority": 2,
    "correlationId": "myJMScoID1",
    "redelivered": false,
    "destination": {
        "physicalName": "testQueue"
    },
    "data": "LQaGQ82S48k=",
    "timestamp": 1598827811958,
    "brokerInTime": 1598827811958,
    "brokerOutTime": 1598827811959,
    "properties": {
        "index": "1",
        "doAlarm": "false",
        "myCustomProperty": "value"
    }
}
]
}

```

RabbitMQ

```

{
    "eventSource": "aws:rmq",
    "eventSourceArn": "arn:aws:mq:us-
east-2:111122223333:broker:pizzaBroker:b-9bcfa592-423a-4942-879d-eb284b418fc8",
    "rmqMessagesByQueue": {
        "pizzaQueue:./": [
            {
                "basicProperties": {
                    "contentType": "text/plain",

```

```
    "contentEncoding": null,
    "headers": {
      "header1": {
        "bytes": [
          118,
          97,
          108,
          117,
          101,
          49
        ]
      },
      "header2": {
        "bytes": [
          118,
          97,
          108,
          117,
          101,
          50
        ]
      },
      "numberInHeader": 10
    },
    "deliveryMode": 1,
    "priority": 34,
    "correlationId": null,
    "replyTo": null,
    "expiration": "60000",
    "messageId": null,
    "timestamp": "Jan 1, 1970, 12:33:41 AM",
    "type": null,
    "userId": "AIDACKCEVSQ6C2EXAMPLE",
    "appId": null,
    "clusterId": null,
    "bodySize": 80
  },
  "redelivered": false,
  "data": "eyJ0aW1lb3V0IjowLCJkYXRhIjoiQ1pybWYwR3c4T3Y0YnFMUXhENEUifQ=="
}
]
}
```

Note

In the RabbitMQ example, `pizzaQueue` is the name of the RabbitMQ queue, and `/` is the name of the virtual host. When receiving messages, the event source lists messages under `pizzaQueue: :/`.

Configuring Amazon MQ event source for Lambda

Topics

- [Configure network security](#)
- [Create the event source mapping](#)

Configure network security

To give Lambda full access to Amazon MQ through your event source mapping, either your broker must use a public endpoint (public IP address), or you must provide access to the Amazon VPC you created the broker in.

When you use Amazon MQ with Lambda, create [AWS PrivateLink VPC endpoints](#) that provide your function access to the resources in your Amazon VPC.

Note

AWS PrivateLink VPC endpoints are required for functions with event source mappings that use the default (on-demand) mode for event pollers. If your event source mapping uses [provisioned mode](#), you don't need to configure AWS PrivateLink VPC endpoints.

Create an endpoint to provide access to the following resources:

- Lambda — Create an endpoint for the Lambda service principal.
- AWS STS — Create an endpoint for the AWS STS in order for a service principal to assume a role on your behalf.
- Secrets Manager — If your broker uses Secrets Manager to store credentials, create an endpoint for Secrets Manager.

Alternatively, configure a NAT gateway on each public subnet in the Amazon VPC. For more information, see [the section called “Internet access for VPC functions”](#).

When you create an event source mapping for Amazon MQ, Lambda checks whether Elastic Network Interfaces (ENIs) are already present for the subnets and security groups configured for your Amazon VPC. If Lambda finds existing ENIs, it attempts to re-use them. Otherwise, Lambda creates new ENIs to connect to the event source and invoke your function.

Note

Lambda functions always run inside VPCs owned by the Lambda service. Your function's VPC configuration does not affect the event source mapping. Only the networking configuration of the event source's determines how Lambda connects to your event source.

Configure the security groups for the Amazon VPC containing your broker. By default, Amazon MQ uses the following ports: 61617 (Amazon MQ for ActiveMQ), and 5671 (Amazon MQ for RabbitMQ).

- Inbound rules – Allow all traffic on the default broker port for the security group associated with your event source.
- Outbound rules – Allow all traffic on port 443 for all destinations. Allow all traffic on the default broker port for the security group associated with your event source.
- Amazon VPC endpoint inbound rules — If you are using an Amazon VPC endpoint, the security group associated with your Amazon VPC endpoint must allow inbound traffic on port 443 from the broker security group.

If your broker uses authentication, you can also restrict the endpoint policy for the Secrets Manager endpoint. To call the Secrets Manager API, Lambda uses your function role, not the Lambda service principal.

Example VPC endpoint policy — Secrets Manager endpoint

```
{
  "Statement": [
    {
      "Action": "secretsmanager:GetSecretValue",
      "Effect": "Allow",
      "Principal": {
```

```

        "AWS": [
            "arn:aws::iam::123456789012:role/my-role"
        ]
    },
    "Resource": "arn:aws::secretsmanager:us-west-2:123456789012:secret:my-
secret"
    }
]
}

```

When you use Amazon VPC endpoints, AWS routes your API calls to invoke your function using the endpoint's Elastic Network Interface (ENI). The Lambda service principal needs to call `lambda:InvokeFunction` on any roles and functions that use those ENIs.

By default, Amazon VPC endpoints have open IAM policies that allow broad access to resources. Best practice is to restrict these policies to perform the needed actions using that endpoint. To ensure that your event source mapping is able to invoke your Lambda function, the VPC endpoint policy must allow the Lambda service principal to call `sts:AssumeRole` and `lambda:InvokeFunction`. Restricting your VPC endpoint policies to allow only API calls originating within your organization prevents the event source mapping from functioning properly, so `"Resource": "*" is required in these policies.`

The following example VPC endpoint policies show how to grant the required access to the Lambda service principal for the AWS STS and Lambda endpoints.

Example VPC Endpoint policy — AWS STS endpoint

```

{
    "Statement": [
        {
            "Action": "sts:AssumeRole",
            "Effect": "Allow",
            "Principal": {
                "Service": [
                    "lambda.amazonaws.com"
                ]
            },
            "Resource": "*"
        }
    ]
}

```

Example VPC Endpoint policy — Lambda endpoint

```
{
  "Statement": [
    {
      "Action": "lambda:InvokeFunction",
      "Effect": "Allow",
      "Principal": {
        "Service": [
          "lambda.amazonaws.com"
        ]
      },
      "Resource": "*"
    }
  ]
}
```

Create the event source mapping

Create an [event source mapping](#) to tell Lambda to send records from an Amazon MQ broker to a Lambda function. You can create multiple event source mappings to process the same data with multiple functions, or to process items from multiple sources with a single function.

To configure your function to read from Amazon MQ, add the required permissions and create an **MQ** trigger in the Lambda console.

To read records from an Amazon MQ broker, your Lambda function needs the following permissions. You grant Lambda permission to interact with your Amazon MQ broker and its underlying resources by adding permission statements to your function [execution role](#):

- [mq:DescribeBroker](#)
- [secretsmanager:GetSecretValue](#)
- [ec2:CreateNetworkInterface](#)
- [ec2:DeleteNetworkInterface](#)
- [ec2:DescribeNetworkInterfaces](#)
- [ec2:DescribeSecurityGroups](#)
- [ec2:DescribeSubnets](#)
- [ec2:DescribeVpcs](#)
- [logs:CreateLogGroup](#)

- [logs:CreateLogStream](#)
- [logs:PutLogEvents](#)

Note

When using an encrypted customer managed key, add the [kms:Decrypt](#) permission as well.

To add permissions and create a trigger

1. Open the [Functions page](#) of the Lambda console.
2. Choose the name of a function.
3. Choose the **Configuration** tab, and then choose **Permissions**.
4. Under **Role name**, choose the link to your execution role. This link opens the role in the IAM console.

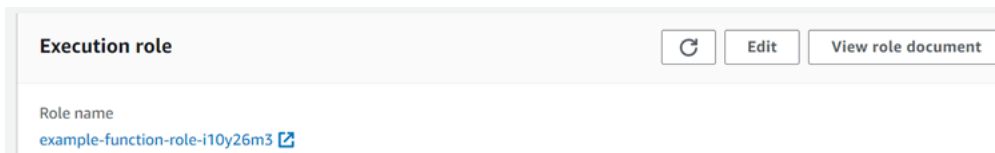

5. Choose **Add permissions**, and then choose **Create inline policy**.

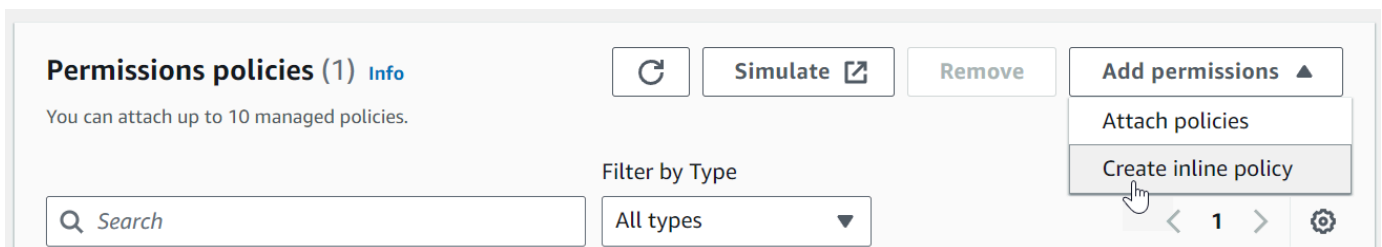

6. In the **Policy editor**, choose **JSON**. Enter the following policy. Your function needs these permissions to read from an Amazon MQ broker.

```
{
  "Version": "2012-10-17",
  "Statement": [
    {
      "Effect": "Allow",
      "Action": [
        "mq:DescribeBroker",
```

```

    "secretsmanager:GetSecretValue",
    "ec2:CreateNetworkInterface",
    "ec2:DeleteNetworkInterface",
    "ec2:DescribeNetworkInterfaces",
    "ec2:DescribeSecurityGroups",
    "ec2:DescribeSubnets",
    "ec2:DescribeVpcs",
    "logs:CreateLogGroup",
    "logs:CreateLogStream",
    "logs:PutLogEvents"
  ],
  "Resource": "*"
}
]
}

```

Note

When using an encrypted customer managed key, you must also add the `kms:Decrypt` permission.

7. Choose **Next**. Enter a policy name and then choose **Create policy**.
8. Go back to your function in the Lambda console. Under **Function overview**, choose **Add trigger**.

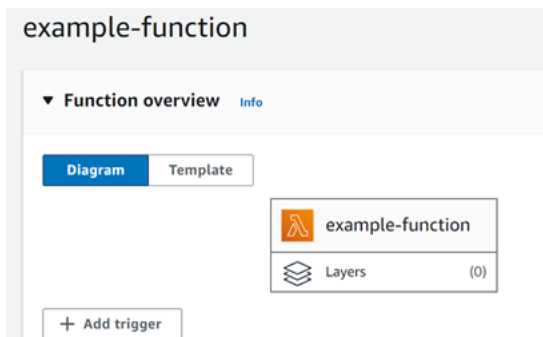

9. Choose the **MQ** trigger type.
10. Configure the required options, and then choose **Add**.

Lambda supports the following options for Amazon MQ event sources:

- **MQ broker** – Select an Amazon MQ broker.
- **Batch size** – Set the maximum number of messages to retrieve in a single batch.

- **Queue name** – Enter the Amazon MQ queue to consume.
- **Source access configuration** – Enter virtual host information and the Secrets Manager secret that stores your broker credentials.
- **Enable trigger** – Disable the trigger to stop processing records.

To enable or disable the trigger (or delete it), choose the **MQ** trigger in the designer. To reconfigure the trigger, use the event source mapping API operations.

Event source mapping parameters

All Lambda event source types share the same [CreateEventSourceMapping](#) and [UpdateEventSourceMapping](#) API operations. However, only some of the parameters apply to Amazon MQ and RabbitMQ.

Parameter	Required	Default	Notes
BatchSize	N	100	Maximum: 10,000
Enabled	N	true	none
FunctionName	Y	N/A	none
FilterCriteria	N	N/A	Control which events Lambda sends to your function
MaximumBatchingWindowInSeconds	N	500 ms	Batching behavior
Queues	N	N/A	The name of the Amazon MQ broker destination queue to consume.
SourceAccessConfigurations	N	N/A	For ActiveMQ, BASIC_AUTH credentials. For

Parameter	Required	Default	Notes
			RabbitMQ, can contain both BASIC_AUTH credentials and VIRTUAL_HOST information.

Filter events from an Amazon MQ event source

You can use event filtering to control which records from a stream or queue Lambda sends to your function. For general information about how event filtering works, see [the section called “Event filtering”](#).

This section focuses on event filtering for Amazon MQ event sources.

Topics

- [Amazon MQ event filtering basics](#)

Amazon MQ event filtering basics

Suppose your Amazon MQ message queue contains messages either in valid JSON format or as plain strings. An example record would look like the following, with the data converted to a Base64 encoded string in the data field.

ActiveMQ

```
{
  "messageID": "ID:b-9bcfa592-423a-4942-879d-eb284b418fc8-1.mq.us-east-2.amazonaws.com-37557-1234520418293-4:1:1:1:1",
  "messageType": "jms/text-message",
  "deliveryMode": 1,
  "replyTo": null,
  "type": null,
  "expiration": "60000",
  "priority": 1,
  "correlationId": "myJMScoID",
  "redelivered": false,
```

```
"destination": {
  "physicalName": "testQueue"
},
"data": "QUJD0kFBQUE=",
"timestamp": 1598827811958,
"brokerInTime": 1598827811958,
"brokerOutTime": 1598827811959,
"properties": {
  "index": "1",
  "doAlarm": "false",
  "myCustomProperty": "value"
}
}
```

RabbitMQ

```
{
  "basicProperties": {
    "contentType": "text/plain",
    "contentEncoding": null,
    "headers": {
      "header1": {
        "bytes": [
          118,
          97,
          108,
          117,
          101,
          49
        ]
      },
      "header2": {
        "bytes": [
          118,
          97,
          108,
          117,
          101,
          50
        ]
      },
      "numberInHeader": 10
    }
  },
}
```

```

    "deliveryMode": 1,
    "priority": 34,
    "correlationId": null,
    "replyTo": null,
    "expiration": "60000",
    "messageId": null,
    "timestamp": "Jan 1, 1970, 12:33:41 AM",
    "type": null,
    "userId": "AIDACKCEVSQ6C2EXAMPLE",
    "appId": null,
    "clusterId": null,
    "bodySize": 80
  },
  "redelivered": false,
  "data": "eyJ0aW1lb3V0IjowLCJkYXRhIjoiQ1pybWYwR3c4T3Y0YnFMUXhENEUifQ=="
}

```

For both Active MQ and Rabbit MQ brokers, you can use event filtering to filter records using the data key. Suppose your Amazon MQ queue contains messages in the following JSON format.

```

{
  "timeout": 0,
  "IPAddress": "203.0.113.254"
}

```

To filter only those records where the timeout field is greater than 0, the `FilterCriteria` object would be as follows.

```

{
  "Filters": [
    {
      "Pattern": "{ \"data\" : { \"timeout\" : [ { \"numeric\" : [ \">\",
0] } ] ] } }"
    }
  ]
}

```

For added clarity, here is the value of the filter's `Pattern` expanded in plain JSON.

```

{
  "data": {

```

```

    "timeout": [ { "numeric": [ ">", 0 ] } ]
  }
}

```

You can add your filter using the console, AWS CLI or an AWS SAM template.

Console

to add this filter using the console, follow the instructions in [Attaching filter criteria to an event source mapping \(console\)](#) and enter the following string for the **Filter criteria**.

```
{ "data" : { "timeout" : [ { "numeric": [ ">", 0 ] } ] } }
```

AWS CLI

To create a new event source mapping with these filter criteria using the AWS Command Line Interface (AWS CLI), run the following command.

```
aws lambda create-event-source-mapping \
  --function-name my-function \
  --event-source-arn arn:aws:mq:us-east-2:123456789012:broker:my-  
broker:b-8ac7cc01-5898-482d-be2f-a6b596050ea8 \
  --filter-criteria '{"Filters": [{"Pattern": "{ \"data\" : { \"timeout\" :  
[ { \"numeric\": [ \">\", 0 ] } ] } }"]}]'
```

To add these filter criteria to an existing event source mapping, run the following command.

```
aws lambda update-event-source-mapping \
  --uuid "a1b2c3d4-5678-90ab-cdef-1111EXAMPLE" \
  --filter-criteria '{"Filters": [{"Pattern": "{ \"data\" : { \"timeout\" :  
[ { \"numeric\": [ \">\", 0 ] } ] } }"]}]'
```

To add these filter criteria to an existing event source mapping, run the following command.

```
aws lambda update-event-source-mapping \
  --uuid "a1b2c3d4-5678-90ab-cdef-1111EXAMPLE" \
  --filter-criteria '{"Filters": [{"Pattern": "{ \"data\" : { \"timeout\" :  
[ { \"numeric\": [ \">\", 0 ] } ] } }"]}]'
```

AWS SAM

To add this filter using AWS SAM, add the following snippet to the YAML template for your event source.

```
FilterCriteria:
  Filters:
    - Pattern: '{ "data" : { "timeout" : [ { "numeric": [ ">", 0 ] ] } ] }'
```

With Amazon MQ, you can also filter records where the message is a plain string. Suppose you want to process only records where the message begins with "Result: ". The `FilterCriteria` object would look as follows.

```
{
  "Filters": [
    {
      "Pattern": "{ \"data\" : [ { \"prefix\": \"Result: \" } ] }"
    }
  ]
}
```

For added clarity, here is the value of the filter's `Pattern` expanded in plain JSON.

```
{
  "data": [
    {
      "prefix": "Result: "
    }
  ]
}
```

You can add your filter using the console, AWS CLI or an AWS SAM template.

Console

To add this filter using the console, follow the instructions in [Attaching filter criteria to an event source mapping \(console\)](#) and enter the following string for the **Filter criteria**.

```
{ "data" : [ { "prefix": "Result: " } ] }
```

AWS CLI

To create a new event source mapping with these filter criteria using the AWS Command Line Interface (AWS CLI), run the following command.

```
aws lambda create-event-source-mapping \
  --function-name my-function \
  --event-source-arn arn:aws:mq:us-east-2:123456789012:broker:my-  
broker:b-8ac7cc01-5898-482d-be2f-a6b596050ea8 \
  --filter-criteria '{"Filters": [{"Pattern": "{ \"data\" : [ { \"prefix\":  
\"Result: \" } ] }"]}]'
```

To add these filter criteria to an existing event source mapping, run the following command.

```
aws lambda update-event-source-mapping \
  --uuid "a1b2c3d4-5678-90ab-cdef-11111EXAMPLE" \
  --filter-criteria '{"Filters": [{"Pattern": "{ \"data\" : [ { \"prefix\":  
\"Result: \" } ] }"]}]'
```

AWS SAM

To add this filter using AWS SAM, add the following snippet to the YAML template for your event source.

```
FilterCriteria:
  Filters:
    - Pattern: '{ "data" : [ { "prefix": "Result " } ] }'
```

Amazon MQ messages must be UTF-8 encoded strings, either plain strings or in JSON format. That's because Lambda decodes Amazon MQ byte arrays into UTF-8 before applying filter criteria. If your messages use another encoding, such as UTF-16 or ASCII, or if the message format doesn't match the `FilterCriteria` format, Lambda processes metadata filters only. The following table summarizes the specific behavior:

Incoming message format	Filter pattern format for message properties	Resulting action
Plain string	Plain string	Lambda filters based on your filter criteria.

Incoming message format	Filter pattern format for message properties	Resulting action
Plain string	No filter pattern for data properties	Lambda filters (on the other metadata properties only) based on your filter criteria.
Plain string	Valid JSON	Lambda filters (on the other metadata properties only) based on your filter criteria.
Valid JSON	Plain string	Lambda filters (on the other metadata properties only) based on your filter criteria.
Valid JSON	No filter pattern for data properties	Lambda filters (on the other metadata properties only) based on your filter criteria.
Valid JSON	Valid JSON	Lambda filters based on your filter criteria.
Non-UTF-8 encoded string	JSON, plain string, or no pattern	Lambda filters (on the other metadata properties only) based on your filter criteria.

Troubleshoot Amazon MQ event source mapping errors

When a Lambda function encounters an unrecoverable error, your Amazon MQ consumer stops processing records. Any other consumers can continue processing, provided that they do not encounter the same error. To determine the potential cause of a stopped consumer, check the `StateTransitionReason` field in the return details of your `EventSourceMapping` for one of the following codes:

ESM_CONFIG_NOT_VALID

The event source mapping configuration is not valid.

EVENT_SOURCE_AUTHN_ERROR

Lambda failed to authenticate the event source.

EVENT_SOURCE_AUTHZ_ERROR

Lambda does not have the required permissions to access the event source.

FUNCTION_CONFIG_NOT_VALID

The function's configuration is not valid.

Records also go unprocessed if Lambda drops them due to their size. The size limit for Lambda records is 6 MB. To redeliver messages upon function error, you can use a dead-letter queue (DLQ). For more information, see [Message Redelivery and DLQ Handling](#) on the Apache ActiveMQ website and [Reliability Guide](#) on the RabbitMQ website.

Note

Lambda does not support custom redelivery policies. Instead, Lambda uses a policy with the default values from the [Redelivery Policy](#) page on the Apache ActiveMQ website, with `maximumRedeliveries` set to 6.

Using Lambda with Amazon MSK

Note

If you want to send data to a target other than a Lambda function or enrich the data before sending it, see [Amazon EventBridge Pipes](#).

[Amazon Managed Streaming for Apache Kafka \(Amazon MSK\)](#) is a fully managed service that you can use to build and run applications that use Apache Kafka to process streaming data. Amazon MSK simplifies the setup, scaling, and management of clusters running Kafka. Amazon MSK also makes it easier to configure your application for multiple Availability Zones and for security with AWS Identity and Access Management (IAM). Amazon MSK supports multiple open-source versions of Kafka.

Amazon MSK as an event source operates similarly to using Amazon Simple Queue Service (Amazon SQS) or Amazon Kinesis. Lambda internally polls for new messages from the event source and then synchronously invokes the target Lambda function. Lambda reads the messages in batches and provides these to your function as an event payload. The maximum batch size is configurable (the default is 100 messages). For more information, see [Batching behavior](#).

By default, Lambda [autoscales the number of event pollers](#) for your Amazon MSK event source mapping. To optimize the throughput of your Amazon MSK event source mapping, configure provisioned mode. In provisioned mode, you can define the minimum and maximum number of event pollers allocated to your event source mapping. This can improve the ability of your event source mapping to handle unexpected message spikes. For more information, see [provisioned mode](#).

Warning

Lambda event source mappings process each event at least once, and duplicate processing of records can occur. To avoid potential issues related to duplicate events, we strongly recommend that you make your function code idempotent. To learn more, see [How do I make my Lambda function idempotent](#) in the AWS Knowledge Center.

For an example of how to configure Amazon MSK as an event source, see [Using Amazon MSK as an event source for AWS Lambda](#) on the AWS Compute Blog. For a complete tutorial, see [Amazon MSK Lambda Integration](#) in the Amazon MSK Labs.

Topics

- [Example event](#)
- [Configuring Amazon MSK event sources for Lambda](#)
- [Processing Amazon MSK messages with Lambda](#)
- [Using event filtering with an Amazon MSK event source](#)
- [Capturing discarded batches for an Amazon MSK event source](#)
- [Tutorial: Using an Amazon MSK event source mapping to invoke a Lambda function](#)

Example event

Lambda sends the batch of messages in the event parameter when it invokes your function. The event payload contains an array of messages. Each array item contains details of the Amazon MSK topic and partition identifier, together with a timestamp and a base64-encoded message.

```
{
  "eventSource": "aws:kafka",
  "eventSourceArn": "arn:aws:kafka:us-east-1:123456789012:cluster/
vpc-2priv-2pub/751d2973-a626-431c-9d4e-d7975eb44dd7-2",
  "bootstrapServers": "b-2.demo-cluster-1.a1bcde.c1.kafka.us-
east-1.amazonaws.com:9092,b-1.demo-cluster-1.a1bcde.c1.kafka.us-
east-1.amazonaws.com:9092",
  "records": {
    "mytopic-0": [
      {
        "topic": "mytopic",
        "partition": 0,
        "offset": 15,
        "timestamp": 1545084650987,
        "timestampType": "CREATE_TIME",
        "key": "abcDEFghiJKLmnoPQRstuVWXYZ1234==",
        "value": "SGVsbG8sIHRoaXMgaXMgYSB0ZXN0Lg==",
        "headers": [
          {
            "headerKey": [
              104,
```

```
        101,  
        97,  
        100,  
        101,  
        114,  
        86,  
        97,  
        108,  
        117,  
        101  
    ]  
  }  
] }  
] }  
] }  
}
```

Configuring Amazon MSK event sources for Lambda

Before you create an event source mapping for your Amazon MSK cluster, you need to ensure that your cluster and the VPC it resides in are correctly configured. You also need to make sure that your Lambda function's [execution role](#) has the necessary IAM permissions.

Follow the instructions in the following sections to configure your Amazon MSK cluster, VPC, and Lambda function. To learn how to create the event source mapping, see [the section called "Adding Amazon MSK as an event source"](#).

Topics

- [MSK cluster authentication](#)
- [Managing API access and permissions](#)
- [Authentication and authorization errors](#)
- [Configure network security](#)

MSK cluster authentication

Lambda needs permission to access the Amazon MSK cluster, retrieve records, and perform other tasks. Amazon MSK supports several options for controlling client access to the MSK cluster.

Cluster access options

- [Unauthenticated access](#)
- [SASL/SCRAM authentication](#)
- [IAM role-based authentication](#)
- [Mutual TLS authentication](#)
- [Configuring the mTLS secret](#)
- [How Lambda chooses a bootstrap broker](#)

Unauthenticated access

If no clients access the cluster over the internet, you can use unauthenticated access.

SASL/SCRAM authentication

Amazon MSK supports Simple Authentication and Security Layer/Salted Challenge Response Authentication Mechanism (SASL/SCRAM) authentication with Transport Layer Security (TLS) encryption. For Lambda to connect to the cluster, you store the authentication credentials (user name and password) in an AWS Secrets Manager secret.

For more information about using Secrets Manager, see [User name and password authentication with AWS Secrets Manager](#) in the *Amazon Managed Streaming for Apache Kafka Developer Guide*.

Amazon MSK doesn't support SASL/PLAIN authentication.

IAM role-based authentication

You can use IAM to authenticate the identity of clients that connect to the MSK cluster. If IAM auth is active on your MSK cluster, and you don't provide a secret for auth, Lambda automatically defaults to using IAM auth. To create and deploy user or role-based policies, use the IAM console or API. For more information, see [IAM access control](#) in the *Amazon Managed Streaming for Apache Kafka Developer Guide*.

To allow Lambda to connect to the MSK cluster, read records, and perform other required actions, add the following permissions to your function's [execution role](#).

```
{
  "Version": "2012-10-17",
  "Statement": [
    {
      "Effect": "Allow",
      "Action": [
```

```

        "kafka-cluster:Connect",
        "kafka-cluster:DescribeGroup",
        "kafka-cluster:AlterGroup",
        "kafka-cluster:DescribeTopic",
        "kafka-cluster:ReadData",
        "kafka-cluster:DescribeClusterDynamicConfiguration"
    ],
    "Resource": [
        "arn:aws:kafka:region:account-id:cluster/cluster-name/cluster-uuid",
        "arn:aws:kafka:region:account-id:topic/cluster-name/cluster-uuid/topic-
name",
        "arn:aws:kafka:region:account-id:group/cluster-name/cluster-
uuid/consumer-group-id"
    ]
}
]
}
}

```

You can scope these permissions to a specific cluster, topic, and group. For more information, see the [Amazon MSK Kafka actions](#) in the *Amazon Managed Streaming for Apache Kafka Developer Guide*.

Mutual TLS authentication

Mutual TLS (mTLS) provides two-way authentication between the client and server. The client sends a certificate to the server for the server to verify the client, and the server sends a certificate to the client for the client to verify the server.

For Amazon MSK, Lambda acts as the client. You configure a client certificate (as a secret in Secrets Manager) to authenticate Lambda with the brokers in your MSK cluster. The client certificate must be signed by a CA in the server's trust store. The MSK cluster sends a server certificate to Lambda to authenticate the brokers with Lambda. The server certificate must be signed by a certificate authority (CA) that's in the AWS trust store.

For instructions on how to generate a client certificate, see [Introducing mutual TLS authentication for Amazon MSK as an event source](#).

Amazon MSK doesn't support self-signed server certificates, because all brokers in Amazon MSK use [public certificates](#) signed by [Amazon Trust Services CAs](#), which Lambda trusts by default.

For more information about mTLS for Amazon MSK, see [Mutual TLS Authentication](#) in the *Amazon Managed Streaming for Apache Kafka Developer Guide*.

Configuring the mTLS secret

The `CLIENT_CERTIFICATE_TLS_AUTH` secret requires a certificate field and a private key field. For an encrypted private key, the secret requires a private key password. Both the certificate and private key must be in PEM format.

Note

Lambda supports the [PBES1](#) (but not PBES2) private key encryption algorithms.

The certificate field must contain a list of certificates, beginning with the client certificate, followed by any intermediate certificates, and ending with the root certificate. Each certificate must start on a new line with the following structure:

```
-----BEGIN CERTIFICATE-----
    <certificate contents>
-----END CERTIFICATE-----
```

Secrets Manager supports secrets up to 65,536 bytes, which is enough space for long certificate chains.

The private key must be in [PKCS #8](#) format, with the following structure:

```
-----BEGIN PRIVATE KEY-----
    <private key contents>
-----END PRIVATE KEY-----
```

For an encrypted private key, use the following structure:

```
-----BEGIN ENCRYPTED PRIVATE KEY-----
    <private key contents>
-----END ENCRYPTED PRIVATE KEY-----
```

The following example shows the contents of a secret for mTLS authentication using an encrypted private key. For an encrypted private key, you include the private key password in the secret.

```
{
  "privateKeyPassword": "testpassword",
  "certificate": "-----BEGIN CERTIFICATE-----
MIIE5DCCAsygAwIBAgIRAPJdwaFaNRrytHBto0j5BA0wDQYJKoZIhvcNAQELBQAw
```

```

...
j0Lh4/+1HfgyE2KlmII36dg4IMzNjAFEBZiCRoPim040s1cRqtFHXoal0QQbIlxk
cmUuiAii9R0=
-----END CERTIFICATE-----
-----BEGIN CERTIFICATE-----
MIIFGjCCA2qgAwIBAgIQdjNZd6uFf9hbNC5RdfmHrzANBgkqhkiG9w0BAQsFADBb
...
rQoiowbbk5wXCheYSANQIfTZ6weQTgiCHCCbuuMKNVS95FkXm0vqVD/YpXKwA/no
c8PH3PSoAaRwMMgOSA2ALJvbRz8mpg==
-----END CERTIFICATE-----",
  "privateKey": "-----BEGIN ENCRYPTED PRIVATE KEY-----
MIIFKzBVBGkqhkiG9w0BBQ0wSDANBgkqhkiG9w0BBQwwGgQUiAFcK5hT/X7Kjmgp
...
QrSekqF+kWzmB6nAfSzg09IaoAaytLvNgGTckWeUkWn/V0Ck+LdGUXzAC4RxZnoQ
zp2mwJn2NYB7AZ7+imp0azDZb+8YG2aUCiyqb6PnnA==
-----END ENCRYPTED PRIVATE KEY-----"
}

```

How Lambda chooses a bootstrap broker

Lambda chooses a [bootstrap broker](#) based on the authentication methods available on your cluster, and whether you provide a secret for authentication. If you provide a secret for mTLS or SASL/SCRAM, Lambda automatically chooses that auth method. If you don't provide a secret, Lambda selects the strongest auth method that's active on your cluster. The following is the order of priority in which Lambda selects a broker, from strongest to weakest auth:

- mTLS (secret provided for mTLS)
- SASL/SCRAM (secret provided for SASL/SCRAM)
- SASL IAM (no secret provided, and IAM auth active)
- Unauthenticated TLS (no secret provided, and IAM auth not active)
- Plaintext (no secret provided, and both IAM auth and unauthenticated TLS are not active)

Note

If Lambda can't connect to the most secure broker type, Lambda doesn't attempt to connect to a different (weaker) broker type. If you want Lambda to choose a weaker broker type, deactivate all stronger auth methods on your cluster.

Managing API access and permissions

In addition to accessing the Amazon MSK cluster, your function needs permissions to perform various Amazon MSK API actions. You add these permissions to the function's execution role. If your users need access to any of the Amazon MSK API actions, add the required permissions to the identity policy for the user or role.

You can add each of the following permissions to your execution role manually. Alternatively, you can attach the AWS managed policy [AWSLambdaMSKExecutionRole](#) to your execution role. The `AWSLambdaMSKExecutionRole` policy contains all required API actions and VPC permissions listed below.

Required Lambda function execution role permissions

To create and store logs in a log group in Amazon CloudWatch Logs, your Lambda function must have the following permissions in its execution role:

- [logs:CreateLogGroup](#)
- [logs:CreateLogStream](#)
- [logs:PutLogEvents](#)

For Lambda to access your Amazon MSK cluster on your behalf, your Lambda function must have the following permissions in its execution role:

- [kafka:DescribeCluster](#)
- [kafka:DescribeClusterV2](#)
- [kafka:GetBootstrapBrokers](#)
- [kafka:DescribeVpcConnection](#): Only required for [cross-account event source mappings](#).
- [kafka:ListVpcConnections](#): Not required in execution role, but required for an IAM principal that is creating a [cross-account event source mapping](#).

You only need to add one of either `kafka:DescribeCluster` or `kafka:DescribeClusterV2`. For provisioned MSK clusters, either permission works. For serverless MSK clusters, you must use `kafka:DescribeClusterV2`.

Note

Lambda eventually plans to remove the `kafka:DescribeCluster` permission from the associated `AWSLambdaMSKExecutionRole` managed policy. If you use this policy, you should migrate any applications using `kafka:DescribeCluster` to use `kafka:DescribeClusterV2` instead.

VPC permissions

If only users within a VPC can access your Amazon MSK cluster, your Lambda function must have permission to access your Amazon VPC resources. These resources include your VPC, subnets, security groups, and network interfaces. To access these resources, your function's execution role must have the following permissions. These permissions are included in the [AWSLambdaMSKExecutionRole](#) AWS managed policy.

- [ec2:CreateNetworkInterface](#)
- [ec2:DescribeNetworkInterfaces](#)
- [ec2:DescribeVpcs](#)
- [ec2>DeleteNetworkInterface](#)
- [ec2:DescribeSubnets](#)
- [ec2:DescribeSecurityGroups](#)

Optional Lambda function permissions

Your Lambda function might also need permissions to:

- Access your SCRAM secret, if using SASL/SCRAM authentication.
- Describe your Secrets Manager secret.
- Access your AWS Key Management Service (AWS KMS) customer managed key.
- Send records of failed invocations to a destination.

Secrets Manager and AWS KMS permissions

Depending on the type of access control that you're configuring for your Amazon MSK brokers, your Lambda function might need permission to access your SCRAM secret (if using SASL/SCRAM

authentication), or Secrets Manager secret to decrypt your AWS KMS customer managed key. To access these resources, your function's execution role must have the following permissions:

- [kafka:ListScramSecrets](#)
- [secretsmanager:GetSecretValue](#)
- [kms:Decrypt](#)

Adding permissions to your execution role

Follow these steps to add the AWS managed policy [AWSLambdaMSKExecutionRole](#) to your execution role using the IAM console.

To add an AWS managed policy

1. Open the [Policies page](#) of the IAM console.
2. In the search box, enter the policy name (AWSLambdaMSKExecutionRole).
3. Select the policy from the list, and then choose **Policy actions, Attach**.
4. On the **Attach policy** page, select your execution role from the list, and then choose **Attach policy**.

Granting users access with an IAM policy

By default, users and roles don't have permission to perform Amazon MSK API operations. To grant access to users in your organization or account, you can add or update an identity-based policy. For more information, see [Amazon MSK Identity-Based Policy Examples](#) in the *Amazon Managed Streaming for Apache Kafka Developer Guide*.

Authentication and authorization errors

If any of the permissions required to consume data from the Amazon MSK cluster are missing, Lambda displays one of the following error messages in the event source mapping under **LastProcessingResult**.

Error messages

- [Cluster failed to authorize Lambda](#)
- [SASL authentication failed](#)

- [Server failed to authenticate Lambda](#)
- [Provided certificate or private key is invalid](#)

Cluster failed to authorize Lambda

For SASL/SCRAM or mTLS, this error indicates that the provided user doesn't have all of the following required Kafka access control list (ACL) permissions:

- DescribeConfigs Cluster
- Describe Group
- Read Group
- Describe Topic
- Read Topic

For IAM access control, your function's execution role is missing one or more of the permissions required to access the group or topic. Review the list of required permissions in [the section called "IAM role-based authentication"](#).

When you create either Kafka ACLs or an IAM policy with the required Kafka cluster permissions, specify the topic and group as resources. The topic name must match the topic in the event source mapping. The group name must match the event source mapping's UUID.

After you add the required permissions to the execution role, it might take several minutes for the changes to take effect.

SASL authentication failed

For SASL/SCRAM, this error indicates that the provided user name and password aren't valid.

For IAM access control, the execution role is missing the `kafka-cluster:Connect` permission for the MSK cluster. Add this permission to the role and specify the cluster's Amazon Resource Name (ARN) as a resource.

You might see this error occurring intermittently. The cluster rejects connections after the number of TCP connections exceeds the [Amazon MSK service quota](#). Lambda backs off and retries until a connection is successful. After Lambda connects to the cluster and polls for records, the last processing result changes to OK.

Server failed to authenticate Lambda

This error indicates that the Amazon MSK Kafka brokers failed to authenticate with Lambda. This can occur for any of the following reasons:

- You didn't provide a client certificate for mTLS authentication.
- You provided a client certificate, but the brokers aren't configured to use mTLS.
- A client certificate isn't trusted by the brokers.

Provided certificate or private key is invalid

This error indicates that the Amazon MSK consumer couldn't use the provided certificate or private key. Make sure that the certificate and key use PEM format, and that the private key encryption uses a PBES1 algorithm.

Configure network security

To give Lambda full access to Amazon MSK through your event source mapping, either your cluster must use a public endpoint (public IP address), or you must provide access to the Amazon VPC you created the cluster in.

When you use Amazon MSK with Lambda, create [AWS PrivateLink VPC endpoints](#) that provide your function access to the resources in your Amazon VPC.

Note

AWS PrivateLink VPC endpoints are required for functions with event source mappings that use the default (on-demand) mode for event pollers. If your event source mapping uses [provisioned mode](#), you don't need to configure AWS PrivateLink VPC endpoints.

Create an endpoint to provide access to the following resources:

- Lambda — Create an endpoint for the Lambda service principal.
- AWS STS — Create an endpoint for the AWS STS in order for a service principal to assume a role on your behalf.
- Secrets Manager — If your cluster uses Secrets Manager to store credentials, create an endpoint for Secrets Manager.

Alternatively, configure a NAT gateway on each public subnet in the Amazon VPC. For more information, see [the section called “Internet access for VPC functions”](#).

When you create an event source mapping for Amazon MSK, Lambda checks whether Elastic Network Interfaces (ENIs) are already present for the subnets and security groups configured for your Amazon VPC. If Lambda finds existing ENIs, it attempts to re-use them. Otherwise, Lambda creates new ENIs to connect to the event source and invoke your function.

Note

Lambda functions always run inside VPCs owned by the Lambda service. Your function's VPC configuration does not affect the event source mapping. Only the networking configuration of the event source's determines how Lambda connects to your event source.

Configure the security groups for the Amazon VPC containing your cluster. By default, Amazon MSK uses the following ports: 9092 for plaintext, 9094 for TLS, 9096 for SASL, 9098 for IAM.

- Inbound rules – Allow all traffic on the default cluster port for the security group associated with your event source.
- Outbound rules – Allow all traffic on port 443 for all destinations. Allow all traffic on the default cluster port for the security group associated with your event source.
- Amazon VPC endpoint inbound rules — If you are using an Amazon VPC endpoint, the security group associated with your Amazon VPC endpoint must allow inbound traffic on port 443 from the cluster security group.

If your cluster uses authentication, you can also restrict the endpoint policy for the Secrets Manager endpoint. To call the Secrets Manager API, Lambda uses your function role, not the Lambda service principal.

Example VPC endpoint policy — Secrets Manager endpoint

```
{
  "Statement": [
    {
      "Action": "secretsmanager:GetSecretValue",
      "Effect": "Allow",
      "Principal": {
```

```

        "AWS": [
            "arn:aws::iam::123456789012:role/my-role"
        ]
    },
    "Resource": "arn:aws::secretsmanager:us-west-2:123456789012:secret:my-
secret"
    }
]
}

```

When you use Amazon VPC endpoints, AWS routes your API calls to invoke your function using the endpoint's Elastic Network Interface (ENI). The Lambda service principal needs to call `lambda:InvokeFunction` on any roles and functions that use those ENIs.

By default, Amazon VPC endpoints have open IAM policies that allow broad access to resources. Best practice is to restrict these policies to perform the needed actions using that endpoint. To ensure that your event source mapping is able to invoke your Lambda function, the VPC endpoint policy must allow the Lambda service principal to call `sts:AssumeRole` and `lambda:InvokeFunction`. Restricting your VPC endpoint policies to allow only API calls originating within your organization prevents the event source mapping from functioning properly, so `"Resource": "*" is required in these policies.`

The following example VPC endpoint policies show how to grant the required access to the Lambda service principal for the AWS STS and Lambda endpoints.

Example VPC Endpoint policy — AWS STS endpoint

```

{
    "Statement": [
        {
            "Action": "sts:AssumeRole",
            "Effect": "Allow",
            "Principal": {
                "Service": [
                    "lambda.amazonaws.com"
                ]
            },
            "Resource": "*"
        }
    ]
}

```

Example VPC Endpoint policy — Lambda endpoint

```
{
  "Statement": [
    {
      "Action": "lambda:InvokeFunction",
      "Effect": "Allow",
      "Principal": {
        "Service": [
          "lambda.amazonaws.com"
        ]
      },
      "Resource": "*"
    }
  ]
}
```

Processing Amazon MSK messages with Lambda

Note

If you want to send data to a target other than a Lambda function or enrich the data before sending it, see [Amazon EventBridge Pipes](#).

Topics

- [Adding Amazon MSK as an event source](#)
- [Amazon MSK configuration parameters](#)
- [Creating cross-account event source mappings](#)
- [Using an Amazon MSK cluster as an event source](#)
- [Polling and stream starting positions](#)
- [Amazon CloudWatch metrics](#)
- [Message throughput scaling behavior for Amazon MSK event source mappings](#)

Adding Amazon MSK as an event source

To create an [event source mapping](#), add Amazon MSK as a Lambda function [trigger](#) using the Lambda console, an [AWS SDK](#), or the [AWS Command Line Interface \(AWS CLI\)](#). Note that when you

add Amazon MSK as a trigger, Lambda assumes the VPC settings of the Amazon MSK cluster, not the Lambda function's VPC settings.

This section describes how to create an event source mapping using the Lambda console and the AWS CLI.

Prerequisites

- An Amazon MSK cluster and a Kafka topic. For more information, see [Getting Started Using Amazon MSK](#) in the *Amazon Managed Streaming for Apache Kafka Developer Guide*.
- An [execution role](#) with permission to access the AWS resources that your MSK cluster uses.

Customizable consumer group ID

When setting up Kafka as an event source, you can specify a consumer group ID. This consumer group ID is an existing identifier for the Kafka consumer group that you want your Lambda function to join. You can use this feature to seamlessly migrate any ongoing Kafka record processing setups from other consumers to Lambda.

If you specify a consumer group ID and there are other active pollers within that consumer group, Kafka distributes messages across all consumers. In other words, Lambda doesn't receive all message for the Kafka topic. If you want Lambda to handle all messages in the topic, turn off any other pollers in that consumer group.

Additionally, if you specify a consumer group ID, and Kafka finds a valid existing consumer group with the same ID, Lambda ignores the `StartingPosition` parameter for your event source mapping. Instead, Lambda begins processing records according to the committed offset of the consumer group. If you specify a consumer group ID, and Kafka cannot find an existing consumer group, then Lambda configures your event source with the specified `StartingPosition`.

The consumer group ID that you specify must be unique among all your Kafka event sources. After creating a Kafka event source mapping with the consumer group ID specified, you cannot update this value.

Adding an Amazon MSK trigger (console)

Follow these steps to add your Amazon MSK cluster and a Kafka topic as a trigger for your Lambda function.

To add an Amazon MSK trigger to your Lambda function (console)

1. Open the [Functions page](#) of the Lambda console.
2. Choose the name of your Lambda function.
3. Under **Function overview**, choose **Add trigger**.
4. Under **Trigger configuration**, do the following:
 - a. Choose the **MSK** trigger type.
 - b. For **MSK cluster**, select your cluster.
 - c. For **Batch size**, enter the maximum number of messages to receive in a single batch.
 - d. For **Batch window**, enter the maximum amount of seconds that Lambda spends gathering records before invoking the function.
 - e. For **Topic name**, enter the name of a Kafka topic.
 - f. (Optional) For **Consumer group ID**, enter the ID of a Kafka consumer group to join.
 - g. (Optional) For **Starting position**, choose **Latest** to start reading the stream from the latest record, **Trim horizon** to start at the earliest available record, or **At timestamp** to specify a timestamp to start reading from.
 - h. (Optional) For **Authentication**, choose the secret key for authenticating with the brokers in your MSK cluster.
 - i. To create the trigger in a disabled state for testing (recommended), clear **Enable trigger**. Or, to enable the trigger immediately, select **Enable trigger**.
5. To create the trigger, choose **Add**.

Adding an Amazon MSK trigger (AWS CLI)

Use the following example AWS CLI commands to create and view an Amazon MSK trigger for your Lambda function.

Creating a trigger using the AWS CLI

Example — Create event source mapping for cluster that uses IAM authentication

The following example uses the [create-event-source-mapping](#) AWS CLI command to map a Lambda function named `my-kafka-function` to a Kafka topic named `AWSKafkaTopic`. The topic's starting position is set to `LATEST`. When the cluster uses [IAM role-based authentication](#), you don't need a [SourceAccessConfiguration](#) object. Example:

```
aws lambda create-event-source-mapping \
  --event-source-arn arn:aws:kafka:us-east-1:111122223333:cluster/my-cluster/fc2f5bdf-
fd1b-45ad-85dd-15b4a5a6247e-2 \
  --topics AWSKafkaTopic \
  --starting-position LATEST \
  --function-name my-kafka-function
```

Example — Create event source mapping for cluster that uses SASL/SCRAM authentication

If the cluster uses [SASL/SCRAM authentication](#), you must include a [SourceAccessConfiguration](#) object that specifies SASL_SCRAM_512_AUTH and a Secrets Manager secret ARN.

```
aws lambda create-event-source-mapping \
  --event-source-arn arn:aws:kafka:us-east-1:111122223333:cluster/my-cluster/fc2f5bdf-
fd1b-45ad-85dd-15b4a5a6247e-2 \
  --topics AWSKafkaTopic \
  --starting-position LATEST \
  --function-name my-kafka-function
  --source-access-configurations '["Type": "SASL_SCRAM_512_AUTH", "URI":
"arn:aws:secretsmanager:us-east-1:111122223333:secret:my-secret"]]'
```

Example — Create event source mapping for cluster that uses mTLS authentication

If the cluster uses [mTLS authentication](#), you must include a [SourceAccessConfiguration](#) object that specifies CLIENT_CERTIFICATE_TLS_AUTH and a Secrets Manager secret ARN.

```
aws lambda create-event-source-mapping \
  --event-source-arn arn:aws:kafka:us-east-1:111122223333:cluster/my-cluster/fc2f5bdf-
fd1b-45ad-85dd-15b4a5a6247e-2 \
  --topics AWSKafkaTopic \
  --starting-position LATEST \
  --function-name my-kafka-function
  --source-access-configurations '["Type": "CLIENT_CERTIFICATE_TLS_AUTH", "URI":
"arn:aws:secretsmanager:us-east-1:111122223333:secret:my-secret"]]'
```

For more information, see the [CreateEventSourceMapping](#) API reference documentation.

Viewing the status using the AWS CLI

The following example uses the [get-event-source-mapping](#) AWS CLI command to describe the status of the event source mapping that you created.

```
aws lambda get-event-source-mapping \
  --uuid 6d9bce8e-836b-442c-8070-74e77903c815
```

Amazon MSK configuration parameters

All Lambda event source types share the same [CreateEventSourceMapping](#) and [UpdateEventSourceMapping](#) API operations. However, only some of the parameters apply to Amazon MSK.

Parameter	Required	Default	Notes
AmazonManagedKafkaEventSourceConfig	N	Contains the ConsumerGroupId field, which defaults to a unique value.	Can set only on Create
BatchSize	N	100	Maximum: 10,000
DestinationConfig	N	N/A	the section called "On-failure destinations"
Enabled	N	True	
EventSourceArn	Y	N/A	Can set only on Create
FilterCriteria	N	N/A	Control which events Lambda sends to your function
FunctionName	Y	N/A	
KMSKeyArn	N	N/A	the section called "Encryption of filter criteria"

Parameter	Required	Default	Notes
MaximumBatchingWindowInSeconds	N	500 ms	Batching behavior
ProvisionedPollersConfig	N	MinimumPollers : default value of 1 if not specified MaximumPollers : default value of 200 if not specified	the section called "Configuring provisioned mode"
SourceAccessConfigurations	N	No credentials	SASL/SCRAM or CLIENT_CERTIFICATE_TLS_AUTH (MutualTLS) authentication credentials for your event source
StartingPosition	Y	N/A	AT_TIMESTAMP, TRIM_HORIZON, or LATEST Can set only on Create
StartingPositionTimestamp	N	N/A	Required if StartingPosition is set to AT_TIMESTAMP
Tags	N	N/A	the section called "Event source mapping tags"

Parameter	Required	Default	Notes
Topics	Y	N/A	Kafka topic name Can set only on Create

Creating cross-account event source mappings

You can use [multi-VPC private connectivity](#) to connect a Lambda function to a provisioned MSK cluster in a different AWS account. Multi-VPC connectivity uses AWS PrivateLink, which keeps all traffic within the AWS network.

Note

You can't create cross-account event source mappings for serverless MSK clusters.

To create a cross-account event source mapping, you must first [configure multi-VPC connectivity for the MSK cluster](#). When you create the event source mapping, use the managed VPC connection ARN instead of the cluster ARN, as shown in the following examples. The [CreateEventSourceMapping](#) operation also differs depending on which authentication type the MSK cluster uses.

Example — Create cross-account event source mapping for cluster that uses IAM authentication

When the cluster uses [IAM role-based authentication](#), you don't need a [SourceAccessConfiguration](#) object. Example:

```
aws lambda create-event-source-mapping \
  --event-source-arn arn:aws:kafka:us-east-1:111122223333:vpc-connection/444455556666/  
my-cluster-name/51jn98b4-0a61-46cc-b0a6-61g9a3d797d5-7 \
  --topics AWSKafkaTopic \
  --starting-position LATEST \
  --function-name my-kafka-function
```

Example — Create cross-account event source mapping for cluster that uses SASL/SCRAM authentication

If the cluster uses [SASL/SCRAM authentication](#), you must include a [SourceAccessConfiguration](#) object that specifies SASL_SCRAM_512_AUTH and a Secrets Manager secret ARN.

There are two ways to use secrets for cross-account Amazon MSK event source mappings with SASL/SCRAM authentication:

- Create a secret in the Lambda function account and sync it with the cluster secret. [Create a rotation](#) to keep the two secrets in sync. This option allows you to control the secret from the function account.
- Use the secret that's associated with the MSK cluster. This secret must allow cross-account access to the Lambda function account. For more information, see [Permissions to AWS Secrets Manager secrets for users in a different account](#).

```
aws lambda create-event-source-mapping \  
  --event-source-arn arn:aws:kafka:us-east-1:111122223333:vpc-connection/444455556666/  
my-cluster-name/51jn98b4-0a61-46cc-b0a6-61g9a3d797d5-7 \  
  --topics AWSKafkaTopic \  
  --starting-position LATEST \  
  --function-name my-kafka-function \  
  --source-access-configurations '["Type": "SASL_SCRAM_512_AUTH", "URI":  
"arn:aws:secretsmanager:us-east-1:444455556666:secret:my-secret"]'
```

Example — Create cross-account event source mapping for cluster that uses mTLS authentication

If the cluster uses [mTLS authentication](#), you must include a [SourceAccessConfiguration](#) object that specifies CLIENT_CERTIFICATE_TLS_AUTH and a Secrets Manager secret ARN. The secret can be stored in the cluster account or the Lambda function account.

```
aws lambda create-event-source-mapping \  
  --event-source-arn arn:aws:kafka:us-east-1:111122223333:vpc-connection/444455556666/  
my-cluster-name/51jn98b4-0a61-46cc-b0a6-61g9a3d797d5-7 \  
  --topics AWSKafkaTopic \  
  --starting-position LATEST \  
  --function-name my-kafka-function \  
  --source-access-configurations '["Type": "CLIENT_CERTIFICATE_TLS_AUTH", "URI":  
"arn:aws:secretsmanager:us-east-1:444455556666:secret:my-secret"]'
```

```
--source-access-configurations '[{"Type": "CLIENT_CERTIFICATE_TLS_AUTH", "URI":  
"arn:aws:secretsmanager:us-east-1:444455556666:secret:my-secret"}]'
```

Using an Amazon MSK cluster as an event source

When you add your Apache Kafka or Amazon MSK cluster as a trigger for your Lambda function, the cluster is used as an [event source](#).

Lambda reads event data from the Kafka topics that you specify as `Topics` in a [CreateEventSourceMapping](#) request, based on the `StartingPosition` that you specify. After successful processing, your Kafka topic is committed to your Kafka cluster.

If you specify the `StartingPosition` as `LATEST`, Lambda starts reading from the latest message in each partition belonging to the topic. Because there can be some delay after trigger configuration before Lambda starts reading the messages, Lambda doesn't read any messages produced during this window.

Lambda reads messages sequentially for each Kafka topic partition. A single Lambda payload can contain messages from multiple partitions. When more records are available, Lambda continues processing records in batches, based on the `BatchSize` value that you specify in a [CreateEventSourceMapping](#) request, until your function catches up with the topic.

After Lambda processes each batch, it commits the offsets of the messages in that batch. If your function returns an error for any of the messages in a batch, Lambda retries the whole batch of messages until processing succeeds or the messages expire. You can send records that fail all retry attempts to an [on-failure destination](#) for later processing.

Note

While Lambda functions typically have a maximum timeout limit of 15 minutes, event source mappings for Amazon MSK, self-managed Apache Kafka, Amazon DocumentDB, and Amazon MQ for ActiveMQ and RabbitMQ only support functions with maximum timeout limits of 14 minutes. This constraint ensures that the event source mapping can properly handle function errors and retries.

Polling and stream starting positions

Be aware that stream polling during event source mapping creation and updates is eventually consistent.

- During event source mapping creation, it may take several minutes to start polling events from the stream.
- During event source mapping updates, it may take several minutes to stop and restart polling events from the stream.

This behavior means that if you specify LATEST as the starting position for the stream, the event source mapping could miss events during creation or updates. To ensure that no events are missed, specify the stream starting position as TRIM_HORIZON or AT_TIMESTAMP.

Amazon CloudWatch metrics

Lambda emits the `OffsetLag` metric while your function processes records. The value of this metric is the difference in offset between the last record written to the Kafka event source topic and the last record that your function's consumer group processed. You can use `OffsetLag` to estimate the latency between when a record is added and when your consumer group processes it.

An increasing trend in `OffsetLag` can indicate issues with pollers in your function's consumer group. For more information, see [Using CloudWatch metrics with Lambda](#).

Message throughput scaling behavior for Amazon MSK event source mappings

You can choose between two modes of message throughput scaling behavior for your Amazon MSK event source mapping:

- [the section called "Default \(on-demand\) mode"](#)
- [Provisioned mode](#)

Default (on-demand) mode

When you initially create an Amazon MSK event source, Lambda allocates a default number of event pollers to process all partitions in the Kafka topic. Lambda automatically scales up or down the number of event pollers based on message load.

In one-minute intervals, Lambda evaluates the [offset lag](#) of all the partitions in the topic. If the offset lag is too high, the partition is receiving messages faster than Lambda can process them. If necessary, Lambda adds or removes event pollers from the topic. This autoscaling process of adding or removing event pollers occurs within three minutes of evaluation.

If your target Lambda function is throttled, Lambda reduces the number of event pollers. This action reduces the workload on the function by reducing the number of messages that event pollers can retrieve and send to the function.

Configuring provisioned mode

For workloads where you need to fine-tune the throughput of your event source mapping, you can use provisioned mode. In provisioned mode, you define minimum and maximum limits for the amount of provisioned event pollers. These provisioned event pollers are dedicated to your event source mapping, and can handle unexpected message spikes through responsive autoscaling. We recommend that you use provisioned mode for Kafka workloads that have strict performance requirements.

In Lambda, an event poller is a compute unit capable of handling up to 5 MBps of throughput. For reference, suppose your event source produces an average payload of 1MB, and the average function duration is 1 sec. If the payload doesn't undergo any transformation (such as filtering), a single poller can support 5 MBps throughput, and 5 concurrent Lambda invocations. Using provisioned mode incurs additional costs. For pricing estimates, see [AWS Lambda pricing](#).

Note

When using provisioned mode, you don't need to create AWS PrivateLink VPC endpoints or grant the associated permissions as part of your [network configuration](#).

In provisioned mode, the range of accepted values for the minimum number of event pollers (`MinimumPollers`) is between 1 and 200, inclusive. The range of accepted values for the maximum number of event pollers (`MaximumPollers`) is between 1 and 2,000, inclusive. `MaximumPollers` must be greater than or equal to `MinimumPollers`. In addition, to maintain ordered processing within partitions, Lambda caps the `MaximumPollers` to the number of partitions in the topic.

For more details about choosing appropriate values for minimum and maximum event pollers, see [the section called "Best practices and considerations when using provisioned mode"](#).

You can configure provisioned mode for your Amazon MSK event source mapping using the console or the Lambda API.

To configure provisioned mode for an existing Amazon MSK event source mapping (console)

1. Open the [Functions page](#) of the Lambda console.
2. Choose the function with the Amazon MSK event source mapping you want to configure provisioned mode for.
3. Choose **Configuration**, then choose **Triggers**.
4. Choose the Amazon MSK event source mapping that you want to configure provisioned mode for, then choose **Edit**.
5. Under **Event source mapping configuration**, choose **Configure provisioned mode**.
 - For **Minimum event pollers**, enter a value between 1 and 200. If you don't specify a value, Lambda chooses a default value of 1.
 - For **Maximum event pollers**, enter a value between 1 and 2,000. This value must be greater than or equal to your value for **Minimum event pollers**. If you don't specify a value, Lambda chooses a default value of 200.
6. Choose **Save**.

You can configure provisioned mode programmatically using the [ProvisionedPollerConfig](#) object in your [EventSourceMappingConfiguration](#). For example, the following [UpdateEventSourceMapping](#) CLI command configures a `MinimumPollers` value of 5, and a `MaximumPollers` value of 100.

```
aws lambda update-event-source-mapping \  
  --uuid a1b2c3d4-5678-90ab-cdef-EXAMPLE11111 \  
  --provisioned-poller-config '{"MinimumPollers": 5, "MaximumPollers": 100}'
```

After configuring provisioned mode, you can observe the usage of event pollers for your workload by monitoring the `ProvisionedPollers` metric. For more information, see [the section called “Event source mapping metrics”](#).

To disable provisioned mode and return to default (on-demand) mode, you can use the following [UpdateEventSourceMapping](#) CLI command:

```
aws lambda update-event-source-mapping \  
  --uuid a1b2c3d4-5678-90ab-cdef-EXAMPLE11111 \  
  --provisioned-poller-config '{}'
```

Best practices and considerations when using provisioned mode

The optimal configuration of minimum and maximum event pollers for your event source mapping depends on your application's performance requirements. We recommend that you start with the default minimum event pollers to baseline the performance profile. Adjust your configuration based on observed message processing patterns and your desired performance profile.

For workloads with spiky traffic and strict performance needs, increase the minimum event pollers to handle sudden surges in messages. To determine the minimum event pollers required, consider your workload's messages per second and average payload size, and use the throughput capacity of a single event poller (up to 5 MBps) as a reference.

To maintain ordered processing within a partition, Lambda limits the maximum event pollers to the number of partitions in the topic. Additionally, the maximum event pollers your event source mapping can scale to depends on the function's concurrency settings.

When activating provisioned mode, update your network settings to remove AWS PrivateLink VPC endpoints and associated permissions.

Using event filtering with an Amazon MSK event source

You can use event filtering to control which records from a stream or queue Lambda sends to your function. For general information about how event filtering works, see [the section called "Event filtering"](#).

This section focuses on event filtering for Amazon MSK event sources.

Topics

- [Amazon MSK event filtering basics](#)

Amazon MSK event filtering basics

Suppose a producer is writing messages to a topic in your Amazon MSK cluster, either in valid JSON format or as plain strings. An example record would look like the following, with the message converted to a Base64 encoded string in the `value` field.

```
{
  "mytopic-0": [
```

```

    {
      "topic": "mytopic",
      "partition": 0,
      "offset": 15,
      "timestamp": 1545084650987,
      "timestampType": "CREATE_TIME",
      "value": "SGVsbG8sIHRoaXMgaXMgYSB0ZXN0Lg==",
      "headers": []
    }
  ]
}

```

Suppose your Apache Kafka producer is writing messages to your topic in the following JSON format.

```

{
  "device_ID": "AB1234",
  "session": {
    "start_time": "yyyy-mm-ddThh:mm:ss",
    "duration": 162
  }
}

```

You can use the `value` key to filter records. Suppose you wanted to filter only those records where `device_ID` begins with the letters AB. The `FilterCriteria` object would be as follows.

```

{
  "Filters": [
    {
      "Pattern": "{ \"value\" : { \"device_ID\" : [ { \"prefix\": \"AB\" } ] } }"
    }
  ]
}

```

For added clarity, here is the value of the filter's `Pattern` expanded in plain JSON.

```

{
  "value": {
    "device_ID": [ { "prefix": "AB" } ]
  }
}

```

You can add your filter using the console, AWS CLI or an AWS SAM template.

Console

To add this filter using the console, follow the instructions in [Attaching filter criteria to an event source mapping \(console\)](#) and enter the following string for the **Filter criteria**.

```
{ "value" : { "device_ID" : [ { "prefix": "AB" } ] } }
```

AWS CLI

To create a new event source mapping with these filter criteria using the AWS Command Line Interface (AWS CLI), run the following command.

```
aws lambda create-event-source-mapping \
  --function-name my-function \
  --event-source-arn arn:aws:kafka:us-east-2:123456789012:cluster/my-cluster/  
b-8ac7cc01-5898-482d-be2f-a6b596050ea8 \
  --filter-criteria '{"Filters": [{"Pattern": "{ \"value\" : { \"device_ID\" :  
[ { \"prefix\": \"AB\" } ] } }"]}'
```

To add these filter criteria to an existing event source mapping, run the following command.

```
aws lambda update-event-source-mapping \
  --uuid "a1b2c3d4-5678-90ab-cdef-1111EXAMPLE" \
  --filter-criteria '{"Filters": [{"Pattern": "{ \"value\" : { \"device_ID\" :  
[ { \"prefix\": \"AB\" } ] } }"]}'
```

AWS SAM

To add this filter using AWS SAM, add the following snippet to the YAML template for your event source.

```
FilterCriteria:
  Filters:
    - Pattern: '{ "value" : { "device_ID" : [ { "prefix": "AB" } ] } }'
```

With Amazon MSK, you can also filter records where the message is a plain string. Suppose you want to ignore those messages where the string is "error". The `FilterCriteria` object would look as follows.

```
{
  "Filters": [
    {
      "Pattern": "{ \"value\" : [ { \"anything-but\": [ \"error\" ] } ] }"
    }
  ]
}
```

For added clarity, here is the value of the filter's `Pattern` expanded in plain JSON.

```
{
  "value": [
    {
      "anything-but": [ "error" ]
    }
  ]
}
```

You can add your filter using the console, AWS CLI or an AWS SAM template.

Console

To add this filter using the console, follow the instructions in [Attaching filter criteria to an event source mapping \(console\)](#) and enter the following string for the **Filter criteria**.

```
{ "value" : [ { "anything-but": [ "error" ] } ] }
```

AWS CLI

To create a new event source mapping with these filter criteria using the AWS Command Line Interface (AWS CLI), run the following command.

```
aws lambda create-event-source-mapping \
  --function-name my-function \
  --event-source-arn arn:aws:kafka:us-east-2:123456789012:cluster/my-cluster/  
b-8ac7cc01-5898-482d-be2f-a6b596050ea8 \
  --filter-criteria '{"Filters": [{"Pattern": "{ \"value\" : [ { \"anything-but\":  
[ \"error\" ] } ] }"]}'
```

To add these filter criteria to an existing event source mapping, run the following command.

```
aws lambda update-event-source-mapping \
  --uuid "a1b2c3d4-5678-90ab-cdef-11111EXAMPLE" \
  --filter-criteria '{"Filters": [{"Pattern": "{ \"value\" : [ { \"anything-but\": [ \"error\" ] } ] }"]}'
```

AWS SAM

To add this filter using AWS SAM, add the following snippet to the YAML template for your event source.

```
FilterCriteria:
  Filters:
    - Pattern: '{ "value" : [ { "anything-but": [ "error" ] } ] }'
```

Amazon MSK messages must be UTF-8 encoded strings, either plain strings or in JSON format. That's because Lambda decodes Amazon MSK byte arrays into UTF-8 before applying filter criteria. If your messages use another encoding, such as UTF-16 or ASCII, or if the message format doesn't match the `FilterCriteria` format, Lambda processes metadata filters only. The following table summarizes the specific behavior:

Incoming message format	Filter pattern format for message properties	Resulting action
Plain string	Plain string	Lambda filters based on your filter criteria.
Plain string	No filter pattern for data properties	Lambda filters (on the other metadata properties only) based on your filter criteria.
Plain string	Valid JSON	Lambda filters (on the other metadata properties only) based on your filter criteria.
Valid JSON	Plain string	Lambda filters (on the other metadata properties only) based on your filter criteria.

Incoming message format	Filter pattern format for message properties	Resulting action
Valid JSON	No filter pattern for data properties	Lambda filters (on the other metadata properties only) based on your filter criteria.
Valid JSON	Valid JSON	Lambda filters based on your filter criteria.
Non-UTF-8 encoded string	JSON, plain string, or no pattern	Lambda filters (on the other metadata properties only) based on your filter criteria.

Capturing discarded batches for an Amazon MSK event source

To retain records of failed event source mapping invocations, add a destination to your function's event source mapping. Each record sent to the destination is a JSON document containing metadata about the failed invocation. For Amazon S3 destinations, Lambda also sends the entire invocation record along with the metadata. You can configure any Amazon SNS topic, Amazon SQS queue, or S3 bucket as a destination.

With Amazon S3 destinations, you can use the [Amazon S3 Event Notifications](#) feature to receive notifications when objects are uploaded to your destination S3 bucket. You can also configure S3 Event Notifications to invoke another Lambda function to perform automated processing on failed batches.

Your execution role must have permissions for the destination:

- **For SQS destinations:** [sqs:SendMessage](#)
- **For SNS destinations:** [sns:Publish](#)
- **For S3 bucket destinations:** [s3:PutObject](#) and [s3:ListBucket](#)

You must deploy a VPC endpoint for your on-failure destination service inside your Amazon MSK cluster VPC.

Additionally, if you configured a KMS key on your destination, Lambda needs the following permissions depending on the destination type:

- If you've enabled encryption with your own KMS key for an S3 destination, [kms:GenerateDataKey](#) is required. If the KMS key and S3 bucket destination are in a different account from your Lambda function and execution role, configure the KMS key to trust the execution role to allow `kms:GenerateDataKey`.
- If you've enabled encryption with your own KMS key for SQS destination, [kms:Decrypt](#) and [kms:GenerateDataKey](#) are required. If the KMS key and SQS queue destination are in a different account from your Lambda function and execution role, configure the KMS key to trust the execution role to allow `kms:Decrypt`, `kms:GenerateDataKey`, [kms:DescribeKey](#), and [kms:ReEncrypt](#).
- If you've enabled encryption with your own KMS key for SNS destination, [kms:Decrypt](#) and [kms:GenerateDataKey](#) are required. If the KMS key and SNS topic destination are in a different account from your Lambda function and execution role, configure the KMS key to trust the execution role to allow `kms:Decrypt`, `kms:GenerateDataKey`, [kms:DescribeKey](#), and [kms:ReEncrypt](#).

Configuring on-failure destinations for an Amazon MSK event source mapping

To configure an on-failure destination using the console, follow these steps:

1. Open the [Functions page](#) of the Lambda console.
2. Choose a function.
3. Under **Function overview**, choose **Add destination**.
4. For **Source**, choose **Event source mapping invocation**.
5. For **Event source mapping**, choose an event source that's configured for this function.
6. For **Condition**, select **On failure**. For event source mapping invocations, this is the only accepted condition.
7. For **Destination type**, choose the destination type that Lambda sends invocation records to.
8. For **Destination**, choose a resource.
9. Choose **Save**.

You can also configure an on-failure destination using the AWS CLI. For example, the following [create-event-source-mapping](#) command adds an event source mapping with an SQS on-failure destination to MyFunction:

```
aws lambda create-event-source-mapping \  
--function-name "MyFunction" \  
--event-source-arn arn:aws:kafka:us-east-1:123456789012:cluster/  
vpc-2priv-2pub/751d2973-a626-431c-9d4e-d7975eb44dd7-2 \  
--destination-config '{"OnFailure": {"Destination": "arn:aws:sqs:us-  
east-1:123456789012:dest-queue"}}'
```

The following [update-event-source-mapping](#) command adds an S3 on-failure destination to the event source associated with the input uuid:

```
aws lambda update-event-source-mapping \  
--uuid f89f8514-cdd9-4602-9e1f-01a5b77d449b \  
--destination-config '{"OnFailure": {"Destination": "arn:aws:s3:::dest-bucket"}}'
```

To remove a destination, supply an empty string as the argument to the `destination-config` parameter:

```
aws lambda update-event-source-mapping \  
--uuid f89f8514-cdd9-4602-9e1f-01a5b77d449b \  
--destination-config '{"OnFailure": {"Destination": ""}}'
```

Security best practices for Amazon S3 destinations

Deleting an S3 bucket that's configured as a destination without removing the destination from your function's configuration can create a security risk. If another user knows your destination bucket's name, they can recreate the bucket in their AWS account. Records of failed invocations will be sent to their bucket, potentially exposing data from your function.

Warning

To ensure that invocation records from your function can't be sent to an S3 bucket in another AWS account, add a condition to your function's execution role that limits `s3:PutObject` permissions to buckets in your account.

The following example shows an IAM policy that limits your function's `s3:PutObject` permissions to buckets in your account. This policy also gives Lambda the `s3:ListBucket` permission it needs to use an S3 bucket as a destination.

```
{
  "Version": "2012-10-17",
  "Statement": [
    {
      "Sid": "S3BucketResourceAccountWrite",
      "Effect": "Allow",
      "Action": [
        "s3:PutObject",
        "s3:ListBucket"
      ],
      "Resource": "arn:aws:s3:::*/*",
      "Condition": {
        "StringEquals": {
          "s3:ResourceAccount": "111122223333"
        }
      }
    }
  ]
}
```

To add a permissions policy to your function's execution role using the AWS Management Console or AWS CLI, refer to the instructions in the following procedures:

Console

To add a permissions policy to a function's execution role (console)

1. Open the [Functions page](#) of the Lambda console.
2. Select the Lambda function whose execution role you want to modify.
3. In the **Configuration** tab, select **Permissions**.
4. In the **Execution role** tab, select your function's **Role name** to open the role's IAM console page.
5. Add a permissions policy to the role by doing the following:
 - a. In the **Permissions policies** pane, choose **Add permissions** and select **Create inline policy**.

- b. In **Policy editor**, select **JSON**.
- c. Paste the policy you want to add into the editor (replacing the existing JSON), and then choose **Next**.
- d. Under **Policy details**, enter a **Policy name**.
- e. Choose **Create policy**.

AWS CLI

To add a permissions policy to a function's execution role (CLI)

1. Create a JSON policy document with the required permissions and save it in a local directory.
2. Use the IAM `put-role-policy` CLI command to add the permissions to your function's execution role. Run the following command from the directory you saved your JSON policy document in and replace the role name, policy name, and policy document with your own values.

```
aws iam put-role-policy \  
--role-name my_lambda_role \  
--policy-name LambdaS3DestinationPolicy \  
--policy-document file://my_policy.json
```

SNS and SQS example invocation record

The following example shows what Lambda sends to an SNS topic or SQS queue destination for a failed Kafka event source invocation. Each of the keys under `recordsInfo` contains both the Kafka topic and partition, separated by a hyphen. For example, for the key `"Topic-0"`, `Topic` is the Kafka topic, and `0` is the partition. For each topic and partition, you can use the offsets and timestamp data to find the original invocation records.

```
{  
  "requestContext": {  
    "requestId": "316aa6d0-8154-xmpl-9af7-85d5f4a6bc81",  
    "functionArn": "arn:aws:lambda:us-east-1:123456789012:function:myfunction",  
    "condition": "RetryAttemptsExhausted" | "MaximumPayloadSizeExceeded",  
    "approximateInvokeCount": 1  
  },  
  "responseContext": { // null if record is MaximumPayloadSizeExceeded
```

```

        "statusCode": 200,
        "executedVersion": "$LATEST",
        "functionError": "Unhandled"
    },
    "version": "1.0",
    "timestamp": "2019-11-14T00:38:06.021Z",
    "KafkaBatchInfo": {
        "batchSize": 500,
        "eventSourceArn": "arn:aws:kafka:us-east-1:123456789012:cluster/
vpc-2priv-2pub/751d2973-a626-431c-9d4e-d7975eb44dd7-2",
        "bootstrapServers": "...",
        "payloadSize": 2039086, // In bytes
        "recordsInfo": {
            "Topic-0": {
                "firstRecordOffset":
"49601189658422359378836298521827638475320189012309704722",
                "lastRecordOffset":
"49601189658422359378836298522902373528957594348623495186",
                "firstRecordTimestamp": "2019-11-14T00:38:04.835Z",
                "lastRecordTimestamp": "2019-11-14T00:38:05.580Z",
            },
            "Topic-1": {
                "firstRecordOffset":
"49601189658422359378836298521827638475320189012309704722",
                "lastRecordOffset":
"49601189658422359378836298522902373528957594348623495186",
                "firstRecordTimestamp": "2019-11-14T00:38:04.835Z",
                "lastRecordTimestamp": "2019-11-14T00:38:05.580Z",
            }
        }
    }
}

```

S3 destination example invocation record

For S3 destinations, Lambda sends the entire invocation record along with the metadata to the destination. The following example shows that Lambda sends to an S3 bucket destination for a failed Kafka event source invocation. In addition to all of the fields from the previous example for SQS and SNS destinations, the `payload` field contains the original invocation record as an escaped JSON string.

```

{
    "requestContext": {

```

```

    "requestId": "316aa6d0-8154-xmpl-9af7-85d5f4a6bc81",
    "functionArn": "arn:aws:lambda:us-east-1:123456789012:function:myfunction",
    "condition": "RetryAttemptsExhausted" | "MaximumPayloadSizeExceeded",
    "approximateInvokeCount": 1
  },
  "responseContext": { // null if record is MaximumPayloadSizeExceeded
    "statusCode": 200,
    "executedVersion": "$LATEST",
    "functionError": "Unhandled"
  },
  "version": "1.0",
  "timestamp": "2019-11-14T00:38:06.021Z",
  "KafkaBatchInfo": {
    "batchSize": 500,
    "eventSourceArn": "arn:aws:kafka:us-east-1:123456789012:cluster/
vpc-2priv-2pub/751d2973-a626-431c-9d4e-d7975eb44dd7-2",
    "bootstrapServers": "...",
    "payloadSize": 2039086, // In bytes
    "recordsInfo": {
      "Topic-0": {
        "firstRecordOffset":
"49601189658422359378836298521827638475320189012309704722",
        "lastRecordOffset":
"49601189658422359378836298522902373528957594348623495186",
        "firstRecordTimestamp": "2019-11-14T00:38:04.835Z",
        "lastRecordTimestamp": "2019-11-14T00:38:05.580Z",
      },
      "Topic-1": {
        "firstRecordOffset":
"49601189658422359378836298521827638475320189012309704722",
        "lastRecordOffset":
"49601189658422359378836298522902373528957594348623495186",
        "firstRecordTimestamp": "2019-11-14T00:38:04.835Z",
        "lastRecordTimestamp": "2019-11-14T00:38:05.580Z",
      }
    }
  },
  "payload": "<Whole Event>" // Only available in S3
}

```

Tip

We recommend enabling S3 versioning on your destination bucket.

Tutorial: Using an Amazon MSK event source mapping to invoke a Lambda function

In this tutorial, you will perform the following:

- Create a Lambda function in the same AWS account as an existing Amazon MSK cluster.
- Configure networking and authentication for Lambda to communicate with Amazon MSK.
- Set up a Lambda Amazon MSK event source mapping, which runs your Lambda function when events show up in the topic.

After you are finished with these steps, when events are sent to Amazon MSK, you will be able to set up a Lambda function to process those events automatically with your own custom Lambda code.

What can you do with this feature?

Example solution: Use an MSK event source mapping to deliver live scores to your customers.

Consider the following scenario: Your company hosts a web application where your customers can view information about live events, such as sports games. Information updates from the game are provided to your team through a Kafka topic on Amazon MSK. You want to design a solution that consumes updates from the MSK topic to provide an updated view of the live event to customers inside an application you develop. You have decided on the following design approach: Your client applications will communicate with a serverless backend hosted in AWS. Clients will connect over websocket sessions using the Amazon API Gateway WebSocket API.

In this solution, you need a component that reads MSK events, performs some custom logic to prepare those events for the application layer and then forwards that information to the API Gateway API. You can implement this component with AWS Lambda, by providing your custom logic in a Lambda function, then calling it with a AWS Lambda Amazon MSK event source mapping.

For more information about implementing solutions using the Amazon API Gateway WebSocket API, see [WebSocket API tutorials](#) in the API Gateway documentation.

Prerequisites

An AWS account with the following preconfigured resources:

To fulfill these prerequisites, we recommend following [Getting started using Amazon MSK in the Amazon MSK documentation](#).

- An Amazon MSK cluster. See [Create an Amazon MSK cluster](#) in *Getting started using Amazon MSK*.
- The following configuration:
 - Ensure **IAM role-based authentication** is **Enabled** in your cluster security settings. This improves your security by limiting your Lambda function to only access the Amazon MSK resources needed. This is enabled by default on new Amazon MSK clusters.
 - Ensure **Public access** is off in your cluster networking settings. Restricting your Amazon MSK cluster's access to the internet improves your security by limiting how many intermediaries handle your data. This is enabled by default on new Amazon MSK clusters.
- A Kafka topic in your Amazon MSK cluster to use for this solution. See [Create a topic](#) in *Getting started using Amazon MSK*.
- A Kafka admin host set up to retrieve information from your Kafka cluster and send Kafka events to your topic for testing, such as an Amazon EC2 instance with the Kafka admin CLI and Amazon MSK IAM library installed. See [Create a client machine](#) in *Getting started using Amazon MSK*.

Once you have set up these resources, gather the following information from your AWS account to confirm that you are ready to continue.

- The name of your Amazon MSK cluster. You can find this information in the Amazon MSK console.
- The cluster UUID, part of the ARN for your Amazon MSK cluster, which you can find in the Amazon MSK console. Follow the procedures in [Listing clusters](#) in the Amazon MSK documentation to find this information.
- The security groups associated with your Amazon MSK cluster. You can find this information in the Amazon MSK console. In the following steps, refer to these as your *clusterSecurityGroups*.
- The id of the Amazon VPC containing your Amazon MSK cluster. You can find this information by identifying subnets associated with your Amazon MSK cluster in the Amazon MSK console, then identifying the Amazon VPC associated with the subnet in the Amazon VPC Console.

- The name of the Kafka topic used in your solution. You can find this information by calling your Amazon MSK cluster with the `Kafka topics` CLI from your Kafka admin host. For more information about the `topics` CLI, see [Adding and removing topics](#) in the Kafka documentation.
- The name of a consumer group for your Kafka topic, suitable for use by your Lambda function. This group can be created automatically by Lambda, so you don't need to create it with the Kafka CLI. If you do need to manage your consumer groups, to learn more about the `consumer-groups` CLI, see [Managing Consumer Groups](#) in the Kafka documentation.

The following permissions in your AWS account:

- Permission to create and manage a Lambda function.
- Permission to create IAM policies and associate them with your Lambda function.
- Permission to create Amazon VPC endpoints and alter networking configuration in the Amazon VPC hosting your Amazon MSK cluster.

Configure network connectivity for Lambda to communicate with Amazon MSK

Use AWS PrivateLink to connect Lambda and Amazon MSK. You can do so by creating interface Amazon VPC endpoints in the Amazon VPC console. For more information about networking configuration, see [the section called "Configure network security"](#).

When a Amazon MSK event source mapping runs on the behalf of a Lambda function, it assumes the Lambda function's execution role. This IAM role authorizes the mapping to access resources secured by IAM, such as your Amazon MSK cluster. Although the components share an execution role, the Amazon MSK mapping and your Lambda function have separate connectivity requirements for their respective tasks, as shown in the following diagram.

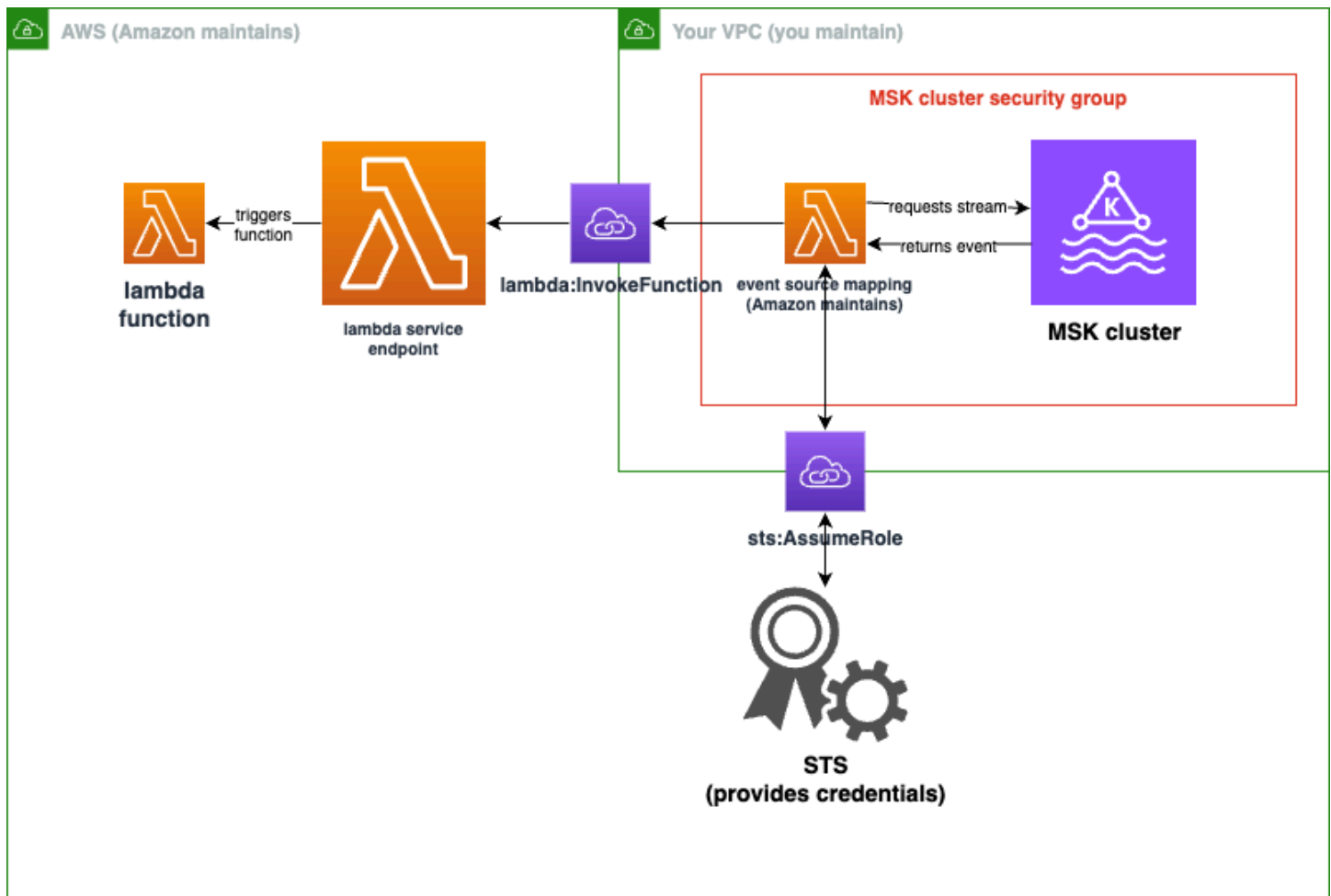

Your event source mapping belongs to your Amazon MSK cluster security group. In this networking step, create Amazon VPC endpoints from your Amazon MSK cluster VPC to connect the event source mapping to the Lambda and STS services. Secure these endpoints to accept traffic from your Amazon MSK cluster security group. Then, adjust the Amazon MSK cluster security groups to allow the event source mapping to communicate with the Amazon MSK cluster.

You can configure the following steps using the AWS Management Console.

To configure interface Amazon VPC endpoints to connect Lambda and Amazon MSK

1. Create a security group for your interface Amazon VPC endpoints, *endpointSecurityGroup*, that allows inbound TCP traffic on 443 from *clusterSecurityGroups*. Follow the procedure in [Create a security group](#) in the Amazon EC2 documentation to create a security group. Then, follow the procedure in [Add rules to a security group](#) in the Amazon EC2 documentation to add appropriate rules.

Create a security group with the following information:

When adding your inbound rules, create a rule for each security group in *clusterSecurityGroups*. For each rule:

- For **Type**, select **HTTPS**.
 - For **Source**, select one of *clusterSecurityGroups*.
2. Create an endpoint connecting the Lambda service to the Amazon VPC containing your Amazon MSK cluster. Follow the procedure in [Create an interface endpoint](#).

Create an interface endpoint with the following information:

- For **Service name**, select `com.amazonaws.regionName.lambda`, where *regionName* hosts your Lambda function.
- For **VPC**, select the Amazon VPC containing your Amazon MSK cluster.
- For **Security groups**, select *endpointSecurityGroup*, which you created earlier.
- For **Subnets**, select the subnets that host your Amazon MSK cluster.
- For **Policy**, provide the following policy document, which secures the endpoint for use by the Lambda service principal for the `lambda:InvokeFunction` action.

```
{
  "Statement": [
    {
      "Action": "lambda:InvokeFunction",
      "Effect": "Allow",
      "Principal": {
        "Service": [
          "lambda.amazonaws.com"
        ]
      },
      "Resource": "*"
    }
  ]
}
```

- Ensure **Enable DNS name** remains set.
3. Create an endpoint connecting the AWS STS service to the Amazon VPC containing your Amazon MSK cluster. Follow the procedure in [Create an interface endpoint](#).

Create an interface endpoint with the following information:

- For **Service name**, select AWS STS.
- For **VPC**, select the Amazon VPC containing your Amazon MSK cluster.
- For **Security groups**, select *endpointSecurityGroup*.
- For **Subnets**, select the subnets that host your Amazon MSK cluster.
- For **Policy**, provide the following policy document, which secures the endpoint for use by the Lambda service principal for the `sts:AssumeRole` action.

```
{
  "Statement": [
    {
      "Action": "sts:AssumeRole",
      "Effect": "Allow",
      "Principal": {
        "Service": [
          "lambda.amazonaws.com"
        ]
      },
      "Resource": "*"
    }
  ]
}
```

- Ensure **Enable DNS name** remains set.
4. For each security group associated with your Amazon MSK cluster, that is, in *clusterSecurityGroups*, allow the following:
- Allow all inbound and outbound TCP traffic on 9098 to all of *clusterSecurityGroups*, including within itself.
 - Allow all outbound TCP traffic on 443.

Some of this traffic is allowed by default security group rules, so if your cluster is attached to a single security group, and that group has default rules, additional rules are not necessary. To adjust security group rules, follow the procedures in [Add rules to a security group](#) in the Amazon EC2 documentation.

Add rules to your security groups with the following information:

- For each inbound rule or outbound rule for port 9098, provide

- For **Type**, select **Custom TCP**.
- For **Port range**, provide 9098.
- For **Source**, provide one of *clusterSecurityGroups*.
- For each inbound rule for port 443, for **Type**, select **HTTPS**.

Create an IAM role for Lambda to read from your Amazon MSK topic

Identify the auth requirements for Lambda to read from your Amazon MSK topic, then define them in a policy. Create a role, *lambdaAuthRole*, that authorizes Lambda to use those permissions. Authorize actions on your Amazon MSK cluster using `kafka-cluster` IAM actions. Then, authorize Lambda to perform Amazon MSK `kafka` and Amazon EC2 actions needed to discover and connect to your Amazon MSK cluster, as well as CloudWatch actions so Lambda can log what it has done.

To describe the auth requirements for Lambda to read from Amazon MSK

1. Write an IAM policy document (a JSON document), *clusterAuthPolicy*, that allows Lambda to read from your Kafka topic in your Amazon MSK cluster using your Kafka consumer group. Lambda requires a Kafka consumer group to be set when reading.

Alter the following template to align with your prerequisites:

```
{
  "Version": "2012-10-17",
  "Statement": [
    {
      "Effect": "Allow",
      "Action": [
        "kafka-cluster:Connect",
        "kafka-cluster:DescribeGroup",
        "kafka-cluster:AlterGroup",
        "kafka-cluster:DescribeTopic",
        "kafka-cluster:ReadData",
        "kafka-cluster:DescribeClusterDynamicConfiguration"
      ],
      "Resource": [
        "arn:aws:kafka:region:account-id:cluster/mskClusterName/cluster-  
uuid",
        "arn:aws:kafka:region:account-id:topic/mskClusterName/cluster-  
uuid/mskTopicName",
```

```
        "arn:aws:kafka:region:account-id:group/mskClusterName/cluster-uuid/mskGroupName"
    ]
}
]
```

For more information, consult [the section called "IAM role-based authentication"](#). When writing your policy:

- For *region* and *account-id*, provide those that host your Amazon MSK cluster.
 - For *mskClusterName*, provide the name of your Amazon MSK cluster.
 - For *cluster-uuid*, provide the UUID in the ARN for your Amazon MSK cluster.
 - For *mskTopicName*, provide the name of your Kafka topic.
 - For *mskGroupName*, provide the name of your Kafka consumer group.
2. Identify the Amazon MSK, Amazon EC2 and CloudWatch permissions required for Lambda to discover and connect your Amazon MSK cluster, and log those events.

The `AWSLambdaMSKExecutionRole` managed policy permissively defines the required permissions. Use it in the following steps.

In a production environment, assess `AWSLambdaMSKExecutionRole` to restrict your execution role policy based on the principle of least privilege, then write a policy for your role that replaces this managed policy.

For details about the IAM policy language, see the [IAM documentation](#).

Now that you have written your policy document, create an IAM policy so you can attach it to your role. You can do this using the console with the following procedure.

To create an IAM policy from your policy document

1. Sign in to the AWS Management Console and open the IAM console at <https://console.aws.amazon.com/iam/>.
2. In the navigation pane on the left, choose **Policies**.
3. Choose **Create policy**.
4. In the **Policy editor** section, choose the **JSON** option.

5. Paste *clusterAuthPolicy*.
6. When you are finished adding permissions to the policy, choose **Next**.
7. On the **Review and create** page, type a **Policy Name** and a **Description** (optional) for the policy that you are creating. Review **Permissions defined in this policy** to see the permissions that are granted by your policy.
8. Choose **Create policy** to save your new policy.

For more information, see [Creating IAM policies](#) in the IAM documentation.

Now that you have appropriate IAM policies, create a role and attach them to it. You can do this using the console with the following procedure.

To create an execution role in the IAM console

1. Open the [Roles page](#) in the IAM console.
2. Choose **Create role**.
3. Under **Trusted entity type**, choose **AWS service**.
4. Under **Use case**, choose **Lambda**.
5. Choose **Next**.
6. Select the following policies:
 - *clusterAuthPolicy*
 - `AWSLambdaMSKExecutionRole`
7. Choose **Next**.
8. For **Role name**, enter *lambdaAuthRole* and then choose **Create role**.

For more information, see [the section called "Execution role \(permissions for functions to access other resources\)"](#).

Create a Lambda function to read from your Amazon MSK topic

Create a Lambda function configured to use your IAM role. You can create your Lambda function using the console.

To create a Lambda function using your auth configuration

1. Open the Lambda console and select **Create function** from the header.
2. Select **Author from scratch**.
3. For **Function name**, provide an appropriate name of your choice.
4. For **Runtime**, choose the **Latest supported** version of Node . js to use the code provided in this tutorial.
5. Choose **Change default execution role**.
6. Select **Use an existing role**.
7. For **Existing role**, select *LambdaAuthRole*.

In a production environment, you usually need to add further policies to the execution role for your Lambda function to meaningfully process your Amazon MSK events. For more information on adding policies to your role, see [Add or remove identity permissions](#) in the IAM documentation.

Create an event source mapping to your Lambda function

Your Amazon MSK event source mapping provides the Lambda service the information necessary to invoke your Lambda when appropriate Amazon MSK events occur. You can create a Amazon MSK mapping using the console. Create a Lambda trigger, then the event source mapping is automatically set up.

To create a Lambda trigger (and event source mapping)

1. Navigate to your Lambda function's overview page.
2. In the function overview section, choose **Add trigger** on the bottom left.
3. In the **Select a source** dropdown, select **Amazon MSK**.
4. Don't set **authentication**.
5. For **MSK cluster**, select your cluster's name.
6. For **Batch size**, enter 1. This step makes this feature easier to test, and is not an ideal value in production.
7. For **Topic name**, provide the name of your Kafka topic.
8. For **Consumer group ID**, provide the id of your Kafka consumer group.

Update your Lambda function to read your streaming data

Lambda provides information about Kafka events through the event method parameter. For an example structure of a Amazon MSK event, see [the section called " Example event"](#). After you understand how to interpret Lambda forwarded Amazon MSK events, you can alter your Lambda function code to use the information they provide.

Provide the following code to your Lambda function to log the contents of a Lambda Amazon MSK event for testing purposes:

.NET

AWS SDK for .NET

Note

There's more on GitHub. Find the complete example and learn how to set up and run in the [Serverless examples](#) repository.

Consuming an Amazon MSK event with Lambda using .NET.

```
using System.Text;
using Amazon.Lambda.Core;
using Amazon.Lambda.KafkaEvents;

// Assembly attribute to enable the Lambda function's JSON input to be converted
// into a .NET class.
[assembly:
    LambdaSerializer(typeof(Amazon.Lambda.Serialization.SystemTextJson.DefaultLambdaJsonSer

namespace MSKLambda;

public class Function
{

    /// <param name="input">The event for the Lambda function handler to
    process.</param>
    /// <param name="context">The ILambdaContext that provides methods for
    logging and describing the Lambda environment.</param>
```

```
/// <returns></returns>
public void FunctionHandler(KafkaEvent evnt, ILambdaContext context)
{
    foreach (var record in evnt.Records)
    {
        Console.WriteLine("Key:" + record.Key);
        foreach (var eventRecord in record.Value)
        {
            var valueBytes = eventRecord.Value.ToArray();
            var valueText = Encoding.UTF8.GetString(valueBytes);

            Console.WriteLine("Message:" + valueText);
        }
    }
}
}
```

Go

SDK for Go V2

Note

There's more on GitHub. Find the complete example and learn how to set up and run in the [Serverless examples](#) repository.

Consuming an Amazon MSK event with Lambda using Go.

```
package main

import (
    "encoding/base64"
    "fmt"

    "github.com/aws/aws-lambda-go/events"
    "github.com/aws/aws-lambda-go/lambda"
)
```

```
)

func handler(event events.KafkaEvent) {
    for key, records := range event.Records {
        fmt.Println("Key:", key)

        for _, record := range records {
            fmt.Println("Record:", record)

            decodedValue, _ := base64.StdEncoding.DecodeString(record.Value)
            message := string(decodedValue)
            fmt.Println("Message:", message)
        }
    }
}

func main() {
    lambda.Start(handler)
}
```

Java

SDK for Java 2.x

Note

There's more on GitHub. Find the complete example and learn how to set up and run in the [Serverless examples](#) repository.

Consuming an Amazon MSK event with Lambda using Java.

```
import com.amazonaws.services.lambda.runtime.Context;
import com.amazonaws.services.lambda.runtime.RequestHandler;
import com.amazonaws.services.lambda.runtime.events.KafkaEvent;
import com.amazonaws.services.lambda.runtime.events.KafkaEvent.KafkaEventRecord;

import java.util.Base64;
import java.util.Map;

public class Example implements RequestHandler<KafkaEvent, Void> {
```

```
@Override
public void handleRequest(KafkaEvent event, Context context) {
    for (Map.Entry<String, java.util.List<KafkaEventRecord>> entry :
event.getRecords().entrySet()) {
        String key = entry.getKey();
        System.out.println("Key: " + key);

        for (KafkaEventRecord record : entry.getValue()) {
            System.out.println("Record: " + record);

            byte[] value = Base64.getDecoder().decode(record.getValue());
            String message = new String(value);
            System.out.println("Message: " + message);
        }
    }

    return null;
}
}
```

JavaScript

SDK for JavaScript (v3)

Note

There's more on GitHub. Find the complete example and learn how to set up and run in the [Serverless examples](#) repository.

Consuming an Amazon MSK event with Lambda using JavaScript.

```
exports.handler = async (event) => {
    // Iterate through keys
    for (let key in event.records) {
        console.log('Key: ', key)
        // Iterate through records
        event.records[key].map((record) => {
            console.log('Record: ', record)
        })
    }
}
```

```
        // Decode base64
        const msg = Buffer.from(record.value, 'base64').toString()
        console.log('Message:', msg)
    })
}
}
```

PHP

SDK for PHP

Note

There's more on GitHub. Find the complete example and learn how to set up and run in the [Serverless examples](#) repository.

Consuming an Amazon MSK event with Lambda using PHP.

```
<?php
// Copyright Amazon.com, Inc. or its affiliates. All Rights Reserved.
// SPDX-License-Identifier: Apache-2.0

// using bref/bref and bref/logger for simplicity

use Bref\Context\Context;
use Bref\Event\Kafka\KafkaEvent;
use Bref\Event\Handler as StdHandler;
use Bref\Logger\StderrLogger;

require __DIR__ . '/vendor/autoload.php';

class Handler implements StdHandler
{
    private StderrLogger $logger;
    public function __construct(StderrLogger $logger)
    {
        $this->logger = $logger;
    }

    /**
     * @throws JsonException
     */
}
```

```
* @throws \Bref\Event\InvalidLambdaEvent
*/
public function handle(mixed $event, Context $context): void
{
    $kafkaEvent = new KafkaEvent($event);
    $this->logger->info("Processing records");
    $records = $kafkaEvent->getRecords();

    foreach ($records as $record) {
        try {
            $key = $record->getKey();
            $this->logger->info("Key: $key");

            $values = $record->getValue();
            $this->logger->info(json_encode($values));

            foreach ($values as $value) {
                $this->logger->info("Value: $value");
            }

        } catch (Exception $e) {
            $this->logger->error($e->getMessage());
        }
    }
    $totalRecords = count($records);
    $this->logger->info("Successfully processed $totalRecords records");
}

$logger = new StderrLogger();
return new Handler($logger);
```

Python

SDK for Python (Boto3)

Note

There's more on GitHub. Find the complete example and learn how to set up and run in the [Serverless examples](#) repository.

Consuming an Amazon MSK event with Lambda using Python.

```
import base64

def lambda_handler(event, context):
    # Iterate through keys
    for key in event['records']:
        print('Key:', key)
        # Iterate through records
        for record in event['records'][key]:
            print('Record:', record)
            # Decode base64
            msg = base64.b64decode(record['value']).decode('utf-8')
            print('Message:', msg)
```

Ruby

SDK for Ruby

Note

There's more on GitHub. Find the complete example and learn how to set up and run in the [Serverless examples](#) repository.

Consuming an Amazon MSK event with Lambda using Ruby.

```
require 'base64'

def lambda_handler(event:, context:)
    # Iterate through keys
    event['records'].each do |key, records|
        puts "Key: #{key}"

        # Iterate through records
        records.each do |record|
            puts "Record: #{record}"

            # Decode base64
```



```
    msg = Base64.decode64(record['value'])
    puts "Message: #{msg}"
  end
end
end
```

Rust

SDK for Rust

Note

There's more on GitHub. Find the complete example and learn how to set up and run in the [Serverless examples](#) repository.

Consuming an Amazon MSK event with Lambda using Rust.

```
use aws_lambda_events::event::kafka::KafkaEvent;
use lambda_runtime::{run, service_fn, tracing, Error, LambdaEvent};
use base64::prelude::*;
use serde_json::{Value};
use tracing::{info};

/// Pre-Requisites:
/// 1. Install Cargo Lambda - see https://www.cargo-lambda.info/guide/getting-
started.html
/// 2. Add packages tracing, tracing-subscriber, serde_json, base64
///
/// This is the main body for the function.
/// Write your code inside it.
/// There are some code example in the following URLs:
/// - https://github.com/awslabs/aws-lambda-rust-runtime/tree/main/examples
/// - https://github.com/aws-samples/serverless-rust-demo/

async fn function_handler(event: LambdaEvent<KafkaEvent>) -> Result<Value, Error>
{

    let payload = event.payload.records;

    for (_name, records) in payload.iter() {
```

```
    for record in records {

        let record_text = record.value.as_ref().ok_or("Value is None"?);
        info!("Record: {}", &record_text);

        // perform Base64 decoding
        let record_bytes = BASE64_STANDARD.decode(record_text)?;
        let message = std::str::from_utf8(&record_bytes)?;

        info!("Message: {}", message);
    }

}

Ok(()).into()
}

#[tokio::main]
async fn main() -> Result<(), Error> {

    // required to enable CloudWatch error logging by the runtime
    tracing::init_default_subscriber();
    info!("Setup CW subscriber!");

    run(service_fn(function_handler)).await
}
```

You can provide function code to your Lambda using the console.

To update function code using the console code editor

1. Open the [Functions page](#) of the Lambda console and select your function.
2. Select the **Code** tab.
3. In the **Code source** pane, select your source code file and edit it in the integrated code editor.
4. In the **DEPLOY** section, choose **Deploy** to update your function's code:

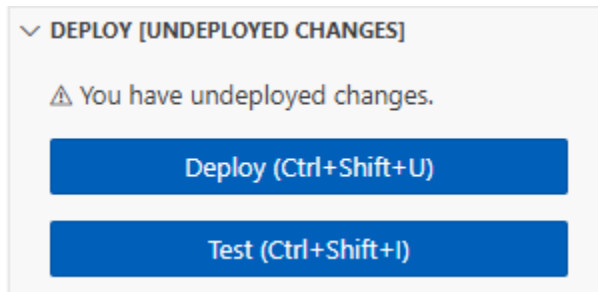

Test your Lambda function to verify it is connected to your Amazon MSK topic

You can now verify whether or not your Lambda is being invoked by the event source by inspecting CloudWatch event logs.

To verify whether your Lambda function is being invoked

1. Use your Kafka admin host to generate Kafka events using the `kafka-console-producer` CLI. For more information, see [Write some events into the topic](#) in the Kafka documentation. Send enough events to fill up the batch defined by batch size for your event source mapping defined in the previous step, or Lambda will wait for more information to invoke.
2. If your function runs, Lambda writes what happened to CloudWatch. In the console, navigate to your Lambda function's detail page.
3. Select the **Configuration** tab.
4. From the sidebar, select **Monitoring and operations tools**.
5. Identify the **CloudWatch log group** under **Logging configuration**. The log group should start with `/aws/lambda`. Choose the link to the log group.
6. In the CloudWatch console, inspect the **Log events** for the log events Lambda has sent to the log stream. Identify if there are log events containing the message from your Kafka event, as in the following image. If there are, you have successfully connected a Lambda function to Amazon MSK with a Lambda event source mapping.

2020-08-06T15:06:18.861-04:00	START RequestId: 88ebae59-be0c-4e22-9db7-4154b437e43a Version: \$LATEST
2020-08-06T15:06:18.866-04:00	2020-08-06T19:06:18.866Z 88ebae59-be0c-4e22-9db7-4154b437e43a INFO Key: mytopic-0
2020-08-06T15:06:18.866-04:00	2020-08-06T19:06:18.866Z 88ebae59-be0c-4e22-9db7-4154b437e43a INFO Record: { topic: 'mytopic', partition: 0, offset: 38, timestamp: 1596740777633, timestampType: 'CREATE_TIME', value: 'TwVzc2FnZSAjMQ==' }
2020-08-06T15:06:18.866-04:00	2020-08-06T19:06:18.866Z 88ebae59-be0c-4e22-9db7-4154b437e43a INFO Message: Message #1
2020-08-06T15:06:18.890-04:00	END RequestId: 88ebae59-be0c-4e22-9db7-4154b437e43a

Using AWS Lambda with Amazon RDS

You can connect a Lambda function to an Amazon Relational Database Service (Amazon RDS) database directly and through an Amazon RDS Proxy. Direct connections are useful in simple scenarios, and proxies are recommended for production. A database proxy manages a pool of shared database connections which enables your function to reach high concurrency levels without exhausting database connections.

We recommend using Amazon RDS Proxy for Lambda functions that make frequent short database connections, or open and close large numbers of database connections. For more information, see [Automatically connecting a Lambda function and a DB instance](#) in the Amazon Relational Database Service Developer Guide.

Tip

To quickly connect a Lambda function to an Amazon RDS database, you can use the in-console guided wizard. To open the wizard, do the following:

1. Open the [Functions page](#) of the Lambda console.
2. Select the function you want to connect a database to.
3. On the **Configuration** tab, select **RDS databases**.
4. Choose **Connect to RDS database**.

After you've connected your function to a database, you can create a proxy by choosing **Add proxy**.

Configuring your function to work with RDS resources

In the Lambda console, you can provision, and configure, Amazon RDS database instances and proxy resources. You can do this by navigating to **RDS databases** under the **Configuration** tab. Alternatively, you can also create and configure connections to Lambda functions in the Amazon RDS console. When configuring an RDS database instance to use with Lambda, note the following criteria:

- To connect to a database, your function must be in the same Amazon VPC where your database runs.

- You can use Amazon RDS databases with MySQL, MariaDB, PostgreSQL, or Microsoft SQL Server engines.
- You can also use Aurora DB clusters with MySQL or PostgreSQL engines.
- You need to provide a Secrets Manager secret for database authentication.
- An IAM role must provide permission to use the secret, and a trust policy must allow Amazon RDS to assume the role.
- The IAM principal that uses the console to configure the Amazon RDS resource, and connect it to your function must have the following permissions:

Note

You need the Amazon RDS Proxy permissions only if you configure an Amazon RDS Proxy to manage a pool of your database connections.

Example permission policy

```
{
  "Version": "2012-10-17",
  "Statement": [
    {
      "Effect": "Allow",
      "Action": [
        "ec2:CreateSecurityGroup",
        "ec2:DescribeSecurityGroups",
        "ec2:DescribeSubnets",
        "ec2:DescribeVpcs",
        "ec2:AuthorizeSecurityGroupIngress",
        "ec2:AuthorizeSecurityGroupEgress",
        "ec2:RevokeSecurityGroupEgress",
        "ec2:CreateNetworkInterface",
        "ec2>DeleteNetworkInterface",
        "ec2:DescribeNetworkInterfaces"
      ],
      "Resource": "*"
    },
    {
      "Effect": "Allow",
      "Action": [
        "rds-db:connect",
```

```

        "rds:CreateDBProxy",
        "rds:CreateDBInstance",
        "rds:CreateDBSubnetGroup",
        "rds:DescribeDBClusters",
        "rds:DescribeDBInstances",
        "rds:DescribeDBSubnetGroups",
        "rds:DescribeDBProxies",
        "rds:DescribeDBProxyTargets",
        "rds:DescribeDBProxyTargetGroups",
        "rds:RegisterDBProxyTargets",
        "rds:ModifyDBInstance",
        "rds:ModifyDBProxy"
    ],
    "Resource": "*"
},
{
    "Effect": "Allow",
    "Action": [
        "lambda:CreateFunction",
        "lambda:ListFunctions",
        "lambda:UpdateFunctionConfiguration"
    ],
    "Resource": "*"
},
{
    "Effect": "Allow",
    "Action": [
        "iam:AttachRolePolicy",
        "iam:AttachPolicy",
        "iam:CreateRole",
        "iam:CreatePolicy"
    ],
    "Resource": "*"
},
{
    "Effect": "Allow",
    "Action": [
        "secretsmanager:GetResourcePolicy",
        "secretsmanager:GetSecretValue",
        "secretsmanager:DescribeSecret",
        "secretsmanager:ListSecretVersionIds",
        "secretsmanager:CreateSecret"
    ],
    "Resource": "*"
}

```

```
}  
]  
}
```

Amazon RDS charges an hourly rate for proxies based on the database instance size, see [RDS Proxy pricing](#) for details. For more information on proxy connections in general, see [Using Amazon RDS Proxy](#) in the Amazon RDS User Guide.

Lambda and Amazon RDS setup

Both Lambda and Amazon RDS consoles will assist you in automatically configuring some of the required resources to make a connection between Lambda and Amazon RDS.

Connecting to an Amazon RDS database in a Lambda function

The following code example shows how to implement a Lambda function that connects to an Amazon RDS database. The function makes a simple database request and returns the result.

.NET

AWS SDK for .NET

Note

There's more on GitHub. Find the complete example and learn how to set up and run in the [Serverless examples](#) repository.

Connecting to an Amazon RDS database in a Lambda function using .NET.

```
using System.Data;  
using System.Text.Json;  
using Amazon.Lambda.APIGatewayEvents;  
using Amazon.Lambda.Core;  
using MySql.Data.MySqlClient;  
  
// Assembly attribute to enable the Lambda function's JSON input to be converted  
// into a .NET class.
```



```

[assembly:
    LambdaSerializer(typeof(Amazon.Lambda.Serialization.SystemTextJson.DefaultLambdaJsonSerializer))]

namespace aws_rds;

public class InputModel
{
    public string key1 { get; set; }
    public string key2 { get; set; }
}

public class Function
{
    /// <summary>
    /// Handles the Lambda function execution for connecting to RDS using IAM
    authentication.
    /// </summary>
    /// <param name="input">The input event data passed to the Lambda function</
    param>
    /// <param name="context">The Lambda execution context that provides runtime
    information</param>
    /// <returns>A response object containing the execution result</returns>

    public async Task<APIGatewayProxyResponse>
    FunctionHandler(APIGatewayProxyRequest request, ILambdaContext context)
    {
        // Sample Input: {"body": "{\"key1\": \"20\", \"key2\": \"25\"}"}
        var input = JsonSerializer.Deserialize<InputModel>(request.Body);

        /// Obtain authentication token
        var authToken = RDSAuthTokenGenerator.GenerateAuthToken(
            Environment.GetEnvironmentVariable("RDS_ENDPOINT"),
            Convert.ToInt32(Environment.GetEnvironmentVariable("RDS_PORT")),
            Environment.GetEnvironmentVariable("RDS_USERNAME")
        );

        /// Build the Connection String with the Token
        string connectionString =
        $"Server={Environment.GetEnvironmentVariable("RDS_ENDPOINT")};" +

        $"Port={Environment.GetEnvironmentVariable("RDS_PORT")};" +

        $"Uid={Environment.GetEnvironmentVariable("RDS_USERNAME")};" +
        $"Pwd={authToken}";
    }
}

```

```
try
{
    await using var connection = new MySqlConnection(connectionString);
    await connection.OpenAsync();

    const string sql = "SELECT @param1 + @param2 AS Sum";

    await using var command = new MySqlCommand(sql, connection);
    command.Parameters.AddWithValue("@param1", int.Parse(input.key1 ??
"0"));
    command.Parameters.AddWithValue("@param2", int.Parse(input.key2 ??
"0"));

    await using var reader = await command.ExecuteReaderAsync();
    if (await reader.ReadAsync())
    {
        int result = reader.GetInt32("Sum");

        //Sample Response: {"statusCode":200,"body":{"message":"The
sum is: 45"},"isBase64Encoded":false}
        return new APIGatewayProxyResponse
        {
            StatusCode = 200,
            Body = JsonSerializer.Serialize(new { message = $"The sum is:
{result}" })
        };
    }

    catch (Exception ex)
    {
        Console.WriteLine($"Error: {ex.Message}");
    }

    return new APIGatewayProxyResponse
    {
        StatusCode = 500,
        Body = JsonSerializer.Serialize(new { error = "Internal server
error" })
    };
}
}
```

Go

SDK for Go V2

Note

There's more on GitHub. Find the complete example and learn how to set up and run in the [Serverless examples](#) repository.

Connecting to an Amazon RDS database in a Lambda function using Go.

```
/*
Golang v2 code here.
*/

package main

import (
    "context"
    "database/sql"
    "encoding/json"
    "fmt"
    "os"

    "github.com/aws/aws-lambda-go/lambda"
    "github.com/aws/aws-sdk-go-v2/config"
    "github.com/aws/aws-sdk-go-v2/feature/rds/auth"
    _ "github.com/go-sql-driver/mysql"
)

type MyEvent struct {
    Name string `json:"name"`
}

func HandleRequest(event *MyEvent) (map[string]interface{}, error) {

    var dbName string = os.Getenv("DatabaseName")
    var dbUser string = os.Getenv("DatabaseUser")
    var dbHost string = os.Getenv("DBHost") // Add hostname without https
```

```
var dbPort int = os.Getenv("Port") // Add port number
var dbEndpoint string = fmt.Sprintf("%s:%d", dbHost, dbPort)
var region string = os.Getenv("AWS_REGION")

cfg, err := config.LoadDefaultConfig(context.TODO())
if err != nil {
    panic("configuration error: " + err.Error())
}

authenticationToken, err := auth.BuildAuthToken(
    context.TODO(), dbEndpoint, region, dbUser, cfg.Credentials)
if err != nil {
    panic("failed to create authentication token: " + err.Error())
}

dsn := fmt.Sprintf("%s:%s@tcp(%s)/%s?tls=true&allowCleartextPasswords=true",
    dbUser, authenticationToken, dbEndpoint, dbName,
)

db, err := sql.Open("mysql", dsn)
if err != nil {
    panic(err)
}

defer db.Close()

var sum int
err = db.QueryRow("SELECT ?+? AS sum", 3, 2).Scan(&sum)
if err != nil {
    panic(err)
}
s := fmt.Sprint(sum)
message := fmt.Sprintf("The selected sum is: %s", s)

messageBytes, err := json.Marshal(message)
if err != nil {
    return nil, err
}

messageString := string(messageBytes)
return map[string]interface{}{
    "statusCode": 200,
    "headers":    map[string]string{"Content-Type": "application/json"},
    "body":      messageString,
```

```
    }, nil
  }

  func main() {
    lambda.Start(HandleRequest)
  }
}
```

Java

SDK for Java 2.x

Note

There's more on GitHub. Find the complete example and learn how to set up and run in the [Serverless examples](#) repository.

Connecting to an Amazon RDS database in a Lambda function using Java.

```
import com.amazonaws.services.lambda.runtime.Context;
import com.amazonaws.services.lambda.runtime.RequestHandler;
import com.amazonaws.services.lambda.runtime.events.APIGatewayProxyRequestEvent;
import com.amazonaws.services.lambda.runtime.events.APIGatewayProxyResponseEvent;
import software.amazon.awssdk.auth.credentials.DefaultCredentialsProvider;
import software.amazon.awssdk.regions.Region;
import software.amazon.awssdk.services.rdsdata.RdsDataClient;
import software.amazon.awssdk.services.rdsdata.model.ExecuteStatementRequest;
import software.amazon.awssdk.services.rdsdata.model.ExecuteStatementResponse;
import software.amazon.awssdk.services.rdsdata.model.Field;

import java.sql.Connection;
import java.sql.DriverManager;
import java.sql.PreparedStatement;
import java.sql.ResultSet;

public class RdsLambdaHandler implements
    RequestHandler<APIGatewayProxyRequestEvent, APIGatewayProxyResponseEvent> {

    @Override
    public APIGatewayProxyResponseEvent handleRequest(APIGatewayProxyRequestEvent
        event, Context context) {
```

```
APIGatewayProxyResponseEvent response = new
APIGatewayProxyResponseEvent();

    try {
        // Obtain auth token
        String token = createAuthToken();

        // Define connection configuration
        String connectionString = String.format("jdbc:mysql://%s:%s/%s?
useSSL=true&requireSSL=true",
            System.getenv("ProxyHostName"),
            System.getenv("Port"),
            System.getenv("DBName"));

        // Establish a connection to the database
        try (Connection connection =
DriverManager.getConnection(connectionString, System.getenv("DBUserName"),
token);
            PreparedStatement statement =
connection.prepareStatement("SELECT ? + ? AS sum")) {

            statement.setInt(1, 3);
            statement.setInt(2, 2);

            try (ResultSet resultSet = statement.executeQuery()) {
                if (resultSet.next()) {
                    int sum = resultSet.getInt("sum");
                    response.setStatusCode(200);
                    response.setBody("The selected sum is: " + sum);
                }
            }
        }

    } catch (Exception e) {
        response.setStatusCode(500);
        response.setBody("Error: " + e.getMessage());
    }

    return response;
}

private String createAuthToken() {
    // Create RDS Data Service client
    RdsDataClient rdsDataClient = RdsDataClient.builder()
```

```

        .region(Region.of(System.getenv("AWS_REGION")))
        .credentialsProvider(DefaultCredentialsProvider.create())
        .build();

    // Define authentication request
    ExecuteStatementRequest request = ExecuteStatementRequest.builder()
        .resourceArn(System.getenv("ProxyHostName"))
        .secretArn(System.getenv("DBUserName"))
        .database(System.getenv("DBName"))
        .sql("SELECT 'RDS IAM Authentication'")
        .build();

    // Execute request and obtain authentication token
    ExecuteStatementResponse response =
rdsDataClient.executeStatement(request);
    Field tokenField = response.records().get(0).get(0);

    return tokenField.stringValue();
}
}

```

JavaScript

SDK for JavaScript (v3)

Note

There's more on GitHub. Find the complete example and learn how to set up and run in the [Serverless examples](#) repository.

Connecting to an Amazon RDS database in a Lambda function using JavaScript.

```

// Copyright Amazon.com, Inc. or its affiliates. All Rights Reserved.
// SPDX-License-Identifier: Apache-2.0
/*
Node.js code here.
*/
// ES6+ example
import { Signer } from "@aws-sdk/rds-signer";
import mysql from 'mysql2/promise';

```

```
async function createAuthToken() {
  // Define connection authentication parameters
  const dbinfo = {

    hostname: process.env.ProxyHostName,
    port: process.env.Port,
    username: process.env.DBUserName,
    region: process.env.AWS_REGION,

  }

  // Create RDS Signer object
  const signer = new Signer(dbinfo);

  // Request authorization token from RDS, specifying the username
  const token = await signer.getAuthToken();
  return token;
}

async function dbOps() {

  // Obtain auth token
  const token = await createAuthToken();
  // Define connection configuration
  let connectionConfig = {
    host: process.env.ProxyHostName,
    user: process.env.DBUserName,
    password: token,
    database: process.env.DBName,
    ssl: 'Amazon RDS'
  }
  // Create the connection to the DB
  const conn = await mysql.createConnection(connectionConfig);
  // Obtain the result of the query
  const [res,] = await conn.execute('select ?+? as sum', [3, 2]);
  return res;
}

export const handler = async (event) => {
  // Execute database flow
  const result = await dbOps();
  // Return result
}
```



```
return {
  statusCode: 200,
  body: JSON.stringify("The selected sum is: " + result[0].sum)
}
};
```

Connecting to an Amazon RDS database in a Lambda function using TypeScript.

```
import { Signer } from "@aws-sdk/rds-signer";
import mysql from 'mysql2/promise';

// RDS settings
// Using '!' (non-null assertion operator) to tell the TypeScript compiler that
// the DB settings are not null or undefined,
const proxy_host_name = process.env.PROXY_HOST_NAME!
const port = parseInt(process.env.PORT!)
const db_name = process.env.DB_NAME!
const db_user_name = process.env.DB_USER_NAME!
const aws_region = process.env.AWS_REGION!

async function createAuthToken(): Promise<string> {

  // Create RDS Signer object
  const signer = new Signer({
    hostname: proxy_host_name,
    port: port,
    region: aws_region,
    username: db_user_name
  });

  // Request authorization token from RDS, specifying the username
  const token = await signer.getAuthToken();
  return token;
}

async function dbOps(): Promise<mysql.QueryResult | undefined> {
  try {
    // Obtain auth token
    const token = await createAuthToken();
    const conn = await mysql.createConnection({
```

```
        host: proxy_host_name,
        user: db_user_name,
        password: token,
        database: db_name,
        ssl: 'Amazon RDS' // Ensure you have the CA bundle for SSL connection
    });
    const [rows, fields] = await conn.execute('SELECT ? + ? AS sum', [3, 2]);
    console.log('result:', rows);
    return rows;
}
catch (err) {
    console.log(err);
}
}

export const lambdaHandler = async (event: any): Promise<{ statusCode: number;
body: string }> => {
    // Execute database flow
    const result = await dbOps();

    // Return error is result is undefined
    if (result == undefined)
        return {
            statusCode: 500,
            body: JSON.stringify(`Error with connection to DB host`)
        }

    // Return result
    return {
        statusCode: 200,
        body: JSON.stringify(`The selected sum is: ${result[0].sum}`)
    };
};
```

PHP

SDK for PHP

 **Note**

There's more on GitHub. Find the complete example and learn how to set up and run in the [Serverless examples](#) repository.

Connecting to an Amazon RDS database in a Lambda function using PHP.

```
<?php
# Copyright Amazon.com, Inc. or its affiliates. All Rights Reserved.
# SPDX-License-Identifier: Apache-2.0

# using bref/bref and bref/logger for simplicity

use Bref\Context\Context;
use Bref\Event\Handler as StdHandler;
use Bref\Logger\StderrLogger;
use Aws\Rds\AuthTokenGenerator;
use Aws\Credentials\CredentialProvider;

require __DIR__ . '/vendor/autoload.php';

class Handler implements StdHandler
{
    private StderrLogger $logger;
    public function __construct(StderrLogger $logger)
    {
        $this->logger = $logger;
    }

    private function getAuthToken(): string {
        // Define connection authentication parameters
        $dbConnection = [
            'hostname' => getenv('DB_HOSTNAME'),
            'port' => getenv('DB_PORT'),
            'username' => getenv('DB_USERNAME'),
            'region' => getenv('AWS_REGION'),
        ];
    }
}
```

```
    // Create RDS AuthTokenGenerator object
    $generator = new
AuthTokenGenerator(CredentialProvider::defaultProvider());

    // Request authorization token from RDS, specifying the username
    return $generator->createToken(
        $dbConnection['hostname'] . ':' . $dbConnection['port'],
        $dbConnection['region'],
        $dbConnection['username']
    );
}

private function getQueryResults() {
    // Obtain auth token
    $token = $this->getAuthToken();

    // Define connection configuration
    $connectionConfig = [
        'host' => getenv('DB_HOSTNAME'),
        'user' => getenv('DB_USERNAME'),
        'password' => $token,
        'database' => getenv('DB_NAME'),
    ];

    // Create the connection to the DB
    $conn = new PDO(
        "mysql:host={$connectionConfig['host']};dbname={$connectionConfig['database']}",
        $connectionConfig['user'],
        $connectionConfig['password'],
        [
            PDO::MYSQL_ATTR_SSL_CA => '/path/to/rds-ca-2019-root.pem',
            PDO::MYSQL_ATTR_SSL_VERIFY_SERVER_CERT => true,
        ]
    );

    // Obtain the result of the query
    $stmt = $conn->prepare('SELECT ?+? AS sum');
    $stmt->execute([3, 2]);

    return $stmt->fetch(PDO::FETCH_ASSOC);
}
```

```
/**
 * @param mixed $event
 * @param Context $context
 * @return array
 */
public function handle(mixed $event, Context $context): array
{
    $this->logger->info("Processing query");

    // Execute database flow
    $result = $this->getQueryResults();

    return [
        'sum' => $result['sum']
    ];
}

$logger = new StderrLogger();
return new Handler($logger);
```

Python

SDK for Python (Boto3)

Note

There's more on GitHub. Find the complete example and learn how to set up and run in the [Serverless examples](#) repository.

Connecting to an Amazon RDS database in a Lambda function using Python.

```
import json
import os
import boto3
import pymysql

# RDS settings
proxy_host_name = os.environ['PROXY_HOST_NAME']
port = int(os.environ['PORT'])
db_name = os.environ['DB_NAME']
```

```
db_user_name = os.environ['DB_USER_NAME']
aws_region = os.environ['AWS_REGION']

# Fetch RDS Auth Token
def get_auth_token():
    client = boto3.client('rds')
    token = client.generate_db_auth_token(
        DBHostname=proxy_host_name,
        Port=port
        DBUsername=db_user_name
        Region=aws_region
    )
    return token

def lambda_handler(event, context):
    token = get_auth_token()
    try:
        connection = pymysql.connect(
            host=proxy_host_name,
            user=db_user_name,
            password=token,
            db=db_name,
            port=port,
            ssl={'ca': 'Amazon RDS'} # Ensure you have the CA bundle for SSL
        )

        with connection.cursor() as cursor:
            cursor.execute('SELECT %s + %s AS sum', (3, 2))
            result = cursor.fetchone()

        return result

    except Exception as e:
        return (f"Error: {str(e)}") # Return an error message if an exception
    occurs
```

Ruby

SDK for Ruby

Note

There's more on GitHub. Find the complete example and learn how to set up and run in the [Serverless examples](#) repository.

Connecting to an Amazon RDS database in a Lambda function using Ruby.

```
# Ruby code here.

require 'aws-sdk-rds'
require 'json'
require 'mysql2'

def lambda_handler(event:, context:)
  endpoint = ENV['DBEndpoint'] # Add the endpoint without https"
  port = ENV['Port']           # 3306
  user = ENV['DBUser']
  region = ENV['DBRegion']     # 'us-east-1'
  db_name = ENV['DBName']

  credentials = Aws::Credentials.new(
    ENV['AWS_ACCESS_KEY_ID'],
    ENV['AWS_SECRET_ACCESS_KEY'],
    ENV['AWS_SESSION_TOKEN']
  )
  rds_client = Aws::RDS::AuthTokenGenerator.new(
    region: region,
    credentials: credentials
  )

  token = rds_client.auth_token(
    endpoint: endpoint+ ':' + port,
    user_name: user,
    region: region
  )

  begin
    conn = Mysql2::Client.new(
```

```

    host: endpoint,
    username: user,
    password: token,
    port: port,
    database: db_name,
    sslca: '/var/task/global-bundle.pem',
    sslverify: true,
    enableCleartextPlugin: true
  )
  a = 3
  b = 2
  result = conn.query("SELECT #{a} + #{b} AS sum").first['sum']
  puts result
  conn.close
  {
    statusCode: 200,
    body: result.to_json
  }
rescue => e
  puts "Database connection failed due to #{e}"
end
end

```

Rust

SDK for Rust

Note

There's more on GitHub. Find the complete example and learn how to set up and run in the [Serverless examples](#) repository.

Connecting to an Amazon RDS database in a Lambda function using Rust.

```

use aws_config::BehaviorVersion;
use aws_credential_types::provider::ProvideCredentials;
use aws_sig4::{
    http_request::{sign, SignableBody, SignableRequest, SigningSettings},
    sign::v4,
};
use lambda_runtime::{run, service_fn, Error, LambdaEvent};

```



```

use serde_json::{json, Value};
use sqlx::postgres::PgConnectOptions;
use std::env;
use std::time::{Duration, SystemTime};

const RDS_CERTS: &[u8] = include_bytes!("global-bundle.pem");

async fn generate_rds_iam_token(
    db_hostname: &str,
    port: u16,
    db_username: &str,
) -> Result<String, Error> {
    let config = aws_config::load_defaults(BehaviorVersion::v2024_03_28()).await;

    let credentials = config
        .credentials_provider()
        .expect("no credentials provider found")
        .provide_credentials()
        .await
        .expect("unable to load credentials");
    let identity = credentials.into();
    let region = config.region().unwrap().to_string();

    let mut signing_settings = SigningSettings::default();
    signing_settings.expires_in = Some(Duration::from_secs(900));
    signing_settings.signature_location =
aws_sigv4::http_request::SignatureLocation::QueryParams;

    let signing_params = v4::SigningParams::builder()
        .identity(&identity)
        .region(&region)
        .name("rds-db")
        .time(SystemTime::now())
        .settings(signing_settings)
        .build()?;

    let url = format!(
        "https://{db_hostname}:{port}/?Action=connect&DBUser={db_user}",
        db_hostname = db_hostname,
        port = port,
        db_user = db_username
    );

    let signable_request =

```

```

        SignableRequest::new("GET", &url, std::iter::empty(),
SignableBody::Bytes(&[]))
            .expect("signable request");

let (signing_instructions, _signature) =
    sign(signable_request, &signing_params.into())?.into_parts();

let mut url = url::Url::parse(&url).unwrap();
for (name, value) in signing_instructions.params() {
    url.query_pairs_mut().append_pair(name, &value);
}

let response = url.to_string().split_off("https://".len());

Ok(response)
}

#[tokio::main]
async fn main() -> Result<(), Error> {
    run(service_fn(handler)).await
}

async fn handler(_event: LambdaEvent<Value>) -> Result<Value, Error> {
    let db_host = env::var("DB_HOSTNAME").expect("DB_HOSTNAME must be set");
    let db_port = env::var("DB_PORT")
        .expect("DB_PORT must be set")
        .parse:::<u16>()
        .expect("PORT must be a valid number");
    let db_name = env::var("DB_NAME").expect("DB_NAME must be set");
    let db_user_name = env::var("DB_USERNAME").expect("DB_USERNAME must be set");

    let token = generate_rds_iam_token(&db_host, db_port, &db_user_name).await?;

    let opts = PgConnectOptions::new()
        .host(&db_host)
        .port(db_port)
        .username(&db_user_name)
        .password(&token)
        .database(&db_name)
        .ssl_root_cert_from_pem(RDS_CERTS.to_vec())
        .ssl_mode(sqlx::postgres::PgSslMode::Require);

    let pool = sqlx::postgres::PgPoolOptions::new()
        .connect_with(opts)

```

```

        .await?;

let result: i32 = sqlx::query_scalar("SELECT $1 + $2")
    .bind(3)
    .bind(2)
    .fetch_one(&pool)
    .await?;

println!("Result: {:?}", result);

Ok(json!({
    "statusCode": 200,
    "content-type": "text/plain",
    "body": format!("The selected sum is: {result}")
}))
}

```

Processing event notifications from Amazon RDS

You can use Lambda to process event notifications from an Amazon RDS database. Amazon RDS sends notifications to an Amazon Simple Notification Service (Amazon SNS) topic, which you can configure to invoke a Lambda function. Amazon SNS wraps the message from Amazon RDS in its own event document and sends it to your function.

For more information about configuring an Amazon RDS database to send notifications, see [Using Amazon RDS event notifications](#).

Example Amazon RDS message in an Amazon SNS event

```

{
  "Records": [
    {
      "EventVersion": "1.0",
      "EventSubscriptionArn": "arn:aws:sns:us-east-2:123456789012:rds-
lambda:21be56ed-a058-49f5-8c98-aedd2564c486",
      "EventSource": "aws:sns",
      "Sns": {
        "SignatureVersion": "1",
        "Timestamp": "2023-01-02T12:45:07.000Z",
        "Signature": "tcc6faL2yUC6dgZdmrwh1Y4cGa/ebXEkAi6RibDsvpi
+tE/1+82j...65r=="
      }
    }
  ]
}

```

```

        "SigningCertUrl": "https://sns.us-east-2.amazonaws.com/
SimpleNotificationService-ac565b8b1a6c5d002d285f9598aa1d9b.pem",
        "MessageId": "95df01b4-ee98-5cb9-9903-4c221d41eb5e",
        "Message": "{\"Event Source\":\"db-instance\", \"Event Time\":\"2023-01-02
12:45:06.000\", \"Identifier Link\":\"https://console.aws.amazon.com/rds/home?
region=eu-west-1#dbinstance:id=dbinstanceid\", \"Source ID\":\"dbinstanceid\", \"Event ID
\": \"http://docs.amazonwebservices.com/AmazonRDS/latest/UserGuide/USER_Events.html#RDS-
EVENT-0002\", \"Event Message\":\"Finished DB Instance backup\"}\",
        "MessageAttributes": {},
        "Type": "Notification",
        "UnsubscribeUrl": "https://sns.us-east-2.amazonaws.com/?
Action=Unsubscribe&SubscriptionArn=arn:aws:sns:us-east-2:123456789012:test-
lambda:21be56ed-a058-49f5-8c98-aedd2564c486",
        "TopicArn": "arn:aws:sns:us-east-2:123456789012:sns-lambda",
        "Subject": "RDS Notification Message"
    }
}
]
}

```

Complete Lambda and Amazon RDS tutorial

- [Using a Lambda function to access an Amazon RDS database](#) – From the Amazon RDS User Guide, learn how to use a Lambda function to write data to an Amazon RDS database through an Amazon RDS Proxy. Your Lambda function will read records from an Amazon SQS queue and write new items to a table in your database whenever a message is added.

Process Amazon S3 event notifications with Lambda

You can use Lambda to process [event notifications](#) from Amazon Simple Storage Service. Amazon S3 can send an event to a Lambda function when an object is created or deleted. You configure notification settings on a bucket, and grant Amazon S3 permission to invoke a function on the function's resource-based permissions policy.

Warning

If your Lambda function uses the same bucket that triggers it, it could cause the function to run in a loop. For example, if the bucket triggers a function each time an object is uploaded, and the function uploads an object to the bucket, then the function indirectly triggers itself. To avoid this, use two buckets, or configure the trigger to only apply to a prefix used for incoming objects.

Amazon S3 invokes your function [asynchronously](#) with an event that contains details about the object. The following example shows an event that Amazon S3 sent when a deployment package was uploaded to Amazon S3.

Example Amazon S3 notification event

```
{
  "Records": [
    {
      "eventVersion": "2.1",
      "eventSource": "aws:s3",
      "awsRegion": "us-east-2",
      "eventTime": "2019-09-03T19:37:27.192Z",
      "eventName": "ObjectCreated:Put",
      "userIdentity": {
        "principalId": "AWS:AIDAINPONIXQXHT3IKHL2"
      },
      "requestParameters": {
        "sourceIPAddress": "205.255.255.255"
      },
      "responseElements": {
        "x-amz-request-id": "D82B88E5F771F645",
        "x-amz-id-2":
"v1R7PnpV2Ce81l0PRw6jlUpck7Jo5ZsQjryTjK1c5aLWGVHPZLj5NeC6qMa0emYBDX0o6QBU0Wo="
      },
    }
  ]
}
```

```
"s3": {
  "s3SchemaVersion": "1.0",
  "configurationId": "828aa6fc-f7b5-4305-8584-487c791949c1",
  "bucket": {
    "name": "amzn-s3-demo-bucket",
    "ownerIdentity": {
      "principalId": "A3I5XTEXAMAI3E"
    },
    "arn": "arn:aws:s3:::lambda-artifacts-deafc19498e3f2df"
  },
  "object": {
    "key": "b21b84d653bb07b05b1e6b33684dc11b",
    "size": 1305107,
    "eTag": "b21b84d653bb07b05b1e6b33684dc11b",
    "sequencer": "0C0F6F405D6ED209E1"
  }
}
}
```

To invoke your function, Amazon S3 needs permission from the function's [resource-based policy](#). When you configure an Amazon S3 trigger in the Lambda console, the console modifies the resource-based policy to allow Amazon S3 to invoke the function if the bucket name and account ID match. If you configure the notification in Amazon S3, you use the Lambda API to update the policy. You can also use the Lambda API to grant permission to another account, or restrict permission to a designated alias.

If your function uses the AWS SDK to manage Amazon S3 resources, it also needs Amazon S3 permissions in its [execution role](#).

Topics

- [Tutorial: Using an Amazon S3 trigger to invoke a Lambda function](#)
- [Tutorial: Using an Amazon S3 trigger to create thumbnail images](#)

Tutorial: Using an Amazon S3 trigger to invoke a Lambda function

In this tutorial, you use the console to create a Lambda function and configure a trigger for an Amazon Simple Storage Service (Amazon S3) bucket. Every time that you add an object to your Amazon S3 bucket, your function runs and outputs the object type to Amazon CloudWatch Logs.

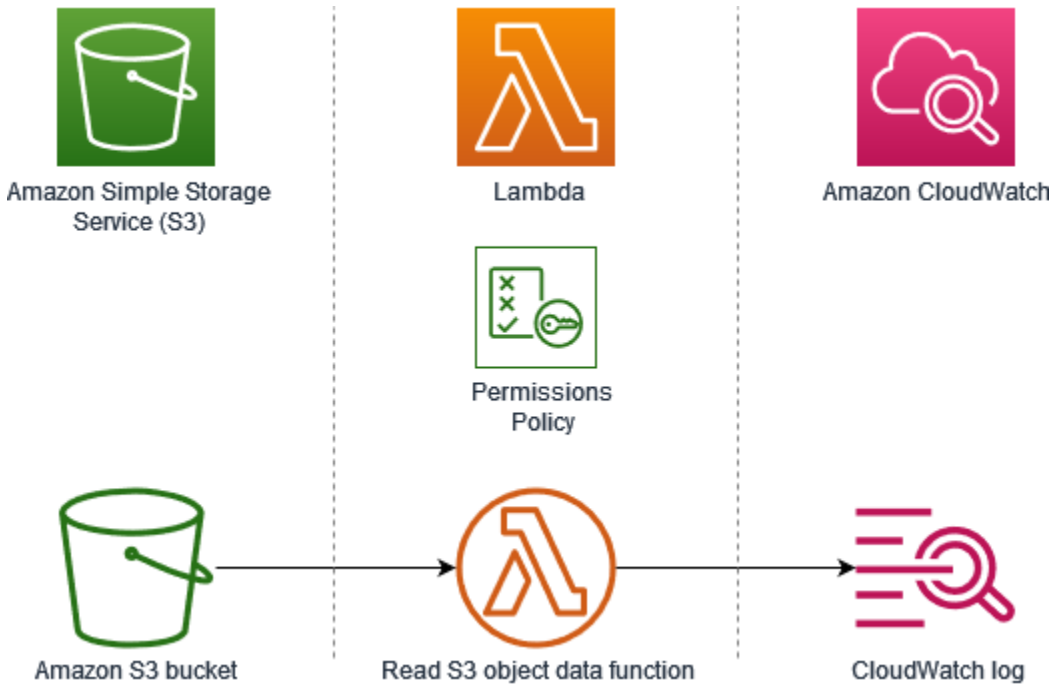

This tutorial demonstrates how to:

1. Create an Amazon S3 bucket.
2. Create a Lambda function that returns the object type of objects in an Amazon S3 bucket.
3. Configure a Lambda trigger that invokes your function when objects are uploaded to your bucket.
4. Test your function, first with a dummy event, and then using the trigger.

By completing these steps, you'll learn how to configure a Lambda function to run whenever objects are added to or deleted from an Amazon S3 bucket. You can complete this tutorial using only the AWS Management Console.

Prerequisites

Sign up for an AWS account

If you do not have an AWS account, complete the following steps to create one.

To sign up for an AWS account

1. Open <https://portal.aws.amazon.com/billing/signup>.
2. Follow the online instructions.

Part of the sign-up procedure involves receiving a phone call and entering a verification code on the phone keypad.

When you sign up for an AWS account, an *AWS account root user* is created. The root user has access to all AWS services and resources in the account. As a security best practice, assign administrative access to a user, and use only the root user to perform [tasks that require root user access](#).

AWS sends you a confirmation email after the sign-up process is complete. At any time, you can view your current account activity and manage your account by going to <https://aws.amazon.com/> and choosing **My Account**.

Create a user with administrative access

After you sign up for an AWS account, secure your AWS account root user, enable AWS IAM Identity Center, and create an administrative user so that you don't use the root user for everyday tasks.

Secure your AWS account root user

1. Sign in to the [AWS Management Console](#) as the account owner by choosing **Root user** and entering your AWS account email address. On the next page, enter your password.

For help signing in by using root user, see [Signing in as the root user](#) in the *AWS Sign-In User Guide*.

2. Turn on multi-factor authentication (MFA) for your root user.

For instructions, see [Enable a virtual MFA device for your AWS account root user \(console\)](#) in the *IAM User Guide*.

Create a user with administrative access

1. Enable IAM Identity Center.

For instructions, see [Enabling AWS IAM Identity Center](#) in the *AWS IAM Identity Center User Guide*.

2. In IAM Identity Center, grant administrative access to a user.

For a tutorial about using the IAM Identity Center directory as your identity source, see [Configure user access with the default IAM Identity Center directory](#) in the *AWS IAM Identity Center User Guide*.

Sign in as the user with administrative access

- To sign in with your IAM Identity Center user, use the sign-in URL that was sent to your email address when you created the IAM Identity Center user.

For help signing in using an IAM Identity Center user, see [Signing in to the AWS access portal](#) in the *AWS Sign-In User Guide*.

Assign access to additional users

- In IAM Identity Center, create a permission set that follows the best practice of applying least-privilege permissions.

For instructions, see [Create a permission set](#) in the *AWS IAM Identity Center User Guide*.

- Assign users to a group, and then assign single sign-on access to the group.

For instructions, see [Add groups](#) in the *AWS IAM Identity Center User Guide*.

Create an Amazon S3 bucket

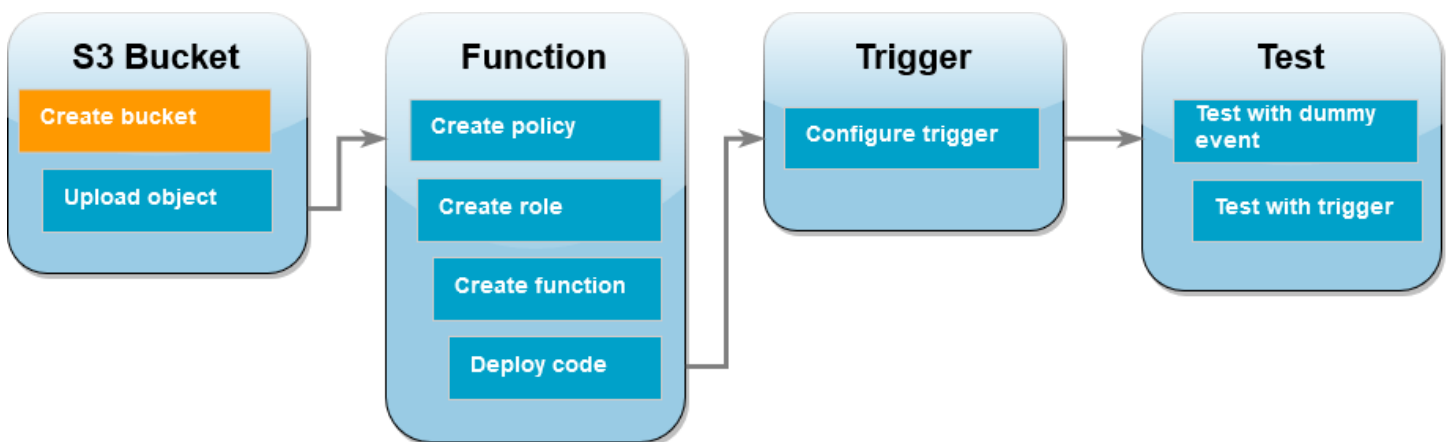

To create an Amazon S3 bucket

- Open the [Amazon S3 console](#) and select the **Buckets** page.

2. Choose **Create bucket**.
3. Under **General configuration**, do the following:
 - a. For **Bucket name**, enter a globally unique name that meets the Amazon S3 [Bucket naming rules](#). Bucket names can contain only lower case letters, numbers, dots (.), and hyphens (-).
 - b. For **AWS Region**, choose a Region. Later in the tutorial, you must create your Lambda function in the same Region.
4. Leave all other options set to their default values and choose **Create bucket**.

Upload a test object to your bucket

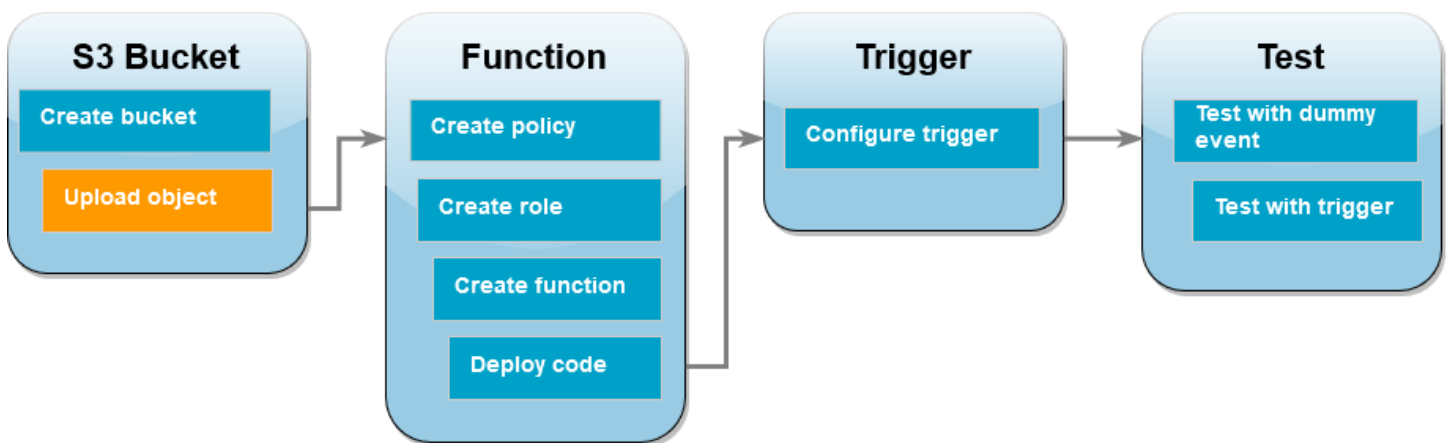

To upload a test object

1. Open the [Buckets](#) page of the Amazon S3 console and choose the bucket you created during the previous step.
2. Choose **Upload**.
3. Choose **Add files** and select the object that you want to upload. You can select any file (for example, HappyFace . jpg).
4. Choose **Open**, then choose **Upload**.

Later in the tutorial, you'll test your Lambda function using this object.

Create a permissions policy

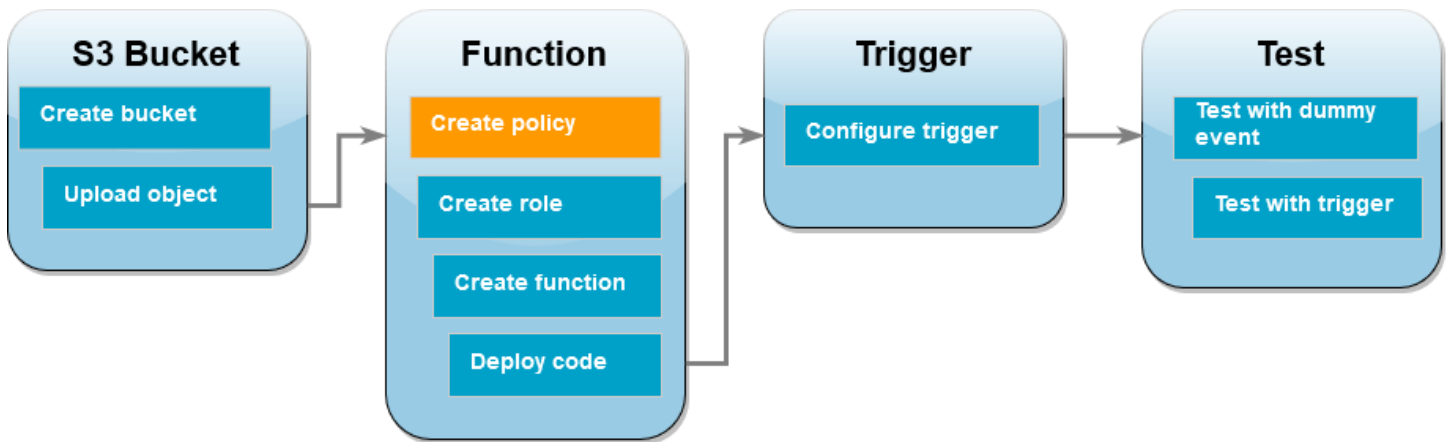

Create a permissions policy that allows Lambda to get objects from an Amazon S3 bucket and to write to Amazon CloudWatch Logs.

To create the policy

1. Open the [Policies page](#) of the IAM console.
2. Choose **Create Policy**.
3. Choose the **JSON** tab, and then paste the following custom policy into the JSON editor.

```

{
  "Version": "2012-10-17",
  "Statement": [
    {
      "Effect": "Allow",
      "Action": [
        "logs:PutLogEvents",
        "logs:CreateLogGroup",
        "logs:CreateLogStream"
      ],
      "Resource": "arn:aws:logs:*:*:*"
    },
    {
      "Effect": "Allow",
      "Action": [
        "s3:GetObject"
      ],
      "Resource": "arn:aws:s3::*/*"
    }
  ]
}

```

```
}

```

4. Choose **Next: Tags**.
5. Choose **Next: Review**.
6. Under **Review policy**, for the policy **Name**, enter **s3-trigger-tutorial**.
7. Choose **Create policy**.

Create an execution role

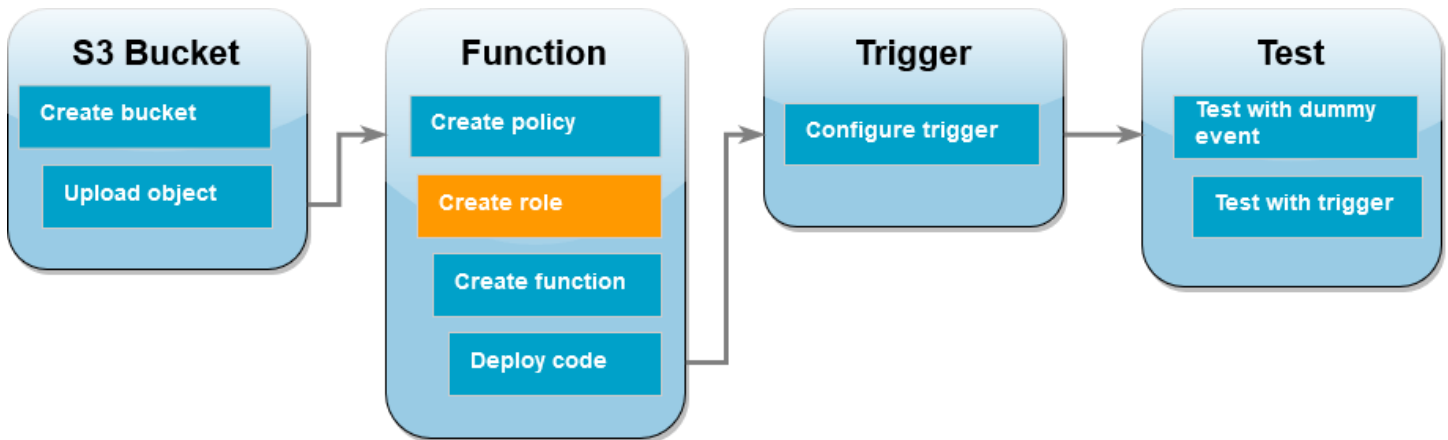

An [execution role](#) is an AWS Identity and Access Management (IAM) role that grants a Lambda function permission to access AWS services and resources. In this step, create an execution role using the permissions policy that you created in the previous step.

To create an execution role and attach your custom permissions policy

1. Open the [Roles page](#) of the IAM console.
2. Choose **Create role**.
3. For the type of trusted entity, choose **AWS service**, then for the use case, choose **Lambda**.
4. Choose **Next**.
5. In the policy search box, enter **s3-trigger-tutorial**.
6. In the search results, select the policy that you created (s3-trigger-tutorial), and then choose **Next**.
7. Under **Role details**, for the **Role name**, enter **lambda-s3-trigger-role**, then choose **Create role**.

Create the Lambda function

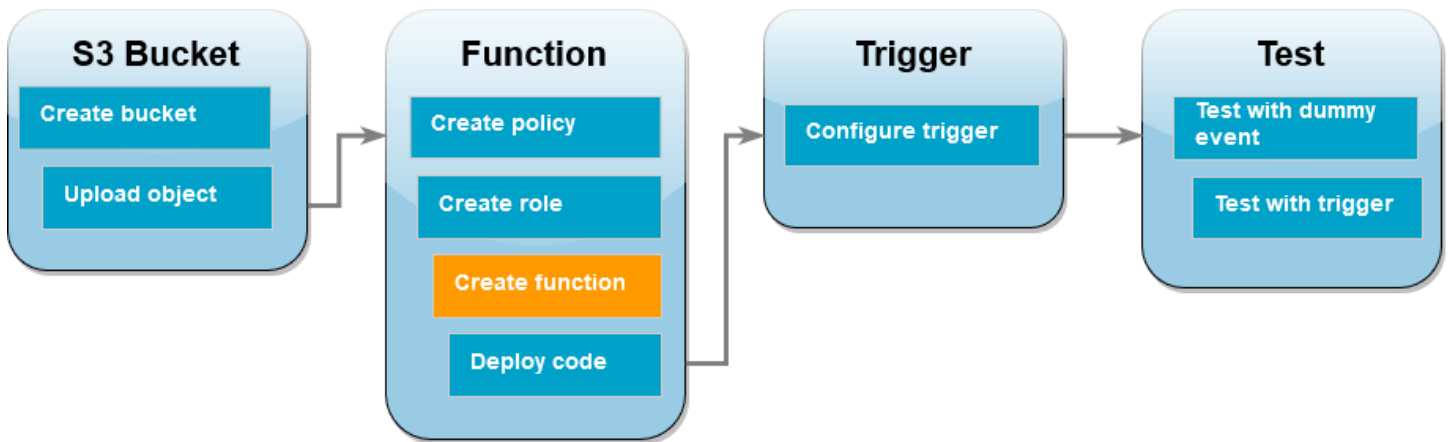

Create a Lambda function in the console using the Python 3.12 runtime.

To create the Lambda function

1. Open the [Functions](#) page of the Lambda console.
2. Make sure you're working in the same AWS Region you created your Amazon S3 bucket in. You can change your Region using the drop-down list at the top of the screen.

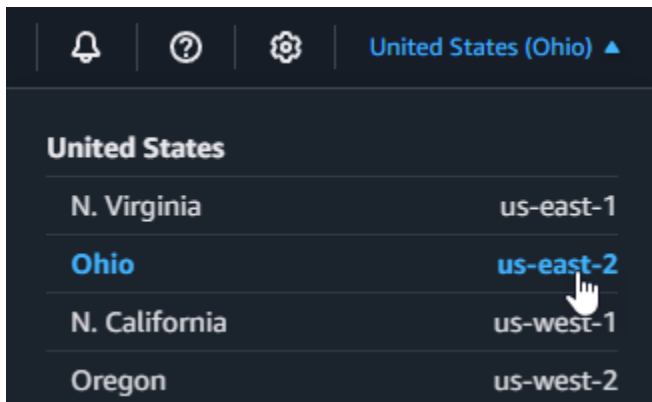

3. Choose **Create function**.
4. Choose **Author from scratch**
5. Under **Basic information**, do the following:
 - a. For **Function name**, enter `s3-trigger-tutorial`
 - b. For **Runtime**, choose **Python 3.12**.
 - c. For **Architecture**, choose **x86_64**.
6. In the **Change default execution role** tab, do the following:

- a. Expand the tab, then choose **Use an existing role**.
 - b. Select the `lambda-s3-trigger-role` you created earlier.
7. Choose **Create function**.

Deploy the function code

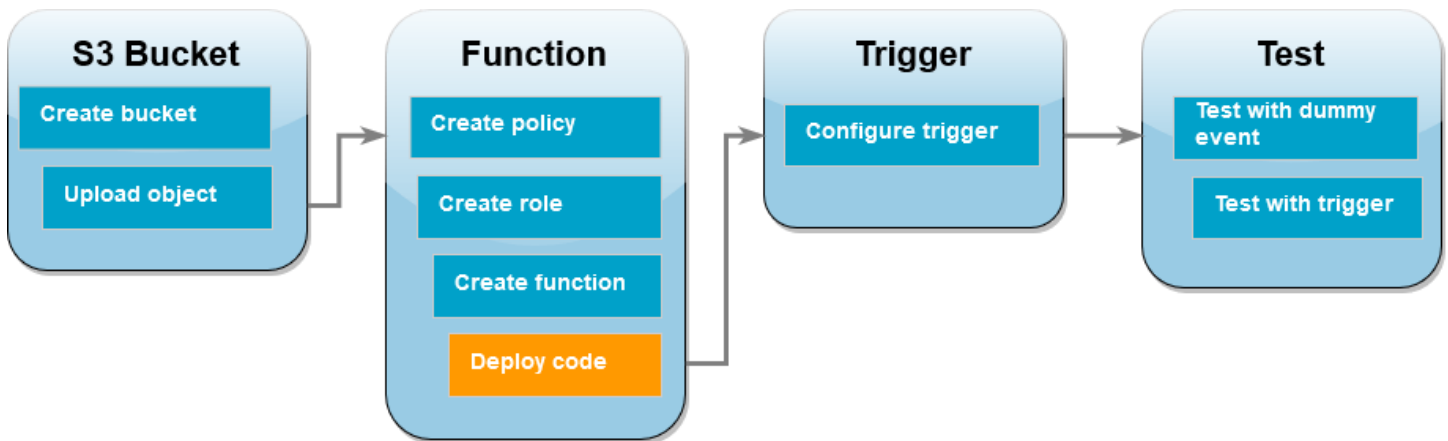

This tutorial uses the Python 3.12 runtime, but we've also provided example code files for other runtimes. You can select the tab in the following box to see the code for the runtime you're interested in.

The Lambda function retrieves the key name of the uploaded object and the name of the bucket from the event parameter it receives from Amazon S3. The function then uses the [get_object](#) method from the AWS SDK for Python (Boto3) to retrieve the object's metadata, including the content type (MIME type) of the uploaded object.

To deploy the function code

1. Choose the **Python** tab in the following box and copy the code.

.NET

AWS SDK for .NET

Note

There's more on GitHub. Find the complete example and learn how to set up and run in the [Serverless examples](#) repository.

Consuming an S3 event with Lambda using .NET.

```
// Copyright Amazon.com, Inc. or its affiliates. All Rights Reserved.
// SPDX-License-Identifier: Apache-2.0
using System.Threading.Tasks;
using Amazon.Lambda.Core;
using Amazon.S3;
using System;
using Amazon.Lambda.S3Events;
using System.Web;

// Assembly attribute to enable the Lambda function's JSON input to be
// converted into a .NET class.
[assembly: LambdaSerializer(typeof(Amazon.Lambda.Serialization.SystemTextJson.DefaultLambdaJsonSerializer))]

namespace S3Integration
{
    public class Function
    {
        private static AmazonS3Client _s3Client;
        public Function() : this(null)
        {
        }

        internal Function(AmazonS3Client s3Client)
        {
            _s3Client = s3Client ?? new AmazonS3Client();
        }

        public async Task<string> Handler(S3Event evt, ILambdaContext context)
        {
            try
            {
                if (evt.Records.Count <= 0)
                {
                    context.Logger.LogLine("Empty S3 Event received");
                    return string.Empty;
                }

                var bucket = evt.Records[0].S3.Bucket.Name;
            }
        }
    }
}
```

```
        var key =
            HttpUtility.UrlDecode(evt.Records[0].S3.Object.Key);

        context.Logger.LogLine($"Request is for {bucket} and {key}");

        var objectResult = await _s3Client.GetObjectAsync(bucket,
            key);

        context.Logger.LogLine($"Returning {objectResult.Key}");

        return objectResult.Key;
    }
    catch (Exception e)
    {
        context.Logger.LogLine($"Error processing request -
            {e.Message}");

        return string.Empty;
    }
}
}
```

Go

SDK for Go V2

Note

There's more on GitHub. Find the complete example and learn how to set up and run in the [Serverless examples](#) repository.

Consuming an S3 event with Lambda using Go.

```
// Copyright Amazon.com, Inc. or its affiliates. All Rights Reserved.
// SPDX-License-Identifier: Apache-2.0
package main

import (
    "context"
```



```
"log"

"github.com/aws/aws-lambda-go/events"
"github.com/aws/aws-lambda-go/lambda"
"github.com/aws/aws-sdk-go-v2/config"
"github.com/aws/aws-sdk-go-v2/service/s3"
)

func handler(ctx context.Context, s3Event events.S3Event) error {
    sdkConfig, err := config.LoadDefaultConfig(ctx)
    if err != nil {
        log.Printf("failed to load default config: %s", err)
        return err
    }
    s3Client := s3.NewFromConfig(sdkConfig)

    for _, record := range s3Event.Records {
        bucket := record.S3.Bucket.Name
        key := record.S3.Object.URLDecodedKey
        headOutput, err := s3Client.HeadObject(ctx, &s3.HeadObjectInput{
            Bucket: &bucket,
            Key:     &key,
        })
        if err != nil {
            log.Printf("error getting head of object %s/%s: %s", bucket, key, err)
            return err
        }
        log.Printf("successfully retrieved %s/%s of type %s", bucket, key,
            *headOutput.ContentType)
    }

    return nil
}

func main() {
    lambda.Start(handler)
}
```

Java

SDK for Java 2.x

Note

There's more on GitHub. Find the complete example and learn how to set up and run in the [Serverless examples](#) repository.

Consuming an S3 event with Lambda using Java.

```
// Copyright Amazon.com, Inc. or its affiliates. All Rights Reserved.
// SPDX-License-Identifier: Apache-2.0
package example;

import software.amazon.awssdk.services.s3.model.HeadObjectRequest;
import software.amazon.awssdk.services.s3.model.HeadObjectResponse;
import software.amazon.awssdk.services.s3.S3Client;

import com.amazonaws.services.lambda.runtime.Context;
import com.amazonaws.services.lambda.runtime.RequestHandler;
import com.amazonaws.services.lambda.runtime.events.S3Event;
import
    com.amazonaws.services.lambda.runtime.events.models.s3.S3EventNotification.S3EventNo

import org.slf4j.Logger;
import org.slf4j.LoggerFactory;

public class Handler implements RequestHandler<S3Event, String> {
    private static final Logger logger =
        LoggerFactory.getLogger(Handler.class);
    @Override
    public String handleRequest(S3Event s3event, Context context) {
        try {
            S3EventNotificationRecord record = s3event.getRecords().get(0);
            String srcBucket = record.getS3().getBucket().getName();
            String srcKey = record.getS3().getObject().getUrlDecodedKey();

            S3Client s3Client = S3Client.builder().build();
```

```
        HeadObjectResponse headObject = getHeadObject(s3Client, srcBucket,
srcKey);

        logger.info("Successfully retrieved " + srcBucket + "/" + srcKey +
" of type " + headObject.contentType());

        return "Ok";
    } catch (Exception e) {
        throw new RuntimeException(e);
    }
}

private HeadObjectResponse getHeadObject(S3Client s3Client, String
bucket, String key) {
    HeadObjectRequest headObjectRequest = HeadObjectRequest.builder()
        .bucket(bucket)
        .key(key)
        .build();
    return s3Client.headObject(headObjectRequest);
}
}
```

JavaScript

SDK for JavaScript (v3)

Note

There's more on GitHub. Find the complete example and learn how to set up and run in the [Serverless examples](#) repository.

Consuming an S3 event with Lambda using JavaScript.

```
import { S3Client, HeadObjectCommand } from "@aws-sdk/client-s3";

const client = new S3Client();

export const handler = async (event, context) => {

    // Get the object from the event and show its content type
```

```

const bucket = event.Records[0].s3.bucket.name;
const key = decodeURIComponent(event.Records[0].s3.object.key.replace(/\+/g, ' '));

try {
  const { ContentType } = await client.send(new HeadObjectCommand({
    Bucket: bucket,
    Key: key,
  }));

  console.log('CONTENT TYPE:', ContentType);
  return ContentType;

} catch (err) {
  console.log(err);
  const message = `Error getting object ${key} from bucket ${bucket}.
Make sure they exist and your bucket is in the same region as this
function.`;
  console.log(message);
  throw new Error(message);
}
};

```

Consuming an S3 event with Lambda using TypeScript.

```

// Copyright Amazon.com, Inc. or its affiliates. All Rights Reserved.
// SPDX-License-Identifier: Apache-2.0
import { S3Event } from 'aws-lambda';
import { S3Client, HeadObjectCommand } from '@aws-sdk/client-s3';

const s3 = new S3Client({ region: process.env.AWS_REGION });

export const handler = async (event: S3Event): Promise<string | undefined> =>
{
  // Get the object from the event and show its content type
  const bucket = event.Records[0].s3.bucket.name;
  const key = decodeURIComponent(event.Records[0].s3.object.key.replace(/\+/g, ' '));
  const params = {
    Bucket: bucket,
    Key: key,
  };
};

```

```
try {
    const { ContentType } = await s3.send(new HeadObjectCommand(params));
    console.log('CONTENT TYPE:', ContentType);
    return ContentType;
} catch (err) {
    console.log(err);
    const message = `Error getting object ${key} from bucket ${bucket}. Make
sure they exist and your bucket is in the same region as this function.`;
    console.log(message);
    throw new Error(message);
}
};
```

PHP

SDK for PHP

Note

There's more on GitHub. Find the complete example and learn how to set up and run in the [Serverless examples](#) repository.

Consuming an S3 event with Lambda using PHP.

```
<?php

use Bref\Context\Context;
use Bref\Event\S3\S3Event;
use Bref\Event\S3\S3Handler;
use Bref\Logger\StderrLogger;

require __DIR__ . '/vendor/autoload.php';

class Handler extends S3Handler
{
    private StderrLogger $logger;
    public function __construct(StderrLogger $logger)
    {
        $this->logger = $logger;
    }
}
```

```
}

public function handleS3(S3Event $event, Context $context) : void
{
    $this->logger->info("Processing S3 records");

    // Get the object from the event and show its content type
    $records = $event->getRecords();

    foreach ($records as $record)
    {
        $bucket = $record->getBucket()->getName();
        $key = urldecode($record->getObject()->getKey());

        try {
            $fileSize = urldecode($record->getObject()->getSize());
            echo "File Size: " . $fileSize . "\n";
            // TODO: Implement your custom processing logic here
        } catch (Exception $e) {
            echo $e->getMessage() . "\n";
            echo 'Error getting object ' . $key . ' from bucket ' .
                $bucket . '. Make sure they exist and your bucket is in the same region as
                this function.' . "\n";
            throw $e;
        }
    }
}

$logger = new StderrLogger();
return new Handler($logger);
```

Python

SDK for Python (Boto3)

Note

There's more on GitHub. Find the complete example and learn how to set up and run in the [Serverless examples](#) repository.

Consuming an S3 event with Lambda using Python.

```
# Copyright Amazon.com, Inc. or its affiliates. All Rights Reserved.
# SPDX-License-Identifier: Apache-2.0
import json
import urllib.parse
import boto3

print('Loading function')

s3 = boto3.client('s3')

def lambda_handler(event, context):
    #print("Received event: " + json.dumps(event, indent=2))

    # Get the object from the event and show its content type
    bucket = event['Records'][0]['s3']['bucket']['name']
    key = urllib.parse.unquote_plus(event['Records'][0]['s3']['object']
    ['key'], encoding='utf-8')
    try:
        response = s3.get_object(Bucket=bucket, Key=key)
        print("CONTENT TYPE: " + response['ContentType'])
        return response['ContentType']
    except Exception as e:
        print(e)
        print('Error getting object {} from bucket {}. Make sure they
        exist and your bucket is in the same region as this function.'.format(key,
        bucket))
        raise e
```

Ruby

SDK for Ruby

Note

There's more on GitHub. Find the complete example and learn how to set up and run in the [Serverless examples](#) repository.

Consuming an S3 event with Lambda using Ruby.

```
require 'json'
require 'uri'
require 'aws-sdk'

puts 'Loading function'

def lambda_handler(event:, context:)
  s3 = Aws::S3::Client.new(region: 'region') # Your AWS region
  # puts "Received event: #{JSON.dump(event)}"

  # Get the object from the event and show its content type
  bucket = event['Records'][0]['s3']['bucket']['name']
  key = URI.decode_www_form_component(event['Records'][0]['s3']['object']
['key'], Encoding::UTF_8)
  begin
    response = s3.get_object(bucket: bucket, key: key)
    puts "CONTENT TYPE: #{response.content_type}"
    return response.content_type
  rescue StandardError => e
    puts e.message
    puts "Error getting object #{key} from bucket #{bucket}. Make sure they
exist and your bucket is in the same region as this function."
    raise e
  end
end
```

Rust

SDK for Rust

Note

There's more on GitHub. Find the complete example and learn how to set up and run in the [Serverless examples](#) repository.

Consuming an S3 event with Lambda using Rust.

```
// Copyright Amazon.com, Inc. or its affiliates. All Rights Reserved.
// SPDX-License-Identifier: Apache-2.0
use aws_lambda_events::event::s3::S3Event;
use aws_sdk_s3::{Client};
use lambda_runtime::{run, service_fn, Error, LambdaEvent};

/// Main function
#[tokio::main]
async fn main() -> Result<(), Error> {
    tracing_subscriber::fmt()
        .with_max_level(tracing::Level::INFO)
        .with_target(false)
        .without_time()
        .init();

    // Initialize the AWS SDK for Rust
    let config = aws_config::load_from_env().await;
    let s3_client = Client::new(&config);

    let res = run(service_fn(|request: LambdaEvent<S3Event>| {
        function_handler(&s3_client, request)
    })).await;

    res
}

async fn function_handler(
    s3_client: &Client,
```

```
    evt: LambdaEvent<S3Event>
) -> Result<(), Error> {
    tracing::info!(records = ?evt.payload.records.len(), "Received request
from SQS");

    if evt.payload.records.len() == 0 {
        tracing::info!("Empty S3 event received");
    }

    let bucket =
evt.payload.records[0].s3.bucket.name.as_ref().expect("Bucket name to
exist");
    let key = evt.payload.records[0].s3.object.key.as_ref().expect("Object
key to exist");

    tracing::info!("Request is for {} and object {}", bucket, key);

    let s3_get_object_result = s3_client
        .get_object()
        .bucket(bucket)
        .key(key)
        .send()
        .await;

    match s3_get_object_result {
        Ok(_) => tracing::info!("S3 Get Object success, the s3GetObjectResult
contains a 'body' property of type ByteStream"),
        Err(_) => tracing::info!("Failure with S3 Get Object request")
    }

    Ok(())
}
```

2. In the **Code source** pane on the Lambda console, paste the code into the code editor, replacing the code that Lambda created.
3. In the **DEPLOY** section, choose **Deploy** to update your function's code:

▼ **DEPLOY [UNDEPLOYED CHANGES]**
 ⚠ You have undeployed changes.
 Deploy (Ctrl+Shift+U)
 Test (Ctrl+Shift+I)

Create the Amazon S3 trigger

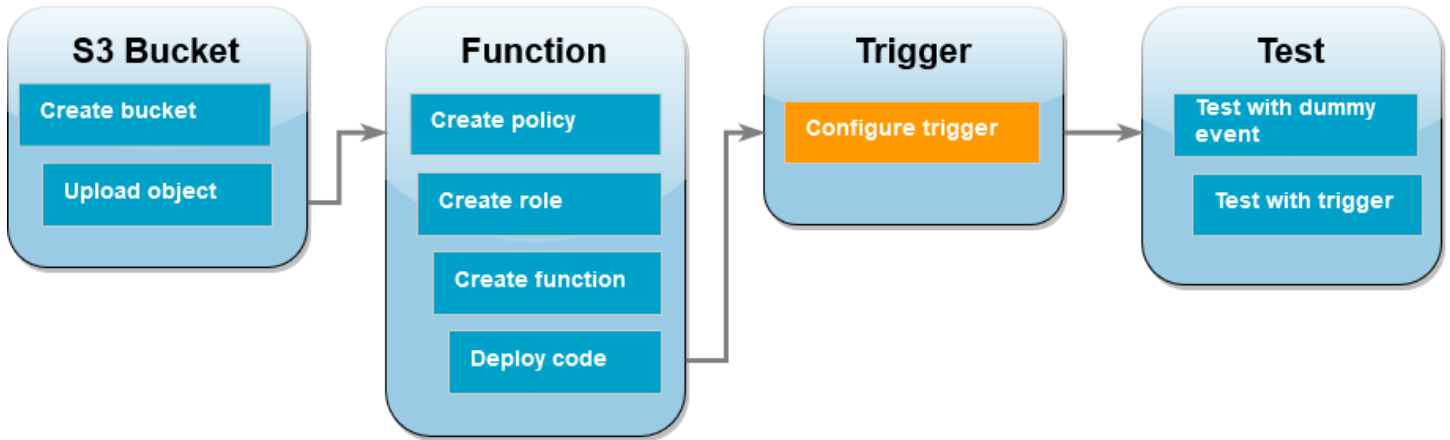



To create the Amazon S3 trigger

1. In the **Function overview** pane, choose **Add trigger**.

▼ **Function overview** [Info](#)

Diagram Template

 **s3-trigger-tutorial**

 Layers (0)

+ Add trigger + Add destination

2. Select **S3**.
3. Under **Bucket**, select the bucket you created earlier in the tutorial.

4. Under **Event types**, be sure that **All object create events** is selected.
5. Under **Recursive invocation**, select the check box to acknowledge that using the same Amazon S3 bucket for input and output is not recommended.
6. Choose **Add**.

Note

When you create an Amazon S3 trigger for a Lambda function using the Lambda console, Amazon S3 configures an [event notification](#) on the bucket you specify. Before configuring this event notification, Amazon S3 performs a series of checks to confirm that the event destination exists and has the required IAM policies. Amazon S3 also performs these tests on any other event notifications configured for that bucket.

Because of this check, if the bucket has previously configured event destinations for resources that no longer exist, or for resources that don't have the required permissions policies, Amazon S3 won't be able to create the new event notification. You'll see the following error message indicating that your trigger couldn't be created:

```
An error occurred when creating the trigger: Unable to validate the following destination configurations.
```

You can see this error if you previously configured a trigger for another Lambda function using the same bucket, and you have since deleted the function or modified its permissions policies.

Test your Lambda function with a dummy event

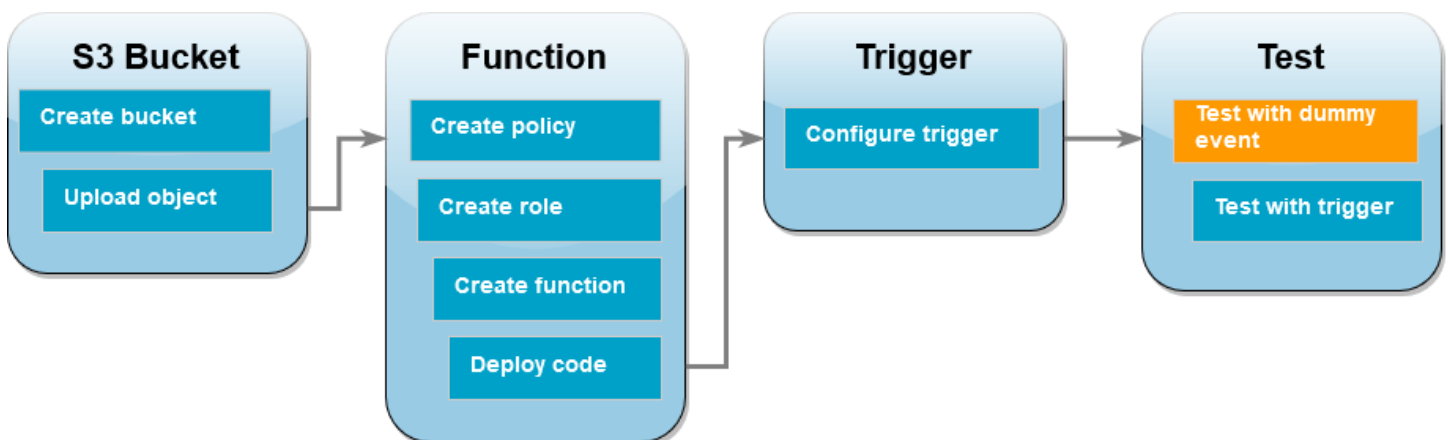

To test the Lambda function with a dummy event

1. In the Lambda console page for your function, choose the **Test** tab.

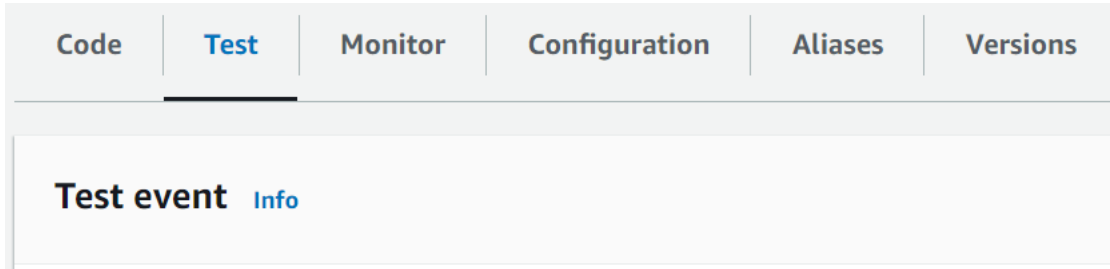

2. For **Event name**, enter MyTestEvent.
3. In the **Event JSON**, paste the following test event. Be sure to replace these values:
 - Replace `us-east-1` with the region you created your Amazon S3 bucket in.
 - Replace both instances of `amzn-s3-demo-bucket` with the name of your own Amazon S3 bucket.
 - Replace `test%2FKey` with the name of the test object you uploaded to your bucket earlier (for example, `HappyFace.jpg`).

```
{
  "Records": [
    {
      "eventVersion": "2.0",
      "eventSource": "aws:s3",
      "awsRegion": "us-east-1",
      "eventTime": "1970-01-01T00:00:00.000Z",
      "eventName": "ObjectCreated:Put",
      "userIdentity": {
        "principalId": "EXAMPLE"
      },
      "requestParameters": {
        "sourceIPAddress": "127.0.0.1"
      },
      "responseElements": {
        "x-amz-request-id": "EXAMPLE123456789",
        "x-amz-id-2": "EXAMPLE123/5678abcdefghijklambdaisawesome/mnopqrstuvwxyzABCDEFGH"
      },
      "s3": {
        "s3SchemaVersion": "1.0",
```

```

    "configurationId": "testConfigRule",
    "bucket": {
      "name": "amzn-s3-demo-bucket",
      "ownerIdentity": {
        "principalId": "EXAMPLE"
      },
      "arn": "arn:aws:s3:::amzn-s3-demo-bucket"
    },
    "object": {
      "key": "test%2Fkey",
      "size": 1024,
      "eTag": "0123456789abcdef0123456789abcdef",
      "sequencer": "0A1B2C3D4E5F678901"
    }
  }
}
]
}

```

4. Choose **Save**.
5. Choose **Test**.
6. If your function runs successfully, you'll see output similar to the following in the **Execution results** tab.

Response

```
"image/jpeg"
```

Function Logs

```

START RequestId: 12b3cae7-5f4e-415e-93e6-416b8f8b66e6 Version: $LATEST
2021-02-18T21:40:59.280Z    12b3cae7-5f4e-415e-93e6-416b8f8b66e6    INFO    INPUT
  BUCKET AND KEY: { Bucket: 'amzn-s3-demo-bucket', Key: 'HappyFace.jpg' }
2021-02-18T21:41:00.215Z    12b3cae7-5f4e-415e-93e6-416b8f8b66e6    INFO    CONTENT
  TYPE: image/jpeg
END RequestId: 12b3cae7-5f4e-415e-93e6-416b8f8b66e6
REPORT RequestId: 12b3cae7-5f4e-415e-93e6-416b8f8b66e6    Duration: 976.25 ms
  Billed Duration: 977 ms    Memory Size: 128 MB    Max Memory Used: 90 MB    Init
  Duration: 430.47 ms

```

Request ID

```
12b3cae7-5f4e-415e-93e6-416b8f8b66e6
```

Test the Lambda function with the Amazon S3 trigger

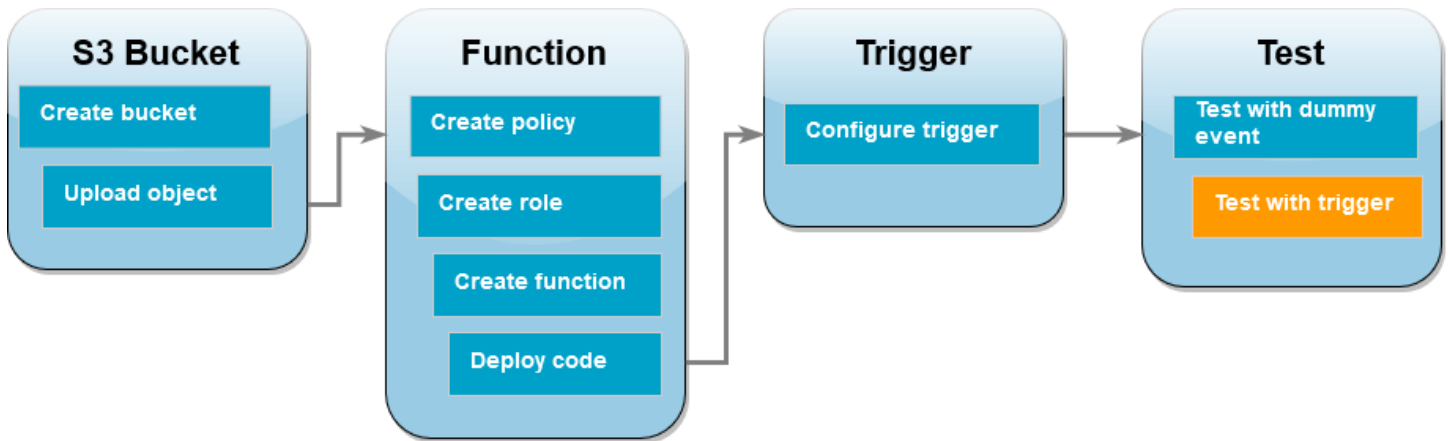

To test your function with the configured trigger, upload an object to your Amazon S3 bucket using the console. To verify that your Lambda function ran as expected, use CloudWatch Logs to view your function's output.

To upload an object to your Amazon S3 bucket

1. Open the [Buckets](#) page of the Amazon S3 console and choose the bucket that you created earlier.
2. Choose **Upload**.
3. Choose **Add files** and use the file selector to choose an object you want to upload. This object can be any file you choose.
4. Choose **Open**, then choose **Upload**.

To verify the function invocation using CloudWatch Logs

1. Open the [CloudWatch](#) console.
2. Make sure you're working in the same AWS Region you created your Lambda function in. You can change your Region using the drop-down list at the top of the screen.

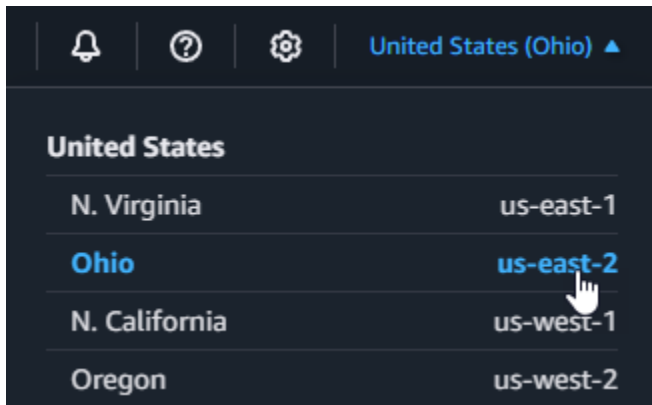

3. Choose **Logs**, then choose **Log groups**.
4. Choose the log group for your function (`/aws/lambda/s3-trigger-tutorial`).
5. Under **Log streams**, choose the most recent log stream.
6. If your function was invoked correctly in response to your Amazon S3 trigger, you'll see output similar to the following. The `CONTENT TYPE` you see depends on the type of file you uploaded to your bucket.

```
2022-05-09T23:17:28.702Z 0cae7f5a-b0af-4c73-8563-a3430333cc10 INFO CONTENT
TYPE: image/jpeg
```

Clean up your resources

You can now delete the resources that you created for this tutorial, unless you want to retain them. By deleting AWS resources that you're no longer using, you prevent unnecessary charges to your AWS account.

To delete the Lambda function

1. Open the [Functions page](#) of the Lambda console.
2. Select the function that you created.
3. Choose **Actions, Delete**.
4. Type **confirm** in the text input field and choose **Delete**.

To delete the execution role

1. Open the [Roles page](#) of the IAM console.

2. Select the execution role that you created.
3. Choose **Delete**.
4. Enter the name of the role in the text input field and choose **Delete**.

To delete the S3 bucket

1. Open the [Amazon S3 console](#).
2. Select the bucket you created.
3. Choose **Delete**.
4. Enter the name of the bucket in the text input field.
5. Choose **Delete bucket**.

Next steps

In [Tutorial: Using an Amazon S3 trigger to create thumbnail images](#), the Amazon S3 trigger invokes a function that creates a thumbnail image for each image file that is uploaded to a bucket. This tutorial requires a moderate level of AWS and Lambda domain knowledge. It demonstrates how to create resources using the AWS Command Line Interface (AWS CLI) and how to create a .zip file archive deployment package for the function and its dependencies.

Tutorial: Using an Amazon S3 trigger to create thumbnail images

In this tutorial, you create and configure a Lambda function that resizes images added to an Amazon Simple Storage Service (Amazon S3) bucket. When you add an image file to your bucket, Amazon S3 invokes your Lambda function. The function then creates a thumbnail version of the image and outputs it to a different Amazon S3 bucket.

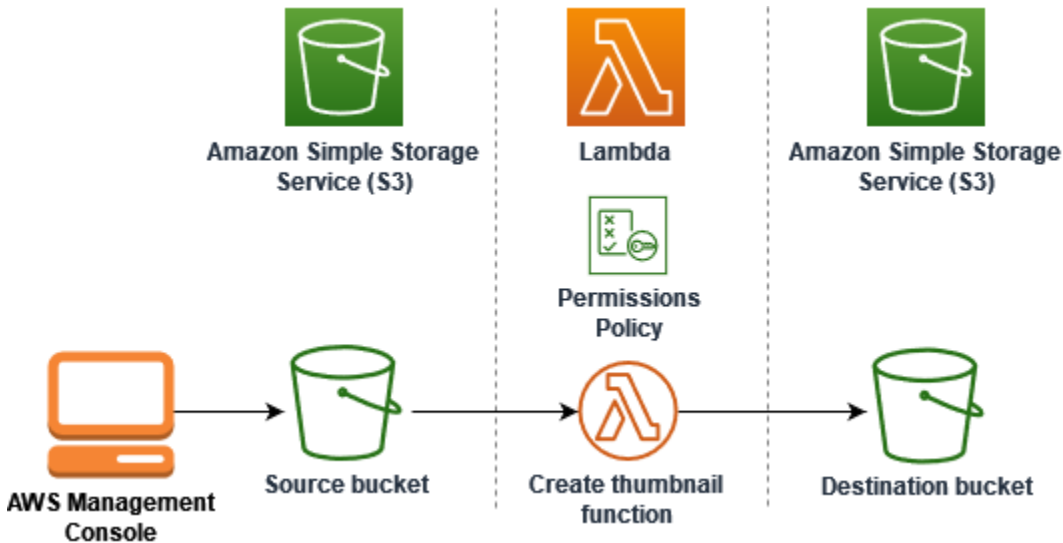

To complete this tutorial, you carry out the following steps:

1. Create source and destination Amazon S3 buckets and upload a sample image.
2. Create a Lambda function that resizes an image and outputs a thumbnail to an Amazon S3 bucket.
3. Configure a Lambda trigger that invokes your function when objects are uploaded to your source bucket.
4. Test your function, first with a dummy event, and then by uploading an image to your source bucket.

By completing these steps, you'll learn how to use Lambda to carry out a file processing task on objects added to an Amazon S3 bucket. You can complete this tutorial using the AWS Command Line Interface (AWS CLI) or the AWS Management Console.

If you're looking for a simpler example to learn how to configure an Amazon S3 trigger for Lambda, you can try [Tutorial: Using an Amazon S3 trigger to invoke a Lambda function](#).

Topics

- [Prerequisites](#)
- [Create two Amazon S3 buckets](#)
- [Upload a test image to your source bucket](#)
- [Create a permissions policy](#)
- [Create an execution role](#)

- [Create the function deployment package](#)
- [Create the Lambda function](#)
- [Configure Amazon S3 to invoke the function](#)
- [Test your Lambda function with a dummy event](#)
- [Test your function using the Amazon S3 trigger](#)
- [Clean up your resources](#)

Prerequisites

Sign up for an AWS account

If you do not have an AWS account, complete the following steps to create one.

To sign up for an AWS account

1. Open <https://portal.aws.amazon.com/billing/signup>.
2. Follow the online instructions.

Part of the sign-up procedure involves receiving a phone call and entering a verification code on the phone keypad.

When you sign up for an AWS account, an *AWS account root user* is created. The root user has access to all AWS services and resources in the account. As a security best practice, assign administrative access to a user, and use only the root user to perform [tasks that require root user access](#).

AWS sends you a confirmation email after the sign-up process is complete. At any time, you can view your current account activity and manage your account by going to <https://aws.amazon.com/> and choosing **My Account**.

Create a user with administrative access

After you sign up for an AWS account, secure your AWS account root user, enable AWS IAM Identity Center, and create an administrative user so that you don't use the root user for everyday tasks.

Secure your AWS account root user

1. Sign in to the [AWS Management Console](#) as the account owner by choosing **Root user** and entering your AWS account email address. On the next page, enter your password.

For help signing in by using root user, see [Signing in as the root user](#) in the *AWS Sign-In User Guide*.

2. Turn on multi-factor authentication (MFA) for your root user.

For instructions, see [Enable a virtual MFA device for your AWS account root user \(console\)](#) in the *IAM User Guide*.

Create a user with administrative access

1. Enable IAM Identity Center.

For instructions, see [Enabling AWS IAM Identity Center](#) in the *AWS IAM Identity Center User Guide*.

2. In IAM Identity Center, grant administrative access to a user.

For a tutorial about using the IAM Identity Center directory as your identity source, see [Configure user access with the default IAM Identity Center directory](#) in the *AWS IAM Identity Center User Guide*.

Sign in as the user with administrative access

- To sign in with your IAM Identity Center user, use the sign-in URL that was sent to your email address when you created the IAM Identity Center user.

For help signing in using an IAM Identity Center user, see [Signing in to the AWS access portal](#) in the *AWS Sign-In User Guide*.

Assign access to additional users

1. In IAM Identity Center, create a permission set that follows the best practice of applying least-privilege permissions.

For instructions, see [Create a permission set](#) in the *AWS IAM Identity Center User Guide*.

2. Assign users to a group, and then assign single sign-on access to the group.

For instructions, see [Add groups](#) in the *AWS IAM Identity Center User Guide*.

If you want to use the AWS CLI to complete the tutorial, install the [latest version of the AWS Command Line Interface](#).

For your Lambda function code, you can use Python or Node.js. Install the language support tools and a package manager for the language that you want to use.

Create two Amazon S3 buckets

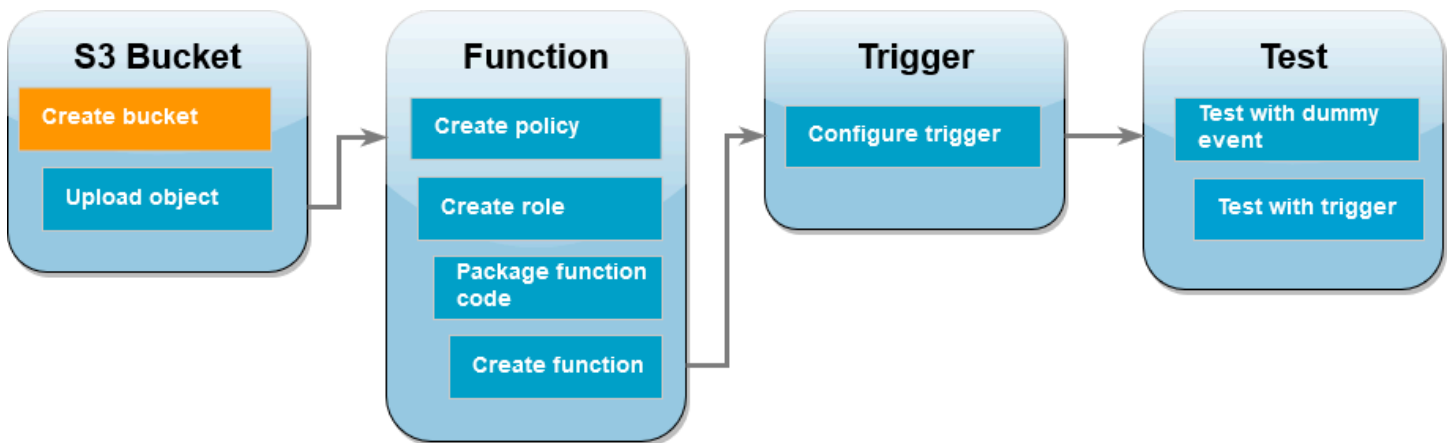

First create two Amazon S3 buckets. The first bucket is the source bucket you will upload your images to. The second bucket is used by Lambda to save the resized thumbnail when you invoke your function.

AWS Management Console

To create the Amazon S3 buckets (console)

1. Open the [Buckets](#) page of the Amazon S3 console.
2. Choose **Create bucket**.
3. Under **General configuration**, do the following:
 - a. For **Bucket name**, enter a globally unique name that meets the Amazon S3 [Bucket naming rules](#). Bucket names can contain only lower case letters, numbers, dots (.), and hyphens (-).

- b. For **AWS Region**, choose the [AWS Region](#) closest to your geographical location. Later in the tutorial, you must create your Lambda function in the same AWS Region, so make a note of the region you chose.
4. Leave all other options set to their default values and choose **Create bucket**.
5. Repeat steps 1 to 4 to create your destination bucket. For **Bucket name**, enter **amzn-s3-demo-source-bucket-resized**, where **amzn-s3-demo-source-bucket** is the name of the source bucket you just created.

AWS CLI

To create the Amazon S3 buckets (AWS CLI)

1. Run the following CLI command to create your source bucket. The name you choose for your bucket must be globally unique and follow the Amazon S3 [Bucket naming rules](#). Names can only contain lower case letters, numbers, dots (.), and hyphens (-). For region and LocationConstraint, choose the [AWS Region](#) closest to your geographical location.

```
aws s3api create-bucket --bucket amzn-s3-demo-source-bucket --region us-east-1 \
--create-bucket-configuration LocationConstraint=us-east-1
```

Later in the tutorial, you must create your Lambda function in the same AWS Region as your source bucket, so make a note of the region you chose.

2. Run the following command to create your destination bucket. For the bucket name, you must use **amzn-s3-demo-source-bucket-resized**, where **amzn-s3-demo-source-bucket** is the name of the source bucket you created in step 1. For region and LocationConstraint, choose the same AWS Region you used to create your source bucket.

```
aws s3api create-bucket --bucket amzn-s3-demo-source-bucket-resized --region us-east-1 \
--create-bucket-configuration LocationConstraint=us-east-1
```

Upload a test image to your source bucket

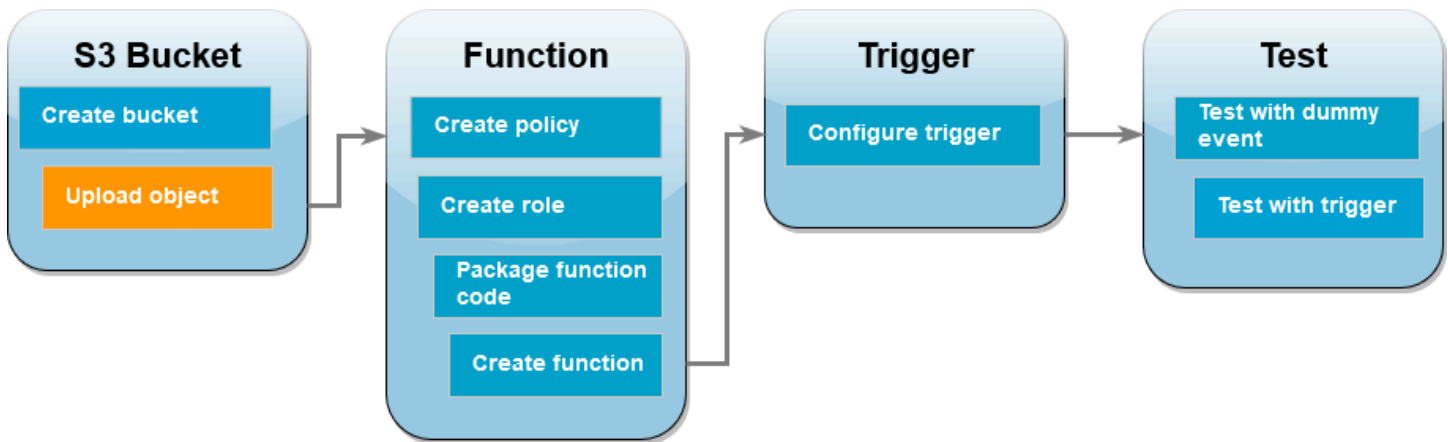

Later in the tutorial, you'll test your Lambda function by invoking it using the AWS CLI or the Lambda console. To confirm that your function is operating correctly, your source bucket needs to contain a test image. This image can be any JPG or PNG file you choose.

AWS Management Console

To upload a test image to your source bucket (console)

1. Open the [Buckets](#) page of the Amazon S3 console.
2. Select the source bucket you created in the previous step.
3. Choose **Upload**.
4. Choose **Add files** and use the file selector to choose the object you want to upload.
5. Choose **Open**, then choose **Upload**.

AWS CLI

To upload a test image to your source bucket (AWS CLI)

- From the directory containing the image you want to upload, run the following CLI command. Replace the `--bucket` parameter with the name of your source bucket. For the `--key` and `--body` parameters, use the filename of your test image.

```
aws s3api put-object --bucket amzn-s3-demo-source-bucket --key HappyFace.jpg --body ./HappyFace.jpg
```

Create a permissions policy

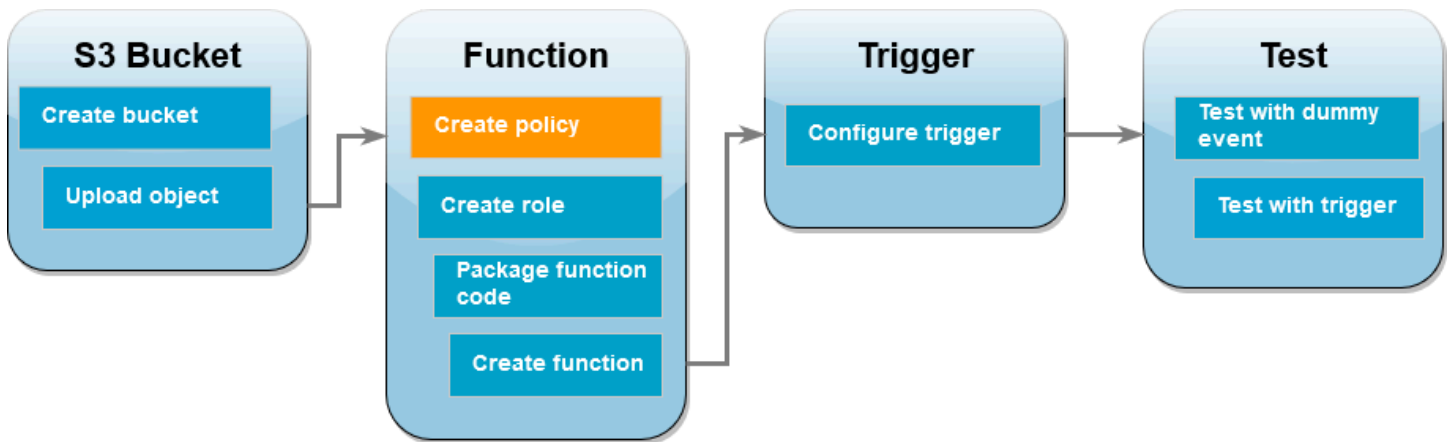

The first step in creating your Lambda function is to create a permissions policy. This policy gives your function the permissions it needs to access other AWS resources. For this tutorial, the policy gives Lambda read and write permissions for Amazon S3 buckets and allows it to write to Amazon CloudWatch Logs.

AWS Management Console

To create the policy (console)

1. Open the [Policies](#) page of the AWS Identity and Access Management (IAM) console.
2. Choose **Create policy**.
3. Choose the **JSON** tab, and then paste the following custom policy into the JSON editor.

```

{
  "Version": "2012-10-17",
  "Statement": [
    {
      "Effect": "Allow",
      "Action": [
        "logs:PutLogEvents",
        "logs:CreateLogGroup",
        "logs:CreateLogStream"
      ],
      "Resource": "arn:aws:logs:*:*:*"
    },
    {
      "Effect": "Allow",
      "Action": [
  
```



```

        "s3:GetObject"
    ],
    "Resource": "arn:aws:s3:::*/*"
  },
  {
    "Effect": "Allow",
    "Action": [
      "s3:PutObject"
    ],
    "Resource": "arn:aws:s3:::*/*"
  }
]
}

```

4. Choose **Next**.
5. Under **Policy details**, for **Policy name**, enter **LambdaS3Policy**.
6. Choose **Create policy**.

AWS CLI

To create the policy (AWS CLI)

1. Save the following JSON in a file named `policy.json`.

```

{
  "Version": "2012-10-17",
  "Statement": [
    {
      "Effect": "Allow",
      "Action": [
        "logs:PutLogEvents",
        "logs:CreateLogGroup",
        "logs:CreateLogStream"
      ],
      "Resource": "arn:aws:logs:*:*:*"
    },
    {
      "Effect": "Allow",
      "Action": [
        "s3:GetObject"
      ],
      "Resource": "arn:aws:s3:::*/*"
    }
  ]
}

```

```

    },
    {
      "Effect": "Allow",
      "Action": [
        "s3:PutObject"
      ],
      "Resource": "arn:aws:s3:::*/*"
    }
  ]
}

```

- From the directory you saved the JSON policy document in, run the following CLI command.

```
aws iam create-policy --policy-name LambdaS3Policy --policy-document file://policy.json
```

Create an execution role

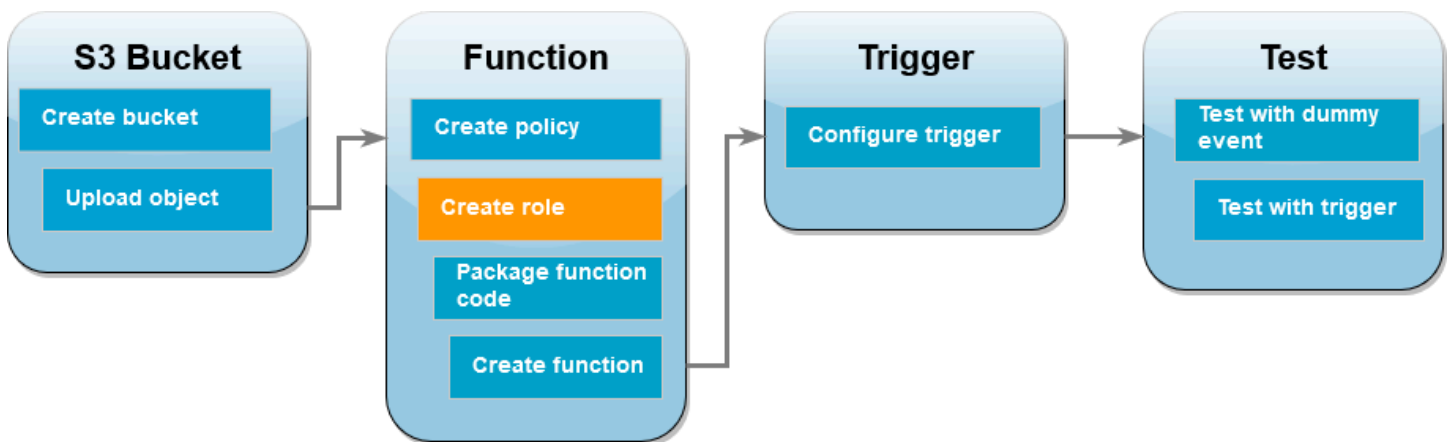

An execution role is an IAM role that grants a Lambda function permission to access AWS services and resources. To give your function read and write access to an Amazon S3 bucket, you attach the permissions policy you created in the previous step.

AWS Management Console

To create an execution role and attach your permissions policy (console)

- Open the [Roles](#) page of the (IAM) console.
- Choose **Create role**.

3. For **Trusted entity type**, select **AWS service**, and for **Use case**, select **Lambda**.
4. Choose **Next**.
5. Add the permissions policy you created in the previous step by doing the following:
 - a. In the policy search box, enter **LambdaS3Policy**.
 - b. In the search results, select the check box for LambdaS3Policy.
 - c. Choose **Next**.
6. Under **Role details**, for the **Role name** enter **LambdaS3Role**.
7. Choose **Create role**.

AWS CLI

To create an execution role and attach your permissions policy (AWS CLI)

1. Save the following JSON in a file named `trust-policy.json`. This trust policy allows Lambda to use the role's permissions by giving the service principal `lambda.amazonaws.com` permission to call the AWS Security Token Service (AWS STS) `AssumeRole` action.

```
{
  "Version": "2012-10-17",
  "Statement": [
    {
      "Effect": "Allow",
      "Principal": {
        "Service": "lambda.amazonaws.com"
      },
      "Action": "sts:AssumeRole"
    }
  ]
}
```

2. From the directory you saved the JSON trust policy document in, run the following CLI command to create the execution role.

```
aws iam create-role --role-name LambdaS3Role --assume-role-policy-document
file://trust-policy.json
```

- To attach the permissions policy you created in the previous step, run the following CLI command. Replace the AWS account number in the policy's ARN with your own account number.

```
aws iam attach-role-policy --role-name LambdaS3Role --policy-arn
arn:aws:iam::123456789012:policy/LambdaS3Policy
```

Create the function deployment package

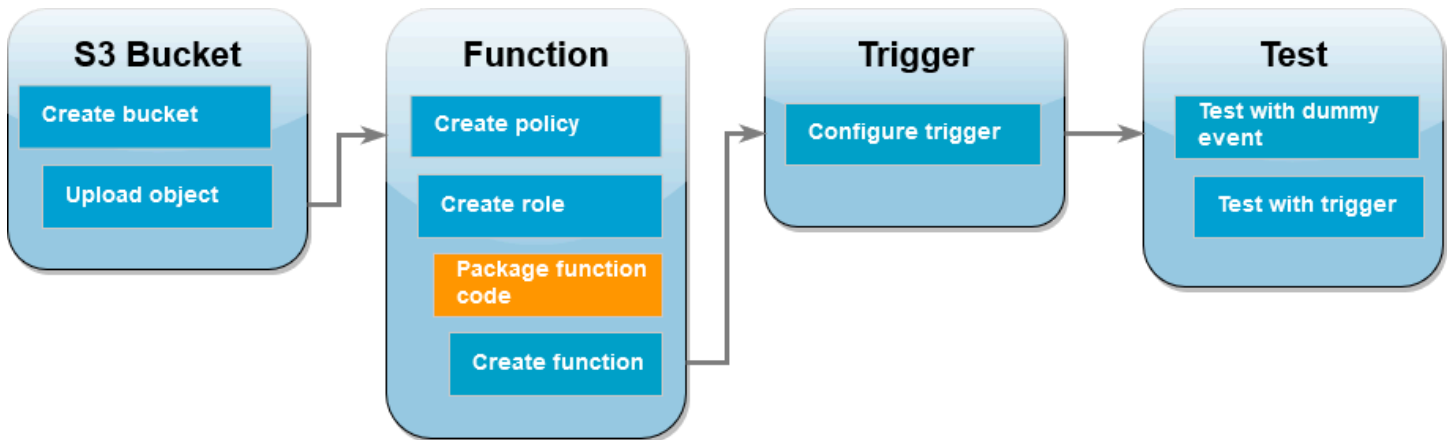

To create your function, you create a *deployment package* containing your function code and its dependencies. For this `CreateThumbnail` function, your function code uses a separate library for the image resizing. Follow the instructions for your chosen language to create a deployment package containing the required library.

Node.js

To create the deployment package (Node.js)

- Create a directory named `lambda-s3` for your function code and dependencies and navigate into it.

```
mkdir lambda-s3
cd lambda-s3
```

- Create a new Node.js project with npm. To accept the default options provided in the interactive experience, press `Enter`.

```
npm init
```

3. Save the following function code in a file named `index.mjs`. Make sure to replace `us-east-1` with the AWS Region in which you created your own source and destination buckets.

```
// dependencies
import { S3Client, GetObjectCommand, PutObjectCommand } from '@aws-sdk/client-s3';

import { Readable } from 'stream';

import sharp from 'sharp';
import util from 'util';

// create S3 client
const s3 = new S3Client({region: 'us-east-1'});

// define the handler function
export const handler = async (event, context) => {

// Read options from the event parameter and get the source bucket
console.log("Reading options from event:\n", util.inspect(event, {depth: 5}));
  const srcBucket = event.Records[0].s3.bucket.name;

// Object key may have spaces or unicode non-ASCII characters
const srcKey = decodeURIComponent(event.Records[0].s3.object.key.replace(/\+/g, " "));
const dstBucket = srcBucket + "-resized";
const dstKey = "resized-" + srcKey;

// Infer the image type from the file suffix
const typeMatch = srcKey.match(/\.[^.]*$/);
if (!typeMatch) {
  console.log("Could not determine the image type.");
  return;
}

// Check that the image type is supported
const imageType = typeMatch[1].toLowerCase();
if (imageType !== "jpg" && imageType !== "png") {
  console.log(`Unsupported image type: ${imageType}`);
  return;
}
```

```
// Get the image from the source bucket. GetObjectCommand returns a stream.
try {
  const params = {
    Bucket: srcBucket,
    Key: srcKey
  };
  var response = await s3.send(new GetObjectCommand(params));
  var stream = response.Body;

  // Convert stream to buffer to pass to sharp resize function.
  if (stream instanceof Readable) {
    var content_buffer = Buffer.concat(await stream.toArray());

  } else {
    throw new Error('Unknown object stream type');
  }

} catch (error) {
  console.log(error);
  return;
}

// set thumbnail width. Resize will set the height automatically to maintain
// aspect ratio.
const width = 200;

// Use the sharp module to resize the image and save in a buffer.
try {
  var output_buffer = await sharp(content_buffer).resize(width).toBuffer();

} catch (error) {
  console.log(error);
  return;
}

// Upload the thumbnail image to the destination bucket
try {
  const destparams = {
    Bucket: dstBucket,
    Key: dstKey,
    Body: output_buffer,
  };
}
```

```
    ContentType: "image"
  };

  const putResult = await s3.send(new PutObjectCommand(destparams));

  } catch (error) {
    console.log(error);
    return;
  }

  console.log('Successfully resized ' + srcBucket + '/' + srcKey +
    ' and uploaded to ' + dstBucket + '/' + dstKey);
};
```

4. In your `lambda-s3` directory, install the sharp library using npm. Note that the latest version of sharp (0.33) isn't compatible with Lambda. Install version 0.32.6 to complete this tutorial.

```
npm install sharp@0.32.6
```

The `npm install` command creates a `node_modules` directory for your modules. After this step, your directory structure should look like the following.

```
lambda-s3
|- index.mjs
|- node_modules
|  |- base64js
|  |- bl
|  |- buffer
...
|- package-lock.json
|- package.json
```

5. Create a `.zip` deployment package containing your function code and its dependencies. In MacOS and Linux, run the following command.

```
zip -r function.zip .
```

In Windows, use your preferred zip utility to create a `.zip` file. Ensure that your `index.mjs`, `package.json`, and `package-lock.json` files and your `node_modules` directory are all at the root of your `.zip` file.

Python

To create the deployment package (Python)

1. Save the example code as a file named `lambda_function.py`.

```
import boto3
import os
import sys
import uuid
from urllib.parse import unquote_plus
from PIL import Image
import PIL.Image

s3_client = boto3.client('s3')

def resize_image(image_path, resized_path):
    with Image.open(image_path) as image:
        image.thumbnail(tuple(x / 2 for x in image.size))
        image.save(resized_path)

def lambda_handler(event, context):
    for record in event['Records']:
        bucket = record['s3']['bucket']['name']
        key = unquote_plus(record['s3']['object']['key'])
        tmpkey = key.replace('/', '')
        download_path = '/tmp/{}'.format(uuid.uuid4(), tmpkey)
        upload_path = '/tmp/resized-{}'.format(tmpkey)
        s3_client.download_file(bucket, key, download_path)
        resize_image(download_path, upload_path)
        s3_client.upload_file(upload_path, '{}-resized'.format(bucket), 'resized-
{}'.format(key))
```

2. In the same directory in which you created your `lambda_function.py` file, create a new directory named `package` and install the [Pillow \(PIL\)](#) library and the AWS SDK for Python (Boto3). Although the Lambda Python runtime includes a version of the Boto3 SDK, we recommend that you add all of your function's dependencies to your deployment package, even if they are included in the runtime. For more information, see [Runtime dependencies in Python](#).

```
mkdir package
pip install \
```



```
--platform manylinux2014_x86_64 \  
--target=package \  
--implementation cp \  
--python-version 3.12 \  
--only-binary=:all: --upgrade \  
pillow boto3
```

The Pillow library contains C/C++ code. By using the `--platform manylinux_2014_x86_64` and `--only-binary=:all:` options, pip will download and install a version of Pillow that contains pre-compiled binaries compatible with the Amazon Linux 2 operating system. This ensures that your deployment package will work in the Lambda execution environment, regardless of the operating system and architecture of your local build machine.

3. Create a `.zip` file containing your application code and the Pillow and Boto3 libraries. In Linux or MacOS, run the following commands from your command line interface.

```
cd package  
zip -r ../lambda_function.zip .  
cd ..  
zip lambda_function.zip lambda_function.py
```

In Windows, use your preferred zip tool to create the `lambda_function.zip` file. Make sure that your `lambda_function.py` file and the folders containing your dependencies are all at the root of the `.zip` file.

You can also create your deployment package using a Python virtual environment. See [Working with .zip file archives for Python Lambda functions](#)

Create the Lambda function

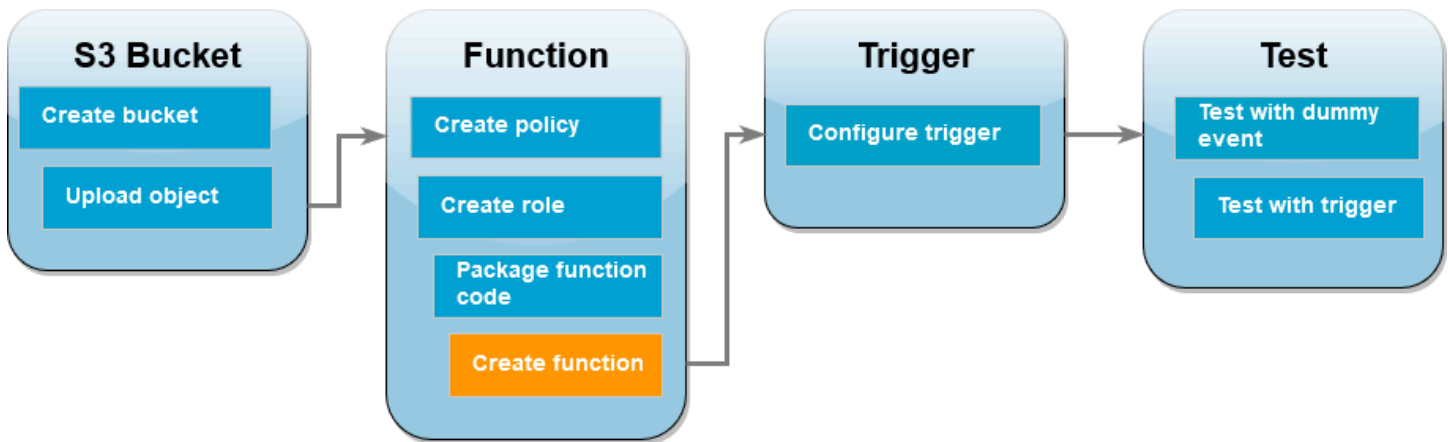

You can create your Lambda function using either the AWS CLI or the Lambda console. Follow the instructions for your chosen language to create the function.

AWS Management Console

To create the function (console)

To create your Lambda function using the console, you first create a basic function containing some 'Hello world' code. You then replace this code with your own function code by uploading the.zip or JAR file you created in the previous step.

1. Open the [Functions page](#) of the Lambda console.
2. Make sure you're working in the same AWS Region you created your Amazon S3 bucket in. You can change your region using the drop-down list at the top of the screen.

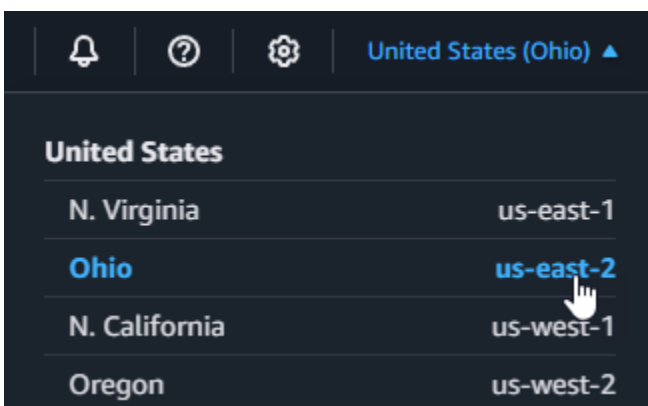

3. Choose **Create function**.
4. Choose **Author from scratch**.
5. Under **Basic information**, do the following:

- a. For **Function name**, enter **CreateThumbnail**.
 - b. For **Runtime**, choose either **Node.js 22.x** or **Python 3.12** according to the language you chose for your function.
 - c. For **Architecture**, choose **x86_64**.
6. In the **Change default execution role** tab, do the following:
 - a. Expand the tab, then choose **Use an existing role**.
 - b. Select the `LambdaS3Role` you created earlier.
 7. Choose **Create function**.

To upload the function code (console)

1. In the **Code source** pane, choose **Upload from**.
2. Choose **.zip file**.
3. Choose **Upload**.
4. In the file selector, select your .zip file and choose **Open**.
5. Choose **Save**.

AWS CLI

To create the function (AWS CLI)

- Run the CLI command for the language you chose. For the `role` parameter, make sure to replace `123456789012` with your own AWS account ID. For the `region` parameter, replace `us-east-1` with the region you created your Amazon S3 buckets in.
- For **Node.js**, run the following command from the directory containing your `function.zip` file.

```
aws lambda create-function --function-name CreateThumbnail \  
--zip-file fileb://function.zip --handler index.handler --runtime nodejs22.x \  
--timeout 10 --memory-size 1024 \  
--role arn:aws:iam::123456789012:role/LambdaS3Role --region us-east-1
```

- For **Python**, run the following command from the directory containing your `lambda_function.zip` file.

```
aws lambda create-function --function-name CreateThumbnail \  
--zip-file fileb://lambda_function.zip --handler \  
lambda_function.lambda_handler \  
--runtime python3.13 --timeout 10 --memory-size 1024 \  
--role arn:aws:iam::123456789012:role/LambdaS3Role --region us-east-1
```

Configure Amazon S3 to invoke the function

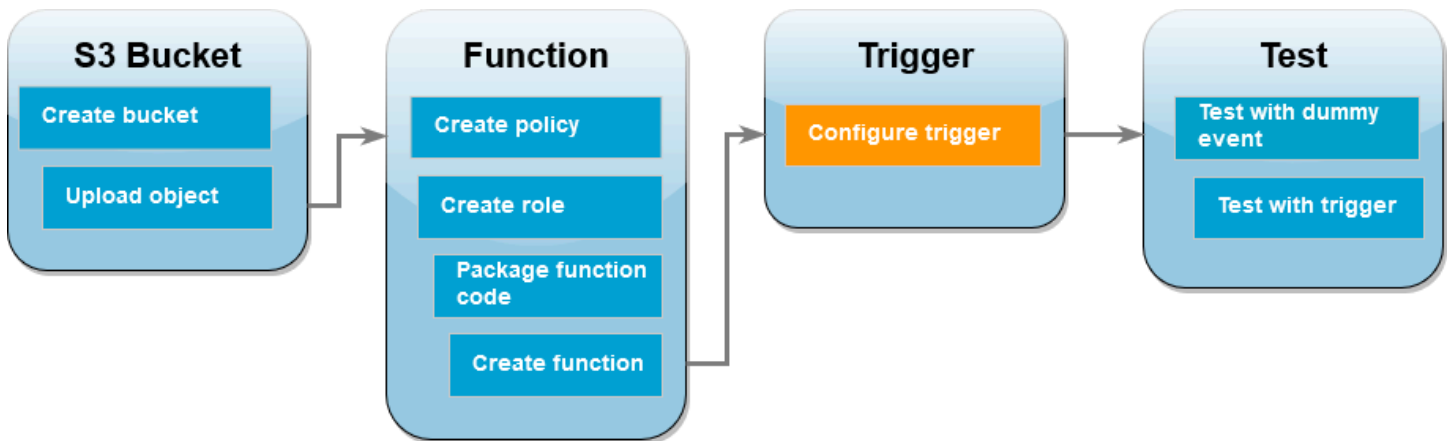

For your Lambda function to run when you upload an image to your source bucket, you need to configure a trigger for your function. You can configure the Amazon S3 trigger using either the console or the AWS CLI.

⚠ Important

This procedure configures the Amazon S3 bucket to invoke your function every time that an object is created in the bucket. Be sure to configure this only on the source bucket. If your Lambda function creates objects in the same bucket that invokes it, your function can be [invoked continuously in a loop](#). This can result in unexpected charges being billed to your AWS account.

AWS Management Console

To configure the Amazon S3 trigger (console)

1. Open the [Functions page](#) of the Lambda console and choose your function (CreateThumbnail).

2. Choose **Add trigger**.
3. Select **S3**.
4. Under **Bucket**, select your source bucket.
5. Under **Event types**, select **All object create events**.
6. Under **Recursive invocation**, select the check box to acknowledge that using the same Amazon S3 bucket for input and output is not recommended. You can learn more about recursive invocation patterns in Lambda by reading [Recursive patterns that cause run-away Lambda functions](#) in Serverless Land.
7. Choose **Add**.

When you create a trigger using the Lambda console, Lambda automatically creates a [resource based policy](#) to give the service you select permission to invoke your function.

AWS CLI

To configure the Amazon S3 trigger (AWS CLI)

1. For your Amazon S3 source bucket to invoke your function when you add an image file, you first need to configure permissions for your function using a [resource based policy](#). A resource-based policy statement gives other AWS services permission to invoke your function. To give Amazon S3 permission to invoke your function, run the following CLI command. Be sure to replace the `source-account` parameter with your own AWS account ID and to use your own source bucket name.

```
aws lambda add-permission --function-name CreateThumbnail \  
--principal s3.amazonaws.com --statement-id s3invoke --action \  
"lambda:InvokeFunction" \  
--source-arn arn:aws:s3:::amzn-s3-demo-source-bucket \  
--source-account 123456789012
```

The policy you define with this command allows Amazon S3 to invoke your function only when an action takes place on your source bucket.

Note

Although Amazon S3 bucket names are globally unique, when using resource-based policies it is best practice to specify that the bucket must belong to your account.

This is because if you delete a bucket, it is possible for another AWS account to create a bucket with the same Amazon Resource Name (ARN).

2. Save the following JSON in a file named `notification.json`. When applied to your source bucket, this JSON configures the bucket to send a notification to your Lambda function every time a new object is added. Replace the AWS account number and AWS Region in the Lambda function ARN with your own account number and region.

```
{
  "LambdaFunctionConfigurations": [
    {
      "Id": "CreateThumbnailEventConfiguration",
      "LambdaFunctionArn": "arn:aws:lambda:us-
east-1:123456789012:function:CreateThumbnail",
      "Events": [ "s3:ObjectCreated:Put" ]
    }
  ]
}
```

3. Run the following CLI command to apply the notification settings in the JSON file you created to your source bucket. Replace `amzn-s3-demo-source-bucket` with the name of your own source bucket.

```
aws s3api put-bucket-notification-configuration --bucket amzn-s3-demo-source-
bucket \
--notification-configuration file://notification.json
```

To learn more about the `put-bucket-notification-configuration` command and the `notification-configuration` option, see [put-bucket-notification-configuration](#) in the *AWS CLI Command Reference*.

Test your Lambda function with a dummy event

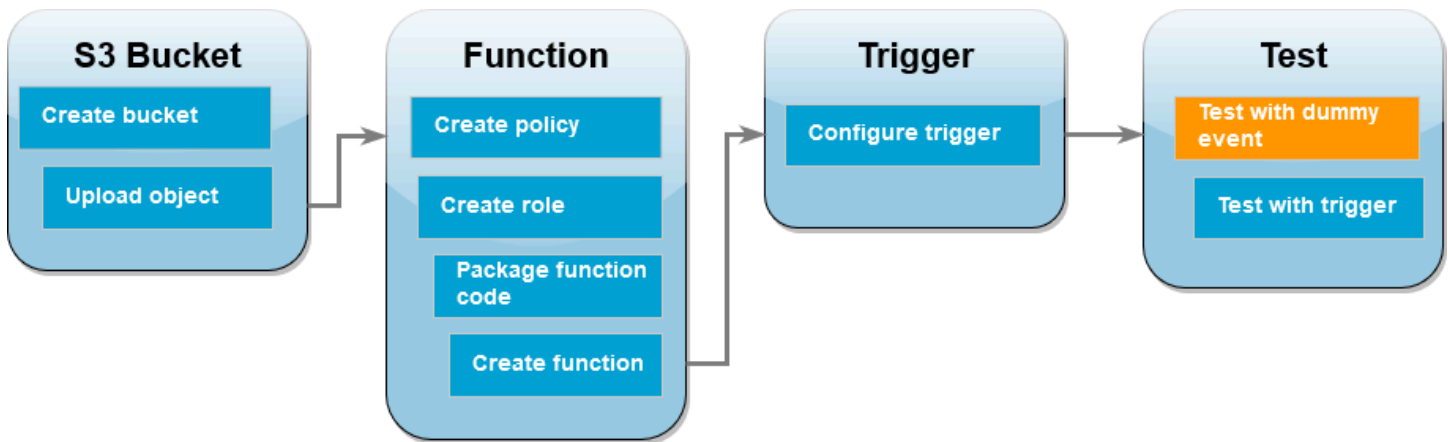

Before you test your whole setup by adding an image file to your Amazon S3 source bucket, you test that your Lambda function is working correctly by invoking it with a dummy event. An event in Lambda is a JSON-formatted document that contains data for your function to process. When your function is invoked by Amazon S3, the event sent to your function contains information such as the bucket name, bucket ARN, and object key.

AWS Management Console

To test your Lambda function with a dummy event (console)

1. Open the [Functions page](#) of the Lambda console and choose your function (CreateThumbnail).
2. Choose the **Test** tab.
3. To create your test event, in the **Test event** pane, do the following:
 - a. Under **Test event action**, select **Create new event**.
 - b. For **Event name**, enter **myTestEvent**.
 - c. For **Template**, select **S3 Put**.
 - d. Replace the values for the following parameters with your own values.
 - For **awsRegion**, replace `us-east-1` with the AWS Region you created your Amazon S3 buckets in.
 - For **name**, replace `amzn-s3-demo-bucket` with the name of your own Amazon S3 source bucket.

- For key, replace `test%2Fkey` with the filename of the test object you uploaded to your source bucket in the step [Upload a test image to your source bucket](#).

```
{
  "Records": [
    {
      "eventVersion": "2.0",
      "eventSource": "aws:s3",
      "awsRegion": "us-east-1",
      "eventTime": "1970-01-01T00:00:00.000Z",
      "eventName": "ObjectCreated:Put",
      "userIdentity": {
        "principalId": "EXAMPLE"
      },
      "requestParameters": {
        "sourceIPAddress": "127.0.0.1"
      },
      "responseElements": {
        "x-amz-request-id": "EXAMPLE123456789",
        "x-amz-id-2": "EXAMPLE123/5678abcdefghijklambdaisawesome/mnopqrstuvwxyzABCDEFGH"
      },
      "s3": {
        "s3SchemaVersion": "1.0",
        "configurationId": "testConfigRule",
        "bucket": {
          "name": "amzn-s3-demo-bucket",
          "ownerIdentity": {
            "principalId": "EXAMPLE"
          },
          "arn": "arn:aws:s3:::amzn-s3-demo-bucket"
        },
        "object": {
          "key": "test%2Fkey",
          "size": 1024,
          "eTag": "0123456789abcdef0123456789abcdef",
          "sequencer": "0A1B2C3D4E5F678901"
        }
      }
    }
  ]
}
```

- e. Choose **Save**.
4. In the **Test event** pane, choose **Test**.
 5. To check the your function has created a resized verison of your image and stored it in your target Amazon S3 bucket, do the following:
 - a. Open the [Buckets page](#) of the Amazon S3 console.
 - b. Choose your target bucket and confirm that your resized file is listed in the **Objects** pane.

AWS CLI

To test your Lambda function with a dummy event (AWS CLI)

1. Save the following JSON in a file named `dummyS3Event.json`. Replace the values for the following parameters with your own values:
 - For `awsRegion`, replace `us-east-1` with the AWS Region you created your Amazon S3 buckets in.
 - For `name`, replace `amzn-s3-demo-bucket` with the name of your own Amazon S3 source bucket.
 - For `key`, replace `test%2Fkey` with the filename of the test object you uploaded to your source bucket in the step [Upload a test image to your source bucket](#).

```
{
  "Records": [
    {
      "eventVersion": "2.0",
      "eventSource": "aws:s3",
      "awsRegion": "us-east-1",
      "eventTime": "1970-01-01T00:00:00.000Z",
      "eventName": "ObjectCreated:Put",
      "userIdentity": {
        "principalId": "EXAMPLE"
      },
      "requestParameters": {
        "sourceIPAddress": "127.0.0.1"
      },
      "responseElements": {
```

```

    "x-amz-request-id": "EXAMPLE123456789",
    "x-amz-id-2": "EXAMPLE123/5678abcdefghijklambdaisawesome/
mnopqrstuvwxyzABCDEFGH"
  },
  "s3": {
    "s3SchemaVersion": "1.0",
    "configurationId": "testConfigRule",
    "bucket": {
      "name": "amzn-s3-demo-bucket",
      "ownerIdentity": {
        "principalId": "EXAMPLE"
      },
      "arn": "arn:aws:s3:::amzn-s3-demo-bucket"
    },
    "object": {
      "key": "test%2Fkey",
      "size": 1024,
      "eTag": "0123456789abcdef0123456789abcdef",
      "sequencer": "0A1B2C3D4E5F678901"
    }
  }
}
]
}

```

- From the directory you saved your `dummyS3Event.json` file in, invoke the function by running the following CLI command. This command invokes your Lambda function synchronously by specifying `RequestResponse` as the value of the `invocation-type` parameter. To learn more about synchronous and asynchronous invocation, see [Invoking Lambda functions](#).

```

aws lambda invoke --function-name CreateThumbnail \
--invocation-type RequestResponse --cli-binary-format raw-in-base64-out \
--payload file://dummyS3Event.json outputfile.txt

```

The `cli-binary-format` option is required if you are using version 2 of the AWS CLI. To make this the default setting, run `aws configure set cli-binary-format raw-in-base64-out`. For more information, see [AWS CLI supported global command line options](#).

- Verify that your function has created a thumbnail version of your image and saved it to your target Amazon S3 bucket. Run the following CLI command, replacing `amzn-s3-demo-source-bucket-resized` with the name of your own destination bucket.

```
aws s3api list-objects-v2 --bucket amzn-s3-demo-source-bucket-resized
```

You should see output similar to the following. The Key parameter shows the filename of your resized image file.

```
{
  "Contents": [
    {
      "Key": "resized-HappyFace.jpg",
      "LastModified": "2023-06-06T21:40:07+00:00",
      "ETag": "\"d8ca652ffe83ba6b721ffc20d9d7174a\"",
      "Size": 2633,
      "StorageClass": "STANDARD"
    }
  ]
}
```

Test your function using the Amazon S3 trigger

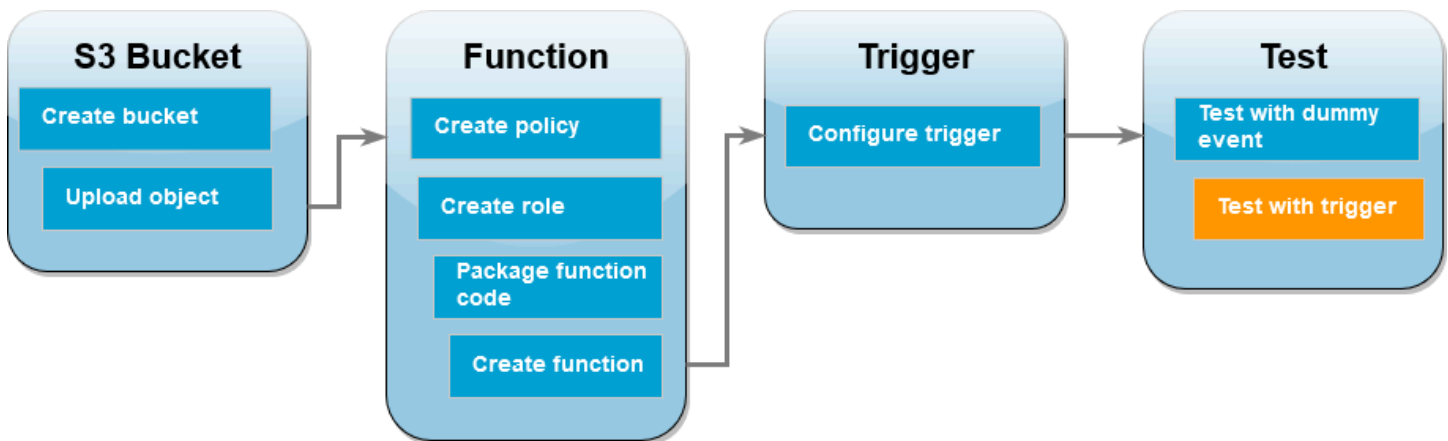

Now that you've confirmed your Lambda function is operating correctly, you're ready to test your complete setup by adding an image file to your Amazon S3 source bucket. When you add your image to the source bucket, your Lambda function should be automatically invoked. Your function creates a resized version of the file and stores it in your target bucket.

AWS Management Console

To test your Lambda function using the Amazon S3 trigger (console)

1. To upload an image to your Amazon S3 bucket, do the following:
 - a. Open the [Buckets](#) page of the Amazon S3 console and choose your source bucket.
 - b. Choose **Upload**.
 - c. Choose **Add files** and use the file selector to choose the image file you want to upload. Your image object can be any .jpg or .png file.
 - d. Choose **Open**, then choose **Upload**.
2. Verify that Lambda has saved a resized version of your image file in your target bucket by doing the following:
 - a. Navigate back to the [Buckets](#) page of the Amazon S3 console and choose your destination bucket.
 - b. In the **Objects** pane, you should now see two resized image files, one from each test of your Lambda function. To download your resized image, select the file, then choose **Download**.

AWS CLI

To test your Lambda function using the Amazon S3 trigger (AWS CLI)

1. From the directory containing the image you want to upload, run the following CLI command. Replace the `--bucket` parameter with the name of your source bucket. For the `--key` and `--body` parameters, use the filename of your test image. Your test image can be any .jpg or .png file.

```
aws s3api put-object --bucket amzn-s3-demo-source-bucket --key SmileyFace.jpg --  
body ./SmileyFace.jpg
```

2. Verify that your function has created a thumbnail version of your image and saved it to your target Amazon S3 bucket. Run the following CLI command, replacing `amzn-s3-demo-source-bucket-resized` with the name of your own destination bucket.

```
aws s3api list-objects-v2 --bucket amzn-s3-demo-source-bucket-resized
```

If your function runs successfully, you'll see output similar to the following. Your target bucket should now contain two resized files.

```
{
  "Contents": [
    {
      "Key": "resized-HappyFace.jpg",
      "LastModified": "2023-06-07T00:15:50+00:00",
      "ETag": "\"7781a43e765a8301713f533d70968a1e\"",
      "Size": 2763,
      "StorageClass": "STANDARD"
    },
    {
      "Key": "resized-SmileyFace.jpg",
      "LastModified": "2023-06-07T00:13:18+00:00",
      "ETag": "\"ca536e5a1b9e32b22cd549e18792cdbc\"",
      "Size": 1245,
      "StorageClass": "STANDARD"
    }
  ]
}
```

Clean up your resources

You can now delete the resources that you created for this tutorial, unless you want to retain them. By deleting AWS resources that you're no longer using, you prevent unnecessary charges to your AWS account.

To delete the Lambda function

1. Open the [Functions page](#) of the Lambda console.
2. Select the function that you created.
3. Choose **Actions, Delete**.
4. Type **confirm** in the text input field and choose **Delete**.

To delete the policy that you created

1. Open the [Policies page](#) of the IAM console.

2. Select the policy that you created (**AWSLambdaS3Policy**).
3. Choose **Policy actions, Delete**.
4. Choose **Delete**.

To delete the execution role

1. Open the [Roles page](#) of the IAM console.
2. Select the execution role that you created.
3. Choose **Delete**.
4. Enter the name of the role in the text input field and choose **Delete**.

To delete the S3 bucket

1. Open the [Amazon S3 console](#).
2. Select the bucket you created.
3. Choose **Delete**.
4. Enter the name of the bucket in the text input field.
5. Choose **Delete bucket**.

Using Lambda with Amazon SQS

Note

If you want to send data to a target other than a Lambda function or enrich the data before sending it, see [Amazon EventBridge Pipes](#).

You can use a Lambda function to process messages in an Amazon Simple Queue Service (Amazon SQS) queue. Lambda supports both [standard queues](#) and [first-in, first-out \(FIFO\) queues](#) for [event source mappings](#). The Lambda function and the Amazon SQS queue must be in the same AWS Region, although they can be in [different AWS accounts](#).

Topics

- [Understanding polling and batching behavior for Amazon SQS event source mappings](#)
- [Example standard queue message event](#)
- [Example FIFO queue message event](#)
- [Creating and configuring an Amazon SQS event source mapping](#)
- [Configuring scaling behavior for SQS event source mappings](#)
- [Handling errors for an SQS event source in Lambda](#)
- [Lambda parameters for Amazon SQS event source mappings](#)
- [Using event filtering with an Amazon SQS event source](#)
- [Tutorial: Using Lambda with Amazon SQS](#)
- [Tutorial: Using a cross-account Amazon SQS queue as an event source](#)

Understanding polling and batching behavior for Amazon SQS event source mappings

With Amazon SQS event source mappings, Lambda polls the queue and invokes your function [synchronously](#) with an event. Each event can contain a batch of multiple messages from the queue. Lambda receives these events one batch at a time, and invokes your function once for each batch. When your function successfully processes a batch, Lambda deletes its messages from the queue.

When Lambda receives a batch, the messages stay in the queue but are hidden for the length of the queue's [visibility timeout](#). If your function successfully processes all messages in the batch,

Lambda deletes the messages from the queue. By default, if your function encounters an error while processing a batch, all messages in that batch become visible in the queue again after the visibility timeout expires. For this reason, your function code must be able to process the same message multiple times without unintended side effects.

Warning

Lambda event source mappings process each event at least once, and duplicate processing of records can occur. To avoid potential issues related to duplicate events, we strongly recommend that you make your function code idempotent. To learn more, see [How do I make my Lambda function idempotent](#) in the AWS Knowledge Center.

To prevent Lambda from processing a message multiple times, you can either configure your event source mapping to include [batch item failures](#) in your function response, or you can use the [DeleteMessage](#) API to remove messages from the queue as your Lambda function successfully processes them.

For more information about configuration parameters that Lambda supports for SQS event source mappings, see [the section called “Creating an SQS event source mapping”](#).

Example standard queue message event

Example Amazon SQS message event (standard queue)

```
{
  "Records": [
    {
      "messageId": "059f36b4-87a3-44ab-83d2-661975830a7d",
      "receiptHandle": "AQEBwJnKyrHigUMZj6rYigCgxlaS3SLy0a...",
      "body": "Test message.",
      "attributes": {
        "ApproximateReceiveCount": "1",
        "SentTimestamp": "1545082649183",
        "SenderId": "AIDAIENQZJOL023YVJ4V0",
        "ApproximateFirstReceiveTimestamp": "1545082649185"
      },
      "messageAttributes": {
        "myAttribute": {
          "stringValue": "myValue",
```



```

        "stringListValues": [],
        "binaryListValues": [],
        "dataType": "String"
    }
},
"md5OfBody": "e4e68fb7bd0e697a0ae8f1bb342846b3",
"eventSource": "aws:sqs",
"eventSourceARN": "arn:aws:sqs:us-east-2:123456789012:my-queue",
"awsRegion": "us-east-2"
},
{
    "messageId": "2e1424d4-f796-459a-8184-9c92662be6da",
    "receiptHandle": "AQEBzWwafTRI0KuVm4tP+/7q1rGgNqicHq...",
    "body": "Test message.",
    "attributes": {
        "ApproximateReceiveCount": "1",
        "SentTimestamp": "1545082650636",
        "SenderId": "AIDAIENQZJOL023YVJ4V0",
        "ApproximateFirstReceiveTimestamp": "1545082650649"
    },
    "messageAttributes": {},
    "md5OfBody": "e4e68fb7bd0e697a0ae8f1bb342846b3",
    "eventSource": "aws:sqs",
    "eventSourceARN": "arn:aws:sqs:us-east-2:123456789012:my-queue",
    "awsRegion": "us-east-2"
}
]
}

```

By default, Lambda polls up to 10 messages in your queue at once and sends that batch to your function. To avoid invoking the function with a small number of records, you can configure the event source to buffer records for up to 5 minutes by configuring a batch window. Before invoking the function, Lambda continues to poll messages from the standard queue until the batch window expires, the [invocation payload size quota](#) is reached, or the configured maximum batch size is reached.

If you're using a batch window and your SQS queue contains very low traffic, Lambda might wait for up to 20 seconds before invoking your function. This is true even if you set a batch window lower than 20 seconds.

Note

In Java, you might experience null pointer errors when deserializing JSON. This could be due to how case of "Records" and "eventSourceARN" is converted by the JSON object mapper.

Example FIFO queue message event

For FIFO queues, records contain additional attributes that are related to deduplication and sequencing.

Example Amazon SQS message event (FIFO queue)

```
{
  "Records": [
    {
      "messageId": "11d6ee51-4cc7-4302-9e22-7cd8afdaadf5",
      "receiptHandle": "AQEBBX8nesZEXmkhsmZeyIE8iQAMig7qw...",
      "body": "Test message.",
      "attributes": {
        "ApproximateReceiveCount": "1",
        "SentTimestamp": "1573251510774",
        "SequenceNumber": "18849496460467696128",
        "MessageGroupId": "1",
        "SenderId": "AIDAI023YVJENQZJOL4V0",
        "MessageDeduplicationId": "1",
        "ApproximateFirstReceiveTimestamp": "1573251510774"
      },
      "messageAttributes": {},
      "md5ofBody": "e4e68fb7bd0e697a0ae8f1bb342846b3",
      "eventSource": "aws:sqs",
      "eventSourceARN": "arn:aws:sqs:us-east-2:123456789012:fifo.fifo",
      "awsRegion": "us-east-2"
    }
  ]
}
```

Creating and configuring an Amazon SQS event source mapping

To process Amazon SQS messages with Lambda, configure your queue with the appropriate settings, then create a Lambda event source mapping.

Configuring a queue to use with Lambda

If you don't already have an existing Amazon SQS queue, [create one](#) to serve as an event source for your Lambda function. The Lambda function and the Amazon SQS queue must be in the same AWS Region, although they can be in [different AWS accounts](#).

To allow your function time to process each batch of records, set the source queue's [visibility timeout](#) to at least six times the [configuration timeout](#) on your function. The extra time allows Lambda to retry if your function is throttled while processing a previous batch.

By default, if Lambda encounters an error at any point while processing a batch, all messages in that batch return to the queue. After the [visibility timeout](#), the messages become visible to Lambda again. You can configure your event source mapping to use [partial batch responses](#) to return only the failed messages back to the queue. In addition, if your function fails to process a message multiple times, Amazon SQS can send it to a [dead-letter queue](#). We recommend setting the `maxReceiveCount` on your source queue's [redrive policy](#) to at least 5. This gives Lambda a few chances to retry before sending failed messages directly to the dead-letter queue.

Setting up Lambda execution role permissions

The [AWSLambdaSQSQueueExecutionRole](#) AWS managed policy includes the permissions that Lambda needs to read from your Amazon SQS queue. You can add this managed policy to your function's [execution role](#).

Optionally, if you're using an encrypted queue, you also need to add the following permission to your execution role:

- [kms:Decrypt](#)

Creating an SQS event source mapping

Create an event source mapping to tell Lambda to send items from your queue to a Lambda function. You can create multiple event source mappings to process items from multiple queues with a single function. When Lambda invokes the target function, the event can contain multiple items, up to a configurable maximum *batch size*.

To configure your function to read from Amazon SQS, attach the [AWSLambdaSQSQueueExecutionRole](#) AWS managed policy to your execution role. Then, create an **SQS** event source mapping from the console using the following steps.

To add permissions and create a trigger

1. Open the [Functions page](#) of the Lambda console.
2. Choose the name of a function.
3. Choose the **Configuration** tab, and then choose **Permissions**.
4. Under **Role name**, choose the link to your execution role. This link opens the role in the IAM console.

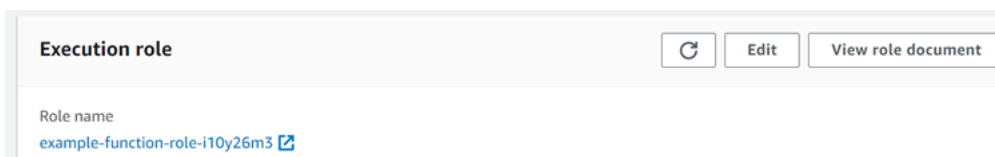

5. Choose **Add permissions**, and then choose **Attach policies**.

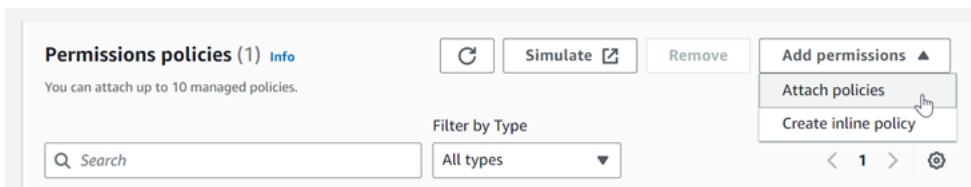

6. In the search field, enter `AWSLambdaSQSQueueExecutionRole`. Add this policy to your execution role. This is an AWS managed policy that contains the permissions your function needs to read from an Amazon SQS queue. For more information about this policy, see [AWSLambdaSQSQueueExecutionRole](#) in the *AWS Managed Policy Reference*.
7. Go back to your function in the Lambda console. Under **Function overview**, choose **Add trigger**.

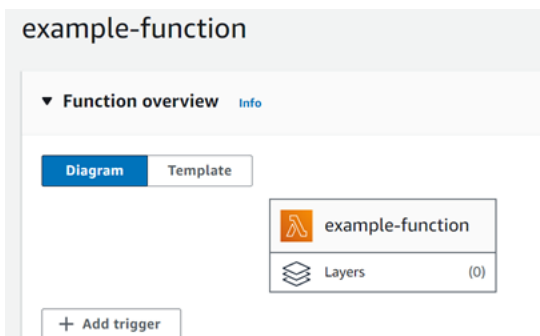

8. Choose a trigger type.
9. Configure the required options, and then choose **Add**.

Lambda supports the following configuration options for Amazon SQS event sources:

SQS queue

The Amazon SQS queue to read records from. The Lambda function and the Amazon SQS queue must be in the same AWS Region, although they can be in [different AWS accounts](#).

Enable trigger

The status of the event source mapping. **Enable trigger** is selected by default.

Batch size

The maximum number of records to send to the function in each batch. For a standard queue, this can be up to 10,000 records. For a FIFO queue, the maximum is 10. For a batch size over 10, you must also set the batch window (`MaximumBatchingWindowInSeconds`) to at least 1 second.

Configure your [function timeout](#) to allow enough time to process an entire batch of items. If items take a long time to process, choose a smaller batch size. A large batch size can improve efficiency for workloads that are very fast or have a lot of overhead. If you configure [reserved concurrency](#) on your function, set a minimum of five concurrent executions to reduce the chance of throttling errors when Lambda invokes your function.

Lambda passes all of the records in the batch to the function in a single call, as long as the total size of the events doesn't exceed the [invocation payload size quota](#) for synchronous invocation (6 MB). Both Lambda and Amazon SQS generate metadata for each record. This additional metadata is counted towards the total payload size and can cause the total number of records sent in a batch to be lower than your configured batch size. The metadata fields that Amazon SQS sends can be variable in length. For more information about the Amazon SQS metadata fields, see the [ReceiveMessage](#) API operation documentation in the *Amazon Simple Queue Service API Reference*.

Batch window

The maximum amount of time to gather records before invoking the function, in seconds. This applies only to standard queues.

If you're using a batch window greater than 0 seconds, you must account for the increased processing time in your queue's [visibility timeout](#). We recommend setting your queue's visibility timeout to six times your [function timeout](#), plus the value of

`MaximumBatchingWindowInSeconds`. This allows time for your Lambda function to process each batch of events and to retry in the event of a throttling error.

When messages become available, Lambda starts processing messages in batches. Lambda starts processing five batches at a time with five concurrent invocations of your function. If messages are still available, Lambda adds up to 300 more instances of your function a minute, up to a maximum of 1,000 function instances. To learn more about function scaling and concurrency, see [Lambda function scaling](#).

To process more messages, you can optimize your Lambda function for higher throughput. For more information, see [Understanding how AWS Lambda scales with Amazon SQS standard queues](#).

Maximum concurrency

The maximum number of concurrent functions that the event source can invoke. For more information, see [Configuring maximum concurrency for Amazon SQS event sources](#).

Filter criteria

Add filter criteria to control which events Lambda sends to your function for processing. For more information, see [Control which events Lambda sends to your function](#).

Configuring scaling behavior for SQS event source mappings

For standard queues, Lambda uses [long polling](#) to poll a queue until it becomes active. When messages are available, Lambda starts processing five batches at a time with five concurrent invocations of your function. If messages are still available, Lambda increases the number of processes that are reading batches by up to 300 more instances per minute. The maximum number of batches that an event source mapping can process simultaneously is 1,000.

For FIFO queues, Lambda sends messages to your function in the order that it receives them. When you send a message to a FIFO queue, you specify a [message group ID](#). Amazon SQS ensures that messages in the same group are delivered to Lambda in order. When Lambda reads your messages into batches, each batch may contain messages from more than one message group, but the order of the messages is maintained. If your function returns an error, the function attempts all retries on the affected messages before Lambda receives additional messages from the same group.

Configuring maximum concurrency for Amazon SQS event sources

You can use the maximum concurrency setting to control scaling behavior for your SQS event sources. The maximum concurrency setting limits the number of concurrent instances of the function that an Amazon SQS event source can invoke. Maximum concurrency is an event source-level setting. If you have multiple Amazon SQS event sources mapped to one function, each event source can have a separate maximum concurrency setting. You can use maximum concurrency to prevent one queue from using all of the function's [reserved concurrency](#) or the rest of the [account's concurrency quota](#). There is no charge for configuring maximum concurrency on an Amazon SQS event source.

Importantly, maximum concurrency and reserved concurrency are two independent settings. Don't set maximum concurrency higher than the function's reserved concurrency. If you configure maximum concurrency, make sure that your function's reserved concurrency is greater than or equal to the total maximum concurrency for all Amazon SQS event sources on the function. Otherwise, Lambda may throttle your messages.

When your account's concurrency quota is set to the default value of 1,000, an Amazon SQS event source mapping can scale to invoke function instances up to this value, unless you specify a maximum concurrency.

If you receive an increase to your account's default concurrency quota, Lambda may not be able to invoke concurrent function instances up to your new quota. By default, Lambda can scale to invoke up to 1,250 concurrent function instances for an Amazon SQS event source mapping. If this is insufficient for your use case, contact AWS support to discuss an increase to your account's Amazon SQS event source mapping concurrency.

Note

For FIFO queues, concurrent invocations are capped either by the number of [message group IDs](#) (`messageGroupId`) or the maximum concurrency setting—whichever is lower. For example, if you have six message group IDs and maximum concurrency is set to 10, your function can have a maximum of six concurrent invocations.

You can configure maximum concurrency on new and existing Amazon SQS event source mappings.

Configure maximum concurrency using the Lambda console

1. Open the [Functions page](#) of the Lambda console.
2. Choose the name of a function.
3. Under **Function overview**, choose **SQS**. This opens the **Configuration** tab.
4. Select the Amazon SQS trigger and choose **Edit**.
5. For **Maximum concurrency**, enter a number between 2 and 1,000. To turn off maximum concurrency, leave the box empty.
6. Choose **Save**.

Configure maximum concurrency using the AWS Command Line Interface (AWS CLI)

Use the [update-event-source-mapping](#) command with the `--scaling-config` option. Example:

```
aws lambda update-event-source-mapping \  
  --uuid "a1b2c3d4-5678-90ab-cdef-11111EXAMPLE" \  
  --scaling-config '{"MaximumConcurrency":5}'
```

To turn off maximum concurrency, enter an empty value for `--scaling-config`:

```
aws lambda update-event-source-mapping \  
  --uuid "a1b2c3d4-5678-90ab-cdef-11111EXAMPLE" \  
  --scaling-config "{}"
```

Configure maximum concurrency using the Lambda API

Use the [CreateEventSourceMapping](#) or [UpdateEventSourceMapping](#) action with a [ScalingConfig](#) object.

Handling errors for an SQS event source in Lambda

To handle errors related to an SQS event source, Lambda automatically uses a retry strategy with a backoff strategy. You can also customize error handling behavior by configuring your SQS event source mapping to return [partial batch responses](#).

Backoff strategy for failed invocations

When an invocation fails, Lambda attempts to retry the invocation while implementing a backoff strategy. The backoff strategy differs slightly depending on whether Lambda encountered the failure due to an error in your function code, or due to throttling.

- If your **function code** caused the error, Lambda will stop processing and retrying the invocation. In the meantime, Lambda gradually backs off, reducing the amount of concurrency allocated to your Amazon SQS event source mapping. After your queue's visibility timeout runs out, the message will again reappear in the queue.
- If the invocation fails due to **throttling**, Lambda gradually backs off retries by reducing the amount of concurrency allocated to your Amazon SQS event source mapping. Lambda continues to retry the message until the message's timestamp exceeds your queue's visibility timeout, at which point Lambda drops the message.

Implementing partial batch responses

When your Lambda function encounters an error while processing a batch, all messages in that batch become visible in the queue again by default, including messages that Lambda processed successfully. As a result, your function can end up processing the same message several times.

To avoid reprocessing successfully processed messages in a failed batch, you can configure your event source mapping to make only the failed messages visible again. This is called a partial batch response. To turn on partial batch responses, specify `ReportBatchItemFailures` for the [FunctionResponseTypes](#) action when configuring your event source mapping. This lets your function return a partial success, which can help reduce the number of unnecessary retries on records.

When `ReportBatchItemFailures` is activated, Lambda doesn't [scale down message polling](#) when function invocations fail. If you expect some messages to fail—and you don't want those failures to impact the message processing rate—use `ReportBatchItemFailures`.

Note

Keep the following in mind when using partial batch responses:

- If your function throws an exception, the entire batch is considered a complete failure.

- If you're using this feature with a FIFO queue, your function should stop processing messages after the first failure and return all failed and unprocessed messages in `batchItemFailures`. This helps preserve the ordering of messages in your queue.

To activate partial batch reporting

1. Review the [Best practices for implementing partial batch responses](#).
2. Run the following command to activate `ReportBatchItemFailures` for your function. To retrieve your event source mapping's UUID, run the [list-event-source-mappings](#) AWS CLI command.

```
aws lambda update-event-source-mapping \  
--uuid "a1b2c3d4-5678-90ab-cdef-11111EXAMPLE" \  
--function-response-types "ReportBatchItemFailures"
```

3. Update your function code to catch all exceptions and return failed messages in a `batchItemFailures` JSON response. The `batchItemFailures` response must include a list of message IDs, as `itemIdentifier` JSON values.

For example, suppose you have a batch of five messages, with message IDs `id1`, `id2`, `id3`, `id4`, and `id5`. Your function successfully processes `id1`, `id3`, and `id5`. To make messages `id2` and `id4` visible again in your queue, your function should return the following response:

```
{  
  "batchItemFailures": [  
    {  
      "itemIdentifier": "id2"  
    },  
    {  
      "itemIdentifier": "id4"  
    }  
  ]  
}
```

Here are some examples of function code that return the list of failed message IDs in the batch:

.NET

AWS SDK for .NET

Note

There's more on GitHub. Find the complete example and learn how to set up and run in the [Serverless examples](#) repository.

Reporting SQS batch item failures with Lambda using .NET.

```
// Copyright Amazon.com, Inc. or its affiliates. All Rights Reserved.
// SPDX-License-Identifier: Apache-2.0
using Amazon.Lambda.Core;
using Amazon.Lambda.SQSEvents;

// Assembly attribute to enable the Lambda function's JSON input to be
// converted into a .NET class.
[assembly:
    LambdaSerializer(typeof(Amazon.Lambda.Serialization.SystemTextJson.DefaultLambdaJsonSerializer))]
namespace sqsSample;

public class Function
{
    public async Task<SQSBatchResponse> FunctionHandler(SQSEvent evnt,
        ILambdaContext context)
    {
        List<SQSBatchResponse.BatchItemFailure> batchItemFailures = new
        List<SQSBatchResponse.BatchItemFailure>();
        foreach(var message in evnt.Records)
        {
            try
            {
                //process your message
                await ProcessMessageAsync(message, context);
            }
            catch (System.Exception)
            {
                //Add failed message identifier to the batchItemFailures list
            }
        }
    }
}
```

```
        batchItemFailures.Add(new
    SQSBatchResponse.BatchItemFailure{ItemIdentifier=message.MessageId});
    }
}
return new SQSBatchResponse(batchItemFailures);
}

private async Task ProcessMessageAsync(SQSEvent.SQSMessage message,
ILambdaContext context)
{
    if (String.IsNullOrEmpty(message.Body))
    {
        throw new Exception("No Body in SQS Message.");
    }
    context.Logger.LogInformation($"Processed message {message.Body}");
    // TODO: Do interesting work based on the new message
    await Task.CompletedTask;
}
}
```

Go

SDK for Go V2

Note

There's more on GitHub. Find the complete example and learn how to set up and run in the [Serverless examples](#) repository.

Reporting SQS batch item failures with Lambda using Go.

```
// Copyright Amazon.com, Inc. or its affiliates. All Rights Reserved.
// SPDX-License-Identifier: Apache-2.0
package main

import (
    "context"
    "encoding/json"
    "fmt"
    "github.com/aws/aws-lambda-go/events"
}
```

```
"github.com/aws/aws-lambda-go/lambda"
)

func handler(ctx context.Context, sqsEvent events.SQSEvent)
(map[string]interface{}, error) {
    batchItemFailures := []map[string]interface{}{}

    for _, message := range sqsEvent.Records {

        if /* Your message processing condition here */ {
            batchItemFailures = append(batchItemFailures, map[string]interface{}{
                "itemIdentifier": message.MessageId})
        }
    }

    sqsBatchResponse := map[string]interface{}{
        "batchItemFailures": batchItemFailures,
    }
    return sqsBatchResponse, nil
}

func main() {
    lambda.Start(handler)
}
```

Java

SDK for Java 2.x

Note

There's more on GitHub. Find the complete example and learn how to set up and run in the [Serverless examples](#) repository.

Reporting SQS batch item failures with Lambda using Java.

```
// Copyright Amazon.com, Inc. or its affiliates. All Rights Reserved.
// SPDX-License-Identifier: Apache-2.0
import com.amazonaws.services.lambda.runtime.Context;
```

```
import com.amazonaws.services.lambda.runtime.RequestHandler;
import com.amazonaws.services.lambda.runtime.events.SQSEvent;
import com.amazonaws.services.lambda.runtime.events.SQSBatchResponse;

import java.util.ArrayList;
import java.util.List;

public class ProcessSQSMessageBatch implements RequestHandler<SQSEvent,
    SQSBatchResponse> {
    @Override
    public SQSBatchResponse handleRequest(SQSEvent sqsEvent, Context context)
    {

        List<SQSBatchResponse.BatchItemFailure> batchItemFailures = new
        ArrayList<SQSBatchResponse.BatchItemFailure>();
        String messageId = "";
        for (SQSEvent.SQSMessage message : sqsEvent.getRecords()) {
            try {
                //process your message
                messageId = message.getMessageId();
            } catch (Exception e) {
                //Add failed message identifier to the batchItemFailures
                list
                batchItemFailures.add(new
                SQSBatchResponse.BatchItemFailure(messageId));
            }
        }
        return new SQSBatchResponse(batchItemFailures);
    }
}
```

JavaScript

SDK for JavaScript (v3)

Note

There's more on GitHub. Find the complete example and learn how to set up and run in the [Serverless examples](#) repository.

Reporting SQS batch item failures with Lambda using JavaScript.

```
// Node.js 20.x Lambda runtime, AWS SDK for Javascript V3
export const handler = async (event, context) => {
  const batchItemFailures = [];
  for (const record of event.Records) {
    try {
      await processMessageAsync(record, context);
    } catch (error) {
      batchItemFailures.push({ itemIdentifier: record.messageId });
    }
  }
  return { batchItemFailures };
};

async function processMessageAsync(record, context) {
  if (record.body && record.body.includes("error")) {
    throw new Error("There is an error in the SQS Message.");
  }
  console.log(`Processed message: ${record.body}`);
}
```

Reporting SQS batch item failures with Lambda using TypeScript.

```
// Copyright Amazon.com, Inc. or its affiliates. All Rights Reserved.
// SPDX-License-Identifier: Apache-2.0
import { SQSEvent, SQSBatchResponse, Context, SQSBatchItemFailure,
  SQSRecord } from 'aws-lambda';

export const handler = async (event: SQSEvent, context: Context):
  Promise<SQSBatchResponse> => {
  const batchItemFailures: SQSBatchItemFailure[] = [];

  for (const record of event.Records) {
    try {
      await processMessageAsync(record);
    } catch (error) {
      batchItemFailures.push({ itemIdentifier: record.messageId });
    }
  }
}
```

```
    return {batchItemFailures: batchItemFailures};
};

async function processMessageAsync(record: SQSRecord): Promise<void> {
    if (record.body && record.body.includes("error")) {
        throw new Error('There is an error in the SQS Message.');
```

```
    }
    console.log(`Processed message ${record.body}`);
}
```

PHP

SDK for PHP

Note

There's more on GitHub. Find the complete example and learn how to set up and run in the [Serverless examples](#) repository.

Reporting SQS batch item failures with Lambda using PHP.

```
// Copyright Amazon.com, Inc. or its affiliates. All Rights Reserved.
// SPDX-License-Identifier: Apache-2.0
<?php

use Bref\Context\Context;
use Bref\Event\Sqs\SqsEvent;
use Bref\Event\Sqs\SqsHandler;
use Bref\Logger\StderrLogger;

require __DIR__ . '/vendor/autoload.php';

class Handler extends SqsHandler
{
    private StderrLogger $logger;
    public function __construct(StderrLogger $logger)
    {
        $this->logger = $logger;
    }
}
```



```
/**
 * @throws JsonException
 * @throws \Bref\Event\InvalidLambdaEvent
 */
public function handleSqs(SqsEvent $event, Context $context): void
{
    $this->logger->info("Processing SQS records");
    $records = $event->getRecords();

    foreach ($records as $record) {
        try {
            // Assuming the SQS message is in JSON format
            $message = json_decode($record->getBody(), true);
            $this->logger->info(json_encode($message));
            // TODO: Implement your custom processing logic here
        } catch (Exception $e) {
            $this->logger->error($e->getMessage());
            // failed processing the record
            $this->markAsFailed($record);
        }
    }
    $totalRecords = count($records);
    $this->logger->info("Successfully processed $totalRecords SQS
records");
}

$logger = new StderrLogger();
return new Handler($logger);
```

Python

SDK for Python (Boto3)

Note

There's more on GitHub. Find the complete example and learn how to set up and run in the [Serverless examples](#) repository.

Reporting SQS batch item failures with Lambda using Python.

```
# Copyright Amazon.com, Inc. or its affiliates. All Rights Reserved.
# SPDX-License-Identifier: Apache-2.0

def lambda_handler(event, context):
    if event:
        batch_item_failures = []
        sqs_batch_response = {}

        for record in event["Records"]:
            try:
                # process message
            except Exception as e:
                batch_item_failures.append({"itemIdentifier":
record['messageId']})

        sqs_batch_response["batchItemFailures"] = batch_item_failures
        return sqs_batch_response
```

Ruby

SDK for Ruby

Note

There's more on GitHub. Find the complete example and learn how to set up and run in the [Serverless examples](#) repository.

Reporting SQS batch item failures with Lambda using Ruby.

```
# Copyright Amazon.com, Inc. or its affiliates. All Rights Reserved.
# SPDX-License-Identifier: Apache-2.0
require 'json'

def lambda_handler(event:, context:)
    if event
        batch_item_failures = []
```

```

sqs_batch_response = {}

event["Records"].each do |record|
  begin
    # process message
    rescue StandardError => e
      batch_item_failures << {"itemIdentifier" => record['messageId']}
    end
  end
end

sqs_batch_response["batchItemFailures"] = batch_item_failures
return sqs_batch_response
end
end

```

Rust

SDK for Rust

Note

There's more on GitHub. Find the complete example and learn how to set up and run in the [Serverless examples](#) repository.

Reporting SQS batch item failures with Lambda using Rust.

```

// Copyright Amazon.com, Inc. or its affiliates. All Rights Reserved.
// SPDX-License-Identifier: Apache-2.0
use aws_lambda_events::{
    event::sqs::{SqsBatchResponse, SqsEvent},
    sqs::{BatchItemFailure, SqsMessage},
};
use lambda_runtime::{run, service_fn, Error, LambdaEvent};

async fn process_record(_: &SqsMessage) -> Result<(), Error> {
    Err(Error::from("Error processing message"))
}

```

```
async fn function_handler(event: LambdaEvent<SqsEvent>) ->
    Result<SqsBatchResponse, Error> {
    let mut batch_item_failures = Vec::new();
    for record in event.payload.records {
        match process_record(&record).await {
            Ok(_) => (),
            Err(_) => batch_item_failures.push(BatchItemFailure {
                item_identifier: record.message_id.unwrap(),
            }),
        }
    }

    Ok(SqsBatchResponse {
        batch_item_failures,
    })
}

#[tokio::main]
async fn main() -> Result<(), Error> {
    run(service_fn(function_handler)).await
}
```

If the failed events do not return to the queue, see [How do I troubleshoot Lambda function SQS ReportBatchItemFailures?](#) in the AWS Knowledge Center.

Success and failure conditions

Lambda treats a batch as a complete success if your function returns any of the following:

- An empty `batchItemFailures` list
- A null `batchItemFailures` list
- An empty `EventResponse`
- A null `EventResponse`

Lambda treats a batch as a complete failure if your function returns any of the following:

- An invalid JSON response
- An empty string `itemIdentifier`
- A null `itemIdentifier`

- An `itemIdentifier` with a bad key name
- An `itemIdentifier` value with a message ID that doesn't exist

CloudWatch metrics

To determine whether your function is correctly reporting batch item failures, you can monitor the `NumberOfMessagesDeleted` and `ApproximateAgeOfOldestMessage` Amazon SQS metrics in Amazon CloudWatch.

- `NumberOfMessagesDeleted` tracks the number of messages removed from your queue. If this drops to 0, this is a sign that your function response is not correctly returning failed messages.
- `ApproximateAgeOfOldestMessage` tracks how long the oldest message has stayed in your queue. A sharp increase in this metric can indicate that your function is not correctly returning failed messages.

Lambda parameters for Amazon SQS event source mappings

All Lambda event source types share the same [CreateEventSourceMapping](#) and [UpdateEventSourceMapping](#) API operations. However, only some of the parameters apply to Amazon SQS.

Parameter	Required	Default	Notes
<code>BatchSize</code>	N	10	For standard queues, the maximum is 10,000. For FIFO queues, the maximum is 10.
<code>Enabled</code>	N	true	none
<code>EventSourceArn</code>	Y	N/A	The ARN of the data stream or a stream consumer
<code>FunctionName</code>	Y	N/A	none

Parameter	Required	Default	Notes
FilterCriteria	N	N/A	Control which events Lambda sends to your function
FunctionResponseTypes	N	N/A	To let your function report specific failures in a batch, include the value <code>ReportBatchItemFailures</code> in <code>FunctionResponseTypes</code> . For more information, see Implementing partial batch responses .
MaximumBatchingWindowInSeconds	N	0	Batching window is not supported for FIFO queues
ScalingConfig	N	N/A	Configuring maximum concurrency for Amazon SQS event sources

Using event filtering with an Amazon SQS event source

You can use event filtering to control which records from a stream or queue Lambda sends to your function. For general information about how event filtering works, see [the section called “Event filtering”](#).

This section focuses on event filtering for Amazon MSK event sources.

Topics

- [Amazon SQS event filtering basics](#)

Amazon SQS event filtering basics

Suppose your Amazon SQS queue contains messages in the following JSON format.

```
{
  "RecordNumber": 1234,
  "TimeStamp": "yyyy-mm-ddThh:mm:ss",
  "RequestCode": "AAAA"
}
```

An example record for this queue would look as follows.

```
{
  "messageId": "059f36b4-87a3-44ab-83d2-661975830a7d",
  "receiptHandle": "AQEBwJnKyrHigUMZj6rYigCgxlaS3SLy0a...",
  "body": "{\n \"RecordNumber\": 1234,\n \"TimeStamp\": \"yyyy-mm-ddThh:mm:ss\",\n\n\"RequestCode\": \"AAAA\"\n}",
  "attributes": {
    "ApproximateReceiveCount": "1",
    "SentTimestamp": "1545082649183",
    "SenderId": "AIDAIENQZJOL023YVJ4V0",
    "ApproximateFirstReceiveTimestamp": "1545082649185"
  },
  "messageAttributes": {},
  "md5fBody": "e4e68fb7bd0e697a0ae8f1bb342846b3",
  "eventSource": "aws:sqs",
  "eventSourceARN": "arn:aws:sqs:us-west-2:123456789012:my-queue",
  "awsRegion": "us-west-2"
}
```

To filter based on the contents of your Amazon SQS messages, use the `body` key in the Amazon SQS message record. Suppose you want to process only those records where the `RequestCode` in your Amazon SQS message is "BBBB." The `FilterCriteria` object would be as follows.

```
{
  "Filters": [
    {
      "Pattern": "{ \"body\" : { \"RequestCode\" : [ \"BBBB\" ] } }"
    }
  ]
}
```

```
]
}
```

For added clarity, here is the value of the filter's `Pattern` expanded in plain JSON.

```
{
  "body": {
    "RequestCode": [ "BBBB" ]
  }
}
```

You can add your filter using the console, AWS CLI or an AWS SAM template.

Console

To add this filter using the console, follow the instructions in [Attaching filter criteria to an event source mapping \(console\)](#) and enter the following string for the **Filter criteria**.

```
{ "body" : { "RequestCode" : [ "BBBB" ] } }
```

AWS CLI

To create a new event source mapping with these filter criteria using the AWS Command Line Interface (AWS CLI), run the following command.

```
aws lambda create-event-source-mapping \
  --function-name my-function \
  --event-source-arn arn:aws:sqs:us-east-2:123456789012:my-queue \
  --filter-criteria '{"Filters": [{"Pattern": "{ \"body\" : { \"RequestCode\" : [ \"BBBB\" ] } }"]}]'
```

To add these filter criteria to an existing event source mapping, run the following command.

```
aws lambda update-event-source-mapping \
  --uuid "a1b2c3d4-5678-90ab-cdef-11111EXAMPLE" \
  --filter-criteria '{"Filters": [{"Pattern": "{ \"body\" : { \"RequestCode\" : [ \"BBBB\" ] } }"]}]'
```

AWS SAM

To add this filter using AWS SAM, add the following snippet to the YAML template for your event source.

```
FilterCriteria:
  Filters:
    - Pattern: '{ "body" : { "RequestCode" : [ "BBBB" ] } }'
```

Suppose you want your function to process only those records where `RecordNumber` is greater than 9999. The `FilterCriteria` object would be as follows.

```
{
  "Filters": [
    {
      "Pattern": "{ \"body\" : { \"RecordNumber\" : [ { \"numeric\" : [ \">\",
9999 ] } ] } }"
    }
  ]
}
```

For added clarity, here is the value of the filter's `Pattern` expanded in plain JSON.

```
{
  "body": {
    "RecordNumber": [
      {
        "numeric": [ ">", 9999 ]
      }
    ]
  }
}
```

You can add your filter using the console, AWS CLI or an AWS SAM template.

Console

To add this filter using the console, follow the instructions in [Attaching filter criteria to an event source mapping \(console\)](#) and enter the following string for the **Filter criteria**.

```
{ "body" : { "RecordNumber" : [ { "numeric": [ ">", 9999 ] } ] } }
```

AWS CLI

To create a new event source mapping with these filter criteria using the AWS Command Line Interface (AWS CLI), run the following command.

```
aws lambda create-event-source-mapping \
  --function-name my-function \
  --event-source-arn arn:aws:sqs:us-east-2:123456789012:my-queue \
  --filter-criteria '{"Filters": [{"Pattern": "{ \"body\" : { \"RecordNumber\" : [ { \"numeric\" : [ \">\", 9999 ] } ] } }"]}]'
```

To add these filter criteria to an existing event source mapping, run the following command.

```
aws lambda update-event-source-mapping \
  --uuid "a1b2c3d4-5678-90ab-cdef-11111EXAMPLE" \
  --filter-criteria '{"Filters": [{"Pattern": "{ \"body\" : { \"RecordNumber\" : [ { \"numeric\" : [ \">\", 9999 ] } ] } }"]}]'
```

AWS SAM

To add this filter using AWS SAM, add the following snippet to the YAML template for your event source.

```
FilterCriteria:
  Filters:
    - Pattern: '{ "body" : { "RecordNumber" : [ { "numeric": [ ">", 9999 ] } ] } }'
```

For Amazon SQS, the message body can be any string. However, this can be problematic if your `FilterCriteria` expect body to be in a valid JSON format. The reverse scenario is also true—if the incoming message body is in JSON format but your filter criteria expects body to be a plain string, this can lead to unintended behavior.

To avoid this issue, ensure that the format of body in your `FilterCriteria` matches the expected format of body in messages that you receive from your queue. Before filtering your messages, Lambda automatically evaluates the format of the incoming message body and of your filter pattern for body. If there is a mismatch, Lambda drops the message. The following table summarizes this evaluation:

Incoming message body format	Filter pattern body format	Resulting action
Plain string	Plain string	Lambda filters based on your filter criteria.
Plain string	No filter pattern for data properties	Lambda filters (on the other metadata properties only) based on your filter criteria.
Plain string	Valid JSON	Lambda drops the message.
Valid JSON	Plain string	Lambda drops the message.
Valid JSON	No filter pattern for data properties	Lambda filters (on the other metadata properties only) based on your filter criteria.
Valid JSON	Valid JSON	Lambda filters based on your filter criteria.

Tutorial: Using Lambda with Amazon SQS

In this tutorial, you create a Lambda function that consumes messages from an [Amazon Simple Queue Service \(Amazon SQS\)](#) queue. The Lambda function runs whenever a new message is added to the queue. The function writes the messages to an Amazon CloudWatch Logs stream. The following diagram shows the AWS resources you use to complete the tutorial.

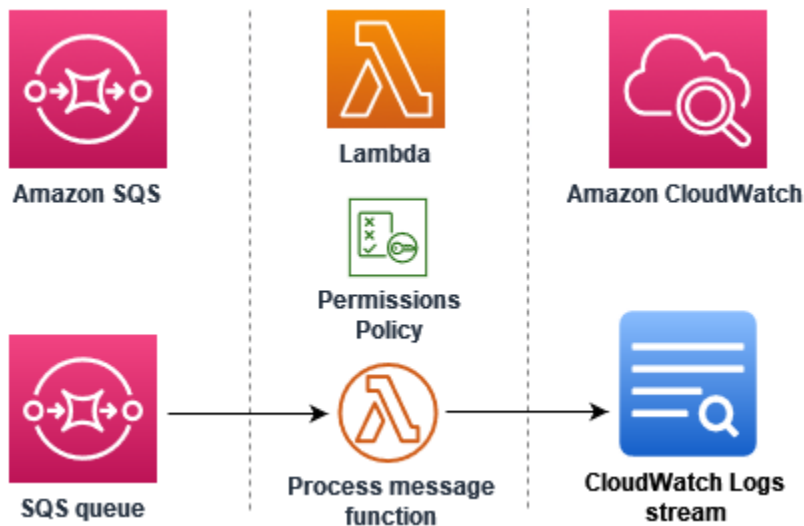

To complete this tutorial, you carry out the following steps:

1. Create a Lambda function that writes messages to CloudWatch Logs.
2. Create an Amazon SQS queue.
3. Create a Lambda event source mapping. The event source mapping reads the Amazon SQS queue and invokes your Lambda function when a new message is added.
4. Test the setup by adding messages to your queue and monitoring the results in CloudWatch Logs.

Prerequisites

Sign up for an AWS account

If you do not have an AWS account, complete the following steps to create one.

To sign up for an AWS account

1. Open <https://portal.aws.amazon.com/billing/signup>.
2. Follow the online instructions.

Part of the sign-up procedure involves receiving a phone call and entering a verification code on the phone keypad.

When you sign up for an AWS account, an *AWS account root user* is created. The root user has access to all AWS services and resources in the account. As a security best practice, assign

administrative access to a user, and use only the root user to perform [tasks that require root user access](#).

AWS sends you a confirmation email after the sign-up process is complete. At any time, you can view your current account activity and manage your account by going to <https://aws.amazon.com/> and choosing **My Account**.

Create a user with administrative access

After you sign up for an AWS account, secure your AWS account root user, enable AWS IAM Identity Center, and create an administrative user so that you don't use the root user for everyday tasks.

Secure your AWS account root user

1. Sign in to the [AWS Management Console](#) as the account owner by choosing **Root user** and entering your AWS account email address. On the next page, enter your password.

For help signing in by using root user, see [Signing in as the root user](#) in the *AWS Sign-In User Guide*.

2. Turn on multi-factor authentication (MFA) for your root user.

For instructions, see [Enable a virtual MFA device for your AWS account root user \(console\)](#) in the *IAM User Guide*.

Create a user with administrative access

1. Enable IAM Identity Center.

For instructions, see [Enabling AWS IAM Identity Center](#) in the *AWS IAM Identity Center User Guide*.

2. In IAM Identity Center, grant administrative access to a user.

For a tutorial about using the IAM Identity Center directory as your identity source, see [Configure user access with the default IAM Identity Center directory](#) in the *AWS IAM Identity Center User Guide*.

Sign in as the user with administrative access

- To sign in with your IAM Identity Center user, use the sign-in URL that was sent to your email address when you created the IAM Identity Center user.

For help signing in using an IAM Identity Center user, see [Signing in to the AWS access portal](#) in the *AWS Sign-In User Guide*.

Assign access to additional users

- In IAM Identity Center, create a permission set that follows the best practice of applying least-privilege permissions.

For instructions, see [Create a permission set](#) in the *AWS IAM Identity Center User Guide*.

- Assign users to a group, and then assign single sign-on access to the group.

For instructions, see [Add groups](#) in the *AWS IAM Identity Center User Guide*.

Install the AWS Command Line Interface

If you have not yet installed the AWS Command Line Interface, follow the steps at [Installing or updating the latest version of the AWS CLI](#) to install it.

The tutorial requires a command line terminal or shell to run commands. In Linux and macOS, use your preferred shell and package manager.

Note

In Windows, some Bash CLI commands that you commonly use with Lambda (such as `zip`) are not supported by the operating system's built-in terminals. To get a Windows-integrated version of Ubuntu and Bash, [install the Windows Subsystem for Linux](#).

Create the execution role

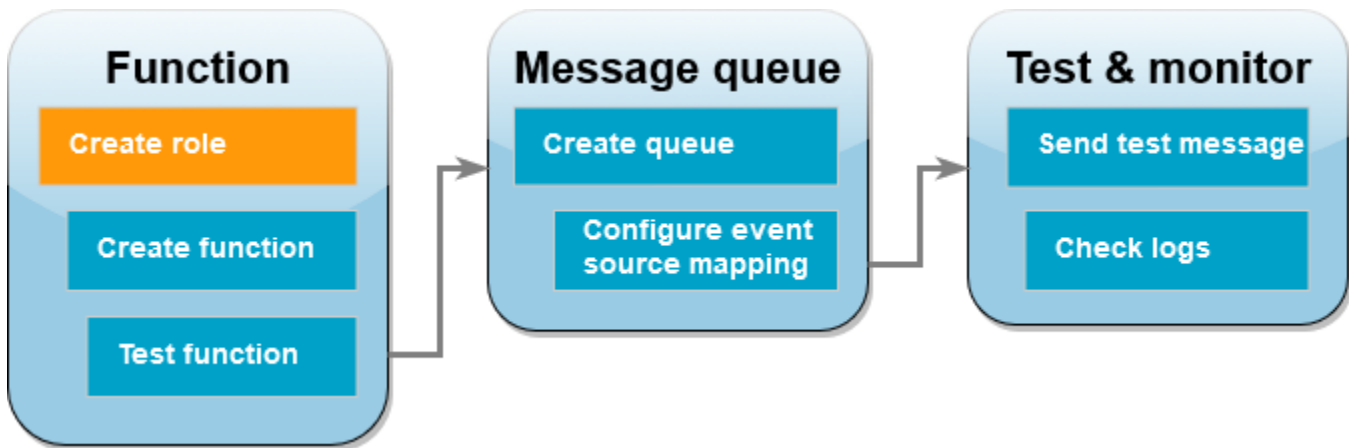

An [execution role](#) is an AWS Identity and Access Management (IAM) role that grants a Lambda function permission to access AWS services and resources. To allow your function to read items from Amazon SQS, attach the **AWSLambdaSQSQueueExecutionRole** permissions policy.

To create an execution role and attach an Amazon SQS permissions policy

1. Open the [Roles page](#) of the IAM console.
2. Choose **Create role**.
3. For **Trusted entity type**, choose **AWS service**.
4. For **Use case**, choose **Lambda**.
5. Choose **Next**.
6. In the **Permissions policies** search box, enter **AWSLambdaSQSQueueExecutionRole**.
7. Select the **AWSLambdaSQSQueueExecutionRole** policy, and then choose **Next**.
8. Under **Role details**, for **Role name**, enter **lambda-sqs-role**, then choose **Create role**.

After role creation, note down the Amazon Resource Name (ARN) of your execution role. You'll need it in later steps.

Create the function

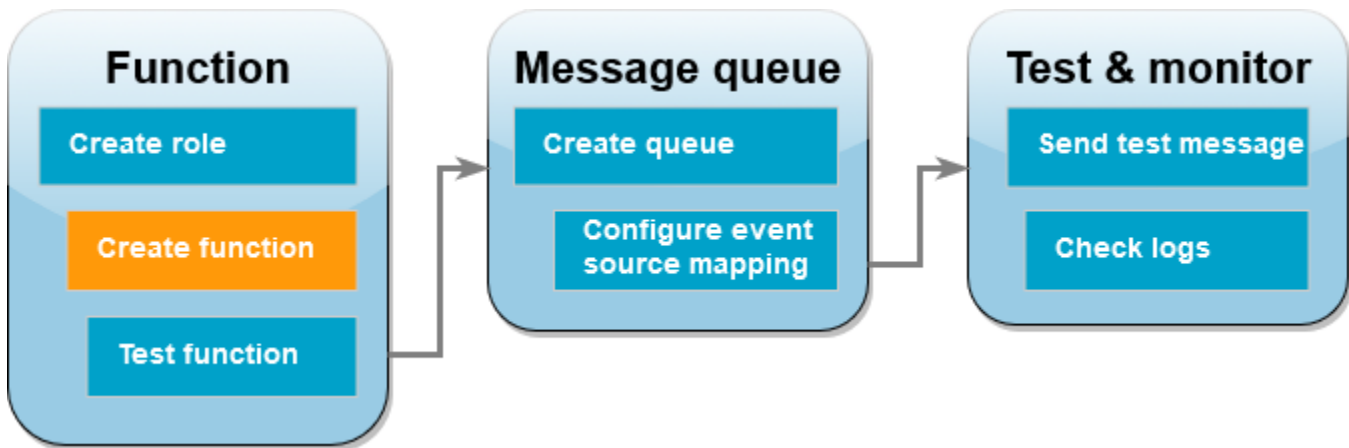

Create a Lambda function that processes your Amazon SQS messages. The function code logs the body of the Amazon SQS message to CloudWatch Logs.

This tutorial uses the Node.js 18.x runtime, but we've also provided example code in other runtime languages. You can select the tab in the following box to see code for the runtime you're interested in. The JavaScript code you'll use in this step is in the first example shown in the **JavaScript** tab.

.NET

AWS SDK for .NET

Note

There's more on GitHub. Find the complete example and learn how to set up and run in the [Serverless examples](#) repository.

Consuming an SQS event with Lambda using .NET.

```

// Copyright Amazon.com, Inc. or its affiliates. All Rights Reserved.
// SPDX-License-Identifier: Apache-2.0
using Amazon.Lambda.Core;
using Amazon.Lambda.SQSEvents;

// Assembly attribute to enable the Lambda function's JSON input to be converted
// into a .NET class.
[assembly: LambdaSerializer(typeof(Amazon.Lambda.Serialization.SystemTextJson.DefaultLambdaJsonSerializer))]
  
```



```
namespace SqsIntegrationSampleCode
{
    public async Task FunctionHandler(SQSEvent evnt, ILambdaContext context)
    {
        foreach (var message in evnt.Records)
        {
            await ProcessMessageAsync(message, context);
        }

        context.Logger.LogInformation("done");
    }

    private async Task ProcessMessageAsync(SQSEvent.SQSMessage message,
    ILambdaContext context)
    {
        try
        {
            context.Logger.LogInformation($"Processed message {message.Body}");

            // TODO: Do interesting work based on the new message
            await Task.CompletedTask;
        }
        catch (Exception e)
        {
            //You can use Dead Letter Queue to handle failures. By configuring a
            Lambda DLQ.
            context.Logger.LogError($"An error occurred");
            throw;
        }
    }
}
```

Go

SDK for Go V2

 **Note**

There's more on GitHub. Find the complete example and learn how to set up and run in the [Serverless examples](#) repository.

Consuming an SQS event with Lambda using Go.

```
// Copyright Amazon.com, Inc. or its affiliates. All Rights Reserved.
// SPDX-License-Identifier: Apache-2.0
package integration_sqs_to_lambda

import (
    "fmt"
    "github.com/aws/aws-lambda-go/events"
    "github.com/aws/aws-lambda-go/lambda"
)

func handler(event events.SQSEvent) error {
    for _, record := range event.Records {
        err := processMessage(record)
        if err != nil {
            return err
        }
    }
    fmt.Println("done")
    return nil
}

func processMessage(record events.SQSMessage) error {
    fmt.Printf("Processed message %s\n", record.Body)
    // TODO: Do interesting work based on the new message
    return nil
}

func main() {
    lambda.Start(handler)
}
```

Java

SDK for Java 2.x

Note

There's more on GitHub. Find the complete example and learn how to set up and run in the [Serverless examples](#) repository.

Consuming an SQS event with Lambda using Java.

```
// Copyright Amazon.com, Inc. or its affiliates. All Rights Reserved.
// SPDX-License-Identifier: Apache-2.0
import com.amazonaws.services.lambda.runtime.Context;
import com.amazonaws.services.lambda.runtime.RequestHandler;
import com.amazonaws.services.lambda.runtime.events.SQSEvent;
import com.amazonaws.services.lambda.runtime.events.SQSEvent.SQSMessage;

public class Function implements RequestHandler<SQSEvent, Void> {
    @Override
    public Void handleRequest(SQSEvent sqsEvent, Context context) {
        for (SQSMessage msg : sqsEvent.getRecords()) {
            processMessage(msg, context);
        }
        context.getLogger().log("done");
        return null;
    }

    private void processMessage(SQSMessage msg, Context context) {
        try {
            context.getLogger().log("Processed message " + msg.getBody());

            // TODO: Do interesting work based on the new message

        } catch (Exception e) {
            context.getLogger().log("An error occurred");
            throw e;
        }
    }
}
```

```
}  
}
```

JavaScript

SDK for JavaScript (v3)

Note

There's more on GitHub. Find the complete example and learn how to set up and run in the [Serverless examples](#) repository.

Consuming an SQS event with Lambda using JavaScript.

```
// Copyright Amazon.com, Inc. or its affiliates. All Rights Reserved.  
// SPDX-License-Identifier: Apache-2.0  
exports.handler = async (event, context) => {  
  for (const message of event.Records) {  
    await processMessageAsync(message);  
  }  
  console.info("done");  
};  
  
async function processMessageAsync(message) {  
  try {  
    console.log(`Processed message ${message.body}`);  
    // TODO: Do interesting work based on the new message  
    await Promise.resolve(1); //Placeholder for actual async work  
  } catch (err) {  
    console.error("An error occurred");  
    throw err;  
  }  
}
```

Consuming an SQS event with Lambda using TypeScript.

```
// Copyright Amazon.com, Inc. or its affiliates. All Rights Reserved.  
// SPDX-License-Identifier: Apache-2.0  
import { SQSEvent, Context, SQSHandler, SQSRecord } from "aws-lambda";
```

```
export const functionHandler: SQSHandler = async (
  event: SQSEvent,
  context: Context
): Promise<void> => {
  for (const message of event.Records) {
    await processMessageAsync(message);
  }
  console.info("done");
};

async function processMessageAsync(message: SQSRecord): Promise<any> {
  try {
    console.log(`Processed message ${message.body}`);
    // TODO: Do interesting work based on the new message
    await Promise.resolve(1); //Placeholder for actual async work
  } catch (err) {
    console.error("An error occurred");
    throw err;
  }
}
```

PHP

SDK for PHP

Note

There's more on GitHub. Find the complete example and learn how to set up and run in the [Serverless examples](#) repository.

Consuming an SQS event with Lambda using PHP.

```
// Copyright Amazon.com, Inc. or its affiliates. All Rights Reserved.
// SPDX-License-Identifier: Apache-2.0
<?php

# using bref/bref and bref/logger for simplicity

use Bref\Context\Context;
```

```
use Bref\Event\InvalidLambdaEvent;
use Bref\Event\Sqs\SqsEvent;
use Bref\Event\Sqs\SqsHandler;
use Bref\Logger\StderrLogger;

require __DIR__ . '/vendor/autoload.php';

class Handler extends SqsHandler
{
    private StderrLogger $logger;
    public function __construct(StderrLogger $logger)
    {
        $this->logger = $logger;
    }

    /**
     * @throws InvalidLambdaEvent
     */
    public function handleSqs(SqsEvent $event, Context $context): void
    {
        foreach ($event->getRecords() as $record) {
            $body = $record->getBody();
            // TODO: Do interesting work based on the new message
        }
    }
}

$logger = new StderrLogger();
return new Handler($logger);
```

Python

SDK for Python (Boto3)

Note

There's more on GitHub. Find the complete example and learn how to set up and run in the [Serverless examples](#) repository.

Consuming an SQS event with Lambda using Python.

```
# Copyright Amazon.com, Inc. or its affiliates. All Rights Reserved.
# SPDX-License-Identifier: Apache-2.0
def lambda_handler(event, context):
    for message in event['Records']:
        process_message(message)
    print("done")

def process_message(message):
    try:
        print(f"Processed message {message['body']}")
        # TODO: Do interesting work based on the new message
    except Exception as err:
        print("An error occurred")
        raise err
```

Ruby

SDK for Ruby

Note

There's more on GitHub. Find the complete example and learn how to set up and run in the [Serverless examples](#) repository.

Consuming an SQS event with Lambda using Ruby.

```
# Copyright Amazon.com, Inc. or its affiliates. All Rights Reserved.
# SPDX-License-Identifier: Apache-2.0
def lambda_handler(event:, context:)
    event['Records'].each do |message|
        process_message(message)
    end
    puts "done"
end

def process_message(message)
    begin
        puts "Processed message #{message['body']}"
        # TODO: Do interesting work based on the new message
    end
end
```

```
rescue StandardError => err
  puts "An error occurred"
  raise err
end
end
```

Rust

SDK for Rust

Note

There's more on GitHub. Find the complete example and learn how to set up and run in the [Serverless examples](#) repository.

Consuming an SQS event with Lambda using Rust.

```
// Copyright Amazon.com, Inc. or its affiliates. All Rights Reserved.
// SPDX-License-Identifier: Apache-2.0
use aws_lambda_events::event::sqs::SqsEvent;
use lambda_runtime::{run, service_fn, Error, LambdaEvent};

async fn function_handler(event: LambdaEvent<SqsEvent>) -> Result<(), Error> {
    event.payload.records.iter().for_each(|record| {
        // process the record
        tracing::info!("Message body: {}",
            record.body.as_deref().unwrap_or_default())
    });

    Ok(())
}

#[tokio::main]
async fn main() -> Result<(), Error> {
    tracing_subscriber::fmt()
        .with_max_level(tracing::Level::INFO)
        // disable printing the name of the module in every log line.
        .with_target(false)
        // disabling time is handy because CloudWatch will add the ingestion
        time.
        .without_time()
}
```



```
        .init();

    run(service_fn(function_handler)).await
}
```

To create a Node.js Lambda function

1. Create a directory for the project, and then switch to that directory.

```
mkdir sqs-tutorial
cd sqs-tutorial
```

2. Copy the sample JavaScript code into a new file named `index.js`.
3. Create a deployment package using the following `zip` command.

```
zip function.zip index.js
```

4. Create a Lambda function using the [create-function](#) AWS CLI command. For the `role` parameter, enter the ARN of the execution role that you created earlier.

Note

The Lambda function and the Amazon SQS queue must be in the same AWS Region.

```
aws lambda create-function --function-name ProcessSQSRecord \
--zip-file fileb://function.zip --handler index.handler --runtime nodejs18.x \
--role arn:aws:iam::111122223333:role/lambda-sqs-role
```

Test the function

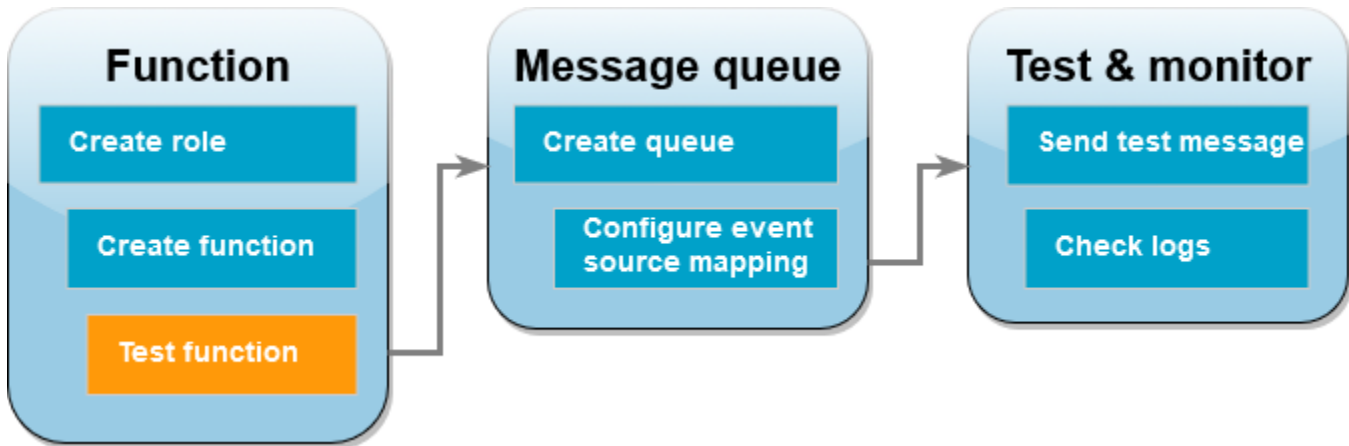

Invoke your Lambda function manually using the `invoke` AWS CLI command and a sample Amazon SQS event.

To invoke the Lambda function with a sample event

1. Save the following JSON as a file named `input.json`. This JSON simulates an event that Amazon SQS might send to your Lambda function, where `"body"` contains the actual message from the queue. In this example, the message is `"test"`.

Example Amazon SQS event

This is a test event—you don't need to change the message or the account number.

```

{
  "Records": [
    {
      "messageId": "059f36b4-87a3-44ab-83d2-661975830a7d",
      "receiptHandle": "AQEBwJnKyrHigUMZj6rYigCgxlaS3SLy0a...",
      "body": "test",
      "attributes": {
        "ApproximateReceiveCount": "1",
        "SentTimestamp": "1545082649183",
        "SenderId": "AIDAIENQZJOL023YVJ4V0",
        "ApproximateFirstReceiveTimestamp": "1545082649185"
      },
      "messageAttributes": {},
      "md5ofBody": "098f6bcd4621d373cade4e832627b4f6",
      "eventSource": "aws:sqs",
      "eventSourceARN": "arn:aws:sqs:us-east-1:111122223333:my-queue",
    }
  ]
}
  
```

```

    "awsRegion": "us-east-1"
  }
]
}

```

2. Run the following [invoke](#) AWS CLI command. This command returns CloudWatch logs in the response. For more information about retrieving logs, see [Access logs with the AWS CLI](#).

```

aws lambda invoke --function-name ProcessSQSRecord --payload file://input.json out
--log-type Tail \
--query 'LogResult' --output text --cli-binary-format raw-in-base64-out | base64 --
decode

```

The **cli-binary-format** option is required if you're using AWS CLI version 2. To make this the default setting, run `aws configure set cli-binary-format raw-in-base64-out`. For more information, see [AWS CLI supported global command line options](#) in the *AWS Command Line Interface User Guide for Version 2*.

3. Find the INFO log in the response. This is where the Lambda function logs the message body. You should see logs that look like this:

```

2023-09-11T22:45:04.271Z 348529ce-2211-4222-9099-59d07d837b60 INFO Processed
message test
2023-09-11T22:45:04.288Z 348529ce-2211-4222-9099-59d07d837b60 INFO done

```

Create an Amazon SQS queue

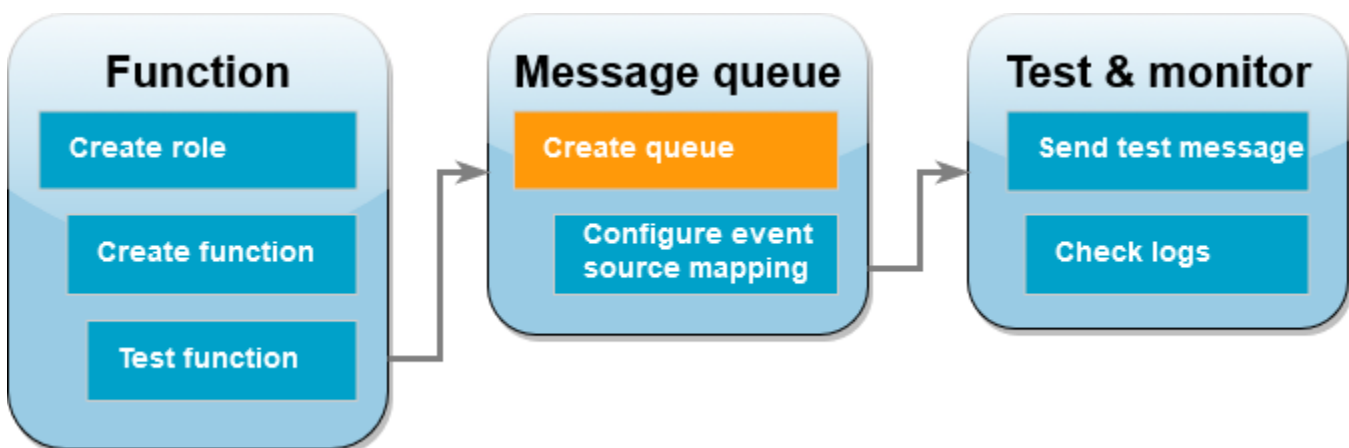

Create an Amazon SQS queue that the Lambda function can use as an event source. The Lambda function and the Amazon SQS queue must be in the same AWS Region.

To create a queue

1. Open the [Amazon SQS console](#).
2. Choose **Create queue**.
3. Enter a name for the queue. Leave all other options at the default settings.
4. Choose **Create queue**.

After creating the queue, note down its ARN. You need this in the next step when you associate the queue with your Lambda function.

Configure the event source

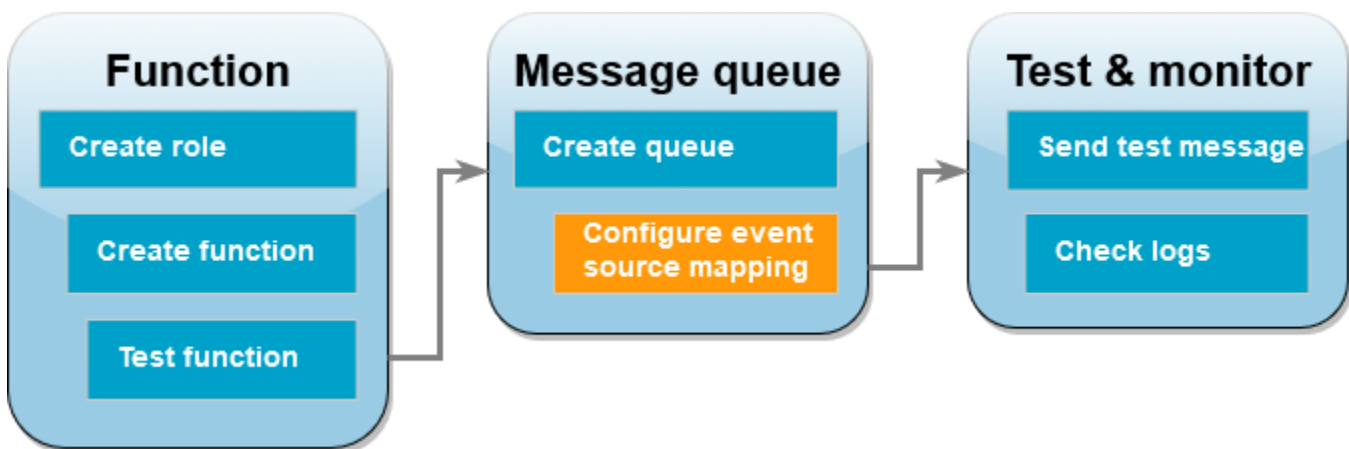

Connect the Amazon SQS queue to your Lambda function by creating an [event source mapping](#). The event source mapping reads the Amazon SQS queue and invokes your Lambda function when a new message is added.

To create a mapping between your Amazon SQS queue and your Lambda function, use the [create-event-source-mapping](#) AWS CLI command. Example:

```
aws lambda create-event-source-mapping --function-name ProcessSQSRecord --batch-size 10 \
--event-source-arn arn:aws:sqs:us-east-1:111122223333:my-queue
```

To get a list of your event source mappings, use the [list-event-source-mappings](#) command. Example:

```
aws lambda list-event-source-mappings --function-name ProcessSQSRecord
```

Send a test message

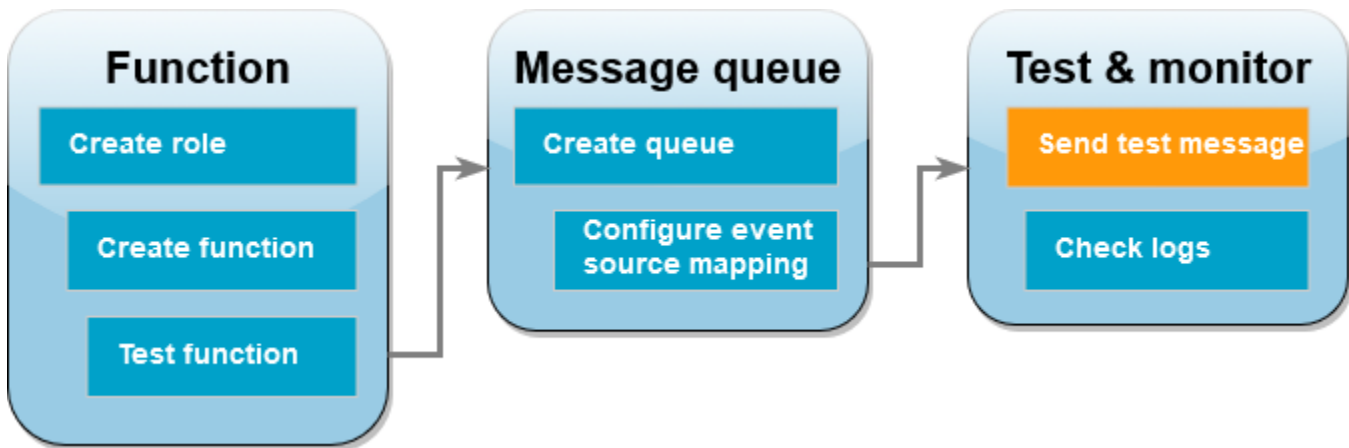

To send an Amazon SQS message to the Lambda function

1. Open the [Amazon SQS console](#).
2. Choose the queue that you created earlier.
3. Choose **Send and receive messages**.
4. Under **Message body**, enter a test message, such as "this is a test message."
5. Choose **Send message**.

Lambda polls the queue for updates. When there is a new message, Lambda invokes your function with this new event data from the queue. If the function handler returns without exceptions, Lambda considers the message successfully processed and begins reading new messages in the queue. After successfully processing a message, Lambda automatically deletes it from the queue. If the handler throws an exception, Lambda considers the batch of messages not successfully processed, and Lambda invokes the function with the same batch of messages.

Check the CloudWatch logs

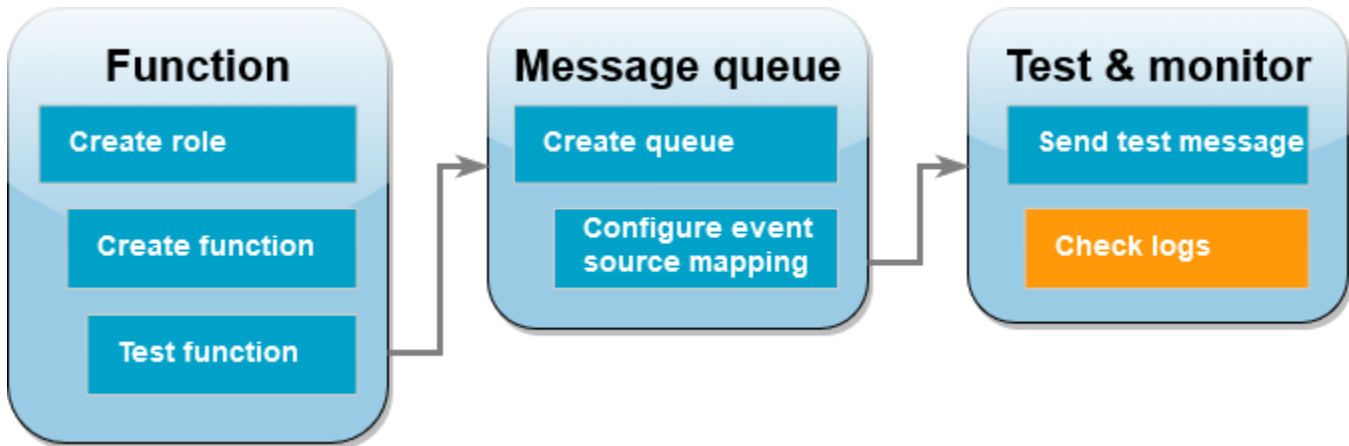

To confirm that the function processed the message

1. Open the [Functions page](#) of the Lambda console.
2. Choose the **ProcessSQSRecord** function.
3. Choose **Monitor**.
4. Choose **View CloudWatch logs**.
5. In the CloudWatch console, choose the **Log stream** for the function.
6. Find the INFO log. This is where the Lambda function logs the message body. You should see the message that you sent from the Amazon SQS queue. Example:

```
2023-09-11T22:49:12.730Z b0c41e9c-0556-5a8b-af83-43e59efeec71 INFO Processed message this is a test message.
```

Clean up your resources

You can now delete the resources that you created for this tutorial, unless you want to retain them. By deleting AWS resources that you're no longer using, you prevent unnecessary charges to your AWS account.

To delete the execution role

1. Open the [Roles page](#) of the IAM console.
2. Select the execution role that you created.
3. Choose **Delete**.

4. Enter the name of the role in the text input field and choose **Delete**.

To delete the Lambda function

1. Open the [Functions page](#) of the Lambda console.
2. Select the function that you created.
3. Choose **Actions, Delete**.
4. Type **confirm** in the text input field and choose **Delete**.

To delete the Amazon SQS queue

1. Sign in to the AWS Management Console and open the Amazon SQS console at <https://console.aws.amazon.com/sqs/>.
2. Select the queue you created.
3. Choose **Delete**.
4. Enter **confirm** in the text input field.
5. Choose **Delete**.

Tutorial: Using a cross-account Amazon SQS queue as an event source

In this tutorial, you create a Lambda function that consumes messages from an Amazon Simple Queue Service (Amazon SQS) queue in a different AWS account. This tutorial involves two AWS accounts: **Account A** refers to the account that contains your Lambda function, and **Account B** refers to the account that contains the Amazon SQS queue.

Prerequisites

This tutorial assumes that you have some knowledge of basic Lambda operations and the Lambda console. If you haven't already, follow the instructions in [Create a Lambda function with the console](#) to create your first Lambda function.

To complete the following steps, you need the [AWS CLI version 2](#). Commands and the expected output are listed in separate blocks:

```
aws --version
```

You should see the following output:

```
aws-cli/2.13.27 Python/3.11.6 Linux/4.14.328-248.540.amzn2.x86_64 exe/x86_64.amzn.2
```

For long commands, an escape character (\) is used to split a command over multiple lines.

On Linux and macOS, use your preferred shell and package manager.

Note

In Windows, some Bash CLI commands that you commonly use with Lambda (such as `zip`) are not supported by the operating system's built-in terminals. To get a Windows-integrated version of Ubuntu and Bash, [install the Windows Subsystem for Linux](#). Example CLI commands in this guide use Linux formatting. Commands which include inline JSON documents must be reformatted if you are using the Windows CLI.

Create the execution role (Account A)

In **Account A**, create an [execution role](#) that gives your function permission to access the required AWS resources.

To create an execution role

1. Open the [Roles page](#) in the AWS Identity and Access Management (IAM) console.
2. Choose **Create role**.
3. Create a role with the following properties.
 - **Trusted entity** – **AWS Lambda**
 - **Permissions** – **AWSLambdaSQSQueueExecutionRole**
 - **Role name** – **cross-account-lambda-sqs-role**

The **AWSLambdaSQSQueueExecutionRole** policy has the permissions that the function needs to read items from Amazon SQS and to write logs to Amazon CloudWatch Logs.

Create the function (Account A)

In **Account A**, create a Lambda function that processes your Amazon SQS messages. The Lambda function and the Amazon SQS queue must be in the same AWS Region.

The following Node.js 18 code example writes each message to a log in CloudWatch Logs.

Example `index.mjs`

```
export const handler = async function(event, context) {
  event.Records.forEach(record => {
    const { body } = record;
    console.log(body);
  });
  return {};
}
```

To create the function

Note

Following these steps creates a function in Node.js 18. For other languages, the steps are similar, but some details are different.

1. Save the code example as a file named `index.mjs`.
2. Create a deployment package.

```
zip function.zip index.mjs
```

3. Create the function using the `create-function` AWS Command Line Interface (AWS CLI) command.

```
aws lambda create-function --function-name CrossAccountSQSExample \  
--zip-file fileb://function.zip --handler index.handler --runtime nodejs18.x \  
--role arn:aws:iam::<AccountA_ID>:role/cross-account-lambda-sqs-role
```

Test the function (Account A)

In **Account A**, test your Lambda function manually using the `invoke` AWS CLI command and a sample Amazon SQS event.

If the handler returns normally without exceptions, Lambda considers the message to be successfully processed and begins reading new messages in the queue. After successfully

processing a message, Lambda automatically deletes it from the queue. If the handler throws an exception, Lambda considers the batch of messages not successfully processed, and Lambda invokes the function with the same batch of messages.

1. Save the following JSON as a file named `input.txt`.

```
{
  "Records": [
    {
      "messageId": "059f36b4-87a3-44ab-83d2-661975830a7d",
      "receiptHandle": "AQEBwJnKyrHigUMZj6rYigCgxlaS3SLy0a...",
      "body": "test",
      "attributes": {
        "ApproximateReceiveCount": "1",
        "SentTimestamp": "1545082649183",
        "SenderId": "AIDAIENQZJOL023YVJ4V0",
        "ApproximateFirstReceiveTimestamp": "1545082649185"
      },
      "messageAttributes": {},
      "md5OfBody": "098f6bcd4621d373cade4e832627b4f6",
      "eventSource": "aws:sqs",
      "eventSourceARN": "arn:aws:sqs:us-east-1:111122223333:example-queue",
      "awsRegion": "us-east-1"
    }
  ]
}
```

The preceding JSON simulates an event that Amazon SQS might send to your Lambda function, where "body" contains the actual message from the queue.

2. Run the following `invoke` AWS CLI command.

```
aws lambda invoke --function-name CrossAccountSQSExample \
  --cli-binary-format raw-in-base64-out \
  --payload file://input.txt outputfile.txt
```

The **cli-binary-format** option is required if you're using AWS CLI version 2. To make this the default setting, run `aws configure set cli-binary-format raw-in-base64-out`. For more information, see [AWS CLI supported global command line options](#) in the *AWS Command Line Interface User Guide for Version 2*.

3. Verify the output in the file `outputfile.txt`.

Create an Amazon SQS queue (Account B)

In **Account B**, create an Amazon SQS queue that the Lambda function in **Account A** can use as an event source. The Lambda function and the Amazon SQS queue must be in the same AWS Region.

To create a queue

1. Open the [Amazon SQS console](#).
2. Choose **Create queue**.
3. Create a queue with the following properties.
 - **Type** – **Standard**
 - **Name** – **LambdaCrossAccountQueue**
 - **Configuration** – Keep the default settings.
 - **Access policy** – Choose **Advanced**. Paste in the following JSON policy:

```
{
  "Version": "2012-10-17",
  "Id": "Queue1_Policy_UUID",
  "Statement": [{
    "Sid": "Queue1_AllActions",
    "Effect": "Allow",
    "Principal": {
      "AWS": [
        "arn:aws:iam::<AccountA_ID>:role/cross-account-lambda-sqs-role"
      ]
    },
    "Action": "sqs:*",
    "Resource": "arn:aws:sqs:us-east-1:<AccountB_ID>:LambdaCrossAccountQueue"
  ]
}
```

This policy grants the Lambda execution role in **Account A** permissions to consume messages from this Amazon SQS queue.

4. After creating the queue, record its Amazon Resource Name (ARN). You need this in the next step when you associate the queue with your Lambda function.

Configure the event source (Account A)

In **Account A**, create an event source mapping between the Amazon SQS queue in **Account B** and your Lambda function by running the following `create-event-source-mapping` AWS CLI command.

```
aws lambda create-event-source-mapping --function-name CrossAccountSQSExample --batch-size 10 \
--event-source-arn arn:aws:sqs:us-east-1:<AccountB_ID>:LambdaCrossAccountQueue
```

To get a list of your event source mappings, run the following command.

```
aws lambda list-event-source-mappings --function-name CrossAccountSQSExample \
--event-source-arn arn:aws:sqs:us-east-1:<AccountB_ID>:LambdaCrossAccountQueue
```

Test the setup

You can now test the setup as follows:

1. In **Account B**, open the [Amazon SQS console](#).
2. Choose **LambdaCrossAccountQueue**, which you created earlier.
3. Choose **Send and receive messages**.
4. Under **Message body**, enter a test message.
5. Choose **Send message**.

Your Lambda function in **Account A** should receive the message. Lambda will continue to poll the queue for updates. When there is a new message, Lambda invokes your function with this new event data from the queue. Your function runs and creates logs in Amazon CloudWatch. You can view the logs in the [CloudWatch console](#).

Clean up your resources

You can now delete the resources that you created for this tutorial, unless you want to retain them. By deleting AWS resources that you're no longer using, you prevent unnecessary charges to your AWS account.

In **Account A**, clean up your execution role and Lambda function.

To delete the execution role

1. Open the [Roles page](#) of the IAM console.
2. Select the execution role that you created.
3. Choose **Delete**.
4. Enter the name of the role in the text input field and choose **Delete**.

To delete the Lambda function

1. Open the [Functions page](#) of the Lambda console.
2. Select the function that you created.
3. Choose **Actions, Delete**.
4. Type **confirm** in the text input field and choose **Delete**.

In **Account B**, clean up the Amazon SQS queue.

To delete the Amazon SQS queue

1. Sign in to the AWS Management Console and open the Amazon SQS console at <https://console.aws.amazon.com/sqs/>.
2. Select the queue you created.
3. Choose **Delete**.
4. Enter **confirm** in the text input field.
5. Choose **Delete**.

Invoke a Lambda function with Amazon S3 batch events

You can use Amazon S3 batch operations to invoke a Lambda function on a large set of Amazon S3 objects. Amazon S3 tracks the progress of batch operations, sends notifications, and stores a completion report that shows the status of each action.

To run a batch operation, you create an Amazon S3 [batch operations job](#). When you create the job, you provide a manifest (the list of objects) and configure the action to perform on those objects.

When the batch job starts, Amazon S3 invokes the Lambda function [synchronously](#) for each object in the manifest. The event parameter includes the names of the bucket and the object.

The following example shows the event that Amazon S3 sends to the Lambda function for an object that is named **customerImage1.jpg** in the **amzn-s3-demo-bucket** bucket.

Example Amazon S3 batch request event

```
{
  "invocationSchemaVersion": "1.0",
  "invocationId": "YXNkbGZqYWRmaiBhc2RmdW9hZHNmZGpmaGFzbGtkaGZza2RmaAo",
  "job": {
    "id": "f3cc4f60-61f6-4a2b-8a21-d07600c373ce"
  },
  "tasks": [
    {
      "taskId": "dGFza2lkZ291c2h1cmUK",
      "s3Key": "customerImage1.jpg",
      "s3VersionId": "1",
      "s3BucketArn": "arn:aws:s3:::amzn-s3-demo-bucket"
    }
  ]
}
```

Your Lambda function must return a JSON object with the fields as shown in the following example. You can copy the `invocationId` and `taskId` from the event parameter. You can return a string in the `resultString`. Amazon S3 saves the `resultString` values in the completion report.

Example Amazon S3 batch request response

```
{
  "invocationSchemaVersion": "1.0",
  "treatMissingKeysAs" : "PermanentFailure",
  "invocationId" : "YXNkbGZqYWRmaiBhc2RmdW9hZHNmZGpmaGFzbGtkaGZza2RmaAo",
  "results": [
    {
      "taskId": "dGFza2lkZ291c2h1cmUK",
      "resultCode": "Succeeded",
      "resultString": "[\"Alice\", \"Bob\"]"
    }
  ]
}
```

Invoking Lambda functions from Amazon S3 batch operations

You can invoke the Lambda function with an unqualified or qualified function ARN. If you want to use the same function version for the entire batch job, configure a specific function version in the `FunctionARN` parameter when you create your job. If you configure an alias or the `$LATEST` qualifier, the batch job immediately starts calling the new version of the function if the alias or `$LATEST` is updated during the job execution.

Note that you can't reuse an existing Amazon S3 event-based function for batch operations. This is because the Amazon S3 batch operation passes a different event parameter to the Lambda function and expects a return message with a specific JSON structure.

In the [resource-based policy](#) that you create for the Amazon S3 batch job, ensure that you set permission for the job to invoke your Lambda function.

In the execution role for the function, set a [trust policy for Amazon S3 to assume the role when it runs your function](#).

If your function uses the AWS SDK to manage Amazon S3 resources, you need to add Amazon S3 permissions in the execution role.

When the job runs, Amazon S3 starts multiple function instances to process the Amazon S3 objects in parallel, up to the [concurrency limit](#) of the function. Amazon S3 limits the initial ramp-up of instances to avoid excess cost for smaller jobs.

If the Lambda function returns a `TemporaryFailure` response code, Amazon S3 retries the operation.

For more information about Amazon S3 batch operations, see [Performing batch operations](#) in the *Amazon S3 Developer Guide*.

For an example of how to use a Lambda function in Amazon S3 batch operations, see [Invoking a Lambda function from Amazon S3 batch operations](#) in the *Amazon S3 Developer Guide*.

Invoking Lambda functions with Amazon SNS notifications

You can use a Lambda function to process Amazon Simple Notification Service (Amazon SNS) notifications. Amazon SNS supports Lambda functions as a target for messages sent to a topic. You can subscribe your function to topics in the same account or in other AWS accounts. For a detailed walkthrough, see [the section called "Tutorial"](#).

Lambda supports SNS triggers for standard SNS topics only. FIFO topics aren't supported.

Lambda processes SNS messages asynchronously by queuing the messages and handling retries. If Amazon SNS can't reach Lambda or the message is rejected, Amazon SNS retries at increasing intervals over several hours. For details, see [Reliability](#) in the Amazon SNS FAQs.

Warning

Lambda event source mappings process each event at least once, and duplicate processing of records can occur. To avoid potential issues related to duplicate events, we strongly recommend that you make your function code idempotent. To learn more, see [How do I make my Lambda function idempotent](#) in the AWS Knowledge Center.

Topics

- [Adding an Amazon SNS topic trigger for a Lambda function using the console](#)
- [Manually adding an Amazon SNS topic trigger for a Lambda function](#)
- [Sample SNS event shape](#)
- [Tutorial: Using AWS Lambda with Amazon Simple Notification Service](#)

Adding an Amazon SNS topic trigger for a Lambda function using the console

To add an SNS topic as a trigger for a Lambda function, the easiest way is to use the Lambda console. When you add the trigger via the console, Lambda automatically sets up the necessary permissions and subscriptions to start receiving events from the SNS topic.

To add an SNS topic as a trigger for a Lambda function (console)

1. Open the [Functions page](#) of the Lambda console.

2. Choose the name of a function you want to add the trigger for.
3. Choose **Configuration**, and then choose **Triggers**.
4. Choose **Add trigger**.
5. Under **Trigger configuration**, in the dropdown menu, choose **SNS**.
6. For **SNS topic**, choose the SNS topic to subscribe to.

Manually adding an Amazon SNS topic trigger for a Lambda function

To set up an SNS trigger for a Lambda function manually, you need to complete the following steps:

- Define a resource-based policy for your function to allow SNS to invoke it.
- Subscribe your Lambda function to the Amazon SNS topic.

Note

If your SNS topic and your Lambda function are in different AWS accounts, you also need to grant extra permissions to allow cross-account subscriptions to the SNS topic. For more information, see [Grant cross-account permission for Amazon SNS subscription](#).

You can use the AWS Command Line Interface (AWS CLI) to complete both of these steps. First, to define a resource-based policy for a Lambda function that allows SNS invocations, use the following AWS CLI command. Be sure to replace the value of `--function-name` with your Lambda function name, and the value of `--source-arn` with your SNS topic ARN.

```
aws lambda add-permission --function-name example-function \  
  --source-arn arn:aws:sns:us-east-1:123456789012:sns-topic-for-lambda \  
  --statement-id function-with-sns --action "lambda:InvokeFunction" \  
  --principal sns.amazonaws.com
```

To subscribe your function to the SNS topic, use the following AWS CLI command. Replace the value of `--topic-arn` with your SNS topic ARN, and the value of `--notification-endpoint` with your Lambda function ARN.

```
aws sns subscribe --protocol lambda \  
  --region us-east-1 \  
  --topic-arn arn:aws:sns:us-east-1:123456789012:sns-topic-for-lambda \  
  --notification-endpoint arn:aws:lambda:us-east-1:123456789012:function:example-function
```

```
--topic-arn arn:aws:sns:us-east-1:123456789012:sns-topic-for-lambda \
--notification-endpoint arn:aws:lambda:us-east-1:123456789012:function:example-
function
```

Sample SNS event shape

Amazon SNS invokes your function [asynchronously](#) with an event that contains a message and metadata.

Example Amazon SNS message event

```
{
  "Records": [
    {
      "EventVersion": "1.0",
      "EventSubscriptionArn": "arn:aws:sns:us-east-1:123456789012:sns-lambda:21be56ed-
a058-49f5-8c98-aedd2564c486",
      "EventSource": "aws:sns",
      "Sns": {
        "SignatureVersion": "1",
        "Timestamp": "2019-01-02T12:45:07.000Z",
        "Signature": "tcc6faL2yUC6dgZdmrwh1Y4cGa/ebXEkAi6RibDsvpi+tE/1+82j...65r==",
        "SigningCertURL": "https://sns.us-east-1.amazonaws.com/
SimpleNotificationService-ac565b8b1a6c5d002d285f9598aa1d9b.pem",
        "MessageId": "95df01b4-ee98-5cb9-9903-4c221d41eb5e",
        "Message": "Hello from SNS!",
        "MessageAttributes": {
          "Test": {
            "Type": "String",
            "Value": "TestString"
          },
          "TestBinary": {
            "Type": "Binary",
            "Value": "TestBinary"
          }
        },
        "Type": "Notification",
        "UnsubscribeUrl": "https://sns.us-east-1.amazonaws.com/?
Action=Unsubscribe&SubscriptionArn=arn:aws:sns:us-east-1:123456789012:test-
lambda:21be56ed-a058-49f5-8c98-aedd2564c486",
        "TopicArn": "arn:aws:sns:us-east-1:123456789012:sns-lambda",
        "Subject": "TestInvoke"
      }
    }
  ]
}
```

```

    }
  ]
}

```

Tutorial: Using AWS Lambda with Amazon Simple Notification Service

In this tutorial, you use a Lambda function in one AWS account to subscribe to an Amazon Simple Notification Service (Amazon SNS) topic in a separate AWS account. When you publish messages to your Amazon SNS topic, your Lambda function reads the contents of the message and outputs it to Amazon CloudWatch Logs. To complete this tutorial, you use the AWS Command Line Interface (AWS CLI).

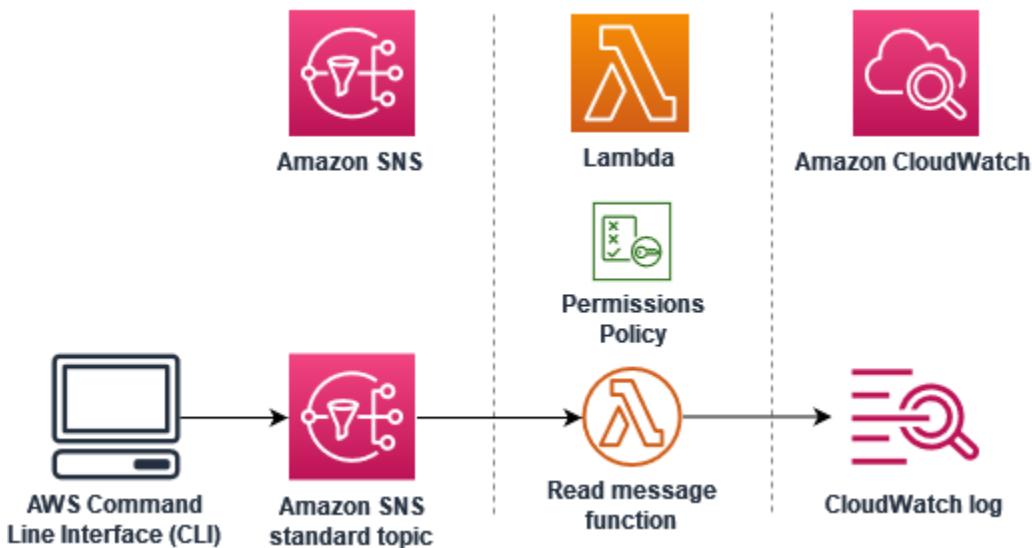

To complete this tutorial, you perform the following steps:

- In **account A**, create an Amazon SNS topic.
- In **account B**, create a Lambda function that will read messages from the topic.
- In **account B**, create a subscription to the topic.
- Publish messages to the Amazon SNS topic in **account A** and confirm that the Lambda function in **account B** outputs them to CloudWatch Logs.

By completing these steps, you will learn how to configure an Amazon SNS topic to invoke a Lambda function. You will also learn how to create an AWS Identity and Access Management (IAM) policy that gives permission for a resource in another AWS account to invoke Lambda.

In the tutorial, you use two separate AWS accounts. The AWS CLI commands illustrate this by using two named profiles called `accountA` and `accountB`, each configured for use with a different AWS

account. To learn how to configure the AWS CLI to use different profiles, see [Configuration and credential file settings](#) in the *AWS Command Line Interface User Guide for Version 2*. Be sure to configure the same default AWS Region for both profiles.

If the AWS CLI profiles you create for the two AWS accounts use different names, or if you use the default profile and one named profile, modify the AWS CLI commands in the following steps as needed.

Prerequisites

Sign up for an AWS account

If you do not have an AWS account, complete the following steps to create one.

To sign up for an AWS account

1. Open <https://portal.aws.amazon.com/billing/signup>.
2. Follow the online instructions.

Part of the sign-up procedure involves receiving a phone call and entering a verification code on the phone keypad.

When you sign up for an AWS account, an *AWS account root user* is created. The root user has access to all AWS services and resources in the account. As a security best practice, assign administrative access to a user, and use only the root user to perform [tasks that require root user access](#).

AWS sends you a confirmation email after the sign-up process is complete. At any time, you can view your current account activity and manage your account by going to <https://aws.amazon.com/> and choosing **My Account**.

Create a user with administrative access

After you sign up for an AWS account, secure your AWS account root user, enable AWS IAM Identity Center, and create an administrative user so that you don't use the root user for everyday tasks.

Secure your AWS account root user

1. Sign in to the [AWS Management Console](#) as the account owner by choosing **Root user** and entering your AWS account email address. On the next page, enter your password.

For help signing in by using root user, see [Signing in as the root user](#) in the *AWS Sign-In User Guide*.

2. Turn on multi-factor authentication (MFA) for your root user.

For instructions, see [Enable a virtual MFA device for your AWS account root user \(console\)](#) in the *IAM User Guide*.

Create a user with administrative access

1. Enable IAM Identity Center.

For instructions, see [Enabling AWS IAM Identity Center](#) in the *AWS IAM Identity Center User Guide*.

2. In IAM Identity Center, grant administrative access to a user.

For a tutorial about using the IAM Identity Center directory as your identity source, see [Configure user access with the default IAM Identity Center directory](#) in the *AWS IAM Identity Center User Guide*.

Sign in as the user with administrative access

- To sign in with your IAM Identity Center user, use the sign-in URL that was sent to your email address when you created the IAM Identity Center user.

For help signing in using an IAM Identity Center user, see [Signing in to the AWS access portal](#) in the *AWS Sign-In User Guide*.

Assign access to additional users

1. In IAM Identity Center, create a permission set that follows the best practice of applying least-privilege permissions.

For instructions, see [Create a permission set](#) in the *AWS IAM Identity Center User Guide*.

2. Assign users to a group, and then assign single sign-on access to the group.

For instructions, see [Add groups](#) in the *AWS IAM Identity Center User Guide*.

Install the AWS Command Line Interface

If you have not yet installed the AWS Command Line Interface, follow the steps at [Installing or updating the latest version of the AWS CLI](#) to install it.

The tutorial requires a command line terminal or shell to run commands. In Linux and macOS, use your preferred shell and package manager.

Note

In Windows, some Bash CLI commands that you commonly use with Lambda (such as `zip`) are not supported by the operating system's built-in terminals. To get a Windows-integrated version of Ubuntu and Bash, [install the Windows Subsystem for Linux](#).

Create an Amazon SNS topic (account A)

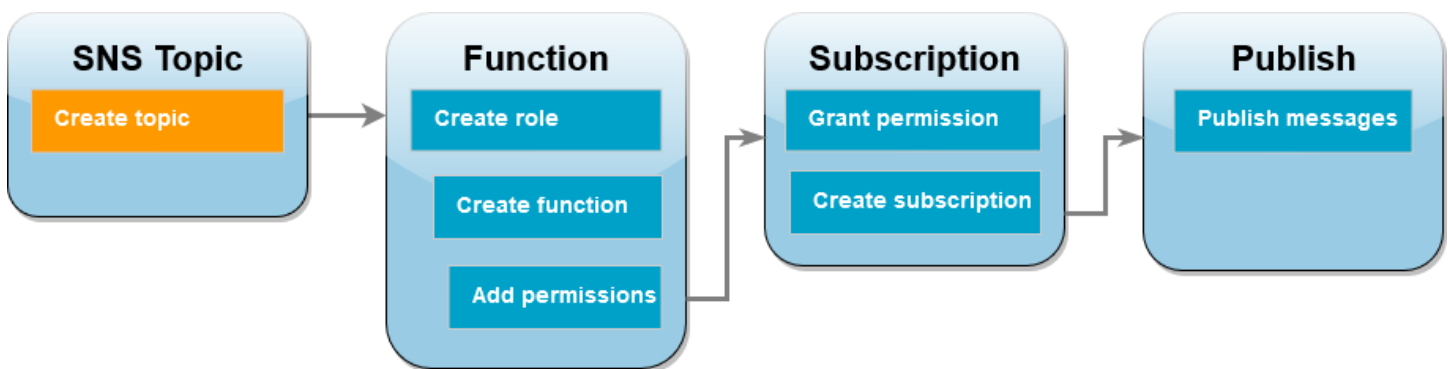

To create the topic

- In **account A**, create an Amazon SNS standard topic using the following AWS CLI command.

```
aws sns create-topic --name sns-topic-for-lambda --profile accountA
```

You should see output similar to the following.

```
{
  "TopicArn": "arn:aws:sns:us-west-2:123456789012:sns-topic-for-lambda"
}
```

Make a note of the Amazon Resource Name (ARN) of your topic. You'll need it later in the tutorial when you add permissions to your Lambda function to subscribe to the topic.

Create a function execution role (account B)

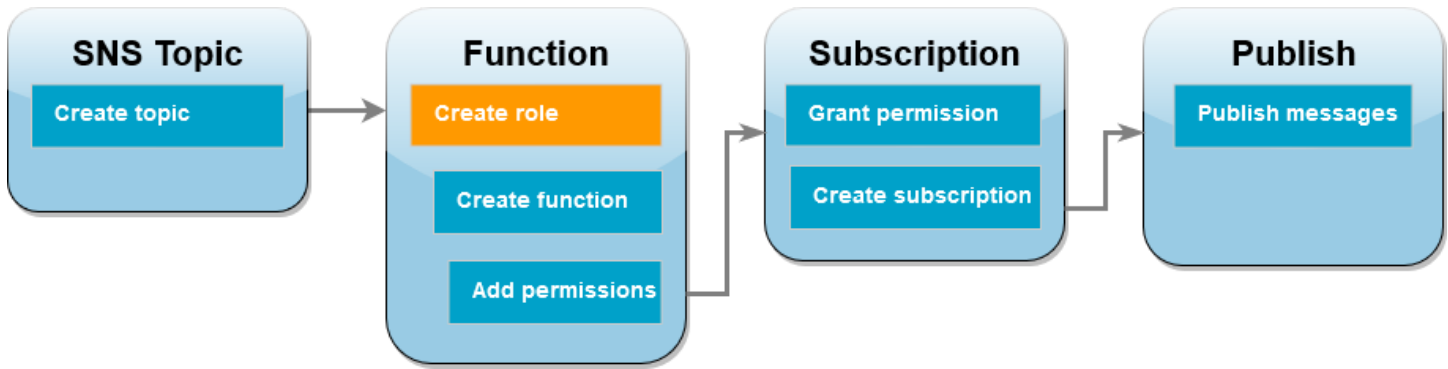

An execution role is an IAM role that grants a Lambda function permission to access AWS services and resources. Before you create your function in **account B**, you create a role that gives the function basic permissions to write logs to CloudWatch Logs. We'll add the permissions to read from your Amazon SNS topic in a later step.

To create an execution role

1. In **account B** open the [roles page](#) in the IAM console.
2. Choose **Create role**.
3. For **Trusted entity type**, choose **AWS service**.
4. For **Use case**, choose **Lambda**.
5. Choose **Next**.
6. Add a basic permissions policy to the role by doing the following:
 - a. In the **Permissions policies** search box, enter **AWSLambdaBasicExecutionRole**.
 - b. Choose **Next**.
7. Finalize the role creation by doing the following:
 - a. Under **Role details**, enter **lambda-sns-role** for **Role name**.
 - b. Choose **Create role**.

Create a Lambda function (account B)

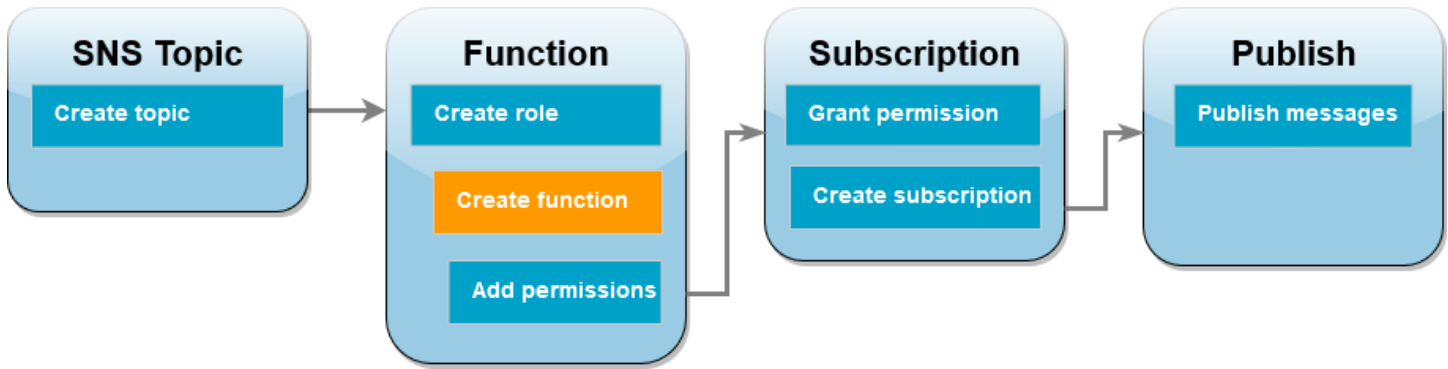

Create a Lambda function that processes your Amazon SNS messages. The function code logs the message contents of each record to Amazon CloudWatch Logs.

This tutorial uses the Node.js 18.x runtime, but we've also provided example code in other runtime languages. You can select the tab in the following box to see code for the runtime you're interested in. The JavaScript code you'll use in this step is in the first example shown in the **JavaScript** tab.

.NET

AWS SDK for .NET

Note

There's more on GitHub. Find the complete example and learn how to set up and run in the [Serverless examples](#) repository.

Consuming an SNS event with Lambda using .NET.

```

// Copyright Amazon.com, Inc. or its affiliates. All Rights Reserved.
// SPDX-License-Identifier: Apache-2.0
using Amazon.Lambda.Core;
using Amazon.Lambda.SNSEvents;

// Assembly attribute to enable the Lambda function's JSON input to be converted
// into a .NET class.
[assembly:
    LambdaSerializer(typeof(Amazon.Lambda.Serialization.SystemTextJson.DefaultLambdaJsonSerializer))]

namespace SnsIntegration;
  
```

```
public class Function
{
    public async Task FunctionHandler(SNSEvent evnt, ILambdaContext context)
    {
        foreach (var record in evnt.Records)
        {
            await ProcessRecordAsync(record, context);
        }
        context.Logger.LogInformation("done");
    }

    private async Task ProcessRecordAsync(SNSEvent.SNSRecord record,
    ILambdaContext context)
    {
        try
        {
            context.Logger.LogInformation($"Processed record
    {record.Sns.Message}");

            // TODO: Do interesting work based on the new message
            await Task.CompletedTask;
        }
        catch (Exception e)
        {
            //You can use Dead Letter Queue to handle failures. By configuring a
    Lambda DLQ.
            context.Logger.LogError($"An error occurred");
            throw;
        }
    }
}
```

Go

SDK for Go V2

Note

There's more on GitHub. Find the complete example and learn how to set up and run in the [Serverless examples](#) repository.

Consuming an SNS event with Lambda using Go.

```
// Copyright Amazon.com, Inc. or its affiliates. All Rights Reserved.
// SPDX-License-Identifier: Apache-2.0
package main

import (
    "context"
    "fmt"

    "github.com/aws/aws-lambda-go/events"
    "github.com/aws/aws-lambda-go/lambda"
)

func handler(ctx context.Context, snsEvent events.SNSEvent) {
    for _, record := range snsEvent.Records {
        processMessage(record)
    }
    fmt.Println("done")
}

func processMessage(record events.SNSEventRecord) {
    message := record.SNS.Message
    fmt.Printf("Processed message: %s\n", message)
    // TODO: Process your record here
}

func main() {
    lambda.Start(handler)
}
```

Java

SDK for Java 2.x

Note

There's more on GitHub. Find the complete example and learn how to set up and run in the [Serverless examples](#) repository.

Consuming an SNS event with Lambda using Java.

```
// Copyright Amazon.com, Inc. or its affiliates. All Rights Reserved.
// SPDX-License-Identifier: Apache-2.0
package example;

import com.amazonaws.services.lambda.runtime.Context;
import com.amazonaws.services.lambda.runtime.LambdaLogger;
import com.amazonaws.services.lambda.runtime.RequestHandler;
import com.amazonaws.services.lambda.runtime.events.SNSEvent;
import com.amazonaws.services.lambda.runtime.events.SNSEvent.SNSRecord;

import java.util.Iterator;
import java.util.List;

public class SNSEventHandler implements RequestHandler<SNSEvent, Boolean> {
    LambdaLogger logger;

    @Override
    public Boolean handleRequest(SNSEvent event, Context context) {
        logger = context.getLogger();
        List<SNSRecord> records = event.getRecords();
        if (!records.isEmpty()) {
            Iterator<SNSRecord> recordsIter = records.iterator();
            while (recordsIter.hasNext()) {
                processRecord(recordsIter.next());
            }
        }
        return Boolean.TRUE;
    }

    public void processRecord(SNSRecord record) {
        try {
            String message = record.getSNS().getMessage();
            logger.log("message: " + message);
        } catch (Exception e) {
            throw new RuntimeException(e);
        }
    }
}
```

JavaScript

SDK for JavaScript (v3)

Note

There's more on GitHub. Find the complete example and learn how to set up and run in the [Serverless examples](#) repository.

Consuming an SNS event with Lambda using JavaScript.

```
// Copyright Amazon.com, Inc. or its affiliates. All Rights Reserved.
// SPDX-License-Identifier: Apache-2.0
exports.handler = async (event, context) => {
  for (const record of event.Records) {
    await processMessageAsync(record);
  }
  console.info("done");
};

async function processMessageAsync(record) {
  try {
    const message = JSON.stringify(record.Sns.Message);
    console.log(`Processed message ${message}`);
    await Promise.resolve(1); //Placeholder for actual async work
  } catch (err) {
    console.error("An error occurred");
    throw err;
  }
}
```

Consuming an SNS event with Lambda using TypeScript.

```
// Copyright Amazon.com, Inc. or its affiliates. All Rights Reserved.
// SPDX-License-Identifier: Apache-2.0
import { SNSEvent, Context, SNSHandler, SNSEventRecord } from "aws-lambda";
```

```
export const functionHandler: SNSHandler = async (
  event: SNSEvent,
  context: Context
): Promise<void> => {
  for (const record of event.Records) {
    await processMessageAsync(record);
  }
  console.info("done");
};

async function processMessageAsync(record: SNSEventRecord): Promise<any> {
  try {
    const message: string = JSON.stringify(record.Sns.Message);
    console.log(`Processed message ${message}`);
    await Promise.resolve(1); //Placeholder for actual async work
  } catch (err) {
    console.error("An error occurred");
    throw err;
  }
}
```

PHP

SDK for PHP

Note

There's more on GitHub. Find the complete example and learn how to set up and run in the [Serverless examples](#) repository.

Consuming an SNS event with Lambda using PHP.

```
// Copyright Amazon.com, Inc. or its affiliates. All Rights Reserved.
// SPDX-License-Identifier: Apache-2.0
<?php

/*
Since native PHP support for AWS Lambda is not available, we are utilizing Bref's
PHP functions runtime for AWS Lambda.
```

For more information on Bref's PHP runtime for Lambda, refer to: <https://bref.sh/docs/runtimes/function>

Another approach would be to create a custom runtime.

A practical example can be found here: <https://aws.amazon.com/blogs/apn/aws-lambda-custom-runtime-for-php-a-practical-example/>

```
*/
```

```
// Additional composer packages may be required when using Bref or any other PHP functions runtime.
```

```
// require __DIR__ . '/vendor/autoload.php';
```

```
use Bref\Context\Context;
use Bref\Event\Sns\SnsEvent;
use Bref\Event\Sns\SnsHandler;
```

```
class Handler extends SnsHandler
```

```
{
```

```
    public function handleSns(SnsEvent $event, Context $context): void
```

```
    {
```

```
        foreach ($event->getRecords() as $record) {
```

```
            $message = $record->getMessage();
```

```
            // TODO: Implement your custom processing logic here
```

```
            // Any exception thrown will be logged and the invocation will be marked as failed
```

```
            echo "Processed Message: $message" . PHP_EOL;
```

```
        }
```

```
    }
```

```
}
```

```
return new Handler();
```

Python

SDK for Python (Boto3)

Note

There's more on GitHub. Find the complete example and learn how to set up and run in the [Serverless examples](#) repository.

Consuming an SNS event with Lambda using Python.

```
# Copyright Amazon.com, Inc. or its affiliates. All Rights Reserved.
# SPDX-License-Identifier: Apache-2.0
def lambda_handler(event, context):
    for record in event['Records']:
        process_message(record)
    print("done")

def process_message(record):
    try:
        message = record['Sns']['Message']
        print(f"Processed message {message}")
        # TODO; Process your record here

    except Exception as e:
        print("An error occurred")
        raise e
```

Ruby

SDK for Ruby

Note

There's more on GitHub. Find the complete example and learn how to set up and run in the [Serverless examples](#) repository.

Consuming an SNS event with Lambda using Ruby.

```
# Copyright Amazon.com, Inc. or its affiliates. All Rights Reserved.
# SPDX-License-Identifier: Apache-2.0
def lambda_handler(event:, context:)
  event['Records'].map { |record| process_message(record) }
end

def process_message(record)
  message = record['Sns']['Message']
  puts("Processing message: #{message}")
rescue StandardError => e
  puts("Error processing message: #{e}")
  raise
end
```

Rust

SDK for Rust

Note

There's more on GitHub. Find the complete example and learn how to set up and run in the [Serverless examples](#) repository.

Consuming an SNS event with Lambda using Rust.

```
// Copyright Amazon.com, Inc. or its affiliates. All Rights Reserved.
// SPDX-License-Identifier: Apache-2.0
use aws_lambda_events::event::sns::SnsEvent;
use aws_lambda_events::sns::SnsRecord;
use lambda_runtime::{run, service_fn, Error, LambdaEvent};
use tracing::info;

// Built with the following dependencies:
// aws_lambda_events = { version = "0.10.0", default-features = false, features
// = ["sns"] }
// lambda_runtime = "0.8.1"
// tokio = { version = "1", features = ["macros"] }
```

```
// tracing = { version = "0.1", features = ["log"] }
// tracing-subscriber = { version = "0.3", default-features = false, features =
  ["fmt"] }

async fn function_handler(event: LambdaEvent<SnsEvent>) -> Result<(), Error> {
    for event in event.payload.records {
        process_record(&event)?;
    }

    Ok(())
}

fn process_record(record: &SnsRecord) -> Result<(), Error> {
    info!("Processing SNS Message: {}", record.sns.message);

    // Implement your record handling code here.

    Ok(())
}

#[tokio::main]
async fn main() -> Result<(), Error> {
    tracing_subscriber::fmt()
        .with_max_level(tracing::Level::INFO)
        .with_target(false)
        .without_time()
        .init();

    run(service_fn(function_handler)).await
}
```

To create the function

1. Create a directory for the project, and then switch to that directory.

```
mkdir sns-tutorial
cd sns-tutorial
```

2. Copy the sample JavaScript code into a new file named `index.js`.
3. Create a deployment package using the following `zip` command.

```
zip function.zip index.js
```

4. Run the following AWS CLI command to create your Lambda function in **account B**.

```
aws lambda create-function --function-name Function-With-SNS \
  --zip-file fileb://function.zip --handler index.handler --runtime nodejs18.x \
  --role arn:aws:iam::<AccountB_ID>:role/lambda-sns-role \
  --timeout 60 --profile accountB
```

You should see output similar to the following.

```
{
  "FunctionName": "Function-With-SNS",
  "FunctionArn": "arn:aws:lambda:us-west-2:123456789012:function:Function-With-SNS",
  "Runtime": "nodejs18.x",
  "Role": "arn:aws:iam::123456789012:role/lambda_basic_role",
  "Handler": "index.handler",
  ...
  "RuntimeVersionConfig": {
    "RuntimeVersionArn": "arn:aws:lambda:us-west-2::runtime:7d5f06b69c951da8a48b926ce280a9daf2e8bb1a74fc4a2672580c787d608206"
  }
}
```

5. Record the Amazon Resource Name (ARN) of your function. You'll need it later in the tutorial when you add permissions to allow Amazon SNS to invoke your function.

Add permissions to function (account B)

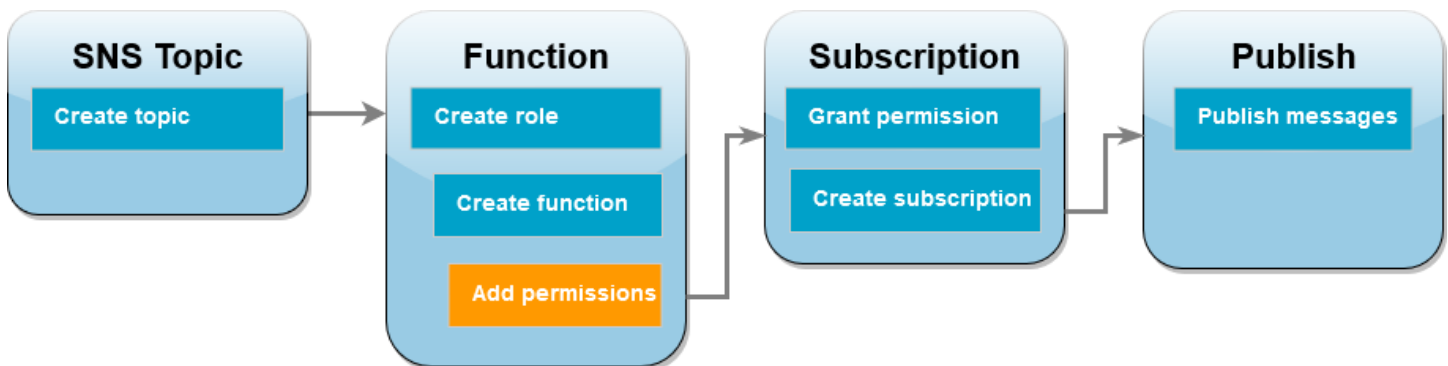

For Amazon SNS to invoke your function, you need to grant it permission in a statement on a [resource-based policy](#). You add this statement using the AWS CLI `add-permission` command.

To grant Amazon SNS permission to invoke your function

- In **account B**, run the following AWS CLI command using the ARN for your Amazon SNS topic you recorded earlier.

```
aws lambda add-permission --function-name Function-With-SNS \  
  --source-arn arn:aws:sns:us-east-1:<AccountA_ID>:sns-topic-for-lambda \  
  --statement-id function-with-sns --action "lambda:InvokeFunction" \  
  --principal sns.amazonaws.com --profile accountB
```

You should see output similar to the following.

```
{  
  "Statement": "{ \"Condition\": { \"ArnLike\": { \"AWS:SourceArn\":  
    \"arn:aws:sns:us-east-1:<AccountA_ID>:sns-topic-for-lambda\" } },  
    \"Action\": [ \"lambda:InvokeFunction\" ],  
    \"Resource\": \"arn:aws:lambda:us-east-1:<AccountB_ID>:function:Function-With-  
SNS\" ,  
    \"Effect\": \"Allow\" , \"Principal\": { \"Service\": \"sns.amazonaws.com\" } ,  
    \"Sid\": \"function-with-sns\" } }"
```

Note

If the account with the Amazon SNS topic is hosted in an [opt-in AWS Region](#), you need to specify the region in the principal. For example, if you're working with an Amazon SNS topic in the Asia Pacific (Hong Kong) region, you need to specify `sns.ap-east-1.amazonaws.com` instead of `sns.amazonaws.com` for the principal.

Grant cross-account permission for Amazon SNS subscription (account A)

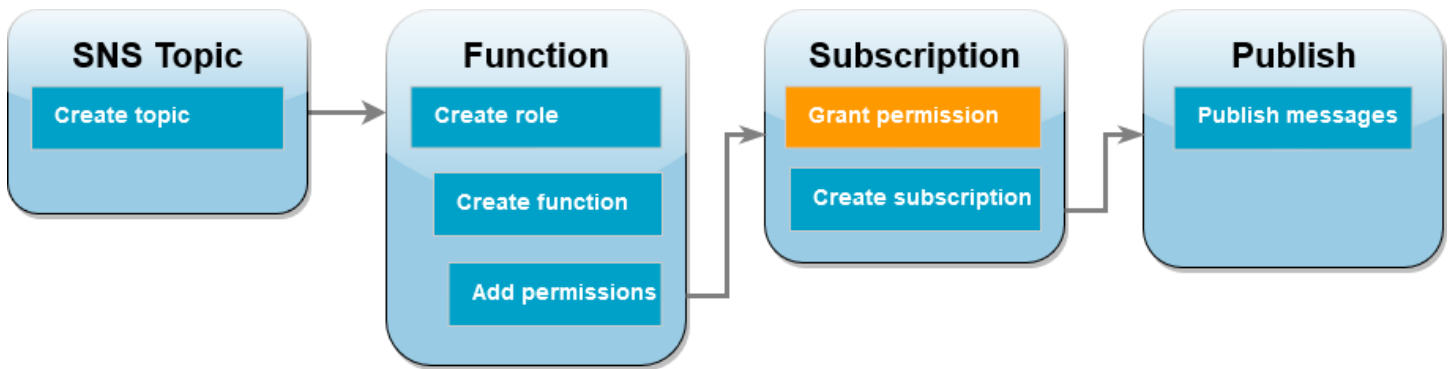

For your Lambda function in **account B** to subscribe to the Amazon SNS topic you created in **account A**, you need to grant permission for **account B** to subscribe to your topic. You grant this permission using the AWS CLI `add-permission` command.

To grant permission for account B to subscribe to the topic

- In **account A**, run the following AWS CLI command. Use the ARN for the Amazon SNS topic you recorded earlier.

```
aws sns add-permission --label lambda-access --aws-account-id <AccountB_ID> \
  --topic-arn arn:aws:sns:us-east-1:<AccountA_ID>:sns-topic-for-lambda \
  --action-name Subscribe ListSubscriptionsByTopic --profile accountA
```

Create a subscription (account B)

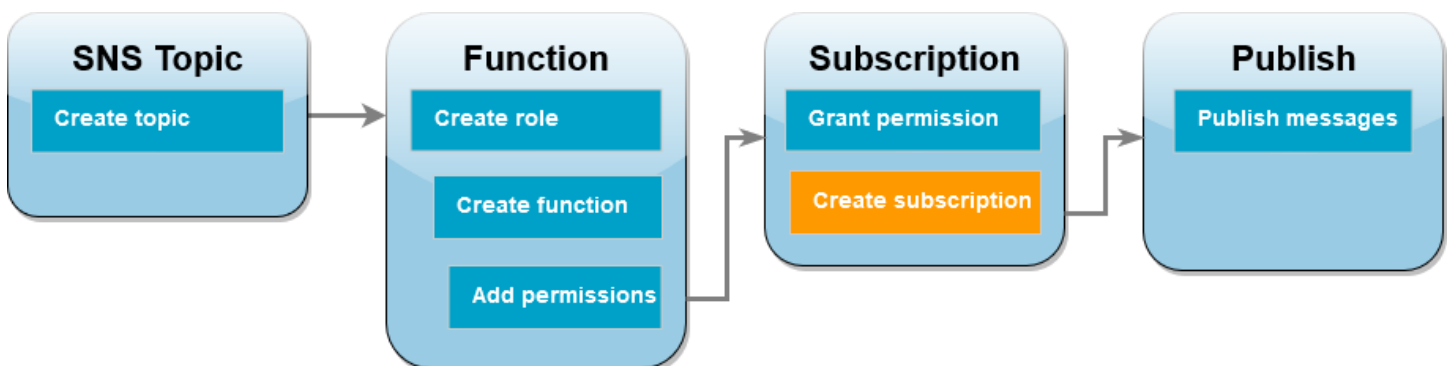

In **account B**, you now subscribe your Lambda function to the Amazon SNS topic you created at the beginning of the tutorial in **account A**. When a message is sent to this topic (`sns-topic-for-lambda`), Amazon SNS invokes your Lambda function `Function-With-SNS` in **account B**.

To create a subscription

- In **account B**, run the following AWS CLI command. Use your default region you created your topic in and the ARNs for your topic and Lambda function.

```
aws sns subscribe --protocol lambda \
  --region us-east-1 \
  --topic-arn arn:aws:sns:us-east-1:<AccountA_ID>:sns-topic-for-lambda \
  --notification-endpoint arn:aws:lambda:us-east-1:<AccountB_ID>:function:Function-With-SNS \
  --profile accountB
```

You should see output similar to the following.

```
{
  "SubscriptionArn": "arn:aws:sns:us-east-1:<AccountA_ID>:sns-topic-for-lambda:5d906xxxx-7c8x-45dx-a9dx-0484e31c98xx"
}
```

Publish messages to topic (account A and account B)

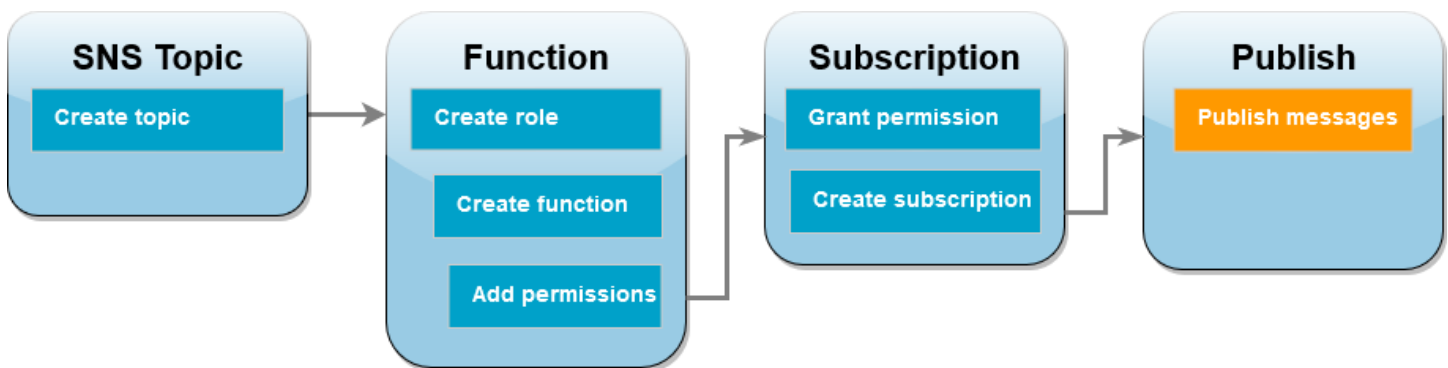

Now that your Lambda function in **account B** is subscribed to your Amazon SNS topic in **account A**, it's time to test your setup by publishing messages to your topic. To confirm that Amazon SNS has invoked your Lambda function, you use CloudWatch Logs to view your function's output.

To publish a message to your topic and view your function's output

- Enter `Hello World` into a text file and save it as `message.txt`.
- From the same directory you saved your text file in, run the following AWS CLI command in **account A**. Use the ARN for your own topic.

```
aws sns publish --message file://message.txt --subject Test \  
  --topic-arn arn:aws:sns:us-east-1:<AccountA_ID>:sns-topic-for-lambda \  
  --profile accountA
```

This will return a message ID with a unique identifier, indicating that Amazon SNS has accepted the message. Amazon SNS then attempts to deliver the message to the topic's subscribers. To confirm that Amazon SNS has invoked your Lambda function, use CloudWatch Logs to view your function's output:

3. In **account B**, open the [Log groups](#) page of the Amazon CloudWatch console.
4. Choose the log group for your function (/aws/lambda/Function-With-SNS).
5. Choose the most recent log stream.
6. If your function was correctly invoked, you'll see output similar to the following showing the contents of the message you published to your topic.

```
2023-07-31T21:42:51.250Z c1cba6b8-ade9-4380-aa32-d1a225da0e48 INFO Processed  
message Hello World  
2023-07-31T21:42:51.250Z c1cba6b8-ade9-4380-aa32-d1a225da0e48 INFO done
```

Clean up your resources

You can now delete the resources that you created for this tutorial, unless you want to retain them. By deleting AWS resources that you're no longer using, you prevent unnecessary charges to your AWS account.

In **Account A**, clean up your Amazon SNS topic.

To delete the Amazon SNS topic

1. Open the [Topics page](#) of the Amazon SNS console.
2. Select the topic you created.
3. Choose **Delete**.
4. Enter **delete me** in the text input field.
5. Choose **Delete**.

In **Account B**, clean up your execution role, Lambda function, and Amazon SNS subscription.

To delete the execution role

1. Open the [Roles page](#) of the IAM console.
2. Select the execution role that you created.
3. Choose **Delete**.
4. Enter the name of the role in the text input field and choose **Delete**.

To delete the Lambda function

1. Open the [Functions page](#) of the Lambda console.
2. Select the function that you created.
3. Choose **Actions, Delete**.
4. Type **confirm** in the text input field and choose **Delete**.

To delete the Amazon SNS subscription

1. Open the [Subscriptions page](#) of the Amazon SNS console.
2. Select the subscription you created.
3. Choose **Delete, Delete**.

Managing permissions in AWS Lambda

You can use AWS Identity and Access Management (IAM) to manage permissions in AWS Lambda. There are two main categories of permissions that you need to consider when working with Lambda functions:

- Permissions that your Lambda functions need to perform API actions and access other AWS resources
- Permissions that other AWS users and entities need to access your Lambda functions

Lambda functions often need to access other AWS resources, and perform various API operations on those resources. For example, you might have a Lambda function that responds to an event by updating entries in an Amazon DynamoDB database. In this case, your function needs permissions to access the database, as well as permissions to put or update items in that database.

You define the permissions that your Lambda function needs in a special IAM role called an [execution role](#). In this role, you can attach a policy that defines every permission your function needs to access other AWS resources, and read from event sources. Every Lambda function must have an execution role. At a minimum, your execution role must have access to Amazon CloudWatch because Lambda functions log to CloudWatch Logs by default. You can attach the [AWSLambdaBasicExecutionRole managed policy](#) to your execution role to satisfy this requirement.

To give other AWS accounts, organizations, and services permissions to access your Lambda resources, you have a few options:

- You can use [identity-based policies](#) to grant other users access to your Lambda resources. Identity-based policies can apply to users directly, or to groups and roles that are associated with a user.
- You can use [resource-based policies](#) to give other accounts and AWS services permissions to access your Lambda resources. When a user tries to access a Lambda resource, Lambda considers both the user's identity-based policies and the resource's resource-based policy. When an AWS service such as Amazon Simple Storage Service (Amazon S3) calls your Lambda function, Lambda considers only the resource-based policy.
- You can use an [attribute-based access control \(ABAC\)](#) model to control access to your Lambda functions. With ABAC, you can attach tags to a Lambda function, pass them in certain API

requests, or attach them to the IAM principal making the request. Specify the same tags in the condition element of an IAM policy to control function access.

In AWS, it's a best practice to grant only the permissions required to perform a task ([least-privilege permissions](#)). To implement this in Lambda, we recommend starting with an [AWS managed policy](#). You can use these managed policies as-is, or as a starting point for writing your own more restrictive policies.

To help you fine-tune your permissions for least-privilege access, Lambda provides some additional conditions you can include in your policies. For more information, see [the section called "Resources and Conditions"](#).

For more information about IAM, see the [IAM User Guide](#).

Defining Lambda function permissions with an execution role

A Lambda function's execution role is an AWS Identity and Access Management (IAM) role that grants the function permission to access AWS services and resources. For example, you might create an execution role that has permission to send logs to Amazon CloudWatch and upload trace data to AWS X-Ray. This page provides information on how to create, view, and manage a Lambda function's execution role.

Lambda automatically assumes your execution role when you invoke your function. You should avoid manually calling `sts:AssumeRole` to assume the execution role in your function code. If your use case requires that the role assumes itself, you must include the role itself as a trusted principal in your role's trust policy. For more information on how to modify a role trust policy, see [Modifying a role trust policy \(console\)](#) in the IAM User Guide.

In order for Lambda to properly assume your execution role, the role's [trust policy](#) must specify the Lambda service principal (`lambda.amazonaws.com`) as a trusted service.

Topics

- [Creating an execution role in the IAM console](#)
- [Creating and managing roles with the AWS CLI](#)
- [Grant least privilege access to your Lambda execution role](#)
- [Viewing and updating permissions in the execution role](#)
- [Working with AWS managed policies in the execution role](#)
- [Using source function ARN to control function access behavior](#)

Creating an execution role in the IAM console

By default, Lambda creates an execution role with minimal permissions when you [create a function in the Lambda console](#). Specifically, this execution role includes the [AWSLambdaBasicExecutionRole managed policy](#), which gives your function basic permissions to log events to Amazon CloudWatch Logs.

Your functions typically need additional permissions to perform more meaningful tasks. For example, you might have a Lambda function that responds to an event by updating entries in an Amazon DynamoDB database. You can create an execution role with the necessary permissions using the IAM console.

To create an execution role in the IAM console

1. Open the [Roles page](#) in the IAM console.
2. Choose **Create role**.
3. Under **Trusted entity type**, choose **AWS service**.
4. Under **Use case**, choose **Lambda**.
5. Choose **Next**.
6. Select the AWS managed policies that you want to attach to your role. For example, if your function needs to access DynamoDB, select the **AWSLambdaDynamoDBExecutionRole** managed policy.
7. Choose **Next**.
8. Enter a **Role name** and then choose **Create role**.

For detailed instructions, see [Creating a role for an AWS service \(console\)](#) in the *IAM User Guide*.

After you create your execution role, attach it to your function. When you [create a function in the Lambda console](#), you can attach any execution role that you previously created to the function. If you want to attach a new execution role to an existing function, follow the steps in [the section called "Updating a function's execution role"](#).

Creating and managing roles with the AWS CLI

To create an execution role with the AWS Command Line Interface (AWS CLI), use the **create-role** command. When using this command, you can specify the trust policy inline. A role's trust policy gives the specified principals permission to assume the role. In the following example, you grant the Lambda service principal permission to assume your role. Note that requirements for escaping quotes in the JSON string may vary depending on your shell.

```
aws iam create-role \  
  --role-name lambda-ex \  
  --assume-role-policy-document '{"Version": "2012-10-17","Statement":  
  [{ "Effect": "Allow", "Principal": {"Service": "lambda.amazonaws.com"}, "Action":  
  "sts:AssumeRole"}]}'
```

You can also define the trust policy for the role using a separate JSON file. In the following example, `trust-policy.json` is a file in the current directory.

Example trust-policy.json

```
{
  "Version": "2012-10-17",
  "Statement": [
    {
      "Effect": "Allow",
      "Principal": {
        "Service": "lambda.amazonaws.com"
      },
      "Action": "sts:AssumeRole"
    }
  ]
}
```

```
aws iam create-role \
  --role-name lambda-ex \
  --assume-role-policy-document file://trust-policy.json
```

You should see the following output:

```
{
  "Role": {
    "Path": "/",
    "RoleName": "lambda-ex",
    "RoleId": "AR0AQFOX MPL6TZ6ITKWND",
    "Arn": "arn:aws:iam::123456789012:role/lambda-ex",
    "CreateDate": "2020-01-17T23:19:12Z",
    "AssumeRolePolicyDocument": {
      "Version": "2012-10-17",
      "Statement": [
        {
          "Effect": "Allow",
          "Principal": {
            "Service": "lambda.amazonaws.com"
          },
          "Action": "sts:AssumeRole"
        }
      ]
    }
  }
}
```

To add permissions to the role, use the **attach-policy-to-role** command. The following command adds the `AWSLambdaBasicExecutionRole` managed policy to the `lambda-ex` execution role.

```
aws iam attach-role-policy --role-name lambda-ex --policy-arn arn:aws:iam::aws:policy/service-role/AWSLambdaBasicExecutionRole
```

After you create your execution role, attach it to your function. When you [create a function in the Lambda console](#), you can attach any execution role that you previously created to the function. If you want to attach a new execution role to an existing function, follow the steps in [the section called "Updating a function's execution role"](#).

Grant least privilege access to your Lambda execution role

When you first create an IAM role for your Lambda function during the development phase, you might sometimes grant permissions beyond what is required. Before publishing your function in the production environment, as a best practice, adjust the policy to include only the required permissions. For more information, see [Apply least-privilege permissions](#) in the *IAM User Guide*.

Use IAM Access Analyzer to help identify the required permissions for the IAM execution role policy. IAM Access Analyzer reviews your AWS CloudTrail logs over the date range that you specify and generates a policy template with only the permissions that the function used during that time. You can use the template to create a managed policy with fine-grained permissions, and then attach it to the IAM role. That way, you grant only the permissions that the role needs to interact with AWS resources for your specific use case.

For more information, see [Generate policies based on access activity](#) in the *IAM User Guide*.

Viewing and updating permissions in the execution role

This topic covers how you can view and update your function's [execution role](#).

Topics

- [Viewing a function's execution role](#)
- [Updating a function's execution role](#)

Viewing a function's execution role

To view a function's execution role, use the Lambda console.

To view a function's execution role (console)

1. Open the [Functions page](#) of the Lambda console.
2. Choose the name of a function.
3. Choose **Configuration**, and then choose **Permissions**.
4. Under **Execution role**, you can view the role that's currently being used as the function's execution role. For convenience, you can view all the resources and actions that the function can access under the **Resource summary** section. You can also choose a service from the dropdown list to see all permissions related to that service.

Updating a function's execution role

You can add or remove permissions from a function's execution role at any time, or configure your function to use a different role. If your function needs access to any other services or resources, you must add the necessary permissions to the execution role.

When you add permissions to your function, perform a trivial update to its code or configuration as well. This forces running instances of your function, which have outdated credentials, to stop and be replaced.

To update a function's execution role, you can use the Lambda console.

To update a function's execution role (console)

1. Open the [Functions page](#) of the Lambda console.
2. Choose the name of a function.
3. Choose **Configuration**, and then choose **Permissions**.
4. Under **Execution role**, choose **Edit**.
5. If you want to update your function to use a different role as the execution role, choose the new role in the dropdown menu under **Existing role**.

Note

If you want to update the permissions within an existing execution role, you can only do so in the AWS Identity and Access Management (IAM) console.

If you want to create a new role to use as the execution role, choose **Create a new role from AWS policy templates** under **Execution role**. Then, enter a name for your new role under **Role name**, and specify any policies you want to attach to the new role under **Policy templates**.

6. Choose **Save**.

Working with AWS managed policies in the execution role

The following AWS managed policies provide permissions that are required to use Lambda features.

Change	Description	Date
AWSLambdaMSKExecutionRole – Lambda added the kafka:DescribeClusterV2 permission to this policy.	AWSLambdaMSKExecutionRole grants permissions to read and access records from an Amazon Managed Streaming for Apache Kafka (Amazon MSK) cluster, manage elastic network interfaces (ENIs), and write to CloudWatch Logs.	June 17, 2022
AWSLambdaBasicExecutionRole – Lambda started tracking changes to this policy.	AWSLambdaBasicExecutionRole grants permissions to upload logs to CloudWatch.	February 14, 2022
AWSLambdaDynamoDBExecutionRole – Lambda started tracking changes to this policy.	AWSLambdaDynamoDBExecutionRole grants permissions to read records from an Amazon DynamoDB stream and write to CloudWatch Logs.	February 14, 2022
AWSLambdaKinesisExecutionRole – Lambda	AWSLambdaKinesisExecutionRole grants	February 14, 2022

Change	Description	Date
started tracking changes to this policy.	permissions to read events from an Amazon Kinesis data stream and write to CloudWatch Logs.	
<u>AWSLambdaMSKExecutionRole</u> – Lambda started tracking changes to this policy.	AWSLambdaMSKExecutionRole grants permissions to read and access records from an Amazon Managed Streaming for Apache Kafka (Amazon MSK) cluster, manage elastic network interfaces (ENIs), and write to CloudWatch Logs.	February 14, 2022
<u>AWSLambdaSQSQueueExecutionRole</u> – Lambda started tracking changes to this policy.	AWSLambdaSQSQueueExecutionRole grants permissions to read a message from an Amazon Simple Queue Service (Amazon SQS) queue and write to CloudWatch Logs.	February 14, 2022
<u>AWSLambdaVPCAccessExecutionRole</u> – Lambda started tracking changes to this policy.	AWSLambdaVPCAccessExecutionRole grants permissions to manage ENIs within an Amazon VPC and write to CloudWatch Logs.	February 14, 2022
<u>AWSXRayDaemonWriteAccess</u> – Lambda started tracking changes to this policy.	AWSXRayDaemonWriteAccess grants permissions to upload trace data to X-Ray.	February 14, 2022

Change	Description	Date
CloudWatchLambdaInsightsExecutionRolePolicy – Lambda started tracking changes to this policy.	CloudWatchLambdaInsightsExecutionRolePolicy grants permissions to write runtime metrics to CloudWatch Lambda Insights.	February 14, 2022
AmazonS3ObjectLambdaExecutionRolePolicy – Lambda started tracking changes to this policy.	AmazonS3ObjectLambdaExecutionRolePolicy grants permissions to interact with Amazon Simple Storage Service (Amazon S3) object Lambda and to write to CloudWatch Logs.	February 14, 2022

For some features, the Lambda console attempts to add missing permissions to your execution role in a customer managed policy. These policies can become numerous. To avoid creating extra policies, add the relevant AWS managed policies to your execution role before enabling features.

When you use an [event source mapping](#) to invoke your function, Lambda uses the execution role to read event data. For example, an event source mapping for Kinesis reads events from a data stream and sends them to your function in batches.

When a service assumes a role in your account, you can include the `aws:SourceAccount` and `aws:SourceArn` global condition context keys in your role trust policy to limit access to the role to only requests that are generated by expected resources. For more information, see [Cross-service confused deputy prevention for AWS Security Token Service](#).

In addition to the AWS managed policies, the Lambda console provides templates for creating a custom policy with permissions for additional use cases. When you create a function in the Lambda console, you can choose to create a new execution role with permissions from one or more templates. These templates are also applied automatically when you create a function from a blueprint, or when you configure options that require access to other services. Example templates are available in this guide's [GitHub repository](#).

Using source function ARN to control function access behavior

It's common for your Lambda function code to make API requests to other AWS services. To make these requests, Lambda generates an ephemeral set of credentials by assuming your function's execution role. These credentials are available as environment variables during your function's invocation. When working with AWS SDKs, you don't need to provide credentials for the SDK directly in code. By default, the credential provider chain sequentially checks each place where you can set credentials and selects the first one available—usually the environment variables (`AWS_ACCESS_KEY_ID`, `AWS_SECRET_ACCESS_KEY`, and `AWS_SESSION_TOKEN`).

Lambda injects the source function ARN into the credentials context if the request is an AWS API request that comes from within your execution environment. Lambda also injects the source function ARN for the following AWS API requests that Lambda makes on your behalf outside of your execution environment:

Service	Action	Reason
CloudWatch Logs	<code>CreateLogGroup</code> , <code>CreateLogStream</code> , <code>PutLogEvents</code>	To store logs into a CloudWatch Logs log group
X-Ray	<code>PutTraceSegments</code>	To send trace data to X-Ray
Amazon EFS	<code>ClientMount</code>	To connect your function to an Amazon Elastic File System (Amazon EFS) file system

Other AWS API calls that Lambda makes outside of your execution environment on your behalf using the same execution role don't contain the source function ARN. Examples of such API calls outside the execution environment include:

- Calls to AWS Key Management Service (AWS KMS) to automatically encrypt and decrypt your environment variables.
- Calls to Amazon Elastic Compute Cloud (Amazon EC2) to create elastic network interfaces (ENIs) for a VPC-enabled function.
- Calls to AWS services, such as Amazon Simple Queue Service (Amazon SQS), to read from an event source that's set up as an [event source mapping](#).

With the source function ARN in the credentials context, you can verify whether a call to your resource came from a specific Lambda function's code. To verify this, use the `lambda:SourceFunctionArn` condition key in an IAM identity-based policy or [service control policy \(SCP\)](#).

Note

You cannot use the `lambda:SourceFunctionArn` condition key in resource-based policies.

With this condition key in your identity-based policies or SCPs, you can implement security controls for the API actions that your function code makes to other AWS services. This has a few key security applications, such as helping you identify the source of a credential leak.

Note

The `lambda:SourceFunctionArn` condition key is different from the `lambda:FunctionArn` and `aws:SourceArn` condition keys. The `lambda:FunctionArn` condition key applies only to [event source mappings](#) and helps define which functions your event source can invoke. The `aws:SourceArn` condition key applies only to policies where your Lambda function is the target resource, and helps define which other AWS services and resources can invoke that function. The `lambda:SourceFunctionArn` condition key can apply to any identity-based policy or SCP to define the specific Lambda functions that have permissions to make specific AWS API calls to other resources.

To use `lambda:SourceFunctionArn` in your policy, include it as a condition with any of the [ARN condition operators](#). The value of the key must be a valid ARN.

For example, suppose your Lambda function code makes an `s3:PutObject` call that targets a specific Amazon S3 bucket. You might want to allow only one specific Lambda function to have `s3:PutObject` access that bucket. In this case, your function's execution role should have a policy attached that looks like this:

Example policy granting a specific Lambda function access to an Amazon S3 resource

```
{
```

```

"Version": "2012-10-17",
"Statement": [
  {
    "Sid": "ExampleSourceFunctionArn",
    "Effect": "Allow",
    "Action": "s3:PutObject",
    "Resource": "arn:aws:s3:::lambda_bucket/*",
    "Condition": {
      "ArnEquals": {
        "lambda:SourceFunctionArn": "arn:aws:lambda:us-
east-1:123456789012:function:source_lambda"
      }
    }
  }
]
}

```

This policy allows only `s3:PutObject` access if the source is the Lambda function with ARN `arn:aws:lambda:us-east-1:123456789012:function:source_lambda`. This policy doesn't allow `s3:PutObject` access to any other calling identity. This is true even if a different function or entity makes an `s3:PutObject` call with the same execution role.

Note

The `lambda:SourceFunctionArn` condition key doesn't support Lambda function versions or function aliases. If you use the ARN for a particular function version or alias, your function won't have permission to take the action you specify. Be sure to use the unqualified ARN for your function without a version or alias suffix.

You can also use `lambda:SourceFunctionArn` in SCPs. For example, suppose you want to restrict access to your bucket to either a single Lambda function's code or to calls from a specific Amazon Virtual Private Cloud (VPC). The following SCP illustrates this.

Example policy denying access to Amazon S3 under specific conditions

```

{
  "Version": "2012-10-17",
  "Statement": [
    {
      "Action": [

```

```

        "s3:*"
    ],
    "Resource": "arn:aws:s3:::lambda_bucket/*",
    "Effect": "Deny",
    "Condition": {
        "StringNotEqualsIfExists": {
            "aws:SourceVpc": [
                "vpc-12345678"
            ]
        }
    }
},
{
    "Action": [
        "s3:*"
    ],
    "Resource": "arn:aws:s3:::lambda_bucket/*",
    "Effect": "Deny",
    "Condition": {
        "ArnNotEqualsIfExists": {
            "lambda:SourceFunctionArn": "arn:aws:lambda:us-
east-1:123456789012:function:source_lambda"
        }
    }
}
]
}

```

This policy denies all S3 actions unless they come from a specific Lambda function with ARN `arn:aws:lambda:*:123456789012:function:source_lambda`, or unless they come from the specified VPC. The `StringNotEqualsIfExists` operator tells IAM to process this condition only if the `aws:SourceVpc` key is present in the request. Similarly, IAM considers the `ArnNotEqualsIfExists` operator only if the `lambda:SourceFunctionArn` exists.

Granting other AWS entities access to your Lambda functions

To give other AWS accounts, organizations, and services permissions to access your Lambda resources, you have a few options:

- You can use [identity-based policies](#) to grant other users access to your Lambda resources. Identity-based policies can apply to users directly, or to groups and roles that are associated with a user.
- You can use [resource-based policies](#) to give other accounts and AWS services permissions to access your Lambda resources. When a user tries to access a Lambda resource, Lambda considers both the user's identity-based policies and the resource's resource-based policy. When an AWS service such as Amazon Simple Storage Service (Amazon S3) calls your Lambda function, Lambda considers only the resource-based policy.
- You can use an [attribute-based access control \(ABAC\)](#) model to control access to your Lambda functions. With ABAC, you can attach tags to a Lambda function, pass them in certain API requests, or attach them to the IAM principal making the request. Specify the same tags in the condition element of an IAM policy to control function access.

To help you fine-tune your permissions for least-privilege access, Lambda provides some additional conditions you can include in your policies. For more information, see [the section called "Resources and Conditions"](#).

Identity-based IAM policies for Lambda

You can use identity-based policies in AWS Identity and Access Management (IAM) to grant users in your account access to Lambda. Identity-based policies can apply to users, user groups, or roles. You can also grant users in another account permission to assume a role in your account and access your Lambda resources.

Lambda provides AWS managed policies that grant access to Lambda API actions and, in some cases, access to other AWS services used to develop and manage Lambda resources. Lambda updates these managed policies as needed to ensure that your users have access to new features when they're released.

- [AWSLambda_FullAccess](#) – Grants full access to Lambda actions and other AWS services used to develop and maintain Lambda resources.
- [AWSLambda_ReadOnlyAccess](#) – Grants read-only access to Lambda resources.

- [AWSLambdaRole](#) – Grants permissions to invoke Lambda functions.

AWS managed policies grant permission to API actions without restricting the Lambda functions or layers that a user can modify. For finer-grained control, you can create your own policies that limit the scope of a user's permissions.

Topics

- [Granting users access to a Lambda function](#)
- [Granting users access to a Lambda layer](#)

Granting users access to a Lambda function

Use [identity-based policies](#) to allow users, user groups, or roles to perform operations on Lambda functions.

Note

For a function defined as a container image, the user permission to access the image must be configured in Amazon Elastic Container Registry (Amazon ECR). For an example, see [Amazon ECR repository policies](#).

The following shows an example of a permissions policy with limited scope. It allows a user to create and manage Lambda functions named with a designated prefix (`intern-`), and configured with a designated execution role.

Example Function development policy

```
{
  "Version": "2012-10-17",
  "Statement": [
    {
      "Sid": "ReadOnlyPermissions",
      "Effect": "Allow",
      "Action": [
        "lambda:GetAccountSettings",
        "lambda:GetEventSourceMapping",
        "lambda:GetFunction",
        "lambda:GetFunctionConfiguration",
```



```

        "lambda:GetFunctionCodeSigningConfig",
        "lambda:GetFunctionConcurrency",
        "lambda:ListEventSourceMappings",
        "lambda:ListFunctions",
        "lambda:ListTags",
        "iam:ListRoles"
    ],
    "Resource": "*"
},
{
    "Sid": "DevelopFunctions",
    "Effect": "Allow",
    "NotAction": [
        "lambda:AddPermission",
        "lambda:PutFunctionConcurrency"
    ],
    "Resource": "arn:aws:lambda:*:*:function:intern-*"
},
{
    "Sid": "DevelopEventSourceMappings",
    "Effect": "Allow",
    "Action": [
        "lambda>DeleteEventSourceMapping",
        "lambda:UpdateEventSourceMapping",
        "lambda>CreateEventSourceMapping"
    ],
    "Resource": "*",
    "Condition": {
        "StringLike": {
            "lambda:FunctionArn": "arn:aws:lambda:*:*:function:intern-*"
        }
    }
},
{
    "Sid": "PassExecutionRole",
    "Effect": "Allow",
    "Action": [
        "iam:ListRolePolicies",
        "iam:ListAttachedRolePolicies",
        "iam:GetRole",
        "iam:GetRolePolicy",
        "iam:PassRole",
        "iam:SimulatePrincipalPolicy"
    ],

```

```

        "Resource": "arn:aws:iam::*:role/intern-lambda-execution-role"
    },
    {
        "Sid": "ViewLogs",
        "Effect": "Allow",
        "Action": [
            "logs:*"
        ],
        "Resource": "arn:aws:logs:*:*:log-group:/aws/lambda/intern-*"
    }
]
}

```

The permissions in the policy are organized into statements based on the [resources and conditions](#) that they support.

- **ReadOnlyPermissions** – The Lambda console uses these permissions when you browse and view functions. They don't support resource patterns or conditions.

```

    "Action": [
        "lambda:GetAccountSettings",
        "lambda:GetEventSourceMapping",
        "lambda:GetFunction",
        "lambda:GetFunctionConfiguration",
        "lambda:GetFunctionCodeSigningConfig",
        "lambda:GetFunctionConcurrency",
        "lambda:ListEventSourceMappings",
        "lambda:ListFunctions",
        "lambda:ListTags",
        "iam:ListRoles"
    ],
    "Resource": "*"

```

- **DevelopFunctions** – Use any Lambda action that operates on functions prefixed with `intern-`, except `AddPermission` and `PutFunctionConcurrency`. `AddPermission` modifies the [resource-based policy](#) on the function and can have security implications. `PutFunctionConcurrency` reserves scaling capacity for a function and can take capacity away from other functions.

```

    "NotAction": [

```

```

        "lambda:AddPermission",
        "lambda:PutFunctionConcurrency"
    ],
    "Resource": "arn:aws:lambda:*:*:function:intern-*"

```

- **DevelopEventSourceMappings** – Manage event source mappings on functions that are prefixed with `intern-`. These actions operate on event source mappings, but you can restrict them by function with a *condition*.

```

    "Action": [
        "lambda:DeleteEventSourceMapping",
        "lambda:UpdateEventSourceMapping",
        "lambda:CreateEventSourceMapping"
    ],
    "Resource": "*",
    "Condition": {
        "StringLike": {
            "lambda:FunctionArn": "arn:aws:lambda:*:*:function:intern-*"
        }
    }
}

```

- **PassExecutionRole** – View and pass only a role named `intern-lambda-execution-role`, which must be created and managed by a user with IAM permissions. `PassRole` is used when you assign an execution role to a function.

```

    "Action": [
        "iam:ListRolePolicies",
        "iam:ListAttachedRolePolicies",
        "iam:GetRole",
        "iam:GetRolePolicy",
        "iam:PassRole",
        "iam:SimulatePrincipalPolicy"
    ],
    "Resource": "arn:aws:iam:*:*:role/intern-lambda-execution-role"

```

- **ViewLogs** – Use CloudWatch Logs to view logs for functions that are prefixed with `intern-`.

```

    "Action": [
        "logs:*"
    ]

```

```
],  
  "Resource": "arn:aws:logs:*:*:log-group:/aws/lambda/intern-*
```

This policy allows a user to get started with Lambda, without putting other users' resources at risk. It doesn't allow a user to configure a function to be triggered by or call other AWS services, which requires broader IAM permissions. It also doesn't include permission to services that don't support limited-scope policies, like CloudWatch and X-Ray. Use the read-only policies for these services to give the user access to metrics and trace data.

When you configure triggers for your function, you need access to use the AWS service that invokes your function. For example, to configure an Amazon S3 trigger, you need permission to use the Amazon S3 actions that manage bucket notifications. Many of these permissions are included in the [AWSLambda_FullAccess](#) managed policy.

Granting users access to a Lambda layer

Use [identity-based policies](#) to allow users, user groups, or roles to perform operations on Lambda layers. The following policy grants a user permission to create layers and use them with functions. The resource patterns allow the user to work in any AWS Region and with any layer version, as long as the name of the layer starts with `test-`.

Example layer development policy

```
{  
  "Version": "2012-10-17",  
  "Statement": [  
    {  
      "Sid": "PublishLayers",  
      "Effect": "Allow",  
      "Action": [  
        "lambda:PublishLayerVersion"  
      ],  
      "Resource": "arn:aws:lambda:*:*:layer:test-*"  
    },  
    {  
      "Sid": "ManageLayerVersions",  
      "Effect": "Allow",  
      "Action": [  
        "lambda:GetLayerVersion",  
        "lambda>DeleteLayerVersion"  
      ],  
    }  
  ]  
}
```

```

        "Resource": "arn:aws:lambda:*:*:layer:test-*:*"
    }
]
}

```

You can also enforce layer use during function creation and configuration with the `lambda:Layer` condition. For example, you can prevent users from using layers published by other accounts. The following policy adds a condition to the `CreateFunction` and `UpdateFunctionConfiguration` actions to require that any layers specified come from account `123456789012`.

```

{
  "Version": "2012-10-17",
  "Statement": [
    {
      "Sid": "ConfigureFunctions",
      "Effect": "Allow",
      "Action": [
        "lambda:CreateFunction",
        "lambda:UpdateFunctionConfiguration"
      ],
      "Resource": "*",
      "Condition": {
        "ForAllValues:StringLike": {
          "lambda:Layer": [
            "arn:aws:lambda:*:123456789012:layer:*:*"
          ]
        }
      }
    }
  ]
}

```

To ensure that the condition applies, verify that no other statements grant the user permission to these actions.

Viewing resource-based IAM policies in Lambda

Lambda supports resource-based permissions policies for Lambda functions and layers. You can use resource-based policies to grant access to other [AWS accounts](#), [organizations](#), or [services](#). Resource-based policies apply to a single function, version, alias, or layer version.

Console

To view a function's resource-based policy

1. Open the [Functions page](#) of the Lambda console.
2. Choose a function.
3. Choose **Configuration** and then choose **Permissions**.
4. Scroll down to **Resource-based policy** and then choose **View policy document**. The resource-based policy shows the permissions that are applied when another account or AWS service attempts to access the function. The following example shows a statement that allows Amazon S3 to invoke a function named my-function for a bucket named amzn-s3-demo-bucket in account 123456789012.

Example Resource-based policy

```
{
  "Version": "2012-10-17",
  "Id": "default",
  "Statement": [
    {
      "Sid": "lambda-allow-s3-my-function",
      "Effect": "Allow",
      "Principal": {
        "Service": "s3.amazonaws.com"
      },
      "Action": "lambda:InvokeFunction",
      "Resource": "arn:aws:lambda:us-east-2:123456789012:function:my-
function",
      "Condition": {
        "StringEquals": {
          "AWS:SourceAccount": "123456789012"
        },
        "ArnLike": {
          "AWS:SourceArn": "arn:aws:s3:::amzn-s3-demo-bucket"
        }
      }
    }
  ]
}
```

AWS CLI

To view a function's resource-based policy, use the `get-policy` command.

```
aws lambda get-policy \  
  --function-name my-function \  
  --output text
```

You should see the following output:

```
{"Version":"2012-10-17","Id":"default","Statement":  
[{"Sid":"sns","Effect":"Allow","Principal":  
{"Service":"s3.amazonaws.com"},"Action":"lambda:InvokeFunction","Resource":"arn:aws:lambda:us-  
east-2:123456789012:function:my-function","Condition":{"ArnLike":  
{"AWS:SourceArn":"arn:aws:sns:us-east-2:123456789012:lambda*"}}}]}      7c681fc9-  
b791-4e91-acdf-eb847fdaa0f0
```

For versions and aliases, append the version number or alias to the function name.

```
aws lambda get-policy --function-name my-function:PROD
```

To remove permissions from your function, use `remove-permission`.

```
aws lambda remove-permission \  
  --function-name example \  
  --statement-id sns
```

Use the `get-layer-version-policy` command to view the permissions on a layer.

```
aws lambda get-layer-version-policy \  
  --layer-name my-layer \  
  --version-number 3 \  
  --output text
```

You should see the following output:

```
b0cd9796-d4eb-4564-939f-de7fe0b42236 {"Sid":"engineering-  
org","Effect":"Allow","Principal": "*", "Action":"lambda:GetLayerVersion","Resource":"arn:aws:  
west-2:123456789012:layer:my-layer:3","Condition":{"StringEquals":  
{"aws:PrincipalOrgID":"o-t194hfs8cz"}}}
```

Use `remove-layer-version-permission` to remove statements from the policy.

```
aws lambda remove-layer-version-permission --layer-name my-layer --version-number 3
--statement-id engineering-org
```

Supported API actions

The following Lambda API actions support resource-based policies:

- [CreateAlias](#)
- [DeleteAlias](#)
- [DeleteFunction](#)
- [DeleteFunctionConcurrency](#)
- [DeleteFunctionEventInvokeConfig](#)
- [DeleteProvisionedConcurrencyConfig](#)
- [GetAlias](#)
- [GetFunction](#)
- [GetFunctionConcurrency](#)
- [GetFunctionConfiguration](#)
- [GetFunctionEventInvokeConfig](#)
- [GetPolicy](#)
- [GetProvisionedConcurrencyConfig](#)
- [Invoke](#)
- [ListAliases](#)
- [ListFunctionEventInvokeConfigs](#)
- [ListProvisionedConcurrencyConfigs](#)
- [ListTags](#)
- [ListVersionsByFunction](#)
- [PublishVersion](#)
- [PutFunctionConcurrency](#)
- [PutFunctionEventInvokeConfig](#)

- [PutProvisionedConcurrencyConfig](#)
- [TagResource](#)
- [UntagResource](#)
- [UpdateAlias](#)
- [UpdateFunctionCode](#)
- [UpdateFunctionEventInvokeConfig](#)

Granting Lambda function access to AWS services

When you [use an AWS service to invoke your function](#), you grant permission in a statement on a resource-based policy. You can apply the statement to the entire function, or limit the statement to a single version or alias.

Note

When you add a trigger to your function with the Lambda console, the console updates the function's resource-based policy to allow the service to invoke it. To grant permissions to other accounts or services that aren't available in the Lambda console, you can use the AWS CLI.

Add a statement with the [add-permission](#) command. The simplest resource-based policy statement allows a service to invoke a function. The following command grants Amazon Simple Notification Service permission to invoke a function named `my-function`.

```
aws lambda add-permission \  
  --function-name my-function \  
  --action lambda:InvokeFunction \  
  --statement-id sns \  
  --principal sns.amazonaws.com \  
  --output text
```

You should see the following output:

```
{"Sid":"sns","Effect":"Allow","Principal":  
{"Service":"sns.amazonaws.com"},"Action":"lambda:InvokeFunction","Resource":"arn:aws:lambda:us-  
east-2:123456789012:function:my-function"}
```

This lets Amazon SNS call the [Invoke](#) API action on the function, but it doesn't restrict the Amazon SNS topic that triggers the invocation. To ensure that your function is only invoked by a specific resource, specify the Amazon Resource Name (ARN) of the resource with the `source-arn` option. The following command only allows Amazon SNS to invoke the function for subscriptions to a topic named `my-topic`.

```
aws lambda add-permission \  
  --function-name my-function \  
  --action lambda:InvokeFunction \  
  --statement-id sns-my-topic \  
  --principal sns.amazonaws.com \  
  --source-arn arn:aws:sns:us-east-2:123456789012:my-topic
```

Some services can invoke functions in other accounts. If you specify a source ARN that has your account ID in it, that isn't an issue. For Amazon S3, however, the source is a bucket whose ARN doesn't have an account ID in it. It's possible that you could delete the bucket and another account could create a bucket with the same name. Use the `source-account` option with your account ID to ensure that only resources in your account can invoke the function.

```
aws lambda add-permission \  
  --function-name my-function \  
  --action lambda:InvokeFunction \  
  --statement-id s3-account \  
  --principal s3.amazonaws.com \  
  --source-arn arn:aws:s3::amzn-s3-demo-bucket \  
  --source-account 123456789012
```

Granting function access to an organization

To grant permissions to an organization in [AWS Organizations](#), specify the organization ID as the `principal-org-id`. The following [add-permission](#) command grants invocation access to all users in organization `o-a1b2c3d4e5f`.

```
aws lambda add-permission \  
  --function-name example \  
  --statement-id Principal0rgIDExample \  
  --action lambda:InvokeFunction \  
  --principal * \  
  --principal-org-id o-a1b2c3d4e5f
```

Note

In this command, `Principal` is `*`. This means that all users in the organization `o-a1b2c3d4e5f` get function invocation permissions. If you specify an AWS account or role as the `Principal`, then only that principal gets function invocation permissions, but only if they are also part of the `o-a1b2c3d4e5f` organization.

This command creates a resource-based policy that looks like the following:

```
{
  "Version": "2012-10-17",
  "Statement": [
    {
      "Sid": "PrincipalOrgIDExample",
      "Effect": "Allow",
      "Principal": "*",
      "Action": "lambda:InvokeFunction",
      "Resource": "arn:aws:lambda:us-east-2:123456789012:function:example",
      "Condition": {
        "StringEquals": {
          "aws:PrincipalOrgID": "o-a1b2c3d4e5f"
        }
      }
    }
  ]
}
```

For more information, see [aws:PrincipalOrgID](#) in the *IAM user guide*.

Granting Lambda function access to other accounts

To share a function with another AWS account, add a cross-account permissions statement to the function's [resource-based policy](#). Run the [add-permission](#) command and specify the account ID as the principal. The following example grants account `111122223333` permission to invoke `my-function` with the `prod` alias.

```
aws lambda add-permission \
  --function-name my-function:prod \
  --statement-id xaccount \
```

```
--action lambda:InvokeFunction \  
--principal 111122223333 \  
--output text
```

You should see the following output:

```
{"Sid":"xaccount","Effect":"Allow","Principal":  
{"AWS":"arn:aws:iam::111122223333:root"},"Action":"lambda:InvokeFunction","Resource":"arn:aws:lambda:us-east-1:123456789012:function:my-function"}
```

The resource-based policy grants permission for the other account to access the function, but doesn't allow users in that account to exceed their permissions. Users in the other account must have the corresponding [user permissions](#) to use the Lambda API.

To limit access to a user or role in another account, specify the full ARN of the identity as the principal. For example, `arn:aws:iam::123456789012:user/developer`.

The [alias](#) limits which version the other account can invoke. It requires the other account to include the alias in the function ARN.

```
aws lambda invoke \  
--function-name arn:aws:lambda:us-east-2:123456789012:function:my-function:prod out
```

You should see the following output:

```
{  
  "StatusCode": 200,  
  "ExecutedVersion": "1"  
}
```

The function owner can then update the alias to point to a new version without the caller needing to change the way they invoke your function. This ensures that the other account doesn't need to change its code to use the new version, and it only has permission to invoke the version of the function associated with the alias.

You can grant cross-account access for most API actions that operate on an existing function. For example, you could grant access to `lambda:ListAliases` to let an account get a list of aliases, or `lambda:GetFunction` to let them download your function code. Add each permission separately, or use `lambda:*` to grant access to all actions for the specified function.

To grant other accounts permission for multiple functions, or for actions that don't operate on a function, we recommend that you use [IAM roles](#).

Granting Lambda layer access to other accounts

To share a layer with another AWS account, add a cross-account permissions statement to the layer's [resource-based policy](#). Run the [add-layer-version-permission](#) command and specify the account ID as the `principal`. In each statement, you can grant permission to a single account, all accounts, or an organization in [AWS Organizations](#).

The following example grants account 111122223333 access to version 2 of the `bash-runtime` layer.

```
aws lambda add-layer-version-permission \  
  --layer-name bash-runtime \  
  --version-number 2 \  
  --statement-id xaccount \  
  --action lambda:GetLayerVersion \  
  --principal 111122223333 \  
  --output text
```

You should see output similar to the following:

```
{"Sid":"xaccount","Effect":"Allow","Principal":  
{"AWS":"arn:aws:iam::111122223333:root"},"Action":"lambda:GetLayerVersion","Resource":"arn:aws:  
east-1:123456789012:layer:bash-runtime:2"}
```

Permissions apply only to a single layer version. Repeat the process each time that you create a new layer version.

To grant permission to all accounts in an [AWS Organizations](#) organization, use the `organization-id` option. The following example grants all accounts in organization `o-t194hfs8cz` permission to use version 3 of `my-layer`.

```
aws lambda add-layer-version-permission \  
  --layer-name my-layer \  
  --version-number 3 \  
  --statement-id engineering-org \  
  --principal '*' \  
  --action lambda:GetLayerVersion \  
  --organization-id o-t194hfs8cz
```

```
--organization-id o-t194hfs8cz \  
--output text
```

You should see the following output:

```
{"Sid":"engineering-  
org","Effect":"Allow","Principal":"*","Action":"lambda:GetLayerVersion","Resource":"arn:aws:lam  
east-2:123456789012:layer:my-layer:3","Condition":{"StringEquals":  
{"aws:PrincipalOrgID":"o-t194hfs8cz"}}}"
```

To grant permission to multiple accounts or organizations, you must add multiple statements.

Using attribute-based access control in Lambda

With [attribute-based access control \(ABAC\)](#), you can use tags to control access to your Lambda resources. You can attach tags to certain Lambda resources, attach them to certain API requests, or attach them to the AWS Identity and Access Management (IAM) principal making the request. For more information about how AWS grants attribute-based access, see [Controlling access to AWS resources using tags](#) in the *IAM User Guide*.

You can use ABAC to [grant least privilege](#) without specifying an Amazon Resource Name (ARN) or ARN pattern in the IAM policy. Instead, you can specify a tag in the [condition element](#) of an IAM policy to control access. Scaling is easier with ABAC because you don't have to update your IAM policies when you create new resources. Instead, add tags to the new resources to control access.

In Lambda, tags work on the following resources:

- Functions—For more information on tagging functions see, [the section called “Tags”](#).
- Code signing configurations—For more information on tagging code signing configurations, see [the section called “Code signing configuration tags”](#).
- Event source mappings—For more information on tagging event source mappings, see [the section called “Event source mapping tags”](#).

Tags aren't supported for layers.

You can use the following condition keys to write IAM policy rules based on tags:

- [aws:ResourceTag/tag-key](#): Control access based on the tags that are attached to a Lambda resource.

- [aws:RequestTag/tag-key](#): Require tags to be present in a request, such as when creating a new function.
- [aws:PrincipalTag/tag-key](#): Control what the IAM principal (the person making the request) is allowed to do based on the tags that are attached to their IAM [user](#) or [role](#).
- [aws:TagKeys](#): Control whether specific tag keys can be used in a request.

You can only specify conditions for actions that support them. For a list of conditions supported by each Lambda action, see [Actions, resources, and condition keys for AWS Lambda](#) in the Service Authorization Reference. For **aws:ResourceTag/tag-key** support, refer to "Resource types defined by AWS Lambda." For **aws:RequestTag/tag-key** and **aws:TagKeys** support, refer to "Actions defined by AWS Lambda."

Topics

- [Secure your functions by tag](#)

Secure your functions by tag

The following steps demonstrate one way to set up permissions for functions using ABAC. In this example scenario, you'll create four IAM permissions policies. Then, you'll attach these policies to a new IAM role. Finally, you'll create an IAM user and give that user permission to assume the new role.

Topics

- [Prerequisites](#)
- [Step 1: Require tags on new functions](#)
- [Step 2: Allow actions based on tags attached to a Lambda function and IAM principal](#)
- [Step 3: Grant list permissions](#)
- [Step 4: Grant IAM permissions](#)
- [Step 5: Create the IAM role](#)
- [Step 6: Create the IAM user](#)
- [Step 7: Test the permissions](#)
- [Step 8: Clean up your resources](#)

Prerequisites

Make sure that you have a [Lambda execution role](#). You'll use this role when you grant IAM permissions and when you create a Lambda function.

Step 1: Require tags on new functions

When using ABAC with Lambda, it's a best practice to require that all functions have tags. This helps ensure that your ABAC permissions policies work as expected.

[Create an IAM policy](#) similar to the following example. This policy uses the [aws:RequestTag/tag-key](#), [aws:ResourceTag/tag-key](#), and [aws:TagKeys](#) condition keys to require that new functions and the IAM principal creating the functions both have the project tag. The `ForAllValues` modifier ensures that `project` is the only allowed tag. If you don't include the `ForAllValues` modifier, users can add other tags to the function as long as they also pass `project`.

Example – Require tags on new functions

```
{
  "Version": "2012-10-17",
  "Statement": {
    "Effect": "Allow",
    "Action": [
      "lambda:CreateFunction",
      "lambda:TagResource"
    ],
    "Resource": "arn:aws:lambda:*:*:function:*",
    "Condition": {
      "StringEquals": {
        "aws:RequestTag/project": "${aws:PrincipalTag/project}",
        "aws:ResourceTag/project": "${aws:PrincipalTag/project}"
      },
      "ForAllValues:StringEquals": {
        "aws:TagKeys": "project"
      }
    }
  }
}
```

Step 2: Allow actions based on tags attached to a Lambda function and IAM principal

Create a second IAM policy using the [aws:ResourceTag/tag-key](#) condition key to require the principal's tag to match the tag that's attached to the function. The following example policy

allows principals with the `project` tag to invoke functions with the `project` tag. If a function has any other tags, the action is denied.

Example – Require matching tags on function and IAM principal

```
{
  "Version": "2012-10-17",
  "Statement": [
    {
      "Effect": "Allow",
      "Action": [
        "lambda:InvokeFunction",
        "lambda:GetFunction"
      ],
      "Resource": "arn:aws:lambda:*:*:function:*",
      "Condition": {
        "StringEquals": {
          "aws:ResourceTag/project": "${aws:PrincipalTag/project}"
        }
      }
    }
  ]
}
```

Step 3: Grant list permissions

Create a policy that allows the principal to list Lambda functions and IAM roles. This allows the principal to see all Lambda functions and IAM roles on the console and when calling the API actions.

Example – Grant Lambda and IAM list permissions

```
{
  "Version": "2012-10-17",
  "Statement": [
    {
      "Sid": "AllResourcesLambdaNoTags",
      "Effect": "Allow",
      "Action": [
        "lambda:GetAccountSettings",
        "lambda:ListFunctions",
        "iam:ListRoles"
      ]
    }
  ]
}
```

```

    ],
    "Resource": "*"
  }
]
}

```

Step 4: Grant IAM permissions

Create a policy that allows **iam:PassRole**. This permission is required when you assign an execution role to a function. In the following example policy, replace the example ARN with the ARN of your Lambda execution role.

Note

Do not use the `ResourceTag` condition key in a policy with the `iam:PassRole` action. You cannot use the tag on an IAM role to control access to who can pass that role. For more information about permissions required to pass a role to a service, see [Granting a user permissions to pass a role to an AWS service](#).

Example – Grant permission to pass the execution role

```

{
  "Version": "2012-10-17",
  "Statement": [
    {
      "Sid": "VisualEditor0",
      "Effect": "Allow",
      "Action": [
        "iam:PassRole"
      ],
      "Resource": "arn:aws:iam::111122223333:role/lambda-ex"
    }
  ]
}

```

Step 5: Create the IAM role

It's a best practice to [use roles to delegate permissions](#). [Create an IAM role](#) called `abac-project-role`:

- On **Step 1: Select trusted entity**: Choose **AWS account** and then choose **This account**.
- On **Step 2: Add permissions**: Attach the four IAM policies that you created in the previous steps.
- On **Step 3: Name, review, and create**: Choose **Add tag**. For **Key**, enter project. Don't enter a **Value**.

Step 6: Create the IAM user

[Create an IAM user](#) called `abac-test-user`. In the **Set permissions** section, choose **Attach existing policies directly** and then choose **Create policy**. Enter the following policy definition. Replace `111122223333` with your [AWS account ID](#). This policy allows `abac-test-user` to assume `abac-project-role`.

Example – Allow IAM user to assume ABAC role

```
{
  "Version": "2012-10-17",
  "Statement": {
    "Effect": "Allow",
    "Action": "sts:AssumeRole",
    "Resource": "arn:aws:iam::111122223333:role/abac-project-role"
  }
}
```

Step 7: Test the permissions

1. Sign in to the AWS console as `abac-test-user`. For more information, see [Sign in as an IAM user](#).
2. Switch to the `abac-project-role` role. For more information, see [Switching to a role \(console\)](#).
3. [Create a Lambda function](#):
 - Under **Permissions**, choose **Change default execution role**, and then for **Execution role**, choose **Use an existing role**. Choose the same execution role that you used in [Step 4: Grant IAM permissions](#).
 - Under **Advanced settings**, choose **Enable tags** and then choose **Add new tag**. For **Key**, enter project. Don't enter a **Value**.
4. [Test the function](#).

5. Create a second Lambda function and add a different tag, such as `environment`. This operation should fail because the ABAC policy that you created in [Step 1: Require tags on new functions](#) only allows the principal to create functions with the `project` tag.
6. Create a third function without tags. This operation should fail because the ABAC policy that you created in [Step 1: Require tags on new functions](#) doesn't allow the principal to create functions without tags.

This authorization strategy allows you to control access without creating new policies for each new user. To grant access to new users, simply give them permission to assume the role that corresponds to their assigned project.

Step 8: Clean up your resources

To delete the IAM role

1. Open the [Roles page](#) of the IAM console.
2. Select the role that you created in [step 5](#).
3. Choose **Delete**.
4. To confirm deletion, enter the role name in the text input field.
5. Choose **Delete**.

To delete the IAM user

1. Open the [Users page](#) of the IAM console.
2. Select the IAM user that you created in [step 6](#).
3. Choose **Delete**.
4. To confirm deletion, enter the user name in the text input field.
5. Choose **Delete user**.

To delete the Lambda function

1. Open the [Functions page](#) of the Lambda console.
2. Select the function that you created.
3. Choose **Actions, Delete**.
4. Type **confirm** in the text input field and choose **Delete**.

Fine-tuning the Resources and Conditions sections of policies

You can restrict the scope of a user's permissions by specifying resources and conditions in an AWS Identity and Access Management (IAM) policy. Each action in a policy supports a combination of resource and condition types that varies depending on the behavior of the action.

Every IAM policy statement grants permission to an action that's performed on a resource. When the action doesn't act on a named resource, or when you grant permission to perform the action on all resources, the value of the resource in the policy is a wildcard (*). For many actions, you can restrict the resources that a user can modify by specifying the Amazon Resource Name (ARN) of a resource, or an ARN pattern that matches multiple resources.

By resource type, the general design of how to restrict the scope of an action is the following:

- **Functions**—Actions that operate on a function can be restricted to a specific function by function, version, or alias ARN.
- **Event source mappings**—Actions can be restricted to specific event source mapping resources by ARN. Event source mappings are always associated with a function. You can also use the `Lambda:FunctionArn` condition to restrict actions by associated function.
- **Layers**—Actions related to layer usage and permissions act on a version of a layer.
- **Code signing configuration**—Actions can be restricted to specific code signing configuration resources by ARN.
- **Tags**—Use standard tag conditions. For more information, see [the section called "Attribute-based access control"](#).

To restrict permissions by resource, specify the resource by ARN.

Lambda resource ARN format

- **Function** – `arn:aws:lambda:us-west-2:123456789012:function:my-function`
- **Function version** – `arn:aws:lambda:us-west-2:123456789012:function:my-function:1`
- **Function alias** – `arn:aws:lambda:us-west-2:123456789012:function:my-function:TEST`
- **Event source mapping** – `arn:aws:lambda:us-west-2:123456789012:event-source-mapping:fa123456-14a1-4fd2-9fec-83de64ad683de6d47`

- Layer – `arn:aws:lambda:us-west-2:123456789012:layer:my-layer`
- Layer version – `arn:aws:lambda:us-west-2:123456789012:layer:my-layer:1`
- Code signing configuration – `arn:aws:lambda:us-west-2:123456789012:code-signing-config:my-csc`

For example, the following policy allows a user in AWS account 123456789012 to invoke a function named `my-function` in the US West (Oregon) AWS Region.

Example invoke function policy

```
{
  "Version": "2012-10-17",
  "Statement": [
    {
      "Sid": "Invoke",
      "Effect": "Allow",
      "Action": [
        "lambda:InvokeFunction"
      ],
      "Resource": "arn:aws:lambda:us-west-2:123456789012:function:my-function"
    }
  ]
}
```

This is a special case where the action identifier (`lambda:InvokeFunction`) differs from the API operation ([Invoke](#)). For other actions, the action identifier is the operation name prefixed by `lambda:`.

Sections

- [Understanding the Condition section in policies](#)
- [Referencing functions in the Resource section of policies](#)
- [Supported IAM actions and function behaviors](#)

Understanding the Condition section in policies

Conditions are an optional policy element that applies additional logic to determine if an action is allowed. In addition to common [conditions](#) that all actions support, Lambda defines condition types that you can use to restrict the values of additional parameters on some actions.

For example, the `lambda:Principal` condition lets you restrict the service or account that a user can grant invocation access to on a function's [resource-based policy](#). The following policy lets a user grant permission to Amazon Simple Notification Service (Amazon SNS) topics to invoke a function named `test`.

Example manage function policy permissions

```
{
  "Version": "2012-10-17",
  "Statement": [
    {
      "Sid": "ManageFunctionPolicy",
      "Effect": "Allow",
      "Action": [
        "lambda:AddPermission",
        "lambda:RemovePermission"
      ],
      "Resource": "arn:aws:lambda:us-west-2:123456789012:function:test:*",
      "Condition": {
        "StringEquals": {
          "lambda:Principal": "sns.amazonaws.com"
        }
      }
    }
  ]
}
```

The condition requires that the principal is Amazon SNS and not another service or account. The resource pattern requires that the function name is `test` and includes a version number or alias. For example, `test:v1`.

For more information on resources and conditions for Lambda and other AWS services, see [Actions, resources, and condition keys for AWS services](#) in the *Service Authorization Reference*.

Referencing functions in the Resource section of policies

You reference a Lambda function in a policy statement using an Amazon Resource Name (ARN). The format of a function ARN depends on whether you are referencing the whole function (unqualified) or a function [version](#) or [alias](#) (qualified).

When making Lambda API calls, users can specify a version or alias by passing a version ARN or alias ARN in the [GetFunction](#) `FunctionName` parameter, or by setting a value in the [GetFunction](#)

Qualifier parameter. Lambda makes authorization decisions by comparing the resource element in the IAM policy with both the `FunctionName` and `Qualifier` passed in API calls. If there is a mismatch, Lambda denies the request.

Whether you are allowing or denying an action on your function, you must use the correct function ARN types in your policy statement to achieve the results that you expect. For example, if your policy references the unqualified ARN, Lambda accepts requests that reference the unqualified ARN but denies requests that reference a qualified ARN.

Note

You can't use a wildcard character (*) to match the account ID. For more information on accepted syntax, see [IAM JSON policy reference](#) in the *IAM User Guide*.

Example allowing invocation of an unqualified ARN

```
{
  "Version": "2012-10-17",
  "Statement": [
    {
      "Effect": "Allow",
      "Action": "lambda:InvokeFunction",
      "Resource": "arn:aws:lambda:us-west-2:123456789012:function:myFunction"
    }
  ]
}
```

If your policy references a specific qualified ARN, Lambda accepts requests that reference that ARN but denies requests that reference the unqualified ARN or a different qualified ARN, for example, `myFunction:2`.

Example allowing invocation of a specific qualified ARN

```
{
  "Version": "2012-10-17",
  "Statement": [
    {
      "Effect": "Allow",
      "Action": "lambda:InvokeFunction",
      "Resource": "arn:aws:lambda:us-west-2:123456789012:function:myFunction:1"
    }
  ]
}
```



```

    }
  ]
}

```

If your policy references any qualified ARN using `:*`, Lambda accepts any qualified ARN but denies requests that reference the unqualified ARN.

Example allowing invocation of any qualified ARN

```

{
  "Version": "2012-10-17",
  "Statement": [
    {
      "Effect": "Allow",
      "Action": "lambda:InvokeFunction",
      "Resource": "arn:aws:lambda:us-west-2:123456789012:function:myFunction:*"
    }
  ]
}

```

If your policy references any ARN using `*`, Lambda accepts any qualified or unqualified ARN.

Example allowing invocation of any qualified or unqualified ARN

```

{
  "Version": "2012-10-17",
  "Statement": [
    {
      "Effect": "Allow",
      "Action": "lambda:InvokeFunction",
      "Resource": "arn:aws:lambda:us-west-2:123456789012:function:myFunction*"
    }
  ]
}

```

Supported IAM actions and function behaviors

Actions define what can be permitted through IAM policies. For a list of actions supported in Lambda, see [Actions, resources, and condition keys for AWS Lambda](#) in the Service Authorization Reference. In most cases, when an IAM action permits an Lambda API action, the name of the IAM action is the same as the name of the Lambda API action, with the following exceptions:

API action	IAM action
Invoke	lambda:InvokeFunction
GetLayerVersion	lambda:GetLayerVersion
GetLayerVersionByArn	

In addition to the resources and conditions defined in the Service Authorization Reference, Lambda supports the following resources and conditions for certain actions. Many of these are related to referencing functions in the resource section of policies. Actions that operate on a function can be restricted to a specific function by function, version, or alias ARN, as described in the following table.

Action	Resource	Condition
AddPermission	Function version	N/A
RemovePermission	Function alias	
Invoke — Permission: lambda:InvokeFunction		
UpdateFunctionConfiguration	N/A	lambda:CodeSigningConfigArn
CreateFunctionUrlConfig	Function alias	N/A
DeleteFunctionUrlConfig		
GetFunctionUrlConfig		
UpdateFunctionUrlConfig		

Security in AWS Lambda

Cloud security at AWS is the highest priority. As an AWS customer, you benefit from a data center and network architecture that is built to meet the requirements of the most security-sensitive organizations.

Security is a shared responsibility between AWS and you. The [shared responsibility model](#) describes this as security *of* the cloud and security *in* the cloud:

- **Security of the cloud** – AWS is responsible for protecting the infrastructure that runs AWS services in the AWS Cloud. AWS also provides you with services that you can use securely. Third-party auditors regularly test and verify the effectiveness of our security as part of the [AWS compliance programs](#). To learn about the compliance programs that apply to AWS Lambda, see [AWS services in Scope by Compliance Program](#).
- **Security in the cloud** – Your responsibility is determined by the AWS service that you use. You are also responsible for other factors including the sensitivity of your data, your company's requirements, and applicable laws and regulations.

This documentation helps you understand how to apply the shared responsibility model when using Lambda. The following topics show you how to configure Lambda to meet your security and compliance objectives. You also learn how to use other AWS services that help you to monitor and secure your Lambda resources.

For more information about applying security principles to Lambda applications, see [Security](#) in Serverless Land.

Topics

- [Data protection in AWS Lambda](#)
- [Identity and Access Management for AWS Lambda](#)
- [Create a governance strategy for Lambda functions and layers](#)
- [Compliance validation for AWS Lambda](#)
- [Resilience in AWS Lambda](#)
- [Infrastructure security in AWS Lambda](#)
- [Securing workloads with public endpoints](#)
- [Using code signing to verify code integrity with Lambda](#)

Data protection in AWS Lambda

The AWS [shared responsibility model](#) applies to data protection in AWS Lambda. As described in this model, AWS is responsible for protecting the global infrastructure that runs all of the AWS Cloud. You are responsible for maintaining control over your content that is hosted on this infrastructure. You are also responsible for the security configuration and management tasks for the AWS services that you use. For more information about data privacy, see the [Data Privacy FAQ](#). For information about data protection in Europe, see the [AWS Shared Responsibility Model and GDPR](#) blog post on the *AWS Security Blog*.

For data protection purposes, we recommend that you protect AWS account credentials and set up individual users with AWS IAM Identity Center or AWS Identity and Access Management (IAM). That way, each user is given only the permissions necessary to fulfill their job duties. We also recommend that you secure your data in the following ways:

- Use multi-factor authentication (MFA) with each account.
- Use SSL/TLS to communicate with AWS resources. We require TLS 1.2 and recommend TLS 1.3.
- Set up API and user activity logging with AWS CloudTrail. For information about using CloudTrail trails to capture AWS activities, see [Working with CloudTrail trails](#) in the *AWS CloudTrail User Guide*.
- Use AWS encryption solutions, along with all default security controls within AWS services.
- Use advanced managed security services such as Amazon Macie, which assists in discovering and securing sensitive data that is stored in Amazon S3.
- If you require FIPS 140-3 validated cryptographic modules when accessing AWS through a command line interface or an API, use a FIPS endpoint. For more information about the available FIPS endpoints, see [Federal Information Processing Standard \(FIPS\) 140-3](#).

We strongly recommend that you never put confidential or sensitive information, such as your customers' email addresses, into tags or free-form text fields such as a **Name** field. This includes when you work with Lambda or other AWS services using the console, API, AWS CLI, or AWS SDKs. Any data that you enter into tags or free-form text fields used for names may be used for billing or diagnostic logs. If you provide a URL to an external server, we strongly recommend that you do not include credentials information in the URL to validate your request to that server.

Sections

- [Encryption in transit](#)

- [Data encryption at rest for AWS Lambda](#)

Encryption in transit

Lambda API endpoints only support secure connections over HTTPS. When you manage Lambda resources with the AWS Management Console, AWS SDK, or the Lambda API, all communication is encrypted with Transport Layer Security (TLS). For a full list of API endpoints, see [AWS Regions and endpoints](#) in the AWS General Reference.

When you [connect your function to a file system](#), Lambda uses encryption in transit for all connections. For more information, see [Data encryption in Amazon EFS](#) in the *Amazon Elastic File System User Guide*.

When you use [environment variables](#), you can enable console encryption helpers to use client-side encryption to protect the environment variables in transit. For more information, see [Securing Lambda environment variables](#).

Data encryption at rest for AWS Lambda

Lambda always provides at-rest encryption for the following resources using an [AWS owned key](#) or an [AWS managed key](#):

- Environment variables
- Files that you upload to Lambda, including deployment packages and layer archives
- Event source mapping filter criteria objects

You can optionally configure Lambda to use a customer managed key to encrypt your [environment variables](#), [.zip deployment packages](#), and [filter criteria objects](#).

Amazon CloudWatch Logs and AWS X-Ray also encrypt data by default, and can be configured to use a customer managed key. For details, see [Encrypt log data in CloudWatch Logs](#) and [Data protection in AWS X-Ray](#).

Monitoring your encryption keys for Lambda

When you use an AWS KMS customer managed key with Lambda, you can use [AWS CloudTrail](#). The following examples are CloudTrail events for Decrypt, DescribeKey, and GenerateDataKey calls made by Lambda to access data encrypted by your customer managed key.

Decrypt

If you used a AWS KMS customer managed key to encrypt your [filter criteria](#) object, Lambda sends a Decrypt request on your behalf when you try to access it in plaintext (for example, from a `ListEventSourceMappings` call). The following example event records the Decrypt operation:

```
{
  "eventVersion": "1.09",
  "userIdentity": {
    "type": "AssumedRole",
    "principalId": "AROA123456789EXAMPLE:example",
    "arn": "arn:aws:sts::123456789012:assumed-role/role-name/example",
    "accountId": "123456789012",
    "accessKeyId": "ASIAIOSFODNN7EXAMPLE",
    "sessionContext": {
      "sessionIssuer": {
        "type": "Role",
        "principalId": "AROA123456789EXAMPLE",
        "arn": "arn:aws:iam::123456789012:role/role-name",
        "accountId": "123456789012",
        "userName": "role-name"
      },
      "attributes": {
        "creationDate": "2024-05-30T00:45:23Z",
        "mfaAuthenticated": "false"
      }
    },
    "invokedBy": "lambda.amazonaws.com"
  },
  "eventTime": "2024-05-30T01:05:46Z",
  "eventSource": "kms.amazonaws.com",
  "eventName": "Decrypt",
  "awsRegion": "eu-west-1",
  "sourceIPAddress": "lambda.amazonaws.com",
  "userAgent": "lambda.amazonaws.com",
  "requestParameters": {
    "keyId": "arn:aws:kms:eu-west-1:123456789012:key/a1b2c3d4-5678-90ab-cdef-EXAMPLE11111",
    "encryptionContext": {
      "aws-crypto-public-key": "ABCD
+7876787678+CDEFGHIJKL/888666888999888555444111555222888333111==",

```

```

        "aws:lambda:EventSourceArn": "arn:aws:sqs:eu-west-1:123456789012:sample-
source",
        "aws:lambda:FunctionArn": "arn:aws:lambda:eu-
west-1:123456789012:function:sample-function"
    },
    "encryptionAlgorithm": "SYMMETRIC_DEFAULT"
},
"responseElements": null,
"requestID": "a1b2c3d4-5678-90ab-cdef-EXAMPLEeaaaaa",
"eventID": "a1b2c3d4-5678-90ab-cdef-EXAMPLEebbbbb",
"readOnly": true,
"resources": [
    {
        "accountId": "AWS Internal",
        "type": "AWS::KMS::Key",
        "ARN": "arn:aws:kms:eu-west-1:123456789012:key/a1b2c3d4-5678-90ab-cdef-
EXAMPLE111111"
    }
],
"eventType": "AwsApiCall",
"managementEvent": true,
"recipientAccountId": "123456789012",
"eventCategory": "Management",
"sessionCredentialFromConsole": "true"
}

```

DescribeKey

If you used a AWS KMS customer managed key to encrypt your [filter criteria](#) object, Lambda sends a DescribeKey request on your behalf when you try to access it (for example, from a GetEventSourceMapping call). The following example event records the DescribeKey operation:

```

{
  "eventVersion": "1.09",
  "userIdentity": {
    "type": "AssumedRole",
    "principalId": "AROA123456789EXAMPLE:example",
    "arn": "arn:aws:sts::123456789012:assumed-role/role-name/example",
    "accountId": "123456789012",
    "accessKeyId": "ASIAIOSFODNN7EXAMPLE",
    "sessionContext": {
      "sessionIssuer": {

```

```

        "type": "Role",
        "principalId": "AROA123456789EXAMPLE",
        "arn": "arn:aws:iam::123456789012:role/role-name",
        "accountId": "123456789012",
        "userName": "role-name"
    },
    "attributes": {
        "creationDate": "2024-05-30T00:45:23Z",
        "mfaAuthenticated": "false"
    }
}
},
"eventTime": "2024-05-30T01:09:40Z",
"eventSource": "kms.amazonaws.com",
"eventName": "DescribeKey",
"awsRegion": "eu-west-1",
"sourceIPAddress": "54.240.197.238",
"userAgent": "Mozilla/5.0 (Macintosh; Intel Mac OS X 10_15_7) AppleWebKit/537.36
(KHTML, like Gecko) Chrome/125.0.0.0 Safari/537.36",
"requestParameters": {
    "keyId": "a1b2c3d4-5678-90ab-cdef-EXAMPLE11111"
},
"responseElements": null,
"requestID": "a1b2c3d4-5678-90ab-cdef-EXAMPLEEaaaaa",
"eventID": "a1b2c3d4-5678-90ab-cdef-EXAMPLEebbbbb",
"readOnly": true,
"resources": [
    {
        "accountId": "AWS Internal",
        "type": "AWS::KMS::Key",
        "ARN": "arn:aws:kms:eu-west-1:123456789012:key/a1b2c3d4-5678-90ab-cdef-
EXAMPLE11111"
    }
],
"eventType": "AwsApiCall",
"managementEvent": true,
"recipientAccountId": "123456789012",
"eventCategory": "Management",
"tlsDetails": {
    "tlsVersion": "TLSv1.3",
    "cipherSuite": "TLS_AES_256_GCM_SHA384",
    "clientProvidedHostHeader": "kms.eu-west-1.amazonaws.com"
},
"sessionCredentialFromConsole": "true"

```



```
}
```

GenerateDataKey

When you use a AWS KMS customer managed key to encrypt your [filter criteria](#) object in a `CreateEventSourceMapping` or `UpdateEventSourceMapping` call, Lambda sends a `GenerateDataKey` request on your behalf to generate a data key to encrypt the filter criteria ([envelope encryption](#)). The following example event records the `GenerateDataKey` operation:

```
{
  "eventVersion": "1.09",
  "userIdentity": {
    "type": "AssumedRole",
    "principalId": "AROAI23456789EXAMPLE:example",
    "arn": "arn:aws:sts::123456789012:assumed-role/role-name/example",
    "accountId": "123456789012",
    "accessKeyId": "ASIAIOSFODNN7EXAMPLE",
    "sessionContext": {
      "sessionIssuer": {
        "type": "Role",
        "principalId": "AROAI23456789EXAMPLE",
        "arn": "arn:aws:iam::123456789012:role/role-name",
        "accountId": "123456789012",
        "userName": "role-name"
      },
      "attributes": {
        "creationDate": "2024-05-30T00:06:07Z",
        "mfaAuthenticated": "false"
      }
    },
    "invokedBy": "lambda.amazonaws.com"
  },
  "eventTime": "2024-05-30T01:04:18Z",
  "eventSource": "kms.amazonaws.com",
  "eventName": "GenerateDataKey",
  "awsRegion": "eu-west-1",
  "sourceIPAddress": "lambda.amazonaws.com",
  "userAgent": "lambda.amazonaws.com",
  "requestParameters": {
    "numberOfBytes": 32,
    "keyId": "arn:aws:kms:eu-west-1:123456789012:key/a1b2c3d4-5678-90ab-cdef-EXAMPLE11111",
    "encryptionContext": {
```

```
    "aws-crypto-public-key": "ABCD
+7876787678+CDEFGHIJKL/888666888999888555444111555222888333111==",
    "aws:lambda:EventSourceArn": "arn:aws:sqs:eu-west-1:123456789012:sample-
source",
    "aws:lambda:FunctionArn": "arn:aws:lambda:eu-
west-1:123456789012:function:sample-function"
  },
},
"responseElements": null,
"requestID": "a1b2c3d4-5678-90ab-cdef-EXAMPLEEaaaaa",
"eventID": "a1b2c3d4-5678-90ab-cdef-EXAMPLEebbbbb",
"readOnly": true,
"resources": [
  {
    "accountId": "AWS Internal",
    "type": "AWS::KMS::Key",
    "ARN": "arn:aws:kms:eu-west-1:123456789012:key/a1b2c3d4-5678-90ab-cdef-
EXAMPLE111111"
  }
],
"eventType": "AwsApiCall",
"managementEvent": true,
"recipientAccountId": "123456789012",
"eventCategory": "Management"
}
```

Identity and Access Management for AWS Lambda

AWS Identity and Access Management (IAM) is an AWS service that helps an administrator securely control access to AWS resources. IAM administrators control who can be *authenticated* (signed in) and *authorized* (have permissions) to use Lambda resources. IAM is an AWS service that you can use with no additional charge.

Topics

- [Audience](#)
- [Authenticating with identities](#)
- [Managing access using policies](#)
- [How AWS Lambda works with IAM](#)

- [Identity-based policy examples for AWS Lambda](#)
- [AWS managed policies for AWS Lambda](#)
- [Troubleshooting AWS Lambda identity and access](#)

Audience

How you use AWS Identity and Access Management (IAM) differs, depending on the work that you do in Lambda.

Service user – If you use the Lambda service to do your job, then your administrator provides you with the credentials and permissions that you need. As you use more Lambda features to do your work, you might need additional permissions. Understanding how access is managed can help you request the right permissions from your administrator. If you cannot access a feature in Lambda, see [Troubleshooting AWS Lambda identity and access](#).

Service administrator – If you're in charge of Lambda resources at your company, you probably have full access to Lambda. It's your job to determine which Lambda features and resources your service users should access. You must then submit requests to your IAM administrator to change the permissions of your service users. Review the information on this page to understand the basic concepts of IAM. To learn more about how your company can use IAM with Lambda, see [How AWS Lambda works with IAM](#).

IAM administrator – If you're an IAM administrator, you might want to learn details about how you can write policies to manage access to Lambda. To view example Lambda identity-based policies that you can use in IAM, see [Identity-based policy examples for AWS Lambda](#).

Authenticating with identities

Authentication is how you sign in to AWS using your identity credentials. You must be *authenticated* (signed in to AWS) as the AWS account root user, as an IAM user, or by assuming an IAM role.

You can sign in to AWS as a federated identity by using credentials provided through an identity source. AWS IAM Identity Center (IAM Identity Center) users, your company's single sign-on authentication, and your Google or Facebook credentials are examples of federated identities. When you sign in as a federated identity, your administrator previously set up identity federation using IAM roles. When you access AWS by using federation, you are indirectly assuming a role.

Depending on the type of user you are, you can sign in to the AWS Management Console or the AWS access portal. For more information about signing in to AWS, see [How to sign in to your AWS account](#) in the *AWS Sign-In User Guide*.

If you access AWS programmatically, AWS provides a software development kit (SDK) and a command line interface (CLI) to cryptographically sign your requests by using your credentials. If you don't use AWS tools, you must sign requests yourself. For more information about using the recommended method to sign requests yourself, see [AWS Signature Version 4 for API requests](#) in the *IAM User Guide*.

Regardless of the authentication method that you use, you might be required to provide additional security information. For example, AWS recommends that you use multi-factor authentication (MFA) to increase the security of your account. To learn more, see [Multi-factor authentication](#) in the *AWS IAM Identity Center User Guide* and [AWS Multi-factor authentication in IAM](#) in the *IAM User Guide*.

AWS account root user

When you create an AWS account, you begin with one sign-in identity that has complete access to all AWS services and resources in the account. This identity is called the AWS account *root user* and is accessed by signing in with the email address and password that you used to create the account. We strongly recommend that you don't use the root user for your everyday tasks. Safeguard your root user credentials and use them to perform the tasks that only the root user can perform. For the complete list of tasks that require you to sign in as the root user, see [Tasks that require root user credentials](#) in the *IAM User Guide*.

Federated identity

As a best practice, require human users, including users that require administrator access, to use federation with an identity provider to access AWS services by using temporary credentials.

A *federated identity* is a user from your enterprise user directory, a web identity provider, the AWS Directory Service, the Identity Center directory, or any user that accesses AWS services by using credentials provided through an identity source. When federated identities access AWS accounts, they assume roles, and the roles provide temporary credentials.

For centralized access management, we recommend that you use AWS IAM Identity Center. You can create users and groups in IAM Identity Center, or you can connect and synchronize to a set of users and groups in your own identity source for use across all your AWS accounts and applications. For

information about IAM Identity Center, see [What is IAM Identity Center?](#) in the *AWS IAM Identity Center User Guide*.

IAM users and groups

An [IAM user](#) is an identity within your AWS account that has specific permissions for a single person or application. Where possible, we recommend relying on temporary credentials instead of creating IAM users who have long-term credentials such as passwords and access keys. However, if you have specific use cases that require long-term credentials with IAM users, we recommend that you rotate access keys. For more information, see [Rotate access keys regularly for use cases that require long-term credentials](#) in the *IAM User Guide*.

An [IAM group](#) is an identity that specifies a collection of IAM users. You can't sign in as a group. You can use groups to specify permissions for multiple users at a time. Groups make permissions easier to manage for large sets of users. For example, you could have a group named *IAMAdmins* and give that group permissions to administer IAM resources.

Users are different from roles. A user is uniquely associated with one person or application, but a role is intended to be assumable by anyone who needs it. Users have permanent long-term credentials, but roles provide temporary credentials. To learn more, see [Use cases for IAM users](#) in the *IAM User Guide*.

IAM roles

An [IAM role](#) is an identity within your AWS account that has specific permissions. It is similar to an IAM user, but is not associated with a specific person. To temporarily assume an IAM role in the AWS Management Console, you can [switch from a user to an IAM role \(console\)](#). You can assume a role by calling an AWS CLI or AWS API operation or by using a custom URL. For more information about methods for using roles, see [Methods to assume a role](#) in the *IAM User Guide*.

IAM roles with temporary credentials are useful in the following situations:

- **Federated user access** – To assign permissions to a federated identity, you create a role and define permissions for the role. When a federated identity authenticates, the identity is associated with the role and is granted the permissions that are defined by the role. For information about roles for federation, see [Create a role for a third-party identity provider \(federation\)](#) in the *IAM User Guide*. If you use IAM Identity Center, you configure a permission set. To control what your identities can access after they authenticate, IAM Identity Center correlates the permission set to a role in IAM. For information about permissions sets, see [Permission sets](#) in the *AWS IAM Identity Center User Guide*.

- **Temporary IAM user permissions** – An IAM user or role can assume an IAM role to temporarily take on different permissions for a specific task.
- **Cross-account access** – You can use an IAM role to allow someone (a trusted principal) in a different account to access resources in your account. Roles are the primary way to grant cross-account access. However, with some AWS services, you can attach a policy directly to a resource (instead of using a role as a proxy). To learn the difference between roles and resource-based policies for cross-account access, see [Cross account resource access in IAM](#) in the *IAM User Guide*.
- **Cross-service access** – Some AWS services use features in other AWS services. For example, when you make a call in a service, it's common for that service to run applications in Amazon EC2 or store objects in Amazon S3. A service might do this using the calling principal's permissions, using a service role, or using a service-linked role.
 - **Forward access sessions (FAS)** – When you use an IAM user or role to perform actions in AWS, you are considered a principal. When you use some services, you might perform an action that then initiates another action in a different service. FAS uses the permissions of the principal calling an AWS service, combined with the requesting AWS service to make requests to downstream services. FAS requests are only made when a service receives a request that requires interactions with other AWS services or resources to complete. In this case, you must have permissions to perform both actions. For policy details when making FAS requests, see [Forward access sessions](#).
 - **Service role** – A service role is an [IAM role](#) that a service assumes to perform actions on your behalf. An IAM administrator can create, modify, and delete a service role from within IAM. For more information, see [Create a role to delegate permissions to an AWS service](#) in the *IAM User Guide*.
 - **Service-linked role** – A service-linked role is a type of service role that is linked to an AWS service. The service can assume the role to perform an action on your behalf. Service-linked roles appear in your AWS account and are owned by the service. An IAM administrator can view, but not edit the permissions for service-linked roles.
- **Applications running on Amazon EC2** – You can use an IAM role to manage temporary credentials for applications that are running on an EC2 instance and making AWS CLI or AWS API requests. This is preferable to storing access keys within the EC2 instance. To assign an AWS role to an EC2 instance and make it available to all of its applications, you create an instance profile that is attached to the instance. An instance profile contains the role and enables programs that are running on the EC2 instance to get temporary credentials. For more information, see [Use an IAM role to grant permissions to applications running on Amazon EC2 instances](#) in the *IAM User Guide*.

Managing access using policies

You control access in AWS by creating policies and attaching them to AWS identities or resources. A policy is an object in AWS that, when associated with an identity or resource, defines their permissions. AWS evaluates these policies when a principal (user, root user, or role session) makes a request. Permissions in the policies determine whether the request is allowed or denied. Most policies are stored in AWS as JSON documents. For more information about the structure and contents of JSON policy documents, see [Overview of JSON policies](#) in the *IAM User Guide*.

Administrators can use AWS JSON policies to specify who has access to what. That is, which **principal** can perform **actions** on what **resources**, and under what **conditions**.

By default, users and roles have no permissions. To grant users permission to perform actions on the resources that they need, an IAM administrator can create IAM policies. The administrator can then add the IAM policies to roles, and users can assume the roles.

IAM policies define permissions for an action regardless of the method that you use to perform the operation. For example, suppose that you have a policy that allows the `iam:GetRole` action. A user with that policy can get role information from the AWS Management Console, the AWS CLI, or the AWS API.

Identity-based policies

Identity-based policies are JSON permissions policy documents that you can attach to an identity, such as an IAM user, group of users, or role. These policies control what actions users and roles can perform, on which resources, and under what conditions. To learn how to create an identity-based policy, see [Define custom IAM permissions with customer managed policies](#) in the *IAM User Guide*.

Identity-based policies can be further categorized as *inline policies* or *managed policies*. Inline policies are embedded directly into a single user, group, or role. Managed policies are standalone policies that you can attach to multiple users, groups, and roles in your AWS account. Managed policies include AWS managed policies and customer managed policies. To learn how to choose between a managed policy or an inline policy, see [Choose between managed policies and inline policies](#) in the *IAM User Guide*.

Resource-based policies

Resource-based policies are JSON policy documents that you attach to a resource. Examples of resource-based policies are IAM *role trust policies* and Amazon S3 *bucket policies*. In services that support resource-based policies, service administrators can use them to control access to a specific

resource. For the resource where the policy is attached, the policy defines what actions a specified principal can perform on that resource and under what conditions. You must [specify a principal](#) in a resource-based policy. Principals can include accounts, users, roles, federated users, or AWS services.

Resource-based policies are inline policies that are located in that service. You can't use AWS managed policies from IAM in a resource-based policy.

Access control lists (ACLs)

Access control lists (ACLs) control which principals (account members, users, or roles) have permissions to access a resource. ACLs are similar to resource-based policies, although they do not use the JSON policy document format.

Amazon S3, AWS WAF, and Amazon VPC are examples of services that support ACLs. To learn more about ACLs, see [Access control list \(ACL\) overview](#) in the *Amazon Simple Storage Service Developer Guide*.

Other policy types

AWS supports additional, less-common policy types. These policy types can set the maximum permissions granted to you by the more common policy types.

- **Permissions boundaries** – A permissions boundary is an advanced feature in which you set the maximum permissions that an identity-based policy can grant to an IAM entity (IAM user or role). You can set a permissions boundary for an entity. The resulting permissions are the intersection of an entity's identity-based policies and its permissions boundaries. Resource-based policies that specify the user or role in the `Principal` field are not limited by the permissions boundary. An explicit deny in any of these policies overrides the allow. For more information about permissions boundaries, see [Permissions boundaries for IAM entities](#) in the *IAM User Guide*.
- **Service control policies (SCPs)** – SCPs are JSON policies that specify the maximum permissions for an organization or organizational unit (OU) in AWS Organizations. AWS Organizations is a service for grouping and centrally managing multiple AWS accounts that your business owns. If you enable all features in an organization, then you can apply service control policies (SCPs) to any or all of your accounts. The SCP limits permissions for entities in member accounts, including each AWS account root user. For more information about Organizations and SCPs, see [Service control policies](#) in the *AWS Organizations User Guide*.
- **Resource control policies (RCPs)** – RCPs are JSON policies that you can use to set the maximum available permissions for resources in your accounts without updating the IAM policies attached

to each resource that you own. The RCP limits permissions for resources in member accounts and can impact the effective permissions for identities, including the AWS account root user, regardless of whether they belong to your organization. For more information about Organizations and RCPs, including a list of AWS services that support RCPs, see [Resource control policies \(RCPs\)](#) in the *AWS Organizations User Guide*.

- **Session policies** – Session policies are advanced policies that you pass as a parameter when you programmatically create a temporary session for a role or federated user. The resulting session's permissions are the intersection of the user or role's identity-based policies and the session policies. Permissions can also come from a resource-based policy. An explicit deny in any of these policies overrides the allow. For more information, see [Session policies](#) in the *IAM User Guide*.

Multiple policy types

When multiple types of policies apply to a request, the resulting permissions are more complicated to understand. To learn how AWS determines whether to allow a request when multiple policy types are involved, see [Policy evaluation logic](#) in the *IAM User Guide*.

How AWS Lambda works with IAM

Before you use IAM to manage access to Lambda, learn what IAM features are available to use with Lambda.

IAM feature	Lambda support
Identity-based policies	Yes
Resource-based policies	Yes
Policy actions	Yes
Policy resources	Yes
Policy condition keys (service-specific)	Yes
ACLs	No
ABAC (tags in policies)	Partial

IAM feature	Lambda support
Temporary credentials	Yes
Forward access sessions (FAS)	No
Service roles	Yes
Service-linked roles	Partial

To get a high-level view of how Lambda and other AWS services work with most IAM features, see [AWS services that work with IAM](#) in the *IAM User Guide*.

Identity-based policies for Lambda

Supports identity-based policies: Yes

Identity-based policies are JSON permissions policy documents that you can attach to an identity, such as an IAM user, group of users, or role. These policies control what actions users and roles can perform, on which resources, and under what conditions. To learn how to create an identity-based policy, see [Define custom IAM permissions with customer managed policies](#) in the *IAM User Guide*.

With IAM identity-based policies, you can specify allowed or denied actions and resources as well as the conditions under which actions are allowed or denied. You can't specify the principal in an identity-based policy because it applies to the user or role to which it is attached. To learn about all of the elements that you can use in a JSON policy, see [IAM JSON policy elements reference](#) in the *IAM User Guide*.

Identity-based policy examples for Lambda

To view examples of Lambda identity-based policies, see [Identity-based policy examples for AWS Lambda](#).

Resource-based policies within Lambda

Supports resource-based policies: Yes

Resource-based policies are JSON policy documents that you attach to a resource. Examples of resource-based policies are *IAM role trust policies* and *Amazon S3 bucket policies*. In services that

support resource-based policies, service administrators can use them to control access to a specific resource. For the resource where the policy is attached, the policy defines what actions a specified principal can perform on that resource and under what conditions. You must [specify a principal](#) in a resource-based policy. Principals can include accounts, users, roles, federated users, or AWS services.

To enable cross-account access, you can specify an entire account or IAM entities in another account as the principal in a resource-based policy. Adding a cross-account principal to a resource-based policy is only half of establishing the trust relationship. When the principal and the resource are in different AWS accounts, an IAM administrator in the trusted account must also grant the principal entity (user or role) permission to access the resource. They grant permission by attaching an identity-based policy to the entity. However, if a resource-based policy grants access to a principal in the same account, no additional identity-based policy is required. For more information, see [Cross account resource access in IAM](#) in the *IAM User Guide*.

You can attach a resource-based policy to a Lambda function or layer. This policy defines which principals can perform actions on the function or layer.

To learn how to attach a resource-based policy to a function or layer, see [Viewing resource-based IAM policies in Lambda](#).

Policy actions for Lambda

Supports policy actions: Yes

Administrators can use AWS JSON policies to specify who has access to what. That is, which **principal** can perform **actions** on what **resources**, and under what **conditions**.

The `Action` element of a JSON policy describes the actions that you can use to allow or deny access in a policy. Policy actions usually have the same name as the associated AWS API operation. There are some exceptions, such as *permission-only actions* that don't have a matching API operation. There are also some operations that require multiple actions in a policy. These additional actions are called *dependent actions*.

Include actions in a policy to grant permissions to perform the associated operation.

To see a list of Lambda actions, see [Actions defined by AWS Lambda](#) in the *Service Authorization Reference*.

Policy actions in Lambda use the following prefix before the action:

```
lambda
```

To specify multiple actions in a single statement, separate them with commas.

```
"Action": [  
    "lambda:action1",  
    "lambda:action2"  
]
```

To view examples of Lambda identity-based policies, see [Identity-based policy examples for AWS Lambda](#).

Policy resources for Lambda

Supports policy resources: Yes

Administrators can use AWS JSON policies to specify who has access to what. That is, which **principal** can perform **actions** on what **resources**, and under what **conditions**.

The Resource JSON policy element specifies the object or objects to which the action applies. Statements must include either a Resource or a NotResource element. As a best practice, specify a resource using its [Amazon Resource Name \(ARN\)](#). You can do this for actions that support a specific resource type, known as *resource-level permissions*.

For actions that don't support resource-level permissions, such as listing operations, use a wildcard (*) to indicate that the statement applies to all resources.

```
"Resource": "*"
```

To see a list of Lambda resource types and their ARNs, see [Resource types defined by AWS Lambda](#) in the *Service Authorization Reference*. To learn with which actions you can specify the ARN of each resource, see [Actions defined by AWS Lambda](#).

To view examples of Lambda identity-based policies, see [Identity-based policy examples for AWS Lambda](#).

Policy condition keys for Lambda

Supports service-specific policy condition keys: Yes

Administrators can use AWS JSON policies to specify who has access to what. That is, which **principal** can perform **actions** on what **resources**, and under what **conditions**.

The Condition element (or Condition *block*) lets you specify conditions in which a statement is in effect. The Condition element is optional. You can create conditional expressions that use [condition operators](#), such as equals or less than, to match the condition in the policy with values in the request.

If you specify multiple Condition elements in a statement, or multiple keys in a single Condition element, AWS evaluates them using a logical AND operation. If you specify multiple values for a single condition key, AWS evaluates the condition using a logical OR operation. All of the conditions must be met before the statement's permissions are granted.

You can also use placeholder variables when you specify conditions. For example, you can grant an IAM user permission to access a resource only if it is tagged with their IAM user name. For more information, see [IAM policy elements: variables and tags](#) in the *IAM User Guide*.

AWS supports global condition keys and service-specific condition keys. To see all AWS global condition keys, see [AWS global condition context keys](#) in the *IAM User Guide*.

To see a list of Lambda condition keys, see [Condition keys for AWS Lambda](#) in the *Service Authorization Reference*. To learn with which actions and resources you can use a condition key, see [Actions defined by AWS Lambda](#).

To view examples of Lambda identity-based policies, see [Identity-based policy examples for AWS Lambda](#).

ACLs in Lambda

Supports ACLs: No

Access control lists (ACLs) control which principals (account members, users, or roles) have permissions to access a resource. ACLs are similar to resource-based policies, although they do not use the JSON policy document format.

ABAC with Lambda

Supports ABAC (tags in policies): Partial

Attribute-based access control (ABAC) is an authorization strategy that defines permissions based on attributes. In AWS, these attributes are called *tags*. You can attach tags to IAM entities (users or roles) and to many AWS resources. Tagging entities and resources is the first step of ABAC. Then you design ABAC policies to allow operations when the principal's tag matches the tag on the resource that they are trying to access.

ABAC is helpful in environments that are growing rapidly and helps with situations where policy management becomes cumbersome.

To control access based on tags, you provide tag information in the [condition element](#) of a policy using the `aws:ResourceTag/key-name`, `aws:RequestTag/key-name`, or `aws:TagKeys` condition keys.

If a service supports all three condition keys for every resource type, then the value is **Yes** for the service. If a service supports all three condition keys for only some resource types, then the value is **Partial**.

For more information about ABAC, see [Define permissions with ABAC authorization](#) in the *IAM User Guide*. To view a tutorial with steps for setting up ABAC, see [Use attribute-based access control \(ABAC\)](#) in the *IAM User Guide*.

For more information about tagging Lambda resources, see [Using attribute-based access control in Lambda](#).

Using temporary credentials with Lambda

Supports temporary credentials: Yes

Some AWS services don't work when you sign in using temporary credentials. For additional information, including which AWS services work with temporary credentials, see [AWS services that work with IAM](#) in the *IAM User Guide*.

You are using temporary credentials if you sign in to the AWS Management Console using any method except a user name and password. For example, when you access AWS using your company's single sign-on (SSO) link, that process automatically creates temporary credentials. You also automatically create temporary credentials when you sign in to the console as a user and then switch roles. For more information about switching roles, see [Switch from a user to an IAM role \(console\)](#) in the *IAM User Guide*.

You can manually create temporary credentials using the AWS CLI or AWS API. You can then use those temporary credentials to access AWS. AWS recommends that you dynamically generate

temporary credentials instead of using long-term access keys. For more information, see [Temporary security credentials in IAM](#).

Forward access sessions for Lambda

Supports forward access sessions (FAS): No

When you use an IAM user or role to perform actions in AWS, you are considered a principal. When you use some services, you might perform an action that then initiates another action in a different service. FAS uses the permissions of the principal calling an AWS service, combined with the requesting AWS service to make requests to downstream services. FAS requests are only made when a service receives a request that requires interactions with other AWS services or resources to complete. In this case, you must have permissions to perform both actions. For policy details when making FAS requests, see [Forward access sessions](#).

Service roles for Lambda

Supports service roles: Yes

A service role is an [IAM role](#) that a service assumes to perform actions on your behalf. An IAM administrator can create, modify, and delete a service role from within IAM. For more information, see [Create a role to delegate permissions to an AWS service](#) in the *IAM User Guide*.

In Lambda, a service role is known as an [execution role](#).

Warning

Changing the permissions for an execution role might break Lambda functionality.

Service-linked roles for Lambda

Supports service-linked roles: Partial

A service-linked role is a type of service role that is linked to an AWS service. The service can assume the role to perform an action on your behalf. Service-linked roles appear in your AWS account and are owned by the service. An IAM administrator can view, but not edit the permissions for service-linked roles.

Lambda doesn't have service-linked roles, but Lambda@Edge does. For more information, see [Service-Linked Roles for Lambda@Edge](#) in the *Amazon CloudFront Developer Guide*.

For details about creating or managing service-linked roles, see [AWS services that work with IAM](#). Find a service in the table that includes a Yes in the **Service-linked role** column. Choose the **Yes** link to view the service-linked role documentation for that service.

Identity-based policy examples for AWS Lambda

By default, users and roles don't have permission to create or modify Lambda resources. They also can't perform tasks by using the AWS Management Console, AWS Command Line Interface (AWS CLI), or AWS API. To grant users permission to perform actions on the resources that they need, an IAM administrator can create IAM policies. The administrator can then add the IAM policies to roles, and users can assume the roles.

To learn how to create an IAM identity-based policy by using these example JSON policy documents, see [Create IAM policies \(console\)](#) in the *IAM User Guide*.

For details about actions and resource types defined by Lambda, including the format of the ARNs for each of the resource types, see [Actions, resources, and condition keys for AWS Lambda](#) in the *Service Authorization Reference*.

Topics

- [Policy best practices](#)
- [Using the Lambda console](#)
- [Allow users to view their own permissions](#)

Policy best practices

Identity-based policies determine whether someone can create, access, or delete Lambda resources in your account. These actions can incur costs for your AWS account. When you create or edit identity-based policies, follow these guidelines and recommendations:

- **Get started with AWS managed policies and move toward least-privilege permissions** – To get started granting permissions to your users and workloads, use the *AWS managed policies* that grant permissions for many common use cases. They are available in your AWS account. We recommend that you reduce permissions further by defining AWS customer managed policies that are specific to your use cases. For more information, see [AWS managed policies](#) or [AWS managed policies for job functions](#) in the *IAM User Guide*.
- **Apply least-privilege permissions** – When you set permissions with IAM policies, grant only the permissions required to perform a task. You do this by defining the actions that can be taken on

specific resources under specific conditions, also known as *least-privilege permissions*. For more information about using IAM to apply permissions, see [Policies and permissions in IAM](#) in the *IAM User Guide*.

- **Use conditions in IAM policies to further restrict access** – You can add a condition to your policies to limit access to actions and resources. For example, you can write a policy condition to specify that all requests must be sent using SSL. You can also use conditions to grant access to service actions if they are used through a specific AWS service, such as AWS CloudFormation. For more information, see [IAM JSON policy elements: Condition](#) in the *IAM User Guide*.
- **Use IAM Access Analyzer to validate your IAM policies to ensure secure and functional permissions** – IAM Access Analyzer validates new and existing policies so that the policies adhere to the IAM policy language (JSON) and IAM best practices. IAM Access Analyzer provides more than 100 policy checks and actionable recommendations to help you author secure and functional policies. For more information, see [Validate policies with IAM Access Analyzer](#) in the *IAM User Guide*.
- **Require multi-factor authentication (MFA)** – If you have a scenario that requires IAM users or a root user in your AWS account, turn on MFA for additional security. To require MFA when API operations are called, add MFA conditions to your policies. For more information, see [Secure API access with MFA](#) in the *IAM User Guide*.

For more information about best practices in IAM, see [Security best practices in IAM](#) in the *IAM User Guide*.

Using the Lambda console

To access the AWS Lambda console, you must have a minimum set of permissions. These permissions must allow you to list and view details about the Lambda resources in your AWS account. If you create an identity-based policy that is more restrictive than the minimum required permissions, the console won't function as intended for entities (users or roles) with that policy.

You don't need to allow minimum console permissions for users that are making calls only to the AWS CLI or the AWS API. Instead, allow access to only the actions that match the API operation that they're trying to perform.

For an example policy that grants minimal access for function development, see [Granting users access to a Lambda function](#). In addition to Lambda APIs, the Lambda console uses other services to display trigger configuration and let you add new triggers. If your users use Lambda with other

services, they need access to those services as well. For details on configuring other services with Lambda, see [Invoking Lambda with events from other AWS services](#).

Allow users to view their own permissions

This example shows how you might create a policy that allows IAM users to view the inline and managed policies that are attached to their user identity. This policy includes permissions to complete this action on the console or programmatically using the AWS CLI or AWS API.

```
{
  "Version": "2012-10-17",
  "Statement": [
    {
      "Sid": "ViewOwnUserInfo",
      "Effect": "Allow",
      "Action": [
        "iam:GetUserPolicy",
        "iam:ListGroupsForUser",
        "iam:ListAttachedUserPolicies",
        "iam:ListUserPolicies",
        "iam:GetUser"
      ],
      "Resource": ["arn:aws:iam::*:user/${aws:username}"]
    },
    {
      "Sid": "NavigateInConsole",
      "Effect": "Allow",
      "Action": [
        "iam:GetGroupPolicy",
        "iam:GetPolicyVersion",
        "iam:GetPolicy",
        "iam:ListAttachedGroupPolicies",
        "iam:ListGroupPolicies",
        "iam:ListPolicyVersions",
        "iam:ListPolicies",
        "iam:ListUsers"
      ],
      "Resource": "*"
    }
  ]
}
```

AWS managed policies for AWS Lambda

An AWS managed policy is a standalone policy that is created and administered by AWS. AWS managed policies are designed to provide permissions for many common use cases so that you can start assigning permissions to users, groups, and roles.

Keep in mind that AWS managed policies might not grant least-privilege permissions for your specific use cases because they're available for all AWS customers to use. We recommend that you reduce permissions further by defining [customer managed policies](#) that are specific to your use cases.

You cannot change the permissions defined in AWS managed policies. If AWS updates the permissions defined in an AWS managed policy, the update affects all principal identities (users, groups, and roles) that the policy is attached to. AWS is most likely to update an AWS managed policy when a new AWS service is launched or new API operations become available for existing services.

For more information, see [AWS managed policies](#) in the *IAM User Guide*.

Topics

- [AWS managed policy: AWSLambda_FullAccess](#)
- [AWS managed policy: AWSLambda_ReadOnlyAccess](#)
- [AWS managed policy: AWSLambdaBasicExecutionRole](#)
- [AWS managed policy: AWSLambdaDynamoDBExecutionRole](#)
- [AWS managed policy: AWSLambdaENIManagementAccess](#)
- [AWS managed policy: AWSLambdaExecute](#)
- [AWS managed policy: AWSLambdaInvocation-DynamoDB](#)
- [AWS managed policy: AWSLambdaKinesisExecutionRole](#)
- [AWS managed policy: AWSLambdaMSKExecutionRole](#)
- [AWS managed policy: AWSLambdaRole](#)
- [AWS managed policy: AWSLambdaSQSQueueExecutionRole](#)
- [AWS managed policy: AWSLambdaVPCLambdaAccessExecutionRole](#)
- [Lambda updates to AWS managed policies](#)

AWS managed policy: AWSLambda_FullAccess

This policy grants full access to Lambda actions. It also grants permissions to other AWS services that are used to develop and maintain Lambda resources.

You can attach the `AWSLambda_FullAccess` policy to your users, groups, and roles.

Permissions details

This policy includes the following permissions:

- `lambda` – Allows principals full access to Lambda.
- `cloudformation` – Allows principals to describe AWS CloudFormation stacks and list the resources in those stacks.
- `cloudwatch` – Allows principals to list Amazon CloudWatch metrics and get metric data.
- `ec2` – Allows principals to describe security groups, subnets, and VPCs.
- `iam` – Allows principals to get policies, policy versions, roles, role policies, attached role policies, and the list of roles. This policy also allows principals to pass roles to Lambda. The `PassRole` permission is used when you assign an execution role to a function.
- `kms` – Allows principals to list aliases.
- `logs` – Allows principals to describe Amazon CloudWatch log groups. For log groups that are associated with a Lambda function, this policy allows the principal to describe log streams, get log events, and filter log events.
- `states` – Allows principals to describe and list AWS Step Functions state machines.
- `tag` – Allows principals to get resources based on their tags.
- `xray` – Allows principals to get AWS X-Ray trace summaries and retrieve a list of traces specified by ID.

For more information about this policy, including the JSON policy document and policy versions, see [AWSLambda_FullAccess](#) in the *AWS Managed Policy Reference Guide*.

AWS managed policy: AWSLambda_ReadOnlyAccess

This policy grants read-only access to Lambda resources and to other AWS services that are used to develop and maintain Lambda resources.

You can attach the `AWSLambda_ReadOnlyAccess` policy to your users, groups, and roles.

Permissions details

This policy includes the following permissions:

- `lambda` – Allows principals to get and list all resources.
- `cloudformation` – Allows principals to describe and list AWS CloudFormation stacks and list the resources in those stacks.
- `cloudwatch` – Allows principals to list Amazon CloudWatch metrics and get metric data.
- `ec2` – Allows principals to describe security groups, subnets, and VPCs.
- `iam` – Allows principals to get policies, policy versions, roles, role policies, attached role policies, and the list of roles.
- `kms` – Allows principals to list aliases.
- `logs` – Allows principals to describe Amazon CloudWatch log groups. For log groups that are associated with a Lambda function, this policy allows the principal to describe log streams, get log events, and filter log events.
- `states` – Allows principals to describe and list AWS Step Functions state machines.
- `tag` – Allows principals to get resources based on their tags.
- `xray` – Allows principals to get AWS X-Ray trace summaries and retrieve a list of traces specified by ID.

For more information about this policy, including the JSON policy document and policy versions, see [AWSLambda_ReadOnlyAccess](#) in the *AWS Managed Policy Reference Guide*.

AWS managed policy: AWSLambdaBasicExecutionRole

This policy grants permissions to upload logs to CloudWatch Logs.

You can attach the `AWSLambdaBasicExecutionRole` policy to your users, groups, and roles.

For more information about this policy, including the JSON policy document and policy versions, see [AWSLambdaBasicExecutionRole](#) in the *AWS Managed Policy Reference Guide*.

AWS managed policy: AWSLambdaDynamoDBExecutionRole

This policy grants permissions to read records from an Amazon DynamoDB stream and write to CloudWatch Logs.

You can attach the `AWSLambdaDynamoDBExecutionRole` policy to your users, groups, and roles.

For more information about this policy, including the JSON policy document and policy versions, see [AWSLambdaDynamoDBExecutionRole](#) in the *AWS Managed Policy Reference Guide*.

AWS managed policy: AWSLambdaENIManagementAccess

This policy grants permissions to create, describe, and delete elastic network interfaces used by a VPC-enabled Lambda function.

You can attach the `AWSLambdaENIManagementAccess` policy to your users, groups, and roles.

For more information about this policy, including the JSON policy document and policy versions, see [AWSLambdaENIManagementAccess](#) in the *AWS Managed Policy Reference Guide*.

AWS managed policy: AWSLambdaExecute

This policy grants PUT and GET access to Amazon Simple Storage Service and full access to CloudWatch Logs.

You can attach the `AWSLambdaExecute` policy to your users, groups, and roles.

For more information about this policy, including the JSON policy document and policy versions, see [AWSLambdaExecute](#) in the *AWS Managed Policy Reference Guide*.

AWS managed policy: AWSLambdaInvocation-DynamoDB

This policy grants read access to Amazon DynamoDB Streams.

You can attach the `AWSLambdaInvocation-DynamoDB` policy to your users, groups, and roles.

For more information about this policy, including the JSON policy document and policy versions, see [AWSLambdaInvocation-DynamoDB](#) in the *AWS Managed Policy Reference Guide*.

AWS managed policy: AWSLambdaKinesisExecutionRole

This policy grants permissions to read events from an Amazon Kinesis data stream and write to CloudWatch Logs.

You can attach the `AWSLambdaKinesisExecutionRole` policy to your users, groups, and roles.

For more information about this policy, including the JSON policy document and policy versions, see [AWSLambdaKinesisExecutionRole](#) in the *AWS Managed Policy Reference Guide*.

AWS managed policy: AWSLambdaMSKExecutionRole

This policy grants permissions to read and access records from an Amazon Managed Streaming for Apache Kafka cluster, manage elastic network interfaces, and write to CloudWatch Logs.

You can attach the `AWSLambdaMSKExecutionRole` policy to your users, groups, and roles.

For more information about this policy, including the JSON policy document and policy versions, see [AWSLambdaMSKExecutionRole](#) in the *AWS Managed Policy Reference Guide*.

AWS managed policy: AWSLambdaRole

This policy grants permissions to invoke Lambda functions.

You can attach the `AWSLambdaRole` policy to your users, groups, and roles.

For more information about this policy, including the JSON policy document and policy versions, see [AWSLambdaRole](#) in the *AWS Managed Policy Reference Guide*.

AWS managed policy: AWSLambdaSQSQueueExecutionRole

This policy grants permissions to read and delete messages from an Amazon Simple Queue Service queue, and grants write permissions to CloudWatch Logs.

You can attach the `AWSLambdaSQSQueueExecutionRole` policy to your users, groups, and roles.

For more information about this policy, including the JSON policy document and policy versions, see [AWSLambdaSQSQueueExecutionRole](#) in the *AWS Managed Policy Reference Guide*.

AWS managed policy: AWSLambdaVPCAccessExecutionRole

This policy grants permissions to manage elastic network interfaces within an Amazon Virtual Private Cloud and write to CloudWatch Logs.

You can attach the `AWSLambdaVPCAccessExecutionRole` policy to your users, groups, and roles.

For more information about this policy, including the JSON policy document and policy versions, see [AWSLambdaVPCAccessExecutionRole](#) in the *AWS Managed Policy Reference Guide*.

Lambda updates to AWS managed policies

Change	Description	Date
AWSLambdaVPCAccessExecutionRole – Change	Lambda updated the <code>AWSLambdaVPCAccessExecutionRole</code> policy to allow the action <code>ec2:DescribeSubnets</code> .	January 5, 2024
AWSLambda_ReadOnlyAccess – Change	Lambda updated the <code>AWSLambda_ReadOnlyAccess</code> policy to allow principals to list AWS CloudFormation stacks.	July 27, 2023
AWS Lambda started tracking changes	AWS Lambda started tracking changes for its AWS managed policies.	July 27, 2023

Troubleshooting AWS Lambda identity and access

Use the following information to help you diagnose and fix common issues that you might encounter when working with Lambda and IAM.

Topics

- [I am not authorized to perform an action in Lambda](#)
- [I am not authorized to perform iam:PassRole](#)
- [I want to allow people outside of my AWS account to access my Lambda resources](#)

I am not authorized to perform an action in Lambda

If you receive an error that you're not authorized to perform an action, your policies must be updated to allow you to perform the action.

The following example error occurs when the `mateojackson` IAM user tries to use the console to view details about a fictional `my-example-widget` resource but doesn't have the fictional `lambda:GetWidget` permissions.

```
User: arn:aws:iam::123456789012:user/mateojackson is not authorized to perform:
lambda:GetWidget on resource: my-example-widget
```

In this case, the policy for the `mateojackson` user must be updated to allow access to the `my-example-widget` resource by using the `lambda:GetWidget` action.

If you need help, contact your AWS administrator. Your administrator is the person who provided you with your sign-in credentials.

I am not authorized to perform iam:PassRole

If you receive an error that you're not authorized to perform the `iam:PassRole` action, your policies must be updated to allow you to pass a role to Lambda.

Some AWS services allow you to pass an existing role to that service instead of creating a new service role or service-linked role. To do this, you must have permissions to pass the role to the service.

The following example error occurs when an IAM user named `marymajor` tries to use the console to perform an action in Lambda. However, the action requires the service to have permissions that are granted by a service role. Mary does not have permissions to pass the role to the service.

```
User: arn:aws:iam::123456789012:user/marymajor is not authorized to perform:
iam:PassRole
```

In this case, Mary's policies must be updated to allow her to perform the `iam:PassRole` action.

If you need help, contact your AWS administrator. Your administrator is the person who provided you with your sign-in credentials.

I want to allow people outside of my AWS account to access my Lambda resources

You can create a role that users in other accounts or people outside of your organization can use to access your resources. You can specify who is trusted to assume the role. For services that support resource-based policies or access control lists (ACLs), you can use those policies to grant people access to your resources.

To learn more, consult the following:

- To learn whether Lambda supports these features, see [How AWS Lambda works with IAM](#).
- To learn how to provide access to your resources across AWS accounts that you own, see [Providing access to an IAM user in another AWS account that you own](#) in the *IAM User Guide*.
- To learn how to provide access to your resources to third-party AWS accounts, see [Providing access to AWS accounts owned by third parties](#) in the *IAM User Guide*.
- To learn how to provide access through identity federation, see [Providing access to externally authenticated users \(identity federation\)](#) in the *IAM User Guide*.
- To learn the difference between using roles and resource-based policies for cross-account access, see [Cross account resource access in IAM](#) in the *IAM User Guide*.

Create a governance strategy for Lambda functions and layers

To build and deploy serverless, cloud-native applications, you must allow for agility and speed to market with appropriate governance and guardrails. You set business-level priorities, maybe emphasizing agility as the top priority, or alternatively emphasizing risk aversion via governance, guardrails, and controls. Realistically, you won't have an "either/or" strategy but an "and" strategy that balances both agility and guardrails in your software development lifecycle. No matter where these requirements fall in your company's lifecycle, governance capabilities are likely to become an implementation requirement in your processes and toolchains.

Here are a few examples of governance controls that an organization might implement for Lambda:

- Lambda functions must not be publicly accessible.
- Lambda functions must be attached to a VPC.
- Lambda functions should not use deprecated runtimes.
- Lambda functions must be tagged with a set of required tags.
- Lambda layers must not be accessible outside of the organization.
- Lambda functions with an attached security group must have matching tags between the function and security group.
- Lambda functions with an attached layer must use an approved version
- Lambda environment variables must be encrypted at rest with a customer managed key.

The following diagram is an example of an in-depth governance strategy that implements controls and policy throughout the software development and deployment process:

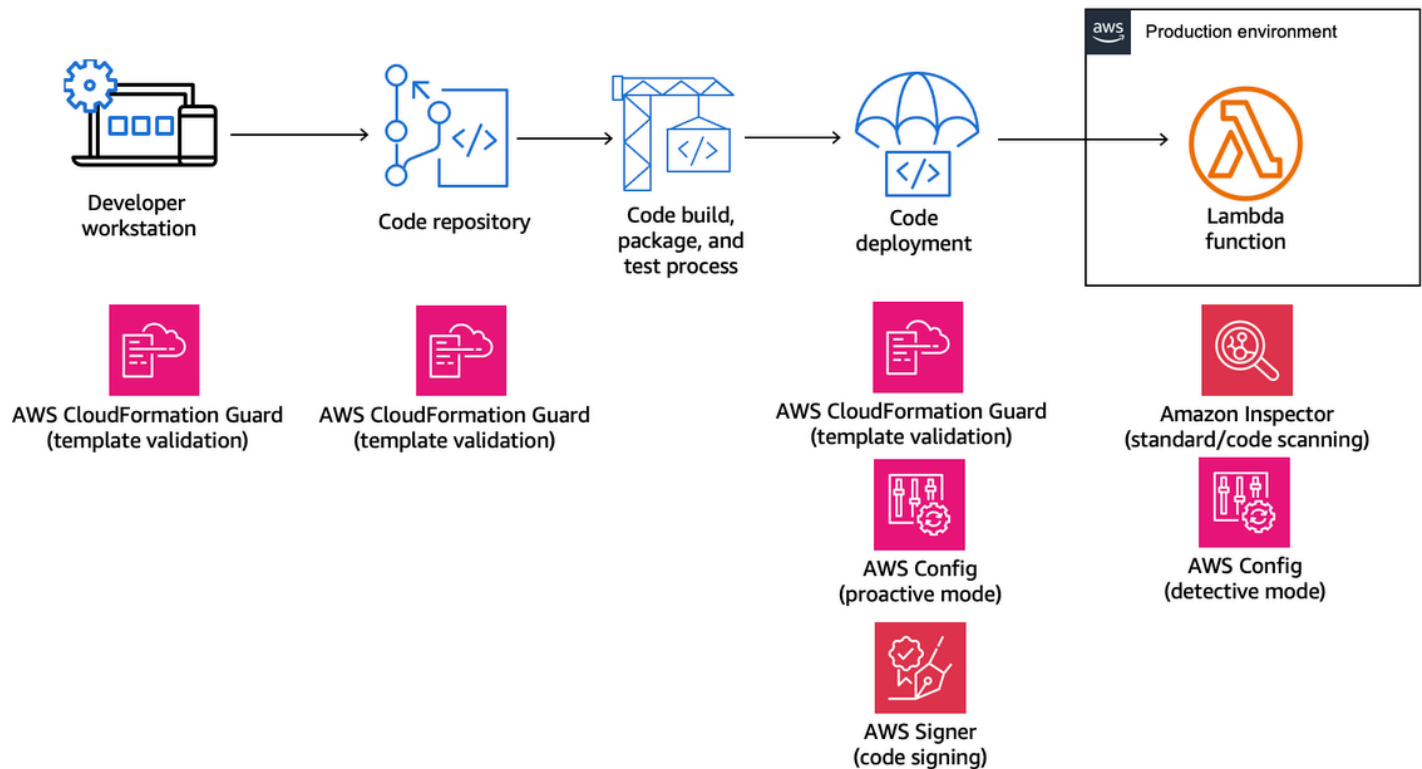

The following topics explain how to implement controls for developing and deploying Lambda functions in your organization, both for the startup and the enterprise. Your organization might already have tools in place. The following topics take a modular approach to these controls, so that you can pick and choose the components you actually need.

Topics

- [Proactive controls for Lambda with AWS CloudFormation Guard](#)
- [Implement preventative controls for Lambda with AWS Config](#)
- [Detect non-compliant Lambda deployments and configurations with AWS Config](#)
- [Lambda code signing with AWS Signer](#)
- [Automate security assessments for Lambda with Amazon Inspector](#)
- [Implement observability for Lambda security and compliance](#)

Proactive controls for Lambda with AWS CloudFormation Guard

[AWS CloudFormation Guard](#) is an open-source, general-purpose, policy-as-code evaluation tool. This can be used for preventative governance and compliance by validating Infrastructure as Code (IaC) templates and service compositions against policy rules. These rules can be customized based on your team or organizational requirements. For Lambda functions, the Guard rules can be used to control resource creation and configuration updates by defining the required property settings needed while creating or updating a Lambda function.

Compliance administrators define the list of controls and governance policies that are required for deploying and updating Lambda functions. Platform administrators implement the controls in CI/CD pipelines, as pre-commit validation webhooks with code repositories, and provide developers with command line tools for validating templates and code on local workstations. Developers author code, validate templates with command line tools, and then commit code to repositories, which are then automatically validated via the CI/CD pipelines prior to deployment into an AWS environment.

Guard allows you to [write your rules](#) and implement your controls with a domain-specific language as follows.

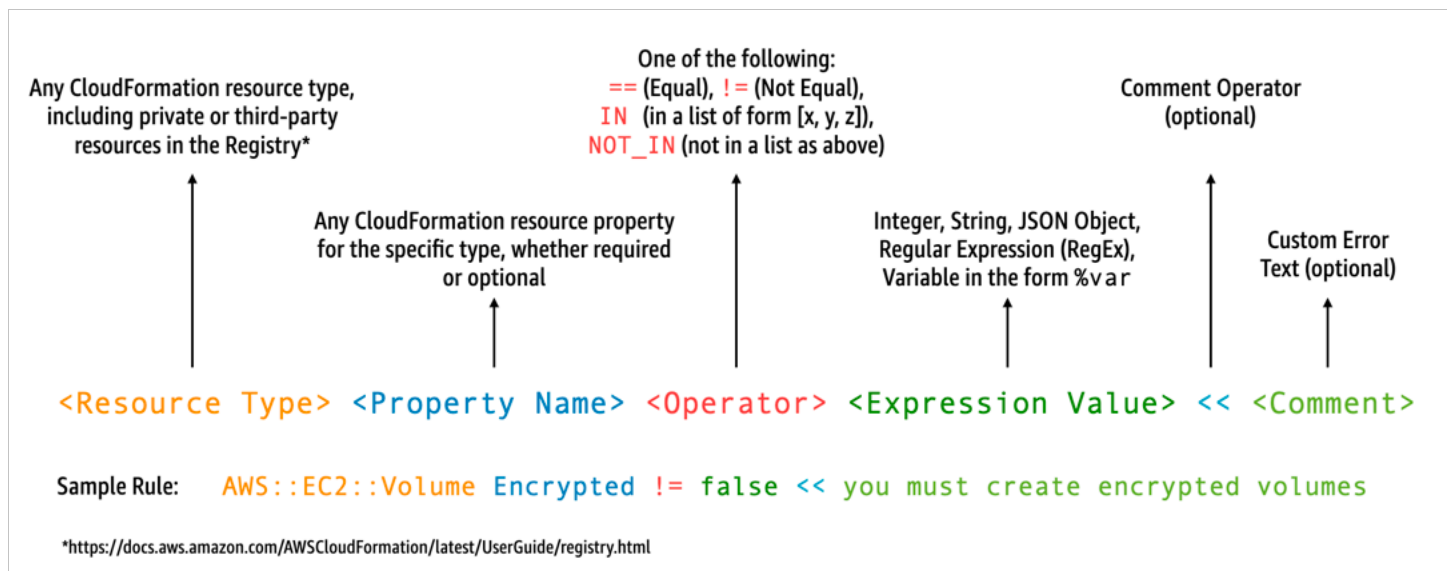

For example, suppose you want to ensure that developers choose only the latest runtimes. You could specify two different policies, one to identify [runtimes](#) that are already deprecated and another to identify runtimes that are to be deprecated soon. To do this, you might write the following `etc/rules.guard` file:

```

let lambda_functions = Resources.*[
  Type == "AWS::Lambda::Function"
]

rule lambda_already_deprecated_runtime when %lambda_functions !empty {
  %lambda_functions {
    Properties {
      when Runtime exists {
        Runtime !in ["dotnetcore3.1", "nodejs12.x", "python3.6", "python2.7",
"dotnet5.0", "dotnetcore2.1", "ruby2.5", "nodejs10.x", "nodejs8.10", "nodejs4.3",
"nodejs6.10", "dotnetcore1.0", "dotnetcore2.0", "nodejs4.3-edge", "nodejs"] <<Lambda
function is using a deprecated runtime.>>
      }
    }
  }
}

rule lambda_soon_to_be_deprecated_runtime when %lambda_functions !empty {
  %lambda_functions {
    Properties {
      when Runtime exists {
        Runtime !in ["nodejs16.x", "nodejs14.x", "python3.7", "java8",
"dotnet7", "go1.x", "ruby2.7", "provided"] <<Lambda function is using a runtime that
is targeted for deprecation.>>
      }
    }
  }
}

```

Now suppose you write the following `iac/lambda.yaml` CloudFormation template that defines a Lambda function:

```

Fn:
  Type: AWS::Lambda::Function
  Properties:
    Runtime: python3.7
    CodeUri: src
    Handler: fn.handler
    Role: !GetAtt FnRole.Arn
    Layers:
      - arn:aws:lambda:us-east-1:111122223333:layer:LambdaInsightsExtension:35

```

After [installing](#) the Guard utility, validate your template:

```
cfn-guard validate --rules etc/rules.guard --data iac/lambda.yaml
```

The output looks like this:

```
lambda.yaml Status = FAIL
FAILED rules
rules.guard/lambda_soon_to_be_deprecated_runtime
---
Evaluating data lambda.yaml against rules rules.guard
Number of non-compliant resources 1
Resource = Fn {
  Type      = AWS::Lambda::Function
  Rule = lambda_soon_to_be_deprecated_runtime {
    ALL {
      Check = Runtime not IN
["nodejs16.x", "nodejs14.x", "python3.7", "java8", "dotnet7", "go1.x", "ruby2.7", "provided"]
{
  ComparisonError {
    Message      = Lambda function is using a runtime that is targeted for
deprecation.
    Error        = Check was not compliant as property [/Resources/
Fn/Properties/Runtime[L:88,C:15]] was not present in [(resolved, Path=[L:0,C:0]
Value=["nodejs16.x", "nodejs14.x", "python3.7", "java8", "dotnet7", "go1.x", "ruby2.7", "provided"])]
  }
  PropertyPath  = /Resources/Fn/Properties/Runtime[L:88,C:15]
  Operator      = NOT IN
  Value         = "python3.7"
  ComparedWith =
["nodejs16.x", "nodejs14.x", "python3.7", "java8", "dotnet7", "go1.x", "ruby2.7", "provided"]]
  Code:
    86. Fn:
    87.   Type: AWS::Lambda::Function
    88.   Properties:
    89.     Runtime: python3.7
    90.     CodeUri: src
    91.     Handler: fn.handler
  }
}
}
}
```

Guard allows your developers to see from their local developer workstations that they need to update the template to use a runtime that is allowed by the organization. This happens prior to committing to a code repository and subsequently failing checks within a CI/CD pipeline. As a result, your developers get this feedback on how to develop compliant templates and shift their time to writing code that delivers business value. This control can be applied on the local developer workstation, in a pre-commit validation webhook, and/or in the CI/CD pipeline prior to deployment.

Caveats

If you're using AWS Serverless Application Model (AWS SAM) templates to define Lambda functions, be aware that you need to update the Guard rule to search for the `AWS::Serverless::Function` resource type as follows.

```
let lambda_functions = Resources.*[
  Type == "AWS::Serverless::Function"
]
```

Guard also expects the properties to be included within the resource definition. Meanwhile, AWS SAM templates allow for properties to be specified in a separate [Globals](#) section. Properties that are defined in the Globals section are not validated with your Guard rules.

As outlined in the Guard troubleshooting [documentation](#), be aware that Guard doesn't support short-form intrinsic like `!GetAtt` or `!Sub` and instead requires using the expanded forms: `Fn::GetAtt` and `Fn::Sub`. (The [earlier example](#) doesn't evaluate the Role property, so the short-form intrinsic was used for simplicity.)

Implement preventative controls for Lambda with AWS Config

It is essential to ensure compliance in your serverless applications as early in the development process as possible. In this topic, we cover how to implement preventative controls using [AWS Config](#). This allows you to implement compliance checks earlier in the development process and enables you to implement the same controls in your CI/CD pipelines. This also standardizes your controls in a centrally managed repository of rules so that you can apply your controls consistently across your AWS accounts.

For example, suppose your compliance administrators defined a requirement to ensure that all Lambda functions include AWS X-Ray tracing. With AWS Config's proactive mode, you can run compliance checks on your Lambda function resources before deployment, reducing the risk of deploying improperly configured Lambda functions and saving developers time by giving them faster feedback on infrastructure as code templates. The following is a visualization of the flow for preventative controls with AWS Config:

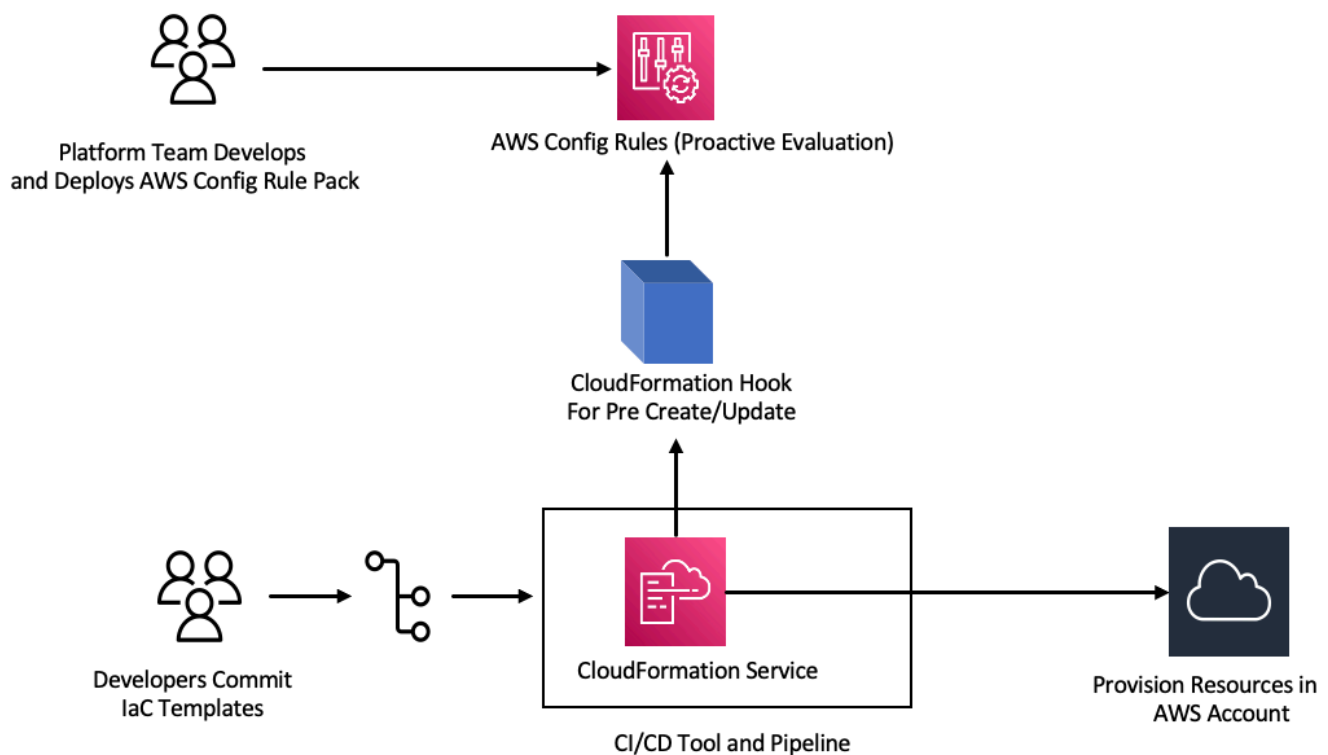

Consider a requirement that all Lambda functions must have tracing enabled. In response, the platform team identifies the need for a specific AWS Config rule to run proactively across all

accounts. This rule flags any Lambda function that lacks a configured X-Ray tracing configuration as a non-compliant resource. The team develops a rule, packages it in a [conformance pack](#), and deploys the conformance pack across all AWS accounts to ensure that all accounts in the organization uniformly apply these controls. You can write the rule in AWS CloudFormation Guard 2.x.x syntax, which takes the following form:

```
rule name when condition { assertion }
```

The following is a sample Guard rule that checks to ensure Lambda functions has tracing enabled:

```
rule lambda_tracing_check {
  when configuration.tracingConfig exists {
    configuration.tracingConfig.mode == "Active"
  }
}
```

The platform team takes further action by mandating that every AWS CloudFormation deployment invokes a pre-create/update [hook](#). They assume full responsibility for developing this hook and configuring the pipeline, strengthening the centralized control of compliance rules and sustaining their consistent application across all deployments. To develop, package, and register a hook, see [Developing AWS CloudFormation Hooks](#) in the CloudFormation Command Line Interface (CFN-CLI) documentation. You can use the [CloudFormation CLI](#) to create the hook project:

```
cfn init
```

This command asks you for some basic information about your hook project and creates a project with following files in it:

```
README.md
<hook-name>.json
rpdk.log
src/handler.py
template.yml
hook-role.yaml
```

As a hook developer, you need to add the desired target resource type in the `<hook-name>.json` configuration file. In the configuration below, a hook is configured to execute before any Lambda function is created using CloudFormation. You can add similar handlers for `preUpdate` and `preDelete` actions as well.

```

"handlers": {
  "preCreate": {
    "targetNames": [
      "AWS::Lambda::Function"
    ],
    "permissions": []
  }
}

```

You also need to ensure that the CloudFormation hook has appropriate permissions to call the AWS Config APIs. You can do that by updating the role definition file named `hook-role.yaml`. The role definition file has the following trust policy by default, which allows CloudFormation to assume the role.

```

AssumeRolePolicyDocument:
  Version: '2012-10-17'
  Statement:
    - Effect: Allow
      Principal:
        Service:
          - hooks.cloudformation.amazonaws.com
          - resources.cloudformation.amazonaws.com

```

To allow this hook to call config APIs, you must add following permissions to the Policy statement. Then you submit the hook project using the `cfn submit` command, where CloudFormation creates a role for you with the required permissions.

```

Policies:
  - PolicyName: HookTypePolicy
    PolicyDocument:
      Version: '2012-10-17'
      Statement:
        - Effect: Allow
          Action:
            - "config:Describe*"
            - "config:Get*"
            - "config:List*"
            - "config:SelectResourceConfig"
          Resource: "*"

```

Next, you need to write a Lambda function in a `src/handler.py` file. Within this file, you find methods named `preCreate`, `preUpdate`, and `preDelete` already created when you initiated the project. You aim to write a common, reusable function that calls the AWS Config `StartResourceEvaluation` API in proactive mode using the AWS SDK for Python (Boto3). This API call takes resource properties as input and evaluates the resource against the rule definition.

```
def validate_lambda_tracing_config(resource_type, function_properties:
MutableMapping[str, Any]) -> ProgressEvent:
    LOG.info("Fetching proactive data")
    config_client = boto3.client('config')
    resource_specs = {
        'ResourceId': 'MyFunction',
        'ResourceType': resource_type,
        'ResourceConfiguration': json.dumps(function_properties),
        'ResourceConfigurationSchemaType': 'CFN_RESOURCE_SCHEMA'
    }
    LOG.info("Resource Specifications:", resource_specs)
    eval_response = config_client.start_resource_evaluation(EvaluationMode='PROACTIVE',
ResourceDetails=resource_specs, EvaluationTimeout=60)
    ResourceEvaluationId = eval_response.ResourceEvaluationId
    compliance_response =
config_client.get_compliance_details_by_resource(ResourceEvaluationId=ResourceEvaluationId)
    LOG.info("Compliance Verification:",
compliance_response.EvaluationResults[0].ComplianceType)
    if "NON_COMPLIANT" == compliance_response.EvaluationResults[0].ComplianceType:
        return ProgressEvent(status=OperationStatus.FAILED, message="Lambda function
found with no tracing enabled : FAILED", errorCode=HandlerErrorCode.NonCompliant)
    else:
        return ProgressEvent(status=OperationStatus.SUCCESS, message="Lambda function
found with tracing enabled : PASS.")
```

Now you can call the common function from the handler for the pre-create hook. Here's an example of the handler:

```
@hook.handler(HookInvocationPoint.CREATE_PRE_PROVISION)
def pre_create_handler(
    session: Optional[SessionProxy],
    request: HookHandlerRequest,
    callback_context: MutableMapping[str, Any],
    type_configuration: TypeConfigurationModel
) -> ProgressEvent:
    LOG.info("Starting execution of the hook")
```

```
target_name = request.hookContext.targetName
LOG.info("Target Name:", target_name)
if "AWS::Lambda::Function" == target_name:
    return validate_lambda_tracing_config(target_name,
        request.hookContext.targetModel.get("resourceProperties")
    )
else:
    raise exceptions.InvalidRequest(f"Unknown target type: {target_name}")
```

After this step you can register the hook and configure it to listen to all AWS Lambda function creation events.

A developer prepares the infrastructure as code (IaC) template for a serverless microservice using Lambda. This preparation includes adherence to internal standards, followed by locally testing and committing the template to the repository. Here's an example IaC template:

```
MyLambdaFunction:
  Type: 'AWS::Lambda::Function'
  Properties:
    Handler: index.handler
    Role: !GetAtt LambdaExecutionRole.Arn
    FunctionName: MyLambdaFunction
    Code:
      ZipFile: |
        import json

        def handler(event, context):
            return {
                'statusCode': 200,
                'body': json.dumps('Hello World!')
            }
    Runtime: python3.13
    TracingConfig:
      Mode: PassThrough
    MemorySize: 256
    Timeout: 10
```

As part of the CI/CD process, when the CloudFormation template is deployed, the CloudFormation service invokes the pre-create/update hook right before provisioning `AWS::Lambda::Function` resource type. The hook utilizes AWS Config rules running in proactive mode to verify that the Lambda function configuration includes the mandated tracing configuration. The response from the hook determines the next step. If compliant, the hook signals success, and CloudFormation

proceeds to provision the resources. If not, the CloudFormation stack deployment fails, the pipeline comes to an immediate halt, and the system records the details for subsequent review. Compliance notifications are sent to the relevant stakeholders.

You can find the hook success/fail information in the CloudFormation console:

Timestamp	Logical ID	Status	Status reason	Hook invocations
2023-08-29 23:50:23 UTC-0500	HookTestStack	❌ ROLLBACK_COMPLETE	-	-
2023-08-29 23:50:22 UTC-0500	LambdaExecutionRole	✅ DELETE_COMPLETE	-	-
2023-08-29 23:50:21 UTC-0500	MyApi	✅ DELETE_COMPLETE	-	-
2023-08-29 23:50:20 UTC-0500	LambdaExecutionRole	🔄 DELETE_IN_PROGRESS	-	-
2023-08-29 23:50:20 UTC-0500	MyLambdaFunction	✅ DELETE_COMPLETE	-	-
2023-08-29 23:50:20 UTC-0500	MyApi	🔄 DELETE_IN_PROGRESS	-	-
2023-08-29 23:50:18 UTC-0500	HookTestStack	❌ ROLLBACK_IN_PROGRESS	The following resource(s) failed to create: [MyLambdaFunction]. Rollback requested by user.	-
2023-08-29 23:50:17 UTC-0500	MyLambdaFunction	❌ CREATE_FAILED	The following hook(s) failed: [AWSSamples::LambdaTracingCheck::Hook]	-
2023-08-29 23:50:17 UTC-0500	MyLambdaFunction	🔄 CREATE_IN_PROGRESS	-	AWSSamples::LambdaTracingCheck::Hook
2023-08-29 23:50:16 UTC-0500	MyLambdaFunction	🔄 CREATE_IN_PROGRESS	-	AWSSamples::LambdaTracingCheck::Hook
2023-08-29 23:50:15 UTC-0500	MyLambdaFunction	🔄 CREATE_IN_PROGRESS	-	-
2023-08-29 23:50:14 UTC-0500	LambdaExecutionRole	✅ CREATE_COMPLETE	-	-
2023-08-29 23:49:59 UTC-0500	MyApi	✅ CREATE_COMPLETE	-	-
2023-08-29 23:49:59 UTC-0500	MyApi	🔄 CREATE_IN_PROGRESS	Resource creation Initiated	-
2023-08-29 23:49:58 UTC-0500	LambdaExecutionRole	🔄 CREATE_IN_PROGRESS	Resource creation Initiated	-
2023-08-29 23:49:58 UTC-0500	LambdaExecutionRole	🔄 CREATE_IN_PROGRESS	-	-
2023-08-29 23:49:58 UTC-0500	MyApi	🔄 CREATE_IN_PROGRESS	-	-
2023-08-29 23:49:55 UTC-0500	HookTestStack	🔄 CREATE_IN_PROGRESS	User Initiated	-
2023-08-29 23:49:50 UTC-0500	HookTestStack	🔄 REVIEW_IN_PROGRESS	User Initiated	-

If you have logs enabled for your CloudFormation hook, you can capture the hook evaluation result. Here is a sample log for a hook with a failed status, indicating that the Lambda function does not have X-Ray enabled:

▼	2023-08-29T23:50:17.574-05:00	ProgressEvent(status=<OperationStatus.FAILED: 'FAILED'>, errorCode=<HandlerErrorCode.NonCompliant: 'NonCompliant'...
	ProgressEvent(status=<OperationStatus.FAILED: 'FAILED'>, errorCode=<HandlerErrorCode.NonCompliant: 'NonCompliant'>, message='Lambda function found with no tracing enabled : FAILED', result=None, callbackContext=None, callbackDelaySeconds=0, resourceModel=None, resourceModels=None, nextToken=None)	
	Copy	
	No newer events at this moment. <i>Auto retry paused.</i> Resume	

If the developer chooses to change the IaC to update TracingConfig Mode value to Active and redeploy, the hook executes successfully and the stack proceeds with creating the Lambda resource.

Events (21)				
Timestamp	Logical ID	Status	Status reason	Hook invocations
2023-08-29 23:56:52 UTC-0500	LambdaApiGatewayInvoke	CREATE_IN_PROGRESS	-	-
2023-08-29 23:56:52 UTC-0500	MyLambdaFunction	CREATE_COMPLETE	-	-
2023-08-29 23:56:44 UTC-0500	MyLambdaFunction	CREATE_IN_PROGRESS	Resource creation Initiated	-
2023-08-29 23:56:44 UTC-0500	MyLambdaFunction	CREATE_IN_PROGRESS	Hook invocations complete. Resource creation initiated	-
2023-08-29 23:56:43 UTC-0500	MyLambdaFunction	CREATE_IN_PROGRESS	-	-
2023-08-29 23:56:41 UTC-0500	MyLambdaFunction	CREATE_IN_PROGRESS	-	-
2023-08-29 23:56:41 UTC-0500	MyLambdaFunction	CREATE_IN_PROGRESS	-	-
2023-08-29 23:56:40 UTC-0500	LambdaExecutionRole	CREATE_COMPLETE	-	-
2023-08-29 23:56:25 UTC-0500	MyApi	CREATE_COMPLETE	-	-
2023-08-29 23:56:25 UTC-0500	MyApi	CREATE_IN_PROGRESS	Resource creation Initiated	-
2023-08-29 23:56:24 UTC-0500	LambdaExecutionRole	CREATE_IN_PROGRESS	Resource creation Initiated	-
2023-08-29 23:56:23 UTC-0500	LambdaExecutionRole	CREATE_IN_PROGRESS	-	-

Hook invocation details

Hook name
[AWSSamples::LambdaTracingCheck::Hook](#)

Hook status
HOOK_COMPLETE_SUCCEEDED

Hook failure mode
Fail

Hook invocation point
PRE_PROVISION

Hook status reason
Hook succeeded with message: Lambda function found with tracing enabled : PASS

In this way, you can implement preventative controls with AWS Config in proactive mode when developing and deploying serverless resources in your AWS accounts. By integrating AWS Config rules into the CI/CD pipeline, you can identify and optionally block non-compliant resource deployments, such as Lambda functions that lack an active tracing configuration. This ensures that only resources that comply with the latest governance policies are deployed into your AWS environments.

Detect non-compliant Lambda deployments and configurations with AWS Config

In addition to [proactive evaluation](#), AWS Config can also reactively detect resource deployments and configurations that do not comply with your governance policies. This is important because governance policies evolve as your organization learns and implements new best practices.

Consider a scenario where you set a brand new policy when deploying or updating Lambda functions: All Lambda functions must always use a specific, approved Lambda layer version. You can configure AWS Config to monitor new or updated functions for layer configurations. If AWS Config detects a function that is not using an approved layer version, it flags the function as a non-compliant resource. You can optionally configure AWS Config to automatically remediate the resource by specifying a remediation action using an AWS Systems Manager automation document. For example, you could write an automation document in Python using the AWS SDK for Python (Boto3), which updates the non-compliant function to point to the approved layer version. Thus, AWS Config serves as both a detective and corrective control, automating compliance management.

Let's break down this process into three important implementation phases:

Existing AWS Accounts

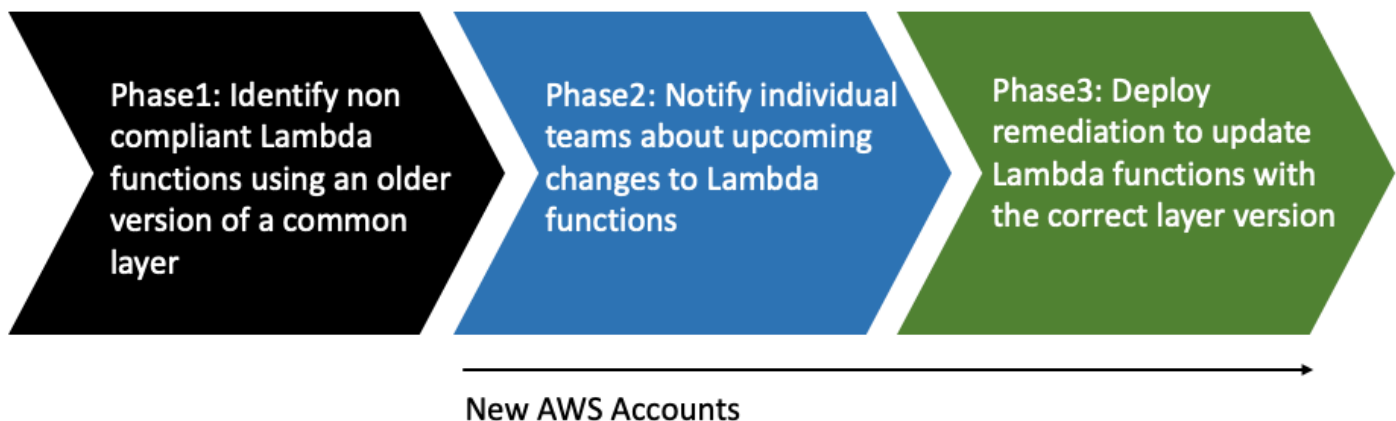

Phase 1: Identify access resources

Start by activating AWS Config across your accounts and configuring it to record AWS Lambda functions. This allows AWS Config to observe when Lambda functions are created or updated. You can then configure [custom policy rules](#) to check for specific policy violations, which use AWS CloudFormation Guard syntax. Guard rules take the following general form:

```
rule name when condition { assertion }
```

Below is a sample rule that checks to ensure that a layer is not set to an old layer version:

```
rule desiredlayer when configuration.layers != empty {  
    some configuration.layers[*].arn != CONFIG_RULE_PARAMETERS.OldLayerArn  
}
```

Let's understand the rule syntax and structure:

- **Rule name:** The name of the rule in the provided example is `desiredlayer`.
- **Condition:** This clause specifies the condition under which the rule should be checked. In the provided example, the condition is `configuration.layers != empty`. This means the resource should be evaluated only when the `layers` property in the configuration isn't empty.
- **Assertion:** After the `when` clause, an assertion determines what the rule checks. The assertion `some configuration.layers[*].arn != CONFIG_RULE_PARAMETERS.OldLayerArn` checks if any of the Lambda layer ARNs do not match the `OldLayerArn` value. If they do not match, the assertion is true and the rule passes; otherwise, it fails.

`CONFIG_RULE_PARAMETERS` is a special set of parameters that is configured with the AWS Config rule. In this case, `OldLayerArn` is a parameter inside `CONFIG_RULE_PARAMETERS`. This allows users to provide a specific ARN value that they consider old or deprecated, and then the rule checks if any Lambda functions are using this old ARN.

Phase 2: Visualize and design

AWS Config gathers configuration data and stores that data in Amazon Simple Storage Service (Amazon S3) buckets. You can use [Amazon Athena](#) to query this data directly from your S3 buckets. With Athena, you can aggregate this data at the organizational level, generating a holistic view of your resource configurations across all your accounts. To set up aggregation of resource configuration data, see [Visualizing AWS Config data using Athena and Amazon QuickSight](#) on the AWS Cloud Operations and Management blog.

The following is a sample Athena query to identify all Lambda functions using a particular layer ARN:

```
WITH unnested AS (
```



```

SELECT
  item.awsaccountid AS account_id,
  item.awsregion AS region,
  item.configuration AS lambda_configuration,
  item.resourceid AS resourceid,
  item.resourcename AS resourcename,
  item.configuration AS configuration,
  json_parse(item.configuration) AS lambda_json
FROM
  default.aws_config_configuration_snapshot,
  UNNEST(configurationitems) as t(item)
WHERE
  "dt" = 'latest'
  AND item.resourcetype = 'AWS::Lambda::Function'
)

SELECT DISTINCT
  region as Region,
  resourcename as FunctionName,
  json_extract_scalar(lambda_json, '$.memorySize') AS memory_size,
  json_extract_scalar(lambda_json, '$.timeout') AS timeout,
  json_extract_scalar(lambda_json, '$.version') AS version
FROM
  unnested
WHERE
  lambda_configuration LIKE '%arn:aws:lambda:us-
east-1:111122223333:layer:AnyGovernanceLayer:24%'

```

Here are results from the query:

Query results		Query stats			
Completed		Time in queue: 127 ms	Run time: 1.803 sec		
		Data scanned: 239.40 KB			
Results (27)					
<input type="text" value="Search rows"/> Copy Download results					
#	Region	FunctionName	memory_size	timeout	version
1	us-east-1	UpdateUIForPublishEvents	128	18	\$LATEST
2	us-east-1	SchedulerCLI-InstanceSchedulerMain	128	300	\$LATEST
3	us-east-1	my_functions_function10	128	3	\$LATEST
4	us-east-1	lex-web-ui-CognitoidentityP-CleanStackNameFunction-1TSORSH6LYXQ	128	300	\$LATEST
5	us-east-1	GetLatestArn	128	3	\$LATEST
6	us-east-1	aws-python-http-api-project-dev-hello	1024	6	\$LATEST
7	us-east-1	cloud9-MyTest-MyTest-688JGPVYP37L	128	15	\$LATEST
8	us-east-1	my_functions_function1	128	3	\$LATEST
9	us-east-1	my_functions_function25	128	3	\$LATEST

With the AWS Config data aggregated across the organization, you can then create a dashboard using [Amazon QuickSight](#). By importing your Athena results into Amazon QuickSight, you can visualize how well your Lambda functions adhere to the layer version rule. This dashboard can highlight compliant and non-compliant resources, which helps you to determine your enforcement policy, as outlined in the [next section](#). The following image is an example dashboard that reports on the distribution of layer versions applied to functions within the organization.

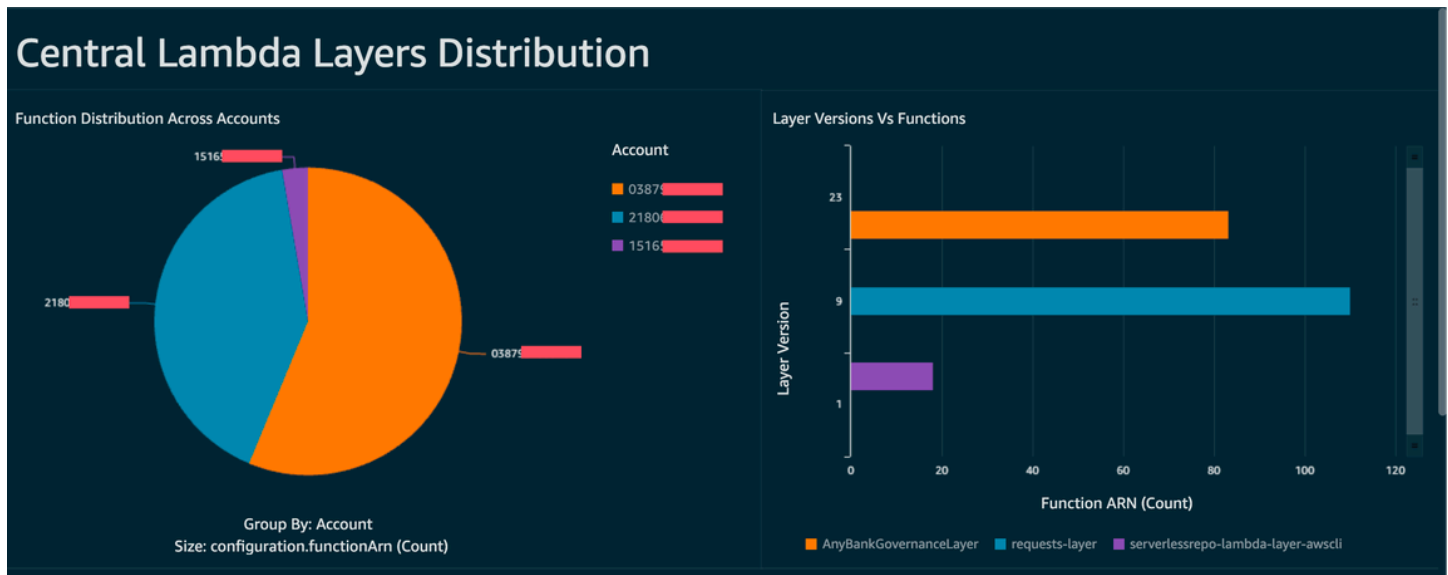

Phase 3: Implement and enforce

You can now optionally pair your layer version rule that you created in [phase 1](#) with a remediation action via a Systems Manager automation document, which you author as a Python script written with AWS SDK for Python (Boto3). The script calls the [UpdateFunctionConfiguration](#) API action for each Lambda function, updating the function configuration with the new layer ARN. Alternatively, you could have the script submit a pull request to the code repository to update the layer ARN. This way future code deployments are also updated with the correct layer ARN.

Lambda code signing with AWS Signer

[AWS Signer](#) is a fully managed code-signing service that allows you to validate your code against a digital signature to confirm that code is unaltered and from a trusted publisher. AWS Signer can be used in conjunction with AWS Lambda to verify that functions and layers are unaltered prior to deployment into your AWS environments. This protects your organization from malicious actors who might have gained credentials to create new or update existing functions.

To set up code signing for your Lambda functions, start by creating an S3 bucket with versioning enabled. After that, create a signing profile with AWS Signer, specify Lambda as the platform and then specify a period of days in which the signing profile is valid. Example:

```
Signer:
  Type: AWS::Signer::SigningProfile
  Properties:
    PlatformId: AWSLambda-SHA384-ECDSA
    SignatureValidityPeriod:
      Type: DAYS
      Value: !Ref pValidDays
```

Then use the signing profile and create a signing configuration with Lambda. You have to specify what to do when the signing configuration sees an artifact that does not match a digital signature that it expected: warn (but allow the deployment) or enforce (and block the deployment). The example below is configured to enforce and block deployments.

```
SigningConfig:
  Type: AWS::Lambda::CodeSigningConfig
  Properties:
    AllowedPublishers:
      SigningProfileVersionArns:
        - !GetAtt Signer.ProfileVersionArn
    CodeSigningPolicies:
      UntrustedArtifactOnDeployment: Enforce
```

You now have AWS Signer configured with Lambda to block untrusted deployments. Let's assume you've finished coding a feature request and are now ready to deploy the function. The first step is to zip the code up with the appropriate dependencies and then sign the artifact using the signing profile that you created. You can do this by uploading the zip artifact to the S3 bucket and then starting a signing job.

```
aws signer start-signing-job \
--source 's3={bucketName=your-versioned-bucket,key=your-prefix/your-zip-artifact.zip,version=QyaJ3c4qa50LXV.9VaZgXHlsGbvCXpT}' \
--destination 's3={bucketName=your-versioned-bucket,prefix=your-prefix/}' \
--profile-name your-signer-id
```

You get an output as follows, where the `jobId` is the object that is created in the destination bucket and `prefix` and `jobOwner` is the 12-digit AWS account ID where the job was run.

```
{
  "jobId": "87a3522b-5c0b-4d7d-b4e0-4255a8e05388",
  "jobOwner": "111122223333"
}
```

And now you can deploy your function using the signed S3 object and the code signing configuration that you created.

```
Fn:
  Type: AWS::Serverless::Function
  Properties:
    CodeUri: s3://your-versioned-bucket/your-prefix/87a3522b-5c0b-4d7d-b4e0-4255a8e05388.zip
    Handler: fn.handler
    Role: !GetAtt FnRole.Arn
    CodeSigningConfigArn: !Ref pSigningConfigArn
```

You can alternatively test a function deployment with the original unsigned source zip artifact. The deployment should fail with the following message:

```
Lambda cannot deploy the function. The function or layer might be signed using a signature that the client is not configured to accept. Check the provided signature for unsigned.
```

If you are building and deploying your functions using the AWS Serverless Application Model (AWS SAM), the `package` command handles uploading the zip artifact to S3 and also starts the signing job and gets the signed artifact. You can do this with the following command and parameters:

```
sam package -t your-template.yaml \
--output-template-file your-output.yaml \
--s3-bucket your-versioned-bucket \
```

```
--s3-prefix your-prefix \  
--signing-profiles your-signer-id
```

AWS Signer helps you verify that zip artifacts that are deployed into your accounts are trusted for deployment. You can include the process above in your CI/CD pipelines and require that all functions have a code signing configuration attached using the techniques outlined in previous topics. By using code signing with your Lambda function deployments, you prevent malicious actors who might have gotten credentials to create or update functions from injecting malicious code in your functions.

Automate security assessments for Lambda with Amazon Inspector

[Amazon Inspector](#) is a vulnerability management service that continually scans workloads for known software vulnerabilities and unintended network exposure. Amazon Inspector creates a finding that describes the vulnerability, identifies the affected resource, rates the severity of the vulnerability, and provides remediation guidance.

Amazon Inspector support provides continuous, automated security vulnerability assessments for Lambda functions and layers. Amazon Inspector provides two scan types for Lambda:

- **Lambda standard scanning (default):** Scans application dependencies within a Lambda function and its layers for [package vulnerabilities](#).
- **Lambda code scanning:** Scans the custom application code in your functions and layers for [code vulnerabilities](#). You can either activate Lambda standard scanning or activate Lambda standard scanning together with Lambda code scanning.

To enable Amazon Inspector, navigate to the [Amazon Inspector console](#), expand the **Settings** section, and choose **Account Management**. On the **Accounts** tab, choose **Activate**, and then select one of the scan options.

You can enable Amazon Inspector for multiple accounts and delegate permissions to manage Amazon Inspector for the organization to specific accounts while setting up Amazon Inspector. While enabling, you need to grant Amazon Inspector permissions by creating the role: `AWSServiceRoleForAmazonInspector2`. The Amazon Inspector console allows you to create this role using a one-click option.

For Lambda standard scanning, Amazon Inspector initiates vulnerability scans of Lambda functions in the following situations:

- As soon as Amazon Inspector discovers an existing Lambda function.
- When you deploy a new Lambda function.
- When you deploy an update to the application code or dependencies of an existing Lambda function or its layers.
- Whenever Amazon Inspector adds a new common vulnerabilities and exposures (CVE) item to its database, and that CVE is relevant to your function.

For Lambda code scanning, Amazon Inspector evaluates your Lambda function application code using automated reasoning and machine learning that analyzes your application code for overall security compliance. If Amazon Inspector detects a vulnerability in your Lambda function application code, Amazon Inspector produces a detailed **Code Vulnerability** finding. For a list of possible detections, see the [Amazon CodeGuru Detector Library](#).

To view the findings, go to the [Amazon Inspector console](#). On the **Findings** menu, choose **By Lambda function** to display the security scan results that were performed on Lambda functions.

To exclude a Lambda function from standard scanning, tag the function with the following key-value pair:

- Key:InspectorExclusion
- Value:LambdaStandardScanning

To exclude a Lambda function from code scans, tag the function with the following key-value pair:

- Key:InspectorCodeExclusion
- Value:LambdaCodeScanning

For example, as shown in following image, Amazon Inspector automatically detects vulnerabilities and categorizes the findings of type **Code Vulnerability**, which indicates that the vulnerability is in the code of the function, and not in one of the code-dependent libraries. You can check these details for a specific function or multiple functions at once.

Findings (2) ↻

Choose a row to view the finding details. All findings are related to this instance.

Active ▼

Resource ID *EQUALS* `arn:aws:lambda:us-east-1:.....function:code_scanning_python:$LATEST` ✕

< 1 > ⚙️

	Severity ▼	Title	Type ▼	Age ▼	Status
<input type="radio"/>	■ High	CWE-200 - Insecure Socket Bind	Code Vulnerability	10 minutes	Active
<input type="radio"/>	■ High	Overriding environment variables that are res	Code Vulnerability	10 minutes	Active

You can dive further into each of these findings and learn how to remediate the issue.

Overriding environment variables that are reserved by AWS Lambda might lead to unexpected behavior.



Finding ID: [arn:aws:inspector2:us-east-1: \[REDACTED\]:finding/\[REDACTED\]](#)

Overriding environment variables that are reserved by AWS Lambda might lead to unexpected behavior or failure of the Lambda function.

Finding overview

AWS account ID	[REDACTED]
Severity	High
Type	Code Vulnerability
Detector name ↗	Override of reserved variable names in a Lambda function
Relevant CWE ↗	--
Rule ID ↗	Rule-434311
Detector tags	#availability, #aws-python-sdk, #aws-lambda, #data-integrity, #maintainability, #security, #security-context, #python
Fix available	Yes
Created at	March 29, 2023 10:08 AM (UTC-04:00)

Vulnerability details

File path `lambda_function.py`

Vulnerability location

```

3 import socket
4
5 def lambda_handler(event, context):
6
7     # print("Scenario 1");
8     os.environ['_HANDLER'] = 'hello'
9     # print("Scenario 1 ends")
10
11     # print("Scenario 2");
12     s = socket.socket(socket.AF_INET, socket.SOCK_STREAM)
13     s.bind(('',0))

```

Suggested remediation

Your code attempts to override an environment variable that is reserved by the Lambda runtime environment. This can lead to unexpected behavior and might break the execution of your Lambda function.

While working with your Lambda functions, ensure that you comply with the naming conventions for your Lambda functions. For more information, see [Create Lambda environment variables](#).

You are responsible for the remediation suggestions that you accept. Always review remediation suggestions before accepting them. You might need to make edits to remediation suggestions to ensure that your code does what you intended.

Implement observability for Lambda security and compliance

AWS Config is a useful tool to find and fix non-compliant AWS Serverless resources. Every change you make to your serverless resources is recorded in AWS Config. Additionally, AWS Config allows you to store configuration snapshot data on S3. You can use Amazon Athena and Amazon QuickSight to make dashboards and see AWS Config data. In [Detect non-compliant Lambda deployments and configurations with AWS Config](#), we discussed how we can visualize a certain configuration like Lambda layers. This topic expands on these concepts.

Visibility into Lambda configurations

You can use queries to pull important configurations like AWS account ID, Region, AWS X-Ray tracing configuration, VPC configuration, memory size, runtime, and tags. Here is a sample query you can use to pull this information from Athena:

```
WITH unnested AS (
  SELECT
    item.awsaccountid AS account_id,
    item.awsregion AS region,
    item.configuration AS lambda_configuration,
    item.resourceid AS resourceid,
    item.resourcename AS resourcename,
    item.configuration AS configuration,
    json_parse(item.configuration) AS lambda_json
  FROM
    default.aws_config_configuration_snapshot,
    UNNEST(configurationitems) as t(item)
  WHERE
    "dt" = 'latest'
    AND item.resourcetype = 'AWS::Lambda::Function'
)

SELECT DISTINCT
  account_id,
  tags,
  region as Region,
  resourcename as FunctionName,
  json_extract_scalar(lambda_json, '$.memorySize') AS memory_size,
  json_extract_scalar(lambda_json, '$.timeout') AS timeout,
  json_extract_scalar(lambda_json, '$.runtime') AS version
  json_extract_scalar(lambda_json, '$.vpcConfig.SubnetIds') AS vpcConfig
  json_extract_scalar(lambda_json, '$.tracingConfig.mode') AS tracingConfig
```

FROM
unnested

You can use the query to build an Amazon QuickSight dashboard and visualize the data. To aggregate AWS resource configuration data, create tables in Athena, and build Amazon QuickSight dashboards on the data from Athena, see [Visualizing AWS Config data using Athena and Amazon QuickSight](#) on the AWS Cloud Operations and Management blog. Notably, this query also retrieves tag information for the functions. This allows for deeper insights into your workloads and environments, especially if you employ custom tags.

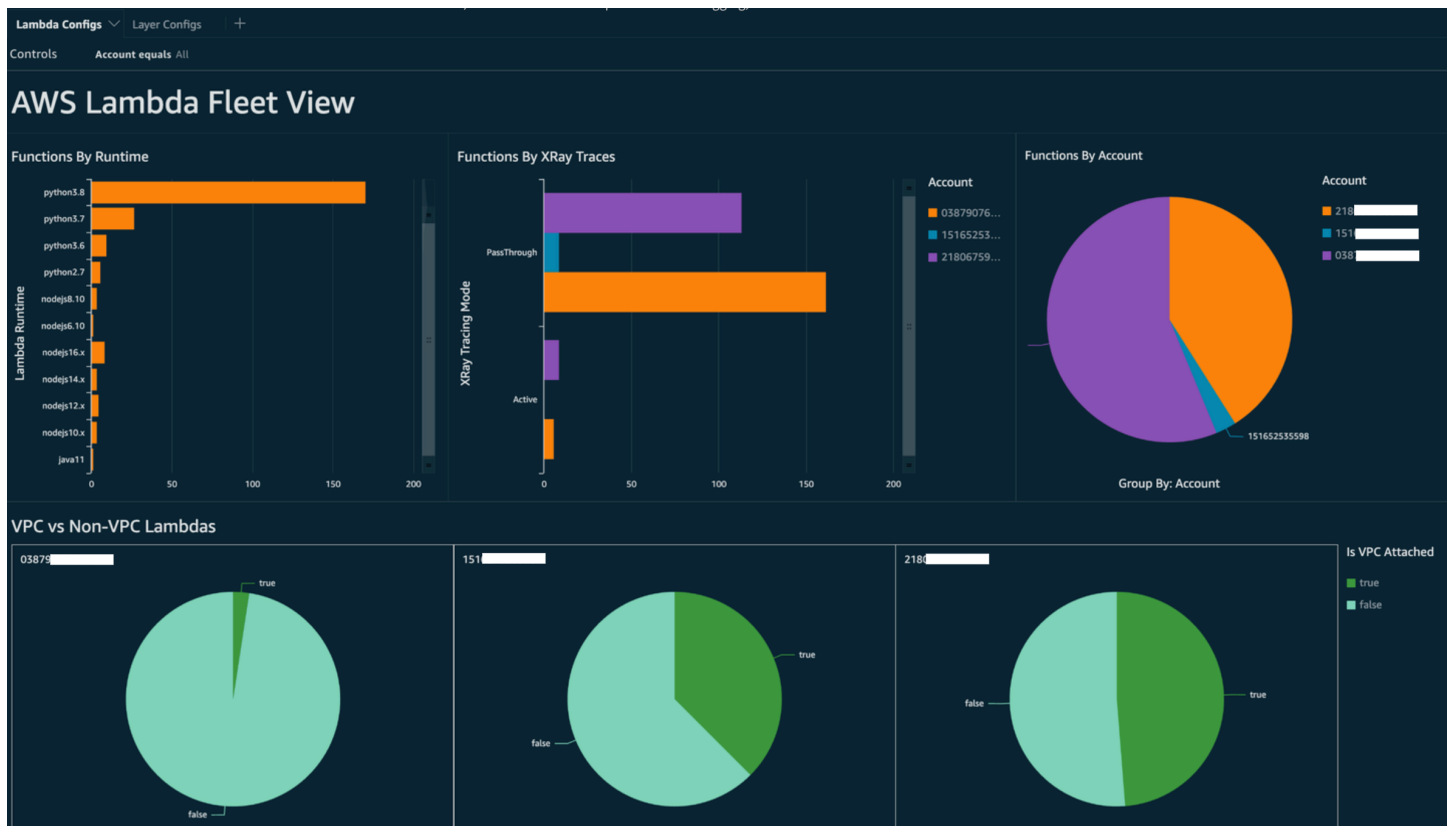

For more information on actions that you can take, see the [Addressing the observability findings](#) section later in this topic.

Visibility into Lambda compliance

With the data generated by AWS Config, you can create organization-level dashboards to monitor compliance. This allows for consistent tracking and monitoring of:

- Compliance packs by compliance score
- Rules by non-compliant resources

- Compliance status

AWS Config ×

Dashboard

Conformance packs

Rules

Resources

▼ Aggregators

- Conformance packs
- Rules
- Resources
- Authorizations

Advanced queries

Settings

What's new

[Documentation](#) ↗

[Partners](#) ↗

[FAQs](#) ↗

[Pricing](#) ↗

[AWS Config](#) > Dashboard

Dashboard

Conformance Packs by Compliance Score

Conformance pack	Compliance score
MyNewConformancePack	<div style="display: flex; align-items: center;"> <div style="flex-grow: 1; border: 1px solid #ccc; background: linear-gradient(to right, #007bff 37%, #e9ecef 37%);"></div> 37% </div>

Compliance status

Rules	Resources
⚠ 6 Noncompliant rule(s) ✔ 7 Compliant rule(s)	⚠ 100+ Noncompliant resource(s) ✔ 82 Compliant resource(s)

Noncompliant rules by noncompliant resource count

Name	Compliance
lambda-function-settings-ch...	⚠ 25+ Noncompliant resource(s)
lambda-dlq-check-conforma...	⚠ 25+ Noncompliant resource(s)
lambda-inside-vpc-conforma...	⚠ 25+ Noncompliant resource(s)
lambda-vpc-multi-az-check-...	⚠ 25+ Noncompliant resource(s)
lambda-function-settings-ch...	⚠ 14 Noncompliant resource(s)
View all noncompliant rules	

Check each rule to identify non-compliant resources for that rule. For example, if your organization mandates that all Lambda functions must be associated with a VPC and if you have deployed an AWS Config rule to identify compliance, you can select the `lambda-inside-vpc` rule in the list above.

Resources in scope

All

- All
- Compliant
- Noncompliant

	Type	Annotation	Compliance
<input type="radio"/> my_functions_function44	Lambda Function	-	✔ Compliant
<input type="radio"/> my_functions_function46	Lambda Function	-	✔ Compliant
<input type="radio"/> my_functions_function47	Lambda Function	-	✔ Compliant
<input type="radio"/> my_functions_function49	Lambda Function	-	✔ Compliant
<input type="radio"/> my_functions_function50	Lambda Function	-	✔ Compliant
<input type="radio"/> my_functions_function6	Lambda Function	-	✔ Compliant
<input type="radio"/> my_functions_function7	Lambda Function	-	✔ Compliant
<input type="radio"/> my_functions_function8	Lambda Function	-	✔ Compliant
<input type="radio"/> ConfigQueryLambda	Lambda Function	This AWS Lambda function is not in ...	⚠ Noncompliant
<input type="radio"/> DormamuLambda	Lambda Function	This AWS Lambda function is not in ...	⚠ Noncompliant

For more information on actions that you can take, see the [Addressing the observability findings](#) section below.

Visibility into Lambda function boundaries using Security Hub

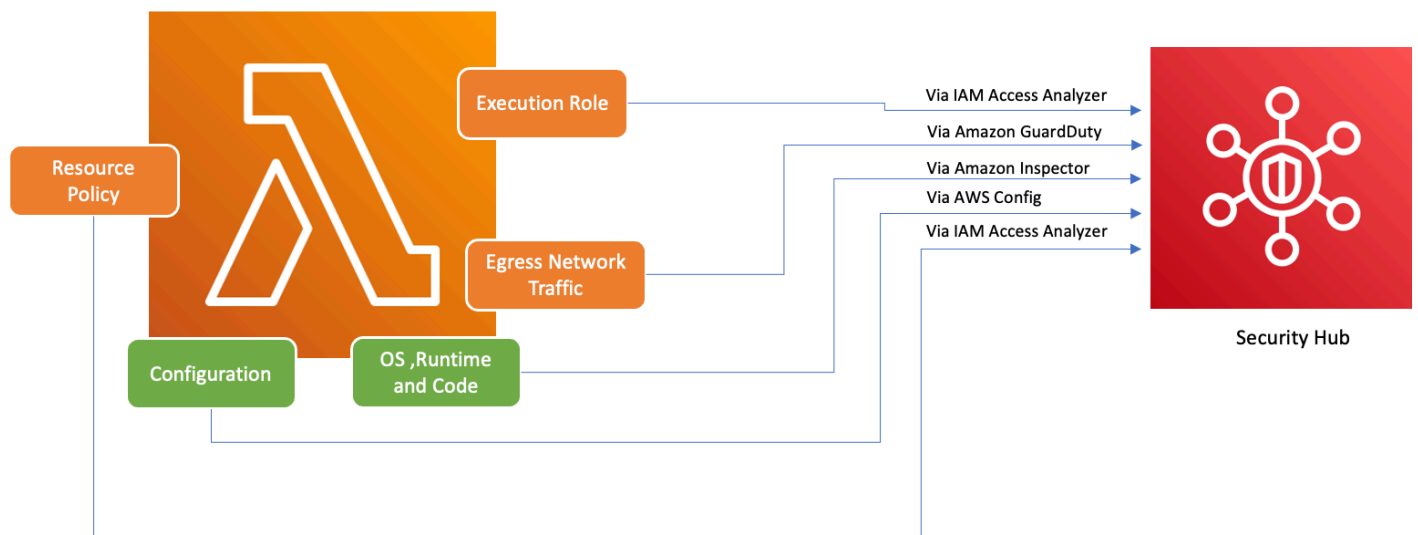

To ensure that AWS services including Lambda are used securely, AWS introduced the Foundational Security Best Practices v1.0.0. This set of best practices provides clear guidelines for securing resources and data in the AWS environment, emphasizing the importance of maintaining a strong security posture. The AWS Security Hub complements this by offering a unified security and compliance center. It aggregates, organizes, and prioritizes security findings from multiple

AWS services like Amazon Inspector, AWS Identity and Access Management Access Analyzer, and Amazon GuardDuty.

If you have Security Hub, Amazon Inspector, IAM Access Analyzer, and GuardDuty enabled within your AWS organization, Security Hub automatically aggregates findings from these services. For instance, let's consider Amazon Inspector. Using Security Hub, you can efficiently identify code and package vulnerabilities in Lambda functions. In the Security Hub console, navigate to the bottom section labeled **Latest findings from AWS integrations**. Here, you can view and analyze findings sourced from various integrated AWS services.

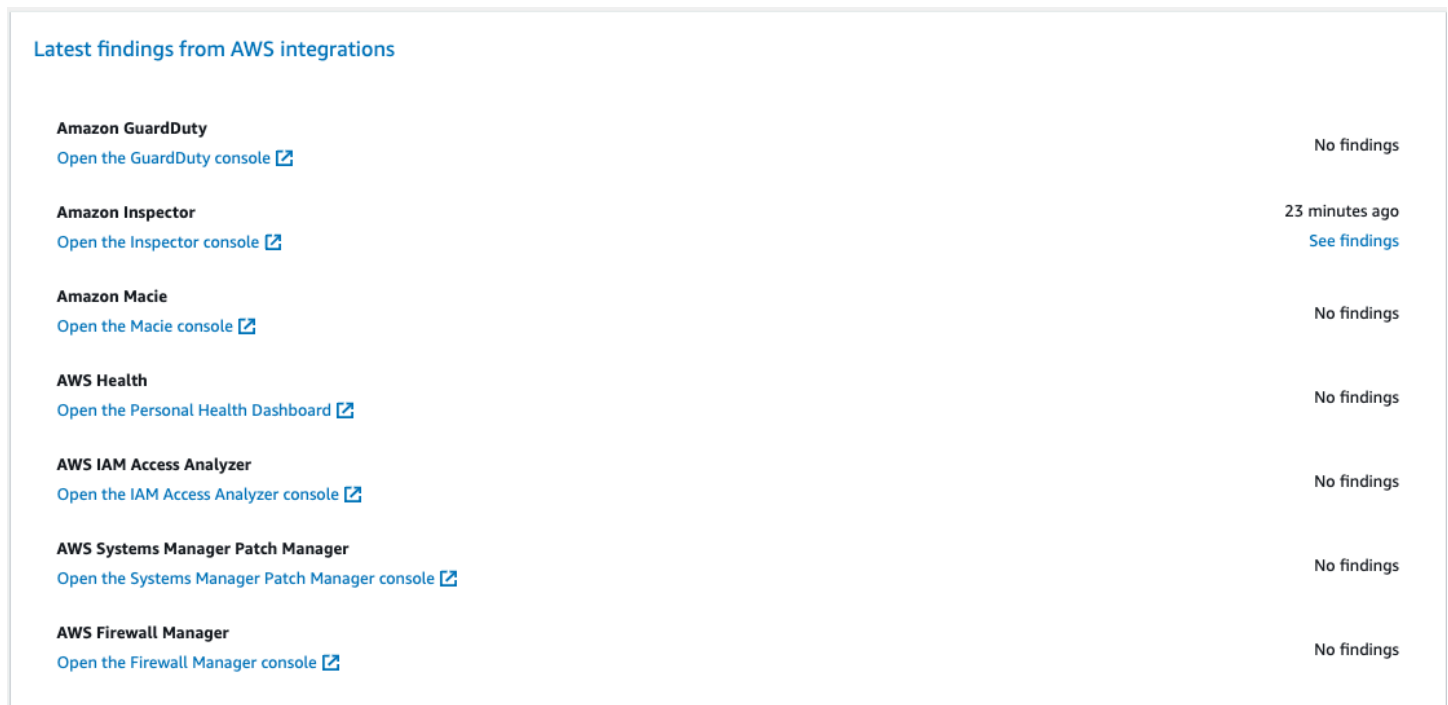

The screenshot displays a table titled "Latest findings from AWS integrations" with the following data:

Service	Findings
Amazon GuardDuty Open the GuardDuty console	No findings
Amazon Inspector Open the Inspector console	23 minutes ago See findings
Amazon Macie Open the Macie console	No findings
AWS Health Open the Personal Health Dashboard	No findings
AWS IAM Access Analyzer Open the IAM Access Analyzer console	No findings
AWS Systems Manager Patch Manager Open the Systems Manager Patch Manager console	No findings
AWS Firewall Manager Open the Firewall Manager console	No findings

To see details, choose the **See findings** link in the second column. This displays a list of findings filtered by product, such as Amazon Inspector. To limit your search to Lambda functions, set `ResourceType` to `AwsLambdaFunction`. This displays findings from Amazon Inspector related to Lambda functions.

Security Hub > Findings

Findings (20+) Actions Workflow status Create insight

A finding is a security issue or a failed security check.

Q Add filter

Product name is Inspector X Resource type is AwsLambdaFunction X Workflow status is NEW X Workflow status is NOTIFIED X Record state is ACTIVE X Clear filters

< 1 ... >

<input type="checkbox"/>	Severity	Workflow status	Record State	Region	Account Id	Company	Product	Title	Resource	Compliance Status	Updated at
<input type="checkbox"/>	HIGH	NEW	ACTIVE	us-east-1	218	Amazon	Inspector	CWE-117 - Log injection	Lambda Function \$LATEST		27 minutes ago
<input type="checkbox"/>	HIGH	NEW	ACTIVE	us-east-1	218	Amazon	Inspector	CWE-117 - Log injection	Lambda Function \$LATEST		27 minutes ago
<input type="checkbox"/>	HIGH	NEW	ACTIVE	us-east-1	218	Amazon	Inspector	CWE-117 - Log injection	Lambda Function \$LATEST		27 minutes ago
<input type="checkbox"/>	HIGH	NEW	ACTIVE	us-east-1	218	Amazon	Inspector	CWE-117 - Log injection	Lambda Function \$LATEST		27 minutes ago

For GuardDuty, you can identify suspicious network traffic patterns. Such anomalies might suggest the existence of potentially malicious code within your Lambda function.

With IAM Access Analyzer, you can check policies, especially those with condition statements that grant function access to external entities. Moreover, IAM Access Analyzer evaluates permissions set when using the [AddPermission](#) operation in the Lambda API alongside an EventSourceToken.

Addressing the observability findings

Given the wide-ranging configurations possible for Lambda functions and their distinct requirements, a standardized automation solution for remediation might not suit every situation. Additionally, changes are implemented differently across various environments. If you encounter any configuration that seems non-compliant, consider the following guidelines:

1. Tagging strategy

We recommend implementing a comprehensive tagging strategy. Each Lambda function should be tagged with key information such as:

- **Owner:** The person or team responsible for the function.
- **Environment:** Production, staging, development, or sandbox.
- **Application:** The broader context to which this function belongs, if applicable.

2. Owner outreach

Instead of automating the breaking changes (like VPC configuration adjustment), proactively contact the owners of non-compliant functions (identified by the owner tag) providing them sufficient time to either:

- Adjust non-compliant configurations on Lambda functions.
- Provide an explanation and request an exception, or refine the compliance standards.

3. **Maintain a configuration management database (CMDB)**

While tags can provide immediate context, maintaining a centralized CMDB can provide deeper insights. It can hold more granular information about each Lambda function, its dependencies, and other critical metadata. A CMDB is an invaluable resource for auditing, compliance checks, and identifying function owners.

As the landscape of serverless infrastructure continually evolves, it's essential to adopt a proactive stance towards monitoring. With tools like AWS Config, Security Hub, and Amazon Inspector, potential anomalies or non-compliant configurations can be swiftly identified. However, tools alone cannot ensure total compliance or optimal configurations. It's crucial to pair these tools with well-documented processes and best practices.

- **Feedback loop:** Once remediation steps are undertaken, ensure there's a feedback loop. This means periodically revisiting non-compliant resources to confirm if they've been updated or are still running with the same issues.
- **Documentation:** Always document the observations, actions taken, and any exceptions granted. Proper documentation not only helps during audits but also aids in enhancing the process for better compliance and security in the future.
- **Training and awareness:** Ensure that all stakeholders, especially Lambda function owners, are regularly trained and made aware of best practices, organizational policies, and compliance mandates. Regular workshops, webinars, or training sessions can go a long way in ensuring everyone is on the same page when it comes to security and compliance.

In conclusion, while tools and technologies provide robust capabilities to detect and flag potential issues, the human element—understanding, communication, training, and documentation—remains pivotal. Together, they form a potent combination to ensure that your Lambda functions and broader infrastructure remain compliant, secure, and optimized for your business needs.

Compliance validation for AWS Lambda

Third-party auditors assess the security and compliance of AWS Lambda as part of multiple AWS compliance programs. These include SOC, PCI, FedRAMP, HIPAA, and others.

For a list of AWS services in scope of specific compliance programs, see [AWS services in scope by compliance program](#). For general information, see [AWS compliance programs](#).

You can download third-party audit reports using AWS Artifact. For more information, see [Downloading reports in AWS artifact](#).

Your compliance responsibility when using Lambda is determined by the sensitivity of your data, your company's compliance objectives, and applicable laws and regulations. You can implement governance controls to ensure that your company's Lambda functions meet your compliance requirements. For more information, see [Create a governance strategy for Lambda functions and layers](#).

Resilience in AWS Lambda

The AWS global infrastructure is built around AWS Regions and Availability Zones. AWS Regions provide multiple physically separated and isolated Availability Zones, which are connected with low-latency, high-throughput, and highly redundant networking. With Availability Zones, you can design and operate applications and databases that automatically fail over between Availability Zones without interruption. Availability Zones are more highly available, fault tolerant, and scalable than traditional single or multiple data center infrastructures.

For more information about AWS Regions and Availability Zones, see [AWS global infrastructure](#).

In addition to the AWS global infrastructure, Lambda offers several features to help support your data resiliency and backup needs.

- **Versioning** – You can use versioning in Lambda to save your function's code and configuration as you develop it. Together with aliases, you can use versioning to perform blue/green and rolling deployments. For details, see [Manage Lambda function versions](#).
- **Scaling** – When your function receives a request while it's processing a previous request, Lambda launches another instance of your function to handle the increased load. Lambda automatically scales to handle 1,000 concurrent executions per Region, a [quota](#) that can be increased if needed. For details, see [Understanding Lambda function scaling](#).

- **High availability** – Lambda runs your function in multiple Availability Zones to ensure that it is available to process events in case of a service interruption in a single zone. If you configure your function to connect to a virtual private cloud (VPC) in your account, specify subnets in multiple Availability Zones to ensure high availability. For details, see [Giving Lambda functions access to resources in an Amazon VPC](#).
- **Reserved concurrency** – To make sure that your function can always scale to handle additional requests, you can reserve concurrency for it. Setting reserved concurrency for a function ensures that it can scale to, but not exceed, a specified number of concurrent invocations. This ensures that you don't lose requests due to other functions consuming all of the available concurrency. For details, see [Configuring reserved concurrency for a function](#).
- **Retries** – For asynchronous invocations and a subset of invocations triggered by other services, Lambda automatically retries on error with delays between retries. Other clients and AWS services that invoke functions synchronously are responsible for performing retries. For details, see [Understanding retry behavior in Lambda](#).
- **Dead-letter queue** – For asynchronous invocations, you can configure Lambda to send requests to a dead-letter queue if all retries fail. A dead-letter queue is an Amazon SNS topic or Amazon SQS queue that receives events for troubleshooting or reprocessing. For details, see [Adding a dead-letter queue](#).

Infrastructure security in AWS Lambda

As a managed service, AWS Lambda is protected by AWS global network security. For information about AWS security services and how AWS protects infrastructure, see [AWS Cloud Security](#). To design your AWS environment using the best practices for infrastructure security, see [Infrastructure Protection](#) in *Security Pillar AWS Well-Architected Framework*.

You use AWS published API calls to access Lambda through the network. Clients must support the following:

- Transport Layer Security (TLS). We require TLS 1.2 and recommend TLS 1.3.
- Cipher suites with perfect forward secrecy (PFS) such as DHE (Ephemeral Diffie-Hellman) or ECDHE (Elliptic Curve Ephemeral Diffie-Hellman). Most modern systems such as Java 7 and later support these modes.

Additionally, requests must be signed by using an access key ID and a secret access key that is associated with an IAM principal. Or you can use the [AWS Security Token Service](#) (AWS STS) to generate temporary security credentials to sign requests.

Securing workloads with public endpoints

For workloads that are accessible publicly, AWS provides a number of features and services that can help mitigate certain risks. This section covers authentication and authorization of application users and protecting API endpoints.

Authentication and authorization

Authentication relates to identity and authorization refers to actions. Use authentication to control who can invoke a Lambda function, and then use authorization to control what they can do. For many applications, IAM is sufficient for managing both control mechanisms.

For applications with external users, such as web or mobile applications, it is common to use [JSON Web Tokens](#) (JWTs) to manage authentication and authorization. Unlike traditional, server-based password management, JWTs are passed from the client on every request. They are a cryptographically secure way to verify identity and claims using data passed from the client. For Lambda-based applications, this allows you to secure every call to each API endpoint without relying on a central server for authentication.

You can [implement JWTs with Amazon Cognito](#), a user directory service that can handle registration, authentication, account recovery, and other common account management operations. [Amplify Framework](#) provides libraries to simplify integrating this service into your frontend application. You can also consider third-party partner services like [Auth0](#).

Given the critical security role of an identity provider service, it's important to use professional tooling to safeguard your application. It's not recommended that you write your own services to handle authentication or authorization. Any vulnerabilities in custom libraries may have significant implications for the security of your workload and its data.

Protecting API endpoints

For serverless applications, the preferred way to serve a backend application publicly is to use Amazon API Gateway. This can help you protect an API from malicious users or spikes in traffic.

API Gateway offers two endpoint types for serverless developers: [REST APIs](#) and [HTTP APIs](#). Both support [authorization using AWS Lambda](#), IAM, or Amazon Cognito. When using IAM or Amazon

Cognito, incoming requests are evaluated and if they are missing a required token or contain invalid authentication, the request is rejected. You are not charged for these requests and they do not count towards any throttling quotas.

Unauthenticated API routes may be accessed by anyone on the public internet so it's recommended that you limit the use of unauthenticated APIs. If you must use unauthenticated APIs, it's important to protect these against common risks, such as [denial-of-service](#) (DoS) attacks. [Applying AWS WAF](#) to these APIs can help protect your application from SQL injection and cross-site scripting (XSS) attacks. API Gateway also implements [throttling](#) at the AWS account-level and per-client level when API keys are used.

In many cases, the functionality provided by unauthenticated API can be achieved with an alternative approach. For example, a web application may provide a list of customer retail stores from a DynamoDB table to users who are not logged in. This request may originate from a frontend web application or from any other source that calls the URL endpoint. This diagram compares three solutions:

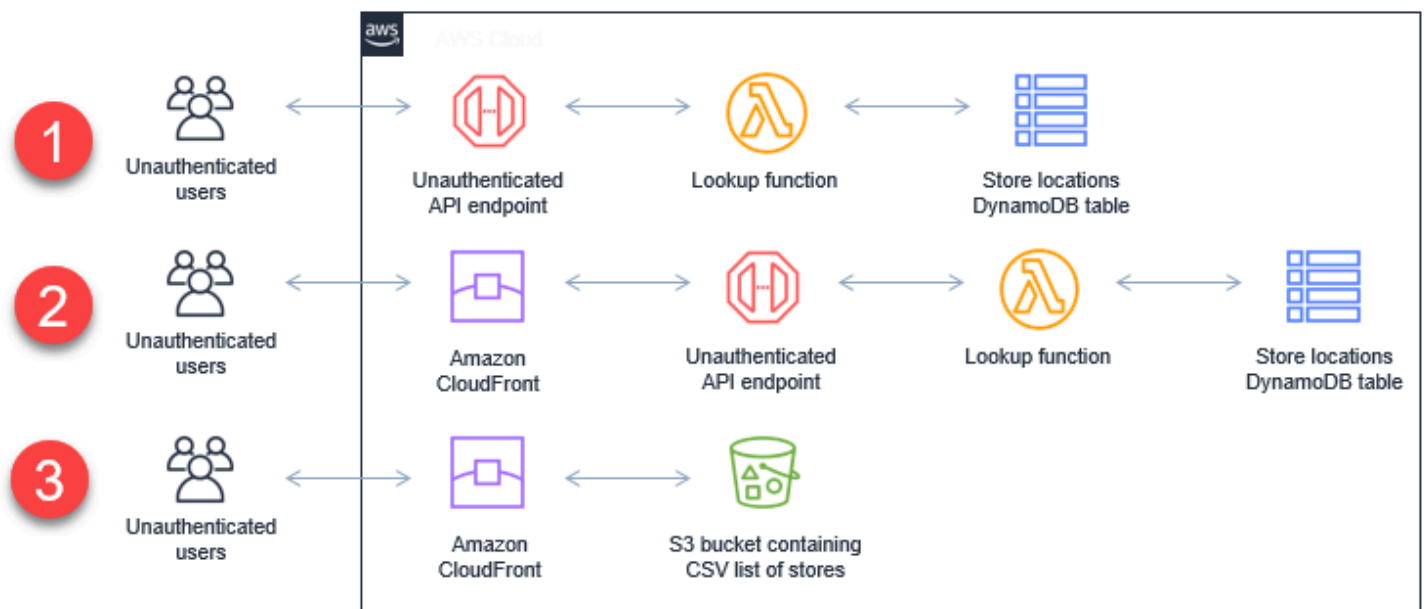

1. This unauthenticated API can be called by anyone on the internet. In a denial of service attack, it's possible to exhaust API throttling limits, Lambda concurrency, or DynamoDB provisioned read capacity on an underlying table.
2. A CloudFront distribution in front of the API endpoint with an appropriate [time-to-live](#) (TTL) configuration would absorb most of the traffic in a DoS attack, without changing the underlying solution for fetching the data.

3. Alternatively, for static data that rarely changes, the CloudFront distribution could serve the data' from an Amazon S3 bucket.

Using code signing to verify code integrity with Lambda

Code signing for AWS Lambda helps to ensure that only trusted code runs in your Lambda functions. When you enable code signing for a function, Lambda checks every code deployment and verifies that the code package is signed by a trusted source.

Note

Functions defined as container images do not support code signing.

To verify code integrity, use [AWS Signer](#) to create digitally signed code packages for functions and layers. When a user attempts to deploy a code package, Lambda performs validation checks on the code package before accepting the deployment. Because code signing validation checks run at deployment time, there is no performance impact on function execution.

You also use AWS Signer to create *signing profiles*. You use a signing profile to create the signed code package. Use AWS Identity and Access Management (IAM) to control who can sign code packages and create signing profiles. For more information, see [Authentication and Access Control](#) in the *AWS Signer Developer Guide*.

Lambda layers follow the same signed code package format as function code packages. When you add a layer to a function that has code signing enabled, Lambda checks that the layer is signed by an allowed signing profile. When you enable code signing for a function, all layers that are added to the function must also be signed by one of the allowed signing profiles.

You can configure code signing to log changes to AWS CloudTrail. Successful and blocked deployments to functions are logged to CloudTrail with information about the signature and validation checks.

There is no additional charge for using AWS Signer or code signing for AWS Lambda.

Signature validation

Lambda performs the following validation checks when you deploy a signed code package to your function:

1. Integrity – Validates that the code package has not been modified since it was signed. Lambda compares the hash of the package with the hash from the signature.
2. Expiry – Validates that the signature of the code package has not expired.
3. Mismatch – Validates that the code package is signed with one of the allowed signing profiles for the Lambda function. A mismatch also occurs if a signature is not present.
4. Revocation – Validates that the signature of the code package has not been revoked.

The signature validation policy defined in the code signing configuration determines which of the following actions Lambda takes if any of the validation checks fail:

- Warn – Lambda allows the deployment of the code package, but issues a warning. Lambda issues a new Amazon CloudWatch metric and also stores the warning in the CloudTrail log.
- Enforce – Lambda issues a warning (the same as for the Warn action) and blocks the deployment of the code package.

You can configure the policy for the expiry, mismatch, and revocation validation checks. Note that you cannot configure a policy for the integrity check. If the integrity check fails, Lambda blocks deployment.

Configuring code signing with the Lambda API

To manage code signing configurations with the AWS CLI or AWS SDK, use the following API operations:

- [ListCodeSigningConfigs](#)
- [CreateCodeSigningConfig](#)
- [GetCodeSigningConfig](#)
- [UpdateCodeSigningConfig](#)
- [DeleteCodeSigningConfig](#)

To manage the code signing configuration for a function, use the following API operations:

- [CreateFunction](#)
- [GetFunctionCodeSigningConfig](#)
- [PutFunctionCodeSigningConfig](#)

- [DeleteFunctionCodeSigningConfig](#)
- [ListFunctionsByCodeSigningConfig](#)

Topics

- [Creating code signing configurations for Lambda](#)
- [Updating a code signing configuration](#)
- [Configuring IAM policies for Lambda code signing configurations](#)
- [Using tags on code signing configurations](#)

Creating code signing configurations for Lambda

To enable code signing for a function, you create a *code signing configuration* and attach it to the function. A code signing configuration defines a list of allowed signing profiles and the policy action to take if any of the validation checks fail.

Sections

- [Configuration prerequisites](#)
- [Creating code signing configurations](#)
- [Enabling code signing for a function](#)

Configuration prerequisites

Before you can configure code signing for a Lambda function, use AWS Signer to do the following:

- Create one or more signing profiles.
- Use a signing profile to create a signed code package for your function.

For more information, see [Creating Signing Profiles \(Console\)](#) in the *AWS Signer Developer Guide*.

Creating code signing configurations

A code signing configuration defines a list of allowed signing profiles and the signature validation policy.

To create a code signing configuration (console)

1. Open the [Code signing configurations page](#) of the Lambda console.
2. Choose **Create configuration**.
3. For **Description**, enter a descriptive name for the configuration.
4. Under **Signing profiles**, add up to 20 signing profiles to the configuration.
 - a. For **Signing profile version ARN**, choose a profile version's Amazon Resource Name (ARN), or enter the ARN.
 - b. To add an additional signing profile, choose **Add signing profiles**.
5. Under **Signature validation policy**, choose **Warn** or **Enforce**.
6. Choose **Create configuration**.

Enabling code signing for a function

To enable code signing for a function, you associate a code signing configuration with the function.

To associate a code signing configuration with a function (console)

1. Open the [Functions page](#) of the Lambda console.
2. Choose the function for which you want to enable code signing.
3. Open the **Configuration** tab.
4. Scroll down and choose **Code signing**.
5. Choose **Edit**.
6. In **Edit code signing**, choose a code signing configuration for this function.
7. Choose **Save**.

Updating a code signing configuration

When you update a [code signing configuration](#), the changes impact the future deployments of functions that have the code signing configuration attached.

To update a code signing configuration (console)

1. Open the [Code signing configurations page](#) of the Lambda console.

2. Select a code signing configuration to update, and then choose **Edit**.
3. For **Description**, enter a descriptive name for the configuration.
4. Under **Signing profiles**, add up to 20 signing profiles to the configuration.
 - a. For **Signing profile version ARN**, choose a profile version's Amazon Resource Name (ARN), or enter the ARN.
 - b. To add an additional signing profile, choose **Add signing profiles**.
5. Under **Signature validation policy**, choose **Warn** or **Enforce**.
6. Choose **Save changes**.

Configuring IAM policies for Lambda code signing configurations

To grant permission for a user to access the [code signing API operations](#), attach one or more policy statements to the user policy. For more information about user policies, see [Identity-based IAM policies for Lambda](#).

The following example policy statement grants permission to create, update, and retrieve code signing configurations.

```
{
  "Version": "2012-10-17",
  "Statement": [
    {
      "Effect": "Allow",
      "Action": [
        "lambda:CreateCodeSigningConfig",
        "lambda:UpdateCodeSigningConfig",
        "lambda:GetCodeSigningConfig"
      ],
      "Resource": "*"
    }
  ]
}
```

Administrators can use the `CodeSigningConfigArn` condition key to specify the code signing configurations that developers must use to create or update your functions.

The following example policy statement grants permission to create a function. The policy statement includes a `lambda:CodeSigningConfigArn` condition to specify the

allowed code signing configuration. Lambda blocks any `CreateFunction` API request if its `CodeSigningConfigArn` parameter is missing or does not match the value in the condition.

```
{
  "Version": "2012-10-17",
  "Statement": [
    {
      "Sid": "AllowReferencingCodeSigningConfig",
      "Effect": "Allow",
      "Action": [
        "lambda:CreateFunction",
      ],
      "Resource": "*",
      "Condition": {
        "StringEquals": {
          "lambda:CodeSigningConfigArn":
            "arn:aws:lambda:us-west-2:123456789012:code-signing-
            config:csc-0d4518bd353a0a7c6"
        }
      }
    }
  ]
}
```

Using tags on code signing configurations

You can tag code signing configurations to organize and manage your resources. Tags are free-form key-value pairs associated with your resources that are supported across AWS services. For more information about use cases for tags, see [Common tagging strategies](#) in the *Tagging AWS Resources and Tag Editor Guide*.

You can use the AWS Lambda API to view and update tags. You can also view and update tags while managing a specific code signing configuration in the Lambda console.

Sections

- [Permissions required for working with tags](#)
- [Using tags with the Lambda console](#)
- [Using tags with the AWS CLI](#)

Permissions required for working with tags

To allow an AWS Identity and Access Management (IAM) identity (user, group, or role) to read or set tags on a resource, grant it the corresponding permissions:

- **lambda:ListTags**—When a resource has tags, grant this permission to anyone who needs to call `ListTags` on it. For tagged functions, this permission is also necessary for `GetFunction`.
- **lambda:TagResource**—Grant this permission to anyone who needs to call `TagResource` or perform a tag on create.

Optionally, consider granting the **lambda:UntagResource** permission as well to allow `UntagResource` calls to the resource.

For more information, see [Identity-based IAM policies for Lambda](#).

Using tags with the Lambda console

You can use the Lambda console to create code signing configurations that have tags, add tags to existing code signing configurations, and filter code signing configurations by tag.

To add a tag when you create a code signing configuration

1. Open [Code signing configurations](#) in the Lambda console.
2. From the header of the content pane, Choose **Create configuration**.
3. In the section at the top of the content pane, set up your code signing configuration. For more information about configuring code signing configurations, see [the section called “Code signing”](#).
4. In the **Tags** section, choose **Add new tag**.
5. In the **Key** field, enter your tag key. For information about tagging restrictions, see [Tag naming limits and requirements](#) in the *Tagging AWS Resources and Tag Editor Guide*.
6. Choose **Create configuration**.

To add a tag to an existing code signing configuration

1. Open [Code signing configurations](#) in the Lambda console.
2. Choose the name of your code signing configuration.

3. In the tabs below the **Detail** pane, choose **Tags**.
4. Choose **Manage tags**.
5. Choose **Add new tag**.
6. In the **Key** field, enter your tag key. For information about tagging restrictions, see [Tag naming limits and requirements](#) in the *Tagging AWS Resources and Tag Editor Guide*.
7. Choose **Save**.

To filter code signing configurations by tag

1. Open [Code signing configurations](#) in the Lambda console.
2. Choose the search box.
3. From the dropdown list, select your tag from below the **Tags** subheading.
4. Select **Use: "tag-name"** to see all code signing configurations tagged with this key, or choose an **Operator** to further filter by value.
5. Select your tag value to filter by a combination of tag key and value.

The search box also supports searching for tag keys. Enter the name of a key to find it in the list.

Using tags with the AWS CLI

You can add and remove tags on existing Lambda resources, including code signing configurations, with the Lambda API. You can also add tags when creating an code signing configuration, which allows you to keep a resource tagged through its entire lifecycle.

Updating tags with the Lambda tag APIs

You can add and remove tags for supported Lambda resources through the [TagResource](#) and [UntagResource](#) API operations.

You can call these operations using the AWS CLI. To add tags to an existing resource, use the `tag-resource` command. This example adds two tags, one with the key *Department* and one with the key *CostCenter*.

```
aws lambda tag-resource \  
--resource arn:aws:lambda:us-east-2:123456789012:resource-type:my-resource \  
--tags Department=Marketing, CostCenter=1234ABCD
```

To remove tags, use the `untag-resource` command. This example removes the tag with the key *Department*.

```
aws lambda untag-resource --resource arn:aws:lambda:us-east-1:123456789012:resource-  
type:resource-identifier \  
--tag-keys Department
```

Adding tags when creating a code signing configuration

To create a new Lambda code signing configuration with tags, use the [CreateCodeSigningConfig](#) API operation. Specify the `Tags` parameter. You can call this operation with the `create-code-signing-config` AWS CLI command and the `--tags` option. For more information about the CLI command, see [create-code-signing-config](#) in the *AWS CLI Command Reference*.

Before using the `Tags` parameter with `CreateCodeSigningConfig`, ensure that your role has permission to tag resources alongside the usual permissions needed for this operation. For more information about permissions for tagging, see [the section called "Permissions required for working with tags"](#).

Viewing tags with the Lambda tag APIs

To view the tags that are applied to a specific Lambda resource, use the `ListTags` API operation. For more information, see [ListTags](#).

You can call this operation with the `list-tags` AWS CLI command by providing an ARN (Amazon Resource Name).

```
aws lambda list-tags --resource arn:aws:lambda:us-east-1:123456789012:resource-  
type:resource-identifier
```

Filtering resources by tag

You can use the AWS Resource Groups Tagging API [GetResources](#) API operation to filter your resources by tags. The `GetResources` operation receives up to 10 filters, with each filter containing a tag key and up to 10 tag values. You provide `GetResources` with a `ResourceType` to filter by specific resource types.

You can call this operation using the `get-resources` AWS CLI command. For examples of using `get-resources`, see [get-resources](#) in the *AWS CLI Command Reference*.

Monitoring and troubleshooting Lambda functions

AWS Lambda integrates with other AWS services to help you monitor and troubleshoot your Lambda functions. Lambda automatically monitors Lambda functions on your behalf and reports metrics through Amazon CloudWatch. To help you monitor your code when it runs, Lambda automatically tracks the number of requests, the invocation duration per request, and the number of requests that result in an error.

You can use other AWS services to troubleshoot your Lambda functions. This section describes how to use these AWS services to monitor, trace, debug, and troubleshoot your Lambda functions and applications. For details about function logging and errors in each runtime, see individual runtime sections.

Sections

- [Pricing](#)
- [Using CloudWatch metrics with Lambda](#)
- [Using CloudWatch Logs with Lambda](#)
- [Logging AWS Lambda API calls using AWS CloudTrail](#)
- [Visualize Lambda function invocations using AWS X-Ray](#)
- [Monitor function performance with Amazon CloudWatch Lambda Insights](#)
- [Monitoring Lambda applications](#)
- [Monitor application performance with Amazon CloudWatch Application Signals](#)

Pricing

CloudWatch has a perpetual free tier. Beyond the free tier threshold, CloudWatch charges for metrics, dashboards, alarms, logs, and insights. For more information, see [Amazon CloudWatch pricing](#).

Using CloudWatch metrics with Lambda

When your AWS Lambda function finishes processing an event, Lambda automatically sends metrics about the invocation to Amazon CloudWatch. You don't need to grant any additional permissions to your execution role to receive function metrics, and there's no additional charge for these metrics.

There are many types of metrics associated with Lambda functions. These include invocation metrics, performance metrics, concurrency metrics, asynchronous invocation metrics, and event source mapping metrics. For more information, see [the section called "Metric types"](#).

In the CloudWatch console, you can [view these metrics](#) and build graphs and dashboards with them. You can also set alarms to respond to changes in utilization, performance, or error rates. Lambda sends metric data to CloudWatch in 1-minute intervals. For more immediate insight into your Lambda function, you can create [high-resolution custom metrics](#). Charges apply for custom metrics and CloudWatch alarms. For more information, see [Amazon CloudWatch Pricing](#).

Viewing metrics for Lambda functions

Use the CloudWatch console to view metrics for your Lambda functions. In the console, you can filter and sort function metrics by function name, alias, version, or event source mapping UUID.

To view metrics on the CloudWatch console

1. Open the [Metrics page](#) (AWS/Lambda namespace) of the CloudWatch console.
2. On the **Browse** tab, under **Metrics**, choose any of the following dimensions:
 - **By Function Name** (FunctionName) – View aggregate metrics for all versions and aliases of a function.
 - **By Resource** (Resource) – View metrics for a version or alias of a function.
 - **By Executed Version** (ExecutedVersion) – View metrics for a combination of alias and version. Use the ExecutedVersion dimension to compare error rates for two versions of a function that are both targets of a [weighted alias](#).
 - **By Event Source Mapping UUID** (EventSourceMappingUUID) – View metrics for an event source mapping.
 - **Across All Functions** (none) – View aggregate metrics for all functions in the current AWS Region.

3. Choose a metric. The metric should automatically appear in the visual graph, as well as under the **Graphed metrics** tab.

By default, graphs use the Sum statistic for all metrics. To choose a different statistic and customize the graph, use the options on the **Graphed metrics** tab.

 **Note**

The timestamp on a metric reflects when the function was invoked. Depending on the duration of the invocation, this can be several minutes before the metric is emitted. For example, if your function has a 10-minute timeout, then look more than 10 minutes in the past for accurate metrics.

For more information about CloudWatch, see the [Amazon CloudWatch User Guide](#).

Types of metrics for Lambda functions

This section describes the types of Lambda metrics available in the CloudWatch console.

Topics

- [Invocation metrics](#)
- [Performance metrics](#)
- [Concurrency metrics](#)
- [Asynchronous invocation metrics](#)
- [Event source mapping metrics](#)

Invocation metrics

Invocation metrics are binary indicators of the outcome of a Lambda function invocation. View these metrics with the Sum statistic. For example, if the function returns an error, then Lambda sends the `Errors` metric with a value of 1. To get a count of the number of function errors that occurred each minute, view the Sum of the `Errors` metric with a period of 1 minute.

- `Invocations` – The number of times that your function code is invoked, including successful invocations and invocations that result in a function error. Invocations aren't recorded if

the invocation request is throttled or otherwise results in an invocation error. The value of `Invocations` equals the number of requests billed.

- `Errors` – The number of invocations that result in a function error. Function errors include exceptions that your code throws and exceptions that the Lambda runtime throws. The runtime returns errors for issues such as timeouts and configuration errors. To calculate the error rate, divide the value of `Errors` by the value of `Invocations`. Note that the timestamp on an error metric reflects when the function was invoked, not when the error occurred.
- `DeadLetterErrors` – For [asynchronous invocation](#), the number of times that Lambda attempts to send an event to a dead-letter queue (DLQ) but fails. Dead-letter errors can occur due to incorrectly set resources or size limits.
- `DestinationDeliveryFailures` – For asynchronous invocation and supported [event source mappings](#), the number of times that Lambda attempts to send an event to a [destination](#) but fails. For event source mappings, Lambda supports destinations for stream sources (DynamoDB and Kinesis). Delivery errors can occur due to permissions errors, incorrectly configured resources, or size limits. Errors can also occur if the destination you have configured is an unsupported type such as an Amazon SQS FIFO queue or an Amazon SNS FIFO topic.
- `Throttles` – The number of invocation requests that are throttled. When all function instances are processing requests and no concurrency is available to scale up, Lambda rejects additional requests with a `TooManyRequestsException` error. Throttled requests and other invocation errors don't count as either `Invocations` or `Errors`.
- `OversizedRecordCount` – For Amazon DocumentDB event sources, the number of events your function receives from your change stream that are over 6 MB in size. Lambda drops the message and emits this metric.
- `ProvisionedConcurrencyInvocations` – The number of times that your function code is invoked using [provisioned concurrency](#).
- `ProvisionedConcurrencySpilloverInvocations` – The number of times that your function code is invoked using standard concurrency when all provisioned concurrency is in use.
- `RecursiveInvocationsDropped` – The number of times that Lambda has stopped invocation of your function because it has detected that your function is part of an infinite recursive loop. Recursive loop detection monitors how many times a function is invoked as part of a chain of requests by tracking metadata added by supported AWS SDKs. By default, if your function is invoked as part of a chain of requests approximately 16 times, Lambda drops the next invocation. If you disable recursive loop detection, this metric is not emitted. For more information about this feature, see [Use Lambda recursive loop detection to prevent infinite loops](#).

Performance metrics

Performance metrics provide performance details about a single function invocation. For example, the `Duration` metric indicates the amount of time in milliseconds that your function spends processing an event. To get a sense of how fast your function processes events, view these metrics with the `Average` or `Max` statistic.

- `Duration` – The amount of time that your function code spends processing an event. The billed duration for an invocation is the value of `Duration` rounded up to the nearest millisecond. `Duration` does not include cold start time.
- `PostRuntimeExtensionsDuration` – The cumulative amount of time that the runtime spends running code for extensions after the function code has completed.
- `IteratorAge` – For DynamoDB, Kinesis, and Amazon DocumentDB event sources, the age of the last record in the event in milliseconds. This metric measures the time between when a stream receives the record and when the event source mapping sends the event to the function.
- `OffsetLag` – For self-managed Apache Kafka and Amazon Managed Streaming for Apache Kafka (Amazon MSK) event sources, the difference in offset between the last record written to a topic and the last record that your function's consumer group processed. Though a Kafka topic can have multiple partitions, this metric measures the offset lag at the topic level.

`Duration` also supports percentile (p) statistics. Use percentiles to exclude outlier values that skew `Average` and `Maximum` statistics. For example, the p95 statistic shows the maximum duration of 95 percent of invocations, excluding the slowest 5 percent. For more information, see [Percentiles](#) in the *Amazon CloudWatch User Guide*.

Concurrency metrics

Lambda reports concurrency metrics as an aggregate count of the number of instances processing events across a function, version, alias, or AWS Region. To see how close you are to hitting [concurrency limits](#), view these metrics with the `Max` statistic.

- `ConcurrentExecutions` – The number of function instances that are processing events. If this number reaches your [concurrent executions quota](#) for the Region, or the [reserved concurrency](#) limit on the function, then Lambda throttles additional invocation requests.
- `ProvisionedConcurrentExecutions` – The number of function instances that are processing events using [provisioned concurrency](#). For each invocation of an alias or version with provisioned concurrency, Lambda emits the current count.

- **ProvisionedConcurrencyUtilization** – For a version or alias, the value of **ProvisionedConcurrentExecutions** divided by the total amount of provisioned concurrency configured. For example, if you configure a provisioned concurrency of 10 for your function, and your **ProvisionedConcurrentExecutions** is 7, then your **ProvisionedConcurrencyUtilization** is 0.7.
- **UnreservedConcurrentExecutions** – For a Region, the number of events that functions without reserved concurrency are processing.
- **ClaimedAccountConcurrency** – For a Region, the amount of concurrency that is unavailable for on-demand invocations. **ClaimedAccountConcurrency** is equal to **UnreservedConcurrentExecutions** plus the amount of allocated concurrency (i.e. the total reserved concurrency plus total provisioned concurrency). For more information, see [Working with the ClaimedAccountConcurrency metric](#).

Asynchronous invocation metrics

Asynchronous invocation metrics provide details about asynchronous invocations from event sources and direct invocations. You can set thresholds and alarms to notify you of certain changes. For example, when there's an undesired increase in the number of events queued for processing (**AsyncEventsReceived**). Or, when an event has been waiting a long time to be processed (**AsyncEventAge**).

- **AsyncEventsReceived** – The number of events that Lambda successfully queues for processing. This metric provides insight into the number of events that a Lambda function receives. Monitor this metric and set alarms for thresholds to check for issues. For example, to detect an undesirable number of events sent to Lambda, and to quickly diagnose issues resulting from incorrect trigger or function configurations. Mismatches between **AsyncEventsReceived** and **Invocations** can indicate a disparity in processing, events being dropped, or a potential queue backlog.
- **AsyncEventAge** – The time between when Lambda successfully queues the event and when the function is invoked. The value of this metric increases when events are being retried due to invocation failures or throttling. Monitor this metric and set alarms for thresholds on different statistics for when a queue buildup occurs. To troubleshoot an increase in this metric, look at the **Errors** metric to identify function errors and the **Throttles** metric to identify concurrency issues.
- **AsyncEventsDropped** – The number of events that are dropped without successfully executing the function. If you configure a dead-letter queue (DLQ) or **OnFailure** destination, then events

are sent there before they're dropped. Events are dropped for various reasons. For example, events can exceed the maximum event age or exhaust the maximum retry attempts, or reserved concurrency might be set to 0. To troubleshoot why events are dropped, look at the `Errors` metric to identify function errors and the `Throttles` metric to identify concurrency issues.

Event source mapping metrics

Event source mapping metrics provide insights into the processing behavior of your event source mapping. These metrics help you monitor the flow and status of events, including events that your event source mapping successfully processed, filtered, or dropped.

You must opt-in to receive metrics related to counts (`PolledEventCount`, `FilteredOutEventCount`, `InvokedEventCount`, `FailedInvokeEventCount`, `DroppedEventCount`, `OnFailureDestinationDeliveredEventCount`, and `DeletedEventCount`). To opt-in, you can use the console or the Lambda API.

To enable metrics on an event source mapping (console)

1. Open the [Functions page](#) of the Lambda console.
2. Choose the function you want to enable metrics for.
3. Choose **Configuration**, then choose **Triggers**.
4. Choose the event source mapping that you want to enable metrics for, then choose **Edit**.
5. Under **Event source mapping configuration**, choose **Enable metrics**.
6. Choose **Save**.

Alternatively, you can enable metrics for your event source mapping programmatically using the [EventSourceMappingMetricsConfig](#) object in your [EventSourceMappingConfiguration](#). For example, the following [UpdateEventSourceMapping](#) CLI command enables metrics for an event source mapping:

```
aws lambda update-event-source-mapping \  
  --uuid a1b2c3d4-5678-90ab-cdef-EXAMPLE11111 \  
  --metrics-config Metrics=EventCount
```

View metrics related to event counts with the `Sum` statistic.

⚠ Warning

Lambda event source mappings process each event at least once, and duplicate processing of records can occur. Because of this, events may be counted multiple times in metrics that involve event counts.

- **PolledEventCount** – The number of events that Lambda reads successfully from the event source. If Lambda polls for events but receives an empty poll (no new records), Lambda emits a 0 value for this metric. Use this metric to detect whether your event source mapping is correctly polling for new events.
- **FilteredOutEventCount** – For event source mapping with a [filter criteria](#), the number of events filtered out by that filter criteria. Use this metric to detect whether your event source mapping is properly filtering out events. For events that match the filter criteria, Lambda emits a 0 metric.
- **InvokedEventCount** – The number of events that invoked your Lambda function. Use this metric to verify that events are properly invoking your function. If an event results in a function error or throttling, **InvokedEventCount** may count multiple times for the same polled event due to automatic retries.
- **FailedInvokeEventCount** – The number of events that Lambda tried to invoke your function with, but failed. Invocations can fail due to reasons such as network configuration issues, incorrect permissions, or a deleted Lambda function, version, or alias. If your event source mapping has [partial batch responses](#) enabled, **FailedInvokeEventCount** includes any event with a non-empty `BatchItemFailures` in the response.

ℹ Note

The timestamp for the **FailedInvokeEventCount** metric represents the end of the function invocation. This behavior differs from other Lambda invocation error metrics, which are timestamped at the start of the function invocation.

- **DroppedEventCount** – The number of events that Lambda dropped due to expiry or retry exhaustion. Specifically, this is the number of records that exceed your configured values for `MaximumRecordAgeInSeconds` or `MaximumRetryAttempts`. Importantly, this doesn't include the number of records that expire due to exceeding your event source's retention settings.

Dropped events also excludes events that you send to an [on-failure destination](#). Use this metric to detect an increasing backlog of events.

- `OnFailureDestinationDeliveredEventCount` – For event source mappings with an [on-failure destination](#) configured, the number of events sent to that destination. Use this metric to monitor for function errors related to invocations from this event source. If delivery to the destination fails, Lambda handles metrics as follows:
 - Lambda doesn't emit the `OnFailureDestinationDeliveredEventCount` metric.
 - For the `DestinationDeliveryFailures` metric, Lambda emits a 1.
 - For the `DroppedEventCount` metric, Lambda emits a number equal to the number of events that failed delivery.
- `DeletedEventCount` – The number of events that Lambda successfully deletes after processing. If Lambda tries to delete an event but fails, Lambda emits a 0 metric. Use this metric to ensure that successfully processed events are deleted from your event source.

If your event source mapping is disabled, you won't receive event source mapping metrics. You may also see missing metrics if CloudWatch or Lambda is experiencing degraded availability.

Not every event source mapping metric is available for each event source. Currently, event source mapping metrics are available for Amazon SQS, Kinesis, and DynamoDB streams event sources. The following availability matrix summarizes the supported metrics for each type of event source.

Event source mapping metric	Support for Amazon SQS	Support for Kinesis and DynamoDB streams
<code>PolledEventCount</code>	Yes	Yes
<code>FilteredOutEventCount</code>	Yes	Yes
<code>InvokedEventCount</code>	Yes	Yes
<code>FailedInvokeEventCount</code>	Yes	Yes
<code>DroppedEventCount</code>	No	Yes

Event source mapping metric	Support for Amazon SQS	Support for Kinesis and DynamoDB streams
OnFailureDestinationDeliveredEventCount	No	Yes
DeletedEventCount	Yes	No

In addition, if your event source mapping is in [provisioned mode](#), Lambda provides the following metric:

- **ProvisionedPollers** – For event source mappings in provisioned mode, the number of event pollers that are actively running. View this metric using the MAX metric.

Using CloudWatch Logs with Lambda

AWS Lambda automatically monitors Lambda functions on your behalf to help you troubleshoot failures in your functions. As long as your function's [execution role](#) has the necessary permissions, Lambda captures logs for all requests handled by your function and sends them to Amazon CloudWatch Logs.

You can insert logging statements into your code to help you validate that your code is working as expected. Lambda automatically integrates with CloudWatch Logs and sends all logs from your code to a CloudWatch logs group associated with a Lambda function.

By default, Lambda sends logs to a log group named `/aws/lambda/<function name>`. If you want your function to send logs to another group, you can configure this using the Lambda console, the AWS Command Line Interface (AWS CLI) or the Lambda API. See [the section called "Configuring CloudWatch log groups"](#) to learn more.

You can view logs for Lambda functions using the Lambda console, the CloudWatch console, the AWS Command Line Interface (AWS CLI), or the CloudWatch API.

Note

It may take 5 to 10 minutes for logs to show up after a function invocation.

Required IAM permissions

Your [execution role](#) needs the following permissions to upload logs to CloudWatch Logs:

- `logs:CreateLogGroup`
- `logs:CreateLogStream`
- `logs:PutLogEvents`

To learn more, see [Using identity-based policies \(IAM policies\) for CloudWatch Logs](#) in the *Amazon CloudWatch User Guide*.

You can add these CloudWatch Logs permissions using the `AWSLambdaBasicExecutionRole` AWS managed policy provided by Lambda. To add this policy to your role, run the following command:

```
aws iam attach-role-policy --role-name your-role --policy-arn arn:aws:iam::aws:policy/service-role/AWSLambdaBasicExecutionRole
```

For more information, see [the section called “AWS managed policies”](#).

Pricing

There is no additional charge for using Lambda logs; however, standard CloudWatch Logs charges apply. For more information, see [CloudWatch pricing](#).

Configuring advanced logging controls for Lambda functions

To give you more control over how your functions' logs are captured, processed, and consumed, Lambda offers the following logging configuration options:

- **Log format** - select between plain text and structured JSON format for your function's logs
- **Log level** - for JSON structured logs, choose the detail level of the logs Lambda sends to CloudWatch, such as ERROR, DEBUG, or INFO
- **Log group** - choose the CloudWatch log group your function sends logs to

To learn more about configuring advanced logging controls, refer to the following sections:

Topics

- [Configuring JSON and plain text log formats](#)
- [Log-level filtering](#)
- [Configuring CloudWatch log groups](#)

Configuring JSON and plain text log formats

Capturing your log outputs as JSON key value pairs makes it easier to search and filter when debugging your functions. With JSON formatted logs, you can also add tags and contextual information to your logs. This can help you to perform automated analysis of large volumes of log data. Unless your development workflow relies on existing tooling that consumes Lambda logs in plain text, we recommend that you select JSON for your log format.

For all Lambda managed runtimes, you can choose whether your function's system logs are sent to CloudWatch Logs in unstructured plain text or JSON format. System logs are the logs that Lambda generates and are sometimes known as platform event logs.

For [supported runtimes](#), when you use one of the supported built-in logging methods, Lambda can also output your function's application logs (the logs your function code generates) in structured JSON format. When you configure your function's log format for these runtimes, the configuration you choose applies to both system and application logs.

For supported runtimes, if your function uses a supported logging library or method, you don't need to make any changes to your existing code for Lambda to capture logs in structured JSON.

Note

Using JSON log formatting adds additional metadata and encodes log messages as JSON objects containing a series of key value pairs. Because of this, the size of your function's log messages can increase.

Supported runtimes and logging methods

Lambda currently supports the option to output JSON structured application logs for the following runtimes.

Runtime	Supported versions
Java	All Java runtimes except Java 8 on Amazon Linux 1
.NET	.NET 8
Node.js	Node.js 16 and later
Python	Python 3.8 and later

For Lambda to send your function's application logs to CloudWatch in structured JSON format, your function must use the following built-in logging tools to output logs:

- **Java** - the `LambdaLogger` logger or `Log4j2`.

- **.NET** - the `ILambdaLogger` instance on the context object.
- **Node.js** - The console methods `console.trace`, `console.debug`, `console.log`, `console.info`, `console.error`, and `console.warn`
- **Python** - the standard Python logging library

For more information about using advanced logging controls with supported runtimes, see [the section called “Logging”](#), [the section called “Logging”](#), and [the section called “Logging”](#).

For other managed Lambda runtimes, Lambda currently only natively supports capturing system logs in structured JSON format. However, you can still capture application logs in structured JSON format in any runtime by using logging tools such as Powertools for AWS Lambda that output JSON formatted log outputs.

Default log formats

Currently, the default log format for all Lambda runtimes is plain text.

If you're already using logging libraries like Powertools for AWS Lambda to generate your function logs in JSON structured format, you don't need to change your code if you select JSON log formatting. Lambda doesn't double-encode any logs that are already JSON encoded, so your function's application logs will continue to be captured as before.

JSON format for system logs

When you configure your function's log format as JSON, each system log item (platform event) is captured as a JSON object that contains key value pairs with the following keys:

- `"time"` - the time the log message was generated
- `"type"` - the type of event being logged
- `"record"` - the contents of the log output

The format of the `"record"` value varies according to the type of event being logged. For more information see [the section called “Telemetry API Event object types”](#). For more information about the log levels assigned to system log events, see [the section called “System log level event mapping”](#).

For comparison, the following two examples show the same log output in both plain text and structured JSON formats. Note that in most cases, system log events contain more information when output in JSON format than when output in plain text.

Example plain text:

```
2024-03-13 18:56:24.046000 fbe8c1 INIT_START Runtime Version:
python:3.12.v18 Runtime Version ARN: arn:aws:lambda:eu-
west-1::runtime:edb5a058bfa782cb9cedc6d534ac8b8c193bc28e9a9879d9f5ebaaf619cd0fc0
```

Example structured JSON:

```
{
  "time": "2024-03-13T18:56:24.046Z",
  "type": "platform.initStart",
  "record": {
    "initializationType": "on-demand",
    "phase": "init",
    "runtimeVersion": "python:3.12.v18",
    "runtimeVersionArn": "arn:aws:lambda:eu-
west-1::runtime:edb5a058bfa782cb9cedc6d534ac8b8c193bc28e9a9879d9f5ebaaf619cd0fc0"
  }
}
```

Note

The [the section called “Telemetry API”](#) always emits platform events such as START and REPORT in JSON format. Configuring the format of the system logs Lambda sends to CloudWatch doesn't affect Lambda Telemetry API behavior.

JSON format for application logs

When you configure your function's log format as JSON, application log outputs written using supported logging libraries and methods are captured as a JSON object that contains key value pairs with the following keys.

- "timestamp" - the time the log message was generated
- "level" - the log level assigned to the message
- "message" - the contents of the log message

- "requestId" (Python, .NET, and Node.js) or "AWSrequestId" (Java) - the unique request ID for the function invocation

Depending on the runtime and logging method that your function uses, this JSON object may also contain additional key pairs. For example, in Node.js, if your function uses `console` methods to log error objects using multiple arguments, The JSON object will contain extra key value pairs with the keys `errorMessage`, `errorType`, and `stackTrace`. To learn more about JSON formatted logs in different Lambda runtimes, see [the section called "Logging"](#), [the section called "Logging"](#), and [the section called "Logging"](#).

Note

The key Lambda uses for the timestamp value is different for system logs and application logs. For system logs, Lambda uses the key "time" to maintain consistency with Telemetry API. For application logs, Lambda follows the conventions of the supported runtimes and uses "timestamp".

For comparison, the following two examples show the same log output in both plain text and structured JSON formats.

Example plain text:

```
2024-10-27T19:17:45.586Z 79b4f56e-95b1-4643-9700-2807f4e68189 INFO some log message
```

Example structured JSON:

```
{
  "timestamp": "2024-10-27T19:17:45.586Z",
  "level": "INFO",
  "message": "some log message",
  "requestId": "79b4f56e-95b1-4643-9700-2807f4e68189"
}
```

Setting your function's log format

To configure the log format for your function, you can use the Lambda console or the AWS Command Line Interface (AWS CLI). You can also configure a function's log format using the

[CreateFunction](#) and [UpdateFunctionConfiguration](#) Lambda API commands, the AWS Serverless Application Model (AWS SAM) [AWS::Serverless::Function](#) resource, and the AWS CloudFormation [AWS::Lambda::Function](#) resource.

Changing your function's log format doesn't affect existing logs stored in CloudWatch Logs. Only new logs will use the updated format.

If you change your function's log format to JSON and do not set log level, then Lambda automatically sets your function's application log level and system log level to INFO. This means that Lambda sends only log outputs of level INFO and lower to CloudWatch Logs. To learn more about application and system log-level filtering see [the section called "Log-level filtering"](#)

Note

For Python runtimes, when your function's log format is set to plain text, the default log-level setting is WARN. This means that Lambda only sends log outputs of level WARN and lower to CloudWatch Logs. Changing your function's log format to JSON changes this default behavior. To learn more about logging in Python, see [the section called "Logging"](#).

For Node.js functions that emit embedded metric format (EMF) logs, changing your function's log format to JSON could result in CloudWatch being unable to recognize your metrics.

Important

If your function uses Powertools for AWS Lambda (TypeScript) or the open-sourced EMF client libraries to emit EMF logs, update your [Powertools](#) and [EMF](#) libraries to the latest versions to ensure that CloudWatch can continue to parse your logs correctly. If you switch to the JSON log format, we also recommend that you carry out testing to ensure compatibility with your function's embedded metrics. For further advice about node.js functions that emit EMF logs, see [the section called "Using embedded metric format \(EMF\) client libraries with structured JSON logs"](#).

To configure a function's log format (console)

1. Open the [Functions page](#) of the Lambda console.
2. Choose a function

3. On the function configuration page, choose **Monitoring and operations tools**.
4. In the **Logging configuration** pane, choose **Edit**.
5. Under **Log content**, for **Log format** select either **Text** or **JSON**.
6. Choose **Save**.

To change the log format of an existing function (AWS CLI)

- To change the log format of an existing function, use the [update-function-configuration](#) command. Set the LogFormat option in LoggingConfig to either JSON or Text.

```
aws lambda update-function-configuration \  
  --function-name myFunction \  
  --logging-config LogFormat=JSON
```

To set log format when you create a function (AWS CLI)

- To configure log format when you create a new function, use the `--logging-config` option in the [create-function](#) command. Set LogFormat to either JSON or Text. The following example command creates a Node.js function that outputs logs in structured JSON.

If you don't specify a log format when you create a function, Lambda will use the default log format for the runtime version you select. For information about default logging formats, see [the section called "Default log formats"](#).

```
aws lambda create-function \  
  --function-name myFunction \  
  --runtime nodejs22.x \  
  --handler index.handler \  
  --zip-file fileb://function.zip \  
  --role arn:aws:iam::123456789012:role/LambdaRole \  
  --logging-config LogFormat=JSON
```

Log-level filtering

Lambda can filter your function's logs so that only logs of a certain detail level or lower are sent to CloudWatch Logs. You can configure log-level filtering separately for your function's system logs (the logs that Lambda generates) and application logs (the logs that your function code generates).

For [the section called “Supported runtimes and logging methods”](#), you don't need to make any changes to your function code for Lambda to filter your function's application logs.

For all other runtimes and logging methods, your function code must output log events to `stdout` or `stderr` as JSON formatted objects that contain a key value pair with the key `"level"`. For example, Lambda interprets the following output to `stdout` as a DEBUG level log.

```
print({'level': "debug", "msg": "my debug log", "timestamp":  
      "2024-11-02T16:51:31.587199Z"})
```

If the `"level"` value field is invalid or missing, Lambda will assign the log output the level INFO. For Lambda to use the `timestamp` field, you must specify the time in valid [RFC 3339](#) timestamp format. If you don't supply a valid timestamp, Lambda will assign the log the level INFO and add a timestamp for you.

When naming the `timestamp` key, follow the conventions of the runtime you are using. Lambda supports most common naming conventions used by the managed runtimes.

Note

To use log-level filtering, your function must be configured to use the JSON log format. The default log format for all Lambda managed runtimes is currently plain text. To learn how to configure your function's log format to JSON, see [the section called “Setting your function's log format”](#).

For application logs (the logs generated by your function code), you can choose between the following log levels.

Log level	Standard usage
TRACE (most detail)	The most fine-grained information used to trace the path of your code's execution
DEBUG	Detailed information for system debugging
INFO	Messages that record the normal operation of your function

Log level	Standard usage
WARN	Messages about potential errors that may lead to unexpected behavior if unaddressed
ERROR	Messages about problems that prevent the code from performing as expected
FATAL (least detail)	Messages about serious errors that cause the application to stop functioning

When you select a log level, Lambda sends logs at that level and lower to CloudWatch Logs. For example, if you set a function's application log level to WARN, Lambda doesn't send log outputs at the INFO and DEBUG levels. The default application log level for log filtering is INFO.

When Lambda filters your function's application logs, log messages with no level will be assigned the log level INFO.

For system logs (the logs generated by the Lambda service), you can choose between the following log levels.

Log level	Usage
DEBUG (most detail)	Detailed information for system debugging
INFO	Messages that record the normal operation of your function
WARN (least detail)	Messages about potential errors that may lead to unexpected behavior if unaddressed

When you select a log level, Lambda sends logs at that level and lower. For example, if you set a function's system log level to INFO, Lambda doesn't send log outputs at the DEBUG level.

By default, Lambda sets the system log level to INFO. With this setting, Lambda automatically sends "start" and "report" log messages to CloudWatch. To receive more or less detailed system logs, change the log level to DEBUG or WARN. To see a list of the log levels that Lambda maps different system log events to, see [the section called "System log level event mapping"](#).

Configuring log-level filtering

To configure application and system log-level filtering for your function, you can use the Lambda console or the AWS Command Line Interface (AWS CLI). You can also configure a function's log level using the [CreateFunction](#) and [UpdateFunctionConfiguration](#) Lambda API commands, the AWS Serverless Application Model (AWS SAM) [AWS::Serverless::Function](#) resource, and the AWS CloudFormation [AWS::Lambda::Function](#) resource.

Note that if you set your function's log level in your code, this setting takes precedence over any other log level settings you configure. For example, if you use the Python logging `setLevel()` method to set your function's logging level to INFO, this setting takes precedence over a setting of WARN that you configure using the Lambda console.

To configure an existing function's application or system log level (console)

1. Open the [Functions page](#) of the Lambda console.
2. Choose a function.
3. On the function configuration page, choose **Monitoring and operations tools**.
4. In the **Logging configuration** pane, choose **Edit**.
5. Under **Log content**, for **Log format** ensure **JSON** is selected.
6. Using the radio buttons, select your desired **Application log level** and **System log level** for your function.
7. Choose **Save**.

To configure an existing function's application or system log level (AWS CLI)

- To change the application or system log level of an existing function, use the [update-function-configuration](#) command. Use `--logging-config` to set `SystemLogLevel` to one of DEBUG, INFO, or WARN. Set `ApplicationLogLevel` to one of DEBUG, INFO, WARN, ERROR, or FATAL.

```
aws lambda update-function-configuration \  
  --function-name myFunction \  
  --logging-config LogFormat=JSON,ApplicationLogLevel=ERROR,SystemLogLevel=WARN
```

To configure log-level filtering when you create a function

- To configure log-level filtering when you create a new function, use `--logging-config` to set the `SystemLogLevel` and `ApplicationLogLevel` keys in the [create-function](#) command. Set `SystemLogLevel` to one of `DEBUG`, `INFO`, or `WARN`. Set `ApplicationLogLevel` to one of `DEBUG`, `INFO`, `WARN`, `ERROR`, or `FATAL`.

```
aws lambda create-function \
  --function-name myFunction \
  --runtime nodejs22.x \
  --handler index.handler \
  --zip-file fileb://function.zip \
  --role arn:aws:iam::123456789012:role/LambdaRole \
  --logging-config LogFormat=JSON,ApplicationLogLevel=ERROR,SystemLogLevel=WARN
```

System log level event mapping

For system level log events generated by Lambda, the following table defines the log level assigned to each event. To learn more about the events listed in the table, see [the section called “Event schema reference”](#)

Event name	Condition	Assigned log level
initStart	runtimeVersion is set	INFO
initStart	runtimeVersion is not set	DEBUG
initRuntimeDone	status=success	DEBUG
initRuntimeDone	status!=success	WARN
initReport	initializationType!=on-demand	INFO
initReport	initializationType=on-demand	DEBUG
initReport	status!=success	WARN
restoreStart	runtimeVersion is set	INFO

Event name	Condition	Assigned log level
restoreStart	runtimeVersion is not set	DEBUG
restoreRuntimeDone	status=success	DEBUG
restoreRuntimeDone	status!=success	WARN
restoreReport	status=success	INFO
restoreReport	status!=success	WARN
start	-	INFO
runtimeDone	status=success	DEBUG
runtimeDone	status!=success	WARN
report	status=success	INFO
report	status!=success	WARN
extension	state=success	INFO
extension	state!=success	WARN
logSubscription	-	INFO
telemetrySubscription	-	INFO
logsDropped	-	WARN

Note

The [the section called “Telemetry API”](#) always emits the complete set of platform events. Configuring the level of the system logs Lambda sends to CloudWatch doesn't affect Lambda Telemetry API behavior.

Application log-level filtering with custom runtimes

When you configure application log-level filtering for your function, behind the scenes Lambda sets the application log level in the runtime using the `AWS_LAMBDA_LOG_LEVEL` environment variable. Lambda also sets your function's log format using the `AWS_LAMBDA_LOG_FORMAT` environment variable. You can use these variables to integrate Lambda advanced logging controls into a [custom runtime](#).

For the ability to configure logging settings for a function using a custom runtime with the Lambda console, AWS CLI, and Lambda APIs, configure your custom runtime to check the value of these environment variables. You can then configure your runtime's loggers in accordance with the log format and log levels you select.

Configuring CloudWatch log groups

By default, CloudWatch automatically creates a log group named `/aws/lambda/<function name>` for your function when it's first invoked. To configure your function to send logs to an existing log group, or to create a new log group for your function, you can use the Lambda console or the AWS CLI. You can also configure custom log groups using the [CreateFunction](#) and [UpdateFunctionConfiguration](#) Lambda API commands and the AWS Serverless Application Model (AWS SAM) [AWS::Serverless::Function](#) resource.

You can configure multiple Lambda functions to send logs to the same CloudWatch log group. For example, you could use a single log group to store logs for all of the Lambda functions that make up a particular application. When you use a custom log group for a Lambda function, the log streams Lambda creates include the function name and function version. This ensures that the mapping between log messages and functions is preserved, even if you use the same log group for multiple functions.

The log stream naming format for custom log groups follows this convention:

```
YYYY/MM/DD/<function_name>[<function_version>][<execution_environment_GUID>]
```

Note that when configuring a custom log group, the name you select for your log group must follow the [CloudWatch Logs naming rules](#). Additionally, custom log group names mustn't begin with the string `aws/`. If you create a custom log group beginning with `aws/`, Lambda won't be able to create the log group. As a result of this, your function's logs won't be sent to CloudWatch.

To change a function's log group (console)

1. Open the [Functions page](#) of the Lambda console.
2. Choose a function.
3. On the function configuration page, choose **Monitoring and operations tools**.
4. In the **Logging configuration** pane, choose **Edit**.
5. In the **Logging group** pane, for **CloudWatch log group**, choose **Custom**.
6. Under **Custom log group**, enter the name of the CloudWatch log group you want your function to send logs to. If you enter the name of an existing log group, then your function will use that group. If no log group exists with the name that you enter, then Lambda will create a new log group for your function with that name.

To change a function's log group (AWS CLI)

- To change the log group of an existing function, use the [update-function-configuration](#) command.

```
aws lambda update-function-configuration \  
  --function-name myFunction \  
  --logging-config LogGroup=myLogGroup
```

To specify a custom log group when you create a function (AWS CLI)

- To specify a custom log group when you create a new Lambda function using the AWS CLI, use the `--logging-config` option. The following example command creates a Node.js Lambda function that sends logs to a log group named `myLogGroup`.

```
aws lambda create-function \  
  --function-name myFunction \  
  --runtime nodejs22.x \  
  --handler index.handler \  
  --zip-file fileb://function.zip \  
  --role arn:aws:iam::123456789012:role/LambdaRole \  
  --logging-config LogGroup=myLogGroup
```

Execution role permissions

For your function to send logs to CloudWatch Logs, it must have the [logs:PutLogEvents](#) permission. When you configure your function's log group using the Lambda console, if your function doesn't have this permission, Lambda adds it to the function's [execution role](#) by default. When Lambda adds this permission, it gives the function permission to send logs to any CloudWatch Logs log group.

To prevent Lambda from automatically updating the function's execution role and edit it manually instead, expand **Permissions** and uncheck **Add required permissions**.

When you configure your function's log group using the AWS CLI, Lambda won't automatically add the `logs:PutLogEvents` permission. Add the permission to your function's execution role if it doesn't already have it. This permission is included in the [AWSLambdaBasicExecutionRole](#) managed policy.

Viewing CloudWatch logs for Lambda functions

You can view Amazon CloudWatch logs for your Lambda function using the Lambda console, the CloudWatch console, or the AWS Command Line Interface (AWS CLI). Follow the instructions in the following sections to access your function's logs.

Stream function logs with CloudWatch Logs Live Tail

Amazon CloudWatch Logs Live Tail helps you quickly troubleshoot your functions by displaying a streaming list of new log events directly in the Lambda console. You can view and filter ingested logs from your Lambda functions in real time, helping you to detect and resolve issues quickly.

Note

Live Tail sessions incur costs by session usage time, per minute. For more information about pricing, see [Amazon CloudWatch Pricing](#).

Comparing Live Tail and `--log-type Tail`

There are several differences between CloudWatch Logs Live Tail and the [LogType: Tail](#) option in the Lambda API (`--log-type Tail` in the AWS CLI):

- `--log-type Tail` returns only the first 4 KB of the invocation logs. Live Tail does not share this limit, and can receive up to 500 log events per second.

- `--log-type Tail` captures and sends the logs with the response, which can impact the function's response latency. Live Tail does not affect function response latency.
- `--log-type Tail` supports synchronous invocations only. Live Tail works for both synchronous and asynchronous invocations.

Permissions

The following permissions are required to start and stop CloudWatch Logs Live Tail sessions:

- `logs:DescribeLogGroups`
- `logs:StartLiveTail`
- `logs:StopLiveTail`

Start a Live Tail session in the Lambda console

1. Open the [Functions page](#) of the Lambda console.
2. Choose the name of the function.
3. Choose the **Test** tab.
4. In the **Test event** pane, choose **CloudWatch Logs Live Tail**.
5. For **Select log groups**, the function's log group is selected by default. You can select up to five log groups at a time.
6. (Optional) To display only log events that contain certain words or other strings, enter the word or string in the **Add filter pattern** box. The filters field is case-sensitive. You can include multiple terms and pattern operators in this field, including regular expressions (regex). For more information about pattern syntax, see [Filter pattern syntax](#) in the *Amazon CloudWatch Logs User Guide*.
7. Choose **Start**. Matching log events begin appearing in the window.
8. To stop the Live Tail session, choose **Stop**.

Note

The Live Tail session automatically stops after 15 minutes of inactivity or when the Lambda console session times out.

Access function logs using the console

1. Open the [Functions page](#) of the Lambda console.
2. Select a function.
3. Choose the **Monitor** tab.
4. Choose **View CloudWatch logs** to open the CloudWatch console.
5. Scroll down and choose the **Log stream** for the function invocations you want to look at.

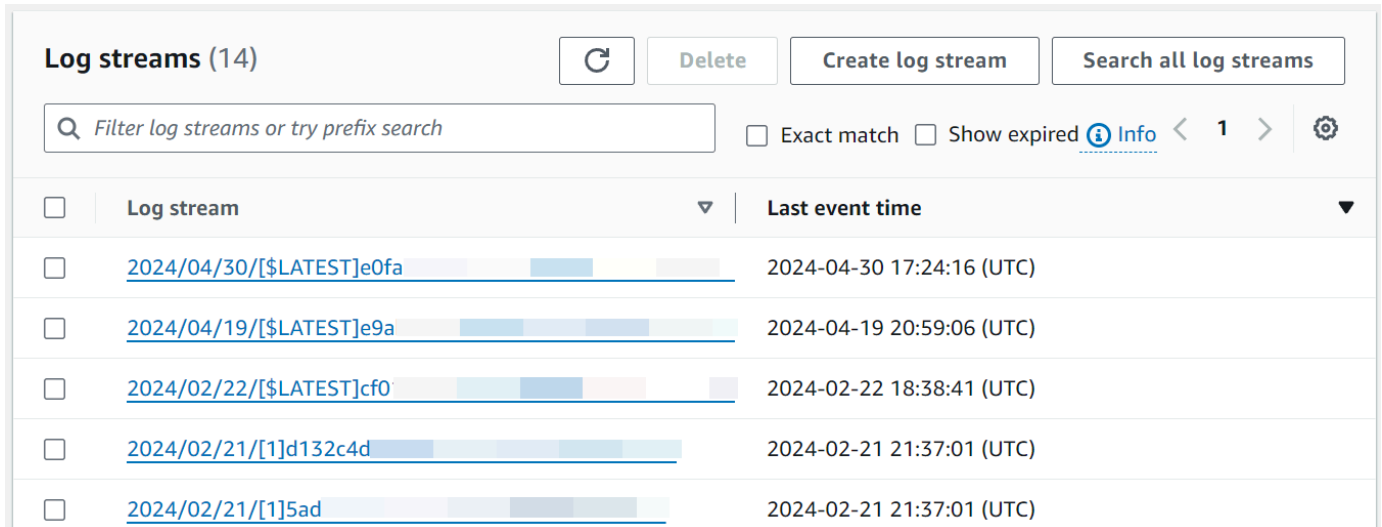

<input type="checkbox"/>	Log stream	Last event time
<input type="checkbox"/>	2024/04/30/[\$LATEST]e0fa	2024-04-30 17:24:16 (UTC)
<input type="checkbox"/>	2024/04/19/[\$LATEST]e9a	2024-04-19 20:59:06 (UTC)
<input type="checkbox"/>	2024/02/22/[\$LATEST]cf0	2024-02-22 18:38:41 (UTC)
<input type="checkbox"/>	2024/02/21/[1]d132c4d	2024-02-21 21:37:01 (UTC)
<input type="checkbox"/>	2024/02/21/[1]5ad	2024-02-21 21:37:01 (UTC)

Each instance of a Lambda function has a dedicated log stream. If a function scales up, each concurrent instance has its own log stream. Each time a new execution environment is created in response to an invocation, this generates a new log stream. The naming convention for log streams is:

```
YYYY/MM/DD[Function version][Execution environment GUID]
```

A single execution environment writes to the same log stream during its lifetime. The log stream contains messages from that execution environment and also any output from your Lambda function's code. Every message is timestamped, including your custom logs. Even if your function does not log any output from your code, there are three minimal log statements generated per invocation (START, END and REPORT):

▼	2020-10-08T15:52:11.447-04:00	START RequestId: 345a1711-d325-4af6-b01f-b0648975743f Version: \$LATEST	START RequestId: 345a1711-d325-4af6-b01f-b0648975743f Version: \$LATEST	Copy
▼	2020-10-08T15:52:12.452-04:00	END RequestId: 345a1711-d325-4af6-b01f-b0648975743f	END RequestId: 345a1711-d325-4af6-b01f-b0648975743f	Copy
▼	2020-10-08T15:52:12.452-04:00	REPORT RequestId: 345a1711-d325-4af6-b01f-b0648975743f Duration: 1004.58 ms Billed Duration: 1100 ms Memory Size: 1...	REPORT RequestId: 345a1711-d325-4af6-b01f-b0648975743f Duration: 1004.58 ms Billed Duration: 1100 ms Memory Size: 128 MB Max Memory Used: 64 MB Init Duration: 295.85 ms	Copy

These logs show:

- **RequestId** – this is a unique ID generated per request. If the Lambda function retries a request, this ID does not change and appears in the logs for each subsequent retry.
- **Start/End** – these bookmark a single invocation, so every log line between these belongs to the same invocation.
- **Duration** – the total invocation time for the handler function, excluding INIT code.
- **Billed Duration** – applies ROUNDING logic for billing purposes.
- **Memory Size** – the amount of memory allocated to the function.
- **Max Memory Used** – the maximum amount of memory used during the invocation.
- **Init Duration** – the time taken to run the INIT section of code, outside of the main handler.

Access logs with the AWS CLI

The AWS CLI is an open-source tool that enables you to interact with AWS services using commands in your command line shell. To complete the steps in this section, you must have the [AWS CLI version 2](#).

You can use the [AWS CLI](#) to retrieve logs for an invocation using the `--log-type` command option. The response contains a `LogResult` field that contains up to 4 KB of base64-encoded logs from the invocation.

Example retrieve a log ID

The following example shows how to retrieve a *log ID* from the `LogResult` field for a function named `my-function`.

```
aws lambda invoke --function-name my-function out --log-type Tail
```

You should see the following output:

```
{
  "StatusCode": 200,
  "LogResult":
  "U1RBULQgUmVxdWVzdElk0iA4N2QwNDRi0C1mMTU0LTExZTgt0GNkYS0yOTc0YzVlNGZiMjEgVmVyc2lvb...",
  "ExecutedVersion": "$LATEST"
}
```

Example decode the logs

In the same command prompt, use the `base64` utility to decode the logs. The following example shows how to retrieve base64-encoded logs for `my-function`.

```
aws lambda invoke --function-name my-function out --log-type Tail \
--query 'LogResult' --output text --cli-binary-format raw-in-base64-out | base64 --
decode
```

The `cli-binary-format` option is required if you're using AWS CLI version 2. To make this the default setting, run `aws configure set cli-binary-format raw-in-base64-out`. For more information, see [AWS CLI supported global command line options](#) in the *AWS Command Line Interface User Guide for Version 2*.

You should see the following output:

```
START RequestId: 57f231fb-1730-4395-85cb-4f71bd2b87b8 Version: $LATEST
"AWS_SESSION_TOKEN": "AgoJb3JpZ2luX2VjELj...", "_X_AMZN_TRACE_ID": "Root=1-5d02e5ca-
f5792818b6fe8368e5b51d50;Parent=191db58857df8395;Sampled=0\"",ask/lib:/opt/lib",
END RequestId: 57f231fb-1730-4395-85cb-4f71bd2b87b8
REPORT RequestId: 57f231fb-1730-4395-85cb-4f71bd2b87b8 Duration: 79.67 ms Billed
Duration: 80 ms Memory Size: 128 MB Max Memory Used: 73 MB
```

The `base64` utility is available on Linux, macOS, and [Ubuntu on Windows](#). macOS users may need to use `base64 -D`.

Example get-logs.sh script

In the same command prompt, use the following script to download the last five log events. The script uses `sed` to remove quotes from the output file, and sleeps for 15 seconds to allow time for

the logs to become available. The output includes the response from Lambda and the output from the `get-log-events` command.

Copy the contents of the following code sample and save in your Lambda project directory as `get-logs.sh`.

The **cli-binary-format** option is required if you're using AWS CLI version 2. To make this the default setting, run `aws configure set cli-binary-format raw-in-base64-out`. For more information, see [AWS CLI supported global command line options](#) in the *AWS Command Line Interface User Guide for Version 2*.

```
#!/bin/bash
aws lambda invoke --function-name my-function --cli-binary-format raw-in-base64-out --
payload '{"key": "value"}' out
sed -i'' -e 's/"//g' out
sleep 15
aws logs get-log-events --log-group-name /aws/lambda/my-function --log-stream-
name stream1 --limit 5
```

Example macOS and Linux (only)

In the same command prompt, macOS and Linux users may need to run the following command to ensure the script is executable.

```
chmod -R 755 get-logs.sh
```

Example retrieve the last five log events

In the same command prompt, run the following script to get the last five log events.

```
./get-logs.sh
```

You should see the following output:

```
{
  "StatusCode": 200,
  "ExecutedVersion": "$LATEST"
}
{
  "events": [
    {
```

```

        "timestamp": 1559763003171,
        "message": "START RequestId: 4ce9340a-b765-490f-ad8a-02ab3415e2bf Version:
$LATEST\n",
        "ingestionTime": 1559763003309
    },
    {
        "timestamp": 1559763003173,
        "message": "2019-06-05T19:30:03.173Z\t4ce9340a-b765-490f-ad8a-02ab3415e2bf
\tINFO\tENVIRONMENT VARIABLES\r{\r  \"AWS_LAMBDA_FUNCTION_VERSION\": \"\n$LATEST\n",
\r ...",
        "ingestionTime": 1559763018353
    },
    {
        "timestamp": 1559763003173,
        "message": "2019-06-05T19:30:03.173Z\t4ce9340a-b765-490f-ad8a-02ab3415e2bf
\tINFO\tEVENT\r{\r  \"key\": \"value\"\r}\n",
        "ingestionTime": 1559763018353
    },
    {
        "timestamp": 1559763003218,
        "message": "END RequestId: 4ce9340a-b765-490f-ad8a-02ab3415e2bf\n",
        "ingestionTime": 1559763018353
    },
    {
        "timestamp": 1559763003218,
        "message": "REPORT RequestId: 4ce9340a-b765-490f-ad8a-02ab3415e2bf
\tDuration: 26.73 ms\tBilled Duration: 27 ms \tMemory Size: 128 MB\tMax Memory Used: 75
MB\t\n",
        "ingestionTime": 1559763018353
    }
  ],
  "nextForwardToken": "f/34783877304859518393868359594929986069206639495374241795",
  "nextBackwardToken": "b/34783877303811383369537420289090800615709599058929582080"
}

```

Parsing logs and structured logging

With CloudWatch Logs Insights, you can search and analyze log data using a specialized [query syntax](#). It performs queries over multiple log groups and provides powerful filtering using [glob](#) and [regular expressions](#) pattern matching.

You can take advantage of these capabilities by implementing structured logging in your Lambda functions. Structured logging organizes your logs into a pre-defined format, making it easier to

query for. Using log levels is an important first step in generating filter-friendly logs that separate informational messages from warnings or errors. For example, consider the following Node.js code:

```
exports.handler = async (event) => {
  console.log("console.log - Application is fine")
  console.info("console.info - This is the same as console.log")
  console.warn("console.warn - Application provides a warning")
  console.error("console.error - An error occurred")
}
```

The resulting CloudWatch log file contains a separate field specifying the log level:

```
START RequestId: 99d91f9b-2dff-40ad-b9c8-664020094109 Version: $LATEST
2020-10-22T12:21:28.268Z      99d91f9b-2dff-40ad-b9c8-664020094109 INFO console.log - Application is fine
2020-10-22T12:21:28.268Z      99d91f9b-2dff-40ad-b9c8-664020094109 INFO console.info - This is the same as console.log
2020-10-22T12:21:28.268Z      99d91f9b-2dff-40ad-b9c8-664020094109 WARN console.warn - Application provides a warning
2020-10-22T12:21:28.268Z      99d91f9b-2dff-40ad-b9c8-664020094109 ERROR console.error - An error occurred
END RequestId: 99d91f9b-2dff-40ad-b9c8-664020094109
REPORT RequestId: 99d91f9b-2dff-40ad-b9c8-664020094109 Duration: 3.13 ms Billed Duration: 100 ms Memory Size: 128 MB
Max Memory Used: 64 MB Init Duration: 142.18 ms
```

A CloudWatch Logs Insights query can then filter on log level. For example, to query for errors only, you can use the following query:

```
fields @timestamp, @message
| filter @message like /ERROR/
| sort @timestamp desc
```

JSON structured logging

JSON is commonly used to provide structure for application logs. In the following example, the logs have been converted to JSON to output three distinct values:

```
START RequestId: 22fda338-7b46-4c49-9531-efd6e8568480 Version: $LATEST
2020-10-22T11:35:59.216Z      22fda338-7b46-4c49-9531-efd6e8568480 INFO { uploadedBytes: 5453396,
invocation: 5, uploadTimeMS: 4519 }
END RequestId: 22fda338-7b46-4c49-9531-efd6e8568480
REPORT RequestId: 22fda338-7b46-4c49-9531-efd6e8568480 Duration: 1.25 ms Billed Duration: 100 ms Memory
Size: 128 MB Max Memory Used: 65 MB
```

The CloudWatch Logs Insights feature automatically discovers values in JSON output and parses the messages as fields, without the need for custom glob or regular expression. By using the JSON-structured logs, the following query finds invocations where the uploaded file was larger than 1 MB, the upload time was more than 1 second, and the invocation was not a cold start:

```
fields @message
```

```

| filter @message like /INFO/
| filter uploadedBytes > 1000000
| filter uploadTimeMS > 1000
| filter invocation != 1

```

This query might produce the following result:

The screenshot shows the AWS CloudWatch Logs Insights interface. On the left, a navigation menu includes options like Dashboards, Alarms, Billing, Logs, and Insights. The main area displays a query editor with the following query:

```

1 fields @message
2 | filter @message like /INFO/
3 | filter uploadedBytes > 1000000
4 | filter uploadTimeMS > 1000
5 | filter invocation != 1

```

Below the query editor, the results are shown in a table. The first few rows of the log entries are:

#	@timestamp	@message
1	2020-10-22T12:56:45.853Z	6b9f62f7-cffb-4664-99fd-ef099042c18a INFO { uploadedBytes: 6267459, invocation: 375, uploadTimeMS: 2082 }
2	2020-10-22T12:56:44.515Z	5294a304-e909-4d8b-9371-08a7011f07e4 INFO { uploadedBytes: 4984813, invocation: 372, uploadTimeMS: 2667 }
3	2020-10-22T12:56:43.627Z	f5a402ed-8495-4bce-8107-ee4f427523e INFO { uploadedBytes: 1850753, invocation: 370, uploadTimeMS: 1229 }
4	2020-10-22T12:56:42.744Z	49064079-475a-4534-a7c9-4ac1f7975e00 INFO { uploadedBytes: 2951740, invocation: 368, uploadTimeMS: 1063 }
5	2020-10-22T12:56:42.069Z	edfbb924-e142-44b8-ad33-f5e8500af66c INFO { uploadedBytes: 2197056, invocation: 367, uploadTimeMS: 2484 }
6	2020-10-22T12:56:41.968Z	5e72a917-97bb-473c-b230-c56c3fab0690 INFO { uploadedBytes: 1081180, invocation: 366, uploadTimeMS: 1226 }

On the right side of the console, the 'Discovered fields' menu is open, showing a list of fields with their respective percentages. The fields 'invocation', 'uploadedBytes', and 'uploadTimeMS' are highlighted with a red box, indicating they are the focus of the query.

The discovered fields in JSON are automatically populated in the *Discovered fields* menu on the right side. Standard fields emitted by the Lambda service are prefixed with '@', and you can query on these fields in the same way. Lambda logs always include the fields @timestamp, @logStream, @message, @requestId, @duration, @billedDuration, @type, @maxMemoryUsed, @memorySize. If X-Ray is enabled for a function, logs also include @xrayTraceId and @xraySegmentId.

When an AWS event source such as Amazon S3, Amazon SQS, or Amazon EventBridge invokes your function, the entire event is provided to the function as a JSON object input. By logging this event in the first line of the function, you can then query on any of the nested fields using CloudWatch Logs Insights.

Useful Insights queries

The following table shows example Insights queries that can be useful for monitoring Lambda functions.

Description	Example query syntax
The last 100 errors	fields Timestamp, LogLevel, Message

Description	Example query syntax
	<pre> filter LogLevel == "ERR" sort @timestamp desc limit 100</pre>
The top 100 highest billed invocations	<pre>filter @type = "REPORT" fields @requestId, @billedDuration sort by @billedDuration desc limit 100</pre>
Percentage of cold starts in total invocations	<pre>filter @type = "REPORT" stats sum(strcontains(@message, "Init Duration"))/count(*) * 100 as coldStartPct, avg(@duration) by bin(5m)</pre>
Percentile report of Lambda duration	<pre>filter @type = "REPORT" stats avg(@billedDuration) as Average, percentile(@billedDuration, 99) as NinetyNinth, percentile(@billedDuration, 95) as NinetyFifth, percentile(@billedDuration, 90) as Ninetieth by bin(30m)</pre>
Percentile report of Lambda memory usage	<pre>filter @type="REPORT" stats avg(@maxMemoryUsed/1024/1024) as mean_MemoryUsed, min(@maxMemoryUsed/1024/1024) as min_MemoryUsed, max(@maxMemoryUsed/1024/1024) as max_MemoryUsed, percentile(@maxMemoryUsed/1024/1024, 95) as Percentile95</pre>

Description	Example query syntax
Invocations using 100% of assigned memory	<pre>filter @type = "REPORT" and @maxMemoryUsed=@memorySize stats count_distinct(@requestId) by bin(30m)</pre>
Average memory used across invocations	<pre>avgMemoryUsedPERC, avg(@billedDuration) as avgDurationMS by bin(5m)</pre>
Visualization of memory statistics	<pre>filter @type = "REPORT" stats max(@maxMemoryUsed / 1024 / 1024) as maxMemMB, avg(@maxMemoryUsed / 1024 / 1024) as avgMemMB, min(@maxMemoryUsed / 1024 / 1024) as minMemMB, (avg(@maxMemoryUsed / 1024 / 1024) / max(@memorySize / 1024 / 1024)) * 100 as avgMemUsedPct, avg(@billedDuration) as avgDurationMS by bin(30m)</pre>
Invocations where Lambda exited	<pre>filter @message like /Process exited/ stats count() by bin(30m)</pre>
Invocations that timed out	<pre>filter @message like /Task timed out/ stats count() by bin(30m)</pre>

Description	Example query syntax
Latency report	<pre>filter @type = "REPORT" stats avg(@duration), max(@duration), min(@duration) by bin(5m)</pre>
Over-provisioned memory	<pre>filter @type = "REPORT" stats max(@memorySize / 1024 / 1024) as provisionedMemMB, min(@maxMemoryUsed / 1024 / 1024) as smallestMemReqMB, avg(@maxMemoryUsed / 1024 / 1024) as avgMemUsedMB, max(@maxMemoryUsed / 1024 / 1024) as maxMemUsedMB, provisionedMemMB - maxMemUsedMB as overProvisionedMB</pre>

Log visualization and dashboards

For any CloudWatch Logs Insights query, you can export the results to markdown or CSV format. In some cases, it might be more useful to create [visualizations from queries](#), providing there is at least one aggregation function. The `stats` function allows you to define aggregations and grouping.

The previous *logInsightsJSON* example filtered on upload size and upload time and excluded first invocations. This resulted in a table of data. For monitoring a production system, it may be more useful to visualize minimum, maximum, and average file sizes to find outliers. To do this, apply the `stats` function with the required aggregates, and group on a time value such as every minute:

For example, consider the following query. This is the same example query from the [the section called "JSON structured logging"](#) section, but with additional aggregation functions:

```
fields @message
| filter @message like /INFO/
| filter uploadedBytes > 1000000
| filter uploadTimeMS > 1000
| filter invocation != 1
```

```
| stats min(uploadedBytes), avg(uploadedBytes), max(uploadedBytes) by bin (1m)
```

We included these aggregates because it may be more useful to visualize minimum, maximum, and average file sizes to find outliers. You can view the results in the **Visualization** tab:

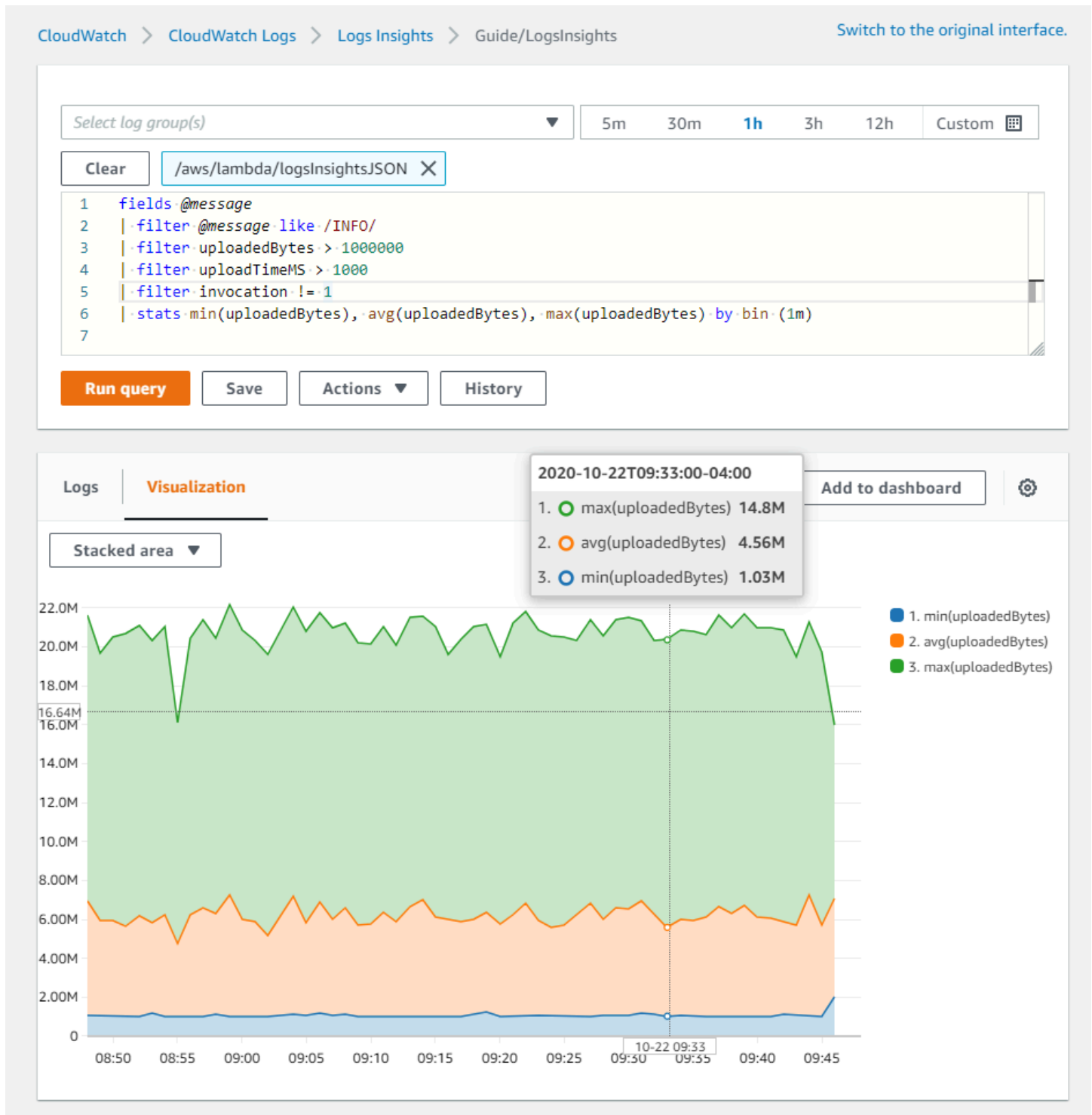

After you have finished building the visualization, you can optionally add the graph to a CloudWatch dashboard. To do this, choose **Add to dashboard** above the visualization. This adds the query as a widget and enables you to select automatic refresh intervals, making it easier to continuously monitor the results:

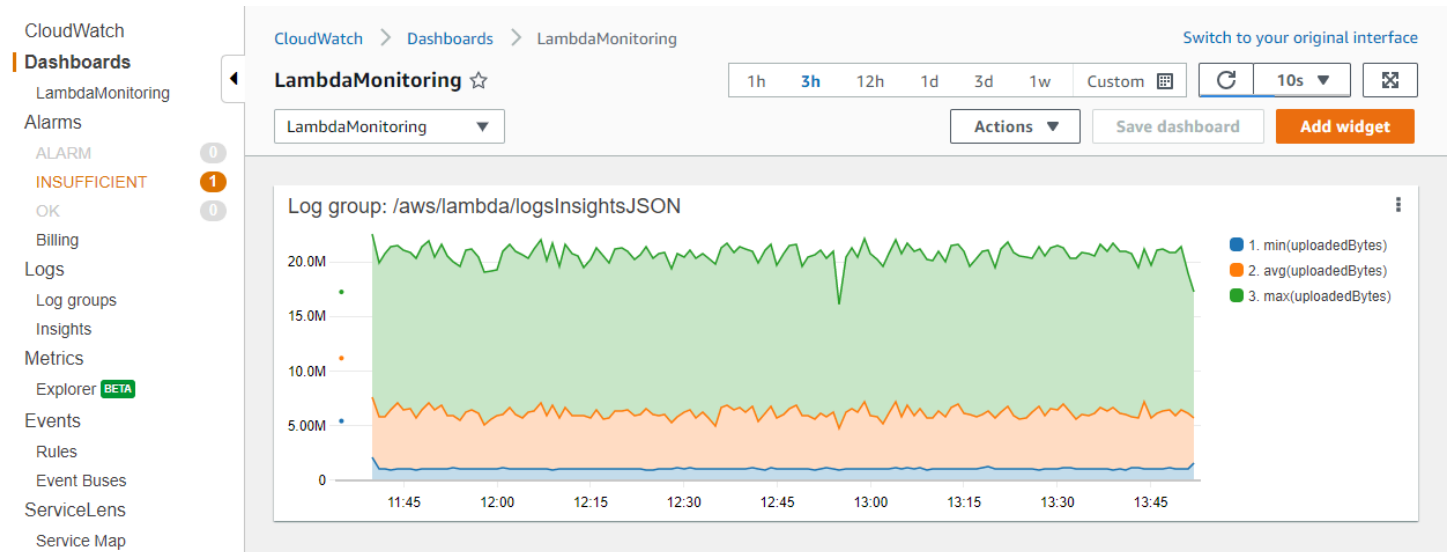

Logging AWS Lambda API calls using AWS CloudTrail

AWS Lambda is integrated with [AWS CloudTrail](#), a service that provides a record of actions taken by a user, role, or an AWS service. CloudTrail captures API calls for Lambda as events. The calls captured include calls from the Lambda console and code calls to the Lambda API operations. Using the information collected by CloudTrail, you can determine the request that was made to Lambda, the IP address from which the request was made, when it was made, and additional details.

Every event or log entry contains information about who generated the request. The identity information helps you determine the following:

- Whether the request was made with root user or user credentials.
- Whether the request was made on behalf of an IAM Identity Center user.
- Whether the request was made with temporary security credentials for a role or federated user.
- Whether the request was made by another AWS service.

CloudTrail is active in your AWS account when you create the account and you automatically have access to the CloudTrail **Event history**. The CloudTrail **Event history** provides a viewable, searchable, downloadable, and immutable record of the past 90 days of recorded management events in an AWS Region. For more information, see [Working with CloudTrail Event history](#) in the *AWS CloudTrail User Guide*. There are no CloudTrail charges for viewing the **Event history**.

For an ongoing record of events in your AWS account past 90 days, create a trail or a [CloudTrail Lake](#) event data store.

CloudTrail trails

A *trail* enables CloudTrail to deliver log files to an Amazon S3 bucket. All trails created using the AWS Management Console are multi-Region. You can create a single-Region or a multi-Region trail by using the AWS CLI. Creating a multi-Region trail is recommended because you capture activity in all AWS Regions in your account. If you create a single-Region trail, you can view only the events logged in the trail's AWS Region. For more information about trails, see [Creating a trail for your AWS account](#) and [Creating a trail for an organization](#) in the *AWS CloudTrail User Guide*.

You can deliver one copy of your ongoing management events to your Amazon S3 bucket at no charge from CloudTrail by creating a trail, however, there are Amazon S3 storage charges. For

more information about CloudTrail pricing, see [AWS CloudTrail Pricing](#). For information about Amazon S3 pricing, see [Amazon S3 Pricing](#).

CloudTrail Lake event data stores

CloudTrail Lake lets you run SQL-based queries on your events. CloudTrail Lake converts existing events in row-based JSON format to [Apache ORC](#) format. ORC is a columnar storage format that is optimized for fast retrieval of data. Events are aggregated into *event data stores*, which are immutable collections of events based on criteria that you select by applying [advanced event selectors](#). The selectors that you apply to an event data store control which events persist and are available for you to query. For more information about CloudTrail Lake, see [Working with AWS CloudTrail Lake](#) in the *AWS CloudTrail User Guide*.

CloudTrail Lake event data stores and queries incur costs. When you create an event data store, you choose the [pricing option](#) you want to use for the event data store. The pricing option determines the cost for ingesting and storing events, and the default and maximum retention period for the event data store. For more information about CloudTrail pricing, see [AWS CloudTrail Pricing](#).

Lambda data events in CloudTrail

[Data events](#) provide information about the resource operations performed on or in a resource (for example, reading or writing to an Amazon S3 object). These are also known as data plane operations. Data events are often high-volume activities. By default, CloudTrail doesn't log most data events, and the CloudTrail **Event history** doesn't record them.

One CloudTrail data event that is logged by default for supported services is `LambdaESMDisabled`. To learn more about using this event to help troubleshoot issues with Lambda event source mappings, see [the section called "Using CloudTrail to troubleshoot disabled Lambda event sources"](#).

Additional charges apply for data events. For more information about CloudTrail pricing, see [AWS CloudTrail Pricing](#).

You can log data events for the `AWS::Lambda::Function` resource type by using the CloudTrail console, AWS CLI, or CloudTrail API operations. For more information about how to log data events, see [Logging data events with the AWS Management Console](#) and [Logging data events with the AWS Command Line Interface](#) in the *AWS CloudTrail User Guide*.

The following table lists the Lambda resource type for which you can log data events. The **Data event type (console)** column shows the value to choose from the **Data event type** list on the CloudTrail console. The **resources.type value** column shows the `resources.type` value, which you would specify when configuring advanced event selectors using the AWS CLI or CloudTrail APIs. The **Data APIs logged to CloudTrail** column shows the API calls logged to CloudTrail for the resource type.

Data event type (console)	resources.type value	Data APIs logged to CloudTrail
Lambda	<code>AWS::Lambda::Function</code>	Invoke

You can configure advanced event selectors to filter on the `eventName`, `readOnly`, and `resources.ARN` fields to log only those events that are important to you. The following example is the JSON view of a data event configuration that logs events for a specific function only. For more information about these fields, see [AdvancedFieldSelector](#) in the *AWS CloudTrail API Reference*.

```
[
  {
    "name": "function-invokes",
    "fieldSelectors": [
      {
        "field": "eventCategory",
        "equals": [
          "Data"
        ]
      },
      {
        "field": "resources.type",
        "equals": [
          "AWS::Lambda::Function"
        ]
      },
      {
        "field": "resources.ARN",
        "equals": [
          "arn:aws:lambda:us-east-1:111122223333:function:hello-world"
        ]
      }
    ]
  }
]
```



```
    ]
  }
]
}
```

Lambda management events in CloudTrail

[Management events](#) provide information about management operations that are performed on resources in your AWS account. These are also known as control plane operations. By default, CloudTrail logs management events.

Lambda supports logging the following actions as management events in CloudTrail log files.

Note

In the CloudTrail log file, the eventName might include date and version information, but it is still referring to the same public API action. For example the, GetFunction action appears as GetFunction20150331v2. The following list specifies when the event name differs from the API action name.

- [AddLayerVersionPermission](#)
- [AddPermission](#) (event name: AddPermission20150331v2)
- [CreateAlias](#) (event name: CreateAlias20150331)
- [CreateEventSourceMapping](#) (event name: CreateEventSourceMapping20150331)
- [CreateFunction](#) (event name: CreateFunction20150331)

(The Environment and ZipFile parameters are omitted from the CloudTrail logs for CreateFunction.)

- [CreateFunctionUrlConfig](#)
- [DeleteAlias](#) (event name: DeleteAlias20150331)
- [DeleteCodeSigningConfig](#)
- [DeleteEventSourceMapping](#) (event name: DeleteEventSourceMapping20150331)
- [DeleteFunction](#) (event name: DeleteFunction20150331)
- [DeleteFunctionConcurrency](#) (event name: DeleteFunctionConcurrency20171031)

- [DeleteFunctionUrlConfig](#)
- [DeleteProvisionedConcurrencyConfig](#)
- [GetAlias](#) (event name: GetAlias20150331)
- [GetEventSourceMapping](#)
- [GetFunction](#)
- [GetFunctionUrlConfig](#)
- [GetFunctionConfiguration](#)
- [GetLayerVersionPolicy](#)
- [GetPolicy](#)
- [ListEventSourceMappings](#)
- [ListFunctions](#)
- [ListFunctionUrlConfigs](#)
- [PublishLayerVersion](#) (event name: PublishLayerVersion20181031)

(The ZipFile parameter is omitted from the CloudTrail logs for PublishLayerVersion.)

- [PublishVersion](#) (event name: PublishVersion20150331)
- [PutFunctionConcurrency](#) (event name: PutFunctionConcurrency20171031)
- [PutFunctionCodeSigningConfig](#)
- [PutFunctionEventInvokeConfig](#)
- [PutProvisionedConcurrencyConfig](#)
- [PutRuntimeManagementConfig](#)
- [RemovePermission](#) (event name: RemovePermission20150331v2)
- [TagResource](#) (event name: TagResource20170331v2)
- [UntagResource](#) (event name: UntagResource20170331v2)
- [UpdateAlias](#) (event name: UpdateAlias20150331)
- [UpdateCodeSigningConfig](#)
- [UpdateEventSourceMapping](#) (event name: UpdateEventSourceMapping20150331)
- [UpdateFunctionCode](#) (event name: UpdateFunctionCode20150331v2)

(The ZipFile parameter is omitted from the CloudTrail logs for UpdateFunctionCode.)

- [UpdateFunctionConfiguration](#) (event name: UpdateFunctionConfiguration20150331v2)

(The `Environment` parameter is omitted from the CloudTrail logs for `UpdateFunctionConfiguration`.)

- [UpdateFunctionEventInvokeConfig](#)
- [UpdateFunctionUrlConfig](#)

Using CloudTrail to troubleshoot disabled Lambda event sources

When you change the state of an event source mapping using the [UpdateEventSourceMapping](#) API action, the API call is logged as a management event in CloudTrail. Event source mappings can also transition directly to the `Disabled` state due to errors.

For the following services, Lambda publishes the `LambdaESMDisabled` data event to CloudTrail when your event source transitions to the `Disabled` state:

- Amazon Simple Queue Service (Amazon SQS)
- Amazon DynamoDB
- Amazon Kinesis

Lambda doesn't support this event for any other event source mapping types.

To receive alerts when event source mappings for supported services transition to the `Disabled` state, set up an alarm in Amazon CloudWatch using the `LambdaESMDisabled` CloudTrail event. To learn more about setting up a CloudWatch alarm, see [Creating CloudWatch alarms for CloudTrail events: examples](#).

The `serviceEventDetails` entity in the `LambdaESMDisabled` event message contains one of the following error codes.

RESOURCE_NOT_FOUND

The resource specified in the request does not exist.

FUNCTION_NOT_FOUND

The function attached to the event source does not exist.

REGION_NAME_NOT_VALID

A Region name provided to the event source or function is invalid.

AUTHORIZATION_ERROR

Permissions have not been set, or are misconfigured.

FUNCTION_IN_FAILED_STATE

The function code does not compile, has encountered an unrecoverable exception, or a bad deployment has occurred.

Lambda event examples

An event represents a single request from any source and includes information about the requested API operation, the date and time of the operation, request parameters, and so on. CloudTrail log files aren't an ordered stack trace of the public API calls, so events don't appear in any specific order.

The following example shows CloudTrail log entries for the `GetFunction` and `DeleteFunction` actions.

Note

The `eventName` might include date and version information, such as `"GetFunction20150331"`, but it is still referring to the same public API.

```
{
  "Records": [
    {
      "eventVersion": "1.03",
      "userIdentity": {
        "type": "IAMUser",
        "principalId": "A1B2C3D4E5F6G7EXAMPLE",
        "arn": "arn:aws:iam::111122223333:user/myUserName",
        "accountId": "111122223333",
        "accessKeyId": "AKIAIOSFODNN7EXAMPLE",
        "userName": "myUserName"
      },
      "eventTime": "2015-03-18T19:03:36Z",
      "eventSource": "lambda.amazonaws.com",
      "eventName": "GetFunction",
      "awsRegion": "us-east-1",
```

```

    "sourceIPAddress": "127.0.0.1",
    "userAgent": "Python-httpplib2/0.8 (gzip)",
    "errorCode": "AccessDenied",
    "errorMessage": "User: arn:aws:iam::111122223333:user/myUserName is not
authorized to perform: lambda:GetFunction on resource: arn:aws:lambda:us-
west-2:111122223333:function:other-acct-function",
    "requestParameters": null,
    "responseElements": null,
    "requestID": "7aebcd0f-cda1-11e4-aaa2-e356da31e4ff",
    "eventID": "e92a3e85-8ecd-4d23-8074-843aabfe89bf",
    "eventType": "AwsApiCall",
    "recipientAccountId": "111122223333"
  },
  {
    "eventVersion": "1.03",
    "userIdentity": {
      "type": "IAMUser",
      "principalId": "A1B2C3D4E5F6G7EXAMPLE",
      "arn": "arn:aws:iam::111122223333:user/myUserName",
      "accountId": "111122223333",
      "accessKeyId": "AKIAIOSFODNN7EXAMPLE",
      "userName": "myUserName"
    },
    "eventTime": "2015-03-18T19:04:42Z",
    "eventSource": "lambda.amazonaws.com",
    "eventName": "DeleteFunction20150331",
    "awsRegion": "us-east-1",
    "sourceIPAddress": "127.0.0.1",
    "userAgent": "Python-httpplib2/0.8 (gzip)",
    "requestParameters": {
      "functionName": "basic-node-task"
    },
    "responseElements": null,
    "requestID": "a2198ecc-cda1-11e4-aaa2-e356da31e4ff",
    "eventID": "20b84ce5-730f-482e-b2b2-e8fcc87ceb22",
    "eventType": "AwsApiCall",
    "recipientAccountId": "111122223333"
  }
]
}

```

For information about CloudTrail record contents, see [CloudTrail record contents](#) in the *AWS CloudTrail User Guide*.

Visualize Lambda function invocations using AWS X-Ray

You can use AWS X-Ray to visualize the components of your application, identify performance bottlenecks, and troubleshoot requests that resulted in an error. Your Lambda functions send trace data to X-Ray, and X-Ray processes the data to generate a service map and searchable trace summaries.

If you've enabled X-Ray tracing in a service that invokes your function, Lambda sends traces to X-Ray automatically. The upstream service, such as Amazon API Gateway, or an application hosted on Amazon EC2 that is instrumented with the X-Ray SDK, samples incoming requests and adds a tracing header that tells Lambda to send traces or not. Traces from upstream message producers, such as Amazon SQS, are automatically linked to traces from downstream Lambda functions, creating an end-to-end view of the entire application. For more information, see [Tracing event-driven applications](#) in the *AWS X-Ray Developer Guide*.

Note

X-Ray tracing is currently not supported for Lambda functions with Amazon Managed Streaming for Apache Kafka (Amazon MSK), self-managed Apache Kafka, Amazon MQ with ActiveMQ and RabbitMQ, or Amazon DocumentDB event source mappings.

To toggle active tracing on your Lambda function with the console, follow these steps:

To turn on active tracing

1. Open the [Functions page](#) of the Lambda console.
2. Choose a function.
3. Choose **Configuration** and then choose **Monitoring and operations tools**.
4. Choose **Edit**.
5. Under **X-Ray**, toggle on **Active tracing**.
6. Choose **Save**.

Your function needs permission to upload trace data to X-Ray. When you activate tracing in the Lambda console, Lambda adds the required permissions to your function's [execution role](#). Otherwise, add the [AWSXRayDaemonWriteAccess](#) policy to the execution role.

X-Ray doesn't trace all requests to your application. X-Ray applies a sampling algorithm to ensure that tracing is efficient, while still providing a representative sample of all requests. The sampling rate is 1 request per second and 5 percent of additional requests. You can't configure the X-Ray sampling rate for your functions.

Understanding X-Ray traces

In X-Ray, a *trace* records information about a request that is processed by one or more *services*. Lambda records 2 segments per trace, which creates two nodes on the service graph. The following image highlights these two nodes:

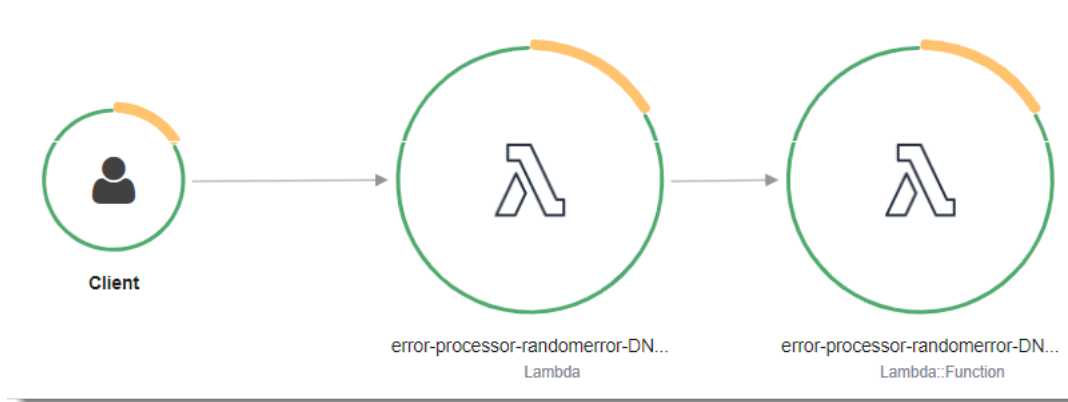

The first node on the left represents the Lambda service, which receives the invocation request. The second node represents your specific Lambda function.

The segment recorded for the Lambda service, `AWS::Lambda`, covers all the steps required to prepare the Lambda execution environment. This includes scheduling the MicroVM, creating or unfreezing an execution environment with the resources you have configured, as well as downloading your function code and all layers.

The `AWS::Lambda::Function` segment is for the work done by the function.

Note

AWS is currently implementing changes to the Lambda service. Due to these changes, you may see minor differences between the structure and content of system log messages and trace segments emitted by different Lambda functions in your AWS account. This change affects the subsegments of the function segment. The following paragraphs describe both the old and new formats for these subsegments.

These changes will be implemented during the coming weeks, and all functions in all AWS Regions except the China and GovCloud regions will transition to use the new-format log messages and trace segments.

Old-style AWS X-Ray Lambda segment structure

The old-style X-Ray structure for the `AWS::Lambda` segment looks like the following:

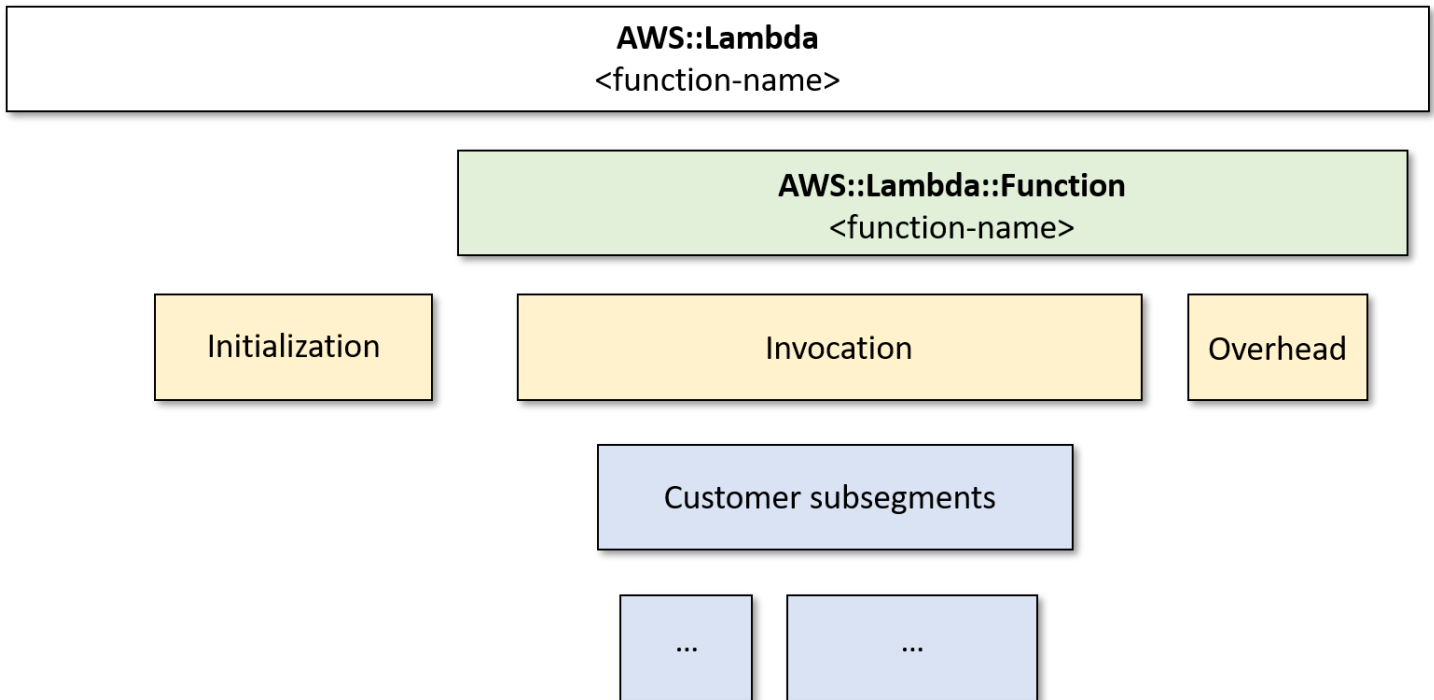

In this format, the function segment has subsegments for `Initialization`, `Invocation`, and `Overhead`. For [Lambda SnapStart](#) only, there is also a `Restore` subsegment (not shown on this diagram).

The `Initialization` subsegment represents the init phase of the Lambda execution environment lifecycle. During this phase, Lambda initializes extensions, initializes the runtime, and runs the function's initialization code.

The `Invocation` subsegment represents the invoke phase where Lambda invokes the function handler. This begins with runtime and extension registration and it ends when the runtime is ready to send the response.

(Lambda SnapStart only) The `Restore` subsegment shows the time it takes for Lambda to restore a snapshot, load the runtime (JVM), and run any `afterRestore` runtime hooks. The process of

restoring snapshots can include time spent on activities outside the MicroVM. This time is reported in the Restore subsegment. You aren't charged for the time spent outside the microVM to restore a snapshot.

The Overhead subsegment represents the phase that occurs between the time when the runtime sends the response and the signal for the next invoke. During this time, the runtime finishes all tasks related to an invoke and prepares to freeze the sandbox.

Important

You can use the X-Ray SDK to extend the Invocation subsegment with additional subsegments for downstream calls, annotations, and metadata. You can't access the function segment directly or record work done outside of the handler invocation scope.

For more information about Lambda execution environment phases, see [the section called “Execution environment”](#).

An example trace using the old-style X-Ray structure is shown in the following diagram.

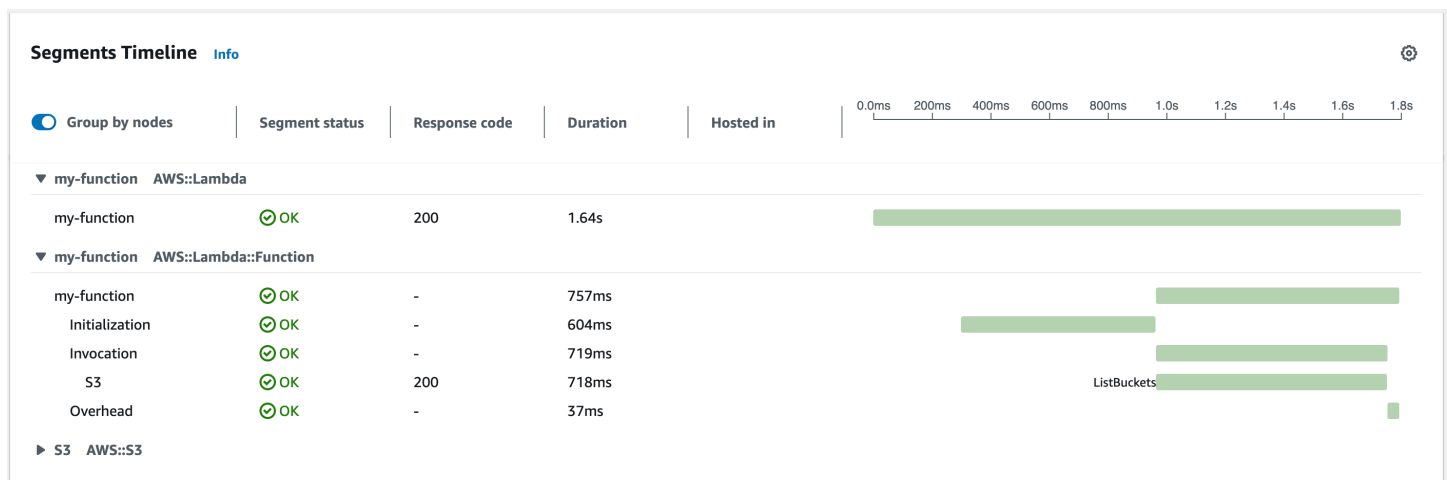

Note the two segments in the example. Both are named **my-function**, but one has an origin of `AWS::Lambda` and the other has an origin of `AWS::Lambda::Function`. If the `AWS::Lambda` segment shows an error, the Lambda service had an issue. If the `AWS::Lambda::Function` segment shows an error, your function had an issue.

Note

Occasionally, you may notice a large gap between the function initialization and invocation phases in your X-Ray traces. For functions using [provisioned concurrency](#), this is because Lambda initializes your function instances well in advance of invocation. For functions using [unreserved \(on-demand\) concurrency](#), Lambda may proactively initialize a function instance, even if there's no invocation. Visually, both of these cases show up as a time gap between the initialization and invocation phases.

New-style AWS X-Ray Lambda segment structure

The new-style X-Ray structure for the `AWS::Lambda` segment looks like the following:

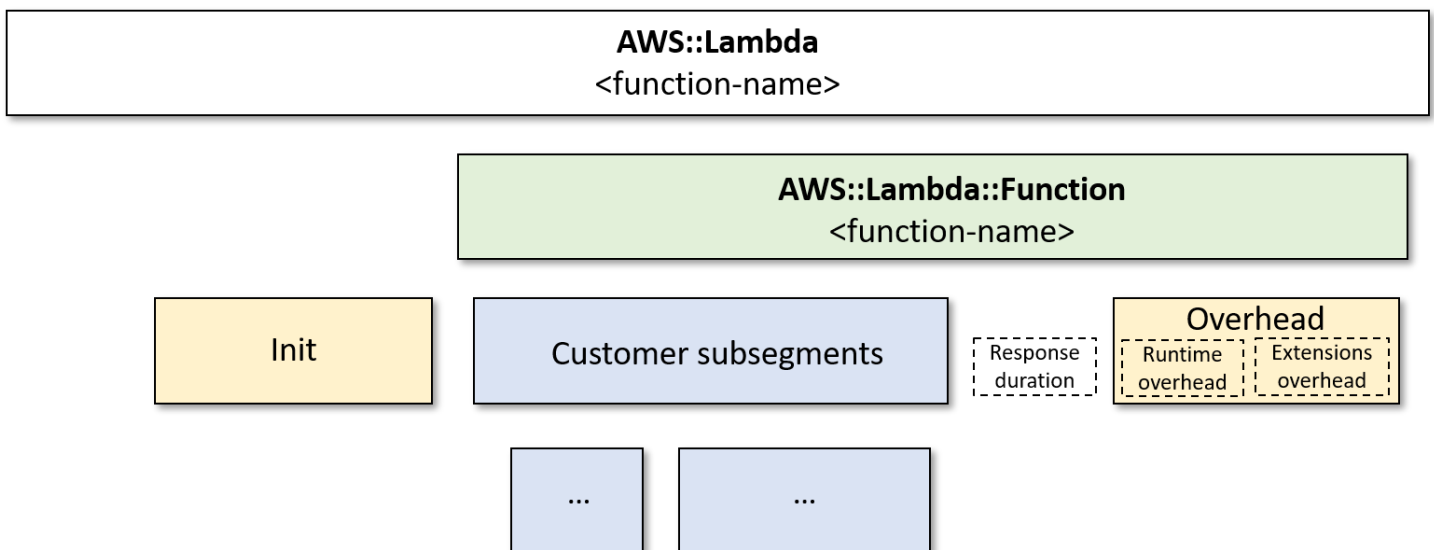

In this new format, The `Init` subsegment represents the init phase of the Lambda execution environment lifecycle as before.

There is no invocation segment in the new format. Instead, customer subsegments are attached directly to the `AWS::Lambda::Function` segment. This segment contains the following metrics as annotations:

- `aws.responseLatency` - the time taken for the function to run
- `aws.responseDuration` - the time taken to transfer the response to the customer
- `aws.runtimeOverhead` - the amount of additional time the runtime needed to finish
- `aws.extensionOverhead` - the amount of additional time the extensions needed to finish

An example trace using the new-style X-Ray structure is shown in the following diagram.

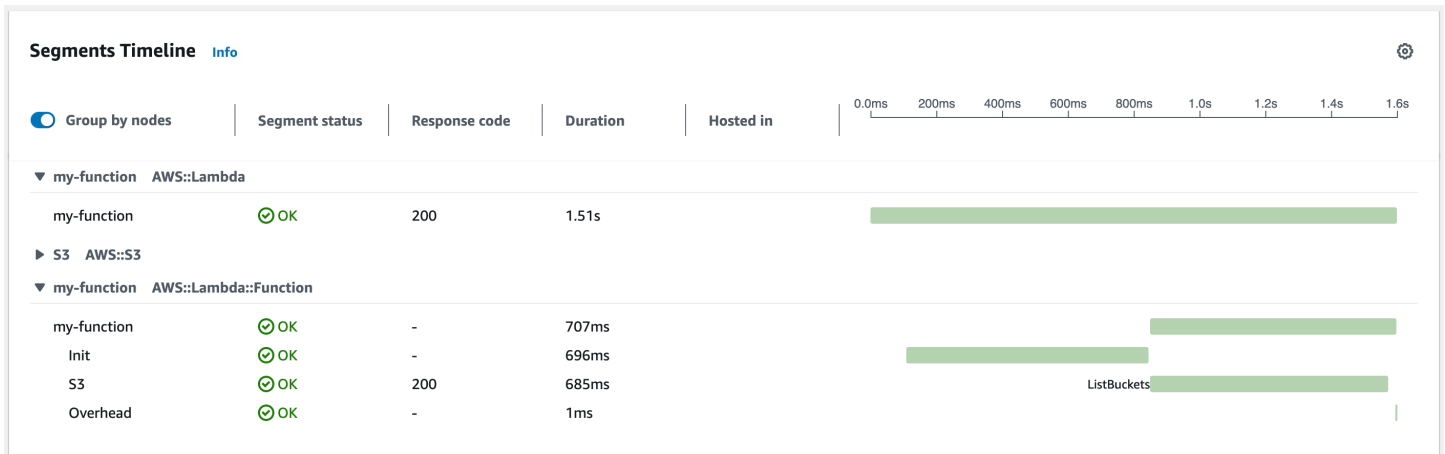

Note the two segments in the example. Both are named **my-function**, but one has an origin of `AWS::Lambda` and the other has an origin of `AWS::Lambda::Function`. If the `AWS::Lambda` segment shows an error, the Lambda service had an issue. If the `AWS::Lambda::Function` segment shows an error, your function had an issue.

See the following topics for a language-specific introduction to tracing in Lambda:

- [Instrumenting Node.js code in AWS Lambda](#)
- [Instrumenting Python code in AWS Lambda](#)
- [Instrumenting Ruby code in AWS Lambda](#)
- [Instrumenting Java code in AWS Lambda](#)
- [Instrumenting Go code in AWS Lambda](#)
- [Instrumenting C# code in AWS Lambda](#)

For a full list of services that support active instrumentation, see [Supported AWS services](#) in the AWS X-Ray Developer Guide.

Execution role permissions

Lambda needs the following permissions to send trace data to X-Ray. Add them to your function's [execution role](#).

- [xray:PutTraceSegments](#)
- [xray:PutTelemetryRecords](#)

These permissions are included in the [AWSXRayDaemonWriteAccess](#) managed policy.

The AWS X-Ray daemon

Instead of sending trace data directly to the X-Ray API, the X-Ray SDK uses a daemon process. The AWS X-Ray daemon is an application that runs in the Lambda environment and listens for UDP traffic that contains segments and subsegments. It buffers incoming data and writes it to X-Ray in batches, reducing the processing and memory overhead required to trace invocations.

The Lambda runtime allows the daemon to up to 3 percent of your function's configured memory or 16 MB, whichever is greater. If your function runs out of memory during invocation, the runtime terminates the daemon process first to free up memory.

The daemon process is fully managed by Lambda and cannot be configured by the user. All segments generated by function invocations are recorded in the same account as the Lambda function. The daemon cannot be configured to redirect them to any other account.

For more information, see [The X-Ray daemon](#) in the X-Ray Developer Guide.

Enabling active tracing with the Lambda API

To manage tracing configuration with the AWS CLI or AWS SDK, use the following API operations:

- [UpdateFunctionConfiguration](#)
- [GetFunctionConfiguration](#)
- [CreateFunction](#)

The following example AWS CLI command enables active tracing on a function named **my-function**.

```
aws lambda update-function-configuration --function-name my-function \  
--tracing-config Mode=Active
```

Tracing mode is part of the version-specific configuration when you publish a version of your function. You can't change the tracing mode on a published version.

Enabling active tracing with AWS CloudFormation

To activate tracing on an `AWS::Lambda::Function` resource in an AWS CloudFormation template, use the `TracingConfig` property.

Example [function-inline.yml](#) – Tracing configuration

```
Resources:
  function:
    Type: AWS::Lambda::Function
    Properties:
      TracingConfig:
        Mode: Active
      ...
```

For an AWS Serverless Application Model (AWS SAM) `AWS::Serverless::Function` resource, use the `Tracing` property.

Example [template.yml](#) – Tracing configuration

```
Resources:
  function:
    Type: AWS::Serverless::Function
    Properties:
      Tracing: Active
      ...
```

Monitor function performance with Amazon CloudWatch Lambda Insights

Amazon CloudWatch Lambda Insights collects and aggregates Lambda function runtime performance metrics and logs for your serverless applications. This page describes how to enable and use Lambda Insights to diagnose issues with your Lambda functions.

Sections

- [How Lambda Insights monitors serverless applications](#)
- [Pricing](#)
- [Supported runtimes](#)
- [Enabling Lambda Insights in the Lambda console](#)
- [Enabling Lambda Insights programmatically](#)
- [Using the Lambda Insights dashboard](#)
- [Example workflow to detect function anomalies](#)
- [Example workflow using queries to troubleshoot a function](#)
- [What's next?](#)

How Lambda Insights monitors serverless applications

CloudWatch Lambda Insights is a monitoring and troubleshooting solution for serverless applications running on AWS Lambda. The solution collects, aggregates, and summarizes system-level metrics including CPU time, memory, disk and network usage. It also collects, aggregates, and summarizes diagnostic information such as cold starts and Lambda worker shutdowns to help you isolate issues with your Lambda functions and resolve them quickly.

Lambda Insights uses a new CloudWatch Lambda Insights [extension](#), which is provided as a [Lambda layer](#). When you enable this extension on a Lambda function for a supported runtime, it collects system-level metrics and emits a single performance log event for every invocation of that Lambda function. CloudWatch uses embedded metric formatting to extract metrics from the log events. For more information, see [Using AWS Lambda extensions](#).

The Lambda Insights layer extends the `CreateLogStream` and `PutLogEvents` for the `/aws/lambda-insights/` log group.

Pricing

When you enable Lambda Insights for your Lambda function, Lambda Insights reports 8 metrics per function and every function invocation sends about 1KB of log data to CloudWatch. You only pay for the metrics and logs reported for your function by Lambda Insights. There are no minimum fees or mandatory service usage policies. You do not pay for Lambda Insights if the function is not invoked. For a pricing example, see [Amazon CloudWatch pricing](#).

Supported runtimes

You can use Lambda Insights with any of the runtimes that support [Lambda extensions](#).

Enabling Lambda Insights in the Lambda console

You can enable Lambda Insights enhanced monitoring on new and existing Lambda functions. When you enable Lambda Insights on a function in the Lambda console for a supported runtime, Lambda adds the Lambda Insights [extension](#) as a layer to your function, and verifies or attempts to attach the [CloudWatchLambdaInsightsExecutionRolePolicy](#) policy to your function's [execution role](#).

To enable Lambda Insights in the Lambda console

1. Open the [Functions page](#) of the Lambda console.
2. Choose your function.
3. Choose the **Configuration** tab.
4. On the left menu, choose **Monitoring and operations tools**.
5. On the **Additional monitoring tools** pane, choose **Edit**.
6. Under **CloudWatch Lambda Insights**, turn on **Enhanced monitoring**.
7. Choose **Save**.

Enabling Lambda Insights programmatically

You can also enable Lambda Insights using the AWS Command Line Interface (AWS CLI), AWS Serverless Application Model (SAM) CLI, AWS CloudFormation, or the AWS Cloud Development Kit (AWS CDK). When you enable Lambda Insights programmatically on a function for a supported runtime, CloudWatch attaches the [CloudWatchLambdaInsightsExecutionRolePolicy](#) policy to your function's [execution role](#).

For more information, see [Getting started with Lambda Insights](#) in the *Amazon CloudWatch User Guide*.

Using the Lambda Insights dashboard

The Lambda Insights dashboard has two views in the CloudWatch console: the multi-function overview and the single-function view. The multi-function overview aggregates the runtime metrics for the Lambda functions in the current AWS account and Region. The single-function view shows the available runtime metrics for a single Lambda function.

You can use the Lambda Insights dashboard multi-function overview in the CloudWatch console to identify over- and under-utilized Lambda functions. You can use the Lambda Insights dashboard single-function view in the CloudWatch console to troubleshoot individual requests.

To view the runtime metrics for all functions

1. Open the [Multi-function](#) page in the CloudWatch console.
2. Choose from the predefined time ranges, or choose a custom time range.
3. (Optional) Choose **Add to dashboard** to add the widgets to your CloudWatch dashboard.

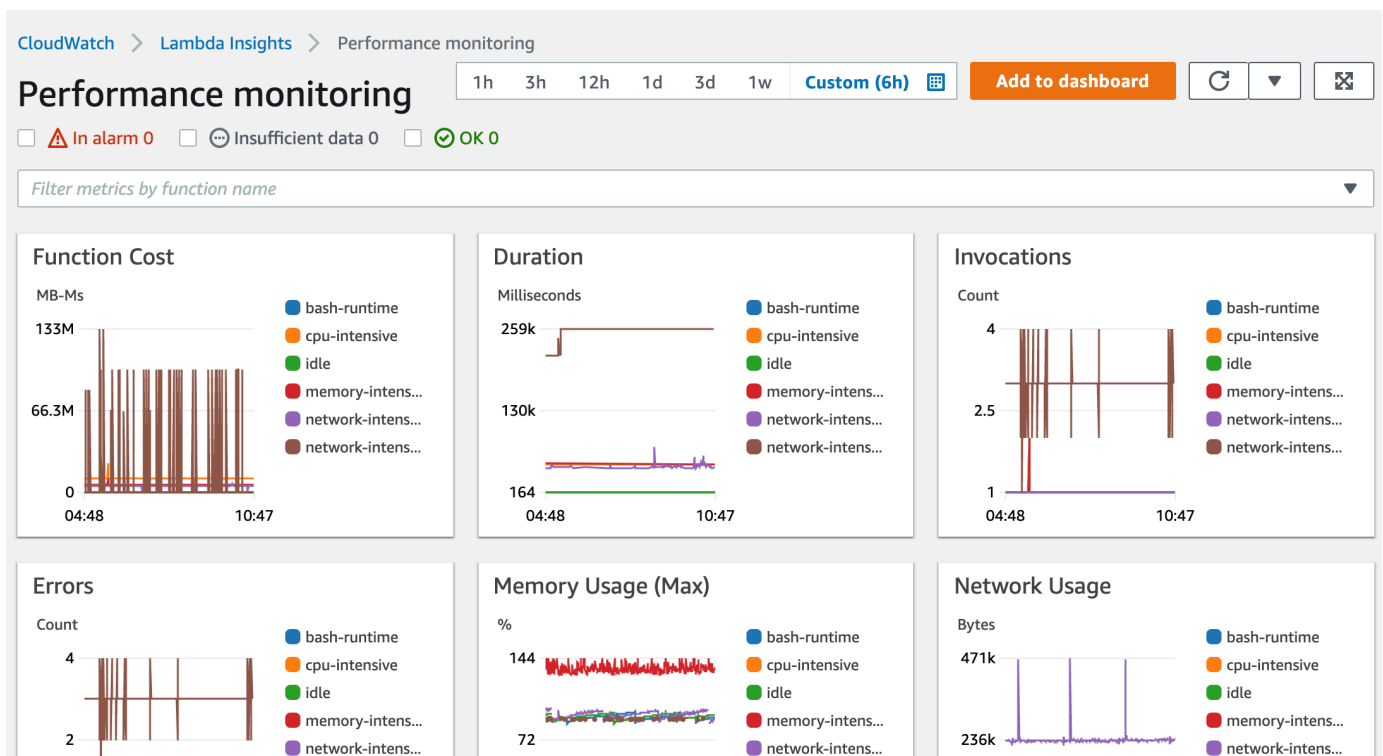

To view the runtime metrics of a single function

1. Open the [Single-function](#) page in the CloudWatch console.
2. Choose from the predefined time ranges, or choose a custom time range.
3. (Optional) Choose **Add to dashboard** to add the widgets to your CloudWatch dashboard.

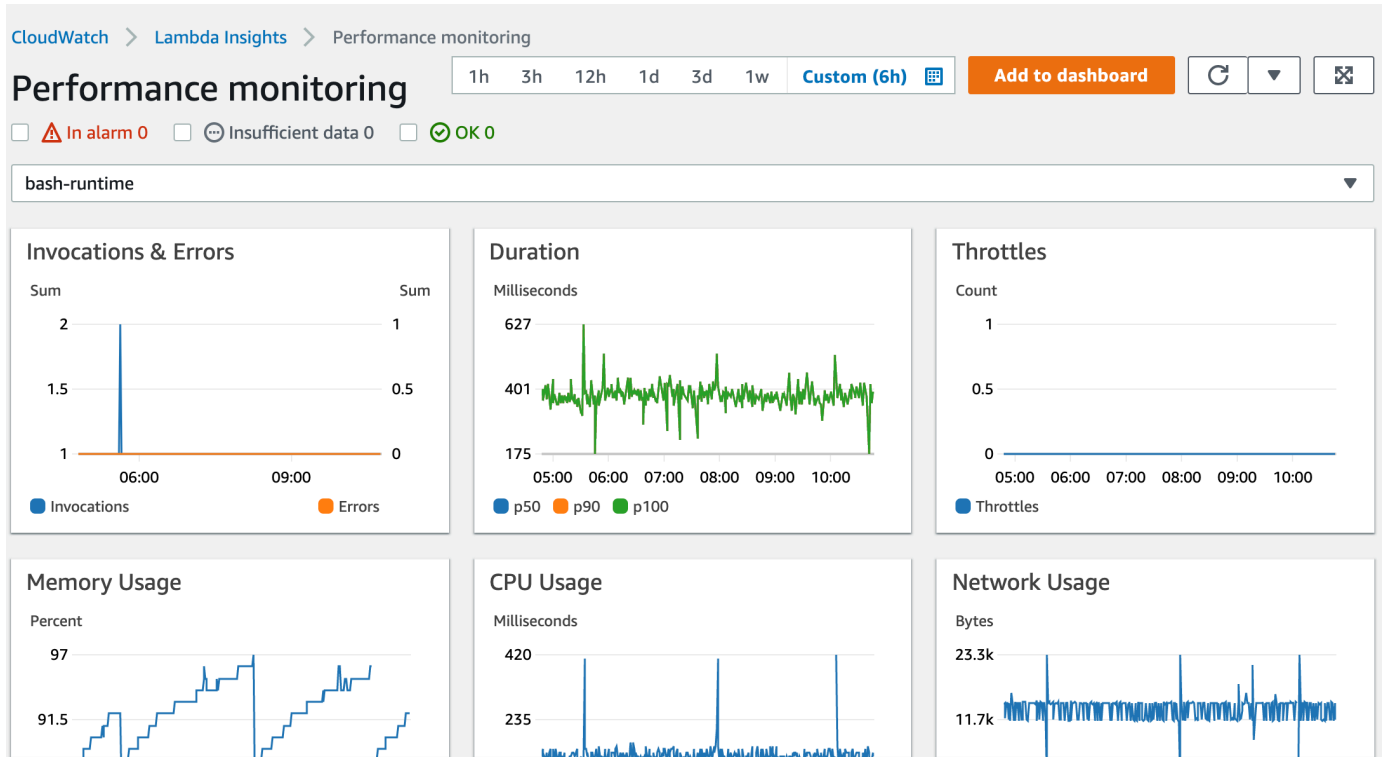

For more information, see [Creating and working with widgets on CloudWatch dashboards](#).



Example workflow to detect function anomalies

You can use the multi-function overview on the Lambda Insights dashboard to identify and detect compute memory anomalies with your function. For example, if the multi-function overview indicates that a function is using a large amount of memory, you can view detailed memory utilization metrics in the **Memory Usage** pane. You can then go to the Metrics dashboard to enable anomaly detection or create an alarm.

To enable anomaly detection for a function

1. Open the [Multi-function](#) page in the CloudWatch console.
2. Under **Function summary**, choose your function's name.

The single-function view opens with the function runtime metrics.

Function summary (6)								Actions 
								< 1 > 
<input type="checkbox"/>	Function name ▲	Invocations ▼	CPU time ▼	Network IO ▼	Max. memory ▼	Cold starts ▼		
<input type="checkbox"/>	bash-runtime	360	132.9167ms	4770 kB	<div style="width: 97%;"><div style="width: 97%;"></div></div> 97%	3		
<input type="checkbox"/>	cpu-intensive	359	6714.2897ms	4780 kB	<div style="width: 43%;"><div style="width: 43%;"></div></div> 43%	4		
<input type="checkbox"/>	idle	359	120.2507ms	4746 kB	<div style="width: 96%;"><div style="width: 96%;"></div></div> 96%	3		
<input type="checkbox"/>	memory-intensive	358	2385.9497ms	4794 kB	<div style="width: 44%;"><div style="width: 44%;"></div></div> 44%	4		
<input type="checkbox"/>	network-intensive	359	781.0585ms	82008 kB	<div style="width: 99%;"><div style="width: 99%;"></div></div> 99%	3		
<input type="checkbox"/>	network-intensive-vpc	43	2730.6977ms	95 kB	<div style="width: 91%;"><div style="width: 91%;"></div></div> 91%	43		

- On the **Memory Usage** pane, choose the three vertical dots, and then choose **View in metrics** to open the **Metrics** dashboard.

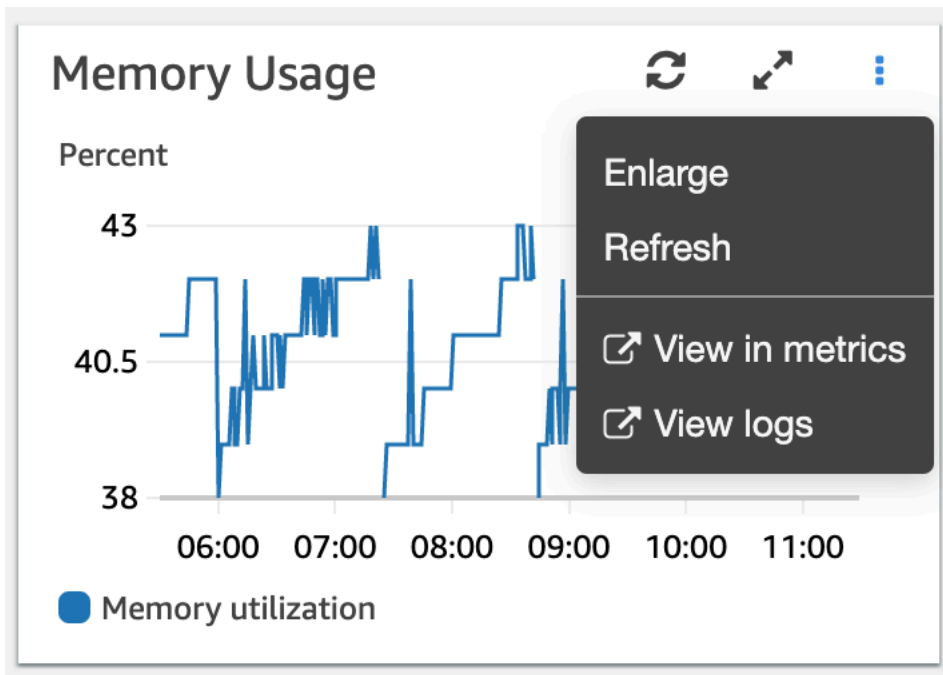

- On the **Graphed metrics** tab, in the **Actions** column, choose the first icon to enable anomaly detection for the function.

All metrics		Graphed metrics (6)		Graph options	Source				
Math expression ?		Dynamic labels ?		Statistic: Maximum ?	Period: 1 Minute ?	Remove all			
<input checked="" type="checkbox"/>	Label	Details	Statistic	Period	Y Axis	Actions			
<input checked="" type="checkbox"/>	bash-runtime	LambdaInsights * memory_utilization * functio...	Maximum	1 Minute	< >				
<input checked="" type="checkbox"/>	cpu-intensive	LambdaInsights * memory_utilization * functio...	Maximum	1 Minute	< >				
<input checked="" type="checkbox"/>	idle	LambdaInsights * memory_utilization * functio...	Maximum	1 Minute	< >				
<input checked="" type="checkbox"/>	memory-intensive	LambdaInsights * memory_utilization * functio...	Maximum	1 Minute	< >				

For more information, see [Using CloudWatch Anomaly Detection](#).

Example workflow using queries to troubleshoot a function

You can use the single-function view on the Lambda Insights dashboard to identify the root cause of a spike in function duration. For example, if the multi-function overview indicates a large increase in function duration, you can pause on or choose each function in the **Duration** pane to determine which function is causing the increase. You can then go to the single-function view and review the **Application logs** to determine the root cause.

To run queries on a function

1. Open the [Multi-function](#) page in the CloudWatch console.
2. In the **Duration** pane, choose your function to filter the duration metrics.

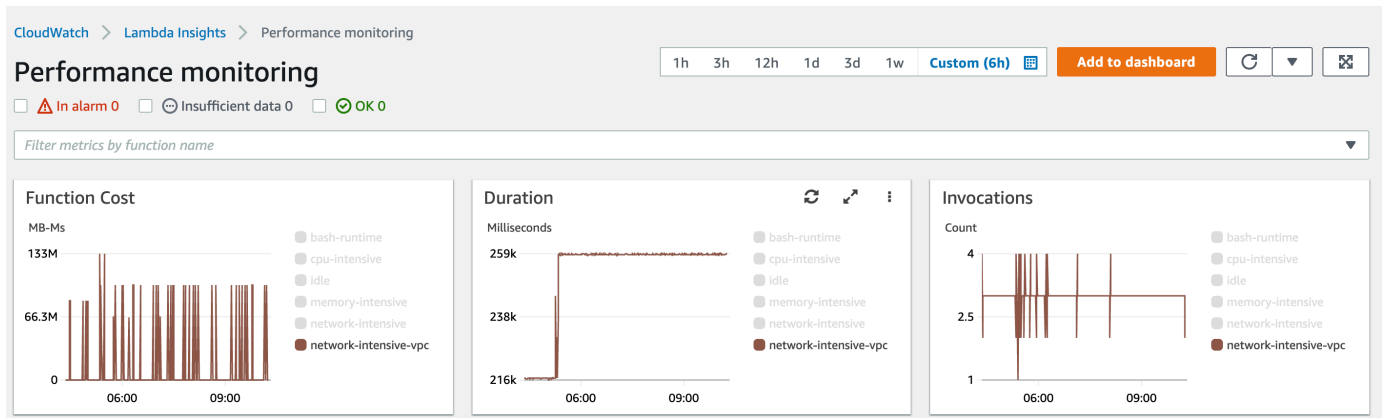

3. Open the [Single-function](#) page.
4. Choose the **Filter metrics by function name** dropdown list, and then choose your function.
5. To view the **Most recent 1000 application logs**, choose the **Application logs** tab.

- Review the **Timestamp** and **Message** to identify the invocation request that you want to troubleshoot.

Timestamp	Message
2020-09-30T16:24:36.121-06	0 0 0 0 0 0 0 --:--:-- 0:03:06 --:--:-- 0
2020-09-30T16:24:34.917-06	0 0 0 0 0 0 0 --:--:-- 0:04:15 --:--:-- 0
2020-09-30T16:24:34.120-06	0 0 0 0 0 0 0 --:--:-- 0:03:04 --:--:-- 0
2020-09-30T16:24:33.033-06	0 0 0 0 0 0 0 --:--:-- 0:01:26 --:--:-- 0

- To show the **Most recent 1000 invocations**, choose the **Invocations** tab.
- Select the **Timestamp** or **Message** for the invocation request that you want to troubleshoot.

	Timestamp	Request ID	Trace	Memory %	Network ID	CPU time	Cold start
<input checked="" type="checkbox"/>	2020-09-30 16:22:34 (UTC-06:00)	247e6369-3a2b-...	-	91%	2 kB	2550ms	Yes
<input type="checkbox"/>	2020-09-30 16:13:39 (UTC-06:00)	311fb438-fa9d-4...	-	90%	2 kB	2340ms	Yes

- Choose the **View logs** dropdown list, and then choose **View performance logs**.

An autogenerated query for your function opens in the **Logs Insights** dashboard.

- Choose **Run query** to generate a **Logs** message for the invocation request.

The screenshot shows the AWS CloudWatch Logs console interface. At the top, there is a search bar with the text "Select log group(s)" and a dropdown arrow. To the right of the search bar, there are two time range selectors: "2020-09-30 (10:35:41)" and "2020-09-30 (16:35:41)". Below the search bar, there is a text input field containing the query: `/aws/lambda-insights` with a close button (X) and a "Clear" button. The query is displayed in a code editor with syntax highlighting. Below the code editor, there are three buttons: "Run query" (orange), "Save", and "History".

Below the query editor, there are two tabs: "Logs" (selected) and "Visualization". To the right of the tabs, there are buttons for "Export results" (with a dropdown arrow) and "Add to dashboard", along with a settings gear icon. The main content area shows a histogram with a single bar at approximately 04:35 PM. Above the histogram, it says "Showing 1 of 1 records matched" and "1,856 records (2.0 MB) scanned in 4.0s @ 467 records/s (521.7 kB/s)". A "Hide histogram" link is visible in the top right corner of the visualization area.

At the bottom, there is a table with the following columns: "#", "@timestamp", and "@message". The table contains one row with the following data:

#	@timestamp	@message
▶ 1	2020-09-30T16:22:34....	{"cpu_system_time":1520,"shutdown":1,"cpu_user_time":1030,"agent_memory_avg":7487349,"used_memory..."

What's next?

- Learn how to create a CloudWatch Logs dashboard in [Create a Dashboard](#) in the *Amazon CloudWatch User Guide*.
- Learn how to add queries to a CloudWatch Logs dashboard in [Add Query to Dashboard or Export Query Results](#) in the *Amazon CloudWatch User Guide*.

Monitoring Lambda applications

The **Applications** section of the Lambda console includes a **Monitoring** tab where you can review an Amazon CloudWatch dashboard with aggregate metrics for the resources in your application.

To monitor a Lambda application

1. Open the Lambda console [Applications page](#).
2. Choose **Monitoring**.
3. To see more details about the metrics in any graph, choose **View in metrics** from the drop-down menu.

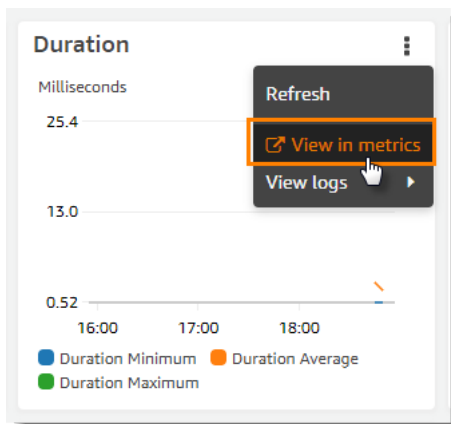

The graph appears in a new tab, with the relevant metrics listed below the graph. You can customize your view of this graph, changing the metrics and resources shown, the statistic, the period, and other factors to get a better understanding of the current situation.

By default, the Lambda console shows a basic dashboard. You can customize this page by adding one or more Amazon CloudWatch dashboards to your application template with the [AWS::CloudWatch::Dashboard](#) resource type. When your template includes one or more dashboards, the page shows your dashboards instead of the default dashboard. You can switch between dashboards with the drop-down menu on the top right of the page. The following example creates a dashboard with a single widget that graphs the number of invocations of a function named `my-function`.

Example function dashboard template

```
Resources:
  MyDashboard:
```

```
Type: AWS::CloudWatch::Dashboard
Properties:
  DashboardName: my-dashboard
  DashboardBody: |
    {
      "widgets": [
        {
          "type": "metric",
          "width": 12,
          "height": 6,
          "properties": {
            "metrics": [
              [
                "AWS/Lambda",
                "Invocations",
                "FunctionName",
                "my-function",
                {
                  "stat": "Sum",
                  "label": "MyFunction"
                }
              ],
              [
                {
                  "expression": "SUM(METRICS())",
                  "label": "Total Invocations"
                }
              ]
            ],
            "region": "us-east-1",
            "title": "Invocations",
            "view": "timeSeries",
            "stacked": false
          }
        }
      ]
    }
  }
```

For more information about authoring CloudWatch dashboards and widgets, see [Dashboard body structure and syntax](#) in the *Amazon CloudWatch API Reference*.

Monitor application performance with Amazon CloudWatch Application Signals

Amazon CloudWatch Application Signals is an application performance monitoring (APM) solution that enables developers and operators to monitor the health and performance of their serverless applications built using Lambda. You can enable Application Signals in one-click from the Lambda console, and you don't need to add any instrumentation code or external dependencies to your Lambda function. After you enable Application Signals, you can view all collected metrics and traces in the CloudWatch console. This page describes how to enable and view Application Signals telemetry data for your applications.

Topics

- [How Application Signals integrates with Lambda](#)
- [Pricing](#)
- [Supported runtimes](#)
- [Enabling Application Signals in the Lambda console](#)
- [Using the Application Signals dashboard](#)

How Application Signals integrates with Lambda

Application Signals automatically instruments your Lambda functions using enhanced [AWS Distro for OpenTelemetry \(ADOT\)](#) libraries, provided via a [Lambda layer](#). Application Signals reads data collected by the layer and generates dashboards with key performance metrics for your applications.

You can attach this layer in one-click by [enabling Application Signals](#) in the Lambda console. When you enable Application Signals from the console, Lambda does the following on your behalf:

- Updates your function's execution role to include the `CloudWatchLambdaApplicationSignalsExecutionRolePolicy`. [This policy](#) provides write access to AWS X-Ray and CloudWatch log groups used for Application Signals.
- Adds a layer to your function which automatically instruments the function to capture telemetry data such as requests, availability, latency, errors, and faults. To ensure that Application Signals works properly, remove any existing X-Ray SDK instrumentation code from your function. Custom X-Ray SDK instrumentation code can interfere with the layer-provided instrumentation.

- Adds the `AWS_LAMBDA-EXEC_WRAPPER` environment variable to your function, and sets its value to `/opt/otel-instrument`. This environment variable modifies your function's startup behavior to utilize the Application Signals layer, and is required for proper instrumentation. If this environment variable already exists, ensure that it's set to the required value.

Pricing

Using Application Signals for your Lambda functions incurs costs. For pricing information, see [Amazon CloudWatch pricing](#).

Supported runtimes

The Application Signals integration with Lambda works with the following runtimes:

- Python 3.10
- Python 3.11
- Python 3.12
- Python 3.13
- Node.js 18.x
- Node.js 20.x
- Node.js 22.x

Enabling Application Signals in the Lambda console

You can enable Application Signals on any existing Lambda function using a [supported runtime](#). The following steps describe how to enable Application Signals in one-click in the Lambda console.

To enable Application Signals in the Lambda console

1. Open the [Functions page](#) of the Lambda console.
2. Choose your function.
3. Choose the **Configuration** tab.
4. On the left menu, choose **Monitoring and operations tools**.
5. On the **Additional monitoring tools** pane, choose **Edit**.

6. Under **CloudWatch Application Signals and AWS X-Ray**, and under **Application Signals**, choose **Enable**.
7. Choose **Save**.

If this is your first time enabling Application Signals for your function, you must also do a one-time service discovery setup for Application Signals in the CloudWatch console. After you complete this one-time service discovery setup, Application Signals automatically discovers any additional Lambda functions that you enable Application Signals for, across all Regions.

 **Note**

After you invoke your updated function, it can take up to 10 minutes for service data to start appearing in the Application Signals dashboard in the CloudWatch console.

Using the Application Signals dashboard

After you enable Application Signals for your function, you can visualize your application metrics in the CloudWatch console. You can quickly view the associated Application Signals dashboard from the Lambda console with the following steps:

To view the Application Signals dashboard for your function

1. Open the [Functions page](#) of the Lambda console.
2. Choose your function.
3. Choose the **Monitor** tab.
4. Choose the **View Application Signals** button. This takes you directly to the Application Signals overview for your service in the CloudWatch console.

For example, the following screenshot shows metrics for latency, number of requests, availability, fault rate, and error rate for a function across a 10 minute time window.

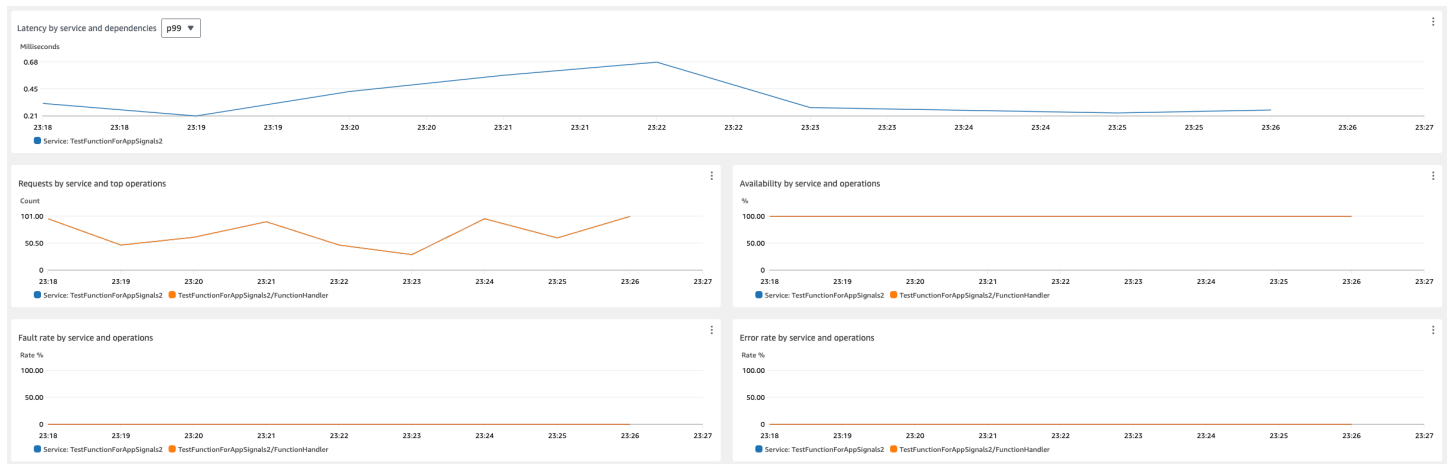

To make the most out of your integration with Application Signals, you can create service-level objectives (SLOs) for your application. For example, you can create latency SLOs to ensure your application responds quickly to user requests, and availability SLOs to track uptime. SLOs can help you detect performance degradation or outages before they impact your users. For more information, see [Service level objectives \(SLOs\)](#) in the Amazon CloudWatch User Guide.

Managing Lambda dependencies with layers

A Lambda layer is a .zip file archive that contains supplementary code or data. Layers usually contain library dependencies, a [custom runtime](#), or configuration files.

There are multiple reasons why you might consider using layers:

- **To reduce the size of your deployment packages.** Instead of including all of your function dependencies along with your function code in your deployment package, put them in a layer. This keeps deployment packages small and organized.
- **To separate core function logic from dependencies.** With layers, you can update your function dependencies independent of your function code, and vice versa. This promotes separation of concerns and helps you focus on your function logic.
- **To share dependencies across multiple functions.** After you create a layer, you can apply it to any number of functions in your account. Without layers, you need to include the same dependencies in each individual deployment package.
- **To use the Lambda console code editor.** The code editor is a useful tool for testing minor function code updates quickly. However, you can't use the editor if your deployment package size is too large. Using layers reduces your package size and can unlock usage of the code editor.

If you're working with Lambda functions in Go or Rust, we recommend against using layers. For Go and Rust functions, you provide your function code as an executable, which includes your compiled function code along with all of its dependencies. Putting your dependencies in a layer forces your function to manually load additional assemblies during the initialization phase, which can increase cold start times. For optimal performance for Go and Rust functions, include your dependencies along with your deployment package.

The following diagram illustrates the high-level architectural differences between two functions that share dependencies. One uses Lambda layers, and the other does not.

Lambda function components: Without layers

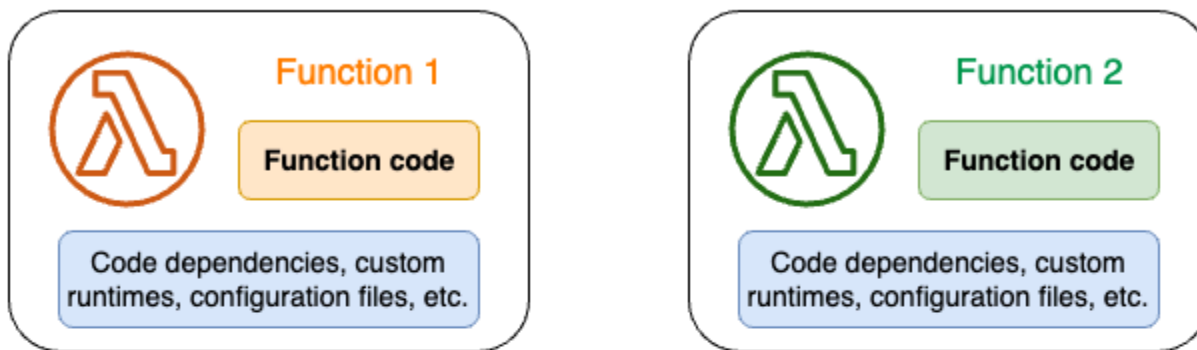

Lambda function components: With layers

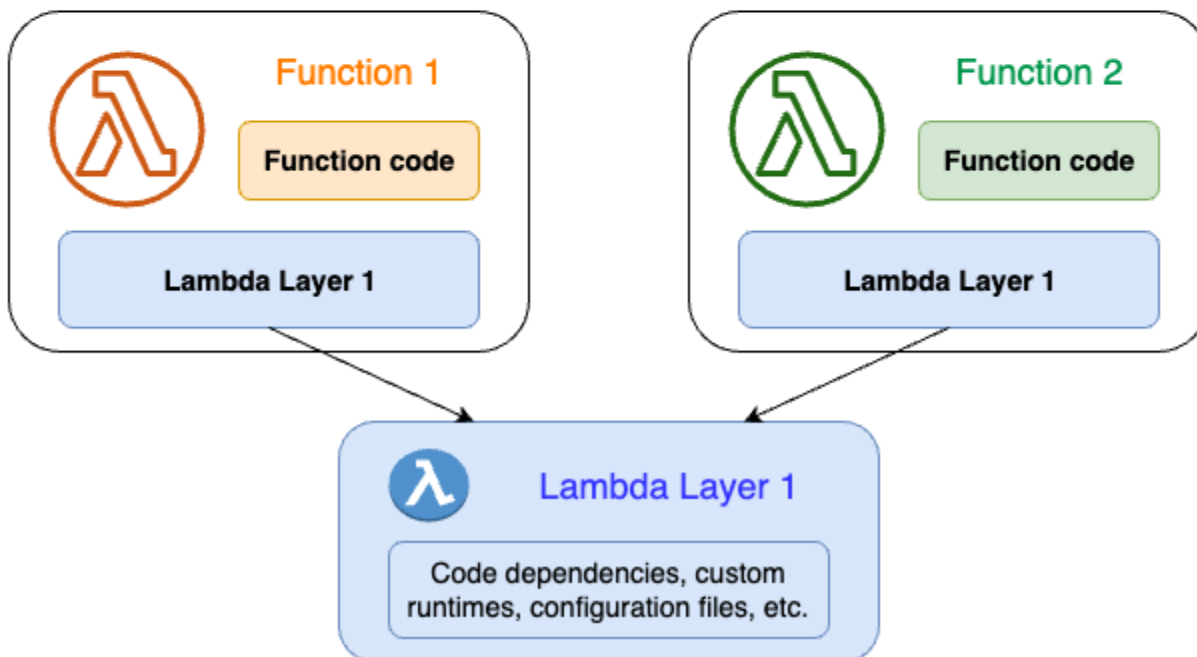

When you add a layer to a function, Lambda extracts the layer contents into the `/opt` directory in your function's [execution environment](#). All natively supported Lambda runtimes include paths to specific directories within the `/opt` directory. This gives your function access to your layer content. For more information about these specific paths and how to properly package your layers, see [the section called "Packaging layers"](#).

You can include up to five layers per function. Also, you can use layers only with Lambda functions [deployed as a .zip file archive](#). For functions [defined as a container image](#), package your preferred

runtime and all code dependencies when you create the container image. For more information, see [Working with Lambda layers and extensions in container images](#) on the AWS Compute Blog.

Topics

- [How to use layers](#)
- [Layers and layer versions](#)
- [Packaging your layer content](#)
- [Creating and deleting layers in Lambda](#)
- [Adding layers to functions](#)
- [Using AWS CloudFormation with layers](#)
- [Using AWS SAM with layers](#)

How to use layers

To create a layer, package your dependencies into a .zip file, similar to how you [create a normal deployment package](#). More specifically, the general process of creating and using layers involves these three steps:

- **First, package your layer content.** This means creating a .zip file archive. For more information, see [the section called “Packaging layers”](#).
- **Next, create the layer in Lambda.** For more information, see [the section called “Creating and deleting layers”](#).
- **Add the layer to your function(s).** For more information, see [the section called “Adding layers”](#).

Layers and layer versions

A layer version is an immutable snapshot of a specific version of a layer. When you create a new layer, Lambda creates a new layer version with a version number of 1. Each time you publish an update to the layer, Lambda increments the version number and creates a new layer version.

Every layer version is identified by a unique Amazon Resource Name (ARN). When adding a layer to the function, you must specify the exact layer version you want to use.

Packaging your layer content

A Lambda layer is a .zip file archive that contains supplementary code or data. Layers usually contain library dependencies, a [custom runtime](#), or configuration files.

This section explains how to properly package your layer content. For more conceptual information about layers and why you might consider using them, see [Lambda layers](#).

The first step to creating a layer is to bundle all of your layer content into a .zip file archive. Because Lambda functions run on [Amazon Linux](#), your layer content must be able to compile and build in a Linux environment.

To ensure that your layer content works properly in a Linux environment, we recommend creating your layer content using a tool like [Docker](#) or [AWS Cloud9](#). AWS Cloud9 is a cloud-based integrated development environment (IDE) that provides built-in access to a Linux server for running and testing code. For more information, see [Using Lambda layers to simplify your development process](#) on the AWS Compute Blog.

Topics

- [Layer paths for each Lambda runtime](#)

Layer paths for each Lambda runtime

When you add a layer to a function, Lambda loads the layer content into the /opt directory of that execution environment. For each Lambda runtime, the PATH variable already includes specific folder paths within the /opt directory. To ensure that Lambda picks up your layer content, your layer .zip file should have its dependencies in the following folder paths:

Runtime	Path
Node.js	nodejs/node_modules
	nodejs/node16/node_modules (NODE_PATH)
	nodejs/node18/node_modules (NODE_PATH)
	nodejs/node20/node_modules (NODE_PATH)
Python	python

Runtime	Path
	python/lib/ <i>python3.x</i> /site-packages (site directories)
Java	java/lib (CLASSPATH)
Ruby	ruby/gems/3.3.0 (GEM_PATH)
	ruby/lib (RUBYLIB)
All runtimes	bin (PATH)
	lib (LD_LIBRARY_PATH)

The following examples show how you can structure the folders in your layer .zip archive.

Node.js

Example file structure for the AWS X-Ray SDK for Node.js

```
xray-sdk.zip
# nodejs/node_modules/aws-xray-sdk
```

Python

Example file structure for the Requests library

```
layer_content.zip
# python
# lib
# python3.11
# site-packages
# requests
# <other_dependencies> (i.e. dependencies of the requests package)
# ...
```

Ruby

Example file structure for the JSON gem

```
json.zip
# ruby/gems/3.3.0/
    | build_info
    | cache
    | doc
    | extensions
    | gems
    | # json-2.1.0
# specifications
  # json-2.1.0.gemspec
```

Java

Example file structure for the Jackson JAR file

```
layer_content.zip
# java
  # lib
    # jackson-core-2.17.0.jar
    # <other potential dependencies>
    # ...
```

All

Example file structure for the jq library

```
jq.zip
# bin/jq
```

For language-specific instructions on packaging, creating, and adding a layer, refer to the following pages:

- **Python** – [the section called “Layers”](#)
- **Java** – [the section called “Layers”](#)

We recommend **against** using layers for the following languages. The linked pages contain more information.

- **Go** – [the section called “Layers”](#)
- **Rust**

Creating and deleting layers in Lambda

A Lambda layer is a .zip file archive that contains supplementary code or data. Layers usually contain library dependencies, a [custom runtime](#), or configuration files.

This section explains how to create and delete layers in Lambda. For more conceptual information about layers and why you might consider using them, see [Lambda layers](#).

After you've [packaged your layer content](#), the next step is to create the layer in Lambda. This section demonstrates how to create and delete layers using the Lambda console or the Lambda API only. To create a layer using AWS CloudFormation, see [the section called "Layers with AWS CloudFormation"](#). To create a layer using the AWS Serverless Application Model (AWS SAM), see [the section called "Layers with AWS SAM"](#).

Topics

- [Creating a layer](#)
- [Deleting a layer version](#)

Creating a layer

To create a layer, you can either upload the .zip file archive from your local machine or from Amazon Simple Storage Service (Amazon S3). Lambda extracts the layer contents into the /opt directory when setting up the execution environment for the function.

Layers can have one or more [layer versions](#). When you create a layer, Lambda sets the layer version to version 1. You can change the permissions on an existing layer version at any time. However, to update the code or make other configuration changes, you must create a new version of the layer.

To create a layer (console)

1. Open the [Layers page](#) of the Lambda console.
2. Choose **Create layer**.
3. Under **Layer configuration**, for **Name**, enter a name for your layer.
4. (Optional) For **Description**, enter a description for your layer.
5. To upload your layer code, do one of the following:
 - To upload a .zip file from your computer, choose **Upload a .zip file**. Then, choose **Upload** to select your local .zip file.

- To upload a file from Amazon S3, choose **Upload a file from Amazon S3**. Then, for **Amazon S3 link URL**, enter a link to the file.
6. (Optional) For **Compatible architectures**, choose one value or both values. For more information, see [the section called "Instruction sets \(ARM/x86\)"](#).
 7. (Optional) For **Compatible runtimes**, choose the runtimes that your layer is compatible with.
 8. (Optional) For **License**, enter any necessary license information.
 9. Choose **Create**.

Alternatively, you can also use the [PublishLayerVersion](#) API to create a layer. For example, you can use the `publish-layer-version` AWS Command Line Interface (CLI) command with a name, description, and .zip file archive specified. The license info, compatible runtimes, and compatible architecture parameters are optional.

```
aws lambda publish-layer-version --layer-name my-layer \  
  --description "My layer" \  
  --license-info "MIT" \  
  --zip-file fileb://layer.zip \  
  --compatible-runtimes python3.10 python3.11 \  
  --compatible-architectures "arm64" "x86_64"
```

You should see output similar to the following:

```
{  
  "Content": {  
    "Location": "https://awslambda-us-east-2-layers.s3.us-east-2.amazonaws.com/  
snapshots/123456789012/my-layer-4aaa2fbb-ff77-4b0a-ad92-5b78a716a96a?  
versionId=27iWyA73cCAYqyH...",  
    "CodeSha256": "tv9jJ0+rPbXUUXuRKi7CwHzKtLDkDRJLB3cC3Z/ouXo=",  
    "CodeSize": 169  
  },  
  "LayerArn": "arn:aws:lambda:us-east-2:123456789012:layer:my-layer",  
  "LayerVersionArn": "arn:aws:lambda:us-east-2:123456789012:layer:my-layer:1",  
  "Description": "My layer",  
  "CreateDate": "2023-11-14T23:03:52.894+0000",  
  "Version": 1,  
  "CompatibleArchitectures": [  
    "arm64",  
    "x86_64"  
  ],  
}
```

```
"LicenseInfo": "MIT",
"CompatibleRuntimes": [
  "python3.10",
  "python3.11"
]
}
```

Each time you call `publish-layer-version`, you create a new version of the layer.

Deleting a layer version

To delete a layer version, use the [DeleteLayerVersion](#) API. For example, you can use the `delete-layer-version` CLI command with the layer name and layer version specified.

```
aws lambda delete-layer-version --layer-name my-layer --version-number 1
```

When you delete a layer version, you can no longer configure a Lambda function to use it. However, any function that already uses the version continues to have access to it. Also, Lambda never reuses version numbers for a layer name.

When calculating [quotas](#), deleting a layer version means it's no longer counted as part of the default 75 GB quota for storage of functions and layers. However, for functions that consume a deleted layer version, the layer content still counts towards the function's deployment package size quota (i.e. 250MB for .zip file archives).

Adding layers to functions

A Lambda layer is a .zip file archive that contains supplementary code or data. Layers usually contain library dependencies, a [custom runtime](#), or configuration files.

This section explains how to add a layer to a Lambda function. For more conceptual information about layers and why you might consider using them, see [Lambda layers](#).

Before you can configure a Lambda function to use a layer, you must:

- [Package your layer content](#)
- [Create a layer in Lambda](#)
- Make sure that you have permission to call the [GetLayerVersion](#) API on the layer version. For functions in your AWS account, you must have this permission in your [user policy](#). To use a layer in another account, the owner of that account must grant your account permission in a [resource-based policy](#). For examples, see [the section called “Layer access for other accounts”](#).

You can add up to five layers to a Lambda function. The total unzipped size of the function and all layers cannot exceed the unzipped deployment package size quota of 250 MB. For more information, see [Lambda quotas](#).

Your functions can continue to use any layer version that you’ve already added, even after that layer version has been deleted, or after your permission to access the layer is revoked. However, you cannot create a new function that uses a deleted layer version.

Note

Make sure that the layers you add to a function are compatible with the runtime and instruction set architecture of the function.

To add a layer to a function (console)

1. Open the [Functions page](#) of the Lambda console.
2. Choose the function to configure.
3. Under **Layers**, choose **Add a layer**
4. Under **Choose a layer**, choose a layer source:

- a. For the **AWS layers** or **Custom layers** layer sources, choose a layer from the pull-down menu. Under **Version**, choose a layer version from the pull-down menu.
- b. For the **Specify an ARN** layer source, enter an ARN in the text box and choose **Verify**. Then, choose **Add**.

The order in which you add the layers is the order in which Lambda merges the layer content into the execution environment. You can change the layer merge order using the console.

To update layer merge order for your function (console)

1. Open the [Functions page](#) of the Lambda console.
2. Choose the function to configure.
3. Under **Layers**, choose **Edit**
4. Choose one of the layers.
5. Choose **Merge earlier** or **Merge later** to adjust the order of the layers.
6. Choose **Save**.

Layers are versioned. The content of each layer version is immutable. The owner of a layer can release new layer versions to provide updated content. You can use the console to update the layer version attached to your functions.

To update layer versions for your function (console)

1. Open the [Layers page](#) of the Lambda console.
2. Choose the layer you want to update the version for.
3. Choose the **Functions using this version** tab.
4. Choose the functions you want to modify, then choose **Edit**.
5. For **Layer version**, choose the layer version to change to.
6. Choose **Update functions**.

You cannot update function layer versions across AWS accounts.

Topics

- [Accessing layer content from your function](#)

- [Finding layer information](#)

Accessing layer content from your function

If your Lambda function includes layers, Lambda extracts the layer contents into the `/opt` directory in the function execution environment. Lambda extracts the layers in the order (low to high) listed by the function. Lambda merges folders with the same name. If the same file appears in multiple layers, the function uses the version in the last extracted layer.

Each Lambda runtime adds specific `/opt` directory folders to the `PATH` variable. Your function code can access the layer content without having to specify the path. For more information about path settings in the Lambda execution environment, see [the section called "Defined runtime environment variables"](#).

Refer to [the section called "Layer paths for each Lambda runtime"](#) to learn where to include your libraries when creating a layer.

If you're using a Node.js or Python runtime, you can use the built-in code editor in the Lambda console. You should be able to import any library that you've added as a layer to the current function.

Finding layer information

To find layers in your account that are compatible with your function's runtime, use the [ListLayers](#) API. For example, you can use the following `list-layers` AWS Command Line Interface (CLI) command:

```
aws lambda list-layers --compatible-runtime python3.9
```

You should see output similar to the following:

```
{
  "Layers": [
    {
      "LayerName": "my-layer",
      "LayerArn": "arn:aws:lambda:us-east-2:123456789012:layer:my-layer",
      "LatestMatchingVersion": {
        "LayerVersionArn": "arn:aws:lambda:us-east-2:123456789012:layer:my-
layer:2",
```



```

        "Version": 2,
        "Description": "My layer",
        "CreateDate": "2023-11-15T00:37:46.592+0000",
        "CompatibleRuntimes": [
            "python3.9",
            "python3.10",
            "python3.11",
        ]
    }
}
]
}

```

To list all layers in your account, omit the `--compatible-runtime` option. The response details show the latest version of each layer.

You can also get the latest version of a layer using the [ListLayerVersions](#) API. For example, you can use the following `list-layer-versions` CLI command:

```
aws lambda list-layer-versions --layer-name my-layer
```

You should see output similar to the following:

```

{
  "LayerVersions": [
    {
      "LayerVersionArn": "arn:aws:lambda:us-east-2:123456789012:layer:my-
layer:2",
      "Version": 2,
      "Description": "My layer",
      "CreateDate": "2023-11-15T00:37:46.592+0000",
      "CompatibleRuntimes": [
        "java11"
      ]
    },
    {
      "LayerVersionArn": "arn:aws:lambda:us-east-2:123456789012:layer:my-
layer:1",
      "Version": 1,
      "Description": "My layer",
      "CreateDate": "2023-11-15T00:27:46.592+0000",
      "CompatibleRuntimes": [

```

```
    "java11"  
  ]  
}  
]
```

Using AWS CloudFormation with layers

You can use AWS CloudFormation to create a layer and associate the layer with your Lambda function. The following example template creates a layer named `my-lambda-layer` and attaches the layer to the Lambda function using the **Layers** property.

In this example, the template specifies the Amazon Resource Name (ARN) of an existing IAM [execution role](#). You can also create a new execution role in the template using the AWS CloudFormation [AWS::IAM::Role](#) resource.

Your function doesn't need any special permissions to use layers.

```
---
Description: CloudFormation Template for Lambda Function with Lambda Layer
Resources:
  MyLambdaLayer:
    Type: AWS::Lambda::LayerVersion
    Properties:
      LayerName: my-lambda-layer
      Description: My Lambda Layer
      Content:
        S3Bucket: amzn-s3-demo-bucket
        S3Key: my-layer.zip
      CompatibleRuntimes:
        - python3.9
        - python3.10
        - python3.11

  MyLambdaFunction:
    Type: AWS::Lambda::Function
    Properties:
      FunctionName: my-lambda-function
      Runtime: python3.9
      Handler: index.handler
      Timeout: 10
      Role: arn:aws:iam::111122223333:role/my_lambda_role
      Layers:
        - !Ref MyLambdaLayer
```

Using AWS SAM with layers

You can use the AWS Serverless Application Model (AWS SAM) to automate the creation of layers in your application. The `AWS::Serverless::LayerVersion` resource type creates a layer version that you can reference from your Lambda function configuration.

```
AWSTemplateFormatVersion: '2010-09-09'  
Transform: 'AWS::Serverless-2016-10-31'  
Description: AWS SAM Template for Lambda Function with Lambda Layer
```

Resources:

MyLambdaLayer:

```
Type: AWS::Serverless::LayerVersion
```

Properties:

```
LayerName: my-lambda-layer
```

```
Description: My Lambda Layer
```

```
ContentUri: s3://amzn-s3-demo-bucket/my-layer.zip
```

CompatibleRuntimes:

- python3.9
- python3.10
- python3.11

MyLambdaFunction:

```
Type: AWS::Serverless::Function
```

Properties:

```
FunctionName: MyLambdaFunction
```

```
Runtime: python3.9
```

```
Handler: app.handler
```

```
CodeUri: s3://amzn-s3-demo-bucket/my-function
```

Layers:

- !Ref MyLambdaLayer

Augment Lambda functions using Lambda extensions

You can use Lambda extensions to augment your Lambda functions. For example, use Lambda extensions to integrate functions with your preferred monitoring, observability, security, and governance tools. You can choose from a broad set of tools that [AWS Lambda Partners](#) provides, or you can [create your own Lambda extensions](#).

Lambda supports external and internal extensions. An external extension runs as an independent process in the execution environment and continues to run after the function invocation is fully processed. Because extensions run as separate processes, you can write them in a different language than the function. All [Lambda runtimes](#) support extensions.

An internal extension runs as part of the runtime process. Your function accesses internal extensions by using wrapper scripts or in-process mechanisms such as `JAVA_TOOL_OPTIONS`. For more information, see [Modifying the runtime environment](#).

You can add extensions to a function using the Lambda console, the AWS Command Line Interface (AWS CLI), or infrastructure as code (IaC) services and tools such as AWS CloudFormation, AWS Serverless Application Model (AWS SAM), and Terraform.

You are charged for the execution time that the extension consumes (in 1 ms increments). There is no cost to install your own extensions. For more pricing information for extensions, see [AWS Lambda Pricing](#). For pricing information for partner extensions, see those partners' websites. See [the section called "Extensions partners"](#) for a list of official partner extensions.

For a tutorial on extensions and how to use them with your Lambda functions, see the [AWS Lambda Extensions Workshop](#).

Topics

- [Execution environment](#)
- [Impact on performance and resources](#)
- [Permissions](#)
- [Configuring Lambda extensions](#)
- [AWS Lambda extensions partners](#)
- [Using the Lambda Extensions API to create extensions](#)
- [Accessing real-time telemetry data for extensions using the Telemetry API](#)

Execution environment

Lambda invokes your function in an [execution environment](#), which provides a secure and isolated runtime environment. The execution environment manages the resources required to run your function and provides lifecycle support for the function's runtime and extensions.

The lifecycle of the execution environment includes the following phases:

- **Init:** In this phase, Lambda creates or unfreezes an execution environment with the configured resources, downloads the code for the function and all layers, initializes any extensions, initializes the runtime, and then runs the function's initialization code (the code outside the main handler). The `Init` phase happens either during the first invocation, or in advance of function invocations if you have enabled [provisioned concurrency](#).

The `Init` phase is split into three sub-phases: `Extension init`, `Runtime init`, and `Function init`. These sub-phases ensure that all extensions and the runtime complete their setup tasks before the function code runs.

When [Lambda SnapStart](#) is activated, the `Init` phase happens when you publish a function version. Lambda saves a snapshot of the memory and disk state of the initialized execution environment, persists the encrypted snapshot, and caches it for low-latency access. If you have a before-checkpoint [runtime hook](#), then the code runs at the end of `Init` phase.

- **Restore** (SnapStart only): When you first invoke a [SnapStart](#) function and as the function scales up, Lambda resumes new execution environments from the persisted snapshot instead of initializing the function from scratch. If you have an `afterRestore()` [runtime hook](#), the code runs at the end of the `Restore` phase. You are charged for the duration of `afterRestore()` runtime hooks. The runtime (JVM) must load and `afterRestore()` runtime hooks must complete within the timeout limit (10 seconds). Otherwise, you'll get a `SnapStartTimeoutException`. When the `Restore` phase completes, Lambda invokes the function handler (the [Invoke phase](#)).
- **Invoke:** In this phase, Lambda invokes the function handler. After the function runs to completion, Lambda prepares to handle another function invocation.
- **Shutdown:** This phase is triggered if the Lambda function does not receive any invocations for a period of time. In the `Shutdown` phase, Lambda shuts down the runtime, alerts the extensions to let them stop cleanly, and then removes the environment. Lambda sends a `Shutdown` event to each extension, which tells the extension that the environment is about to be shut down.

During the `Init` phase, Lambda extracts layers containing extensions into the `/opt` directory in the execution environment. Lambda looks for extensions in the `/opt/extensions/` directory, interprets each file as an executable bootstrap for launching the extension, and starts all extensions in parallel.

Impact on performance and resources

The size of your function's extensions counts towards the deployment package size limit. For a .zip file archive, the total unzipped size of the function and all extensions cannot exceed the unzipped deployment package size limit of 250 MB.

Extensions can impact the performance of your function because they share function resources such as CPU, memory, and storage. For example, if an extension performs compute-intensive operations, you may see your function's execution duration increase.

Each extension must complete its initialization before Lambda invokes the function. Therefore, an extension that consumes significant initialization time can increase the latency of the function invocation.

To measure the extra time that the extension takes after the function execution, you can use the `PostRuntimeExtensionsDuration` [function metric](#). To measure the increase in memory used, you can use the `MaxMemoryUsed` metric. To understand the impact of a specific extension, you can run different versions of your functions side by side.

Permissions

Extensions have access to the same resources as functions. Because extensions are executed within the same environment as the function, permissions are shared between the function and the extension.

For a .zip file archive, you can create an AWS CloudFormation template to simplify the task of attaching the same extension configuration—including AWS Identity and Access Management (IAM) permissions—to multiple functions.

Configuring Lambda extensions

Configuring extensions (.zip file archive)

You can add an extension to your function as a [Lambda layer](#). Using layers enables you to share extensions across your organization or to the entire community of Lambda developers. You can add one or more extensions to a layer. You can register up to 10 extensions for a function.

You add the extension to your function using the same method as you would for any layer. For more information, see [Lambda layers](#).

Add an extension to your function (console)

1. Open the [Functions page](#) of the Lambda console.
2. Choose a function.
3. Choose the **Code** tab if it is not already selected.
4. Under **Layers**, choose **Edit**.
5. For **Choose a layer**, choose **Specify an ARN**.
6. For **Specify an ARN**, enter the Amazon Resource Name (ARN) of an extension layer.
7. Choose **Add**.

Using extensions in container images

You can add extensions to your [container image](#). The ENTRYPOINT container image setting specifies the main process for the function. Configure the ENTRYPOINT setting in the Dockerfile, or as an override in the function configuration.

You can run multiple processes within a container. Lambda manages the lifecycle of the main process and any additional processes. Lambda uses the [Extensions API](#) to manage the extension lifecycle.

Example: Adding an external extension

An external extension runs in a separate process from the Lambda function. Lambda starts a process for each extension in the `/opt/extensions/` directory. Lambda uses the Extensions API to manage the extension lifecycle. After the function has run to completion, Lambda sends a Shutdown event to each external extension.

Example of adding an external extension to a Python base image

```
FROM public.ecr.aws/lambda/python:3.11

# Copy and install the app
COPY /app /app
WORKDIR /app
RUN pip install -r requirements.txt

# Add an extension from the local directory into /opt/extensions
ADD my-extension.zip /opt/extensions
CMD python ./my-function.py
```

Next steps

To learn more about extensions, we recommend the following resources:

- For a basic working example, see [Building Extensions for AWS Lambda](#) on the AWS Compute Blog.
- For information about extensions that AWS Lambda Partners provides, see [Introducing AWS Lambda Extensions](#) on the AWS Compute Blog.
- To view available example extensions and wrapper scripts, see [AWS Lambda Extensions](#) on the AWS Samples GitHub repository.

AWS Lambda extensions partners

AWS Lambda has partnered with several third party entities to provide extensions to integrate with your Lambda functions. The following list details third party extensions that are ready for you to use at any time.

- [AppDynamics](#) – Provides automatic instrumentation of Node.js or Python Lambda functions, providing visibility and alerting on function performance.
- [Axiom](#) – Provides dashboards for monitoring Lambda function performance and aggregate system-level metrics.
- [Check Point CloudGuard](#) – An extension-based runtime solution that offers full lifecycle security for serverless applications.
- [Datadog](#) – Provides comprehensive, real-time visibility to your serverless applications through the use of metrics, traces, and logs.
- [Dynatrace](#) – Provides visibility into traces and metrics, and leverages AI for automated error detection and root cause analysis across the entire application stack.
- [Elastic](#) – Provides Application Performance Monitoring (APM) to identify and resolve root cause issues using correlated traces, metrics, and logs.
- [Epsagon](#) – Listens to invocation events, stores traces, and sends them in parallel to Lambda function executions.
- [Fastly](#)– Protects your Lambda functions from suspicious activity, such as injection-style attacks, account takeover via credential stuffing, malicious bots, and API abuse.
- [HashiCorp Vault](#) – Manages secrets and makes them available for developers to use within function code, without making functions Vault aware.
- [Honeycomb](#) – Observability tool for debugging your app stack.
- [Lumigo](#) – Profiles Lambda function invocations and collects metrics for troubleshooting issues in serverless and microservice environments.
- [New Relic](#) – Runs alongside Lambda functions, automatically collecting, enhancing, and transporting telemetry to New Relic's unified observability platform.
- [Sedai](#) – An autonomous cloud management platform, powered by AI/ML, that delivers continuous optimization for cloud operations teams to maximize cloud cost savings, performance, and availability at scale.
- [Sentry](#) – Diagnose, fix, and optimize performance of Lambda functions.
- [Site24x7](#) – Achieve real-time observability into your Lambda environments

- [Splunk](#) – Collects high-resolution, low-latency metrics for efficient and effective monitoring of Lambda functions.
- [Sumo Logic](#) – Provides visibility into the health and performance of serverless applications.
- [Thundra](#) – Provides asynchronous telemetry reporting, such as traces, metrics, and logs.
- [Salt Security](#) – Simplifies API posture governance and API security for Lambda functions through automated setup and support for diverse runtimes.

AWS managed extensions

AWS provides its own managed extensions, including:

- [AWS AppConfig](#) – Use feature flags and dynamic data to update your Lambda functions. You can also use this extension to update other dynamic configuration, such as ops throttling and tuning.
- [Amazon CodeGuru Profiler](#) – Improves application performance and reduces cost by pinpointing an application's most expensive line of code and providing recommendations for improving code.
- [CloudWatch Lambda Insights](#) – Monitor, troubleshoot, and optimize the performance of your Lambda functions through automated dashboards.
- [AWS Distro for OpenTelemetry \(ADOT\)](#) – Enables functions to send trace data to AWS monitoring services such as AWS X-Ray, and to destinations that support OpenTelemetry such as Honeycomb and Lightstep.
- **AWS Parameters and Secrets** – Enables customers to securely retrieve parameters from [AWS Systems Manager Parameter Store](#) and secrets from [AWS Secrets Manager](#).

For additional extensions samples and demo projects, see [AWS Lambda Extensions](#).

Using the Lambda Extensions API to create extensions

Lambda function authors use extensions to integrate Lambda with their preferred tools for monitoring, observability, security, and governance. Function authors can use extensions from AWS, [AWS Partners](#), and open-source projects. For more information on using extensions, see [Introducing AWS Lambda Extensions](#) on the AWS Compute Blog. This section describes how to use the Lambda Extensions API, the Lambda execution environment lifecycle, and the Lambda Extensions API reference.

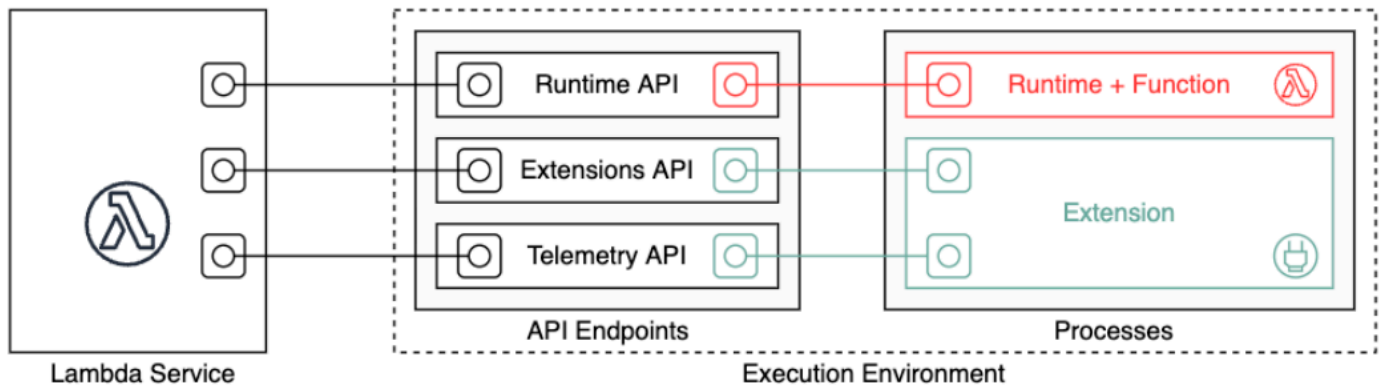

As an extension author, you can use the Lambda Extensions API to integrate deeply into the Lambda [execution environment](#). Your extension can register for function and execution environment lifecycle events. In response to these events, you can start new processes, run logic, and control and participate in all phases of the Lambda lifecycle: initialization, invocation, and shutdown. In addition, you can use the [Runtime Logs API](#) to receive a stream of logs.

An extension runs as an independent process in the execution environment and can continue to run after the function invocation is fully processed. Because extensions run as processes, you can write them in a different language than the function. We recommend that you implement extensions using a compiled language. In this case, the extension is a self-contained binary that is compatible with supported runtimes. All [Lambda runtimes](#) support extensions. If you use a non-compiled language, ensure that you include a compatible runtime in the extension.

Lambda also supports *internal extensions*. An internal extension runs as a separate thread in the runtime process. The runtime starts and stops the internal extension. An alternative way to integrate with the Lambda environment is to use language-specific [environment variables and wrapper scripts](#). You can use these to configure the runtime environment and modify the startup behavior of the runtime process.

You can add extensions to a function in two ways. For a function deployed as a [.zip file archive](#), you deploy your extension as a [layer](#). For a function defined as a container image, you add [the extensions](#) to your container image.

Note

For example extensions and wrapper scripts, see [AWS Lambda Extensions](#) on the AWS Samples GitHub repository.

Topics

- [Lambda execution environment lifecycle](#)
- [Extensions API reference](#)

Lambda execution environment lifecycle

The lifecycle of the execution environment includes the following phases:

- **Init:** In this phase, Lambda creates or unfreezes an execution environment with the configured resources, downloads the code for the function and all layers, initializes any extensions, initializes the runtime, and then runs the function's initialization code (the code outside the main handler). The Init phase happens either during the first invocation, or in advance of function invocations if you have enabled [provisioned concurrency](#).

The Init phase is split into three sub-phases: `Extension init`, `Runtime init`, and `Function init`. These sub-phases ensure that all extensions and the runtime complete their setup tasks before the function code runs.

- **Invoke:** In this phase, Lambda invokes the function handler. After the function runs to completion, Lambda prepares to handle another function invocation.
- **Shutdown:** This phase is triggered if the Lambda function does not receive any invocations for a period of time. In the Shutdown phase, Lambda shuts down the runtime, alerts the extensions to let them stop cleanly, and then removes the environment. Lambda sends a Shutdown event to each extension, which tells the extension that the environment is about to be shut down.

Each phase starts with an event from Lambda to the runtime and to all registered extensions. The runtime and each extension signal completion by sending a Next API request. Lambda freezes the execution environment when each process has completed and there are no pending events.

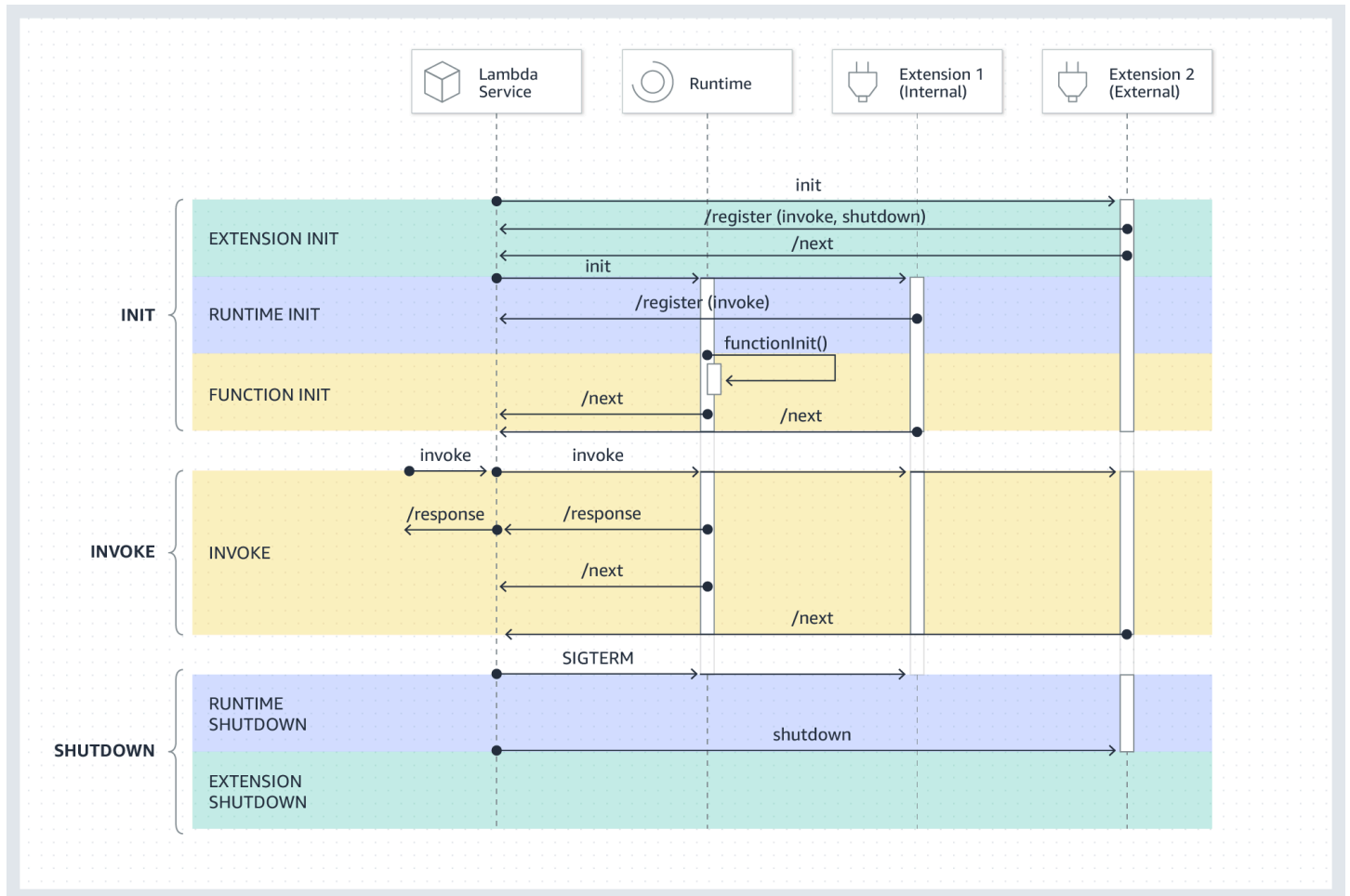

Topics

- [Init phase](#)
- [Invoke phase](#)
- [Shutdown phase](#)
- [Permissions and configuration](#)
- [Failure handling](#)
- [Troubleshooting extensions](#)

Init phase

During the `Extension init` phase, each extension needs to register with Lambda to receive events. Lambda uses the full file name of the extension to validate that the extension has completed the bootstrap sequence. Therefore, each `Register` API call must include the `Lambda-Extension-Name` header with the full file name of the extension.

You can register up to 10 extensions for a function. This limit is enforced through the `Register` API call.

After each extension registers, Lambda starts the `Runtime init` phase. The runtime process calls `functionInit` to start the `Function init` phase.

The `Init` phase completes after the runtime and each registered extension indicate completion by sending a `Next` API request.

Note

Extensions can complete their initialization at any point in the `Init` phase.

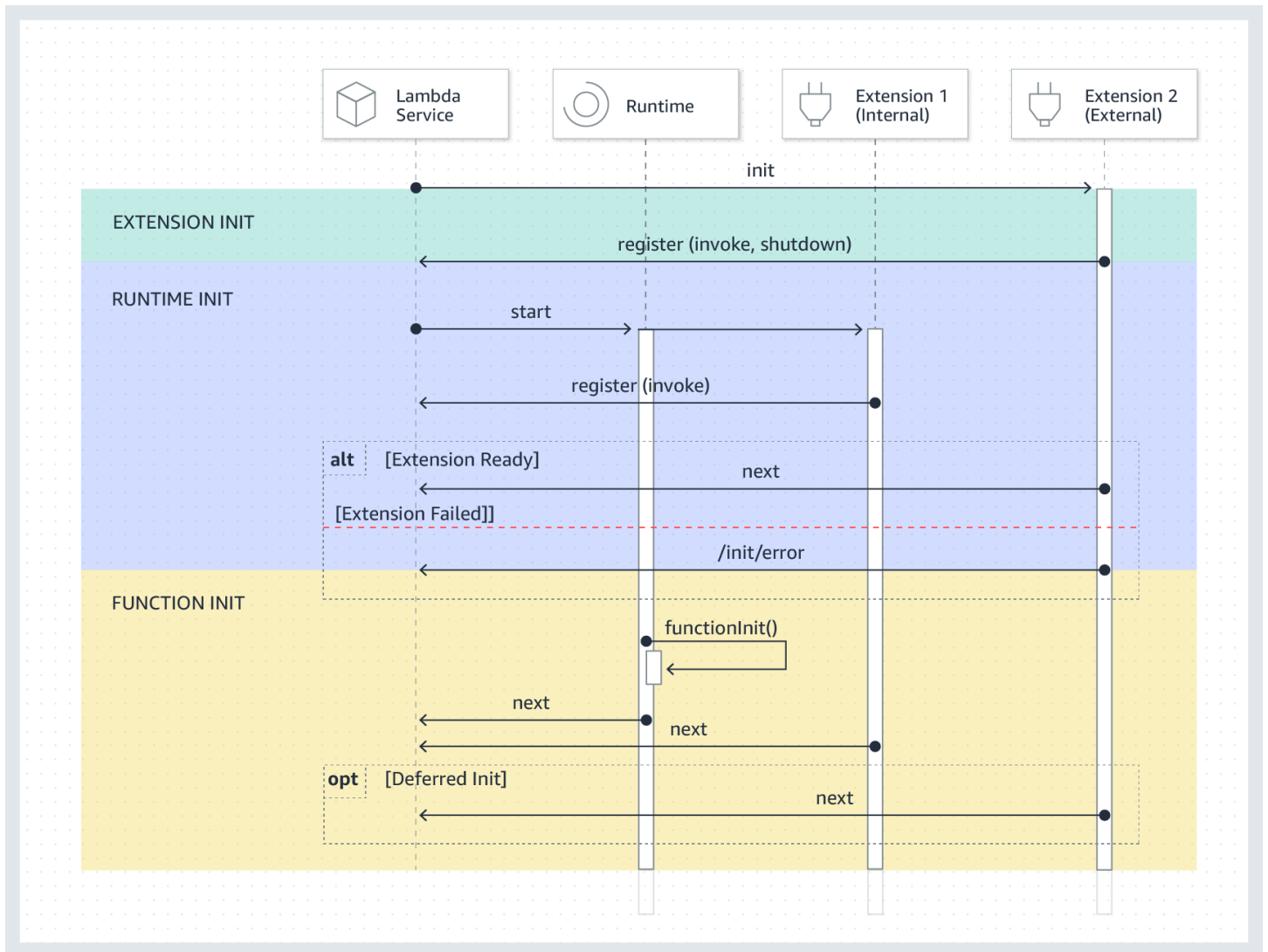

Invoke phase

When a Lambda function is invoked in response to a Next API request, Lambda sends an Invoke event to the runtime and to each extension that is registered for the Invoke event.

During the invocation, external extensions run in parallel with the function. They also continue running after the function has completed. This enables you to capture diagnostic information or to send logs, metrics, and traces to a location of your choice.

After receiving the function response from the runtime, Lambda returns the response to the client, even if extensions are still running.

The Invoke phase ends after the runtime and all extensions signal that they are done by sending a Next API request.

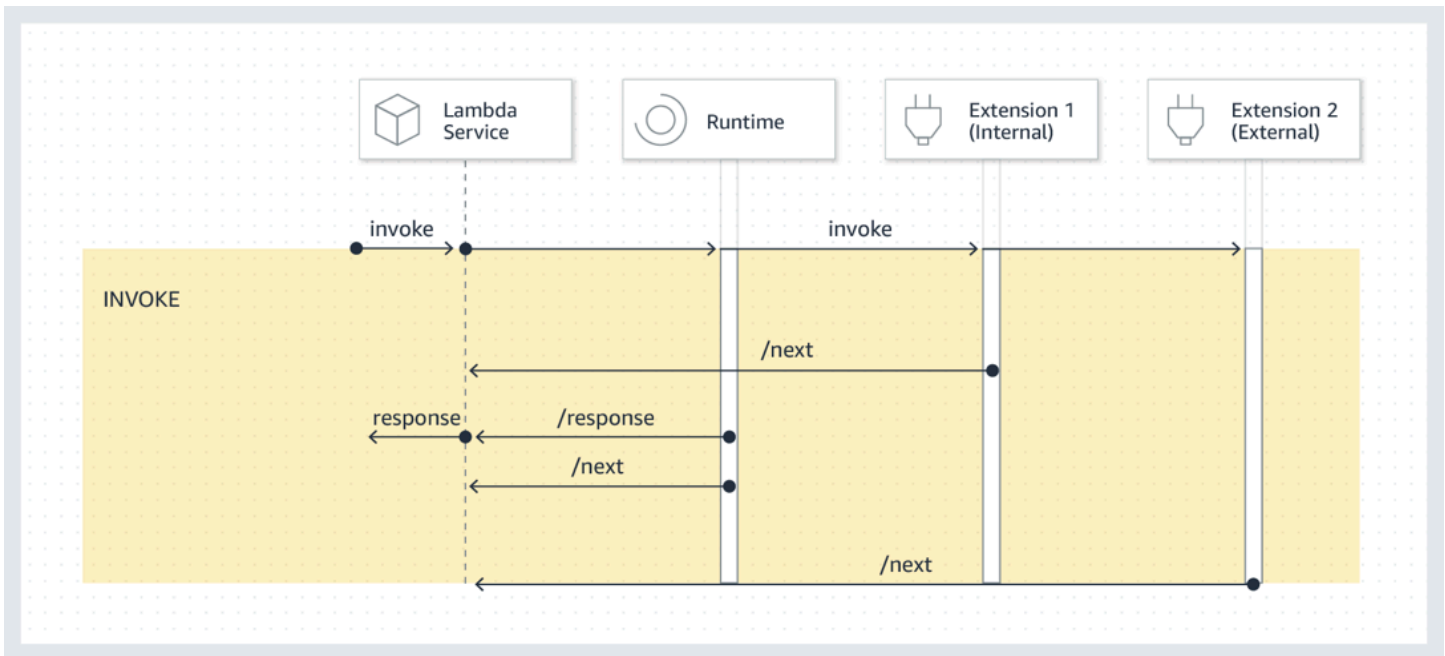

Event payload: The event sent to the runtime (and the Lambda function) carries the entire request, headers (such as RequestId), and payload. The event sent to each extension contains metadata that describes the event content. This lifecycle event includes the type of the event, the time that the function times out (`deadlineMs`), the `requestId`, the invoked function's Amazon Resource Name (ARN), and tracing headers.

Extensions that want to access the function event body can use an in-runtime SDK that communicates with the extension. Function developers use the in-runtime SDK to send the payload to the extension when the function is invoked.

Here is an example payload:

```
{
  "eventType": "INVOKE",
  "deadlineMs": 676051,
  "requestId": "3da1f2dc-3222-475e-9205-e2e6c6318895",
  "invokedFunctionArn": "arn:aws:lambda:us-east-1:123456789012:function:ExtensionTest",
  "tracing": {
    "type": "X-Amzn-Trace-Id",
    "value":
      "Root=1-5f35ae12-0c0fec141ab77a00bc047aa2;Parent=2be948a625588e32;Sampled=1"
  }
}
```

Duration limit: The function's timeout setting limits the duration of the entire Invoke phase. For example, if you set the function timeout as 360 seconds, the function and all extensions need to complete within 360 seconds. Note that there is no independent post-invoke phase. The duration is the total time it takes for your runtime and all your extensions' invocations to complete and is not calculated until the function and all extensions have finished running.

Performance impact and extension overhead: Extensions can impact function performance. As an extension author, you have control over the performance impact of your extension. For example, if your extension performs compute-intensive operations, the function's duration increases because the extension and the function code share the same CPU resources. In addition, if your extension performs extensive operations after the function invocation completes, the function duration increases because the Invoke phase continues until all extensions signal that they are completed.

Note

Lambda allocates CPU power in proportion to the function's memory setting. You might see increased execution and initialization duration at lower memory settings because the function and extension processes are competing for the same CPU resources. To reduce the execution and initialization duration, try increasing the memory setting.

To help identify the performance impact introduced by extensions on the Invoke phase, Lambda outputs the `PostRuntimeExtensionsDuration` metric. This metric measures the cumulative time spent between the runtime Next API request and the last extension Next API request. To measure the increase in memory used, use the `MaxMemoryUsed` metric. For more information about function metrics, see [Using CloudWatch metrics with Lambda](#).

Function developers can run different versions of their functions side by side to understand the impact of a specific extension. We recommend that extension authors publish expected resource consumption to make it easier for function developers to choose a suitable extension.

Shutdown phase

When Lambda is about to shut down the runtime, it sends a Shutdown to each registered external extension. Extensions can use this time for final cleanup tasks. The Shutdown event is sent in response to a Next API request.

Duration limit: The maximum duration of the Shutdown phase depends on the configuration of registered extensions:

- 0 ms – A function with no registered extensions
- 500 ms – A function with a registered internal extension
- 2,000 ms – A function with one or more registered external extensions

For a function with external extensions, Lambda reserves up to 300 ms (500 ms for a runtime with an internal extension) for the runtime process to perform a graceful shutdown. Lambda allocates the remainder of the 2,000 ms limit for external extensions to shut down.

If the runtime or an extension does not respond to the Shutdown event within the limit, Lambda ends the process using a SIGKILL signal.

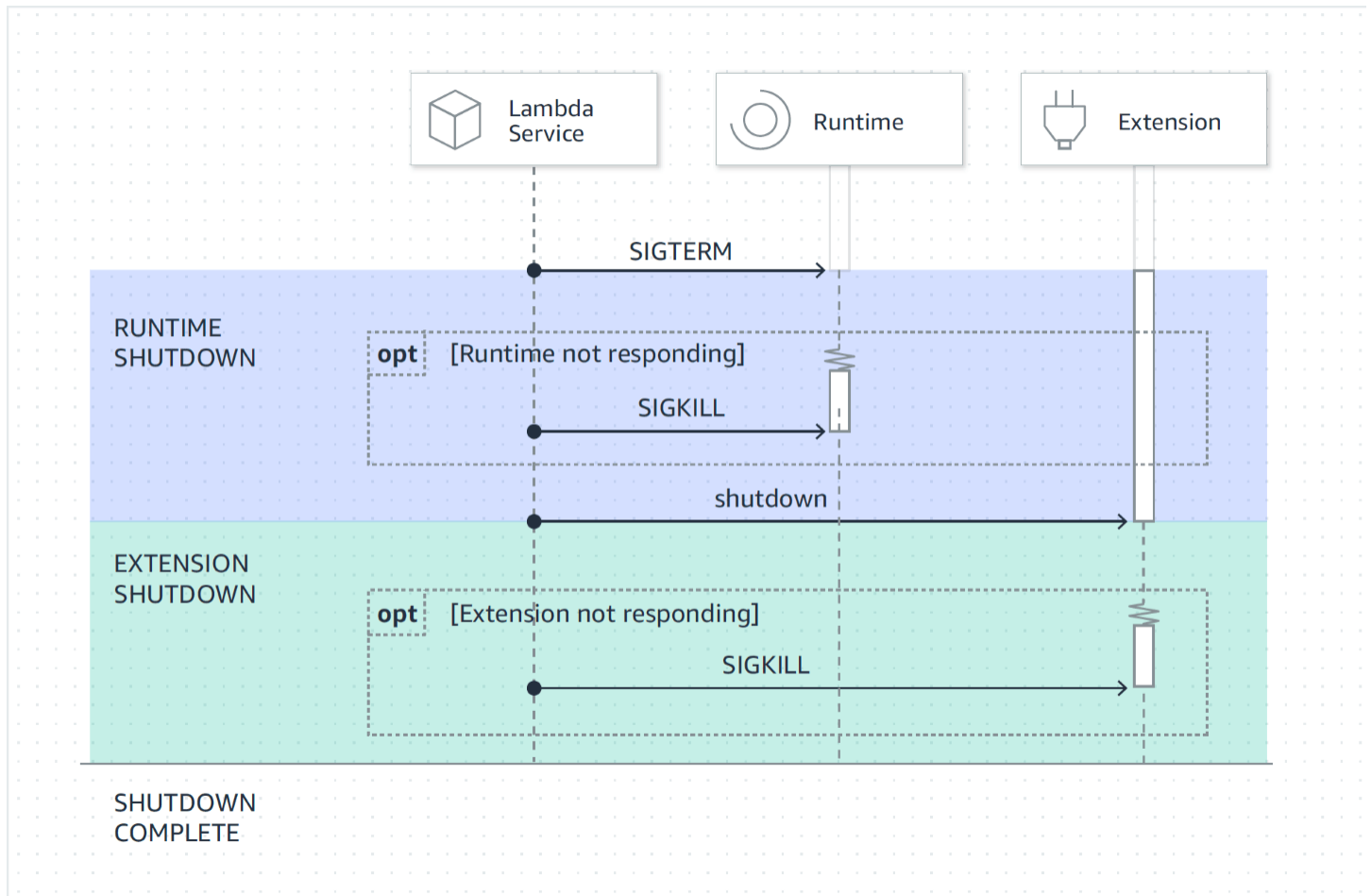

Event payload: The Shutdown event contains the reason for the shutdown and the time remaining in milliseconds.

The `shutdownReason` includes the following values:

- `SPINDOWN` – Normal shutdown

- **TIMEOUT** – Duration limit timed out
- **FAILURE** – Error condition, such as an out-of-memory event

```
{
  "eventType": "SHUTDOWN",
  "shutdownReason": "reason for shutdown",
  "deadlineMs": "the time and date that the function times out in Unix time
milliseconds"
}
```

Permissions and configuration

Extensions run in the same execution environment as the Lambda function. Extensions also share resources with the function, such as CPU, memory, and /tmp disk storage. In addition, extensions use the same AWS Identity and Access Management (IAM) role and security context as the function.

File system and network access permissions: Extensions run in the same file system and network name namespace as the function runtime. This means that extensions need to be compatible with the associated operating system. If an extension requires any additional outbound network traffic rules, you must apply these rules to the function configuration.

Note

Because the function code directory is read-only, extensions cannot modify the function code.

Environment variables: Extensions can access the function's [environment variables](#), except for the following variables that are specific to the runtime process:

- `AWS_EXECUTION_ENV`
- `AWS_LAMBDA_LOG_GROUP_NAME`
- `AWS_LAMBDA_LOG_STREAM_NAME`
- `AWS_XRAY_CONTEXT_MISSING`
- `AWS_XRAY_DAEMON_ADDRESS`

- LAMBDA_RUNTIME_DIR
- LAMBDA_TASK_ROOT
- _AWS_XRAY_DAEMON_ADDRESS
- _AWS_XRAY_DAEMON_PORT
- _HANDLER

Failure handling

Initialization failures: If an extension fails, Lambda restarts the execution environment to enforce consistent behavior and to encourage fail fast for extensions. Also, for some customers, the extensions must meet mission-critical needs such as logging, security, governance, and telemetry collection.

Invoke failures (such as out of memory, function timeout): Because extensions share resources with the runtime, memory exhaustion affects them. When the runtime fails, all extensions and the runtime itself participate in the Shutdown phase. In addition, the runtime is restarted—either automatically as part of the current invocation, or via a deferred re-initialization mechanism.

If there is a failure (such as a function timeout or runtime error) during Invoke, the Lambda service performs a reset. The reset behaves like a Shutdown event. First, Lambda shuts down the runtime, then it sends a Shutdown event to each registered external extension. The event includes the reason for the shutdown. If this environment is used for a new invocation, the extension and runtime are re-initialized as part of the next invocation.

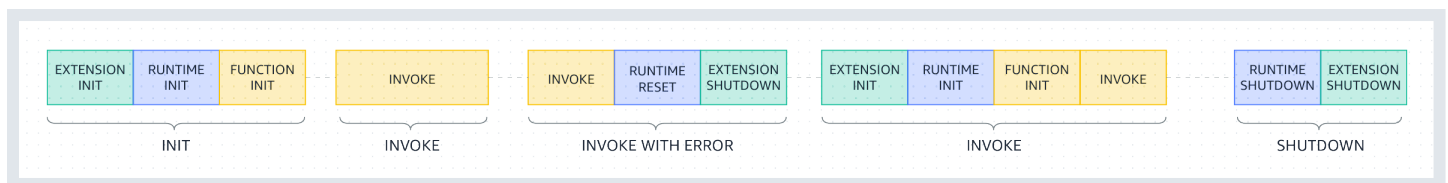

For a more detailed explanation of the previous diagram, see [Failures during the invoke phase](#).

Extension logs: Lambda sends the log output of extensions to CloudWatch Logs. Lambda also generates an additional log event for each extension during Init. The log event records the name and registration preference (event, config) on success, or the failure reason on failure.

Troubleshooting extensions

- If a Register request fails, make sure that the Lambda-Extension-Name header in the Register API call contains the full file name of the extension.

- If the `Register` request fails for an internal extension, make sure that the request does not register for the `Shutdown` event.

Extensions API reference

The OpenAPI specification for the extensions API version **2020-01-01** is available here: [extensions-api.zip](#)

You can retrieve the value of the API endpoint from the `AWS_LAMBDA_RUNTIME_API` environment variable. To send a `Register` request, use the prefix `2020-01-01/` before each API path. For example:

```
http://${AWS_LAMBDA_RUNTIME_API}/2020-01-01/extension/register
```

API methods

- [Register](#)
- [Next](#)
- [Init error](#)
- [Exit error](#)

Register

During `Extension init`, all extensions need to register with Lambda to receive events. Lambda uses the full file name of the extension to validate that the extension has completed the bootstrap sequence. Therefore, each `Register` API call must include the `Lambda-Extension-Name` header with the full file name of the extension.

Internal extensions are started and stopped by the runtime process, so they are not permitted to register for the `Shutdown` event.

Path – `/extension/register`

Method – `POST`

Request headers

- `Lambda-Extension-Name` – The full file name of the extension. Required: yes. Type: string.

- **Lambda-Extension-Accept-Feature** – Use this to specify optional Extensions features during registration. Required: no. Type: comma separated string. Features available to specify using this setting:
 - **accountId** – If specified, the Extension registration response will contain the account ID associated with the Lambda function that you're registering the Extension for.

Request body parameters

- **events** – Array of the events to register for. Required: no. Type: array of strings. Valid strings: INVOKE, SHUTDOWN.

Response headers

- **Lambda-Extension-Identifier** – Generated unique agent identifier (UUID string) that is required for all subsequent requests.

Response codes

- 200 – Response body contains the function name, function version, and handler name.
- 400 – Bad Request
- 403 – Forbidden
- 500 – Container error. Non-recoverable state. Extension should exit promptly.

Example Example request body

```
{
  'events': [ 'INVOKE', 'SHUTDOWN' ]
}
```

Example Example response body

```
{
  "functionName": "helloWorld",
  "functionVersion": "$LATEST",
  "handler": "lambda_function.lambda_handler"
}
```

Example Example response body with optional accountId feature

```
{
  "functionName": "helloWorld",
  "functionVersion": "$LATEST",
  "handler": "lambda_function.lambda_handler",
  "accountId": "123456789012"
}
```

Next

Extensions send a Next API request to receive the next event, which can be an Invoke event or a Shutdown event. The response body contains the payload, which is a JSON document that contains event data.

The extension sends a Next API request to signal that it is ready to receive new events. This is a blocking call.

Do not set a timeout on the GET call, as the extension can be suspended for a period of time until there is an event to return.

Path – /extension/event/next

Method – GET

Request headers

- `Lambda-Extension-Identifier` – Unique identifier for extension (UUID string). Required: yes. Type: UUID string.

Response headers

- `Lambda-Extension-Event-Identifier` – Unique identifier for the event (UUID string).

Response codes

- 200 – Response contains information about the next event (EventInvoke or EventShutdown).
- 403 – Forbidden
- 500 – Container error. Non-recoverable state. Extension should exit promptly.

Init error

The extension uses this method to report an initialization error to Lambda. Call it when the extension fails to initialize after it has registered. After Lambda receives the error, no further API calls succeed. The extension should exit after it receives the response from Lambda.

Path – `/extension/init/error`

Method – `POST`

Request headers

- `Lambda-Extension-Identifier` – Unique identifier for extension. Required: yes. Type: UUID string.
- `Lambda-Extension-Function-Error-Type` – Error type that the extension encountered. Required: yes. This header consists of a string value. Lambda accepts any string, but we recommend a format of `<category.reason>`. For example:
 - `Extension.NoSuchHandler`
 - `Extension.APIKeyNotFound`
 - `Extension.ConfigInvalid`
 - `Extension.UnknownReason`

Request body parameters

- `ErrorRequest` – Information about the error. Required: no.

This field is a JSON object with the following structure:

```
{
  errorMessage: string (text description of the error),
  errorType: string,
  stackTrace: array of strings
}
```

Note that Lambda accepts any value for `errorType`.

The following example shows a Lambda function error message in which the function could not parse the event data provided in the invocation.

Example Function error

```
{
  "errorMessage" : "Error parsing event data.",
  "errorType" : "InvalidEventDataException",
  "stackTrace": [ ]
}
```

Response codes

- 202 – Accepted
- 400 – Bad Request
- 403 – Forbidden
- 500 – Container error. Non-recoverable state. Extension should exit promptly.

Exit error

The extension uses this method to report an error to Lambda before exiting. Call it when you encounter an unexpected failure. After Lambda receives the error, no further API calls succeed. The extension should exit after it receives the response from Lambda.

Path – `/extension/exit/error`

Method – **POST**

Request headers

- `Lambda-Extension-Identifier` – Unique identifier for extension. Required: yes. Type: UUID string.
- `Lambda-Extension-Function-Error-Type` – Error type that the extension encountered. Required: yes. This header consists of a string value. Lambda accepts any string, but we recommend a format of `<category.reason>`. For example:
 - `Extension.NoSuchHandler`
 - `Extension.APIKeyNotFound`
 - `Extension.ConfigInvalid`
 - `Extension.UnknownReason`

Request body parameters

- `ErrorRequest` – Information about the error. Required: no.

This field is a JSON object with the following structure:

```
{
  errorMessage: string (text description of the error),
  errorType: string,
  stackTrace: array of strings
}
```

Note that Lambda accepts any value for `errorType`.

The following example shows a Lambda function error message in which the function could not parse the event data provided in the invocation.

Example Function error

```
{
  "errorMessage" : "Error parsing event data.",
  "errorType" : "InvalidEventDataException",
  "stackTrace": [ ]
}
```

Response codes

- 202 – Accepted
- 400 – Bad Request
- 403 – Forbidden
- 500 – Container error. Non-recoverable state. Extension should exit promptly.

Accessing real-time telemetry data for extensions using the Telemetry API

The Telemetry API enables your extensions to receive telemetry data directly from Lambda. During function initialization and invocation, Lambda automatically captures telemetry, including logs, platform metrics, and platform traces. The Telemetry API enables extensions to access this telemetry data directly from Lambda in near real time.

Within the Lambda execution environment, you can subscribe your Lambda extensions to telemetry streams. After subscribing, Lambda automatically sends all telemetry data to your extensions. You then have the flexibility to process, filter, and dispatch the data to your preferred destination, such as an Amazon Simple Storage Service (Amazon S3) bucket or a third-part observability tools provider.

The following diagram shows how the Extensions API and Telemetry API link extensions to Lambda from within the execution environment. Additionally, the Runtime API connects your runtime and function to Lambda.

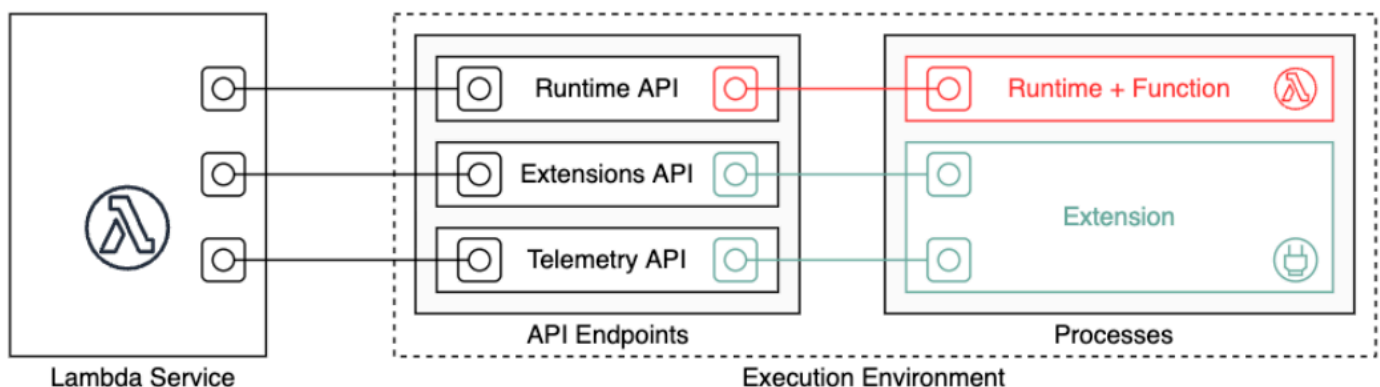

⚠ Important

The Lambda Telemetry API supersedes the Lambda Logs API. **While the Logs API remains fully functional, we recommend using only the Telemetry API going forward.** You can subscribe your extension to a telemetry stream using either the Telemetry API or the Logs API. After subscribing using one of these APIs, any attempt to subscribe using the other API returns an error.

Extensions can use the Telemetry API to subscribe to three different telemetry streams:

- **Platform telemetry** – Logs, metrics, and traces, which describe events and errors related to the execution environment runtime lifecycle, extension lifecycle, and function invocations.
- **Function logs** – Custom logs that the Lambda function code generates.
- **Extension logs** – Custom logs that the Lambda extension code generates.

Note

Lambda sends logs and metrics to CloudWatch, and traces to X-Ray (if you've activated tracing), even if an extension subscribes to telemetry streams.

Sections

- [Creating extensions using the Telemetry API](#)
- [Registering your extension](#)
- [Creating a telemetry listener](#)
- [Specifying a destination protocol](#)
- [Configuring memory usage and buffering](#)
- [Sending a subscription request to the Telemetry API](#)
- [Inbound Telemetry API messages](#)
- [Lambda Telemetry API reference](#)
- [Lambda Telemetry API Event schema reference](#)
- [Converting Lambda Telemetry API Event objects to OpenTelemetry Spans](#)
- [Using the Lambda Logs API](#)

Creating extensions using the Telemetry API

Lambda extensions run as independent processes in the execution environment. Extensions can continue to run after function invocation completes. Because extensions are separate processes, you can write them in a language different from the function code. We recommend writing extensions using a compiled language such as Golang or Rust. This way, the extension is a self-contained binary that can be compatible with any supported runtime.

The following diagram illustrates a four-step process to create an extension that receives and processes telemetry data using the Telemetry API.

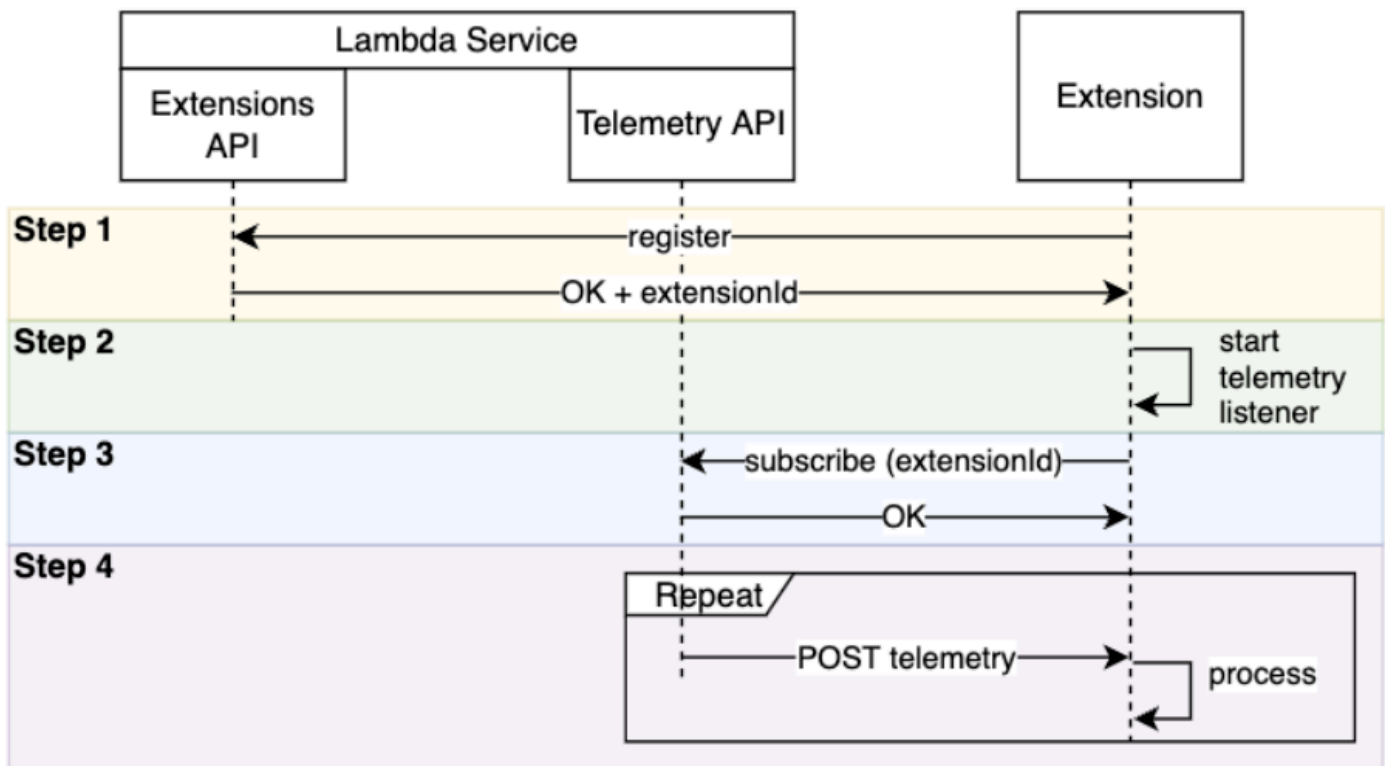

Here is each step in more detail:

1. Register your extension using the [the section called “Extensions API”](#). This provides you with a `Lambda-Extension-Identifier`, which you'll need in the following steps. For more information about how to register your extension, see [the section called “Registering your extension”](#).
2. Create a telemetry listener. This can be a basic HTTP or TCP server. Lambda uses the URI of the telemetry listener to send telemetry data to your extension. For more information, see [the section called “Creating a telemetry listener”](#).
3. Using the Subscribe API in the Telemetry API, subscribe your extension to the desired telemetry streams. You'll need the URI of your telemetry listener for this step. For more information, see [the section called “Sending a subscription request to the Telemetry API”](#).
4. Get telemetry data from Lambda via the telemetry listener. You can do any custom processing of this data, such as dispatching the data to Amazon S3 or to an external observability service.

Note

A Lambda function's execution environment can start and stop multiple times as part of its [lifecycle](#). In general, your extension code runs during function invocations, and also up to 2 seconds during the shutdown phase. We recommend batching the telemetry as it arrives to your listener. Then, use the `Invoke` and `Shutdown` lifecycle events to send each batch to their desired destinations.

Registering your extension

Before you can subscribe to telemetry data, you must register your Lambda extension. Registration occurs during the [extension initialization phase](#). The following example shows an HTTP request to register an extension.

```
POST http://${AWS_LAMBDA_RUNTIME_API}/2020-01-01/extension/register
Lambda-Extension-Name: lambda_extension_name
{
  'events': [ 'INVOKE', 'SHUTDOWN' ]
}
```

If the request succeeds, the subscriber receives an HTTP 200 success response. The response header contains the `Lambda-Extension-Identifier`. The response body contains other properties of the function.

```
HTTP/1.1 200 OK
Lambda-Extension-Identifier: a1b2c3d4-5678-90ab-cdef-EXAMPLE11111
{
  "functionName": "lambda_function",
  "functionVersion": "$LATEST",
  "handler": "lambda_handler",
  "accountId": "123456789012"
}
```

For more information, see the [the section called “Extensions API reference”](#).

Creating a telemetry listener

Your Lambda extension must have a listener that handles incoming requests from the Telemetry API. The following code shows an example telemetry listener implementation in Golang:

```
// Starts the server in a goroutine where the log events will be sent
func (s *TelemetryApiListener) Start() (string, error) {
    address := listenOnAddress()
    l.Info("[listener:Start] Starting on address", address)
    s.httpServer = &http.Server{Addr: address}
    http.HandleFunc("/", s.http_handler)
    go func() {
        err := s.httpServer.ListenAndServe()
        if err != http.ErrServerClosed {
            l.Error("[listener:goroutine] Unexpected stop on Http Server:", err)
            s.Shutdown()
        } else {
            l.Info("[listener:goroutine] Http Server closed:", err)
        }
    }()
    return fmt.Sprintf("http://%s/", address), nil
}

// http_handler handles the requests coming from the Telemetry API.
// Everytime Telemetry API sends log events, this function will read them from the
// response body
// and put into a synchronous queue to be dispatched later.
// Logging or printing besides the error cases below is not recommended if you have
// subscribed to
// receive extension logs. Otherwise, logging here will cause Telemetry API to send new
// logs for
// the printed lines which may create an infinite loop.
func (s *TelemetryApiListener) http_handler(w http.ResponseWriter, r *http.Request) {
    body, err := ioutil.ReadAll(r.Body)
    if err != nil {
        l.Error("[listener:http_handler] Error reading body:", err)
        return
    }

    // Parse and put the log messages into the queue
    var slice []interface{}
    _ = json.Unmarshal(body, &slice)

    for _, el := range slice {
        s.LogEventsQueue.Put(el)
    }
}
```



```
1.Info("[listener:http_handler] logEvents received:", len(slice), " LogEventsQueue
length:", s.LogEventsQueue.Len())
slice = nil
}
```

Specifying a destination protocol

When you subscribe to receive telemetry using the Telemetry API, you can specify a destination protocol in addition to the destination URI:

```
{
  "destination": {
    "protocol": "HTTP",
    "URI": "http://sandbox.localdomain:8080"
  }
}
```

Lambda accepts two protocols for receiving telemetry:

- **HTTP (recommended)** – Lambda delivers telemetry to a local HTTP endpoint (`http://sandbox.localdomain:${PORT}/${PATH}`) as an array of records in JSON format. The `$PATH` parameter is optional. Lambda supports only HTTP, not HTTPS. Lambda delivers telemetry through POST requests.
- **TCP** – Lambda delivers telemetry to a TCP port in [Newline delimited JSON \(NDJSON\) format](#).

Note

We strongly recommend using HTTP rather than TCP. With TCP, the Lambda platform cannot acknowledge when it delivers telemetry to the application layer. Therefore, if your extension crashes, you might lose telemetry. HTTP does not have this limitation.

Before subscribing to receive telemetry, establish the local HTTP listener or TCP port. During setup, note the following:

- Lambda sends telemetry only to destinations that are inside the execution environment.

- Lambda retries to send telemetry (with backoff) in the absence of a listener, or if the POST request encounters an error. If the telemetry listener crashes, it resumes receiving telemetry after Lambda restarts the execution environment.
- Lambda reserves port 9001. There are no other port number restrictions or recommendations.

Configuring memory usage and buffering

Memory usage in an execution environment grows linearly with the number of subscribers. Subscriptions consume memory resources because each one opens a new memory buffer to store telemetry data. Buffer memory usage contributes to the overall memory consumption in the execution environment.

When subscribing to receive telemetry through the Telemetry API, you have the option to buffer telemetry data and deliver it to subscribers in batches. To optimize memory usage, you can specify a buffering configuration:

```
{
  "buffering": {
    "maxBytes": 256*1024,
    "maxItems": 1000,
    "timeoutMs": 100
  }
}
```

Parameter	Description	Defaults and limits
maxBytes	The maximum volume of telemetry (in bytes) to buffer in memory.	Default: 262,144 Minimum: 262,144 Maximum: 1,048,576
maxItems	The maximum number of events to buffer in memory.	Default: 10,000 Minimum: 1,000 Maximum: 10,000

Parameter	Description	Defaults and limits
<code>timeoutMs</code>	The maximum time (in milliseconds) to buffer a batch.	Default: 1,000 Minimum: 25 Maximum: 30,000

When setting up buffering, keep these points in mind:

- If any of the input streams are closed, Lambda flushes the logs. For example, this can occur if the runtime crashes.
- Each subscriber can customize their buffering configuration in their subscription request.
- When determining the buffer size for reading the data, anticipate receiving payloads as large as $2 * \text{maxBytes} + \text{metadataBytes}$, where `maxBytes` is a component of your buffering setup. To gauge the amount of `metadataBytes` to consider, review the following metadata. Lambda appends metadata similar to this to each record:

```
{
  "time": "2022-08-20T12:31:32.123Z",
  "type": "function",
  "record": "Hello World"
}
```

- If the subscriber cannot process incoming telemetry fast enough, or if your function code generates very high log volume, Lambda might drop records to keep memory utilization bounded. When this occurs, Lambda sends a `platform.logsDropped` event.

Sending a subscription request to the Telemetry API

Lambda extensions can subscribe to receive telemetry data by sending a subscription request to the Telemetry API. The subscription request should contain information about the types of events that you want the extension to subscribe to. In addition, the request can contain [delivery destination information](#) and a [buffering configuration](#).

Before sending a subscription request, you must have an extension ID (Lambda-Extension-Identifier). When you [register your extension with the Extensions API](#), you obtain an extension ID from the API response.

Subscription occurs during the [extension initialization phase](#). The following example shows an HTTP request to subscribe to all three telemetry streams: platform telemetry, function logs, and extension logs.

```
PUT http://${AWS_LAMBDA_RUNTIME_API}/2022-07-01/telemetry HTTP/1.1
{
  "schemaVersion": "2022-12-13",
  "types": [
    "platform",
    "function",
    "extension"
  ],
  "buffering": {
    "maxItems": 1000,
    "maxBytes": 256*1024,
    "timeoutMs": 100
  },
  "destination": {
    "protocol": "HTTP",
    "URI": "http://sandbox.localdomain:8080"
  }
}
```

If the request succeeds, then the subscriber receives an HTTP 200 success response.

```
HTTP/1.1 200 OK
"OK"
```

Inbound Telemetry API messages

After subscribing using the Telemetry API, an extension automatically starts to receive telemetry from Lambda via POST requests. Each POST request body contains an array of Event objects. Each Event has the following schema:

```
{
  time: String,
  type: String,
  record: Object
}
```

- The `time` property defines when the Lambda platform generated the event. This is different from when the event actually occurred. The string value of `time` is a timestamp in ISO 8601 format.
- The `type` property defines the event type. The following table describes all possible values.
- The `record` property defines a JSON object that contains the telemetry data. The schema of this JSON object depends on the type.

The following table summarizes all types of Event objects, and links to the [Telemetry API Event schema reference](#) for each event type.

Category	Event type	Description	Event record schema
Platform event	<code>platform.initStart</code>	Function initialization started.	the section called "platform.initStart " schema
Platform event	<code>platform.initRuntimeDone</code>	Function initialization completed.	the section called "platform.initRuntimeDone " schema
Platform event	<code>platform.initReport</code>	A report of function initialization.	the section called "platform.initReport " schema
Platform event	<code>platform.start</code>	Function invocation started.	the section called "platform.start " schema
Platform event	<code>platform.runtimeDone</code>	The runtime finished processing an event with either success or failure.	the section called "platform.runtimeDone " schema

Category	Event type	Description	Event record schema
Platform event	<code>platform.report</code>	A report of function invocation.	the section called "platform.report" schema
Platform event	<code>platform.restoreStart</code>	Runtime restore started.	the section called "platform.restoreStart" schema
Platform event	<code>platform.restoreRuntimeDone</code>	Runtime restore completed.	the section called "platform.restoreRuntimeDone" schema
Platform event	<code>platform.restoreReport</code>	Report of runtime restore.	the section called "platform.restoreReport" schema
Platform event	<code>platform.telemetrySubscription</code>	The extension subscribed to the Telemetry API.	the section called "platform.telemetrySubscription" schema
Platform event	<code>platform.logsDropped</code>	Lambda dropped log entries.	the section called "platform.logsDropped" schema
Function logs	<code>function</code>	A log line from function code.	the section called "function" schema

Category	Event type	Description	Event record schema
Extension logs	extension	A log line from extension code.	the section called "extension " schema

Lambda Telemetry API reference

Use the Lambda Telemetry API endpoint to subscribe extensions to telemetry streams. You can retrieve the Telemetry API endpoint from the `AWS_LAMBDA_RUNTIME_API` environment variable. To send an API request, append the API version (`2022-07-01/`) and `telemetry/`. For example:

```
http://${AWS_LAMBDA_RUNTIME_API}/2022-07-01/telemetry/
```

For the OpenAPI Specification (OAS) definition of the subscription responses version 2022-12-13, see the following:

- **HTTP** – [telemetry-api-http-schema.zip](#)
- **TCP** – [telemetry-api-tcp-schema.zip](#)

API operations

- [Subscribe](#)

Subscribe

To subscribe to a telemetry stream, a Lambda extension can send a Subscribe API request.

- **Path** – `/telemetry`
- **Method** – PUT
- **Headers**
 - Content-Type: `application/json`
- **Request body parameters**
 - **schemaVersion**
 - Required: Yes
 - Type: String
 - Valid values: `"2022-12-13"` or `"2022-07-01"`
 - **destination** – The configuration settings that define the telemetry event destination and the protocol for event delivery.
 - Required: Yes
 - Type: Object

```
{
  "protocol": "HTTP",
  "URI": "http://sandbox.localdomain:8080"
}
```

- **protocol** – The protocol that Lambda uses to send telemetry data.
 - Required: Yes
 - Type: String
 - Valid values: "HTTP"|"TCP"
- **URI** – The URI to send telemetry data to.
 - Required: Yes
 - Type: String
 - For more information, see [the section called “Specifying a destination protocol”](#).
- **types** – The types of telemetry that you want the extension to subscribe to.
 - Required: Yes
 - Type: Array of strings
 - Valid values: "platform"|"function"|"extension"
- **buffering** – The configuration settings for event buffering.
 - Required: No
 - Type: Object

```
{
  "buffering": {
    "maxItems": 1000,
    "maxBytes": 256*1024,
    "timeoutMs": 100
  }
}
```

- **maxItems** – The maximum number of events to buffer in memory.
 - Required: No
 - Type: Integer
 - Default: 1,000
 - **Minimum: 1,000**

- Maximum: 10,000
- **maxBytes** – The maximum volume of telemetry (in bytes) to buffer in memory.
 - Required: No
 - Type: Integer
 - Default: 262,144
 - Minimum: 262,144
 - Maximum: 1,048,576
- **timeoutMs** – The maximum time (in milliseconds) to buffer a batch.
 - Required: No
 - Type: Integer
 - Default: 1,000
 - Minimum: 25
 - Maximum: 30,000
- For more information, see [the section called “Configuring memory usage and buffering”](#).

Example Subscribe API request

```
PUT http://${AWS_LAMBDA_RUNTIME_API}/2022-07-01/telemetry HTTP/1.1
{
  "schemaVersion": "2022-12-13",
  "types": [
    "platform",
    "function",
    "extension"
  ],
  "buffering": {
    "maxItems": 1000,
    "maxBytes": 256*1024,
    "timeoutMs": 100
  },
  "destination": {
    "protocol": "HTTP",
    "URI": "http://sandbox.localdomain:8080"
  }
}
```

If the Subscribe request succeeds, the extension receives an HTTP 200 success response:

```
HTTP/1.1 200 OK
"OK"
```

If the Subscribe request fails, the extension receives an error response. For example:

```
HTTP/1.1 400 OK
{
  "errorType": "ValidationError",
  "errorMessage": "URI port is not provided; types should not be empty"
}
```

Here are some additional response codes that the extension can receive:

- 200 – Request completed successfully
- 202 – Request accepted. Subscription request response in local testing environment
- 400 – Bad request
- 500 – Service error

Lambda Telemetry API Event schema reference

Use the Lambda Telemetry API endpoint to subscribe extensions to telemetry streams. You can retrieve the Telemetry API endpoint from the `AWS_LAMBDA_RUNTIME_API` environment variable. To send an API request, append the API version (`2022-07-01/`) and `telemetry/`. For example:

```
http://${AWS_LAMBDA_RUNTIME_API}/2022-07-01/telemetry/
```

For the OpenAPI Specification (OAS) definition of the subscription responses version 2022-12-13, see the following:

- **HTTP** – [telemetry-api-http-schema.zip](#)
- **TCP** – [telemetry-api-tcp-schema.zip](#)

The following table is a summary of all the types of Event objects that the Telemetry API supports.

Category	Event type	Description	Event record schema
Platform event	<code>platform.initStart</code>	Function initialization started.	the section called "platform.initStart " schema
Platform event	<code>platform.initRuntimeDone</code>	Function initialization completed.	the section called "platform.initRuntimeDone " schema
Platform event	<code>platform.initReport</code>	A report of function initialization.	the section called "platform.initReport " schema
Platform event	<code>platform.start</code>	Function invocation started.	the section called "platform.start " schema

Category	Event type	Description	Event record schema
Platform event	<code>platform.runtimeDone</code>	The runtime finished processing an event with either success or failure.	the section called "platform.runtimeDone " schema
Platform event	<code>platform.report</code>	A report of function invocation.	the section called "platform.report " schema
Platform event	<code>platform.restoreStart</code>	Runtime restore started.	the section called "platform.restoreStart " schema
Platform event	<code>platform.restoreRuntimeDone</code>	Runtime restore completed.	the section called "platform.restoreRuntimeDone " schema
Platform event	<code>platform.restoreReport</code>	Report of runtime restore.	the section called "platform.restoreReport " schema
Platform event	<code>platform.telemetrySubscription</code>	The extension subscribed to the Telemetry API.	the section called "platform.telemetrySubscription " schema
Platform event	<code>platform.logsDropped</code>	Lambda dropped log entries.	the section called "platform.logsDropped " schema

Category	Event type	Description	Event record schema
Function logs	function	A log line from function code.	the section called "function" schema
Extension logs	extension	A log line from extension code.	the section called "extension " schema

Contents

- [Telemetry API Event object types](#)
 - [platform.initStart](#)
 - [platform.initRuntimeDone](#)
 - [platform.initReport](#)
 - [platform.start](#)
 - [platform.runtimeDone](#)
 - [platform.report](#)
 - [platform.restoreStart](#)
 - [platform.restoreRuntimeDone](#)
 - [platform.restoreReport](#)
 - [platform.extension](#)
 - [platform.telemetrySubscription](#)
 - [platform.logsDropped](#)
 - [function](#)
 - [extension](#)
- [Shared object types](#)
 - [InitPhase](#)
 - [InitReportMetrics](#)
 - [InitType](#)
 - [ReportMetrics](#)
 - [RestoreReportMetrics](#)
 - [RuntimeDoneMetrics](#)

- [Span](#)
- [Status](#)
- [TraceContext](#)
- [TracingType](#)

Telemetry API Event object types

This section details the types of Event objects that the Lambda Telemetry API supports. In the event descriptions, a question mark (?) indicates that the attribute may not be present in the object.

`platform.initStart`

A `platform.initStart` event indicates that the function initialization phase has started. A `platform.initStart` Event object has the following shape:

```
Event: Object
- time: String
- type: String = platform.initStart
- record: PlatformInitStart
```

The `PlatformInitStart` object has the following attributes:

- **functionName** – String
- **functionVersion** – String
- **initializationType** – [the section called “InitType”](#) object
- **instanceId?** – String
- **instanceMaxMemory?** – Integer
- **phase** – [the section called “InitPhase”](#) object
- **runtimeVersion?** – String
- **runtimeVersionArn?** – String

The following is an example Event of type `platform.initStart`:

```
{
  "time": "2022-10-12T00:00:15.064Z",
```

```

    "type": "platform.initStart",
    "record": {
      "initializationType": "on-demand",
      "phase": "init",
      "runtimeVersion": "nodejs-14.v3",
      "runtimeVersionArn": "arn",
      "functionName": "myFunction",
      "functionVersion": "$LATEST",
      "instanceId": "82561ce0-53dd-47d1-90e0-c8f5e063e62e",
      "instanceMaxMemory": 256
    }
  }
}

```

platform.initRuntimeDone

A `platform.initRuntimeDone` event indicates that the function initialization phase has completed. A `platform.initRuntimeDone` Event object has the following shape:

```

Event: Object
- time: String
- type: String = platform.initRuntimeDone
- record: PlatformInitRuntimeDone

```

The `PlatformInitRuntimeDone` object has the following attributes:

- **initializationType** – [the section called “InitType”](#) object
- **phase** – [the section called “InitPhase”](#) object
- **status** – [the section called “Status”](#) object
- **spans?** – List of [the section called “Span”](#) objects

The following is an example Event of type `platform.initRuntimeDone`:

```

{
  "time": "2022-10-12T00:01:15.000Z",
  "type": "platform.initRuntimeDone",
  "record": {
    "initializationType": "on-demand"
    "status": "success",
    "spans": [
      {

```



```

        "name": "someTimeSpan",
        "start": "2022-06-02T12:02:33.913Z",
        "durationMs": 70.5
    }
]
}
}

```

platform.initReport

A `platform.initReport` event contains an overall report of the function initialization phase. A `platform.initReport` Event object has the following shape:

```

Event: Object
- time: String
- type: String = platform.initReport
- record: PlatformInitReport

```

The `PlatformInitReport` object has the following attributes:

- **errorType?** – string
- **initializationType** – [the section called “InitType”](#) object
- **phase** – [the section called “InitPhase”](#) object
- **metrics** – [the section called “InitReportMetrics”](#) object
- **spans?** – List of [the section called “Span”](#) objects
- **status** – [the section called “Status”](#) object

The following is an example Event of type `platform.initReport`:

```

{
  "time": "2022-10-12T00:01:15.000Z",
  "type": "platform.initReport",
  "record": {
    "initializationType": "on-demand",
    "status": "success",
    "phase": "init",
    "metrics": {
      "durationMs": 125.33
    }
  },
}

```

```

    "spans": [
      {
        "name": "someTimeSpan",
        "start": "2022-06-02T12:02:33.913Z",
        "durationMs": 90.1
      }
    ]
  }
}

```

platform.start

A `platform.start` event indicates that the function invocation phase has started. A `platform.start` Event object has the following shape:

```

Event: Object
- time: String
- type: String = platform.start
- record: PlatformStart

```

The `PlatformStart` object has the following attributes:

- **requestId** – String
- **version?** – String
- **tracing?** – [the section called “TraceContext”](#)

The following is an example Event of type `platform.start`:

```

{
  "time": "2022-10-12T00:00:15.064Z",
  "type": "platform.start",
  "record": {
    "requestId": "6d68ca91-49c9-448d-89b8-7ca3e6dc66aa",
    "version": "$LATEST",
    "tracing": {
      "spanId": "54565fb41ac79632",
      "type": "X-Amzn-Trace-Id",
      "value":
"Root=1-62e900b2-710d76f009d6e7785905449a;Parent=0efbd19962d95b05;Sampled=1"
    }
  }
}

```

```
}
```

platform.runtimeDone

A `platform.runtimeDone` event indicates that the function invocation phase has completed. A `platform.runtimeDone` Event object has the following shape:

```
Event: Object
- time: String
- type: String = platform.runtimeDone
- record: PlatformRuntimeDone
```

The `PlatformRuntimeDone` object has the following attributes:

- **errorType?** – String
- **metrics?** – [the section called “RuntimeDoneMetrics”](#) object
- **requestId** – String
- **status** – [the section called “Status”](#) object
- **spans?** – List of [the section called “Span”](#) objects
- **tracing?** – [the section called “TraceContext”](#) object

The following is an example Event of type `platform.runtimeDone`:

```
{
  "time": "2022-10-12T00:01:15.000Z",
  "type": "platform.runtimeDone",
  "record": {
    "requestId": "6d68ca91-49c9-448d-89b8-7ca3e6dc66aa",
    "status": "success",
    "tracing": {
      "spanId": "54565fb41ac79632",
      "type": "X-Amzn-Trace-Id",
      "value":
"Root=1-62e900b2-710d76f009d6e7785905449a;Parent=0efbd19962d95b05;Sampled=1"
    },
    "spans": [
      {
        "name": "someTimeSpan",
        "start": "2022-08-02T12:01:23:521Z",
        "durationMs": 80.0
      }
    ]
  }
}
```

```
    }
  ],
  "metrics": {
    "durationMs": 140.0,
    "producedBytes": 16
  }
}
```

platform.report

A `platform.report` event contains an overall report of the function invoke phase. A `platform.report` Event object has the following shape:

```
Event: Object
- time: String
- type: String = platform.report
- record: PlatformReport
```

The `PlatformReport` object has the following attributes:

- **metrics** – [the section called “ReportMetrics”](#) object
- **requestId** – String
- **spans?** – List of [the section called “Span”](#) objects
- **status** – [the section called “Status”](#) object
- **tracing?** – [the section called “TraceContext”](#) object

The following is an example Event of type `platform.report`:

```
{
  "time": "2022-10-12T00:01:15.000Z",
  "type": "platform.report",
  "record": {
    "metrics": {
      "billedDurationMs": 694,
      "durationMs": 693.92,
      "initDurationMs": 397.68,
      "maxMemoryUsedMB": 84,
      "memorySizeMB": 128
    },
```

```
    "requestId": "6d68ca91-49c9-448d-89b8-7ca3e6dc66aa",  
  }  
}
```

platform.restoreStart

A `platform.restoreStart` event indicates that a function environment restoration event started. In an environment restoration event, Lambda creates the environment from a cached snapshot rather than initializing it from scratch. For more information, see [Lambda SnapStart](#). A `platform.restoreStart` Event object has the following shape:

```
Event: Object  
- time: String  
- type: String = platform.restoreStart  
- record: PlatformRestoreStart
```

The `PlatformRestoreStart` object has the following attributes:

- **functionName** – String
- **functionVersion** – String
- **instanceId?** – String
- **instanceMaxMemory?** – String
- **runtimeVersion?** – String
- **runtimeVersionArn?** – String

The following is an example Event of type `platform.restoreStart`:

```
{  
  "time": "2022-10-12T00:00:15.064Z",  
  "type": "platform.restoreStart",  
  "record": {  
    "runtimeVersion": "nodejs-14.v3",  
    "runtimeVersionArn": "arn",  
    "functionName": "myFunction",  
    "functionVersion": "$LATEST",  
    "instanceId": "82561ce0-53dd-47d1-90e0-c8f5e063e62e",  
    "instanceMaxMemory": 256  
  }  
}
```

`platform.restoreRuntimeDone`

A `platform.restoreRuntimeDone` event indicates that a function environment restoration event completed. In an environment restoration event, Lambda creates the environment from a cached snapshot rather than initializing it from scratch. For more information, see [Lambda SnapStart](#). A `platform.restoreRuntimeDone` Event object has the following shape:

```
Event: Object
- time: String
- type: String = platform.restoreRuntimeDone
- record: PlatformRestoreRuntimeDone
```

The `PlatformRestoreRuntimeDone` object has the following attributes:

- **errorType?** – String
- **spans?** – List of [the section called “Span”](#) objects
- **status** – [the section called “Status”](#) object

The following is an example Event of type `platform.restoreRuntimeDone`:

```
{
  "time": "2022-10-12T00:00:15.064Z",
  "type": "platform.restoreRuntimeDone",
  "record": {
    "status": "success",
    "spans": [
      {
        "name": "someTimeSpan",
        "start": "2022-08-02T12:01:23:521Z",
        "durationMs": 80.0
      }
    ]
  }
}
```

`platform.restoreReport`

A `platform.restoreReport` event contains an overall report of a function restoration event. A `platform.restoreReport` Event object has the following shape:

```
Event: Object
- time: String
- type: String = platform.restoreReport
- record: PlatformRestoreReport
```

The PlatformRestoreReport object has the following attributes:

- **errorType?** – string
- **metrics?** – [the section called “RestoreReportMetrics”](#) object
- **spans?** – List of [the section called “Span”](#) objects
- **status** – [the section called “Status”](#) object

The following is an example Event of type `platform.restoreReport`:

```
{
  "time": "2022-10-12T00:00:15.064Z",
  "type": "platform.restoreReport",
  "record": {
    "status": "success",
    "metrics": {
      "durationMs": 15.19
    },
    "spans": [
      {
        "name": "someTimeSpan",
        "start": "2022-08-02T12:01:23:521Z",
        "durationMs": 30.0
      }
    ]
  }
}
```

platform.extension

An extension event contains logs from the extension code. An extension Event object has the following shape:

```
Event: Object
- time: String
- type: String = extension
```

```
- record: {}
```

The PlatformExtension object has the following attributes:

- **events** – List of String
- **name** – String
- **state** – String

The following is an example Event of type `platform.extension`:

```
{
  "time": "2022-10-12T00:02:15.000Z",
  "type": "platform.extension",
  "record": {
    "events": [ "INVOKE", "SHUTDOWN" ],
    "name": "my-telemetry-extension",
    "state": "Ready"
  }
}
```

platform.telemetrySubscription

A `platform.telemetrySubscription` event contains information about an extension subscription. A `platform.telemetrySubscription` Event object has the following shape:

```
Event: Object
- time: String
- type: String = platform.telemetrySubscription
- record: PlatformTelemetrySubscription
```

The PlatformTelemetrySubscription object has the following attributes:

- **name** – String
- **state** – String
- **types** – List of String

The following is an example Event of type `platform.telemetrySubscription`:

```
{
```



```
"time": "2022-10-12T00:02:35.000Z",
"type": "platform.telemetrySubscription",
"record": {
  "name": "my-telemetry-extension",
  "state": "Subscribed",
  "types": [ "platform", "function" ]
}
```

platform.logsDropped

A `platform.logsDropped` event contains information about dropped events. Lambda emits the `platform.logsDropped` event when a function outputs logs at too high a rate for Lambda to process them. When Lambda can't send logs to CloudWatch or to the extension subscribed to Telemetry API at the rate the function produces them, it drops logs to prevent the function's execution from slowing down. A `platform.logsDropped` Event object has the following shape:

```
Event: Object
- time: String
- type: String = platform.logsDropped
- record: PlatformLogsDropped
```

The `PlatformLogsDropped` object has the following attributes:

- **droppedBytes** – Integer
- **droppedRecords** – Integer
- **reason** – String

The following is an example Event of type `platform.logsDropped`:

```
{
  "time": "2022-10-12T00:02:35.000Z",
  "type": "platform.logsDropped",
  "record": {
    "droppedBytes": 12345,
    "droppedRecords": 123,
    "reason": "Some logs were dropped because the downstream consumer is slower
than the logs production rate"
  }
}
```

function

A function event contains logs from the function code. A function Event object has the following shape:

```
Event: Object
- time: String
- type: String = function
- record: {}
```

The format of the `record` field depends on whether your function's logs are formatted in plain text or JSON format. To learn more about log format configuration options, see [the section called "Configuring JSON and plain text log formats"](#)

The following is an example Event of type `function` where the log format is plain text:

```
{
  "time": "2022-10-12T00:03:50.000Z",
  "type": "function",
  "record": "[INFO] Hello world, I am a function!"
}
```

The following is an example Event of type `function` where the log format is JSON:

```
{
  "time": "2022-10-12T00:03:50.000Z",
  "type": "function",
  "record": {
    "timestamp": "2022-10-12T00:03:50.000Z",
    "level": "INFO",
    "requestId": "79b4f56e-95b1-4643-9700-2807f4e68189",
    "message": "Hello world, I am a function!"
  }
}
```

Note

If the schema version you're using is older than the 2022-12-13 version, then the `"record"` is always rendered as a string even when your function's logging format is configured as JSON.

extension

A `extension` event contains logs from the extension code. A `extension Event` object has the following shape:

```
Event: Object
- time: String
- type: String = extension
- record: {}
```

The format of the `record` field depends on whether your function's logs are formatted in plain text or JSON format. To learn more about log format configuration options, see [the section called "Configuring JSON and plain text log formats"](#)

The following is an example Event of type `extension` where the log format is plain text:

```
{
  "time": "2022-10-12T00:03:50.000Z",
  "type": "extension",
  "record": "[INFO] Hello world, I am an extension!"
}
```

The following is an example Event of type `extension` where the log format is JSON:

```
{
  "time": "2022-10-12T00:03:50.000Z",
  "type": "extension",
  "record": {
    "timestamp": "2022-10-12T00:03:50.000Z",
    "level": "INFO",
    "requestId": "79b4f56e-95b1-4643-9700-2807f4e68189",
    "message": "Hello world, I am an extension!"
  }
}
```

Note

If the schema version you're using is older than the 2022-12-13 version, then the `"record"` is always rendered as a string even when your function's logging format is configured as JSON.

Shared object types

This section details the types of shared objects that the Lambda Telemetry API supports.

InitPhase

A string enum that describes the phase when the initialization step occurs. In most cases, Lambda runs the function initialization code during the `init` phase. However, in some error cases, Lambda may re-run the function initialization code during the `invoke` phase. (This is called a *suppressed init*.)

- **Type** – String
- **Valid values** – `init|invoke|snap-start`

InitReportMetrics

An object that contains metrics about an initialization phase.

- **Type** – Object

An `InitReportMetrics` object has the following shape:

```
InitReportMetrics: Object
- durationMs: Double
```

The following is an example `InitReportMetrics` object:

```
{
  "durationMs": 247.88
}
```

InitType

A string enum that describes how Lambda initialized the environment.

- **Type** – String
- **Valid values** – `on-demand|provisioned-concurrency`

ReportMetrics

An object that contains metrics about a completed phase.

- **Type** – Object

A ReportMetrics object has the following shape:

```
ReportMetrics: Object
- billedDurationMs: Integer
- durationMs: Double
- initDurationMs?: Double
- maxMemoryUsedMB: Integer
- memorySizeMB: Integer
- restoreDurationMs?: Double
```

The following is an example ReportMetrics object:

```
{
  "billedDurationMs": 694,
  "durationMs": 693.92,
  "initDurationMs": 397.68,
  "maxMemoryUsedMB": 84,
  "memorySizeMB": 128
}
```

RestoreReportMetrics

An object that contains metrics about a completed restoration phase.

- **Type** – Object

A RestoreReportMetrics object has the following shape:

```
RestoreReportMetrics: Object
- durationMs: Double
```

The following is an example RestoreReportMetrics object:

```
{
```

```
"durationMs": 15.19
}
```

RuntimeDoneMetrics

An object that contains metrics about an invocation phase.

- **Type** – Object

A `RuntimeDoneMetrics` object has the following shape:

```
RuntimeDoneMetrics: Object
- durationMs: Double
- producedBytes?: Integer
```

The following is an example `RuntimeDoneMetrics` object:

```
{
  "durationMs": 200.0,
  "producedBytes": 15
}
```

Span

An object that contains details about a span. A span represents a unit of work or operation in a trace. For more information about spans, see [Span](#) on the **Tracing API** page of the OpenTelemetry Docs website.

Lambda supports the following spans for the platform. `RuntimeDone` event:

- The `responseLatency` span describes how long it took your Lambda function to start sending the response.
- The `responseDuration` span describes how long it took your Lambda function to finish sending the entire response.
- The `runtimeOverhead` span describes how long it took the Lambda runtime to signal that it is ready to process the next function invoke. This is how long the runtime took to call the [next invocation](#) API to get the next event after returning your function response.

The following is an example `responseLatency` span object:

```
{
  "name": "responseLatency",
  "start": "2022-08-02T12:01:23.521Z",
  "durationMs": 23.02
}
```

Status

An object that describes the status of an initialization or invocation phase. If the status is either `failure` or `error`, then the `Status` object also contains an `errorType` field describing the error.

- **Type** – Object
- **Valid status values** – `success|failure|error|timeout`

TraceContext

An object that describes the properties of a trace.

- **Type** – Object

A `TraceContext` object has the following shape:

```
TraceContext: Object
- spanId?: String
- type: TracingType enum
- value: String
```

The following is an example `TraceContext` object:

```
{
  "spanId": "073a49012f3c312e",
  "type": "X-Amzn-Trace-Id",
  "value":
    "Root=1-62e900b2-710d76f009d6e7785905449a;Parent=0efbd19962d95b05;Sampled=1"
}
```

TracingType

A string enum that describes the type of tracing in a [the section called “TraceContext”](#) object.

- **Type** – String
- **Valid values** – X-Amzn-Trace-Id

Converting Lambda Telemetry API Event objects to OpenTelemetry Spans

The AWS Lambda Telemetry API schema is semantically compatible with OpenTelemetry (OTel). This means that you can convert your AWS Lambda Telemetry API Event objects to OpenTelemetry (OTel) Spans. When converting, you shouldn't map a single Event object to a single OTel Span. Instead, you should present all three events related to a lifecycle phase in a single OTel Span. For example, the `start`, `runtimeDone`, and `runtimeReport` events represent a single function invocation. Present all three of these events as a single OTel Span.

You can convert your events using Span Events or Child (nested) Spans. The tables on this page describe the mappings between Telemetry API schema properties and OTel Span properties for both approaches. For more information about OTel Spans, see [Span](#) on the **Tracing API** page of the OpenTelemetry Docs website.

Sections

- [Map to OTel Spans with Span Events](#)
- [Map to OTel Spans with Child Spans](#)

Map to OTel Spans with Span Events

In the following tables, `e` represents the event coming from the telemetry source.

Mapping the *Start events

OpenTelemetry	Lambda Telemetry API schema
<code>Span.Name</code>	Your extension generates this value based on the <code>type</code> field.
<code>Span.StartTime</code>	Use <code>e.time</code> .
<code>Span.EndTime</code>	N/A, because the event hasn't completed yet.
<code>Span.Kind</code>	Set to <code>Server</code> .
<code>Span.Status</code>	Set to <code>Unset</code> .

OpenTelemetry	Lambda Telemetry API schema
Span.TraceId	Parse the AWS X-Ray header found in <code>e.tracing.value</code> , then use the TraceId value.
Span.ParentId	Parse the X-Ray header found in <code>e.tracing.value</code> , then use the Parent value.
Span.SpanId	Use <code>e.tracing.spanId</code> if available. Otherwise, generate a new SpanId.
Span.SpanContext.TraceState	N/A for an X-Ray trace context.
Span.SpanContext.TraceFlags	Parse the X-Ray header found in <code>e.tracing.value</code> , then use the Sampled value.
Span.Attributes	Your extension can add any custom values here.

Mapping the *RuntimeDone events

OpenTelemetry	Lambda Telemetry API schema
Span.Name	Your extension generates the value based on the type field.
Span.StartTime	Use <code>e.time</code> from the matching *Start event. Alternatively, use <code>e.time - e.metrics.durationMs</code> .
Span.EndTime	N/A, because the event hasn't completed yet.
Span.Kind	Set to Server.
Span.Status	If <code>e.status</code> doesn't equal success, then set to Error.

OpenTelemetry	Lambda Telemetry API schema
	Otherwise, set to 0k.
<code>Span.Events[]</code>	Use <code>e.spans[]</code> .
<code>Span.Events[i].Name</code>	Use <code>e.spans[i].name</code> .
<code>Span.Events[i].Time</code>	Use <code>e.spans[i].start</code> .
<code>Span.TraceId</code>	Parse the AWS X-Ray header found in <code>e.tracing.value</code> , then use the <code>TraceId</code> value.
<code>Span.ParentId</code>	Parse the X-Ray header found in <code>e.tracing.value</code> , then use the <code>Parent</code> value.
<code>Span.SpanId</code>	Use the same <code>SpanId</code> from the <code>*Start</code> event. If unavailable, then use <code>e.tracing.spanId</code> , or generate a new <code>SpanId</code> .
<code>Span.SpanContext.TraceState</code>	N/A for an X-Ray trace context.
<code>Span.SpanContext.TraceFlags</code>	Parse the X-Ray header found in <code>e.tracing.value</code> , then use the <code>Sampled</code> value.
<code>Span.Attributes</code>	Your extension can add any custom values here.

Mapping the `*Report` events

OpenTelemetry	Lambda Telemetry API schema
<code>Span.Name</code>	Your extension generates the value based on the <code>type</code> field.
<code>Span.StartTime</code>	Use <code>e.time</code> from the matching <code>*Start</code> event.

OpenTelemetry	Lambda Telemetry API schema
	Alternatively, use <code>e.time - e.metrics.durationMs</code> .
<code>Span.EndTime</code>	Use <code>e.time</code> .
<code>Span.Kind</code>	Set to <code>Server</code> .
<code>Span.Status</code>	Use the same value as the <code>*RuntimeDone</code> event.
<code>Span.TraceId</code>	Parse the AWS X-Ray header found in <code>e.tracing.value</code> , then use the <code>TraceId</code> value.
<code>Span.ParentId</code>	Parse the X-Ray header found in <code>e.tracing.value</code> , then use the <code>Parent</code> value.
<code>Span.SpanId</code>	Use the same <code>SpanId</code> from the <code>*Start</code> event. If unavailable, then use <code>e.tracing.spanId</code> , or generate a new <code>SpanId</code> .
<code>Span.SpanContext.TraceState</code>	N/A for an X-Ray trace context.
<code>Span.SpanContext.TraceFlags</code>	Parse the X-Ray header found in <code>e.tracing.value</code> , then use the <code>Sampled</code> value.
<code>Span.Attributes</code>	Your extension can add any custom values here.

Map to OTel Spans with Child Spans

The following table describes how to convert Lambda Telemetry API events into OTel Spans with Child (nested) Spans for `*RuntimeDone` Spans. For `*Start` and `*Report` mappings, refer to the tables in [the section called “Map to OTel Spans with Span Events”](#), as they're the same for Child Spans. In this table, `e` represents the event coming from the telemetry source.

Mapping the `*RuntimeDone` events

OpenTelemetry	Lambda Telemetry API schema
<code>Span.Name</code>	Your extension generates the value based on the <code>type</code> field.
<code>Span.StartTime</code>	Use <code>e.time</code> from the matching <code>*Start</code> event. Alternatively, use <code>e.time - e.metrics.durationMs</code> .
<code>Span.EndTime</code>	N/A, because the event hasn't completed yet.
<code>Span.Kind</code>	Set to <code>Server</code> .
<code>Span.Status</code>	If <code>e.status</code> doesn't equal <code>success</code> , then set to <code>Error</code> . Otherwise, set to <code>Ok</code> .
<code>Span.TraceId</code>	Parse the AWS X-Ray header found in <code>e.tracing.value</code> , then use the <code>TraceId</code> value.
<code>Span.ParentId</code>	Parse the X-Ray header found in <code>e.tracing.value</code> , then use the <code>Parent</code> value.
<code>Span.SpanId</code>	Use the same <code>SpanId</code> from the <code>*Start</code> event. If unavailable, then use <code>e.tracing.spanId</code> , or generate a new <code>SpanId</code> .
<code>Span.SpanContext.TraceState</code>	N/A for an X-Ray trace context.
<code>Span.SpanContext.TraceFlags</code>	Parse the X-Ray header found in <code>e.tracing.value</code> , then use the <code>Sampled</code> value.
<code>Span.Attributes</code>	Your extension can add any custom values here.
<code>ChildSpan[i].Name</code>	Use <code>e.spans[i].name</code> .

OpenTelemetry	Lambda Telemetry API schema
<code>ChildSpan[i].StartTime</code>	Use <code>e.spans[i].start</code> .
<code>ChildSpan[i].EndTime</code>	Use <code>e.spans[i].start + e.spans[i].durations</code> .
<code>ChildSpan[i].Kind</code>	Same as parent <code>Span.Kind</code> .
<code>ChildSpan[i].Status</code>	Same as parent <code>Span.Status</code> .
<code>ChildSpan[i].TraceId</code>	Same as parent <code>Span.TraceId</code> .
<code>ChildSpan[i].ParentId</code>	Use parent <code>Span.SpanId</code> .
<code>ChildSpan[i].SpanId</code>	Generate a new <code>SpanId</code> .
<code>ChildSpan[i].SpanContext.TraceState</code>	N/A for an X-Ray trace context.
<code>ChildSpan[i].SpanContext.TraceFlags</code>	Same as parent <code>Span.SpanContext.TraceFlags</code> .

Using the Lambda Logs API

⚠ Important

The Lambda Telemetry API supersedes the Lambda Logs API. **While the Logs API remains fully functional, we recommend using only the Telemetry API going forward.** You can subscribe your extension to a telemetry stream using either the Telemetry API or the Logs API. After subscribing using one of these APIs, any attempt to subscribe using the other API returns an error.

Lambda automatically captures runtime logs and streams them to Amazon CloudWatch. This log stream contains the logs that your function code and extensions generate, and also the logs that Lambda generates as part of the function invocation.

[Lambda extensions](#) can use the Lambda Runtime Logs API to subscribe to log streams directly from within the Lambda [execution environment](#). Lambda streams the logs to the extension, and the extension can then process, filter, and send the logs to any preferred destination.

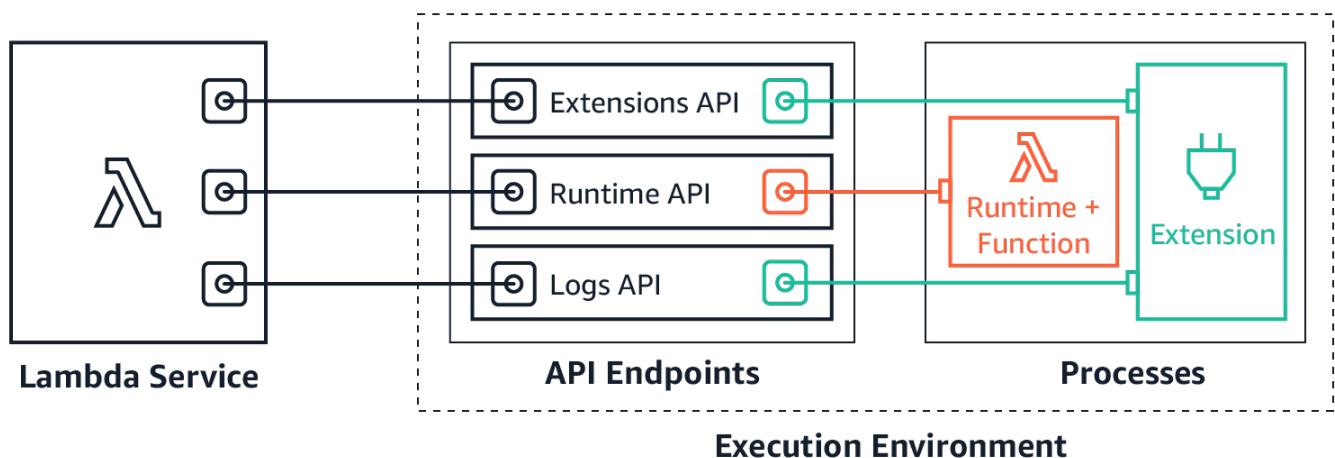

The Logs API allows extensions to subscribe to three different logs streams:

- Function logs that the Lambda function generates and writes to `stdout` or `stderr`.
- Extension logs that extension code generates.
- Lambda platform logs, which record events and errors related to invocations and extensions.

Note

Lambda sends all logs to CloudWatch, even when an extension subscribes to one or more of the log streams.

Topics

- [Subscribing to receive logs](#)
- [Memory usage](#)
- [Destination protocols](#)
- [Buffering configuration](#)
- [Example subscription](#)
- [Sample code for Logs API](#)
- [Logs API reference](#)
- [Log messages](#)

Subscribing to receive logs

A Lambda extension can subscribe to receive logs by sending a subscription request to the Logs API.

To subscribe to receive logs, you need the extension identifier (`Lambda-Extension-Identifier`). First [register the extension](#) to receive the extension identifier. Then subscribe to the Logs API during [initialization](#). After the initialization phase completes, Lambda does not process subscription requests.

Note

Logs API subscription is idempotent. Duplicate subscribe requests do not result in duplicate subscriptions.

Memory usage

Memory usage increases linearly as the number of subscribers increases. Subscriptions consume memory resources because each subscription opens a new memory buffer to store the logs. To help

optimize memory usage, you can adjust the [buffering configuration](#). Buffer memory usage counts towards overall memory consumption in the execution environment.

Destination protocols

You can choose one of the following protocols to receive the logs:

1. **HTTP** (recommended) – Lambda delivers logs to a local HTTP endpoint (`http://sandbox.localdomain:${PORT}/${PATH}`) as an array of records in JSON format. The `$PATH` parameter is optional. Note that only HTTP is supported, not HTTPS. You can choose to receive logs through PUT or POST.
2. **TCP** – Lambda delivers logs to a TCP port in [Newline delimited JSON \(NDJSON\) format](#).

We recommend using HTTP rather than TCP. With TCP, the Lambda platform cannot acknowledge when it delivers logs to the application layer. Therefore, you might lose logs if your extension crashes. HTTP does not share this limitation.

We also recommend setting up the local HTTP listener or the TCP port before subscribing to receive logs. During setup, note the following:

- Lambda sends logs only to destinations that are inside the execution environment.
- Lambda retries the attempt to send the logs (with backoff) if there is no listener, or if the POST or PUT request results in an error. If the log subscriber crashes, it continues to receive logs after Lambda restarts the execution environment.
- Lambda reserves port 9001. There are no other port number restrictions or recommendations.

Buffering configuration

Lambda can buffer logs and deliver them to the subscriber. You can configure this behavior in the subscription request by specifying the following optional fields. Note that Lambda uses the default value for any field that you do not specify.

- **timeoutMs** – The maximum time (in milliseconds) to buffer a batch. Default: 1,000. Minimum: 25. Maximum: 30,000.
- **maxBytes** – The maximum size (in bytes) of the logs to buffer in memory. Default: 262,144. Minimum: 262,144. Maximum: 1,048,576.

- **maxItems** – The maximum number of events to buffer in memory. Default: 10,000. Minimum: 1,000. Maximum: 10,000.

During buffering configuration, note the following points:

- Lambda flushes the logs if any of the input streams are closed, for example, if the runtime crashes.
- Each subscriber can specify a different buffering configuration in their subscription request.
- Consider the buffer size that you need for reading the data. Expect to receive payloads as large as $2 * \text{maxBytes} + \text{metadata}$, where `maxBytes` is configured in the subscribe request. For example, Lambda adds the following metadata bytes to each record:

```
{
  "time": "2020-08-20T12:31:32.123Z",
  "type": "function",
  "record": "Hello World"
}
```

- If the subscriber cannot process incoming logs quickly enough, Lambda might drop logs to keep memory utilization bounded. To indicate the number of dropped records, Lambda sends a `platform.logsDropped` log. For more information, see [the section called “Lambda: Not all of my function's logs appear”](#).

Example subscription

The following example shows a request to subscribe to the platform and function logs.

```
PUT http://${AWS_LAMBDA_RUNTIME_API}/2020-08-15/logs HTTP/1.1
{ "schemaVersion": "2020-08-15",
  "types": [
    "platform",
    "function"
  ],
  "buffering": {
    "maxItems": 1000,
    "maxBytes": 262144,
    "timeoutMs": 100
  },
  "destination": {
```

```
"protocol": "HTTP",
"URI": "http://sandbox.localdomain:8080/lambda_logs"
}
}
```

If the request succeeds, the subscriber receives an HTTP 200 success response.

```
HTTP/1.1 200 OK
"OK"
```

Sample code for Logs API

For sample code showing how to send logs to a custom destination, see [Using AWS Lambda extensions to send logs to custom destinations](#) on the AWS Compute Blog.

For Python and Go code examples showing how to develop a basic Lambda extension and subscribe to the Logs API, see [AWS Lambda Extensions](#) on the AWS Samples GitHub repository. For more information about building a Lambda extension, see [the section called "Extensions API"](#).

Logs API reference

You can retrieve the Logs API endpoint from the `AWS_LAMBDA_RUNTIME_API` environment variable. To send an API request, use the prefix `2020-08-15/` before the API path. For example:

```
http://${AWS_LAMBDA_RUNTIME_API}/2020-08-15/logs
```

The OpenAPI specification for the Logs API version **2020-08-15** is available here: [logs-api-request.zip](#)

Subscribe

To subscribe to one or more of the log streams available in the Lambda execution environment, extensions send a Subscribe API request.

Path – `/logs`

Method – `PUT`

Body parameters

`destination` – See [the section called "Destination protocols"](#). Required: yes. Type: strings.

`buffering` – See [the section called “Buffering configuration”](#). Required: no. Type: strings.

`types` – An array of the types of logs to receive. Required: yes. Type: array of strings. Valid values: "platform", "function", "extension".

`schemaVersion` – Required: no. Default value: "2020-08-15". Set to "2021-03-18" for the extension to receive [platform.runtimeDone](#) messages.

Response parameters

The OpenAPI specifications for the subscription responses version **2020-08-15** are available for the HTTP and TCP protocols:

- HTTP: [logs-api-http-response.zip](#)
- TCP: [logs-api-tcp-response.zip](#)

Response codes

- 200 – Request completed successfully
- 202 – Request accepted. Response to a subscription request during local testing.
- 4XX – Bad Request
- 500 – Service error

If the request succeeds, the subscriber receives an HTTP 200 success response.

```
HTTP/1.1 200 OK
"OK"
```

If the request fails, the subscriber receives an error response. For example:

```
HTTP/1.1 400 OK
{
  "errorType": "Logs.ValidationError",
  "errorMessage": "URI port is not provided; types should not be empty"
}
```

Log messages

The Logs API allows extensions to subscribe to three different logs streams:

- **Function** – Logs that the Lambda function generates and writes to `stdout` or `stderr`.
- **Extension** – Logs that extension code generates.
- **Platform** – Logs that the runtime platform generates, which record events and errors related to invocations and extensions.

Topics

- [Function logs](#)
- [Extension logs](#)
- [Platform logs](#)

Function logs

The Lambda function and internal extensions generate function logs and write them to `stdout` or `stderr`.

The following example shows the format of a function log message. { "time": "2020-08-20T12:31:32.123Z", "type": "function", "record": "ERROR encountered. Stack trace:\n\nmy-function (line 10)\n" }

Extension logs

Extensions can generate extension logs. The log format is the same as for a function log.

Platform logs

Lambda generates log messages for platform events such as `platform.start`, `platform.end`, and `platform.fault`.

Optionally, you can subscribe to the **2021-03-18** version of the Logs API schema, which includes the `platform.runtimeDone` log message.

Example platform log messages

The following example shows the platform start and platform end logs. These logs indicate the invocation start time and invocation end time for the invocation that the `requestId` specifies.

```
{  
  "time": "2020-08-20T12:31:32.123Z",
```

```
"type": "platform.start",
"record": {"requestId": "6f7f0961f83442118a7af6fe80b88d56"}
}
{
"time": "2020-08-20T12:31:32.123Z",
"type": "platform.end",
"record": {"requestId": "6f7f0961f83442118a7af6fe80b88d56"}
}
```

The **platform.initRuntimeDone** log message shows the status of the Runtime `init` sub-phase, which is part of the [Init lifecycle phase](#). When Runtime `init` is successful, the runtime sends a /next runtime API request (for the on-demand and provisioned-concurrency initialization types) or `restore/next` (for the `snap-start` initialization type). The following example shows a successful **platform.initRuntimeDone** log message for the `snap-start` initialization type.

```
{
"time":"2022-07-17T18:41:57.083Z",
"type":"platform.initRuntimeDone",
"record":{"
"initializationType":"snap-start",
"status":"success"
}
}
```

The **platform.initReport** log message shows how long the `Init` phase lasted and how many milliseconds you were billed for during this phase. When the initialization type is `provisioned-concurrency`, Lambda sends this message during invocation. When the initialization type is `snap-start`, Lambda sends this message after restoring the snapshot. The following example shows a **platform.initReport** log message for the `snap-start` initialization type.

```
{
"time":"2022-07-17T18:41:57.083Z",
"type":"platform.initReport",
"record":{"
"initializationType":"snap-start",
"metrics":{"
"durationMs":731.79,
"billedDurationMs":732
}
}
}
```

The platform report log includes metrics about the invocation that the `requestId` specifies. The `initDurationMs` field is included in the log only if the invocation included a cold start. If AWS X-Ray tracing is active, the log includes X-Ray metadata. The following example shows a platform report log for an invocation that included a cold start.

```
{
  "time": "2020-08-20T12:31:32.123Z",
  "type": "platform.report",
  "record": {"requestId": "6f7f0961f83442118a7af6fe80b88d56",
    "metrics": {"durationMs": 101.51,
      "billedDurationMs": 300,
      "memorySizeMB": 512,
      "maxMemoryUsedMB": 33,
      "initDurationMs": 116.67
    }
  }
}
```

The platform fault log captures runtime or execution environment errors. The following example shows a platform fault log message.

```
{
  "time": "2020-08-20T12:31:32.123Z",
  "type": "platform.fault",
  "record": "RequestId: d783b35e-a91d-4251-af17-035953428a2c Process exited before
  completing request"
}
```

Note

AWS is currently implementing changes to the Lambda service. Due to these changes, you may see minor differences between the structure and content of system log messages and trace segments emitted by different Lambda functions in your AWS account.

One of the log outputs affected by this change is the platform fault log `record` field. The following examples show illustrative `record` fields in the old and new formats. The new style of fault log contains a more concise message

These changes will be implemented during the coming weeks, and all functions in all AWS Regions except the China and GovCloud regions will transition to use the new-format log messages and trace segments.

Example platform fault log record (old style)

```
"record": "RequestId: ... \tError: Runtime exited with error: exit status 255\nRuntime.ExitError"
```

Example platform fault log record (new style)

```
"record": "RequestId: ... Status: error \tErrorType: Runtime.ExitError"
```

Lambda generates a platform extension log when an extension registers with the extensions API. The following example shows a platform extension message.

```
{
  "time": "2020-08-20T12:31:32.123Z",
  "type": "platform.extension",
  "record": {"name": "Foo.bar",
    "state": "Ready",
    "events": ["INVOKE", "SHUTDOWN"]}
}
```

Lambda generates a platform logs subscription log when an extension subscribes to the logs API. The following example shows a logs subscription message.

```
{
  "time": "2020-08-20T12:31:32.123Z",
  "type": "platform.logsSubscription",
  "record": {"name": "Foo.bar",
    "state": "Subscribed",
    "types": ["function", "platform"]},
}
```

Lambda generates a platform logs dropped log when an extension is not able to process the number of logs that it is receiving. The following example shows a `platform.logsDropped` log message.

```
{
  "time": "2020-08-20T12:31:32.123Z",
```



```
    "type": "platform.logsDropped",
    "record": {"reason": "Consumer seems to have fallen behind as it has not
acknowledged receipt of logs.",
      "droppedRecords": 123,
      "droppedBytes": 12345
    }
  }
```

The **platform.restoreStart** log message shows the time that the Restore phase started (snap-start initialization type only). Example:

```
{
  "time": "2022-07-17T18:43:44.782Z",
  "type": "platform.restoreStart",
  "record": {}
}
```

The **platform.restoreReport** log message shows how long the Restore phase lasted and how many milliseconds you were billed for during this phase (snap-start initialization type only). Example:

```
{
  "time": "2022-07-17T18:43:45.936Z",
  "type": "platform.restoreReport",
  "record": {
    "metrics": {
      "durationMs": 70.87,
      "billedDurationMs": 13
    }
  }
}
```

Platform runtimeDone messages

If you set the schema version to "2021-03-18" in the subscribe request, Lambda sends a `platform.runtimeDone` message after the function invocation completes either successfully or with an error. The extension can use this message to stop all the telemetry collection for this function invocation.

The OpenAPI specification for the Log event type in schema version **2021-03-18** is available here: [schema-2021-03-18.zip](#)

Lambda generates the `platform.runtimeDone` log message when the runtime sends a `Next` or `Error` runtime API request. The `platform.runtimeDone` log informs consumers of the Logs API that the function invocation completes. Extensions can use this information to decide when to send all the telemetry collected during that invocation.

Examples

Lambda sends the `platform.runtimeDone` message after the runtime sends the `NEXT` request when the function invocation completes. The following examples show messages for each of the status values: `success`, `failure`, and `timeout`.

Example Example success message

```
{
  "time": "2021-02-04T20:00:05.123Z",
  "type": "platform.runtimeDone",
  "record": {
    "requestId": "6f7f0961f83442118a7af6fe80b88",
    "status": "success"
  }
}
```

Example Example failure message

```
{
  "time": "2021-02-04T20:00:05.123Z",
  "type": "platform.runtimeDone",
  "record": {
    "requestId": "6f7f0961f83442118a7af6fe80b88",
    "status": "failure"
  }
}
```

Example Example timeout message

```
{
  "time": "2021-02-04T20:00:05.123Z",
  "type": "platform.runtimeDone",
  "record": {
    "requestId": "6f7f0961f83442118a7af6fe80b88",
    "status": "timeout"
  }
}
```

```
}  
}
```

Example Example `platform.restoreRuntimeDone` message (snap-start initialization type only)

The `platform.restoreRuntimeDone` log message shows whether or not the Restore phase was successful. Lambda sends this message when the runtime sends a `restore/next` runtime API request. There are three possible statuses: `success`, `failure`, and `timeout`. The following example shows a successful `platform.restoreRuntimeDone` log message.

```
{  
  "time": "2022-07-17T18:43:45.936Z",  
  "type": "platform.restoreRuntimeDone",  
  "record": {  
    "status": "success"  
  }  
}
```

Troubleshooting issues in Lambda

The following topics provide troubleshooting advice for errors and issues that you might encounter when using the Lambda API, console, or tools. If you find an issue that is not listed here, you can use the **Feedback** button on this page to report it.

For more troubleshooting advice and answers to common support questions, visit the [AWS Knowledge Center](#).

For more information about debugging and troubleshooting Lambda applications, see [Debugging](#) in Serverless Land.

Topics

- [Troubleshoot configuration issues in Lambda](#)
- [Troubleshoot deployment issues in Lambda](#)
- [Troubleshoot invocation issues in Lambda](#)
- [Troubleshoot execution issues in Lambda](#)
- [Troubleshoot event source mapping issues in Lambda](#)
- [Troubleshoot networking issues in Lambda](#)

Troubleshoot configuration issues in Lambda

Your function configuration settings can have an impact on the overall performance and behavior of your Lambda function. These may not cause actual function errors, but can cause unexpected timeouts and results.

The following topics provide troubleshooting advice for common issues that you might encounter related to Lambda function configuration settings.

Topics

- [Memory configurations](#)
- [CPU-bound configurations](#)
- [Timeouts](#)
- [Memory leakage between invocations](#)
- [Asynchronous results returned to a later invocation](#)

Memory configurations

You can configure a Lambda function to use between 128 MB and 10,240 MB of memory. By default, any function created in the console is assigned the smallest amount of memory. Many Lambda functions are performant at this lowest setting. However, if you are importing large code libraries or completing memory intensive tasks, 128 MB is not sufficient.

If your functions are running much slower than expected, the first step is to increase the memory setting. For memory-bound functions, this will resolve the bottleneck and may improve the performance of your function.

CPU-bound configurations

For compute-intensive operations, if your function experiences slower-than-expected performance, this may be due to your function being CPU-bound. In this case, the computational capacity of the function cannot keep pace with the work.

While Lambda doesn't allow you to modify CPU configuration directly, CPU is indirectly controlled via the memory settings. The Lambda service proportionally allocates more virtual CPU as you allocate more memory. At 1.8 GB memory, a Lambda function has an entire vCPU allocated, and above this level it has access to more than one vCPU core. At 10,240MB, it has 6 vCPUs available. In other words, you can improve performance by increasing the memory allocation, even if the function doesn't use all of the memory.

Timeouts

[Timeouts](#) for Lambda functions can be set between 1 and 900 seconds (15 minutes). By default, the Lambda console sets this to 3 seconds. The timeout value is a safety valve that ensures functions do not run indefinitely. After the timeout value is reached, Lambda stops the function invocation.

If a timeout value is set close to the average duration of a function, this increases the risk that the function will time out unexpectedly. The duration of a function can vary based on the amount of data transfer and processing, and the latency of any services the function interacts with. Common causes of timeout include:

- When downloading data from S3 buckets or other data stores, the download is larger or takes longer than average.

- A function makes a request to another service, which takes longer to respond.
- The parameters provided to a function require more computational complexity in the function, which causes the invocation to take longer.

When testing your application, ensure that your tests accurately reflect the size and quantity of data, and realistic parameter values. Importantly, use datasets at the upper bounds of what is reasonably expected for your workload.

Additionally, implement upper-bound limits in your workload wherever practical. In this example, the application could use a maximum size limit for each file type. You can then test the performance of your application for a range of expected file sizes, up to and including the maximum limits.

Memory leakage between invocations

Global variables and objects stored in the INIT phase of a Lambda invocation retain their state between warm invocations. They are completely reset only when the execution environment is run for the first time (also known as a “cold start”). Any variables stored in the handler are destroyed when the handler exits. It’s best practice to use the INIT phase to set up database connections, load libraries, create caches, and load immutable assets.

When you use third-party libraries across multiple invocations in the same execution environment, check their documentation for usage in a serverless compute environment. Some database connection and logging libraries may save intermediate invocation results and other data. This causes the memory usage of these libraries to grow with subsequent warm invocations. If this is the case, you may find the Lambda function runs out of memory, even if your custom code is disposing of variables correctly.

This issue affects invocations occurring in warm execution environments. For example, the following code creates a memory leak between invocations. The Lambda function consumes additional memory with each invocation by increasing the size of a global array:

```
let a = []

exports.handler = async (event) => {
  a.push(Array(100000).fill(1))
}
```

Configured with 128 MB of memory, after invoking this function 1000 times, the **Monitoring** tab of the Lambda function shows the typical changes in invocations, duration, and error counts when a memory leak occurs:

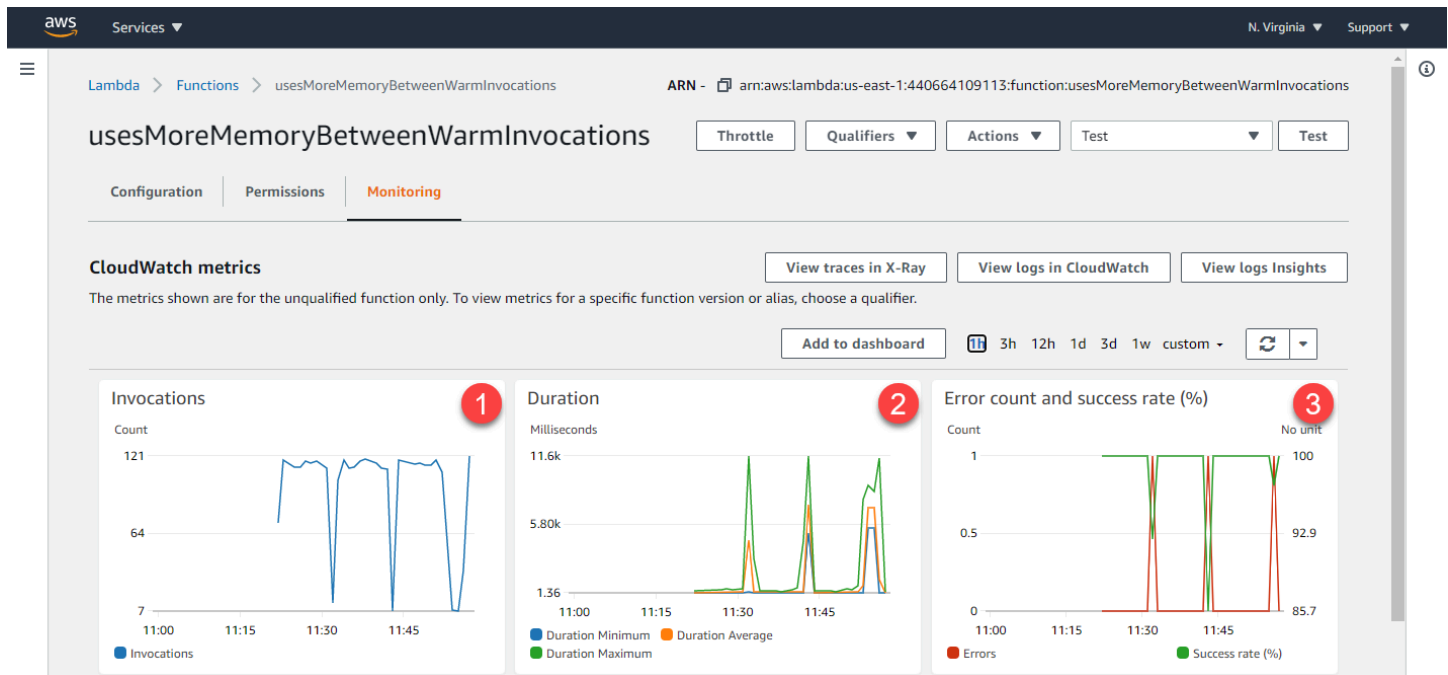

- 1. Invocations** – A steady transaction rate is interrupted periodically as the invocations take longer to complete. During the steady state, the memory leak is not consuming all of the function's allocated memory. As performance degrades, the operating system is paging local storage to accommodate the growing memory required by the function, which results in fewer transactions being completed.
- 2. Duration** – Before the function runs out of memory, it finishes invocations at a steady double-digit millisecond rate. As paging occurs, the duration takes an order of magnitude longer.
- 3. Error count** – As the memory leak exceeds allocated memory, eventually the function errors due to the computation exceeding the timeout, or the execution environment stops the function.

After the error, Lambda restarts the execution environment, which explains why all three graphs show a return to the original state. Expanding the CloudWatch metrics for duration provides more detail for the minimum, maximum and average duration statistics:

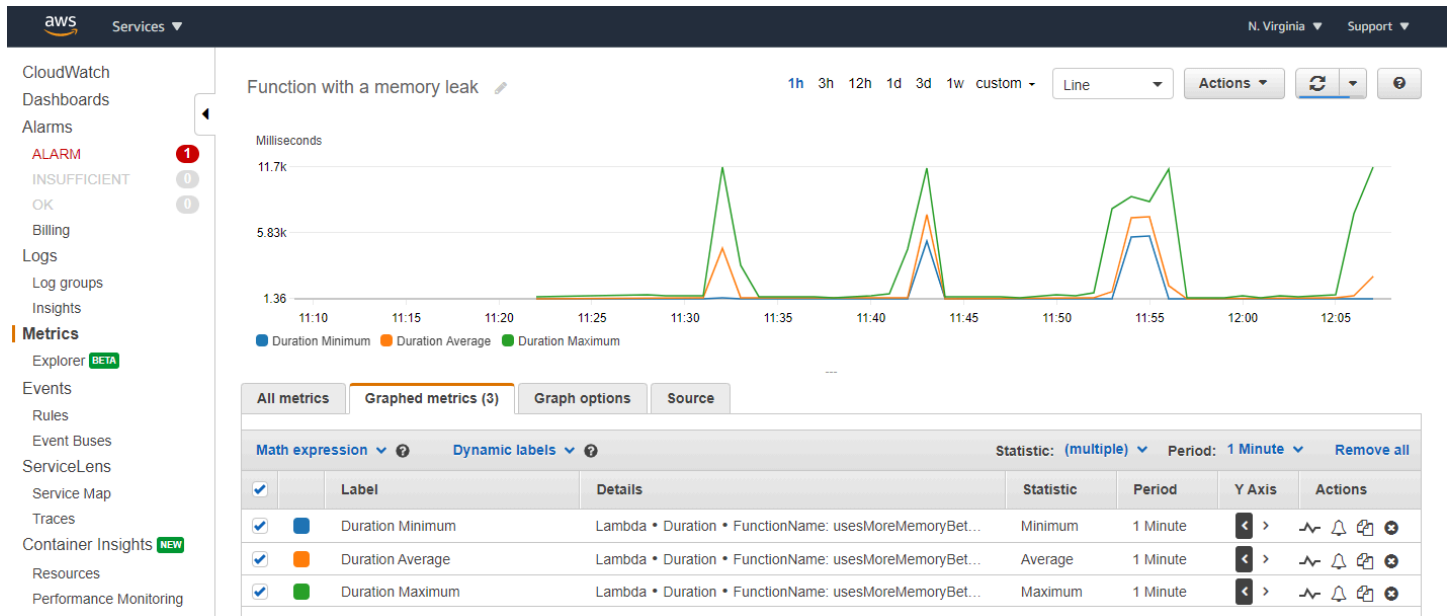

To find the errors generated across the 1000 invocations, you can use the CloudWatch Insights query language. The following query excludes informational logs to report only the errors:

```
fields @timestamp, @message
| sort @timestamp desc
| filter @message not like 'EXTENSION'
| filter @message not like 'Lambda Insights'
| filter @message not like 'INFO'
| filter @message not like 'REPORT'
| filter @message not like 'END'
| filter @message not like 'START'
```

When run against the log group for this function, this shows that timeouts were responsible for the periodic errors:

The screenshot shows the AWS CloudWatch Logs Insights interface. The query is:

```

1 fields @timestamp, @message
2 | sort @timestamp desc
3 | filter @message not like 'EXTENSION'
4 | filter @message not like 'Lambda Insights'
5 | filter @message not like 'INFO'
6 | filter @message not like 'REPORT'
7 | filter @message not like 'END'
8 | filter @message not like 'START'
9 | limit 20

```

The results table shows the following records:

#	@timestamp	@message
1	2020-10-14T08:07:46.36...	2020-10-14T12:07:46.361Z 1917d63d-ccf5-4547-987a-1fecb4e9447f Task timed out after 11.65 seconds
2	2020-10-14T07:56:39.57...	2020-10-14T11:56:39.579Z 1a00b31d-86cb-42e6-b916-eb57c3d3b69a Task timed out after 11.45 seconds
3	2020-10-14T07:44:00.65...	2020-10-14T11:44:00.652Z 43644f33-8dec-4cea-87c5-a92a8c2da8cf Task timed out after 11.56 seconds
4	2020-10-14T07:33:05.92...	2020-10-14T11:33:05.929Z abab510c-92a3-4b69-8be7-a62b23876418 Task timed out after 11.61 seconds

Asynchronous results returned to a later invocation

For function code that uses asynchronous patterns, it's possible for the callback results from one invocation to be returned in a future invocation. This example uses Node.js, but the same logic can apply to other runtimes using asynchronous patterns. The function uses the traditional callback syntax in JavaScript. It calls an asynchronous function with an incremental counter that tracks the number of invocations:

```

let seqId = 0

exports.handler = async (event, context) => {
  console.log(`Starting: sequence Id=${++seqId}`)
  doWork(seqId, function(id) {
    console.log(`Work done: sequence Id=${id}`)
  })
}

function doWork(id, callback) {
  setTimeout(() => callback(id), 3000)
}

```

}

When invoked several times in succession, the results of the callbacks occur in subsequent invocations:

The screenshot displays the AWS Lambda console interface for a function named 'delayedAsyncReturn'. The function code in `index.js` is as follows:

```

1 let seqId = 0;
2
3 exports.handler = async (event) => {
4   console.log(`Starting: sequence Id=${++seqId}`)
5   doWork(seqId, function(id) {
6     console.log(`Work done: sequence Id=${id}`)
7   })
8 }
9
10 function doWork(id, callback) {
11   setTimeout(() => callback(id), 3000)
12 }

```

The execution results show three invocations. The logs for the third invocation are displayed first, indicating that the event loop processes pending callbacks from previous invocations before starting the current one:

```

Function logs:
START RequestId: 6afdf887-424a-4ec6-b622-3ffc07eebb64 Version: $LATEST
2020-10-13T19:22:38.586Z 6afdf887-424a-4ec6-b622-3ffc07eebb64 INFO Starting: sequence Id=5
2020-10-13T19:22:38.587Z 6afdf887-424a-4ec6-b622-3ffc07eebb64 INFO Work done: sequence Id=2
2020-10-13T19:22:38.587Z 6afdf887-424a-4ec6-b622-3ffc07eebb64 INFO Work done: sequence Id=3
END RequestId: 6afdf887-424a-4ec6-b622-3ffc07eebb64
REPORT RequestId: 6afdf887-424a-4ec6-b622-3ffc07eebb64 Duration: 1.54 ms Billed Duration: 100 ms Memory Size: 128 MB Max Memory Used: 64 MB

```

1. The code calls the `doWork` function, providing a callback function as the last parameter.
2. The `doWork` function takes some period of time to complete before invoking the callback.
3. The function's logging indicates that the invocation is ending before the `doWork` function finishes execution. Additionally, after starting an iteration, callbacks from previous iterations are being processed, as shown in the logs.

In JavaScript, asynchronous callbacks are handled with an [event loop](#). Other runtimes use different mechanisms to handle concurrency. When the function's execution environment ends, Lambda freezes the environment until the next invocation. After it resumes, JavaScript continues processing the event loop, which in this case includes an asynchronous callback from a previous invocation. Without this context, it can appear that the function is running code for no reason, and returning arbitrary data. In fact, it is really an artifact of how runtime concurrency and the execution environments interact.

This creates the potential for private data from a previous invocation to appear in a subsequent invocation. There are two ways to prevent or detect this behavior. First, JavaScript provides the

[async and await keywords](#) to simplify asynchronous development and also force code execution to wait for an asynchronous call to complete. The function above can be rewritten using this approach as follows:

```
let seqId = 0
exports.handler = async (event) => {
  console.log(`Starting: sequence Id=${++seqId}`)
  const result = await doWork(seqId)
  console.log(`Work done: sequence Id=${result}`)
}

function doWork(id) {
  return new Promise(resolve => {
    setTimeout(() => resolve(id), 4000)
  })
}
```

Using this syntax prevents the handler from exiting before the asynchronous function is finished. In this case, if the callback takes longer than the Lambda function's timeout, the function will throw an error, instead of returning the callback result in a later invocation:

The screenshot displays the AWS Lambda console interface. At the top, there are buttons for 'Deploy' and 'Actions'. Below that is a menu bar with 'File', 'Edit', 'Find', 'View', 'Go', 'Tools', 'Window', 'Test', and 'Deploy'. The main area shows the function code for 'index.js' with three red circles highlighting specific parts: circle 1 is on the 'await doWork(seqId)' line, circle 2 is on the 'setTimeout' line, and circle 3 is on the error message in the execution results. The execution results show a 'Failed' status with a 'Task timed out after 3.00 seconds' error. The function logs show the start and end of the function execution, including the request ID and duration.

```
Function code Info Deploy Actions
```

```
File Edit Find View Go Tools Window Test Deploy
```

```
Environment
```

```
es6-js.js index.js
```

```
1 let seqId = 0
2
3 exports.handler = async (event) => {
4   console.log(`Starting: sequence Id=${++seqId}`)
5   const result = await doWork(seqId)
6   console.log(`Work done: sequence Id=${result}`)
7 }
8
9 function doWork(id) {
10  return new Promise(resolve => {
11    setTimeout(() => resolve(id), 4000)
12  })
13 }
```

```
Execution Result
```

```
Status: Failed Max Memory Used: 64 MB Time: 3003.72 ms Execution results
```

```
Response:
{
  "errorMessage": "2020-10-14T12:25:33.709Z 0d4a1340-e9ce-47c2-8034-e35ec9cb1c9b Task timed out after 3.00 seconds"
}

Request ID:
"0d4a1340-e9ce-47c2-8034-e35ec9cb1c9b"

Function logs:
START RequestId: 0d4a1340-e9ce-47c2-8034-e35ec9cb1c9b Version: $LATEST
2020-10-14T12:25:30.707Z 0d4a1340-e9ce-47c2-8034-e35ec9cb1c9b INFO Starting: sequence Id=1
END RequestId: 0d4a1340-e9ce-47c2-8034-e35ec9cb1c9b
REPORT RequestId: 0d4a1340-e9ce-47c2-8034-e35ec9cb1c9b Duration: 3003.72 ms Billed Duration: 3000 ms Memory Size: 128 MB Max Memory Used: 64 MB
2020-10-14T12:25:33.709Z 0d4a1340-e9ce-47c2-8034-e35ec9cb1c9b Task timed out after 3.00 seconds
```

1. The code calls the asynchronous `doWork` function using the `await` keyword in the handler.

2. The `doWork` function takes some period of time to complete before resolving the promise.
3. The function times out because `doWork` takes longer than the timeout limit allows and the callback result is not returned in a later invocation.

Generally, you should make sure any background processes or callbacks in the code are complete before the code exits. If this is not possible in your use case, you can use an identifier to ensure that the callback belongs to the current invocation. To do this, you can use the `awsRequestId` provided by the context object. By passing this value to the asynchronous callback, you can compare the passed value with the current value to detect if the callback originated from another invocation:

```
let currentContext

exports.handler = async (event, context) => {
  console.log(`Starting: request id=${context.awsRequestId}`)
  currentContext = context

  doWork(context.awsRequestId, function(id) {
    if (id !== currentContext.awsRequestId) {
      console.info(`This callback is from another invocation.`)
    }
  })
}

function doWork(id, callback) {
  setTimeout(() => callback(id), 3000)
}
```

The screenshot shows the AWS Lambda console interface. At the top, there are 'Function code' and 'Info' tabs, along with 'Deploy' and 'Actions' buttons. Below this is a menu bar with 'File', 'Edit', 'Find', 'View', 'Go', 'Tools', 'Window', 'Test', and 'Deploy'. The main area is divided into two panes. The top pane shows the code editor for 'index.js' with the following code:

```

1 let currentContext
2
3 exports.handler = async (event, context) => {
4   console.log(`Starting: request id=${context.awsRequestId}`)
5   currentContext = context
6
7   doWork(context.awsRequestId, function(id) {
8     if (id !== currentContext.awsRequestId) {
9       console.info(`This callback is from another invocation.`)
10    }
11  })
12 }
13
14 function doWork(id, callback) {
15   setTimeout(() => callback(id), 3000)
16 }
17

```

Two red circles with numbers 1 and 2 are overlaid on the code. Circle 1 is positioned over the 'context' parameter in the handler function signature. Circle 2 is positioned over the 'context.awsRequestId' property access in the log statement and the 'doWork' function call.

The bottom pane shows the 'Execution Result' for a successful invocation. The status is 'Succeeded', Max Memory Used is 65 MB, and Time is 1.28 ms. The response is 'null'. The request ID is 'aa137379-9c11-4e8d-b45b-895930ecca46'. The function logs show the following output:

```

Function logs:
START RequestId: aa137379-9c11-4e8d-b45b-895930ecca46 Version: $LATEST
2020-10-14T12:50:46.765Z aa137379-9c11-4e8d-b45b-895930ecca46 INFO Starting: request id=aa137379-9c11-4e8d-b45b-895930ecca46
2020-10-14T12:50:46.766Z aa137379-9c11-4e8d-b45b-895930ecca46 INFO This callback is from another invocation.
END RequestId: aa137379-9c11-4e8d-b45b-895930ecca46
REPORT RequestId: aa137379-9c11-4e8d-b45b-895930ecca46 Duration: 1.28 ms Billed Duration: 100 ms Memory Size: 128 MB Max Memory Used: 65 MB

```

1. The Lambda function handler takes the context parameter, which provides access to a unique invocation request ID.
2. The `awsRequestId` is passed to the `doWork` function. In the callback, the ID is compared with the `awsRequestId` of the current invocation. If these values are different, the code can take action accordingly.

Troubleshoot deployment issues in Lambda

When you update your function, Lambda deploys the change by launching new instances of the function with the updated code or settings. Deployment errors prevent the new version from being used and can arise from issues with your deployment package, code, permissions, or tools.

When you deploy updates to your function directly with the Lambda API or with a client such as the AWS CLI, you can see errors from Lambda directly in the output. If you use services like AWS CloudFormation, AWS CodeDeploy, or AWS CodePipeline, look for the response from Lambda in the logs or event stream for that service.

The following topics provide troubleshooting advice for errors and issues that you might encounter when using the Lambda API, console, or tools. If you find an issue that is not listed here, you can use the **Feedback** button on this page to report it.

For more troubleshooting advice and answers to common support questions, visit the [AWS Knowledge Center](#).

For more information about debugging and troubleshooting Lambda applications, see [Debugging](#) in Serverless Land.

Topics

- [General: Permission is denied / Cannot load such file](#)
- [General: Error occurs when calling the UpdateFunctionCode](#)
- [Amazon S3: Error Code PermanentRedirect.](#)
- [General: Cannot find, cannot load, unable to import, class not found, no such file or directory](#)
- [General: Undefined method handler](#)
- [General: Lambda code storage limit exceeded](#)
- [Lambda: Layer conversion failed](#)
- [Lambda: InvalidParameterValueException or RequestEntityTooLargeException](#)
- [Lambda: InvalidParameterValueException](#)
- [Lambda: Concurrency and memory quotas](#)

General: Permission is denied / Cannot load such file

Error: *EACCES: permission denied, open '/var/task/index.js'*

Error: *cannot load such file -- function*

Error: *[Errno 13] Permission denied: '/var/task/function.py'*

The Lambda runtime needs permission to read the files in your deployment package. In Linux permissions octal notation, Lambda needs 644 permissions for non-executable files (rw-r--r--) and 755 permissions (rwxr-xr-x) for directories and executable files.

In Linux and MacOS, use the `chmod` command to change file permissions on files and directories in your deployment package. For example, to give a non-executable file the correct permissions, run the following command.

```
chmod 644 <filepath>
```

To change file permissions in Windows, see [Set, View, Change, or Remove Permissions on an Object](#) in the Microsoft Windows documentation.

Note

If you don't grant Lambda the permissions it needs to access directories in your deployment package, Lambda sets the permissions for those directories to 755 (rwxr-xr-x).

General: Error occurs when calling the UpdateFunctionCode

Error: *An error occurred (RequestEntityTooLargeException) when calling the UpdateFunctionCode operation*

When you upload a deployment package or layer archive directly to Lambda, the size of the ZIP file is limited to 50 MB. To upload a larger file, store it in Amazon S3 and use the S3Bucket and S3Key parameters.

Note

When you upload a file directly with the AWS CLI, AWS SDK, or otherwise, the binary ZIP file is converted to base64, which increases its size by about 30%. To allow for this, and the size of other parameters in the request, the actual request size limit that Lambda applies is larger. Due to this, the 50 MB limit is approximate.

Amazon S3: Error Code PermanentRedirect.

Error: *Error occurred while GetObject. S3 Error Code: PermanentRedirect. S3 Error Message: The bucket is in this region: us-east-2. Please use this region to retry the request*

When you upload a function's deployment package from an Amazon S3 bucket, the bucket must be in the same Region as the function. This issue can occur when you specify an Amazon S3 object in a call to [UpdateFunctionCode](#), or use the package and deploy commands in the AWS CLI or AWS SAM CLI. Create a deployment artifact bucket for each Region where you develop applications.

General: Cannot find, cannot load, unable to import, class not found, no such file or directory

Error: *Cannot find module 'function'*

Error: *cannot load such file -- function*

Error: *Unable to import module 'function'*

Error: *Class not found: function.Handler*

Error: *fork/exec /var/task/function: no such file or directory*

Error: *Unable to load type 'Function.Handler' from assembly 'Function'.*

The name of the file or class in your function's handler configuration doesn't match your code. See the following section for more information.

General: Undefined method handler

Error: *index.handler is undefined or not exported*

Error: *Handler 'handler' missing on module 'function'*

Error: *undefined method `handler' for #<LambdaHandler:0x000055b76cceb9f8>*

Error: *No public method named handleRequest with appropriate method signature found on class function.Handler*

Error: *Unable to find method 'handleRequest' in type 'Function.Handler' from assembly 'Function'*

The name of the handler method in your function's handler configuration doesn't match your code. Each runtime defines a naming convention for handlers, such as *filename.methodname*. The handler is the method in your function's code that the runtime runs when your function is invoked.

For some languages, Lambda provides a library with an interface that expects a handler method to have a specific name. For details about handler naming for each language, see the following topics.

- [Building Lambda functions with Node.js](#)
- [Building Lambda functions with Python](#)
- [Building Lambda functions with Ruby](#)
- [Building Lambda functions with Java](#)

- [Building Lambda functions with Go](#)
- [Building Lambda functions with C#](#)
- [Building Lambda functions with PowerShell](#)

General: Lambda code storage limit exceeded

Error: *Code storage limit exceeded.*

Lambda stores your function code in an internal S3 bucket that's private to your account. Each AWS account is allocated 75 GB of storage in each Region. Code storage includes the total storage used by both Lambda functions and layers. If you reach the quota, you receive a `CodeStorageExceededException` when you attempt to deploy new functions.

Manage the storage space available by cleaning up old versions of functions, removing unused code, or using Lambda layers. In addition, it's good practice to [use separate AWS accounts for separate workloads](#) to help manage storage quotas.

You can view your total storage usage in the Lambda console, under the **Dashboard** submenu:

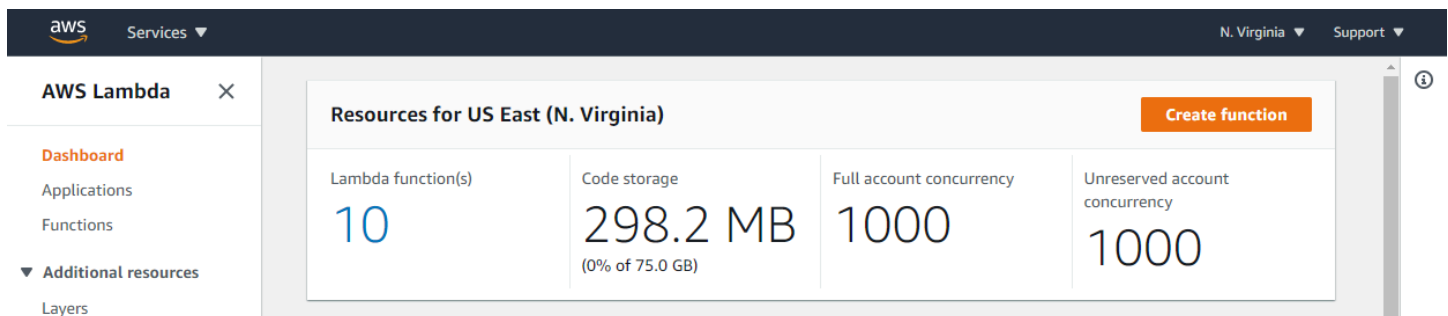

The screenshot shows the AWS Lambda console dashboard for the US East (N. Virginia) region. The dashboard displays the following resource usage:

Resource	Usage	Limit
Lambda function(s)	10	
Code storage	298.2 MB (0% of 75.0 GB)	
Full account concurrency	1000	
Unreserved account concurrency	1000	

The dashboard also includes a 'Create function' button and a navigation menu on the left with options like 'Dashboard', 'Applications', 'Functions', and 'Additional resources'.

Lambda: Layer conversion failed

Error: *Lambda layer conversion failed. For advice on resolving this issue, see the Troubleshoot deployment issues in Lambda page in the Lambda User Guide.*

When you configure a Lambda function with a layer, Lambda merges the layer with your function code. If this process fails to complete, Lambda returns this error. If you encounter this error, take the following steps:

- Delete any unused files from your layer
- Delete any symbolic links in your layer
- Rename any files that have the same name as a directory in any of your function's layers

Lambda: InvalidParameterValueException or RequestEntityTooLargeException

Error: *InvalidParameterValueException: Lambda was unable to configure your environment variables because the environment variables you have provided exceeded the 4KB limit. String measured: {"A1":"uSFeY5cyPiPn7AtnX5BsM...*

Error: *RequestEntityTooLargeException: Request must be smaller than 5120 bytes for the UpdateFunctionConfiguration operation*

The maximum size of the variables object that is stored in the function's configuration must not exceed 4096 bytes. This includes key names, values, quotes, commas, and brackets. The total size of the HTTP request body is also limited.

```
{
  "FunctionName": "my-function",
  "FunctionArn": "arn:aws:lambda:us-east-2:123456789012:function:my-function",
  "Runtime": "nodejs22.x",
  "Role": "arn:aws:iam::123456789012:role/lambda-role",
  "Environment": {
    "Variables": {
      "BUCKET": "amzn-s3-demo-bucket",
      "KEY": "file.txt"
    }
  },
  ...
}
```

In this example, the object is 39 characters and takes up 39 bytes when it's stored (without white space) as the string {"BUCKET": "amzn-s3-demo-bucket", "KEY": "file.txt"}. Standard ASCII characters in environment variable values use one byte each. Extended ASCII and Unicode characters can use between 2 bytes and 4 bytes per character.

Lambda: InvalidParameterValueException

Error: *InvalidParameterValueException: Lambda was unable to configure your environment variables because the environment variables you have provided contains reserved keys that are currently not supported for modification.*

Lambda reserves some environment variable keys for internal use. For example, AWS_REGION is used by the runtime to determine the current Region and cannot be overridden. Other variables,

like `PATH`, are used by the runtime but can be extended in your function configuration. For a full list, see [Defined runtime environment variables](#).

Lambda: Concurrency and memory quotas

Error: *Specified ConcurrentExecutions for function decreases account's UnreservedConcurrentExecution below its minimum value*

Error: *'MemorySize' value failed to satisfy constraint: Member must have value less than or equal to 3008*

These errors occur when you exceed the concurrency or memory [quotas](#) for your account. New AWS accounts have reduced concurrency and memory quotas. To resolve errors related to concurrency, you can [request a quota increase](#). You cannot request memory quota increases.

- **Concurrency:** You might get an error if you try to create a function using reserved or provisioned concurrency, or if your per-function concurrency request ([PutFunctionConcurrency](#)) exceeds your account's concurrency quota.
- **Memory:** Errors occur if the amount of memory allocated to the function exceeds your account's memory quota.

Troubleshoot invocation issues in Lambda

When you invoke a Lambda function, Lambda validates the request and checks for scaling capacity before sending the event to your function or, for asynchronous invocation, to the event queue. Invocation errors can be caused by issues with request parameters, event structure, function settings, user permissions, resource permissions, or limits.

If you invoke your function directly, you see any invocation errors in the response from Lambda. If you invoke your function asynchronously with an event source mapping or through another service, you might find errors in logs, a dead-letter queue, or a failed-event destination. Error handling options and retry behavior vary depending on how you invoke your function and on the type of error.

For a list of error types that the `Invoke` operation can return, see [Invoke](#).

Topics

- [Lambda: Function times out during Init phase \(Sandbox.Timeout\)](#)

- [IAM: lambda:InvokeFunction not authorized](#)
- [Lambda: Couldn't find valid bootstrap \(Runtime.InvalidEntrypoint\)](#)
- [Lambda: Operation cannot be performed ResourceConflictException](#)
- [Lambda: Function is stuck in Pending](#)
- [Lambda: One function is using all concurrency](#)
- [General: Cannot invoke function with other accounts or services](#)
- [General: Function invocation is looping](#)
- [Lambda: Alias routing with provisioned concurrency](#)
- [Lambda: Cold starts with provisioned concurrency](#)
- [Lambda: Cold starts with new versions](#)
- [EFS: Function could not mount the EFS file system](#)
- [EFS: Function could not connect to the EFS file system](#)
- [EFS: Function could not mount the EFS file system due to timeout](#)
- [Lambda: Lambda detected an IO process that was taking too long](#)

Lambda: Function times out during Init phase (Sandbox.Timedout)

Error: *Task timed out after 3.00 seconds*

When the [Init](#) phase times out, Lambda initializes the execution environment again by re-running the `Init` phase when the next invoke request arrives. This is called a [suppressed init](#). However, if your function is configured with a short [timeout duration](#) (generally around 3 seconds), the suppressed init might not complete during the allocated timeout duration, causing the `Init` phase to time out again. Alternatively, the suppressed init completes but does not leave enough time for the [Invoke](#) phase to complete, causing the `Invoke` phase to time out.

To reduce timeout errors, use one or more of the following strategies:

- **Increase the function timeout duration:** Extend the [timeout](#) to give the `Init` and `Invoke` phases time to complete successfully.
- **Increase the function memory allocation:** More [memory](#) also means more proportional CPU allocation, which can speed up both the `Init` and `Invoke` phases.
- **Optimize the function initialization code:** Reduce the time needed for initialization to ensure that the `Init` and `Invoke` phase can complete within the configured timeout.

- **Add error handling:** Proper error handling in the function code can prevent the Lambda execution environment from failing and triggering repeated initialization attempts.

IAM: lambda:InvokeFunction not authorized

Error: *User: arn:aws:iam::123456789012:user/developer is not authorized to perform: lambda:InvokeFunction on resource: my-function*

Your user, or the role that you assume, must have permission to invoke a function. This requirement also applies to Lambda functions and other compute resources that invoke functions. Add the AWS managed policy **AWSLambdaRole** to your user, or add a custom policy that allows the `lambda:InvokeFunction` action on the target function.

Note

The name of the IAM action (`lambda:InvokeFunction`) refers to the Invoke Lambda API operation.

For more information, see [Managing permissions in AWS Lambda](#).

Lambda: Couldn't find valid bootstrap (Runtime.InvalidEntryPoint)

Error: *Couldn't find valid bootstrap(s): [/var/task/bootstrap /opt/bootstrap]*

This error typically occurs when the root of your deployment package doesn't contain an executable file named `bootstrap`. For example, if you're deploying a provided .a12023 function with a .zip file, the `bootstrap` file must be at the root of the .zip file, not in a directory.

Lambda: Operation cannot be performed ResourceConflictException

Error: *ResourceConflictException: The operation cannot be performed at this time. The function is currently in the following state: Pending*

When you connect a function to a virtual private cloud (VPC) at the time of creation, the function enters a Pending state while Lambda creates elastic network interfaces. During this time, you can't invoke or modify your function. If you connect your function to a VPC after creation, you can invoke it while the update is pending, but you can't modify its code or configuration.

For more information, see [Lambda function states](#) .

Lambda: Function is stuck in Pending

Error: *A function is stuck in the Pending state for several minutes.*

If a function is stuck in the Pending state for more than six minutes, call one of the following API operations to unblock it:

- [UpdateFunctionCode](#)
- [UpdateFunctionConfiguration](#)
- [PublishVersion](#)

Lambda cancels the pending operation and puts the function into the Failed state. You can then attempt another update.

Lambda: One function is using all concurrency

Issue: *One function is using all of the available concurrency, causing other functions to be throttled.*

To divide your AWS account's available concurrency in an AWS Region into pools, use [reserved concurrency](#). Reserved concurrency ensures that a function can always scale to its assigned concurrency, and that it doesn't scale beyond its assigned concurrency.

General: Cannot invoke function with other accounts or services

Issue: *You can invoke your function directly, but it doesn't run when another service or account invokes it.*

You grant [other services](#) and accounts permission to invoke a function in the function's [resource-based policy](#). If the invoker is in another account, that user must also have [permission to invoke functions](#).

General: Function invocation is looping

Issue: *Function is invoked continuously in a loop.*

This typically occurs when your function manages resources in the same AWS service that triggers it. For example, it's possible to create a function that stores an object in an Amazon Simple Storage

Service (Amazon S3) bucket that's configured with a [notification that invokes the function again](#). To stop the function from running, reduce the available [concurrency](#) to zero, which throttles all future invocations. Then, identify the code path or configuration error that caused the recursive invocation. Lambda automatically detects and stops recursive loops for some AWS services and SDKs. For more information, see [the section called "Recursive loop detection"](#).

Lambda: Alias routing with provisioned concurrency

Issue: *Provisioned concurrency spillover invocations during alias routing.*

Lambda uses a simple probabilistic model to distribute the traffic between the two function versions. At low traffic levels, you might see a high variance between the configured and actual percentage of traffic on each version. If your function uses provisioned concurrency, you can avoid [spillover invocations](#) by configuring a higher number of provisioned concurrency instances during the time that alias routing is active.

Lambda: Cold starts with provisioned concurrency

Issue: *You see cold starts after enabling provisioned concurrency.*

When the number of concurrent executions on a function is less than or equal to the [configured level of provisioned concurrency](#), there shouldn't be any cold starts. To help you confirm if provisioned concurrency is operating normally, do the following:

- [Check that provisioned concurrency is enabled](#) on the function version or alias.

Note

Provisioned concurrency is not configurable on the unpublished [version of the function](#) (\$LATEST).

- Ensure that your triggers invoke the correct function version or alias. For example, if you're using Amazon API Gateway, check that API Gateway invokes the function version or alias with provisioned concurrency, not \$LATEST. To confirm that provisioned concurrency is being used, you can check the [ProvisionedConcurrencyInvocations Amazon CloudWatch metric](#). A non-zero value indicates that the function is processing invocations on initialized execution environments.
- Determine whether your function concurrency exceeds the configured level of provisioned concurrency by checking the [ProvisionedConcurrencySpilloverInvocations CloudWatch metric](#). A

non-zero value indicates that all provisioned concurrency is in use and some invocation occurred with a cold start.

- Check your [invocation frequency](#) (requests per second). Functions with provisioned concurrency have a maximum rate of 10 requests per second per provisioned concurrency. For example, a function configured with 100 provisioned concurrency can handle 1,000 requests per second. If the invocation rate exceeds 1,000 requests per second, some cold starts can occur.

Lambda: Cold starts with new versions

Issue: *You see cold starts while deploying new versions of your function.*

When you update a function alias, Lambda automatically shifts provisioned concurrency to the new version based on the weights configured on the alias.

Error: *KMSDisabledException: Lambda was unable to decrypt the environment variables because the KMS key used is disabled. Please check the function's KMS key settings.*

This error can occur if your AWS Key Management Service (AWS KMS) key is disabled, or if the grant that allows Lambda to use the key is revoked. If the grant is missing, configure the function to use a different key. Then, reassign the custom key to recreate the grant.

EFS: Function could not mount the EFS file system

Error: *EFSMountFailureException: The function could not mount the EFS file system with access point arn:aws:elasticfilesystem:us-east-2:123456789012:access-point/fsap-015cxmplb72b405fd.*

The mount request to the function's [file system](#) was rejected. Check the function's permissions, and confirm that its file system and access point exist and are ready for use.

EFS: Function could not connect to the EFS file system

Error: *EFSMountConnectivityException: The function couldn't connect to the Amazon EFS file system with access point arn:aws:elasticfilesystem:us-east-2:123456789012:access-point/fsap-015cxmplb72b405fd. Check your network configuration and try again.*

The function couldn't establish a connection to the function's [file system](#) with the NFS protocol (TCP port 2049). Check the [security group and routing configuration](#) for the VPC's subnets.

If you get these errors after updating your function's VPC configuration settings, try unmounting and remounting the file system.

EFS: Function could not mount the EFS file system due to timeout

Error: *EFSMountTimeoutException: The function could not mount the EFS file system with access point {arn:aws:elasticfilesystem:us-east-2:123456789012:access-point/fsap-015cxmplb72b405fd} due to mount time out.*

The function could connect to the function's [file system](#), but the mount operation timed out. Try again after a short time and consider limiting the function's [concurrency](#) to reduce load on the file system.

Lambda: Lambda detected an IO process that was taking too long

EFSIOException: This function instance was stopped because Lambda detected an IO process that was taking too long.

A previous invocation timed out and Lambda couldn't terminate the function handler. This issue can occur when an attached file system runs out of burst credits and the baseline throughput is insufficient. To increase throughput, you can increase the size of the file system or use provisioned throughput.

Troubleshoot execution issues in Lambda

When the Lambda runtime runs your function code, the event might be processed on an instance of the function that's been processing events for some time, or it might require a new instance to be initialized. Errors can occur during function initialization, when your handler code processes the event, or when your function returns (or fails to return) a response.

Function execution errors can be caused by issues with your code, function configuration, downstream resources, or permissions. If you invoke your function directly, you see function errors in the response from Lambda. If you invoke your function asynchronously, with an event source mapping, or through another service, you might find errors in logs, a dead-letter queue, or an on-failure destination. Error handling options and retry behavior vary depending on how you invoke your function and on the type of error.

When your function code or the Lambda runtime return an error, the status code in the response from Lambda is 200 OK. The presence of an error in the response is indicated by a header named `X-Amz-Function-Error`. 400 and 500-series status codes are reserved for [invocation errors](#).

Topics

- [Lambda: Execution takes too long](#)
- [Lambda: Unexpected event payload](#)
- [Lambda: Unexpectedly large payload sizes](#)
- [Lambda: JSON encoding and decoding errors](#)
- [Lambda: Logs or traces don't appear](#)
- [Lambda: Not all of my function's logs appear](#)
- [Lambda: The function returns before execution finishes](#)
- [Lambda: Running an unintended function version or alias](#)
- [Lambda: Detecting infinite loops](#)
- [General: Downstream service unavailability](#)
- [AWS SDK: Versions and updates](#)
- [Python: Libraries load incorrectly](#)
- [Java: Your function takes longer to process events after updating to Java 17 from Java 11](#)

Lambda: Execution takes too long

Issue: *Function execution takes too long.*

If your code takes much longer to run in Lambda than on your local machine, it may be constrained by the memory or processing power available to the function. [Configure the function with additional memory](#) to increase both memory and CPU.

Lambda: Unexpected event payload

Issue: *Function errors related to malformed JSON or inadequate data validation.*

All Lambda functions receive an event payload in the first parameter of the handler. The event payload is a JSON structure that may contain arrays and nested elements.

Malformed JSON can occur when provided by upstream services that do not use a robust process for checking JSON structures. This occurs when services concatenate text strings or embed user input that has not been sanitized. JSON is also frequently serialized for passing between services. Always parse JSON structures both as the producer and consumer of JSON to ensure that the structure is valid.

Similarly, failing to check for ranges of values in the event payload can result in errors. This example shows a function that calculates a tax withholding:

```
exports.handler = async (event) => {
  let pct = event.taxPct
  let salary = event.salary

  // Calculate % of paycheck for taxes
  return (salary * pct)
}
```

This function uses a salary and tax rate from the event payload to perform the calculation. However, the code fails to check if the attributes are present. It also fails to check data types, or ensure boundaries, such as ensuring that the tax percentage is between 0 and 1. As a result, values outside of these bounds produce nonsensical results. An incorrect type or missing attribute causes a runtime error.

Create tests to ensure that your function handles larger payload sizes. The maximum size for a Lambda event payload is 256 KB. Depending upon the content, larger payloads may mean more items passed to the function or more binary data embedded in a JSON attribute. In both cases, this can result in more processing for a Lambda function.

Larger payloads can also cause timeouts. For example, a Lambda function processes one record per 100 ms and has a timeout of 3 seconds. Processing is successful for 0-29 items in the payload. However, once the payload contains more than 30 items, the function times out and throws an error. To avoid this, ensure that timeouts are set to handle the additional processing time for the maximum number of items expected.

Lambda: Unexpectedly large payload sizes

Issue: *Functions are timing out or causing errors due to large payloads.*

Larger payloads can cause timeouts and errors. We recommend creating tests to ensure that your function handles your largest expected payloads, and ensuring the function timeout is properly set.

In addition, certain event payloads can contain pointers to other resources. For example, a Lambda function with 128 MB of memory may perform image processing on a JPG file stored as an object in S3. The function works as expected with smaller image files. However, when a larger JPG file is provided as input, the Lambda function throws an error due to running out of memory. To avoid

this, the test cases should include examples from the upper bounds of expected data sizes. The code should also validate payload sizes.

Lambda: JSON encoding and decoding errors

Issue: *NoSuchKey exception when parsing JSON inputs.*

Check to ensure you are processing JSON attributes correctly. For example, for events generated by S3, the `s3.object.key` attribute contains a URL encoded object key name. Many functions process this attribute as text to load the referenced S3 object:

Example

```
const originalText = await s3.getObject({
  Bucket: event.Records[0].s3.bucket.name,
  Key: event.Records[0].s3.object.key
}).promise()
```

This code works with the key name `james.jpg` but throws a `NoSuchKey` error when the name is `james beswick.jpg`. Since URL encoding converts spaces and other characters in a key name, you must ensure that functions decode keys before using this data:

Example

```
const originalText = await s3.getObject({
  Bucket: event.Records[0].s3.bucket.name,
  Key: decodeURIComponent(event.Records[0].s3.object.key.replace(/\+/g, " "))
}).promise()
```

Lambda: Logs or traces don't appear

Issue: *Logs don't appear in CloudWatch Logs.*

Issue: *Traces don't appear in AWS X-Ray.*

Your function needs permission to call CloudWatch Logs and X-Ray. Update its [execution role](#) to grant it permission. Add the following managed policies to enable logs and tracing.

- **AWSLambdaBasicExecutionRole**
- **AWSXRayDaemonWriteAccess**

When you add permissions to your function, perform a trivial update to its code or configuration as well. This forces running instances of your function, which have outdated credentials, to stop and be replaced.

 **Note**

It may take 5 to 10 minutes for logs to show up after a function invocation.

Lambda: Not all of my function's logs appear

Issue: Function logs are missing in CloudWatch Logs, even though my permissions are correct

If your AWS account reaches its [CloudWatch Logs quota limits](#), CloudWatch throttles function logging. When this happens, some of the logs output by your functions may not appear in CloudWatch Logs.

If your function outputs logs at too high a rate for Lambda to process them, this can also cause log outputs not to appear in CloudWatch Logs. When Lambda can't send logs to CloudWatch at the rate your function produces them, it drops logs to prevent the execution of your function from slowing down. Expect to consistently observe dropped logs when your log throughput exceeds 2 MB/s for a single log stream.

If your function is configured to use [JSON formatted logs](#), Lambda tries to send a [logsDropped](#) event to CloudWatch Logs when it drops logs. However, when CloudWatch throttles your function's logging, this event might not reach CloudWatch Logs, so you won't always see a record when Lambda drops logs.

To check if your AWS account has reached its CloudWatch Logs quota limits, do the following:

1. Open the [Service Quotas console](#).
2. In the navigation pane, choose **AWS services**.
3. From the **AWS services** list, search for Amazon CloudWatch Logs.
4. In the **Service quotas** list, choose the `CreateLogGroup` throttle limit in transactions per second, `CreateLogStream` throttle limit in transactions per second and `PutLogEvents` throttle limit in transactions per second quotas to view your utilization.

You can also set CloudWatch alarms to alert you when your account utilization exceeds a limit you specify for these quotas. See [Create a CloudWatch alarm based on a static threshold](#) to learn more.

If the default quota limits for CloudWatch Logs aren't enough for your use case, you can [request a quota increase](#).

Lambda: The function returns before execution finishes

Issue: (Node.js) *Function returns before code finishes executing*

Many libraries, including the AWS SDK, operate asynchronously. When you make a network call or perform another operation that requires waiting for a response, libraries return an object called a promise that tracks the progress of the operation in the background.

To wait for the promise to resolve into a response, use the `await` keyword. This blocks your handler code from executing until the promise is resolved into an object that contains the response. If you don't need to use the data from the response in your code, you can return the promise directly to the runtime.

Some libraries don't return promises but can be wrapped in code that does. For more information, see [Define Lambda function handler in Node.js](#).

Lambda: Running an unintended function version or alias

Issue: *Function version or alias not invoked*

When you publish new Lambda functions in the console or using AWS SAM, the latest code version is represented by `$LATEST`. By default, invocations that don't specify a version or alias automatically targets the `$LATEST` version of your function code.

If you use specific function versions or aliases, these are immutable published versions of a function in addition to `$LATEST`. When troubleshooting these functions, first determine that the caller has invoked the intended version or alias. You can do this by checking your function logs. The version of the function that was invoked is always shown in the `START` log line:

2020-11-13T09:53:21.179-05:00	START RequestId: a37400cb-f3bc-441b-8592-dcb9fa552995 Version: 1
2020-11-13T08:14:27.834-05:00	START RequestId: f4943cb9-58a1-472a-af81-5801b6f0eb8d Version: \$LATEST

Lambda: Detecting infinite loops

Issue: Infinite loop patterns related to Lambda functions

There are two types of infinite loops in Lambda functions. The first is within the function itself, caused by a loop that never exits. The invocation ends only when the function times out. You can identify these by monitoring timeouts, and then fixing the looping behavior.

The second type of loop is between Lambda functions and other AWS resources. These occur when an event from a resource like an S3 bucket invokes a Lambda function, which then interacts with the same source resource to trigger another event. This invokes the function again, which creates another interaction with the same S3 bucket, and so on. These types of loops can be caused by a number of different AWS event sources, including Amazon SQS queues and DynamoDB tables. You can use [recursive loop detection](#) to identify these patterns.

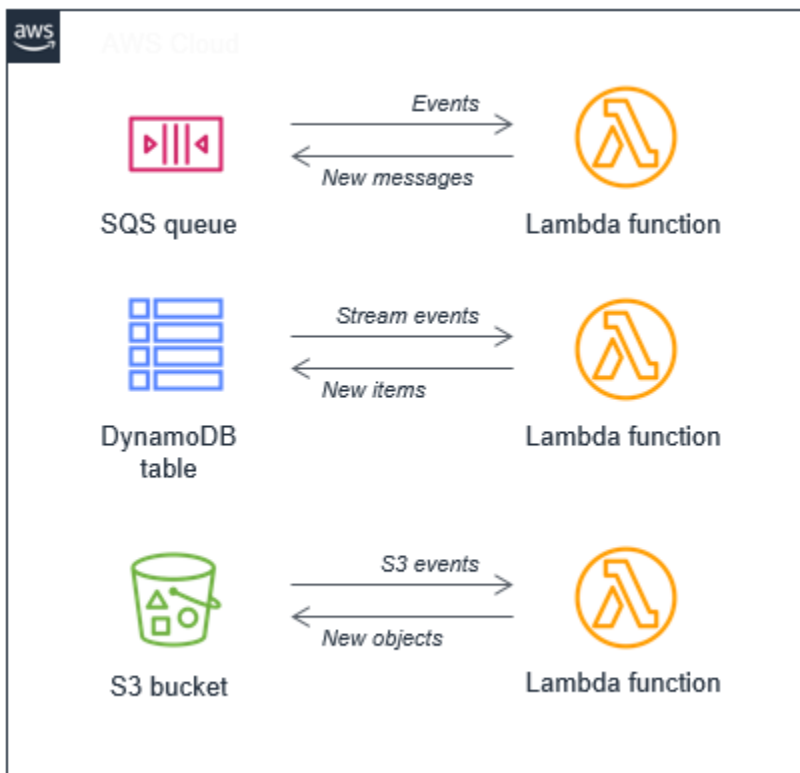

You can avoid these loops by ensuring that Lambda functions write to resources that are not the same as the consuming resource. If you must publish data back to the consuming resource, ensure that the new data doesn't trigger the same event. Alternatively, use [event filtering](#). For example, here are two proposed solutions to infinite loops with S3 and DynamoDB resources:

- If you write back to the same S3 bucket, use a different prefix or suffix from the event trigger.
- If you write items to the same DynamoDB table, include an attribute that a consuming Lambda function can filter on. If Lambda finds the attribute, it will not result in another invocation.

General: Downstream service unavailability

Issue: *Downstream services that your Lambda function relies on are unavailable*

For Lambda functions that call out to third-party endpoints or other downstream resources, ensure they can handle service errors and timeouts. These downstream resources can have variable response times, or become unavailable due to service disruptions. Depending upon the implementation, these downstream errors may appear as Lambda timeouts or exceptions if the service's error response is not handled within the function code.

Anytime a function depends on a downstream service, such as an API call, implement appropriate error handling and retry logic. For critical services, the Lambda function should publish metrics or logs to CloudWatch. For example, if a third-party payment API becomes unavailable, your Lambda function can log this information. You can then set up CloudWatch alarms to send notifications related to these errors.

Since Lambda can scale quickly, non-serverless downstream services may struggle to handle spikes in traffic. There are three common approaches to handling this:

- **Caching** – Consider caching the result of values returned by third-party services if they don't change frequently. You can store these values in global variable in your function, or another service. For example, the results for a product list query from an Amazon RDS instance could be saved for a period of time within the function to prevent redundant queries.
- **Queuing** – When saving or updating data, add an Amazon SQS queue between the Lambda function and the resource. The queue durably persists data while the downstream service processes messages.
- **Proxies** – Where long-lived connections are typically used, such as for Amazon RDS instances, use a proxy layer to pool and reuse those connections. For relational databases, [Amazon RDS Proxy](#) is a service designed to help improve scalability and resiliency in Lambda-based applications.

AWS SDK: Versions and updates

Issue: *The AWS SDK included on the runtime is not the latest version*

Issue: *The AWS SDK included on the runtime updates automatically*

Runtimes for scripting languages include the AWS SDK and are periodically updated to the latest version. The current version for each runtime is listed on [runtimes page](#). To use a newer version of the AWS SDK, or to lock your functions to a specific version, you can bundle the library with your function code, or [create a Lambda layer](#). For details on creating a deployment package with dependencies, see the following topics:

Node.js

[Deploy Node.js Lambda functions with .zip file archives](#)

Python

[Working with .zip file archives for Python Lambda functions](#)

Ruby

[Deploy Ruby Lambda functions with .zip file archives](#)

Java

[Deploy Java Lambda functions with .zip or JAR file archives](#)

Go

[Deploy Go Lambda functions with .zip file archives](#)

C#

[Build and deploy C# Lambda functions with .zip file archives](#)

PowerShell

[Deploy PowerShell Lambda functions with .zip file archives](#)

Python: Libraries load incorrectly

Issue: (Python) *Some libraries don't load correctly from the deployment package*

Libraries with extension modules written in C or C++ must be compiled in an environment with the same processor architecture as Lambda (Amazon Linux). For more information, see [Working with .zip file archives for Python Lambda functions](#).

Java: Your function takes longer to process events after updating to Java 17 from Java 11

Issue: (Java) *Your function takes longer to process events after updating to Java 17 from Java 11*

Tune your compiler using the `JAVA_TOOL_OPTIONS` parameter. Lambda runtimes for Java 17 and later Java versions change the default compiler options. The change improves cold start times for short-lived functions, but the previous behavior is better suited to computationally intensive, longer-running functions. Set `JAVA_TOOL_OPTIONS` to `-XX:-TieredCompilation` to revert to the Java 11 behavior. For more information about the `JAVA_TOOL_OPTIONS` parameter, see [the section called “Understanding the `JAVA_TOOL_OPTIONS` environment variable”](#).

Troubleshoot event source mapping issues in Lambda

Issues in Lambda that relate to an [event source mapping](#) can be more complex because they involve debugging across multiple services. Moreover, event source behavior can differ based on the exact event source used. This section lists common issues that involve event source mappings, and provides guidance on how to identify and troubleshoot them.

Note

This section uses an Amazon SQS event source for illustration, but the principles apply to other event source mappings that queue messages for Lambda functions.

Identifying and managing throttling

In Lambda, throttling occurs when you reach your function's or account's concurrency limit. Consider the following example, where there is a Lambda function that reads messages from an Amazon SQS queue. This Lambda function simulates 30 second invocations, and has a batch size of 1. This means that the function processes only 1 message every 30 seconds:

```
const doWork = (ms) => new Promise(resolve => setTimeout(resolve, ms))

exports.handler = async (event) => {
  await doWork(30000)
}
```

With such a long invocation time, messages begin arriving in the queue more rapidly than they are processed. If your account's unreserved concurrency is 100, Lambda scales up to 100 concurrent executions, and then throttling occurs. You can see this pattern in the CloudWatch metrics for the function:

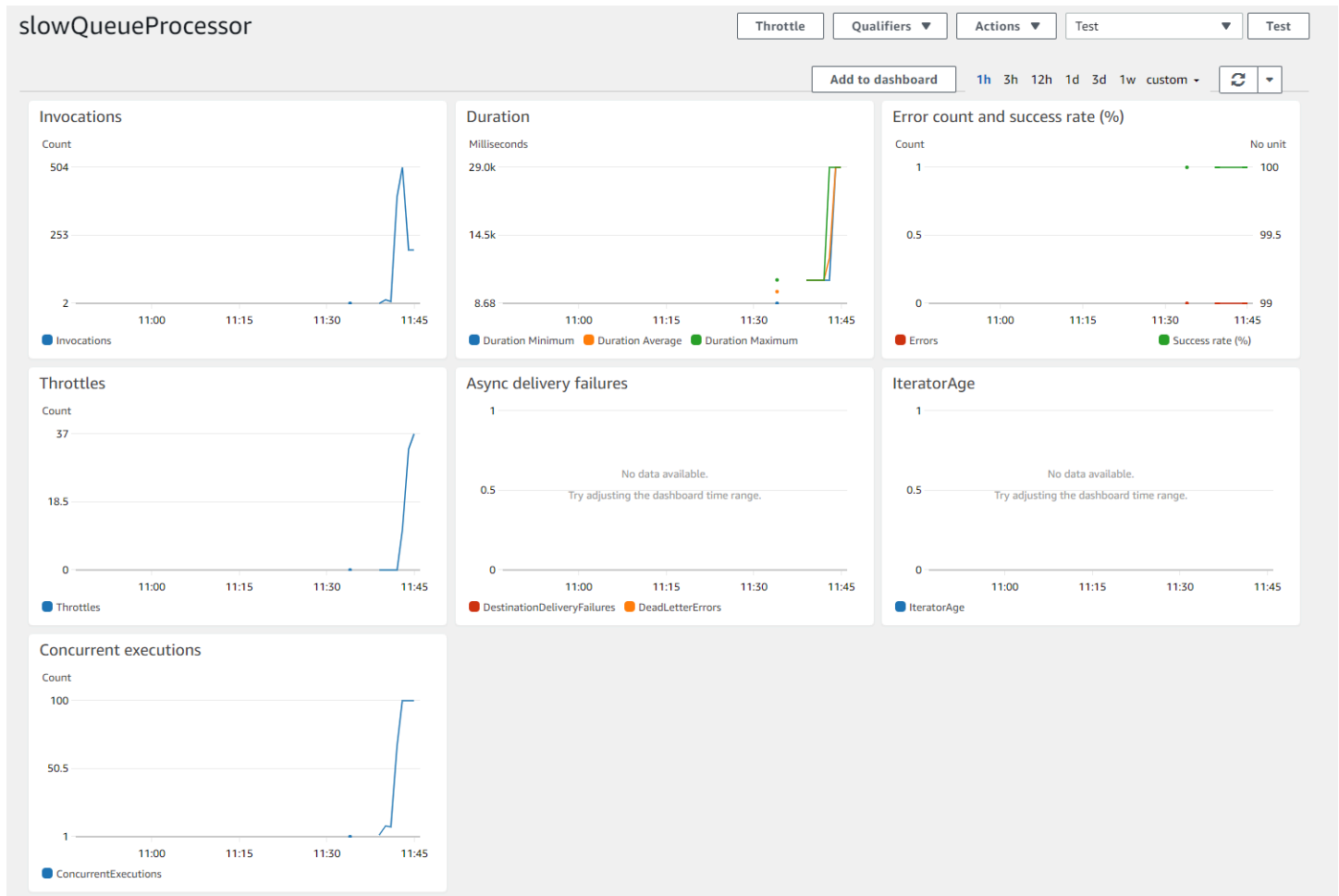

CloudWatch metrics for the function show no errors, but the **Concurrent executions** chart shows that the maximum concurrency of 100 is reached. As a result, the **Throttles** chart shows the throttling in place.

You can detect throttling with CloudWatch alarms, and setting an alarm anytime the throttling metric for a function is greater than 0. After you've identified the throttling issue, you have a few options for resolution:

- Request a concurrency increase from AWS Support in this Region.
- Identify performance issues in the function to improve the speed of processing and therefore improve throughput.
- Increase the batch size of the function, so more messages are processed by each invocation.

Errors in the processing function

If the processing function throws errors, Lambda returns the messages to the SQS queue. Lambda prevents your function from scaling to prevent errors at scale. The following SQS metrics in CloudWatch indicate an issue with queue processing:

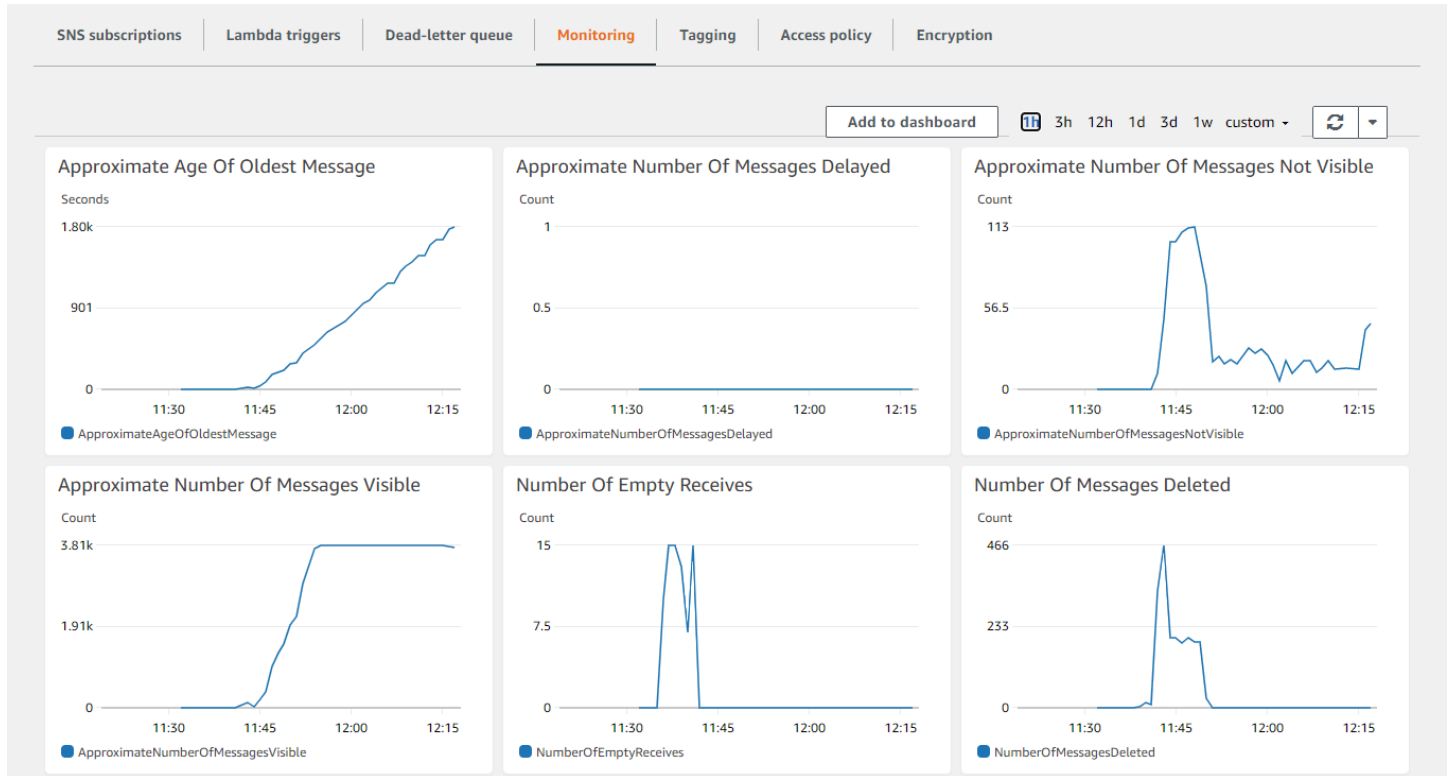

In particular, both the age of the oldest message and the number of messages visible are increasing, while no messages are deleted. The queue continues to grow but messages are not being processed. The CloudWatch metrics for the processing Lambda function also indicate that there is a problem:

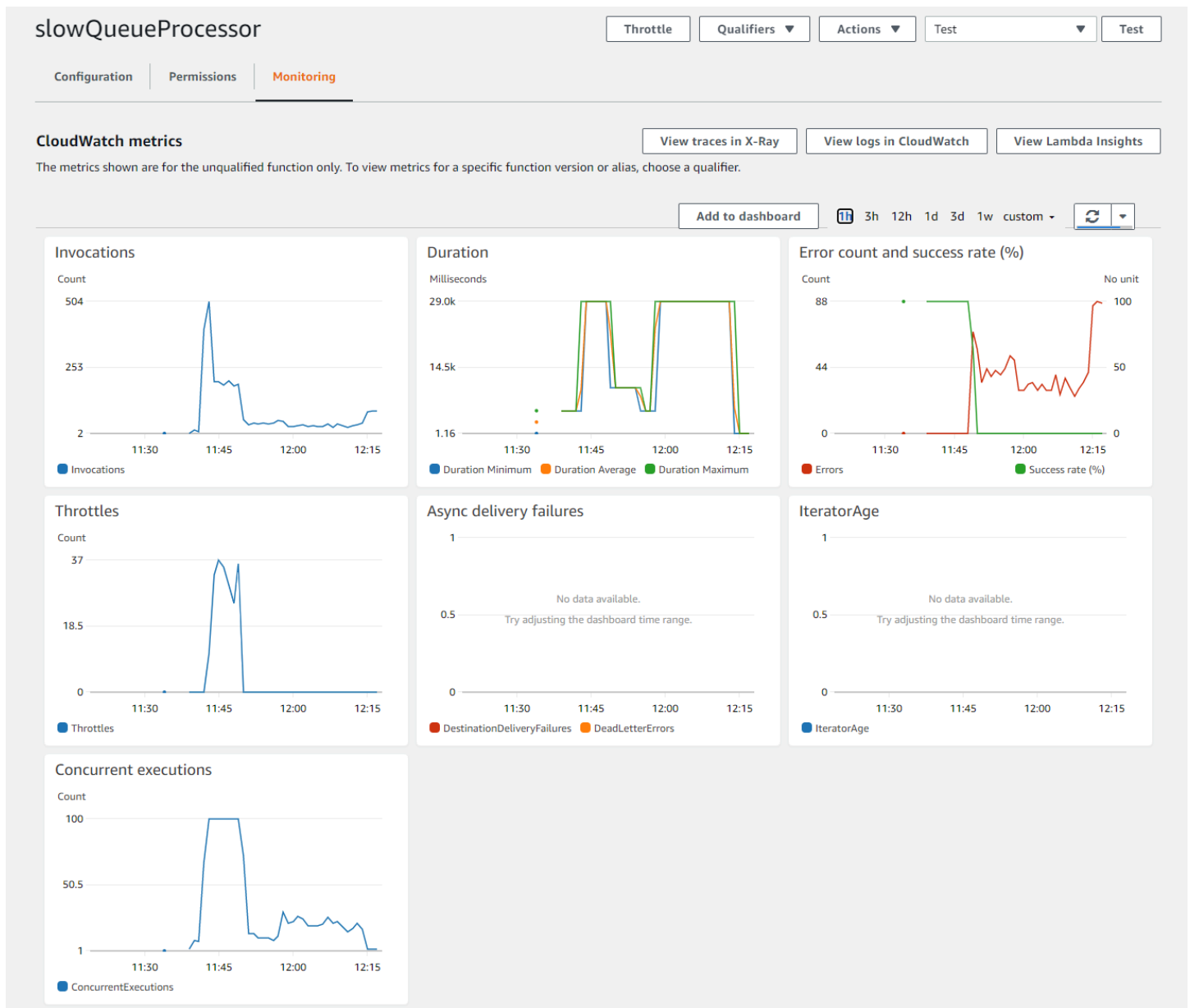

The **Error count** metric is non-zero and growing, while **Concurrent executions** have reduced and throttling has stopped. This shows that Lambda has stopped scaling up your function due to errors. The CloudWatch logs for the function provide details of the type of error.

You can resolve this issue by identifying the function causing the error, then finding and resolving the error. After you fix the error and deploy the new function code, the CloudWatch metrics should show the processing recover:

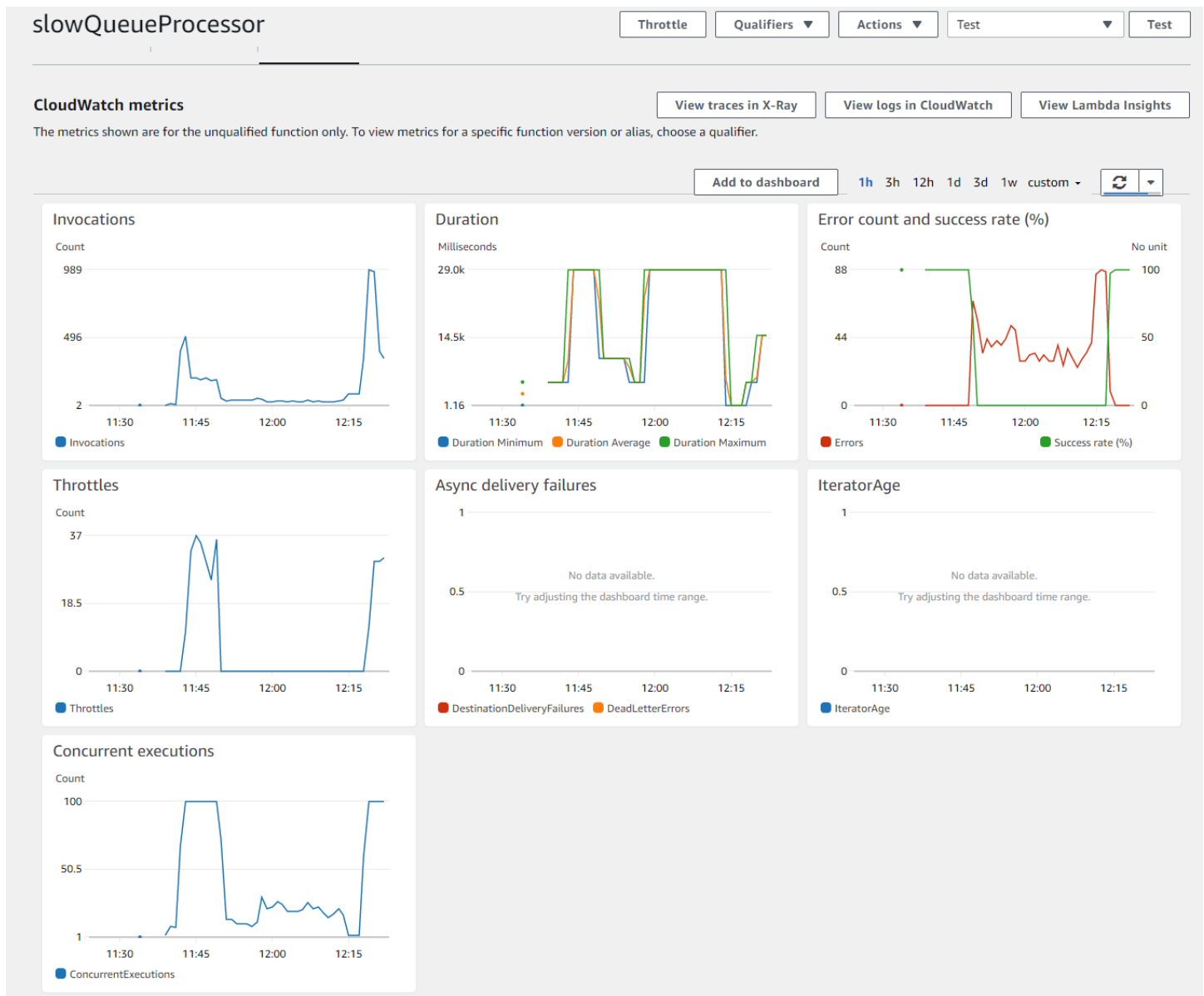

Here, the **Error count** metric drops to zero and the **Success rate** metric returns to 100%. Lambda starts scaling up the function again, as shown in the **Concurrent executions** graph.

Identifying and handling backpressure

If an event producer consistently generates messages for an SQS queue faster than a Lambda function can process them, backpressure occurs. In this case, SQS monitoring should show the age of the oldest message growing linearly, along with the approximate number of messages visible. You can detect backpressure in queues using CloudWatch alarms.

The steps to resolve backpressure depend on your workload. If the primary goal is to increase processing capability and throughput by the Lambda function, you have a few options:

- Request a concurrency increase in the specific Region from AWS Support.
- Increase the batch size of the function, so more messages are processed by each invocation.

Troubleshoot networking issues in Lambda

By default, Lambda runs your functions in an internal virtual private cloud (VPC) with connectivity to AWS services and the internet. To access local network resources, you can [configure your function to connect to a VPC in your account](#). When you use this feature, you manage the function's internet access and network connectivity with Amazon Virtual Private Cloud (Amazon VPC) resources.

Network connectivity errors can result from issues with your VPC's routing configuration, security group rules, AWS Identity and Access Management (IAM) role permissions, or network address translation (NAT), or from the availability of resources such as IP addresses or network interfaces. Depending on the issue, you might see a specific error or timeout if a request can't reach its destination.

Topics

- [VPC: Function loses internet access or times out](#)
- [VPC: Function needs access to AWS services without using the internet](#)
- [VPC: Elastic network interface limit reached](#)
- [EC2: Elastic network interface with type of "lambda"](#)
- [DNS: Fail to connect to hosts with UNKNOWNHOSTEXCEPTION](#)

VPC: Function loses internet access or times out

Issue: *Your Lambda function loses internet access after connecting to a VPC.*

Error: *Error: connect ETIMEDOUT 176.32.98.189:443*

Error: *Error: Task timed out after 10.00 seconds*

Error: *ReadTimeoutError: Read timed out. (read timeout=15)*

When you connect a function to a VPC, all outbound requests go through the VPC. To connect to the internet, configure your VPC to send outbound traffic from the function's subnet to a NAT

gateway in a public subnet. For more information and sample VPC configurations, see [the section called "Internet access for VPC functions"](#).

If some of your TCP connections are timing out, this may be due to packet fragmentation. Lambda functions cannot handle incoming fragmented TCP requests, since Lambda does not support IP fragmentation for TCP or ICMP.

VPC: Function needs access to AWS services without using the internet

Issue: *Your Lambda function needs access to AWS services without using the internet.*

To connect a function to AWS services from a private subnet with no internet access, use VPC endpoints.

VPC: Elastic network interface limit reached

Error: *ENILimitReachedException: The elastic network interface limit was reached for the function's VPC.*

When you connect a Lambda function to a VPC, Lambda creates an elastic network interface for each combination of subnet and security group attached to the function. The default service quota is 250 network interfaces per VPC. To request a quota increase, use the [Service Quotas console](#).

EC2: Elastic network interface with type of "lambda"

Error Code: *Client.OperationNotPermitted*

Error message: *The security group can not be modified for this type of interface*

You will receive this error if you attempt to modify an elastic network interface (ENI) that is managed by Lambda. The `ModifyNetworkInterfaceAttribute` is not included in the Lambda API for update operations on elastic network interfaces created by Lambda.

DNS: Fail to connect to hosts with UNKNOWNHOSTEXCEPTION

Error Message: *UNKNOWNHOSTEXCEPTION*

Lambda functions support a maximum of 20 concurrent TCP connections for DNS resolution. Your function may be exhausting that limit. Most common DNS requests are done over UDP. If your function is only making UDP DNS connections, this is unlikely to be your issue. This error is

commonly thrown due to misconfiguration or degraded infrastructure, so before examining your DNS traffic in depth, confirm that your DNS infrastructure is properly configured and healthy and that your Lambda function is referring to a host specified in DNS.

If you diagnose your issue as related to the TCP connection maximum, note that you cannot request an increase to this limit. If your Lambda function is falling back to TCP DNS because of large DNS payloads, confirm that your solution is using libraries that support EDNS. For more information about EDNS, see [the RFC 6891 standard](#). If your DNS payloads consistently exceed EDNS max sizes, your solution may still exhaust the TCP DNS limit.

Lambda sample applications

The GitHub repository for this guide includes sample applications that demonstrate the use of various languages and AWS services. Each sample application includes scripts for easy deployment and cleanup and supporting resources.

Node.js

Sample Lambda applications in Node.js

- [blank-nodejs](#) – A Node.js function that shows the use of logging, environment variables, AWS X-Ray tracing, layers, unit tests and the AWS SDK.
- [nodejs-apig](#) – A function with a public API endpoint that processes an event from API Gateway and returns an HTTP response.
- [efs-nodejs](#) – A function that uses an Amazon EFS file system in a Amazon VPC. This sample includes a VPC, file system, mount targets, and access point configured for use with Lambda.

Python

Sample Lambda applications in Python

- [blank-python](#) – A Python function that shows the use of logging, environment variables, AWS X-Ray tracing, layers, unit tests and the AWS SDK.

Ruby

Sample Lambda applications in Ruby

- [blank-ruby](#) – A Ruby function that shows the use of logging, environment variables, AWS X-Ray tracing, layers, unit tests and the AWS SDK.
- [Ruby Code Samples for AWS Lambda](#) – Code samples written in Ruby that demonstrate how to interact with AWS Lambda.

Java

Sample Lambda applications in Java

- [java17-examples](#) – A Java function that demonstrates how to use a Java record to represent an input event data object.
- [java-basic](#) – A collection of minimal Java functions with unit tests and variable logging configuration.
- [java-events](#) – A collection of Java functions that contain skeleton code for how to handle events from various services such as Amazon API Gateway, Amazon SQS, and Amazon Kinesis. These functions use the latest version of the [aws-lambda-java-events](#) library (3.0.0 and newer). These examples do not require the AWS SDK as a dependency.
- [s3-java](#) – A Java function that processes notification events from Amazon S3 and uses the Java Class Library (JCL) to create thumbnails from uploaded image files.
- [custom-serialization](#) – Examples of how to implement [custom serialization](#) using popular libraries such as fastJson, Gson, Moshi, and jackson-jr.
- [Use API Gateway to invoke a Lambda function](#) – A Java function that scans a Amazon DynamoDB table that contains employee information. It then uses Amazon Simple Notification Service to send a text message to employees celebrating their work anniversaries. This example uses API Gateway to invoke the function.

Running popular Java frameworks on Lambda

- [spring-cloud-function-samples](#) – An example from Spring that shows how to use the [Spring Cloud Function](#) framework to create AWS Lambda functions.
- [Serverless Spring Boot Application Demo](#) – An example that shows how to set up a typical Spring Boot application in a managed Java runtime with and without SnapStart, or as a GraalVM native image with a custom runtime.
- [Serverless Micronaut Application Demo](#) – An example that shows how to use Micronaut in a managed Java runtime with and without SnapStart, or as a GraalVM native image with a custom runtime. Learn more in the [Micronaut/Lambda guides](#).
- [Serverless Quarkus Application Demo](#) – An example that shows how to use Quarkus in a managed Java runtime with and without SnapStart, or as a GraalVM native image with a custom runtime. Learn more in the [Quarkus/Lambda guide](#) and [Quarkus/SnapStart guide](#).

Go

Lambda provides the following sample applications for the Go runtime:

Sample Lambda applications in Go

- [go-al2](#) – A hello world function that returns the public IP address. This app uses the `provided.al2` custom runtime.
- [blank-go](#) – A Go function that shows the use of Lambda's Go libraries, logging, environment variables, and the AWS SDK. This app uses the `go1.x` runtime.

C#

Sample Lambda applications in C#

- [blank-csharp](#) – A C# function that shows the use of Lambda's .NET libraries, logging, environment variables, AWS X-Ray tracing, unit tests, and the AWS SDK.
- [blank-csharp-with-layer](#) – A C# function that uses the .NET CLI to create a layer that packages the function's dependencies.
- [ec2-spot](#) – A function that manages spot instance requests in Amazon EC2.

PowerShell

Lambda provides the following sample applications for PowerShell:

- [blank-powershell](#) – A PowerShell function that shows the use of logging, environment variables, and the AWS SDK.

To deploy a sample application, follow the instructions in its README file.

Using Lambda with an AWS SDK

AWS software development kits (SDKs) are available for many popular programming languages. Each SDK provides an API, code examples, and documentation that make it easier for developers to build applications in their preferred language.

SDK documentation	Code examples
AWS SDK for C++	AWS SDK for C++ code examples
AWS CLI	AWS CLI code examples
AWS SDK for Go	AWS SDK for Go code examples
AWS SDK for Java	AWS SDK for Java code examples
AWS SDK for JavaScript	AWS SDK for JavaScript code examples
AWS SDK for Kotlin	AWS SDK for Kotlin code examples
AWS SDK for .NET	AWS SDK for .NET code examples
AWS SDK for PHP	AWS SDK for PHP code examples
AWS Tools for PowerShell	Tools for PowerShell code examples
AWS SDK for Python (Boto3)	AWS SDK for Python (Boto3) code examples
AWS SDK for Ruby	AWS SDK for Ruby code examples
AWS SDK for Rust	AWS SDK for Rust code examples
AWS SDK for SAP ABAP	AWS SDK for SAP ABAP code examples
AWS SDK for Swift	AWS SDK for Swift code examples

For examples specific to Lambda, see [Code examples for Lambda using AWS SDKs](#).

 **Example availability**

Can't find what you need? Request a code example by using the **Provide feedback** link at the bottom of this page.

Code examples for Lambda using AWS SDKs

The following code examples show how to use Lambda with an AWS software development kit (SDK).

Basics are code examples that show you how to perform the essential operations within a service.

Actions are code excerpts from larger programs and must be run in context. While actions show you how to call individual service functions, you can see actions in context in their related scenarios.

Scenarios are code examples that show you how to accomplish specific tasks by calling multiple functions within a service or combined with other AWS services.

AWS community contributions are examples that were created and are maintained by multiple teams across AWS. To provide feedback, use the mechanism provided in the linked repositories.

For a complete list of AWS SDK developer guides and code examples, see [Using Lambda with an AWS SDK](#). This topic also includes information about getting started and details about previous SDK versions.

Get started

Hello Lambda

The following code examples show how to get started using Lambda.

.NET

AWS SDK for .NET

Note

There's more on GitHub. Find the complete example and learn how to set up and run in the [AWS Code Examples Repository](#).

```
namespace LambdaActions;  
  
using Amazon.Lambda;
```

```
public class HelloLambda
{
    static async Task Main(string[] args)
    {
        var lambdaClient = new AmazonLambdaClient();

        Console.WriteLine("Hello AWS Lambda");
        Console.WriteLine("Let's get started with AWS Lambda by listing your
existing Lambda functions:");

        var response = await lambdaClient.ListFunctionsAsync();
        response.Functions.ForEach(function =>
        {

            Console.WriteLine($"{function.FunctionName}\t{function.Description}");
        });
    }
}
```

- For API details, see [ListFunctions](#) in *AWS SDK for .NET API Reference*.

C++

SDK for C++

Note

There's more on GitHub. Find the complete example and learn how to set up and run in the [AWS Code Examples Repository](#).

Code for the CMakeLists.txt CMake file.

```
# Set the minimum required version of CMake for this project.
cmake_minimum_required(VERSION 3.13)

# Set the AWS service components used by this project.
set(SERVICE_COMPONENTS lambda)

# Set this project's name.
```



```
project("hello_lambda")

# Set the C++ standard to use to build this target.
# At least C++ 11 is required for the AWS SDK for C++.
set(CMAKE_CXX_STANDARD 11)

# Use the MSVC variable to determine if this is a Windows build.
set(WINDOWS_BUILD ${MSVC})

if (WINDOWS_BUILD) # Set the location where CMake can find the installed
  libraries for the AWS SDK.
  string(REPLACE ";" "/aws-cpp-sdk-all;" SYSTEM_MODULE_PATH
    "${CMAKE_SYSTEM_PREFIX_PATH}/aws-cpp-sdk-all")
  list(APPEND CMAKE_PREFIX_PATH ${SYSTEM_MODULE_PATH})
endif ()

# Find the AWS SDK for C++ package.
find_package(AWSSDK REQUIRED COMPONENTS ${SERVICE_COMPONENTS})

if (WINDOWS_BUILD AND AWSSDK_INSTALL_AS_SHARED_LIBS)
  # Copy relevant AWS SDK for C++ libraries into the current binary directory
  for running and debugging.

  # set(BIN_SUB_DIR "/Debug") # if you are building from the command line you
  may need to uncomment this
  # and set the proper subdirectory to the
  executables' location.

  AWSSDK_CPY_DYN_LIBS(SERVICE_COMPONENTS ""
    ${CMAKE_CURRENT_BINARY_DIR}${BIN_SUB_DIR})
endif ()

add_executable(${PROJECT_NAME}
  hello_lambda.cpp)

target_link_libraries(${PROJECT_NAME}
  ${AWSSDK_LINK_LIBRARIES})
```

Code for the `hello_lambda.cpp` source file.

```
#include <aws/core/Aws.h>
#include <aws/lambda/LambdaClient.h>
```

```
#include <aws/lambda/model/ListFunctionsRequest.h>
#include <iostream>

/*
 * A "Hello Lambda" starter application which initializes an AWS Lambda (Lambda)
 * client and lists the Lambda functions.
 *
 * main function
 *
 * Usage: 'hello_lambda'
 *
 */

int main(int argc, char **argv) {
    Aws::SDKOptions options;
    // Optionally change the log level for debugging.
    // options.loggingOptions.logLevel = Utils::Logging::LogLevel::Debug;
    Aws::InitAPI(options); // Should only be called once.
    int result = 0;
    {
        Aws::Client::ClientConfiguration clientConfig;
        // Optional: Set to the AWS Region (overrides config file).
        // clientConfig.region = "us-east-1";

        Aws::Lambda::LambdaClient lambdaClient(clientConfig);
        std::vector<Aws::String> functions;
        Aws::String marker; // Used for pagination.

        do {
            Aws::Lambda::Model::ListFunctionsRequest request;
            if (!marker.empty()) {
                request.SetMarker(marker);
            }

            Aws::Lambda::Model::ListFunctionsOutcome outcome =
lambdaClient.ListFunctions(
                request);

            if (outcome.IsSuccess()) {
                const Aws::Lambda::Model::ListFunctionsResult
&listFunctionsResult = outcome.GetResult();
                std::cout << listFunctionsResult.GetFunctions().size()
                    << " lambda functions were retrieved." << std::endl;
            }
        }
    }
}
```

```

        for (const Aws::Lambda::Model::FunctionConfiguration
&functionConfiguration: listFunctionsResult.GetFunctions()) {
            functions.push_back(functionConfiguration.GetFunctionName());
            std::cout << functions.size() << " "
                << functionConfiguration.GetDescription() <<
std::endl;

            std::cout << " "
                <<
Aws::Lambda::Model::RuntimeMapper::GetNameForRuntime(
                functionConfiguration.GetRuntime()) << ": "
                << functionConfiguration.GetHandler()
                << std::endl;
        }
        marker = listFunctionsResult.GetNextMarker();
    } else {
        std::cerr << "Error with Lambda::ListFunctions. "
            << outcome.GetError().GetMessage()
            << std::endl;
        result = 1;
        break;
    }
} while (!marker.empty());
}

Aws::ShutdownAPI(options); // Should only be called once.
return result;
}

```

- For API details, see [ListFunctions](#) in *AWS SDK for C++ API Reference*.

Go

SDK for Go V2

Note

There's more on GitHub. Find the complete example and learn how to set up and run in the [AWS Code Examples Repository](#).

```
}  
}
```

- For API details, see [ListFunctions](#) in *AWS SDK for Go API Reference*.

Java

SDK for Java 2.x

Note

There's more on GitHub. Find the complete example and learn how to set up and run in the [AWS Code Examples Repository](#).

```
/**  
 * Lists the AWS Lambda functions associated with the current AWS account.  
 *  
 * @param awsLambda an instance of the {@link LambdaClient} class, which is  
 used to interact with the AWS Lambda service  
 *  
 * @throws LambdaException if an error occurs while interacting with the AWS  
 Lambda service  
 */  
public static void listFunctions(LambdaClient awsLambda) {  
    try {  
        ListFunctionsResponse functionResult = awsLambda.listFunctions();  
        List<FunctionConfiguration> list = functionResult.functions();  
        for (FunctionConfiguration config : list) {  
            System.out.println("The function name is " +  
config.functionName());  
        }  
    } catch (LambdaException e) {  
        System.err.println(e.getMessage());  
        System.exit(1);  
    }  
}
```

- For API details, see [ListFunctions](#) in *AWS SDK for Java 2.x API Reference*.

JavaScript

SDK for JavaScript (v3)

Note

There's more on GitHub. Find the complete example and learn how to set up and run in the [AWS Code Examples Repository](#).

```
import { LambdaClient, paginateListFunctions } from "@aws-sdk/client-lambda";

const client = new LambdaClient({});

export const helloLambda = async () => {
  const paginator = paginateListFunctions({ client }, {});
  const functions = [];

  for await (const page of paginator) {
    const funcNames = page.Functions.map((f) => f.FunctionName);
    functions.push(...funcNames);
  }

  console.log("Functions:");
  console.log(functions.join("\n"));
  return functions;
};
```

- For API details, see [ListFunctions](#) in *AWS SDK for JavaScript API Reference*.

Python

SDK for Python (Boto3)

Note

There's more on GitHub. Find the complete example and learn how to set up and run in the [AWS Code Examples Repository](#).

```
import boto3

def main():
    """
    List the Lambda functions in your AWS account.
    """
    # Create the Lambda client
    lambda_client = boto3.client("lambda")

    # Use the paginator to list the functions
    paginator = lambda_client.get_paginator("list_functions")
    response_iterator = paginator.paginate()

    print("Here are the Lambda functions in your account:")
    for page in response_iterator:
        for function in page["Functions"]:
            print(f" {function['FunctionName']}")

if __name__ == "__main__":
    main()
```

- For API details, see [ListFunctions](#) in *AWS SDK for Python (Boto3) API Reference*.

Ruby

SDK for Ruby

Note

There's more on GitHub. Find the complete example and learn how to set up and run in the [AWS Code Examples Repository](#).

```
require 'aws-sdk-lambda'

# Creates an AWS Lambda client using the default credentials and configuration
def lambda_client
  Aws::Lambda::Client.new
end

# Lists the Lambda functions in your AWS account, paginating the results if
# necessary
def list_lambda_functions
  lambda = lambda_client

  # Use a pagination iterator to list all functions
  functions = []
  lambda.list_functions.each_page do |page|
    functions.concat(page.functions)
  end

  # Print the name and ARN of each function
  functions.each do |function|
    puts "Function name: #{function.function_name}"
    puts "Function ARN: #{function.function_arn}"
    puts
  end

  puts "Total functions: #{functions.count}"
end

list_lambda_functions if __FILE__ == $PROGRAM_NAME
```

- For API details, see [ListFunctions](#) in *AWS SDK for Ruby API Reference*.

Code examples

- [Basic examples for Lambda using AWS SDKs](#)
 - [Hello Lambda](#)
 - [Learn the basics of Lambda with an AWS SDK](#)
 - [Actions for Lambda using AWS SDKs](#)
 - [Use CreateAlias with a CLI](#)
 - [Use CreateFunction with an AWS SDK or CLI](#)
 - [Use DeleteAlias with a CLI](#)
 - [Use DeleteFunction with an AWS SDK or CLI](#)
 - [Use DeleteFunctionConcurrency with a CLI](#)
 - [Use DeleteProvisionedConcurrencyConfig with a CLI](#)
 - [Use GetAccountSettings with a CLI](#)
 - [Use GetAlias with a CLI](#)
 - [Use GetFunction with an AWS SDK or CLI](#)
 - [Use GetFunctionConcurrency with a CLI](#)
 - [Use GetFunctionConfiguration with a CLI](#)
 - [Use GetPolicy with a CLI](#)
 - [Use GetProvisionedConcurrencyConfig with a CLI](#)
 - [Use Invoke with an AWS SDK or CLI](#)
 - [Use ListFunctions with an AWS SDK or CLI](#)
 - [Use ListProvisionedConcurrencyConfigs with a CLI](#)
 - [Use ListTags with a CLI](#)
 - [Use ListVersionsByFunction with a CLI](#)
 - [Use PublishVersion with a CLI](#)
 - [Use PutFunctionConcurrency with a CLI](#)
 - [Use PutProvisionedConcurrencyConfig with a CLI](#)
 - [Use RemovePermission with a CLI](#)
 - [Use TagResource with a CLI](#)
 - [Use UntagResource with a CLI](#)

- [Use UpdateAlias with a CLI](#)
- [Use UpdateFunctionCode with an AWS SDK or CLI](#)
- [Use UpdateFunctionConfiguration with an AWS SDK or CLI](#)
- [Scenarios for Lambda using AWS SDKs](#)
 - [Automatically confirm known Amazon Cognito users with a Lambda function using an AWS SDK](#)
 - [Automatically migrate known Amazon Cognito users with a Lambda function using an AWS SDK](#)
 - [Create an API Gateway REST API to track COVID-19 data](#)
 - [Create a lending library REST API](#)
 - [Create a messenger application with Step Functions](#)
 - [Create a photo asset management application that lets users manage photos using labels](#)
 - [Create a websocket chat application with API Gateway](#)
 - [Create an application that analyzes customer feedback and synthesizes audio](#)
 - [Invoke a Lambda function from a browser](#)
 - [Transform data for your application with S3 Object Lambda](#)
 - [Use API Gateway to invoke a Lambda function](#)
 - [Use Step Functions to invoke Lambda functions](#)
 - [Use scheduled events to invoke a Lambda function](#)
 - [Write custom activity data with a Lambda function after Amazon Cognito user authentication using an AWS SDK](#)
- [Serverless examples for Lambda using AWS SDKs](#)
 - [Connecting to an Amazon RDS database in a Lambda function](#)
 - [Invoke a Lambda function from a Kinesis trigger](#)
 - [Invoke a Lambda function from a DynamoDB trigger](#)
 - [Invoke a Lambda function from a Amazon DocumentDB trigger](#)
 - [Invoke a Lambda function from an Amazon MSK trigger](#)
 - [Invoke a Lambda function from an Amazon S3 trigger](#)
 - [Invoke a Lambda function from an Amazon SNS trigger](#)
 - [Invoke a Lambda function from an Amazon SQS trigger](#)
 - [Reporting batch item failures for Lambda functions with a Kinesis trigger](#)

- [Reporting batch item failures for Lambda functions with a DynamoDB trigger](#)
- [Reporting batch item failures for Lambda functions with an Amazon SQS trigger](#)
- [AWS community contributions for Lambda using AWS SDKs](#)
 - [Build and test a serverless application](#)

Basic examples for Lambda using AWS SDKs

The following code examples show how to use the basics of AWS Lambda with AWS SDKs.

Examples

- [Hello Lambda](#)
- [Learn the basics of Lambda with an AWS SDK](#)
- [Actions for Lambda using AWS SDKs](#)
 - [Use CreateAlias with a CLI](#)
 - [Use CreateFunction with an AWS SDK or CLI](#)
 - [Use DeleteAlias with a CLI](#)
 - [Use DeleteFunction with an AWS SDK or CLI](#)
 - [Use DeleteFunctionConcurrency with a CLI](#)
 - [Use DeleteProvisionedConcurrencyConfig with a CLI](#)
 - [Use GetAccountSettings with a CLI](#)
 - [Use GetAlias with a CLI](#)
 - [Use GetFunction with an AWS SDK or CLI](#)
 - [Use GetFunctionConcurrency with a CLI](#)
 - [Use GetFunctionConfiguration with a CLI](#)
 - [Use GetPolicy with a CLI](#)
 - [Use GetProvisionedConcurrencyConfig with a CLI](#)
 - [Use Invoke with an AWS SDK or CLI](#)
 - [Use ListFunctions with an AWS SDK or CLI](#)
 - [Use ListProvisionedConcurrencyConfigs with a CLI](#)
 - [Use ListTags with a CLI](#)
 - [Use ListVersionsByFunction with a CLI](#)

- [Use PublishVersion with a CLI](#)
- [Use PutFunctionConcurrency with a CLI](#)
- [Use PutProvisionedConcurrencyConfig with a CLI](#)
- [Use RemovePermission with a CLI](#)
- [Use TagResource with a CLI](#)
- [Use UntagResource with a CLI](#)
- [Use UpdateAlias with a CLI](#)
- [Use UpdateFunctionCode with an AWS SDK or CLI](#)
- [Use UpdateFunctionConfiguration with an AWS SDK or CLI](#)

Hello Lambda

The following code examples show how to get started using Lambda.

.NET

AWS SDK for .NET

Note

There's more on GitHub. Find the complete example and learn how to set up and run in the [AWS Code Examples Repository](#).

```
namespace LambdaActions;

using Amazon.Lambda;

public class HelloLambda
{
    static async Task Main(string[] args)
    {
        var lambdaClient = new AmazonLambdaClient();

        Console.WriteLine("Hello AWS Lambda");
        Console.WriteLine("Let's get started with AWS Lambda by listing your
existing Lambda functions:");
    }
}
```

```
var response = await lambdaClient.ListFunctionsAsync();
response.Functions.ForEach(function =>
{
    Console.WriteLine($"{function.FunctionName}\t{function.Description}");
});
}
```

- For API details, see [ListFunctions](#) in *AWS SDK for .NET API Reference*.

C++

SDK for C++

Note

There's more on GitHub. Find the complete example and learn how to set up and run in the [AWS Code Examples Repository](#).

Code for the CMakeLists.txt CMake file.

```
# Set the minimum required version of CMake for this project.
cmake_minimum_required(VERSION 3.13)

# Set the AWS service components used by this project.
set(SERVICE_COMPONENTS lambda)

# Set this project's name.
project("hello_lambda")

# Set the C++ standard to use to build this target.
# At least C++ 11 is required for the AWS SDK for C++.
set(CMAKE_CXX_STANDARD 11)

# Use the MSVC variable to determine if this is a Windows build.
set(WINDOWS_BUILD ${MSVC})
```

```

if (WINDOWS_BUILD) # Set the location where CMake can find the installed
    libraries for the AWS SDK.
    string(REPLACE ";" "/aws-cpp-sdk-all;" SYSTEM_MODULE_PATH
        "${CMAKE_SYSTEM_PREFIX_PATH}/aws-cpp-sdk-all")
    list(APPEND CMAKE_PREFIX_PATH ${SYSTEM_MODULE_PATH})
endif ()

# Find the AWS SDK for C++ package.
find_package(AWSSDK REQUIRED COMPONENTS ${SERVICE_COMPONENTS})

if (WINDOWS_BUILD AND AWSSDK_INSTALL_AS_SHARED_LIBS)
    # Copy relevant AWS SDK for C++ libraries into the current binary directory
    for running and debugging.

    # set(BIN_SUB_DIR "/Debug") # if you are building from the command line you
    may need to uncomment this
                                # and set the proper subdirectory to the
    executables' location.

    AWSSDK_CPY_DYN_LIBS(SERVICE_COMPONENTS ""
        ${CMAKE_CURRENT_BINARY_DIR}${BIN_SUB_DIR})
endif ()

add_executable(${PROJECT_NAME}
    hello_lambda.cpp)

target_link_libraries(${PROJECT_NAME}
    ${AWSSDK_LINK_LIBRARIES})

```

Code for the `hello_lambda.cpp` source file.

```

#include <aws/core/Aws.h>
#include <aws/lambda/LambdaClient.h>
#include <aws/lambda/model/ListFunctionsRequest.h>
#include <iostream>

/*
 * A "Hello Lambda" starter application which initializes an AWS Lambda (Lambda)
 * client and lists the Lambda functions.
 *
 * main function
 */

```

```
* Usage: 'hello_lambda'
*
*/

int main(int argc, char **argv) {
    Aws::SDKOptions options;
    // Optionally change the log level for debugging.
// options.loggingOptions.logLevel = Utils::Logging::LogLevel::Debug;
    Aws::InitAPI(options); // Should only be called once.
    int result = 0;
    {
        Aws::Client::ClientConfiguration clientConfig;
        // Optional: Set to the AWS Region (overrides config file).
        // clientConfig.region = "us-east-1";

        Aws::Lambda::LambdaClient lambdaClient(clientConfig);
        std::vector<Aws::String> functions;
        Aws::String marker; // Used for pagination.

        do {
            Aws::Lambda::Model::ListFunctionsRequest request;
            if (!marker.empty()) {
                request.SetMarker(marker);
            }

            Aws::Lambda::Model::ListFunctionsOutcome outcome =
lambdaClient.ListFunctions(
                request);

            if (outcome.IsSuccess()) {
                const Aws::Lambda::Model::ListFunctionsResult
&listFunctionsResult = outcome.GetResult();
                std::cout << listFunctionsResult.GetFunctions().size()
                    << " lambda functions were retrieved." << std::endl;

                for (const Aws::Lambda::Model::FunctionConfiguration
&functionConfiguration: listFunctionsResult.GetFunctions()) {
                    functions.push_back(functionConfiguration.GetFunctionName());
                    std::cout << functions.size() << " "
                        << functionConfiguration.GetDescription() <<
std::endl;
                    std::cout << " "
                        <<
Aws::Lambda::Model::RuntimeMapper::GetNameForRuntime(
```

```

        functionConfiguration.GetRuntime()) << ": "
        << functionConfiguration.GetHandler()
        << std::endl;
    }
    marker = listFunctionsResult.GetNextMarker();
} else {
    std::cerr << "Error with Lambda::ListFunctions. "
        << outcome.GetError().GetMessage()
        << std::endl;
    result = 1;
    break;
}
} while (!marker.empty());
}

Aws::ShutdownAPI(options); // Should only be called once.
return result;
}

```

- For API details, see [ListFunctions](#) in *AWS SDK for C++ API Reference*.

Go

SDK for Go V2

Note

There's more on GitHub. Find the complete example and learn how to set up and run in the [AWS Code Examples Repository](#).

```

package main

import (
    "context"
    "fmt"

    "github.com/aws/aws-sdk-go-v2/aws"
    "github.com/aws/aws-sdk-go-v2/config"

```



```
"github.com/aws/aws-sdk-go-v2/service/lambda"
)

// main uses the AWS SDK for Go (v2) to create an AWS Lambda client and list up
// to 10
// functions in your account.
// This example uses the default settings specified in your shared credentials
// and config files.
func main() {
    ctx := context.Background()
    sdkConfig, err := config.LoadDefaultConfig(ctx)
    if err != nil {
        fmt.Println("Couldn't load default configuration. Have you set up your AWS
account?")
        fmt.Println(err)
        return
    }
    lambdaClient := lambda.NewFromConfig(sdkConfig)

    maxItems := 10
    fmt.Printf("Let's list up to %v functions for your account.\n", maxItems)
    result, err := lambdaClient.ListFunctions(ctx, &lambda.ListFunctionsInput{
        MaxItems: aws.Int32(int32(maxItems)),
    })
    if err != nil {
        fmt.Printf("Couldn't list functions for your account. Here's why: %v\n", err)
        return
    }
    if len(result.Functions) == 0 {
        fmt.Println("You don't have any functions!")
    } else {
        for _, function := range result.Functions {
            fmt.Printf("\t\t%v\n", *function.FunctionName)
        }
    }
}
```

- For API details, see [ListFunctions](#) in *AWS SDK for Go API Reference*.

Java

SDK for Java 2.x

 **Note**

There's more on GitHub. Find the complete example and learn how to set up and run in the [AWS Code Examples Repository](#).

```
/**
 * Lists the AWS Lambda functions associated with the current AWS account.
 *
 * @param awsLambda an instance of the {@link LambdaClient} class, which is
 * used to interact with the AWS Lambda service
 *
 * @throws LambdaException if an error occurs while interacting with the AWS
 * Lambda service
 */
public static void listFunctions(LambdaClient awsLambda) {
    try {
        ListFunctionsResponse functionResult = awsLambda.listFunctions();
        List<FunctionConfiguration> list = functionResult.functions();
        for (FunctionConfiguration config : list) {
            System.out.println("The function name is " +
config.functionName());
        }

        } catch (LambdaException e) {
            System.err.println(e.getMessage());
            System.exit(1);
        }
    }
}
```

- For API details, see [ListFunctions](#) in *AWS SDK for Java 2.x API Reference*.

JavaScript

SDK for JavaScript (v3)

Note

There's more on GitHub. Find the complete example and learn how to set up and run in the [AWS Code Examples Repository](#).

```
import { LambdaClient, paginateListFunctions } from "@aws-sdk/client-lambda";

const client = new LambdaClient({});

export const helloLambda = async () => {
  const paginator = paginateListFunctions({ client }, {});
  const functions = [];

  for await (const page of paginator) {
    const funcNames = page.Functions.map((f) => f.FunctionName);
    functions.push(...funcNames);
  }

  console.log("Functions:");
  console.log(functions.join("\n"));
  return functions;
};
```

- For API details, see [ListFunctions](#) in *AWS SDK for JavaScript API Reference*.

Python

SDK for Python (Boto3)

Note

There's more on GitHub. Find the complete example and learn how to set up and run in the [AWS Code Examples Repository](#).

```
import boto3

def main():
    """
    List the Lambda functions in your AWS account.
    """
    # Create the Lambda client
    lambda_client = boto3.client("lambda")

    # Use the paginator to list the functions
    paginator = lambda_client.get_paginator("list_functions")
    response_iterator = paginator.paginate()

    print("Here are the Lambda functions in your account:")
    for page in response_iterator:
        for function in page["Functions"]:
            print(f" {function['FunctionName']}")

if __name__ == "__main__":
    main()
```

- For API details, see [ListFunctions](#) in *AWS SDK for Python (Boto3) API Reference*.

Ruby

SDK for Ruby

Note

There's more on GitHub. Find the complete example and learn how to set up and run in the [AWS Code Examples Repository](#).

```
require 'aws-sdk-lambda'
```

```
# Creates an AWS Lambda client using the default credentials and configuration
def lambda_client
  Aws::Lambda::Client.new
end

# Lists the Lambda functions in your AWS account, paginating the results if
# necessary
def list_lambda_functions
  lambda = lambda_client

  # Use a pagination iterator to list all functions
  functions = []
  lambda.list_functions.each_page do |page|
    functions.concat(page.functions)
  end

  # Print the name and ARN of each function
  functions.each do |function|
    puts "Function name: #{function.function_name}"
    puts "Function ARN: #{function.function_arn}"
    puts
  end

  puts "Total functions: #{functions.count}"
end

list_lambda_functions if __FILE__ == $PROGRAM_NAME
```

- For API details, see [ListFunctions](#) in *AWS SDK for Ruby API Reference*.

For a complete list of AWS SDK developer guides and code examples, see [Using Lambda with an AWS SDK](#). This topic also includes information about getting started and details about previous SDK versions.

Learn the basics of Lambda with an AWS SDK

The following code examples show how to:

- Create an IAM role and Lambda function, then upload handler code.
- Invoke the function with a single parameter and get results.

- Update the function code and configure with an environment variable.
- Invoke the function with new parameters and get results. Display the returned execution log.
- List the functions for your account, then clean up resources.

For more information, see [Create a Lambda function with the console](#).

.NET

AWS SDK for .NET

Note

There's more on GitHub. Find the complete example and learn how to set up and run in the [AWS Code Examples Repository](#).

Create methods that perform Lambda actions.

```
namespace LambdaActions;

using Amazon.Lambda;
using Amazon.Lambda.Model;

/// <summary>
/// A class that implements AWS Lambda methods.
/// </summary>
public class LambdaWrapper
{
    private readonly IAmazonLambda _lambdaService;

    /// <summary>
    /// Constructor for the LambdaWrapper class.
    /// </summary>
    /// <param name="lambdaService">An initialized Lambda service client.</param>
    public LambdaWrapper(IAmazonLambda lambdaService)
    {
        _lambdaService = lambdaService;
    }

    /// <summary>
    /// Creates a new Lambda function.
```

```
/// </summary>
/// <param name="functionName">The name of the function.</param>
/// <param name="s3Bucket">The Amazon Simple Storage Service (Amazon S3)
/// bucket where the zip file containing the code is located.</param>
/// <param name="s3Key">The Amazon S3 key of the zip file.</param>
/// <param name="role">The Amazon Resource Name (ARN) of a role with the
/// appropriate Lambda permissions.</param>
/// <param name="handler">The name of the handler function.</param>
/// <returns>The Amazon Resource Name (ARN) of the newly created
/// Lambda function.</returns>
public async Task<string> CreateLambdaFunctionAsync(
    string functionName,
    string s3Bucket,
    string s3Key,
    string role,
    string handler)
{
    // Defines the location for the function code.
    // S3Bucket - The S3 bucket where the file containing
    //           the source code is stored.
    // S3Key    - The name of the file containing the code.
    var functionCode = new FunctionCode
    {
        S3Bucket = s3Bucket,
        S3Key = s3Key,
    };

    var createFunctionRequest = new CreateFunctionRequest
    {
        FunctionName = functionName,
        Description = "Created by the Lambda .NET API",
        Code = functionCode,
        Handler = handler,
        Runtime = Runtime.Dotnet6,
        Role = role,
    };

    var reponse = await
_lambdaService.CreateFunctionAsync(createFunctionRequest);
    return reponse.FunctionArn;
}

/// <summary>
```

```
/// Delete an AWS Lambda function.
/// </summary>
/// <param name="functionName">The name of the Lambda function to
/// delete.</param>
/// <returns>A Boolean value that indicates the success of the action.</
returns>
public async Task<bool> DeleteFunctionAsync(string functionName)
{
    var request = new DeleteFunctionRequest
    {
        FunctionName = functionName,
    };

    var response = await _lambdaService.DeleteFunctionAsync(request);

    // A return value of NoContent means that the request was processed.
    // In this case, the function was deleted, and the return value
    // is intentionally blank.
    return response.HttpStatusCode == System.Net.HttpStatusCode.NoContent;
}

/// <summary>
/// Gets information about a Lambda function.
/// </summary>
/// <param name="functionName">The name of the Lambda function for
/// which to retrieve information.</param>
/// <returns>Async Task.</returns>
public async Task<FunctionConfiguration> GetFunctionAsync(string
functionName)
{
    var functionRequest = new GetFunctionRequest
    {
        FunctionName = functionName,
    };

    var response = await _lambdaService.GetFunctionAsync(functionRequest);
    return response.Configuration;
}

/// <summary>
/// Invoke a Lambda function.
/// </summary>
```



```
    /// <param name="functionName">The name of the Lambda function to
    /// invoke.</param>
    /// <param name="parameters">The parameter values that will be passed to the
function.</param>
    /// <returns>A System Threading Task.</returns>
    public async Task<string> InvokeFunctionAsync(
        string functionName,
        string parameters)
    {
        var payload = parameters;
        var request = new InvokeRequest
        {
            FunctionName = functionName,
            Payload = payload,
        };

        var response = await _lambdaService.InvokeAsync(request);
        MemoryStream stream = response.Payload;
        string returnValue =
System.Text.Encoding.UTF8.GetString(stream.ToArray());
        return returnValue;
    }

    /// <summary>
    /// Get a list of Lambda functions.
    /// </summary>
    /// <returns>A list of FunctionConfiguration objects.</returns>
    public async Task<List<FunctionConfiguration>> ListFunctionsAsync()
    {
        var functionList = new List<FunctionConfiguration>();

        var functionPaginator =
            _lambdaService.Paginators.ListFunctions(new ListFunctionsRequest());
        await foreach (var function in functionPaginator.Functions)
        {
            functionList.Add(function);
        }

        return functionList;
    }

    /// <summary>
```

```
/// Update an existing Lambda function.
/// </summary>
/// <param name="functionName">The name of the Lambda function to update.</
param>
/// <param name="bucketName">The bucket where the zip file containing
/// the Lambda function code is stored.</param>
/// <param name="key">The key name of the source code file.</param>
/// <returns>Async Task.</returns>
public async Task UpdateFunctionCodeAsync(
    string functionName,
    string bucketName,
    string key)
{
    var functionCodeRequest = new UpdateFunctionCodeRequest
    {
        FunctionName = functionName,
        Publish = true,
        S3Bucket = bucketName,
        S3Key = key,
    };

    var response = await
_lambdaService.UpdateFunctionCodeAsync(functionCodeRequest);
    Console.WriteLine($"The Function was last modified at
{response.LastModified}.");
}

/// <summary>
/// Update the code of a Lambda function.
/// </summary>
/// <param name="functionName">The name of the function to update.</param>
/// <param name="functionHandler">The code that performs the function's
actions.</param>
/// <param name="environmentVariables">A dictionary of environment
variables.</param>
/// <returns>A Boolean value indicating the success of the action.</returns>
public async Task<bool> UpdateFunctionConfigurationAsync(
    string functionName,
    string functionHandler,
    Dictionary<string, string> environmentVariables)
{
    var request = new UpdateFunctionConfigurationRequest
    {
```

```
        Handler = functionHandler,
        FunctionName = functionName,
        Environment = new Amazon.Lambda.Model.Environment { Variables =
environmentVariables },
    };

    var response = await
_lambdaService.UpdateFunctionConfigurationAsync(request);

    Console.WriteLine(response.LastModified);

    return response.HttpStatusCode == System.Net.HttpStatusCode.OK;
}
}
```

Create a function that runs the scenario.

```
global using System.Threading.Tasks;
global using Amazon.IdentityManagement;
global using Amazon.Lambda;
global using LambdaActions;
global using LambdaScenarioCommon;
global using Microsoft.Extensions.DependencyInjection;
global using Microsoft.Extensions.Hosting;
global using Microsoft.Extensions.Logging;
global using Microsoft.Extensions.Logging.Console;
global using Microsoft.Extensions.Logging.Debug;

using Amazon.Lambda.Model;
using Microsoft.Extensions.Configuration;

namespace LambdaBasics;

public class LambdaBasics
{
    private static ILogger logger = null!;

    static async Task Main(string[] args)
```

```

{
    // Set up dependency injection for the Amazon service.
    using var host = Host.CreateDefaultBuilder(args)
        .ConfigureLogging(logging =>
            logging.AddFilter("System", LogLevel.Debug)
                .AddFilter<DebugLoggerProvider>("Microsoft",
                    LogLevel.Information)
                .AddFilter<ConsoleLoggerProvider>("Microsoft",
                    LogLevel.Trace))
        .ConfigureServices((_, services) =>
            services.AddAWSService<IAmazonLambda>()
                .AddAWSService<IAmazonIdentityManagementService>()
                .AddTransient<LambdaWrapper>()
                .AddTransient<LambdaRoleWrapper>()
                .AddTransient<UIWrapper>()
        )
        .Build();

    var configuration = new ConfigurationBuilder()
        .SetBasePath(Directory.GetCurrentDirectory())
        .AddJsonFile("settings.json") // Load test settings from .json file.
        .AddJsonFile("settings.local.json",
            true) // Optionally load local settings.
        .Build();

    logger = LoggerFactory.Create(builder => { builder.AddConsole(); })
        .CreateLogger<LambdaBasics>();

    var lambdaWrapper = host.Services.GetRequiredService<LambdaWrapper>();
    var lambdaRoleWrapper =
        host.Services.GetRequiredService<LambdaRoleWrapper>();
    var uiWrapper = host.Services.GetRequiredService<UIWrapper>();

    string functionName = configuration["FunctionName"]!;
    string roleName = configuration["RoleName"]!;
    string policyDocument = "{" +
        "  \"Version\": \"2012-10-17\", " +
        "  \"Statement\": [ " +
        "    { " +
        "      \"Effect\": \"Allow\", " +
        "      \"Principal\": { " +
        "        \"Service\": \"lambda.amazonaws.com\" " +
        "      }, " +

```

```
        "        \\"Action\\": \\"sts:AssumeRole\\" " +
        "    }" +
        "]" +
    "};

    var incrementHandler = configuration["IncrementHandler"];
    var calculatorHandler = configuration["CalculatorHandler"];
    var bucketName = configuration["BucketName"];
    var incrementKey = configuration["IncrementKey"];
    var calculatorKey = configuration["CalculatorKey"];
    var policyArn = configuration["PolicyArn"];

    uiWrapper.DisplayLambdaBasicsOverview();

    // Create the policy to use with the AWS Lambda functions and then attach
the
    // policy to a new role.
    var roleArn = await lambdaRoleWrapper.CreateLambdaRoleAsync(roleName,
policyDocument);

    Console.WriteLine("Waiting for role to become active.");
    uiWrapper.WaitABit(15, "Wait until the role is active before trying to
use it.");

    // Attach the appropriate AWS Identity and Access Management (IAM) role
policy to the new role.
    var success = await
lambdaRoleWrapper.AttachLambdaRolePolicyAsync(policyArn, roleName);
    uiWrapper.WaitABit(10, "Allow time for the IAM policy to be attached to
the role.");

    // Create the Lambda function using a zip file stored in an Amazon Simple
Storage Service
    // (Amazon S3) bucket.
    uiWrapper.DisplayTitle("Create Lambda Function");
    Console.WriteLine($"Creating the AWS Lambda function: {functionName}.");
    var lambdaArn = await lambdaWrapper.CreateLambdaFunctionAsync(
        functionName,
        bucketName,
        incrementKey,
        roleArn,
        incrementHandler);

    Console.WriteLine("Waiting for the new function to be available.");
```

```
Console.WriteLine($"The AWS Lambda ARN is {lambdaArn}");

// Get the Lambda function.
Console.WriteLine($"Getting the {functionName} AWS Lambda function.");
FunctionConfiguration config;
do
{
    config = await lambdaWrapper.GetFunctionAsync(functionName);
    Console.Write(".");
}
while (config.State != State.Active);

Console.WriteLine($"\\nThe function, {functionName} has been created.");
Console.WriteLine($"The runtime of this Lambda function is
{config.Runtime}.");

uiWrapper.PressEnter();

// List the Lambda functions.
uiWrapper.DisplayTitle("Listing all Lambda functions.");
var functions = await lambdaWrapper.ListFunctionsAsync();
DisplayFunctionList(functions);

uiWrapper.DisplayTitle("Invoke increment function");
Console.WriteLine("Now that it has been created, invoke the Lambda
increment function.");
string? value;
do
{
    Console.Write("Enter a value to increment: ");
    value = Console.ReadLine();
}
while (string.IsNullOrEmpty(value));

string functionParameters = "{" +
    "\\\"action\\\": \\\"increment\\\", " +
    "\\\"x\\\": \\\"" + value + "\\\" " +
    "}";
var answer = await lambdaWrapper.InvokeFunctionAsync(functionName,
functionParameters);
Console.WriteLine($"{value} + 1 = {answer}.");

uiWrapper.DisplayTitle("Update function");
Console.WriteLine("Now update the Lambda function code.");
```

```
    await lambdaWrapper.UpdateFunctionCodeAsync(functionName, bucketName,
calculatorKey);

    do
    {
        config = await lambdaWrapper.GetFunctionAsync(functionName);
        Console.WriteLine(".");
    }
    while (config.LastUpdateStatus == LastUpdateStatus.InProgress);

    await lambdaWrapper.UpdateFunctionConfigurationAsync(
        functionName,
        calculatorHandler,
        new Dictionary<string, string> { { "LOG_LEVEL", "DEBUG" } });

    do
    {
        config = await lambdaWrapper.GetFunctionAsync(functionName);
        Console.WriteLine(".");
    }
    while (config.LastUpdateStatus == LastUpdateStatus.InProgress);

    uiWrapper.DisplayTitle("Call updated function");
    Console.WriteLine("Now call the updated function...");

    bool done = false;

    do
    {
        string? opSelected;

        Console.WriteLine("Select the operation to perform:");
        Console.WriteLine("\t1. add");
        Console.WriteLine("\t2. subtract");
        Console.WriteLine("\t3. multiply");
        Console.WriteLine("\t4. divide");
        Console.WriteLine("\t0r enter \"q\" to quit.");
        Console.WriteLine("Enter the number (1, 2, 3, 4, or q) of the
operation you want to perform: ");
        do
        {
            Console.WriteLine("Your choice? ");
            opSelected = Console.ReadLine();
        }
    }
```

```
while (opSelected == string.Empty);

var operation = (opSelected) switch
{
    "1" => "add",
    "2" => "subtract",
    "3" => "multiply",
    "4" => "divide",
    "q" => "quit",
    _ => "add",
};

if (operation == "quit")
{
    done = true;
}
else
{
    // Get two numbers and an action from the user.
    value = string.Empty;
    do
    {
        Console.WriteLine("Enter the first value: ");
        value = Console.ReadLine();
    }
    while (value == string.Empty);

    string? value2;
    do
    {
        Console.WriteLine("Enter a second value: ");
        value2 = Console.ReadLine();
    }
    while (value2 == string.Empty);

    functionParameters = "{" +
        "\"action\": \"" + operation + "\", " +
        "\"x\": \"" + value + "\", " +
        "\"y\": \"" + value2 + "\"" +
        "}";

    answer = await lambdaWrapper.InvokeFunctionAsync(functionName,
functionParameters);
```



```
        Console.WriteLine($"The answer when we {operation} the two
numbers is: {answer}.");
    }

    uiWrapper.PressEnter();
} while (!done);

// Delete the function created earlier.

uiWrapper.DisplayTitle("Clean up resources");
// Detach the IAM policy from the IAM role.
Console.WriteLine("First detach the IAM policy from the role.");
success = await lambdaRoleWrapper.DetachLambdaRolePolicyAsync(policyArn,
roleName);
uiWrapper.WaitABit(15, "Let's wait for the policy to be fully detached
from the role.");

Console.WriteLine("Delete the AWS Lambda function.");
success = await lambdaWrapper.DeleteFunctionAsync(functionName);
if (success)
{
    Console.WriteLine($"The {functionName} function was deleted.");
}
else
{
    Console.WriteLine($"Could not remove the function {functionName}");
}

// Now delete the IAM role created for use with the functions
// created by the application.
Console.WriteLine("Now we can delete the role that we created.");
success = await lambdaRoleWrapper.DeleteLambdaRoleAsync(roleName);
if (success)
{
    Console.WriteLine("The role has been successfully removed.");
}
else
{
    Console.WriteLine("Couldn't delete the role.");
}

Console.WriteLine("The Lambda Scenario is now complete.");
uiWrapper.PressEnter();
```

```
// Displays a formatted list of existing functions returned by the
// LambdaMethods.ListFunctions.
void DisplayFunctionList(List<FunctionConfiguration> functions)
{
    functions.ForEach(functionConfig =>
    {
        Console.WriteLine($"{functionConfig.FunctionName}\t{functionConfig.Description}");
    });
}

namespace LambdaActions;

using Amazon.IdentityManagement;
using Amazon.IdentityManagement.Model;

public class LambdaRoleWrapper
{
    private readonly IAmazonIdentityManagementService _lambdaRoleService;

    public LambdaRoleWrapper(IAmazonIdentityManagementService lambdaRoleService)
    {
        _lambdaRoleService = lambdaRoleService;
    }

    /// <summary>
    /// Attach an AWS Identity and Access Management (IAM) role policy to the
    /// IAM role to be assumed by the AWS Lambda functions created for the
    scenario.
    /// </summary>
    /// <param name="policyArn">The Amazon Resource Name (ARN) of the IAM
    policy.</param>
    /// <param name="roleName">The name of the IAM role to attach the IAM policy
    to.</param>
    /// <returns>A Boolean value indicating the success of the action.</returns>
    public async Task<bool> AttachLambdaRolePolicyAsync(string policyArn, string
    roleName)
    {
        var response = await _lambdaRoleService.AttachRolePolicyAsync(new
    AttachRolePolicyRequest { PolicyArn = policyArn, RoleName = roleName });
        return response.HttpStatusCode == System.Net.HttpStatusCode.OK;
    }
}
```

```
    }

    /// <summary>
    /// Create a new IAM role.
    /// </summary>
    /// <param name="roleName">The name of the IAM role to create.</param>
    /// <param name="policyDocument">The policy document for the new IAM role.</
param>
    /// <returns>A string representing the ARN for newly created role.</returns>
    public async Task<string> CreateLambdaRoleAsync(string roleName, string
policyDocument)
    {
        var request = new CreateRoleRequest
        {
            AssumeRolePolicyDocument = policyDocument,
            RoleName = roleName,
        };

        var response = await _lambdaRoleService.CreateRoleAsync(request);
        return response.Role.Arn;
    }

    /// <summary>
    /// Deletes an IAM role.
    /// </summary>
    /// <param name="roleName">The name of the role to delete.</param>
    /// <returns>A Boolean value indicating the success of the operation.</
returns>
    public async Task<bool> DeleteLambdaRoleAsync(string roleName)
    {
        var request = new DeleteRoleRequest
        {
            RoleName = roleName,
        };

        var response = await _lambdaRoleService.DeleteRoleAsync(request);
        return response.HttpStatusCode == System.Net.HttpStatusCode.OK;
    }

    public async Task<bool> DetachLambdaRolePolicyAsync(string policyArn, string
roleName)
    {
        var response = await _lambdaRoleService.DetachRolePolicyAsync(new
DetachRolePolicyRequest { PolicyArn = policyArn, RoleName = roleName });
    }
}
```

```
        return response.HttpStatusCode == System.Net.HttpStatusCode.OK;
    }
}

namespace LambdaScenarioCommon;
public class UIWrapper
{
    public readonly string SepBar = new('-', Console.WindowWidth);

    /// <summary>
    /// Show information about the AWS Lambda Basics scenario.
    /// </summary>
    public void DisplayLambdaBasicsOverview()
    {
        Console.Clear();

        DisplayTitle("Welcome to AWS Lambda Basics");
        Console.WriteLine("This example application does the following:");
        Console.WriteLine("\t1. Creates an AWS Identity and Access Management
(IAM) role that will be assumed by the functions we create.");
        Console.WriteLine("\t2. Attaches an IAM role policy that has Lambda
permissions.");
        Console.WriteLine("\t3. Creates a Lambda function that increments the
value passed to it.");
        Console.WriteLine("\t4. Calls the increment function and passes a
value.");
        Console.WriteLine("\t5. Updates the code so that the function is a simple
calculator.");
        Console.WriteLine("\t6. Calls the calculator function with the values
entered.");
        Console.WriteLine("\t7. Deletes the Lambda function.");
        Console.WriteLine("\t7. Detaches the IAM role policy.");
        Console.WriteLine("\t8. Deletes the IAM role.");
        PressEnter();
    }

    /// <summary>
    /// Display a message and wait until the user presses enter.
    /// </summary>
    public void PressEnter()
    {
        Console.Write("\nPress <Enter> to continue. ");
        _ = Console.ReadLine();
    }
}
```

```
        Console.WriteLine();
    }

    /// <summary>
    /// Pad a string with spaces to center it on the console display.
    /// </summary>
    /// <param name="strToCenter">The string to be centered.</param>
    /// <returns>The padded string.</returns>
    public string CenterString(string strToCenter)
    {
        var padAmount = (Console.WindowWidth - strToCenter.Length) / 2;
        var leftPad = new string(' ', padAmount);
        return $"{leftPad}{strToCenter}";
    }

    /// <summary>
    /// Display a line of hyphens, the centered text of the title and another
    /// line of hyphens.
    /// </summary>
    /// <param name="strTitle">The string to be displayed.</param>
    public void DisplayTitle(string strTitle)
    {
        Console.WriteLine(SepBar);
        Console.WriteLine(CenterString(strTitle));
        Console.WriteLine(SepBar);
    }

    /// <summary>
    /// Display a countdown and wait for a number of seconds.
    /// </summary>
    /// <param name="numSeconds">The number of seconds to wait.</param>
    public void WaitABit(int numSeconds, string msg)
    {
        Console.WriteLine(msg);

        // Wait for the requested number of seconds.
        for (int i = numSeconds; i > 0; i--)
        {
            System.Threading.Thread.Sleep(1000);
            Console.Write($"{i}...");
        }

        PressEnter();
    }
}
```

```
}
```

Define a Lambda handler that increments a number.

```
using Amazon.Lambda.Core;

// Assembly attribute to enable the Lambda function's JSON input to be converted
// into a .NET class.
[assembly:
    LambdaSerializer(typeof(Amazon.Lambda.Serialization.SystemTextJson.DefaultLambdaJsonSerializer))]

namespace LambdaIncrement;

public class Function
{
    /// <summary>
    /// A simple function increments the integer parameter.
    /// </summary>
    /// <param name="input">A JSON string containing an action, which must be
    /// "increment" and a string representing the value to increment.</param>
    /// <param name="context">The context object passed by Lambda containing
    /// information about invocation, function, and execution environment.</
    param>
    /// <returns>A string representing the incremented value of the parameter.</
    returns>
    public int FunctionHandler(Dictionary<string, string> input, ILambdaContext
    context)
    {
        if (input["action"] == "increment")
        {
            int inputValue = Convert.ToInt32(input["x"]);
            return inputValue + 1;
        }
        else
        {
            return 0;
        }
    }
}
```

Define a second Lambda handler that performs arithmetic operations.

```
using Amazon.Lambda.Core;

// Assembly attribute to enable the Lambda function's JSON input to be converted
// into a .NET class.
[assembly:
    LambdaSerializer(typeof(Amazon.Lambda.Serialization.SystemTextJson.DefaultLambdaJsonSerializer))]

namespace LambdaCalculator;

public class Function
{
    /// <summary>
    /// A simple function that takes two number in string format and performs
    /// the requested arithmetic function.
    /// </summary>
    /// <param name="input">JSON data containing an action, and x and y values.
    /// Valid actions include: add, subtract, multiply, and divide.</param>
    /// <param name="context">The context object passed by Lambda containing
    /// information about invocation, function, and execution environment.</
    param>
    /// <returns>A string representing the results of the calculation.</returns>
    public int FunctionHandler(Dictionary<string, string> input, ILambdaContext
    context)
    {
        var action = input["action"];
        int x = Convert.ToInt32(input["x"]);
        int y = Convert.ToInt32(input["y"]);
        int result;
        switch (action)
        {
            case "add":
                result = x + y;
                break;
            case "subtract":
                result = x - y;
                break;
            case "multiply":
                result = x * y;
```

```
        break;
    case "divide":
        if (y == 0)
        {
            Console.Error.WriteLine("Divide by zero error.");
            result = 0;
        }
        else
            result = x / y;
        break;
    default:
        Console.Error.WriteLine($"{action} is not a valid operation.");
        result = 0;
        break;
    }
    return result;
}
}
```

- For API details, see the following topics in *AWS SDK for .NET API Reference*.
 - [CreateFunction](#)
 - [DeleteFunction](#)
 - [GetFunction](#)
 - [Invoke](#)
 - [ListFunctions](#)
 - [UpdateFunctionCode](#)
 - [UpdateFunctionConfiguration](#)

C++

SDK for C++

Note

There's more on GitHub. Find the complete example and learn how to set up and run in the [AWS Code Examples Repository](#).

```
//! Get started with functions scenario.
/*!
 \param clientConfig: AWS client configuration.
 \return bool: Successful completion.
 */
bool AwsDoc::Lambda::getStartedWithFunctionsScenario(
    const Aws::Client::ClientConfiguration &clientConfig) {

    Aws::Lambda::LambdaClient client(clientConfig);

    // 1. Create an AWS Identity and Access Management (IAM) role for Lambda
    function.
    Aws::String roleArn;
    if (!getIamRoleArn(roleArn, clientConfig)) {
        return false;
    }

    // 2. Create a Lambda function.
    int seconds = 0;
    do {
        Aws::Lambda::Model::CreateFunctionRequest request;
        request.SetFunctionName(LAMBDA_NAME);
        request.SetDescription(LAMBDA_DESCRIPTION); // Optional.
#if USE_CPP_LAMBDA_FUNCTION
        request.SetRuntime(Aws::Lambda::Model::Runtime::provided_al2);
        request.SetTimeout(15);
        request.SetMemorySize(128);

        // Assume the AWS Lambda function was built in Docker with same
        architecture
        // as this code.
#if defined(__x86_64__)
            request.SetArchitectures({Aws::Lambda::Model::Architecture::x86_64});
#elif defined(__aarch64__)
            request.SetArchitectures({Aws::Lambda::Model::Architecture::arm64});
#else
            #error "Unimplemented architecture"
#endif // defined(architecture)
#else
        request.SetRuntime(Aws::Lambda::Model::Runtime::python3_9);
#endif
        request.SetRole(roleArn);
        request.SetHandler(LAMBDA_HANDLER_NAME);
```

```

    request.SetPublish(true);
    Aws::Lambda::Model::FunctionCode code;
    std::ifstream ifstream(INCREMENT_LAMBDA_CODE.c_str(),
                           std::ios_base::in | std::ios_base::binary);
    if (!ifstream.is_open()) {
        std::cerr << "Error opening file " << INCREMENT_LAMBDA_CODE << "." <<
std::endl;

#if USE_CPP_LAMBDA_FUNCTION
        std::cerr
            << "The cpp Lambda function must be built following the
instructions in the cpp_lambda/README.md file. "
            << std::endl;
#endif

        deleteIamRole(clientConfig);
        return false;
    }

    Aws::StringStream buffer;
    buffer << ifstream.rdbuf();

    code.SetZipFile(Aws::Utils::ByteBuffer((unsigned char *)
buffer.str().c_str(),
                                           buffer.str().length()));
    request.SetCode(code);

    Aws::Lambda::Model::CreateFunctionOutcome outcome =
client.CreateFunction(
    request);

    if (outcome.IsSuccess()) {
        std::cout << "The lambda function was successfully created. " <<
seconds
            << " seconds elapsed." << std::endl;
        break;
    }
    else if (outcome.GetError().GetErrorType() ==
        Aws::Lambda::LambdaErrors::INVALID_PARAMETER_VALUE &&
        outcome.GetError().GetMessage().find("role") >= 0) {
        if ((seconds % 5) == 0) { // Log status every 10 seconds.
            std::cout
                << "Waiting for the IAM role to become available as a
CreateFunction parameter. "
                << seconds

```

```

        << " seconds elapsed." << std::endl;

        std::cout << outcome.GetError().GetMessage() << std::endl;
    }
}
else {
    std::cerr << "Error with CreateFunction. "
        << outcome.GetError().GetMessage()
        << std::endl;
    deleteIamRole(clientConfig);
    return false;
}
++seconds;
std::this_thread::sleep_for(std::chrono::seconds(1));
} while (60 > seconds);

std::cout << "The current Lambda function increments 1 by an input." <<
std::endl;

// 3. Invoke the Lambda function.
{
    int increment = askQuestionForInt("Enter an increment integer: ");

    Aws::Lambda::Model::InvokeResult invokeResult;
    Aws::Utils::Json::JsonValue jsonPayload;
    jsonPayload.WithString("action", "increment");
    jsonPayload.WithInteger("number", increment);
    if (invokeLambdaFunction(jsonPayload, Aws::Lambda::Model::LogType::Tail,
        invokeResult, client)) {
        Aws::Utils::Json::JsonValue jsonValue(invokeResult.GetPayload());
        Aws::Map<Aws::String, Aws::Utils::Json::JsonValue> values =
            jsonValue.View().GetAllObjects();
        auto iter = values.find("result");
        if (iter != values.end() && iter->second.IsIntegerType()) {
            {
                std::cout << INCREMENT_RESULT_PREFIX
                    << iter->second.AsInteger() << std::endl;
            }
        }
    }
    else {
        std::cout << "There was an error in execution. Here is the log."
            << std::endl;
        Aws::Utils::ByteBuffer buffer =
        Aws::Utils::HashingUtils::Base64Decode(

```

```
        invokeResult.GetLogResult());
        std::cout << "With log " << buffer.GetUnderlyingData() <<
std::endl;
    }
}

std::cout
    << "The Lambda function will now be updated with new code. Press
return to continue, ";
    Aws::String answer;
    std::getline(std::cin, answer);

// 4. Update the Lambda function code.
{
    Aws::Lambda::Model::UpdateFunctionCodeRequest request;
    request.SetFunctionName(LAMBDA_NAME);
    std::ifstream ifstream(CALCULATOR_LAMBDA_CODE.c_str(),
                           std::ios_base::in | std::ios_base::binary);
    if (!ifstream.is_open()) {
        std::cerr << "Error opening file " << INCREMENT_LAMBDA_CODE << "." <<
std::endl;
    }

#ifdef USE_CPP_LAMBDA_FUNCTION
    std::cerr
        << "The cpp Lambda function must be built following the
instructions in the cpp_lambda/README.md file. "
        << std::endl;
#endif

    deleteLambdaFunction(client);
    deleteIamRole(clientConfig);
    return false;
}

    Aws::StringStream buffer;
    buffer << ifstream.rdbuf();
    request.SetZipFile(
        Aws::Utils::ByteBuffer((unsigned char *) buffer.str().c_str(),
                               buffer.str().length()));

    request.SetPublish(true);

    Aws::Lambda::Model::UpdateFunctionCodeOutcome outcome =
client.UpdateFunctionCode(
    request);
```

```
        if (outcome.IsSuccess()) {
            std::cout << "The lambda code was successfully updated." <<
std::endl;
        }
        else {
            std::cerr << "Error with Lambda::UpdateFunctionCode. "
                << outcome.GetError().GetMessage()
                << std::endl;
        }
    }

    std::cout
        << "This function uses an environment variable to control the logging
level."
        << std::endl;
    std::cout
        << "UpdateFunctionConfiguration will be used to set the LOG_LEVEL to
DEBUG."
        << std::endl;
    seconds = 0;

    // 5. Update the Lambda function configuration.
    do {
        ++seconds;
        std::this_thread::sleep_for(std::chrono::seconds(1));
        Aws::Lambda::Model::UpdateFunctionConfigurationRequest request;
        request.SetFunctionName(LAMBDA_NAME);
        Aws::Lambda::Model::Environment environment;
        environment.AddVariables("LOG_LEVEL", "DEBUG");
        request.SetEnvironment(environment);

        Aws::Lambda::Model::UpdateFunctionConfigurationOutcome outcome =
client.UpdateFunctionConfiguration(
            request);

        if (outcome.IsSuccess()) {
            std::cout << "The lambda configuration was successfully updated."
                << std::endl;
            break;
        }

        // RESOURCE_IN_USE: function code update not completed.
        else if (outcome.GetError().GetErrorType() !=
```

```

        Aws::Lambda::LambdaErrors::RESOURCE_IN_USE) {
    if ((seconds % 10) == 0) { // Log status every 10 seconds.
        std::cout << "Lambda function update in progress . After " <<
seconds
                << " seconds elapsed." << std::endl;
    }
}
else {
    std::cerr << "Error with Lambda::UpdateFunctionConfiguration. "
        << outcome.GetError().GetMessage()
        << std::endl;
}

} while (0 < seconds);

if (0 > seconds) {
    std::cerr << "Function failed to become active." << std::endl;
}
else {
    std::cout << "Updated function active after " << seconds << " seconds."
        << std::endl;
}

std::cout
    << "\n\nThe new code applies an arithmetic operator to two variables, x
an y."
    << std::endl;
std::vector<Aws::String> operators = {"plus", "minus", "times", "divided-
by"};
for (size_t i = 0; i < operators.size(); ++i) {
    std::cout << "    " << i + 1 << " " << operators[i] << std::endl;
}

// 6. Invoke the updated Lambda function.
do {
    int operatorIndex = askQuestionForIntRange("Select an operator index 1 -
4 ", 1,
                                                4);
    int x = askQuestionForInt("Enter an integer for the x value ");
    int y = askQuestionForInt("Enter an integer for the y value ");

    Aws::Utils::Json::JsonValue calculateJsonPayload;
    calculateJsonPayload.WithString("action", operators[operatorIndex - 1]);
    calculateJsonPayload.WithInteger("x", x);

```

```

    calculateJsonPayload.WithInteger("y", y);
    Aws::Lambda::Model::InvokeResult calculatedResult;
    if (invokeLambdaFunction(calculateJsonPayload,
                            Aws::Lambda::Model::LogType::Tail,
                            calculatedResult, client)) {
        Aws::Utils::Json::JsonValue jsonValue(calculatedResult.GetPayload());
        Aws::Map<Aws::String, Aws::Utils::Json::JsonValue> values =
            jsonValue.View().GetAllObjects();
        auto iter = values.find("result");
        if (iter != values.end() && iter->second.IsIntegerType()) {
            std::cout << ARITHMETIC_RESULT_PREFIX << x << " "
                << operators[operatorIndex - 1] << " "
                << y << " is " << iter->second.AsInteger() <<
std::endl;
        }
        else if (iter != values.end() && iter->second.IsFloatingPointType())
    {
            std::cout << ARITHMETIC_RESULT_PREFIX << x << " "
                << operators[operatorIndex - 1] << " "
                << y << " is " << iter->second.AsDouble() << std::endl;
        }
        else {
            std::cout << "There was an error in execution. Here is the log."
                << std::endl;
            Aws::Utils::ByteBuffer buffer =
    Aws::Utils::HashingUtils::Base64Decode(
                calculatedResult.GetLogResult());
            std::cout << "With log " << buffer.GetUnderlyingData() <<
std::endl;
        }
    }

    answer = askQuestion("Would you like to try another operation? (y/n) ");
    } while (answer == "y");

    std::cout
        << "A list of the lambda functions will be retrieved. Press return to
continue, ";
    std::getline(std::cin, answer);

    // 7. List the Lambda functions.

    std::vector<Aws::String> functions;
    Aws::String marker;

```

```

do {
    Aws::Lambda::Model::ListFunctionsRequest request;
    if (!marker.empty()) {
        request.SetMarker(marker);
    }

    Aws::Lambda::Model::ListFunctionsOutcome outcome = client.ListFunctions(
        request);

    if (outcome.IsSuccess()) {
        const Aws::Lambda::Model::ListFunctionsResult &result =
outcome.GetResult();
        std::cout << result.GetFunctions().size()
            << " lambda functions were retrieved." << std::endl;

        for (const Aws::Lambda::Model::FunctionConfiguration
&functionConfiguration: result.GetFunctions()) {
            functions.push_back(functionConfiguration.GetFunctionName());
            std::cout << functions.size() << " "
                << functionConfiguration.GetDescription() << std::endl;
            std::cout << " "
                <<
Aws::Lambda::Model::RuntimeMapper::GetNameForRuntime(
                    functionConfiguration.GetRuntime()) << ": "
                << functionConfiguration.GetHandler()
                << std::endl;
        }
        marker = result.GetNextMarker();
    }
    else {
        std::cerr << "Error with Lambda::ListFunctions. "
            << outcome.GetError().GetMessage()
            << std::endl;
    }
} while (!marker.empty());

// 8. Get a Lambda function.
if (!functions.empty()) {
    std::stringstream question;
    question << "Choose a function to retrieve between 1 and " <<
functions.size()
        << " ";
    int functionIndex = askQuestionForIntRange(question.str(), 1,

```



```
static_cast<int>(functions.size()));

    Aws::String functionName = functions[functionIndex - 1];

    Aws::Lambda::Model::GetFunctionRequest request;
    request.SetFunctionName(functionName);

    Aws::Lambda::Model::GetFunctionOutcome outcome =
    client.GetFunction(request);

    if (outcome.IsSuccess()) {
        std::cout << "Function retrieve.\n" <<
outcome.GetResult().GetConfiguration().Jsonize().View().WriteReadable()
        << std::endl;
    }
    else {
        std::cerr << "Error with Lambda::GetFunction. "
        << outcome.GetError().GetMessage()
        << std::endl;
    }
}

std::cout << "The resources will be deleted. Press return to continue, ";
std::getline(std::cin, answer);

// 9. Delete the Lambda function.
bool result = deleteLambdaFunction(client);

// 10. Delete the IAM role.
return result && deleteIamRole(clientConfig);
}

//! Routine which invokes a Lambda function and returns the result.
/*!
 \param jsonPayload: Payload for invoke function.
 \param logType: Log type setting for invoke function.
 \param invokeResult: InvokeResult object to receive the result.
 \param client: Lambda client.
 \return bool: Successful completion.
 */
bool
```

```

AwsDoc::Lambda::invokeLambdaFunction(const Aws::Utils::Json::JsonValue
&jsonPayload,
                                     Aws::Lambda::Model::LogType logType,
                                     Aws::Lambda::Model::InvokeResult
&invokeResult,
                                     const Aws::Lambda::LambdaClient &client) {
    int seconds = 0;
    bool result = false;
    /*
     * In this example, the Invoke function can be called before recently created
resources are
     * available. The Invoke function is called repeatedly until the resources
are
     * available.
     */
    do {
        Aws::Lambda::Model::InvokeRequest request;
        request.SetFunctionName(LAMBDA_NAME);
        request.SetLogType(logType);
        std::shared_ptr<Aws::IOStream> payload =
Aws::MakeShared<Aws::StringStream>(
            "FunctionTest");
        *payload << jsonPayload.View().WriteReadable();
        request.SetBody(payload);
        request.SetContentType("application/json");
        Aws::Lambda::Model::InvokeOutcome outcome = client.Invoke(request);

        if (outcome.IsSuccess()) {
            invokeResult = std::move(outcome.GetResult());
            result = true;
            break;
        }

        // ACCESS_DENIED: because the role is not available yet.
        // RESOURCE_CONFLICT: because the Lambda function is being created or
updated.
        else if ((outcome.GetError().GetErrorType() ==
            Aws::Lambda::LambdaErrors::ACCESS_DENIED) ||
            (outcome.GetError().GetErrorType() ==
            Aws::Lambda::LambdaErrors::RESOURCE_CONFLICT)) {
            if ((seconds % 5) == 0) { // Log status every 10 seconds.
                std::cout << "Waiting for the invoke api to be available, status
" <<
                    ((outcome.GetError().GetErrorType() ==

```

```

        Aws::Lambda::LambdaErrors::ACCESS_DENIED ?
        "ACCESS_DENIED" : "RESOURCE_CONFLICT")) << ". " <<
seconds
        << " seconds elapsed." << std::endl;
    }
}
else {
    std::cerr << "Error with Lambda::InvokeRequest. "
        << outcome.GetError().GetMessage()
        << std::endl;
    break;
}
++seconds;
std::this_thread::sleep_for(std::chrono::seconds(1));
} while (seconds < 60);

return result;
}

```

- For API details, see the following topics in *AWS SDK for C++ API Reference*.
 - [CreateFunction](#)
 - [DeleteFunction](#)
 - [GetFunction](#)
 - [Invoke](#)
 - [ListFunctions](#)
 - [UpdateFunctionCode](#)
 - [UpdateFunctionConfiguration](#)

Go

SDK for Go V2

Note

There's more on GitHub. Find the complete example and learn how to set up and run in the [AWS Code Examples Repository](#).

Create an interactive scenario that shows you how to get started with Lambda functions.

```
import (
    "archive/zip"
    "bytes"
    "context"
    "encoding/base64"
    "encoding/json"
    "errors"
    "fmt"
    "log"
    "os"
    "strings"
    "time"

    "github.com/aws/aws-sdk-go-v2/aws"
    "github.com/aws/aws-sdk-go-v2/service/iam"
    iamtypes "github.com/aws/aws-sdk-go-v2/service/iam/types"
    "github.com/aws/aws-sdk-go-v2/service/lambda"
    "github.com/awsdocs/aws-doc-sdk-examples/gov2/demotools"
    "github.com/awsdocs/aws-doc-sdk-examples/gov2/lambda/actions"
)

// GetStartedFunctionsScenario shows you how to use AWS Lambda to perform the
// following
// actions:
//
// 1. Create an AWS Identity and Access Management (IAM) role and Lambda
//    function, then upload handler code.
// 2. Invoke the function with a single parameter and get results.
// 3. Update the function code and configure with an environment variable.
// 4. Invoke the function with new parameters and get results. Display the
//    returned execution log.
// 5. List the functions for your account, then clean up resources.
type GetStartedFunctionsScenario struct {
    sdkConfig      aws.Config
    functionWrapper actions.FunctionWrapper
    questioner     demotools.IQuestioner
    helper         IScenarioHelper
    isTestRun      bool
}
```

```
// NewGetStartedFunctionsScenario constructs a GetStartedFunctionsScenario
instance from a configuration.
// It uses the specified config to get a Lambda client and create wrappers for
the actions
// used in the scenario.
func NewGetStartedFunctionsScenario(sdkConfig aws.Config, questioner
demotools.IQuestioner,
helper IScenarioHelper) GetStartedFunctionsScenario {
lambdaClient := lambda.NewFromConfig(sdkConfig)
return GetStartedFunctionsScenario{
sdkConfig:      sdkConfig,
functionWrapper: actions.FunctionWrapper{LambdaClient: lambdaClient},
questioner:    questioner,
helper:        helper,
}
}

// Run runs the interactive scenario.
func (scenario GetStartedFunctionsScenario) Run(ctx context.Context) {
defer func() {
if r := recover(); r != nil {
log.Printf("Something went wrong with the demo.\n")
}
}()

log.Println(strings.Repeat("-", 88))
log.Println("Welcome to the AWS Lambda get started with functions demo.")
log.Println(strings.Repeat("-", 88))

role := scenario.GetOrCreateRole(ctx)
funcName := scenario.CreateFunction(ctx, role)
scenario.InvokeIncrement(ctx, funcName)
scenario.UpdateFunction(ctx, funcName)
scenario.InvokeCalculator(ctx, funcName)
scenario.ListFunctions(ctx)
scenario.Cleanup(ctx, role, funcName)

log.Println(strings.Repeat("-", 88))
log.Println("Thanks for watching!")
log.Println(strings.Repeat("-", 88))
}

// GetOrCreateRole checks whether the specified role exists and returns it if it
does.
```

```

// Otherwise, a role is created that specifies Lambda as a trusted principal.
// The AWSLambdaBasicExecutionRole managed policy is attached to the role and the
// role
// is returned.
func (scenario GetStartedFunctionsScenario) GetOrCreateRole(ctx context.Context)
    *iamtypes.Role {
    var role *iamtypes.Role
    iamClient := iam.NewFromConfig(scenario.sdkConfig)
    log.Println("First, we need an IAM role that Lambda can assume.")
    roleName := scenario.questioner.Ask("Enter a name for the role:",
    demotools.NotEmpty{})
    getOutput, err := iamClient.GetRole(ctx, &iam.GetRoleInput{
        RoleName: aws.String(roleName)})
    if err != nil {
        var noSuch *iamtypes.NoSuchEntityException
        if errors.As(err, &noSuch) {
            log.Printf("Role %v doesn't exist. Creating it....\n", roleName)
        } else {
            log.Panicf("Couldn't check whether role %v exists. Here's why: %v\n",
                roleName, err)
        }
    } else {
        role = getOutput.Role
        log.Printf("Found role %v.\n", *role.RoleName)
    }
    if role == nil {
        trustPolicy := PolicyDocument{
            Version: "2012-10-17",
            Statement: []PolicyStatement{{
                Effect: "Allow",
                Principal: map[string]string{"Service": "lambda.amazonaws.com"},
                Action: []string{"sts:AssumeRole"},
            }},
        }
        policyArn := "arn:aws:iam::aws:policy/service-role/AWSLambdaBasicExecutionRole"
        createOutput, err := iamClient.CreateRole(ctx, &iam.CreateRoleInput{
            AssumeRolePolicyDocument: aws.String(trustPolicy.String()),
            RoleName: aws.String(roleName),
        })
        if err != nil {
            log.Panicf("Couldn't create role %v. Here's why: %v\n", roleName, err)
        }
        role = createOutput.Role
        _, err = iamClient.AttachRolePolicy(ctx, &iam.AttachRolePolicyInput{

```

```

    PolicyArn: aws.String(policyArn),
    RoleName:  aws.String(roleName),
  })
  if err != nil {
    log.Panicf("Couldn't attach a policy to role %v. Here's why: %v\n", roleName,
err)
  }
  log.Printf("Created role %v.\n", *role.RoleName)
  log.Println("Let's give AWS a few seconds to propagate resources...")
  scenario.helper.Pause(10)
}
log.Println(strings.Repeat("-", 88))
return role
}

// CreateFunction creates a Lambda function and uploads a handler written in
// Python.
// The code for the Python handler is packaged as a []byte in .zip format.
func (scenario GetStartedFunctionsScenario) CreateFunction(ctx context.Context,
role *iamtypes.Role) string {
  log.Println("Let's create a function that increments a number.\n" +
    "The function uses the 'lambda_handler_basic.py' script found in the\n" +
    "'handlers' directory of this project.")
  funcName := scenario.questioner.Ask("Enter a name for the Lambda function:",
demotools.NotEmpty{})
  zipPackage := scenario.helper.CreateDeploymentPackage("lambda_handler_basic.py",
fmt.Sprintf("%v.py", funcName))
  log.Printf("Creating function %v and waiting for it to be ready.", funcName)
  funcState := scenario.functionWrapper.CreateFunction(ctx, funcName,
fmt.Sprintf("%v.lambda_handler", funcName),
  role.Arn, zipPackage)
  log.Printf("Your function is %v.", funcState)
  log.Println(strings.Repeat("-", 88))
  return funcName
}

// InvokeIncrement invokes a Lambda function that increments a number. The
// function
// parameters are contained in a Go struct that is used to serialize the
// parameters to
// a JSON payload that is passed to the function.
// The result payload is deserialized into a Go struct that contains an int
// value.

```

```

func (scenario GetStartedFunctionsScenario) InvokeIncrement(ctx context.Context,
funcName string) {
    parameters := actions.IncrementParameters{Action: "increment"}
    log.Println("Let's invoke our function. This function increments a number.")
    parameters.Number = scenario.questioner.AskInt("Enter a number to increment:",
demotools.NotEmpty{})
    log.Printf("Invoking %v with %v...\n", funcName, parameters.Number)
    invokeOutput := scenario.functionWrapper.Invoke(ctx, funcName, parameters,
false)
    var payload actions.LambdaResultInt
    err := json.Unmarshal(invokeOutput.Payload, &payload)
    if err != nil {
        log.Panicf("Couldn't unmarshal payload from invoking %v. Here's why: %v\n",
funcName, err)
    }
    log.Printf("Invoking %v with %v returned %v.\n", funcName, parameters.Number,
payload)
    log.Println(strings.Repeat("-", 88))
}

// UpdateFunction updates the code for a Lambda function by uploading a simple
arithmetic
// calculator written in Python. The code for the Python handler is packaged as a
// []byte in .zip format.
// After the code is updated, the configuration is also updated with a new log
// level that instructs the handler to log additional information.
func (scenario GetStartedFunctionsScenario) UpdateFunction(ctx context.Context,
funcName string) {
    log.Println("Let's update the function to an arithmetic calculator.\n" +
"The function uses the 'lambda_handler_calculator.py' script found in the \n" +
"'handlers' directory of this project.")
    scenario.questioner.Ask("Press Enter when you're ready.")
    log.Println("Creating deployment package...")
    zipPackage :=
scenario.helper.CreateDeploymentPackage("lambda_handler_calculator.py",
fmt.Sprintf("%v.py", funcName))
    log.Println("...and updating the Lambda function and waiting for it to be
ready.")
    funcState := scenario.functionWrapper.UpdateFunctionCode(ctx, funcName,
zipPackage)
    log.Printf("Updated function %v. Its current state is %v.", funcName, funcState)
    log.Println("This function uses an environment variable to control logging
level.")
    log.Println("Let's set it to DEBUG to get the most logging.")
}

```



```
scenario.functionWrapper.UpdateFunctionConfiguration(ctx, funcName,
    map[string]string{"LOG_LEVEL": "DEBUG"})
log.Println(strings.Repeat("-", 88))
}

// InvokeCalculator invokes the Lambda calculator function. The parameters are
// stored in a
// Go struct that is used to serialize the parameters to a JSON payload. That
// payload is then passed
// to the function.
// The result payload is deserialized to a Go struct that stores the result as
// either an
// int or float32, depending on the kind of operation that was specified.
func (scenario GetStartedFunctionsScenario) InvokeCalculator(ctx context.Context,
    funcName string) {
    wantInvoke := true
    choices := []string{"plus", "minus", "times", "divided-by"}
    for wantInvoke {
        choice := scenario.questioner.AskChoice("Select an arithmetic operation:\n",
            choices)
        x := scenario.questioner.AskInt("Enter a value for x:", demotools.NotEmpty{})
        y := scenario.questioner.AskInt("Enter a value for y:", demotools.NotEmpty{})
        log.Printf("Invoking %v %v %v...", x, choices[choice], y)
        calcParameters := actions.CalculatorParameters{
            Action: choices[choice],
            X:      x,
            Y:      y,
        }
        invokeOutput := scenario.functionWrapper.Invoke(ctx, funcName, calcParameters,
            true)
        var payload any
        if choice == 3 { // divide-by results in a float.
            payload = actions.LambdaResultFloat{}
        } else {
            payload = actions.LambdaResultInt{}
        }
        err := json.Unmarshal(invokeOutput.Payload, &payload)
        if err != nil {
            log.Panicf("Couldn't unmarshal payload from invoking %v. Here's why: %v\n",
                funcName, err)
        }
        log.Printf("Invoking %v with %v %v %v returned %v.\n", funcName,
            calcParameters.X, calcParameters.Action, calcParameters.Y, payload)
        scenario.questioner.Ask("Press Enter to see the logs from the call.")
    }
}
```

```

logRes, err := base64.StdEncoding.DecodeString(*invokeOutput.LogResult)
if err != nil {
    log.Panicf("Couldn't decode log result. Here's why: %v\n", err)
}
log.Println(string(logRes))
wantInvoke = scenario.questioner.AskBool("Do you want to calculate again? (y/n)", "y")
}
log.Println(strings.Repeat("-", 88))
}

// ListFunctions lists up to the specified number of functions for your account.
func (scenario GetStartedFunctionsScenario) ListFunctions(ctx context.Context) {
    count := scenario.questioner.AskInt(
        "Let's list functions for your account. How many do you want to see?",
        demotools.NotEmpty{})
    functions := scenario.functionWrapper.ListFunctions(ctx, count)
    log.Printf("Found %v functions:", len(functions))
    for _, function := range functions {
        log.Printf("\t%v", *function.FunctionName)
    }
    log.Println(strings.Repeat("-", 88))
}

// Cleanup removes the IAM and Lambda resources created by the example.
func (scenario GetStartedFunctionsScenario) Cleanup(ctx context.Context, role
    *iamtypes.Role, funcName string) {
    if scenario.questioner.AskBool("Do you want to clean up resources created for
    this example? (y/n)",
        "y") {
        iamClient := iam.NewFromConfig(scenario.sdkConfig)
        policiesOutput, err := iamClient.ListAttachedRolePolicies(ctx,
            &iam.ListAttachedRolePoliciesInput{RoleName: role.RoleName})
        if err != nil {
            log.Panicf("Couldn't get policies attached to role %v. Here's why: %v\n",
                *role.RoleName, err)
        }
        for _, policy := range policiesOutput.AttachedPolicies {
            _, err = iamClient.DetachRolePolicy(ctx, &iam.DetachRolePolicyInput{
                PolicyArn: policy.PolicyArn, RoleName: role.RoleName,
            })
            if err != nil {
                log.Panicf("Couldn't detach policy %v from role %v. Here's why: %v\n",
                    *policy.PolicyArn, *role.RoleName, err)
            }
        }
    }
}

```

```
    }
  }
  _, err = iamClient.DeleteRole(ctx, &iam.DeleteRoleInput{RoleName:
role.RoleName})
  if err != nil {
    log.Panicf("Couldn't delete role %v. Here's why: %v\n", *role.RoleName, err)
  }
  log.Printf("Deleted role %v.\n", *role.RoleName)

  scenario.functionWrapper.DeleteFunction(ctx, funcName)
  log.Printf("Deleted function %v.\n", funcName)
} else {
  log.Println("Okay. Don't forget to delete the resources when you're done with
them.")
}
}

// IScenarioHelper abstracts I/O and wait functions from a scenario so that they
// can be mocked for unit testing.
type IScenarioHelper interface {
  Pause(secs int)
  CreateDeploymentPackage(sourceFile string, destinationFile string) *bytes.Buffer
}

// ScenarioHelper lets the caller specify the path to Lambda handler functions.
type ScenarioHelper struct {
  HandlerPath string
}

// Pause waits for the specified number of seconds.
func (helper *ScenarioHelper) Pause(secs int) {
  time.Sleep(time.Duration(secs) * time.Second)
}

// CreateDeploymentPackage creates an AWS Lambda deployment package from a source
file. The
// deployment package is stored in .zip format in a bytes.Buffer. The buffer can
be
// used to pass a []byte to Lambda when creating the function.
// The specified destinationFile is the name to give the file when it's deployed
to Lambda.
func (helper *ScenarioHelper) CreateDeploymentPackage(sourceFile string,
destinationFile string) *bytes.Buffer {
  var err error
```

```
buffer := &bytes.Buffer{}
writer := zip.NewWriter(buffer)
zFile, err := writer.Create(destinationFile)
if err != nil {
    log.Panicf("Couldn't create destination archive %v. Here's why: %v\n",
destinationFile, err)
}
sourceBody, err := os.ReadFile(fmt.Sprintf("%v/%v", helper.HandlerPath,
sourceFile))
if err != nil {
    log.Panicf("Couldn't read handler source file %v. Here's why: %v\n",
sourceFile, err)
} else {
    _, err = zFile.Write(sourceBody)
    if err != nil {
        log.Panicf("Couldn't write handler %v to zip archive. Here's why: %v\n",
sourceFile, err)
    }
}
err = writer.Close()
if err != nil {
    log.Panicf("Couldn't close zip writer. Here's why: %v\n", err)
}
return buffer
}
```

Create a struct that wraps individual Lambda actions.

```
import (
    "bytes"
    "context"
    "encoding/json"
    "errors"
    "log"
    "time"

    "github.com/aws/aws-sdk-go-v2/aws"
    "github.com/aws/aws-sdk-go-v2/service/lambda"
    "github.com/aws/aws-sdk-go-v2/service/lambda/types"
)
```

```
// FunctionWrapper encapsulates function actions used in the examples.
// It contains an AWS Lambda service client that is used to perform user actions.
type FunctionWrapper struct {
    LambdaClient *lambda.Client
}

// GetFunction gets data about the Lambda function specified by functionName.
func (wrapper FunctionWrapper) GetFunction(ctx context.Context, functionName
string) types.State {
    var state types.State
    funcOutput, err := wrapper.LambdaClient.GetFunction(ctx,
&lambda.GetFunctionInput{
    FunctionName: aws.String(functionName),
    })
    if err != nil {
        log.Panicf("Couldn't get function %v. Here's why: %v\n", functionName, err)
    } else {
        state = funcOutput.Configuration.State
    }
    return state
}

// CreateFunction creates a new Lambda function from code contained in the
zipPackage
// buffer. The specified handlerName must match the name of the file and function
// contained in the uploaded code. The role specified by iamRoleArn is assumed by
// Lambda and grants specific permissions.
// When the function already exists, types.StateActive is returned.
// When the function is created, a lambda.FunctionActiveV2Waiter is used to wait
until the
// function is active.
func (wrapper FunctionWrapper) CreateFunction(ctx context.Context, functionName
string, handlerName string,
iamRoleArn *string, zipPackage *bytes.Buffer) types.State {
    var state types.State
    _, err := wrapper.LambdaClient.CreateFunction(ctx, &lambda.CreateFunctionInput{
    Code:          &types.FunctionCode{ZipFile: zipPackage.Bytes()},
    FunctionName: aws.String(functionName),
    Role:         iamRoleArn,
    Handler:     aws.String(handlerName),
```

```

    Publish:      true,
    Runtime:      types.RuntimePython39,
})
if err != nil {
    var resConflict *types.ResourceConflictException
    if errors.As(err, &resConflict) {
        log.Printf("Function %v already exists.\n", functionName)
        state = types.StateActive
    } else {
        log.Panicf("Couldn't create function %v. Here's why: %v\n", functionName, err)
    }
} else {
    waiter := lambda.NewFunctionActiveV2Waiter(wrapper.LambdaClient)
    funcOutput, err := waiter.WaitForOutput(ctx, &lambda.GetFunctionInput{
        FunctionName: aws.String(functionName)}, 1*time.Minute)
    if err != nil {
        log.Panicf("Couldn't wait for function %v to be active. Here's why: %v\n",
functionName, err)
    } else {
        state = funcOutput.Configuration.State
    }
}
return state
}

// UpdateFunctionCode updates the code for the Lambda function specified by
// functionName.
// The existing code for the Lambda function is entirely replaced by the code in
// the
// zipPackage buffer. After the update action is called, a
// lambda.FunctionUpdatedV2Waiter
// is used to wait until the update is successful.
func (wrapper FunctionWrapper) UpdateFunctionCode(ctx context.Context,
functionName string, zipPackage *bytes.Buffer) types.State {
    var state types.State
    _, err := wrapper.LambdaClient.UpdateFunctionCode(ctx,
&lambda.UpdateFunctionCodeInput{
    FunctionName: aws.String(functionName), ZipFile: zipPackage.Bytes(),
})
    if err != nil {
        log.Panicf("Couldn't update code for function %v. Here's why: %v\n",
functionName, err)
    }
}

```

```

} else {
    waiter := lambda.NewFunctionUpdatedV2Waiter(wrapper.LambdaClient)
    funcOutput, err := waiter.WaitForOutput(ctx, &lambda.GetFunctionInput{
        FunctionName: aws.String(functionName)}, 1*time.Minute)
    if err != nil {
        log.Panicf("Couldn't wait for function %v to be active. Here's why: %v\n",
            functionName, err)
    } else {
        state = funcOutput.Configuration.State
    }
}
return state
}

// UpdateFunctionConfiguration updates a map of environment variables configured
// for
// the Lambda function specified by functionName.
func (wrapper FunctionWrapper) UpdateFunctionConfiguration(ctx context.Context,
    functionName string, envVars map[string]string) {
    _, err := wrapper.LambdaClient.UpdateFunctionConfiguration(ctx,
        &lambda.UpdateFunctionConfigurationInput{
            FunctionName: aws.String(functionName),
            Environment: &types.Environment{Variables: envVars},
        })
    if err != nil {
        log.Panicf("Couldn't update configuration for %v. Here's why: %v",
            functionName, err)
    }
}

// ListFunctions lists up to maxItems functions for the account. This function
// uses a
// lambda.ListFunctionsPaginator to paginate the results.
func (wrapper FunctionWrapper) ListFunctions(ctx context.Context, maxItems int)
    []types.FunctionConfiguration {
    var functions []types.FunctionConfiguration
    paginator := lambda.NewListFunctionsPaginator(wrapper.LambdaClient,
        &lambda.ListFunctionsInput{
            MaxItems: aws.Int32(int32(maxItems)),
        })
}

```

```
for paginator.HasMorePages() && len(functions) < maxItems {
    pageOutput, err := paginator.NextPage(ctx)
    if err != nil {
        log.Panicf("Couldn't list functions for your account. Here's why: %v\n", err)
    }
    functions = append(functions, pageOutput.Functions...)
}
return functions
}

// DeleteFunction deletes the Lambda function specified by functionName.
func (wrapper FunctionWrapper) DeleteFunction(ctx context.Context, functionName
string) {
    _, err := wrapper.LambdaClient.DeleteFunction(ctx, &lambda.DeleteFunctionInput{
        FunctionName: aws.String(functionName),
    })
    if err != nil {
        log.Panicf("Couldn't delete function %v. Here's why: %v\n", functionName, err)
    }
}

// Invoke invokes the Lambda function specified by functionName, passing the
parameters
// as a JSON payload. When getLog is true, types.LogTypeTail is specified, which
tells
// Lambda to include the last few log lines in the returned result.
func (wrapper FunctionWrapper) Invoke(ctx context.Context, functionName string,
parameters any, getLog bool) *lambda.InvokeOutput {
    logType := types.LogTypeNone
    if getLog {
        logType = types.LogTypeTail
    }
    payload, err := json.Marshal(parameters)
    if err != nil {
        log.Panicf("Couldn't marshal parameters to JSON. Here's why %v\n", err)
    }
    invokeOutput, err := wrapper.LambdaClient.Invoke(ctx, &lambda.InvokeInput{
        FunctionName: aws.String(functionName),
        LogType:      logType,
        Payload:      payload,
    })
}
```



```
    })
    if err != nil {
        log.Panicf("Couldn't invoke function %v. Here's why: %v\n", functionName, err)
    }
    return invokeOutput
}

// IncrementParameters is used to serialize parameters to the increment Lambda
// handler.
type IncrementParameters struct {
    Action string `json:"action"`
    Number int    `json:"number"`
}

// CalculatorParameters is used to serialize parameters to the calculator Lambda
// handler.
type CalculatorParameters struct {
    Action string `json:"action"`
    X      int    `json:"x"`
    Y      int    `json:"y"`
}

// LambdaResultInt is used to deserialize an int result from a Lambda handler.
type LambdaResultInt struct {
    Result int `json:"result"`
}

// LambdaResultFloat is used to deserialize a float32 result from a Lambda
// handler.
type LambdaResultFloat struct {
    Result float32 `json:"result"`
}
```

Define a Lambda handler that increments a number.

```
import logging

logger = logging.getLogger()
logger.setLevel(logging.INFO)
```

```
def lambda_handler(event, context):
    """
    Accepts an action and a single number, performs the specified action on the
    number,
    and returns the result. The only allowable action is 'increment'.

    :param event: The event dict that contains the parameters sent when the
    function
                 is invoked.
    :param context: The context in which the function is called.
    :return: The result of the action.
    """
    result = None
    action = event.get("action")
    if action == "increment":
        result = event.get("number", 0) + 1
        logger.info("Calculated result of %s", result)
    else:
        logger.error("%s is not a valid action.", action)

    response = {"result": result}
    return response
```

Define a second Lambda handler that performs arithmetic operations.

```
import logging
import os

logger = logging.getLogger()

# Define a list of Python lambda functions that are called by this AWS Lambda
function.
ACTIONS = {
    "plus": lambda x, y: x + y,
    "minus": lambda x, y: x - y,
    "times": lambda x, y: x * y,
    "divided-by": lambda x, y: x / y,
```

```
}

def lambda_handler(event, context):
    """
    Accepts an action and two numbers, performs the specified action on the
    numbers,
    and returns the result.

    :param event: The event dict that contains the parameters sent when the
    function
                 is invoked.
    :param context: The context in which the function is called.
    :return: The result of the specified action.
    """
    # Set the log level based on a variable configured in the Lambda environment.
    logger.setLevel(os.environ.get("LOG_LEVEL", logging.INFO))
    logger.debug("Event: %s", event)

    action = event.get("action")
    func = ACTIONS.get(action)
    x = event.get("x")
    y = event.get("y")
    result = None
    try:
        if func is not None and x is not None and y is not None:
            result = func(x, y)
            logger.info("%s %s %s is %s", x, action, y, result)
        else:
            logger.error("I can't calculate %s %s %s.", x, action, y)
    except ZeroDivisionError:
        logger.warning("I can't divide %s by 0!", x)

    response = {"result": result}
    return response
```

- For API details, see the following topics in *AWS SDK for Go API Reference*.
 - [CreateFunction](#)
 - [DeleteFunction](#)

- [GetFunction](#)
- [Invoke](#)
- [ListFunctions](#)
- [UpdateFunctionCode](#)
- [UpdateFunctionConfiguration](#)

Java

SDK for Java 2.x

Note

There's more on GitHub. Find the complete example and learn how to set up and run in the [AWS Code Examples Repository](#).

```
/*
 * Lambda function names appear as:
 *
 * arn:aws:lambda:us-west-2:335556666777:function:HelloFunction
 *
 * To find this value, look at the function in the AWS Management Console.
 *
 * Before running this Java code example, set up your development environment,
 * including your credentials.
 *
 * For more information, see this documentation topic:
 *
 * https://docs.aws.amazon.com/sdk-for-java/latest/developer-guide/get-
 * started.html
 *
 * This example performs the following tasks:
 *
 * 1. Creates an AWS Lambda function.
 * 2. Gets a specific AWS Lambda function.
 * 3. Lists all Lambda functions.
 * 4. Invokes a Lambda function.
 * 5. Updates the Lambda function code and invokes it again.
 * 6. Updates a Lambda function's configuration value.
 * 7. Deletes a Lambda function.
```

```
*/

public class LambdaScenario {
    public static final String DASHES = new String(new char[80]).replace("\0",
"-");

    public static void main(String[] args) throws InterruptedException {
        final String usage = ""

            Usage:
                <functionName> <role> <handler> <bucketName> <key>\s

            Where:
                functionName - The name of the Lambda function.\s
                role - The AWS Identity and Access Management (IAM) service role
that has Lambda permissions.\s
                handler - The fully qualified method name (for example,
example.Handler::handleRequest).\s
                bucketName - The Amazon Simple Storage Service (Amazon S3) bucket
name that contains the .zip or .jar used to update the Lambda function's code.\s
                key - The Amazon S3 key name that represents the .zip or .jar
(for example, LambdaHello-1.0-SNAPSHOT.jar).
                """;

        if (args.length != 5) {
            System.out.println(usage);
            return;
        }

        String functionName = args[0];
        String role = args[1];
        String handler = args[2];
        String bucketName = args[3];
        String key = args[4];
        LambdaClient awsLambda = LambdaClient.builder()
            .build();

        System.out.println(DASHES);
        System.out.println("Welcome to the AWS Lambda Basics scenario.");
        System.out.println(DASHES);

        System.out.println(DASHES);
        System.out.println("1. Create an AWS Lambda function.");
    }
}
```

```
String funArn = createLambdaFunction(awsLambda, functionName, key,
bucketName, role, handler);
System.out.println("The AWS Lambda ARN is " + funArn);
System.out.println(DASHES);

System.out.println(DASHES);
System.out.println("2. Get the " + functionName + " AWS Lambda
function.");
getFunction(awsLambda, functionName);
System.out.println(DASHES);

System.out.println(DASHES);
System.out.println("3. List all AWS Lambda functions.");
listFunctions(awsLambda);
System.out.println(DASHES);

System.out.println(DASHES);
System.out.println("4. Invoke the Lambda function.");
System.out.println("*** Sleep for 1 min to get Lambda function ready.");
Thread.sleep(60000);
invokeFunction(awsLambda, functionName);
System.out.println(DASHES);

System.out.println(DASHES);
System.out.println("5. Update the Lambda function code and invoke it
again.");
updateFunctionCode(awsLambda, functionName, bucketName, key);
System.out.println("*** Sleep for 1 min to get Lambda function ready.");
Thread.sleep(60000);
invokeFunction(awsLambda, functionName);
System.out.println(DASHES);

System.out.println(DASHES);
System.out.println("6. Update a Lambda function's configuration value.");
updateFunctionConfiguration(awsLambda, functionName, handler);
System.out.println(DASHES);

System.out.println(DASHES);
System.out.println("7. Delete the AWS Lambda function.");
LambdaScenario.deleteLambdaFunction(awsLambda, functionName);
System.out.println(DASHES);

System.out.println(DASHES);
System.out.println("The AWS Lambda scenario completed successfully");
```

```
        System.out.println(DASHES);
        awsLambda.close();
    }

    /**
     * Creates a new Lambda function in AWS using the AWS Lambda Java API.
     *
     * @param awsLambda    the AWS Lambda client used to interact with the AWS
Lambda service
     * @param functionName the name of the Lambda function to create
     * @param key          the S3 key of the function code
     * @param bucketName  the name of the S3 bucket containing the function code
     * @param role        the IAM role to assign to the Lambda function
     * @param handler     the fully qualified class name of the function handler
     * @return the Amazon Resource Name (ARN) of the created Lambda function
     */
    public static String createLambdaFunction(LambdaClient awsLambda,
                                             String functionName,
                                             String key,
                                             String bucketName,
                                             String role,
                                             String handler) {

        try {
            LambdaWaiter waiter = awsLambda.waiter();
            FunctionCode code = FunctionCode.builder()
                .s3Key(key)
                .s3Bucket(bucketName)
                .build();

            CreateFunctionRequest functionRequest =
CreateFunctionRequest.builder()
                .functionName(functionName)
                .description("Created by the Lambda Java API")
                .code(code)
                .handler(handler)
                .runtime(Runtime.JAVA17)
                .role(role)
                .build();

            // Create a Lambda function using a waiter
            CreateFunctionResponse functionResponse =
awsLambda.createFunction(functionRequest);
            GetFunctionRequest getFunctionRequest = GetFunctionRequest.builder()
```

```
        .functionName(functionName)
        .build();
        WaiterResponse<GetFunctionResponse> waiterResponse =
waiter.waitUntilFunctionExists(getFunctionRequest);
        waiterResponse.matched().response().ifPresent(System.out::println);
        return functionResponse.functionArn();

    } catch (LambdaException e) {
        System.err.println(e.getMessage());
        System.exit(1);
    }
    return "";
}

/**
 * Retrieves information about an AWS Lambda function.
 *
 * @param awsLambda an instance of the {@link LambdaClient} class, which
is used to interact with the AWS Lambda service
 * @param functionName the name of the AWS Lambda function to retrieve
information about
 */
public static void getFunction(LambdaClient awsLambda, String functionName) {
    try {
        GetFunctionRequest functionRequest = GetFunctionRequest.builder()
            .functionName(functionName)
            .build();

        GetFunctionResponse response =
awsLambda.getFunction(functionRequest);
        System.out.println("The runtime of this Lambda function is " +
response.configuration().runtime());

    } catch (LambdaException e) {
        System.err.println(e.getMessage());
        System.exit(1);
    }
}

/**
 * Lists the AWS Lambda functions associated with the current AWS account.
 *
 * @param awsLambda an instance of the {@link LambdaClient} class, which is
used to interact with the AWS Lambda service
```



```
*
 * @throws LambdaException if an error occurs while interacting with the AWS
Lambda service
 */
public static void listFunctions(LambdaClient awsLambda) {
    try {
        ListFunctionsResponse functionResult = awsLambda.listFunctions();
        List<FunctionConfiguration> list = functionResult.functions();
        for (FunctionConfiguration config : list) {
            System.out.println("The function name is " +
config.functionName());
        }

    } catch (LambdaException e) {
        System.err.println(e.getMessage());
        System.exit(1);
    }
}

/**
 * Invokes a specific AWS Lambda function.
 *
 * @param awsLambda an instance of {@link LambdaClient} to interact with
the AWS Lambda service
 * @param functionName the name of the AWS Lambda function to be invoked
 */
public static void invokeFunction(LambdaClient awsLambda, String
functionName) {
    InvokeResponse res;
    try {
        // Need a SdkBytes instance for the payload.
        JSONObject jsonObj = new JSONObject();
        jsonObj.put("inputValue", "2000");
        String json = jsonObj.toString();
        SdkBytes payload = SdkBytes.fromUtf8String(json);

        InvokeRequest request = InvokeRequest.builder()
            .functionName(functionName)
            .payload(payload)
            .build();

        res = awsLambda.invoke(request);
        String value = res.payload().asUtf8String();
        System.out.println(value);
    }
}
```

```
    } catch (LambdaException e) {
        System.err.println(e.getMessage());
        System.exit(1);
    }
}

/**
 * Updates the code for an AWS Lambda function.
 *
 * @param awsLambda the AWS Lambda client
 * @param functionName the name of the Lambda function to update
 * @param bucketName the name of the S3 bucket where the function code is
located
 * @param key the key (file name) of the function code in the S3 bucket
 * @throws LambdaException if there is an error updating the function code
 */
public static void updateFunctionCode(LambdaClient awsLambda, String
functionName, String bucketName, String key) {
    try {
        LambdaWaiter waiter = awsLambda.waiter();
        UpdateFunctionCodeRequest functionCodeRequest =
UpdateFunctionCodeRequest.builder()
            .functionName(functionName)
            .publish(true)
            .s3Bucket(bucketName)
            .s3Key(key)
            .build();

        UpdateFunctionCodeResponse response =
awsLambda.updateFunctionCode(functionCodeRequest);
        GetFunctionConfigurationRequest getFunctionConfigRequest =
GetFunctionConfigurationRequest.builder()
            .functionName(functionName)
            .build();

        WaiterResponse<GetFunctionConfigurationResponse> waiterResponse =
waiter
            .waitUntilFunctionUpdated(getFunctionConfigRequest);
        waiterResponse.matched().response().ifPresent(System.out::println);
        System.out.println("The last modified value is " +
response.lastModified());
    } catch (LambdaException e) {
```

```
        System.err.println(e.getMessage());
        System.exit(1);
    }
}

/**
 * Updates the configuration of an AWS Lambda function.
 *
 * @param awsLambda    the {@link LambdaClient} instance to use for the AWS
Lambda operation
 * @param functionName the name of the AWS Lambda function to update
 * @param handler      the new handler for the AWS Lambda function
 *
 * @throws LambdaException if there is an error while updating the function
configuration
 */
public static void updateFunctionConfiguration(LambdaClient awsLambda, String
functionName, String handler) {
    try {
        UpdateFunctionConfigurationRequest configurationRequest =
UpdateFunctionConfigurationRequest.builder()
            .functionName(functionName)
            .handler(handler)
            .runtime(Runtime.JAVA17)
            .build();

        awsLambda.updateFunctionConfiguration(configurationRequest);

    } catch (LambdaException e) {
        System.err.println(e.getMessage());
        System.exit(1);
    }
}

/**
 * Deletes an AWS Lambda function.
 *
 * @param awsLambda    an instance of the {@link LambdaClient} class, which
is used to interact with the AWS Lambda service
 * @param functionName the name of the Lambda function to be deleted
 *
 * @throws LambdaException if an error occurs while deleting the Lambda
function
 */
```

```
public static void deleteLambdaFunction(LambdaClient awsLambda, String
functionName) {
    try {
        DeleteFunctionRequest request = DeleteFunctionRequest.builder()
            .functionName(functionName)
            .build();

        awsLambda.deleteFunction(request);
        System.out.println("The " + functionName + " function was deleted");

    } catch (LambdaException e) {
        System.err.println(e.getMessage());
        System.exit(1);
    }
}
```

- For API details, see the following topics in *AWS SDK for Java 2.x API Reference*.
 - [CreateFunction](#)
 - [DeleteFunction](#)
 - [GetFunction](#)
 - [Invoke](#)
 - [ListFunctions](#)
 - [UpdateFunctionCode](#)
 - [UpdateFunctionConfiguration](#)

JavaScript

SDK for JavaScript (v3)

Note

There's more on GitHub. Find the complete example and learn how to set up and run in the [AWS Code Examples Repository](#).

Create an AWS Identity and Access Management (IAM) role that grants Lambda permission to write to logs.

```
logger.log(`Creating role (${NAME_ROLE_LAMBDA})...`);
const response = await createRole(NAME_ROLE_LAMBDA);

import { AttachRolePolicyCommand, IAMClient } from "@aws-sdk/client-iam";

const client = new IAMClient({});

/**
 *
 * @param {string} policyArn
 * @param {string} roleName
 */
export const attachRolePolicy = (policyArn, roleName) => {
  const command = new AttachRolePolicyCommand({
    PolicyArn: policyArn,
    RoleName: roleName,
  });

  return client.send(command);
};
```

Create a Lambda function and upload handler code.

```
const createFunction = async (funcName, roleArn) => {
  const client = new LambdaClient({});
  const code = await readFile(`${dirname}../functions/${funcName}.zip`);

  const command = new CreateFunctionCommand({
    Code: { ZipFile: code },
    FunctionName: funcName,
    Role: roleArn,
    Architectures: [Architecture.arm64],
    Handler: "index.handler", // Required when sending a .zip file
    PackageType: PackageType.Zip, // Required when sending a .zip file
    Runtime: Runtime.nodejs16x, // Required when sending a .zip file
  });

  return client.send(command);
};
```

Invoke the function with a single parameter and get results.

```
const invoke = async (funcName, payload) => {
  const client = new LambdaClient({});
  const command = new InvokeCommand({
    FunctionName: funcName,
    Payload: JSON.stringify(payload),
    LogType: LogType.Tail,
  });

  const { Payload, LogResult } = await client.send(command);
  const result = Buffer.from(Payload).toString();
  const logs = Buffer.from(LogResult, "base64").toString();
  return { logs, result };
};
```

Update the function code and configure its Lambda environment with an environment variable.

```
const updateFunctionCode = async (funcName, newFunc) => {
  const client = new LambdaClient({});
  const code = await readFile(`${dirname}../functions/${newFunc}.zip`);
  const command = new UpdateFunctionCodeCommand({
    ZipFile: code,
    FunctionName: funcName,
    Architectures: [Architecture.arm64],
    Handler: "index.handler", // Required when sending a .zip file
    PackageType: PackageType.Zip, // Required when sending a .zip file
    Runtime: Runtime.nodejs16x, // Required when sending a .zip file
  });

  return client.send(command);
};

const updateFunctionConfiguration = (funcName) => {
  const client = new LambdaClient({});
  const config = readFileSync(`${dirname}../functions/config.json`).toString();
  const command = new UpdateFunctionConfigurationCommand({
    ...JSON.parse(config),
    FunctionName: funcName,
  });
  const result = client.send(command);
};
```

```
waitForFunctionUpdated({ FunctionName: funcName });
return result;
};
```

List the functions for your account.

```
const listFunctions = () => {
  const client = new LambdaClient({});
  const command = new ListFunctionsCommand({});

  return client.send(command);
};
```

Delete the IAM role and the Lambda function.

```
import { DeleteRoleCommand, IAMClient } from "@aws-sdk/client-iam";

const client = new IAMClient({});

/**
 *
 * @param {string} roleName
 */
export const deleteRole = (roleName) => {
  const command = new DeleteRoleCommand({ RoleName: roleName });
  return client.send(command);
};

/**
 * @param {string} funcName
 */
const deleteFunction = (funcName) => {
  const client = new LambdaClient({});
  const command = new DeleteFunctionCommand({ FunctionName: funcName });
  return client.send(command);
};
```

- For API details, see the following topics in *AWS SDK for JavaScript API Reference*.
 - [CreateFunction](#)

- [DeleteFunction](#)
- [GetFunction](#)
- [Invoke](#)
- [ListFunctions](#)
- [UpdateFunctionCode](#)
- [UpdateFunctionConfiguration](#)

Kotlin

SDK for Kotlin

Note

There's more on GitHub. Find the complete example and learn how to set up and run in the [AWS Code Examples Repository](#).

```
suspend fun main(args: Array<String>) {
    val usage = """
        Usage:
            <functionName> <role> <handler> <bucketName> <updatedBucketName>
            <key>

        Where:
            functionName - The name of the AWS Lambda function.
            role - The AWS Identity and Access Management (IAM) service role that
            has AWS Lambda permissions.
            handler - The fully qualified method name (for example,
            example.Handler::handleRequest).
            bucketName - The Amazon Simple Storage Service (Amazon S3) bucket
            name that contains the ZIP or JAR used for the Lambda function's code.
            updatedBucketName - The Amazon S3 bucket name that contains the .zip
            or .jar used to update the Lambda function's code.
            key - The Amazon S3 key name that represents the .zip or .jar file
            (for example, LambdaHello-1.0-SNAPSHOT.jar).
            """

    if (args.size != 6) {
        println(usage)
    }
}
```



```
        exitProcess(1)
    }

    val functionName = args[0]
    val role = args[1]
    val handler = args[2]
    val bucketName = args[3]
    val updatedBucketName = args[4]
    val key = args[5]

    println("Creating a Lambda function named $functionName.")
    val funArn = createScFunction(functionName, bucketName, key, handler, role)
    println("The AWS Lambda ARN is $funArn")

    // Get a specific Lambda function.
    println("Getting the $functionName AWS Lambda function.")
    getFunction(functionName)

    // List the Lambda functions.
    println("Listing all AWS Lambda functions.")
    listFunctionsSc()

    // Invoke the Lambda function.
    println("*** Invoke the Lambda function.")
    invokeFunctionSc(functionName)

    // Update the AWS Lambda function code.
    println("*** Update the Lambda function code.")
    updateFunctionCode(functionName, updatedBucketName, key)

    // println("*** Invoke the function again after updating the code.")
    invokeFunctionSc(functionName)

    // Update the AWS Lambda function configuration.
    println("Update the run time of the function.")
    updateFunctionConfiguration(functionName, handler)

    // Delete the AWS Lambda function.
    println("Delete the AWS Lambda function.")
    delFunction(functionName)
}

suspend fun createScFunction(
    myFunctionName: String,
```

```
s3BucketName: String,
myS3Key: String,
myHandler: String,
myRole: String,
): String {
    val functionCode =
        FunctionCode {
            s3Bucket = s3BucketName
            s3Key = myS3Key
        }

    val request =
        CreateFunctionRequest {
            functionName = myFunctionName
            code = functionCode
            description = "Created by the Lambda Kotlin API"
            handler = myHandler
            role = myRole
            runtime = Runtime.Java8
        }

    // Create a Lambda function using a waiter
    LambdaClient { region = "us-west-2" }.use { awsLambda ->
        val functionResponse = awsLambda.createFunction(request)
        awsLambda.waitForFunctionActive {
            functionName = myFunctionName
        }
        return functionResponse.functionArn.toString()
    }
}

suspend fun getFunction(functionNameVal: String) {
    val functionRequest =
        GetFunctionRequest {
            functionName = functionNameVal
        }

    LambdaClient { region = "us-west-2" }.use { awsLambda ->
        val response = awsLambda.getFunction(functionRequest)
        println("The runtime of this Lambda function is
        ${response.configuration?.runtime}")
    }
}
```

```
suspend fun listFunctionsSc() {
    val request =
        ListFunctionsRequest {
            maxItems = 10
        }

    LambdaClient { region = "us-west-2" }.use { awsLambda ->
        val response = awsLambda.listFunctions(request)
        response.functions?.forEach { function ->
            println("The function name is ${function.functionName}")
        }
    }
}

suspend fun invokeFunctionSc(functionNameVal: String) {
    val json = """"{"inputValue":"1000"}""""
    val byteArray = json.trimIndent().encodeToByteArray()
    val request =
        InvokeRequest {
            functionName = functionNameVal
            payload = byteArray
            logType = LogType.Tail
        }

    LambdaClient { region = "us-west-2" }.use { awsLambda ->
        val res = awsLambda.invoke(request)
        println("The function payload is
        ${res.payload?.toString(Charsets.UTF_8)}")
    }
}

suspend fun updateFunctionCode(
    functionNameVal: String?,
    bucketName: String?,
    key: String?,
) {
    val functionCodeRequest =
        UpdateFunctionCodeRequest {
            functionName = functionNameVal
            publish = true
            s3Bucket = bucketName
            s3Key = key
        }
}
```

```
LambdaClient { region = "us-west-2" }.use { awsLambda ->
    val response = awsLambda.updateFunctionCode(functionCodeRequest)
    awsLambda.waitUntilFunctionUpdated {
        functionName = functionNameVal
    }
    println("The last modified value is " + response.lastModified)
}

suspend fun updateFunctionConfiguration(
    functionNameVal: String?,
    handlerVal: String?,
) {
    val configurationRequest =
        UpdateFunctionConfigurationRequest {
            functionName = functionNameVal
            handler = handlerVal
            runtime = Runtime.Java11
        }

    LambdaClient { region = "us-west-2" }.use { awsLambda ->
        awsLambda.updateFunctionConfiguration(configurationRequest)
    }
}

suspend fun delFunction(myFunctionName: String) {
    val request =
        DeleteFunctionRequest {
            functionName = myFunctionName
        }

    LambdaClient { region = "us-west-2" }.use { awsLambda ->
        awsLambda.deleteFunction(request)
        println("$myFunctionName was deleted")
    }
}
```

- For API details, see the following topics in *AWS SDK for Kotlin API reference*.
 - [CreateFunction](#)
 - [DeleteFunction](#)
 - [GetFunction](#)

- [Invoke](#)
- [ListFunctions](#)
- [UpdateFunctionCode](#)
- [UpdateFunctionConfiguration](#)

PHP

SDK for PHP

Note

There's more on GitHub. Find the complete example and learn how to set up and run in the [AWS Code Examples Repository](#).

```
namespace Lambda;

use Aws\S3\S3Client;
use GuzzleHttp\Psr7\Stream;
use Iam\IAMService;

class GettingStartedWithLambda
{
    public function run()
    {
        echo("\n");
        echo("-----\n");
        print("Welcome to the AWS Lambda getting started demo using PHP!\n");
        echo("-----\n");

        $clientArgs = [
            'region' => 'us-west-2',
            'version' => 'latest',
            'profile' => 'default',
        ];
        $uniqid = uniqid();

        $iamService = new IAMService();
        $s3client = new S3Client($clientArgs);
        $lambdaService = new LambdaService();
```

```
echo "First, let's create a role to run our Lambda code.\n";
$roleName = "test-lambda-role-$uniqid";
$rolePolicyDocument = "{
  \"Version\": \"2012-10-17\",
  \"Statement\": [
    {
      \"Effect\": \"Allow\",
      \"Principal\": {
        \"Service\": \"lambda.amazonaws.com\"
      },
      \"Action\": \"sts:AssumeRole\"
    }
  ]
}";
$role = $iamService->createRole($roleName, $rolePolicyDocument);
echo "Created role {$role['RoleName']}.\n";

$iamService->attachRolePolicy(
  $role['RoleName'],
  "arn:aws:iam::aws:policy/service-role/AWSLambdaBasicExecutionRole"
);
echo "Attached the AWSLambdaBasicExecutionRole to {$role['RoleName']}.
\n";

echo "\nNow let's create an S3 bucket and upload our Lambda code there.
\n";

$bucketName = "test-example-bucket-$uniqid";
$s3client->createBucket([
  'Bucket' => $bucketName,
]);
echo "Created bucket $bucketName.\n";

$functionName = "doc_example_lambda_$uniqid";
$codeBasic = __DIR__ . "/lambda_handler_basic.zip";
$handler = "lambda_handler_basic";
$file = file_get_contents($codeBasic);
$s3client->putObject([
  'Bucket' => $bucketName,
  'Key' => $functionName,
  'Body' => $file,
]);
echo "Uploaded the Lambda code.\n";
```

```
$createLambdaFunction = $lambdaService->createFunction($functionName,
$role, $bucketName, $handler);
// Wait until the function has finished being created.
do {
    $getLambdaFunction = $lambdaService-
>getFunction($createLambdaFunction['FunctionName']);
    } while ($getLambdaFunction['Configuration']['State'] == "Pending");
    echo "Created Lambda function {$getLambdaFunction['Configuration']
['FunctionName']}.\\n";

    sleep(1);

    echo "\\nOk, let's invoke that Lambda code.\\n";
    $basicParams = [
        'action' => 'increment',
        'number' => 3,
    ];
    /** @var Stream $invokeFunction */
    $invokeFunction = $lambdaService->invoke($functionName, $basicParams)
['Payload'];
    $result = json_decode($invokeFunction->getContents())->result;
    echo "After invoking the Lambda code with the input of
    {$basicParams['number']} we received $result.\\n";

    echo "\\nSince that's working, let's update the Lambda code.\\n";
    $codeCalculator = "lambda_handler_calculator.zip";
    $handlerCalculator = "lambda_handler_calculator";
    echo "First, put the new code into the S3 bucket.\\n";
    $file = file_get_contents($codeCalculator);
    $s3client->putObject([
        'Bucket' => $bucketName,
        'Key' => $functionName,
        'Body' => $file,
    ]);
    echo "New code uploaded.\\n";

    $lambdaService->updateFunctionCode($functionName, $bucketName,
$functionName);
    // Wait for the Lambda code to finish updating.
    do {
        $getLambdaFunction = $lambdaService-
>getFunction($createLambdaFunction['FunctionName']);
        } while ($getLambdaFunction['Configuration']['LastUpdateStatus'] !==
"Successful");
```

```
    echo "New Lambda code uploaded.\n";

    $environment = [
        'Variable' => ['Variables' => ['LOG_LEVEL' => 'DEBUG']],
    ];
    $lambdaService->updateFunctionConfiguration($functionName,
    $handlerCalculator, $environment);
    do {
        $getLambdaFunction = $lambdaService-
>getFunction($createLambdaFunction['FunctionName']);
        } while ($getLambdaFunction['Configuration']['LastUpdateStatus'] !==
"Successful");
        echo "Lambda code updated with new handler and a LOG_LEVEL of DEBUG for
more information.\n";

        echo "Invoke the new code with some new data.\n";
        $calculatorParams = [
            'action' => 'plus',
            'x' => 5,
            'y' => 4,
        ];
        $invokeFunction = $lambdaService->invoke($functionName,
    $calculatorParams, "Tail");
        $result = json_decode($invokeFunction['Payload']->getContents())->result;
        echo "Indeed, {$calculatorParams['x']} + {$calculatorParams['y']} does
equal $result.\n";
        echo "Here's the extra debug info: ";
        echo base64_decode($invokeFunction['LogResult']) . "\n";

        echo "\nBut what happens if you try to divide by zero?\n";
        $divZeroParams = [
            'action' => 'divide',
            'x' => 5,
            'y' => 0,
        ];
        $invokeFunction = $lambdaService->invoke($functionName, $divZeroParams,
    "Tail");
        $result = json_decode($invokeFunction['Payload']->getContents())->result;
        echo "You get a |$result| result.\n";
        echo "And an error message: ";
        echo base64_decode($invokeFunction['LogResult']) . "\n";

        echo "\nHere's all the Lambda functions you have in this Region:\n";
        $listLambdaFunctions = $lambdaService->listFunctions(5);
```



```
$allLambdaFunctions = $listLambdaFunctions['Functions'];
$next = $listLambdaFunctions->get('NextMarker');
while ($next != false) {
    $listLambdaFunctions = $lambdaService->listFunctions(5, $next);
    $next = $listLambdaFunctions->get('NextMarker');
    $allLambdaFunctions = array_merge($allLambdaFunctions,
$listLambdaFunctions['Functions']);
}
foreach ($allLambdaFunctions as $function) {
    echo "{$function['FunctionName']}\n";
}

echo "\n\nAnd don't forget to clean up your data!\n\n";

$lambdaService->deleteFunction($functionName);
echo "Deleted Lambda function.\n";
$iamService->deleteRole($role['RoleName']);
echo "Deleted Role.\n";
$deleteObjects = $s3client->listObjectsV2([
    'Bucket' => $bucketName,
]);
$deleteObjects = $s3client->deleteObjects([
    'Bucket' => $bucketName,
    'Delete' => [
        'Objects' => $deleteObjects['Contents'],
    ]
]);
echo "Deleted all objects from the S3 bucket.\n";
$s3client->deleteBucket(['Bucket' => $bucketName]);
echo "Deleted the bucket.\n";
}
}
```

- For API details, see the following topics in *AWS SDK for PHP API Reference*.
 - [CreateFunction](#)
 - [DeleteFunction](#)
 - [GetFunction](#)
 - [Invoke](#)
 - [ListFunctions](#)
 - [UpdateFunctionCode](#)

- [UpdateFunctionConfiguration](#)

Python

SDK for Python (Boto3)

Note

There's more on GitHub. Find the complete example and learn how to set up and run in the [AWS Code Examples Repository](#).

Define a Lambda handler that increments a number.

```
import logging

logger = logging.getLogger()
logger.setLevel(logging.INFO)

def lambda_handler(event, context):
    """
    Accepts an action and a single number, performs the specified action on the
    number,
    and returns the result. The only allowable action is 'increment'.

    :param event: The event dict that contains the parameters sent when the
    function
                 is invoked.
    :param context: The context in which the function is called.
    :return: The result of the action.
    """
    result = None
    action = event.get("action")
    if action == "increment":
        result = event.get("number", 0) + 1
        logger.info("Calculated result of %s", result)
    else:
        logger.error("%s is not a valid action.", action)

    response = {"result": result}
    return response
```

Define a second Lambda handler that performs arithmetic operations.

```
import logging
import os

logger = logging.getLogger()

# Define a list of Python lambda functions that are called by this AWS Lambda
function.
ACTIONS = {
    "plus": lambda x, y: x + y,
    "minus": lambda x, y: x - y,
    "times": lambda x, y: x * y,
    "divided-by": lambda x, y: x / y,
}

def lambda_handler(event, context):
    """
    Accepts an action and two numbers, performs the specified action on the
    numbers,
    and returns the result.

    :param event: The event dict that contains the parameters sent when the
    function
        is invoked.
    :param context: The context in which the function is called.
    :return: The result of the specified action.
    """
    # Set the log level based on a variable configured in the Lambda environment.
    logger.setLevel(os.environ.get("LOG_LEVEL", logging.INFO))
    logger.debug("Event: %s", event)

    action = event.get("action")
    func = ACTIONS.get(action)
    x = event.get("x")
    y = event.get("y")
    result = None
```

```

try:
    if func is not None and x is not None and y is not None:
        result = func(x, y)
        logger.info("%s %s %s is %s", x, action, y, result)
    else:
        logger.error("I can't calculate %s %s %s.", x, action, y)
except ZeroDivisionError:
    logger.warning("I can't divide %s by 0!", x)

response = {"result": result}
return response

```

Create functions that wrap Lambda actions.

```

class LambdaWrapper:
    def __init__(self, lambda_client, iam_resource):
        self.lambda_client = lambda_client
        self.iam_resource = iam_resource

    @staticmethod
    def create_deployment_package(source_file, destination_file):
        """
        Creates a Lambda deployment package in .zip format in an in-memory
        buffer. This
        buffer can be passed directly to Lambda when creating the function.

        :param source_file: The name of the file that contains the Lambda handler
            function.
        :param destination_file: The name to give the file when it's deployed to
            Lambda.
        :return: The deployment package.
        """
        buffer = io.BytesIO()
        with zipfile.ZipFile(buffer, "w") as zipped:
            zipped.write(source_file, destination_file)
        buffer.seek(0)
        return buffer.read()

    def get_iam_role(self, iam_role_name):

```

```
"""
Get an AWS Identity and Access Management (IAM) role.

:param iam_role_name: The name of the role to retrieve.
:return: The IAM role.
"""
role = None
try:
    temp_role = self.iam_resource.Role(iam_role_name)
    temp_role.load()
    role = temp_role
    logger.info("Got IAM role %s", role.name)
except ClientError as err:
    if err.response["Error"]["Code"] == "NoSuchEntity":
        logger.info("IAM role %s does not exist.", iam_role_name)
    else:
        logger.error(
            "Couldn't get IAM role %s. Here's why: %s: %s",
            iam_role_name,
            err.response["Error"]["Code"],
            err.response["Error"]["Message"],
        )
        raise
return role

def create_iam_role_for_lambda(self, iam_role_name):
    """
    Creates an IAM role that grants the Lambda function basic permissions. If
    a role with the specified name already exists, it is used for the demo.

    :param iam_role_name: The name of the role to create.
    :return: The role and a value that indicates whether the role is newly
    created.
    """
    role = self.get_iam_role(iam_role_name)
    if role is not None:
        return role, False

    lambda_assume_role_policy = {
        "Version": "2012-10-17",
        "Statement": [
            {
                "Effect": "Allow",
```

```

        "Principal": {"Service": "lambda.amazonaws.com"},
        "Action": "sts:AssumeRole",
    }
],
}
policy_arn = "arn:aws:iam::aws:policy/service-role/
AWSLambdaBasicExecutionRole"

try:
    role = self.iam_resource.create_role(
        RoleName=iam_role_name,
        AssumeRolePolicyDocument=json.dumps(lambda_assume_role_policy),
    )
    logger.info("Created role %s.", role.name)
    role.attach_policy(PolicyArn=policy_arn)
    logger.info("Attached basic execution policy to role %s.", role.name)
except ClientError as error:
    if error.response["Error"]["Code"] == "EntityAlreadyExists":
        role = self.iam_resource.Role(iam_role_name)
        logger.warning("The role %s already exists. Using it.",
iam_role_name)
    else:
        logger.exception(
            "Couldn't create role %s or attach policy %s.",
            iam_role_name,
            policy_arn,
        )
        raise

    return role, True

def get_function(self, function_name):
    """
    Gets data about a Lambda function.

    :param function_name: The name of the function.
    :return: The function data.
    """
    response = None
    try:
        response =
self.lambda_client.get_function(FunctionName=function_name)
    except ClientError as err:
        if err.response["Error"]["Code"] == "ResourceNotFoundException":

```

```

        logger.info("Function %s does not exist.", function_name)
    else:
        logger.error(
            "Couldn't get function %s. Here's why: %s: %s",
            function_name,
            err.response["Error"]["Code"],
            err.response["Error"]["Message"],
        )
        raise
    return response

def create_function(
    self, function_name, handler_name, iam_role, deployment_package
):
    """
    Deploys a Lambda function.

    :param function_name: The name of the Lambda function.
    :param handler_name: The fully qualified name of the handler function.
    This
                           must include the file name and the function name.
    :param iam_role: The IAM role to use for the function.
    :param deployment_package: The deployment package that contains the
    function
                           code in .zip format.
    :return: The Amazon Resource Name (ARN) of the newly created function.
    """
    try:
        response = self.lambda_client.create_function(
            FunctionName=function_name,
            Description="AWS Lambda doc example",
            Runtime="python3.9",
            Role=iam_role.arn,
            Handler=handler_name,
            Code={"ZipFile": deployment_package},
            Publish=True,
        )
        function_arn = response["FunctionArn"]
        waiter = self.lambda_client.get_waiter("function_active_v2")
        waiter.wait(FunctionName=function_name)
        logger.info(
            "Created function '%s' with ARN: '%s'.",
            function_name,

```

```
        response["FunctionArn"],
    )
except ClientError:
    logger.error("Couldn't create function %s.", function_name)
    raise
else:
    return function_arn

def delete_function(self, function_name):
    """
    Deletes a Lambda function.

    :param function_name: The name of the function to delete.
    """
    try:
        self.lambda_client.delete_function(FunctionName=function_name)
    except ClientError:
        logger.exception("Couldn't delete function %s.", function_name)
        raise

def invoke_function(self, function_name, function_params, get_log=False):
    """
    Invokes a Lambda function.

    :param function_name: The name of the function to invoke.
    :param function_params: The parameters of the function as a dict. This
dict
                           is serialized to JSON before it is sent to
Lambda.
    :param get_log: When true, the last 4 KB of the execution log are
included in
                   the response.
    :return: The response from the function invocation.
    """
    try:
        response = self.lambda_client.invoke(
            FunctionName=function_name,
            Payload=json.dumps(function_params),
            LogType="Tail" if get_log else "None",
        )
        logger.info("Invoked function %s.", function_name)
    except ClientError:
```



```
        logger.exception("Couldn't invoke function %s.", function_name)
        raise
    return response

def update_function_code(self, function_name, deployment_package):
    """
    Updates the code for a Lambda function by submitting a .zip archive that
    contains
    the code for the function.

    :param function_name: The name of the function to update.
    :param deployment_package: The function code to update, packaged as bytes
    in
                                .zip format.
    :return: Data about the update, including the status.
    """
    try:
        response = self.lambda_client.update_function_code(
            FunctionName=function_name, ZipFile=deployment_package
        )
    except ClientError as err:
        logger.error(
            "Couldn't update function %s. Here's why: %s: %s",
            function_name,
            err.response["Error"]["Code"],
            err.response["Error"]["Message"],
        )
        raise
    else:
        return response

def update_function_configuration(self, function_name, env_vars):
    """
    Updates the environment variables for a Lambda function.

    :param function_name: The name of the function to update.
    :param env_vars: A dict of environment variables to update.
    :return: Data about the update, including the status.
    """
    try:
        response = self.lambda_client.update_function_configuration(
            FunctionName=function_name, Environment={"Variables": env_vars}
```

```
    )
except ClientError as err:
    logger.error(
        "Couldn't update function configuration %s. Here's why: %s: %s",
        function_name,
        err.response["Error"]["Code"],
        err.response["Error"]["Message"],
    )
    raise
else:
    return response

def list_functions(self):
    """
    Lists the Lambda functions for the current account.
    """
    try:
        func_paginator = self.lambda_client.get_paginator("list_functions")
        for func_page in func_paginator.paginate():
            for func in func_page["Functions"]:
                print(func["FunctionName"])
                desc = func.get("Description")
                if desc:
                    print(f"\t{desc}")
                    print(f"\t{func['Runtime']}: {func['Handler']}")
    except ClientError as err:
        logger.error(
            "Couldn't list functions. Here's why: %s: %s",
            err.response["Error"]["Code"],
            err.response["Error"]["Message"],
        )
        raise
```

Create a function that runs the scenario.

```
class UpdateFunctionWaiter(CustomWaiter):
    """A custom waiter that waits until a function is successfully updated."""
```

```
def __init__(self, client):
    super().__init__(
        "UpdateSuccess",
        "GetFunction",
        "Configuration.LastUpdateStatus",
        {"Successful": WaitState.SUCCESS, "Failed": WaitState.FAILURE},
        client,
    )

def wait(self, function_name):
    self._wait(FunctionName=function_name)

def run_scenario(lambda_client, iam_resource, basic_file, calculator_file,
lambda_name):
    """
    Runs the scenario.

    :param lambda_client: A Boto3 Lambda client.
    :param iam_resource: A Boto3 IAM resource.
    :param basic_file: The name of the file that contains the basic Lambda
    handler.
    :param calculator_file: The name of the file that contains the calculator
    Lambda handler.
    :param lambda_name: The name to give resources created for the scenario, such
    as the
        IAM role and the Lambda function.
    """
    logging.basicConfig(level=logging.INFO, format="%(levelname)s: %(message)s")

    print("-" * 88)
    print("Welcome to the AWS Lambda getting started with functions demo.")
    print("-" * 88)

    wrapper = LambdaWrapper(lambda_client, iam_resource)

    print("Checking for IAM role for Lambda...")
    iam_role, should_wait = wrapper.create_iam_role_for_lambda(lambda_name)
    if should_wait:
        logger.info("Giving AWS time to create resources...")
        wait(10)

    print(f"Looking for function {lambda_name}...")
    function = wrapper.get_function(lambda_name)
```

```
if function is None:
    print("Zipping the Python script into a deployment package...")
    deployment_package = wrapper.create_deployment_package(
        basic_file, f"{lambda_name}.py"
    )
    print(f"...and creating the {lambda_name} Lambda function.")
    wrapper.create_function(
        lambda_name, f"{lambda_name}.lambda_handler", iam_role,
        deployment_package
    )
else:
    print(f"Function {lambda_name} already exists.")
print("-" * 88)

print(f"Let's invoke {lambda_name}. This function increments a number.")
action_params = {
    "action": "increment",
    "number": q.ask("Give me a number to increment: ", q.is_int),
}
print(f"Invoking {lambda_name}...")
response = wrapper.invoke_function(lambda_name, action_params)
print(
    f"Incrementing {action_params['number']} resulted in "
    f"{json.load(response['Payload'])}"
)
print("-" * 88)

print(f"Let's update the function to an arithmetic calculator.")
q.ask("Press Enter when you're ready.")
print("Creating a new deployment package...")
deployment_package = wrapper.create_deployment_package(
    calculator_file, f"{lambda_name}.py"
)
print(f"...and updating the {lambda_name} Lambda function.")
update_waiter = UpdateFunctionWaiter(lambda_client)
wrapper.update_function_code(lambda_name, deployment_package)
update_waiter.wait(lambda_name)
print(f"This function uses an environment variable to control logging
level.")
print(f"Let's set it to DEBUG to get the most logging.")
wrapper.update_function_configuration(
    lambda_name, {"LOG_LEVEL": logging.getLevelName(logging.DEBUG)}
)
```

```

actions = ["plus", "minus", "times", "divided-by"]
want_invoke = True
while want_invoke:
    print(f"Let's invoke {lambda_name}. You can invoke these actions:")
    for index, action in enumerate(actions):
        print(f"{index + 1}: {action}")
    action_params = {}
    action_index = q.ask(
        "Enter the number of the action you want to take: ",
        q.is_int,
        q.in_range(1, len(actions)),
    )
    action_params["action"] = actions[action_index - 1]
    print(f"You've chosen to invoke 'x {action_params['action']} y'.")
    action_params["x"] = q.ask("Enter a value for x: ", q.is_int)
    action_params["y"] = q.ask("Enter a value for y: ", q.is_int)
    print(f"Invoking {lambda_name}...")
    response = wrapper.invoke_function(lambda_name, action_params, True)
    print(
        f"Calculating {action_params['x']} {action_params['action']}
{action_params['y']} "
        f"resulted in {json.load(response['Payload'])}"
    )
    q.ask("Press Enter to see the logs from the call.")
    print(base64.b64decode(response["LogResult"]).decode())
    want_invoke = q.ask("That was fun. Shall we do it again? (y/n) ",
q.is_yesno)
    print("-" * 88)

    if q.ask(
        "Do you want to list all of the functions in your account? (y/n) ",
q.is_yesno
    ):
        wrapper.list_functions()
        print("-" * 88)

    if q.ask("Ready to delete the function and role? (y/n) ", q.is_yesno):
        for policy in iam_role.attached_policies.all():
            policy.detach_role(RoleName=iam_role.name)
        iam_role.delete()
        print(f"Deleted role {lambda_name}.")
        wrapper.delete_function(lambda_name)
        print(f"Deleted function {lambda_name}.")

```

```
print("\nThanks for watching!")
print("-" * 88)

if __name__ == "__main__":
    try:
        run_scenario(
            boto3.client("lambda"),
            boto3.resource("iam"),
            "lambda_handler_basic.py",
            "lambda_handler_calculator.py",
            "doc_example_lambda_calculator",
        )
    except Exception:
        logging.exception("Something went wrong with the demo!")
```

- For API details, see the following topics in *AWS SDK for Python (Boto3) API Reference*.
 - [CreateFunction](#)
 - [DeleteFunction](#)
 - [GetFunction](#)
 - [Invoke](#)
 - [ListFunctions](#)
 - [UpdateFunctionCode](#)
 - [UpdateFunctionConfiguration](#)

Ruby

SDK for Ruby

Note

There's more on GitHub. Find the complete example and learn how to set up and run in the [AWS Code Examples Repository](#).

Set up pre-requisite IAM permissions for a Lambda function capable of writing logs.

```
# Get an AWS Identity and Access Management (IAM) role.
```

```
#
# @param iam_role_name: The name of the role to retrieve.
# @param action: Whether to create or destroy the IAM apparatus.
# @return: The IAM role.
def manage_iam(iam_role_name, action)
  case action
  when 'create'
    create_iam_role(iam_role_name)
  when 'destroy'
    destroy_iam_role(iam_role_name)
  else
    raise "Incorrect action provided. Must provide 'create' or 'destroy'"
  end
end

private

def create_iam_role(iam_role_name)
  role_policy = {
    'Version': '2012-10-17',
    'Statement': [
      {
        'Effect': 'Allow',
        'Principal': { 'Service': 'lambda.amazonaws.com' },
        'Action': 'sts:AssumeRole'
      }
    ]
  }
  role = @iam_client.create_role(
    role_name: iam_role_name,
    assume_role_policy_document: role_policy.to_json
  )
  @iam_client.attach_role_policy(
    {
      policy_arn: 'arn:aws:iam::aws:policy/service-role/
AWSLambdaBasicExecutionRole',
      role_name: iam_role_name
    }
  )
  wait_for_role_to_exist(iam_role_name)
  @logger.debug("Successfully created IAM role: #{role['role']['arn']}")
  sleep(10)
  [role, role_policy.to_json]
end
```

```
def destroy_iam_role(iam_role_name)
  @iam_client.detach_role_policy(
    {
      policy_arn: 'arn:aws:iam::aws:policy/service-role/
AWSLambdaBasicExecutionRole',
      role_name: iam_role_name
    }
  )
  @iam_client.delete_role(role_name: iam_role_name)
  @logger.debug("Detached policy & deleted IAM role: #{iam_role_name}")
end

def wait_for_role_to_exist(iam_role_name)
  @iam_client.wait_until(:role_exists, { role_name: iam_role_name }) do |w|
    w.max_attempts = 5
    w.delay = 5
  end
end
```

Define a Lambda handler that increments a number provided as an invocation parameter.

```
require 'logger'

# A function that increments a whole number by one (1) and logs the result.
# Requires a manually-provided runtime parameter, 'number', which must be Int
#
# @param event [Hash] Parameters sent when the function is invoked
# @param context [Hash] Methods and properties that provide information
# about the invocation, function, and execution environment.
# @return incremented_number [String] The incremented number.
def lambda_handler(event:, context:)
  logger = Logger.new($stdout)
  log_level = ENV['LOG_LEVEL']
  logger.level = case log_level
                 when 'debug'
                   Logger::DEBUG
                 when 'info'
                   Logger::INFO
                 else
                   Logger::ERROR
                 end
end
```



```
logger.debug('This is a debug log message.')
logger.info('This is an info log message. Code executed successfully!')
number = event['number'].to_i
incremented_number = number + 1
logger.info("You provided #{number.round} and it was incremented to
#{incremented_number.round}")
incremented_number.round.to_s
end
```

Zip your Lambda function into a deployment package.

```
# Creates a Lambda deployment package in .zip format.
#
# @param source_file: The name of the object, without suffix, for the Lambda
file and zip.
# @return: The deployment package.
def create_deployment_package(source_file)
  Dir.chdir(File.dirname(__FILE__))
  if File.exist?('lambda_function.zip')
    File.delete('lambda_function.zip')
    @logger.debug('Deleting old zip: lambda_function.zip')
  end
  Zip::File.open('lambda_function.zip', create: true) do |zipfile|
    zipfile.add('lambda_function.rb', "#{source_file}.rb")
  end
  @logger.debug("Zipping #{source_file}.rb into: lambda_function.zip.")
  File.read('lambda_function.zip').to_s
rescue StandardError => e
  @logger.error("There was an error creating deployment package:\n
#{e.message}")
end
```

Create a new Lambda function.

```
# Deploys a Lambda function.
#
# @param function_name: The name of the Lambda function.
# @param handler_name: The fully qualified name of the handler function.
# @param role_arn: The IAM role to use for the function.
# @param deployment_package: The deployment package that contains the function
code in .zip format.
```

```

# @return: The Amazon Resource Name (ARN) of the newly created function.
def create_function(function_name, handler_name, role_arn, deployment_package)
  response = @lambda_client.create_function({
    role: role_arn.to_s,
    function_name: function_name,
    handler: handler_name,
    runtime: 'ruby2.7',
    code: {
      zip_file: deployment_package
    },
    environment: {
      variables: {
        'LOG_LEVEL' => 'info'
      }
    }
  })

  @lambda_client.wait_until(:function_active_v2, { function_name:
function_name }) do |w|
    w.max_attempts = 5
    w.delay = 5
  end
  response
rescue Aws::Lambda::Errors::ServiceException => e
  @logger.error("There was an error creating #{function_name}:\n #{e.message}")
rescue Aws::Writers::Errors::WaiterFailed => e
  @logger.error("Failed waiting for #{function_name} to activate:\n
#{e.message}")
end

```

Invoke your Lambda function with optional runtime parameters.

```

# Invokes a Lambda function.
# @param function_name [String] The name of the function to invoke.
# @param payload [nil] Payload containing runtime parameters.
# @return [Object] The response from the function invocation.
def invoke_function(function_name, payload = nil)
  params = { function_name: function_name }
  params[:payload] = payload unless payload.nil?
  @lambda_client.invoke(params)
rescue Aws::Lambda::Errors::ServiceException => e
  @logger.error("There was an error executing #{function_name}:\n
#{e.message}")
end

```

```
end
```

Update your Lambda function's configuration to inject a new environment variable.

```
# Updates the environment variables for a Lambda function.
# @param function_name: The name of the function to update.
# @param log_level: The log level of the function.
# @return: Data about the update, including the status.
def update_function_configuration(function_name, log_level)
  @lambda_client.update_function_configuration({
    function_name: function_name,
    environment: {
      variables: {
        'LOG_LEVEL' => log_level
      }
    }
  })

  @lambda_client.wait_until(:function_updated_v2, { function_name:
function_name }) do |w|
    w.max_attempts = 5
    w.delay = 5
  end
  rescue Aws::Lambda::Errors::ServiceException => e
    @logger.error("There was an error updating configurations for
#{function_name}:\n #{e.message}")
  rescue Aws::Waiters::Errors::WaiterFailed => e
    @logger.error("Failed waiting for #{function_name} to activate:\n
#{e.message}")
  end
end
```

Update your Lambda function's code with a different deployment package containing different code.

```
# Updates the code for a Lambda function by submitting a .zip archive that
contains
# the code for the function.
#
# @param function_name: The name of the function to update.
# @param deployment_package: The function code to update, packaged as bytes in
#                               .zip format.
# @return: Data about the update, including the status.
```

```

def update_function_code(function_name, deployment_package)
  @lambda_client.update_function_code(
    function_name: function_name,
    zip_file: deployment_package
  )
  @lambda_client.wait_until(:function_updated_v2, { function_name:
function_name }) do |w|
    w.max_attempts = 5
    w.delay = 5
  end
  rescue Aws::Lambda::Errors::ServiceException => e
    @logger.error("There was an error updating function code for:
#{function_name}:\n #{e.message}")
    nil
  rescue Aws::Waiters::Errors::WaiterFailed => e
    @logger.error("Failed waiting for #{function_name} to update:\n
#{e.message}")
  end
end

```

List all existing Lambda functions using the built-in paginator.

```

# Lists the Lambda functions for the current account.
def list_functions
  functions = []
  @lambda_client.list_functions.each do |response|
    response['functions'].each do |function|
      functions.append(function['function_name'])
    end
  end
  functions
  rescue Aws::Lambda::Errors::ServiceException => e
    @logger.error("There was an error listing functions:\n #{e.message}")
  end
end

```

Delete a specific Lambda function.

```

# Deletes a Lambda function.
# @param function_name: The name of the function to delete.
def delete_function(function_name)
  print "Deleting function: #{function_name}..."
  @lambda_client.delete_function(

```

```
    function_name: function_name
  )
  print 'Done!'.green
rescue Aws::Lambda::Errors::ServiceException => e
  @logger.error("There was an error deleting #{function_name}:\n #{e.message}")
end
```

- For API details, see the following topics in *AWS SDK for Ruby API Reference*.
 - [CreateFunction](#)
 - [DeleteFunction](#)
 - [GetFunction](#)
 - [Invoke](#)
 - [ListFunctions](#)
 - [UpdateFunctionCode](#)
 - [UpdateFunctionConfiguration](#)

Rust

SDK for Rust

Note

There's more on GitHub. Find the complete example and learn how to set up and run in the [AWS Code Examples Repository](#).

The Cargo.toml with dependencies used in this scenario.

```
[package]
name = "lambda-code-examples"
version = "0.1.0"
edition = "2021"

# See more keys and their definitions at https://doc.rust-lang.org/cargo/reference/manifest.html

[dependencies]
aws-config = { version = "1.0.1", features = ["behavior-version-latest"] }
```

```
aws-sdk-ec2 = { version = "1.3.0" }
aws-sdk-iam = { version = "1.3.0" }
aws-sdk-lambda = { version = "1.3.0" }
aws-sdk-s3 = { version = "1.4.0" }
aws-smithy-types = { version = "1.0.1" }
aws-types = { version = "1.0.1" }
clap = { version = "4.4", features = ["derive"] }
tokio = { version = "1.20.1", features = ["full"] }
tracing-subscriber = { version = "0.3.15", features = ["env-filter"] }
tracing = "0.1.37"
serde_json = "1.0.94"
anyhow = "1.0.71"
uuid = { version = "1.3.3", features = ["v4"] }
lambda_runtime = "0.8.0"
serde = "1.0.164"
```

A collection of utilities that streamline calling Lambda for this scenario. This file is `src/ations.rs` in the crate.

```
use anyhow::anyhow;
use aws_sdk_iam::operation::{create_role::CreateRoleError,
    delete_role::DeleteRoleOutput};
use aws_sdk_lambda::{
    operation::{
        delete_function::DeleteFunctionOutput, get_function::GetFunctionOutput,
        invoke::InvokeOutput, list_functions::ListFunctionsOutput,
        update_function_code::UpdateFunctionCodeOutput,
        update_function_configuration::UpdateFunctionConfigurationOutput,
    },
    primitives::ByteStream,
    types::{Environment, FunctionCode, LastUpdateStatus, State},
};
use aws_sdk_s3::{
    error::ErrorMetadata,
    operation::{delete_bucket::DeleteBucketOutput,
        delete_object::DeleteObjectOutput},
    types::CreateBucketConfiguration,
};
use aws_smithy_types::Blob;
use serde::{ser::SerializeMap, Serialize};
use std::{fmt::Display, path::PathBuf, str::FromStr, time::Duration};
```

```
use tracing::{debug, info, warn};

/* Operation describes */
#[derive(Clone, Copy, Debug, Serialize)]
pub enum Operation {
    #[serde(rename = "plus")]
    Plus,
    #[serde(rename = "minus")]
    Minus,
    #[serde(rename = "times")]
    Times,
    #[serde(rename = "divided-by")]
    DividedBy,
}

impl FromStr for Operation {
    type Err = anyhow::Error;

    fn from_str(s: &str) -> Result<Self, Self::Err> {
        match s {
            "plus" => Ok(Operation::Plus),
            "minus" => Ok(Operation::Minus),
            "times" => Ok(Operation::Times),
            "divided-by" => Ok(Operation::DividedBy),
            _ => Err(anyhow!("Unknown operation {s}")),
        }
    }
}

impl Display for Operation {
    fn fmt(&self, f: &mut std::fmt::Formatter<'_>) -> std::fmt::Result {
        match self {
            Operation::Plus => write!(f, "plus"),
            Operation::Minus => write!(f, "minus"),
            Operation::Times => write!(f, "times"),
            Operation::DividedBy => write!(f, "divided-by"),
        }
    }
}

/**
 * InvokeArgs will be serialized as JSON and sent to the AWS Lambda handler.
 */
#[derive(Debug)]
```

```

pub enum InvokeArgs {
    Increment(i32),
    Arithmetic(Operation, i32, i32),
}

impl Serialize for InvokeArgs {
    fn serialize<S>(&self, serializer: S) -> Result<S::Ok, S::Error>
    where
        S: serde::Serializer,
    {
        match self {
            InvokeArgs::Increment(i) => serializer.serialize_i32(*i),
            InvokeArgs::Arithmetic(o, i, j) => {
                let mut map: S::SerializeMap =
serializer.serialize_map(Some(3))?;
                map.serialize_key(&"op".to_string())?;
                map.serialize_value(&o.to_string())?;
                map.serialize_key(&"i".to_string())?;
                map.serialize_value(&i)?;
                map.serialize_key(&"j".to_string())?;
                map.serialize_value(&j)?;
                map.end()
            }
        }
    }
}

/** A policy document allowing Lambda to execute this function on the account's
    behalf. */
const ROLE_POLICY_DOCUMENT: &str = r#"{
    "Version": "2012-10-17",
    "Statement": [
        {
            "Effect": "Allow",
            "Principal": { "Service": "lambda.amazonaws.com" },
            "Action": "sts:AssumeRole"
        }
    ]
}"#;

/**
 * A LambdaManager gathers all the resources necessary to run the Lambda example
    scenario.
 * This includes instantiated aws_sdk clients and details of resource names.

```



```
*/
pub struct LambdaManager {
    iam_client: aws_sdk_iam::Client,
    lambda_client: aws_sdk_lambda::Client,
    s3_client: aws_sdk_s3::Client,
    lambda_name: String,
    role_name: String,
    bucket: String,
    own_bucket: bool,
}

// These unit type structs provide nominal typing on top of String parameters for
// LambdaManager::new
pub struct LambdaName(pub String);
pub struct RoleName(pub String);
pub struct Bucket(pub String);
pub struct OwnBucket(pub bool);

impl LambdaManager {
    pub fn new(
        iam_client: aws_sdk_iam::Client,
        lambda_client: aws_sdk_lambda::Client,
        s3_client: aws_sdk_s3::Client,
        lambda_name: LambdaName,
        role_name: RoleName,
        bucket: Bucket,
        own_bucket: OwnBucket,
    ) -> Self {
        Self {
            iam_client,
            lambda_client,
            s3_client,
            lambda_name: lambda_name.0,
            role_name: role_name.0,
            bucket: bucket.0,
            own_bucket: own_bucket.0,
        }
    }
}

/**
 * Load the AWS configuration from the environment.
 * Look up lambda_name and bucket if none are given, or generate a random
 name if not present in the environment.

```

```

    * If the bucket name is provided, the caller needs to have created the
    bucket.
    * If the bucket name is generated, it will be created.
    */
    pub async fn load_from_env(lambda_name: Option<String>, bucket:
Option<String>) -> Self {
        let sdk_config = aws_config::load_from_env().await;
        let lambda_name = LambdaName(lambda_name.unwrap_or_else(|| {
            std::env::var("LAMBDA_NAME").unwrap_or_else(|_|
"rust_lambda_example".to_string())
        }));
        let role_name = RoleName(format!("{}_role", lambda_name.0));
        let (bucket, own_bucket) =
            match bucket {
                Some(bucket) => (Bucket(bucket), false),
                None => (
                    Bucket(std::env::var("LAMBDA_BUCKET").unwrap_or_else(|_| {
                        format!("rust-lambda-example-{}", uuid::Uuid::new_v4())
                    })),
                    true,
                ),
            };

        let s3_client = aws_sdk_s3::Client::new(&sdk_config);

        if own_bucket {
            info!("Creating bucket for demo: {}", bucket.0);
            s3_client
                .create_bucket()
                .bucket(bucket.0.clone())
                .create_bucket_configuration(
                    CreateBucketConfiguration::builder()

.location_constraint(aws_sdk_s3::types::BucketLocationConstraint::from(
                    sdk_config.region().unwrap().as_ref(),
                ))
                .build(),
            )
                .send()
                .await
                .unwrap();
        }

        Self::new(

```

```
        aws_sdk_iam::Client::new(&sdk_config),
        aws_sdk_lambda::Client::new(&sdk_config),
        s3_client,
        lambda_name,
        role_name,
        bucket,
        OwnBucket(own_bucket),
    )
}

/**
 * Upload function code from a path to a zip file.
 * The zip file must have an AL2 Linux-compatible binary called `bootstrap`.
 * The easiest way to create such a zip is to use `cargo lambda build --
output-format Zip`.
 */
async fn prepare_function(
    &self,
    zip_file: PathBuf,
    key: Option<String>,
) -> Result<FunctionCode, anyhow::Error> {
    let body = ByteStream::from_path(zip_file).await?;

    let key = key.unwrap_or_else(|| format!("{}_code", self.lambda_name));

    info!("Uploading function code to s3://{}/{}", self.bucket, key);
    let _ = self
        .s3_client
        .put_object()
        .bucket(self.bucket.clone())
        .key(key.clone())
        .body(body)
        .send()
        .await?;

    Ok(FunctionCode::builder()
        .s3_bucket(self.bucket.clone())
        .s3_key(key)
        .build())
}

/**
 * Create a function, uploading from a zip file.
 */
```

```

pub async fn create_function(&self, zip_file: PathBuf) -> Result<String,
anyhow::Error> {
    let code = self.prepare_function(zip_file, None).await?;

    let key = code.s3_key().unwrap().to_string();

    let role = self.create_role().await.map_err(|e| anyhow!(e))?;

    info!("Created iam role, waiting 15s for it to become active");
    tokio::time::sleep(Duration::from_secs(15)).await;

    info!("Creating lambda function {}", self.lambda_name);
    let _ = self
        .lambda_client
        .create_function()
        .function_name(self.lambda_name.clone())
        .code(code)
        .role(role.arn())
        .runtime(aws_sdk_lambda::types::Runtime::ProvidedAl2)
        .handler("_unused")
        .send()
        .await
        .map_err(anyhow::Error::from)?;

    self.wait_for_function_ready().await?;

    self.lambda_client
        .publish_version()
        .function_name(self.lambda_name.clone())
        .send()
        .await?;

    Ok(key)
}

/**
 * Create an IAM execution role for the managed Lambda function.
 * If the role already exists, use that instead.
 */
async fn create_role(&self) -> Result<aws_sdk_iam::types::Role,
CreateRoleError> {
    info!("Creating execution role for function");
    let get_role = self
        .iam_client

```

```
        .get_role()
        .role_name(self.role_name.clone())
        .send()
        .await;
    if let Ok(get_role) = get_role {
        if let Some(role) = get_role.role {
            return Ok(role);
        }
    }

    let create_role = self
        .iam_client
        .create_role()
        .role_name(self.role_name.clone())
        .assume_role_policy_document(ROLE_POLICY_DOCUMENT)
        .send()
        .await;

    match create_role {
        Ok(create_role) => match create_role.role {
            Some(role) => Ok(role),
            None => Err(CreateRoleError::generic(
                ErrorMetadata::builder()
                    .message("CreateRole returned empty success")
                    .build(),
            )),
        },
        Err(err) => Err(err.into_service_error()),
    }
}

/**
 * Poll `is_function_ready` with a 1-second delay. It returns when the
 * function is ready or when there's an error checking the function's state.
 */
pub async fn wait_for_function_ready(&self) -> Result<(), anyhow::Error> {
    info!("Waiting for function");
    while !self.is_function_ready(None).await? {
        info!("Function is not ready, sleeping 1s");
        tokio::time::sleep(Duration::from_secs(1)).await;
    }
    Ok(())
}
```

```

/**
 * Check if a Lambda function is ready to be invoked.
 * A Lambda function is ready for this scenario when its state is active and
its LastUpdateStatus is Successful.
 * Additionally, if a sha256 is provided, the function must have that as its
current code hash.
 * Any missing properties or failed requests will be reported as an Err.
 */
async fn is_function_ready(
    &self,
    expected_code_sha256: Option<&str>,
) -> Result<bool, anyhow::Error> {
    match self.get_function().await {
        Ok(func) => {
            if let Some(config) = func.configuration() {
                if let Some(state) = config.state() {
                    info!(?state, "Checking if function is active");
                    if !matches!(state, State::Active) {
                        return Ok(false);
                    }
                }
            }
            match config.last_update_status() {
                Some(last_update_status) => {
                    info!(?last_update_status, "Checking if function is
ready");

                    match last_update_status {
                        LastUpdateStatus::Successful => {
                            // continue
                        }
                        LastUpdateStatus::Failed |
LastUpdateStatus::InProgress => {
                            return Ok(false);
                        }
                        unknown => {
                            warn!(
                                status_variant = unknown.as_str(),
                                "LastUpdateStatus unknown"
                            );
                            return Err(anyhow!(
                                "Unknown LastUpdateStatus, fn config is
{config:?}"
                            ));
                        }
                    }
                }
            }
        }
    }
}

```

```

        }
        None => {
            warn!("Missing last update status");
            return Ok(false);
        }
    };
    if expected_code_sha256.is_none() {
        return Ok(true);
    }
    if let Some(code_sha256) = config.code_sha256() {
        return Ok(code_sha256 ==
expected_code_sha256.unwrap_or_default());
    }
}
}
Err(e) => {
    warn!(?e, "Could not get function while waiting");
}
}
Ok(false)
}

/** Get the Lambda function with this Manager's name. */
pub async fn get_function(&self) -> Result<GetFunctionOutput, anyhow::Error>
{
    info!("Getting lambda function");
    self.lambda_client
        .get_function()
        .function_name(self.lambda_name.clone())
        .send()
        .await
        .map_err(anyhow::Error::from)
}

/** List all Lambda functions in the current Region. */
pub async fn list_functions(&self) -> Result<ListFunctionsOutput,
anyhow::Error> {
    info!("Listing lambda functions");
    self.lambda_client
        .list_functions()
        .send()
        .await
        .map_err(anyhow::Error::from)
}
}

```

```
/** Invoke the lambda function using calculator InvokeArgs. */
pub async fn invoke(&self, args: InvokeArgs) -> Result<InvokeOutput,
anyhow::Error> {
    info!(?args, "Invoking {}", self.lambda_name);
    let payload = serde_json::to_string(&args)?;
    debug!(?payload, "Sending payload");
    self.lambda_client
        .invoke()
        .function_name(self.lambda_name.clone())
        .payload(Blob::new(payload))
        .send()
        .await
        .map_err(anyhow::Error::from)
}

/** Given a Path to a zip file, update the function's code and wait for the
update to finish. */
pub async fn update_function_code(
    &self,
    zip_file: PathBuf,
    key: String,
) -> Result<UpdateFunctionCodeOutput, anyhow::Error> {
    let function_code = self.prepare_function(zip_file, Some(key)).await?;

    info!("Updating code for {}", self.lambda_name);
    let update = self
        .lambda_client
        .update_function_code()
        .function_name(self.lambda_name.clone())
        .s3_bucket(self.bucket.clone())
        .s3_key(function_code.s3_key().unwrap().to_string())
        .send()
        .await
        .map_err(anyhow::Error::from)?;

    self.wait_for_function_ready().await?;

    Ok(update)
}

/** Update the environment for a function. */
pub async fn update_function_configuration(
    &self,
```



```
        environment: Environment,
    ) -> Result<UpdateFunctionConfigurationOutput, anyhow::Error> {
        info!(
            ?environment,
            "Updating environment for {}", self.lambda_name
        );
        let updated = self
            .lambda_client
            .update_function_configuration()
            .function_name(self.lambda_name.clone())
            .environment(environment)
            .send()
            .await
            .map_err(anyhow::Error::from)?;

        self.wait_for_function_ready().await?;

        Ok(updated)
    }

    /** Delete a function and its role, and if possible or necessary, its
    associated code object and bucket. */
    pub async fn delete_function(
        &self,
        location: Option<String>,
    ) -> (
        Result<DeleteFunctionOutput, anyhow::Error>,
        Result<DeleteRoleOutput, anyhow::Error>,
        Option<Result<DeleteObjectOutput, anyhow::Error>>,
    ) {
        info!("Deleting lambda function {}", self.lambda_name);
        let delete_function = self
            .lambda_client
            .delete_function()
            .function_name(self.lambda_name.clone())
            .send()
            .await
            .map_err(anyhow::Error::from);

        info!("Deleting iam role {}", self.role_name);
        let delete_role = self
            .iam_client
            .delete_role()
            .role_name(self.role_name.clone())
```

```

        .send()
        .await
        .map_err(anyhow::Error::from);

let delete_object: Option<Result<DeleteObjectOutput, anyhow::Error>> =
    if let Some(location) = location {
        info!("Deleting object {location}");
        Some(
            self.s3_client
                .delete_object()
                .bucket(self.bucket.clone())
                .key(location)
                .send()
                .await
                .map_err(anyhow::Error::from),
        )
    } else {
        info!(?location, "Skipping delete object");
        None
    };

    (delete_function, delete_role, delete_object)
}

pub async fn cleanup(
    &self,
    location: Option<String>,
) -> (
    (
        Result<DeleteFunctionOutput, anyhow::Error>,
        Result<DeleteRoleOutput, anyhow::Error>,
        Option<Result<DeleteObjectOutput, anyhow::Error>>,
    ),
    Option<Result<DeleteBucketOutput, anyhow::Error>>,
) {
    let delete_function = self.delete_function(location).await;

    let delete_bucket = if self.own_bucket {
        info!("Deleting bucket {}", self.bucket);
        if delete_function.2.is_none() ||
delete_function.2.as_ref().unwrap().is_ok() {
            Some(
                self.s3_client
                    .delete_bucket()

```

```

        .bucket(self.bucket.clone())
        .send()
        .await
        .map_err(anyhow::Error::from),
    )
    } else {
        None
    }
} else {
    info!("No bucket to clean up");
    None
};

(delete_function, delete_bucket)
}
}

/**
 * Testing occurs primarily as an integration test running the `scenario` bin
 * successfully.
 * Each action relies deeply on the internal workings and state of Amazon Simple
 * Storage Service (Amazon S3), Lambda, and IAM working together.
 * It is therefore infeasible to mock the clients to test the individual actions.
 */
#[cfg(test)]
mod test {
    use super::{InvokeArgs, Operation};
    use serde_json::json;

    /** Make sure that the JSON output of serializing InvokeArgs is what's
    expected by the calculator. */
    #[test]
    fn test_serialize() {
        assert_eq!(json!(InvokeArgs::Increment(5)), 5);
        assert_eq!(
            json!(InvokeArgs::Arithmetic(Operation::Plus, 5, 7)).to_string(),
            r#"{"op":"plus","i":5,"j":7}"#.to_string(),
        );
    }
}
}

```

A binary to run the scenario from front to end, using command line flags to control some behavior. This file is `src/bin/scenario.rs` in the crate.

```
/*
## Service actions

Service actions wrap the SDK call, taking a client and any specific parameters
necessary for the call.

* CreateFunction
* GetFunction
* ListFunctions
* Invoke
* UpdateFunctionCode
* UpdateFunctionConfiguration
* DeleteFunction

## Scenario
A scenario runs at a command prompt and prints output to the user on the result
of each service action. A scenario can run in one of two ways: straight through,
printing out progress as it goes, or as an interactive question/answer script.

## Getting started with functions

Use an SDK to manage AWS Lambda functions: create a function, invoke it, update
its code, invoke it again, view its output and logs, and delete it.

This scenario uses two Lambda handlers:
_Note: Handlers don't use AWS SDK API calls._

The increment handler is straightforward:

1. It accepts a number, increments it, and returns the new value.
2. It performs simple logging of the result.

The arithmetic handler is more complex:
1. It accepts a set of actions ['plus', 'minus', 'times', 'divided-by'] and two
numbers, and returns the result of the calculation.
2. It uses an environment variable to control log level (such as DEBUG, INFO,
WARNING, ERROR).
It logs a few things at different levels, such as:
* DEBUG: Full event data.
```

- * INFO: The calculation result.
- * WARN~ING~: When a divide by zero error occurs.
- * This will be the typical `RUST_LOG` variable.

The steps of the scenario are:

1. Create an AWS Identity and Access Management (IAM) role that meets the following requirements:
 - * Has an `assume_role` policy that grants `'lambda.amazonaws.com'` the `'sts:AssumeRole'` action.
 - * Attaches the `'arn:aws:iam::aws:policy/service-role/AWSLambdaBasicExecutionRole'` managed role.
 - * `_You must wait for ~10 seconds after the role is created before you can use it!_`
2. Create a function (`CreateFunction`) for the increment handler by packaging it as a zip and doing one of the following:
 - * Adding it with `CreateFunction Code.ZipFile`.
 - * `--or--`
 - * Uploading it to Amazon Simple Storage Service (Amazon S3) and adding it with `CreateFunction Code.S3Bucket/S3Key`.
 - * `_Note: Zipping the file does not have to be done in code._`
 - * If you have a waiter, use it to wait until the function is active. Otherwise, call `GetFunction` until State is Active.
3. Invoke the function with a number and print the result.
4. Update the function (`UpdateFunctionCode`) to the arithmetic handler by packaging it as a zip and doing one of the following:
 - * Adding it with `UpdateFunctionCode ZipFile`.
 - * `--or--`
 - * Uploading it to Amazon S3 and adding it with `UpdateFunctionCode S3Bucket/S3Key`.
5. Call `GetFunction` until `Configuration.LastUpdateStatus` is `'Successful'` (or `'Failed'`).
6. Update the environment variable by calling `UpdateFunctionConfiguration` and pass it a log level, such as:
 - * `Environment={'Variables': {'RUST_LOG': 'TRACE'}}`
7. Invoke the function with an action from the list and a couple of values. Include `LogType='Tail'` to get logs in the result. Print the result of the calculation and the log.
8. [Optional] Invoke the function to provoke a divide-by-zero error and show the log result.
9. List all functions for the account, using pagination (`ListFunctions`).
10. Delete the function (`DeleteFunction`).
11. Delete the role.

Each step should use the function created in Service Actions to abstract calling the SDK.

```
*/

use aws_sdk_lambda::{operation::invoke::InvokeOutput, types::Environment};
use clap::Parser;
use std::{collections::HashMap, path::PathBuf};
use tracing::{debug, info, warn};
use tracing_subscriber::EnvFilter;

use lambda_code_examples::actions::{
    InvokeArgs::{Arithmetic, Increment},
    LambdaManager, Operation,
};

#[derive(Debug, Parser)]
pub struct Opt {
    /// The AWS Region.
    #[structopt(short, long)]
    pub region: Option<String>,

    // The bucket to use for the FunctionCode.
    #[structopt(short, long)]
    pub bucket: Option<String>,

    // The name of the Lambda function.
    #[structopt(short, long)]
    pub lambda_name: Option<String>,

    // The number to increment.
    #[structopt(short, long, default_value = "12")]
    pub inc: i32,

    // The left operand.
    #[structopt(long, default_value = "19")]
    pub num_a: i32,

    // The right operand.
    #[structopt(long, default_value = "23")]
    pub num_b: i32,

    // The arithmetic operation.
    #[structopt(short, long, default_value = "plus")]

```

```
pub operation: Operation,

#[structopt(long)]
pub cleanup: Option<bool>,

#[structopt(long)]
pub no_cleanup: Option<bool>,
}

fn code_path(lambda: &str) -> PathBuf {
    PathBuf::from(format!("../target/lambda/{lambda}/bootstrap.zip"))
}

fn log_invoke_output(invoker: &InvokeOutput, message: &str) {
    if let Some(payload) = invoker.payload().cloned() {
        let payload = String::from_utf8(payload.into_inner());
        info!(?payload, message);
    } else {
        info!("Could not extract payload")
    }
    if let Some(logs) = invoker.log_result() {
        debug!(?logs, "Invoked function logs")
    } else {
        debug!("Invoked function had no logs")
    }
}

async fn main_block(
    opt: &Opt,
    manager: &LambdaManager,
    code_location: String,
) -> Result<(), anyhow::Error> {
    let invoker = manager.invoke(Increment(opt.inc)).await?;
    log_invoke_output(&invoker, "Invoked function configured as increment");

    let update_code = manager
        .update_function_code(code_path("arithmetic"), code_location.clone())
        .await?;

    let code_sha256 = update_code.code_sha256().unwrap_or("Unknown SHA");
    info!(?code_sha256, "Updated function code with arithmetic.zip");

    let arithmetic_args = Arithmetic(opt.operation, opt.num_a, opt.num_b);
    let invoker = manager.invoke(arithmetic_args).await?;
```

```
log_invoke_output(&invoke, "Invoked function configured as arithmetic");

let update = manager
    .update_function_configuration(
        Environment::builder()
            .set_variables(Some(HashMap::from([(
                "RUST_LOG".to_string(),
                "trace".to_string(),
            ]))))
            .build(),
    )
    .await?;
let updated_environment = update.environment();
info!(?updated_environment, "Updated function configuration");

let invoke = manager
    .invoke(Arithmetic(opt.operation, opt.num_a, opt.num_b))
    .await?;
log_invoke_output(
    &invoke,
    "Invoked function configured as arithmetic with increased logging",
);

let invoke = manager
    .invoke(Arithmetic(Operation::DividedBy, opt.num_a, 0))
    .await?;
log_invoke_output(
    &invoke,
    "Invoked function configured as arithmetic with divide by zero",
);

Ok::<(), anyhow::Error>(( ))
}

#[tokio::main]
async fn main() {
    tracing_subscriber::fmt()
        .without_time()
        .with_file(true)
        .with_line_number(true)
        .with_env_filter(EnvFilter::from_default_env())
        .init();

    let opt = Opt::parse();
```



```
let manager = LambdaManager::load_from_env(opt.lambda_name.clone(),
opt.bucket.clone()).await;

let key = match manager.create_function(code_path("increment")).await {
    Ok(init) => {
        info!(?init, "Created function, initially with increment.zip");
        let run_block = main_block(&opt, &manager, init.clone()).await;
        info!(?run_block, "Finished running example, cleaning up");
        Some(init)
    }
    Err(err) => {
        warn!(?err, "Error happened when initializing function");
        None
    }
};

if Some(false) == opt.cleanup || Some(true) == opt.no_cleanup {
    info!("Skipping cleanup")
} else {
    let delete = manager.cleanup(key).await;
    info!(?delete, "Deleted function & cleaned up resources");
}
}
```

- For API details, see the following topics in *AWS SDK for Rust API reference*.
 - [CreateFunction](#)
 - [DeleteFunction](#)
 - [GetFunction](#)
 - [Invoke](#)
 - [ListFunctions](#)
 - [UpdateFunctionCode](#)
 - [UpdateFunctionConfiguration](#)

SAP ABAP

SDK for SAP ABAP

 **Note**

There's more on GitHub. Find the complete example and learn how to set up and run in the [AWS Code Examples Repository](#).

```

TRY.
    "Create an AWS Identity and Access Management (IAM) role that grants AWS
    Lambda permission to write to logs."
    DATA(lv_policy_document) = `{` &&
        `"Version": "2012-10-17",` &&
        ` "Statement": [` &&
            `{` &&
                `"Effect": "Allow",` &&
                `"Action": [` &&
                    `"sts:AssumeRole"` &&
                `],` &&
                `"Principal": {` &&
                    `"Service": [` &&
                        `"lambda.amazonaws.com"` &&
                    `]` &&
                `}` &&
            `}` &&
        `]` &&
    `}`.

TRY.
    DATA(lo_create_role_output) = lo_iam->createrole(
        iv_rolename = iv_role_name
        iv_assumerolepolicydocument = lv_policy_document
        iv_description = 'Grant lambda permission to write to logs'
    ).
    MESSAGE 'IAM role created.' TYPE 'I'.
    WAIT UP TO 10 SECONDS.          " Make sure that the IAM role is
ready for use. "
    CATCH /aws1/cx_iamentityalrddyexex.
        MESSAGE 'IAM role already exists.' TYPE 'E'.
    CATCH /aws1/cx_iaminvalidinputex.

```

```
        MESSAGE 'The request contains a non-valid parameter.' TYPE 'E'.
    CATCH /aws1/cx_iammalformedplydocex.
        MESSAGE 'Policy document in the request is malformed.' TYPE 'E'.
    ENDTRY.

    TRY.
        lo_iam->attachrolepolicy(
            iv_rolename = iv_role_name
            iv_policyarn = 'arn:aws:iam::aws:policy/service-role/
AWSLambdaBasicExecutionRole'
        ).
        MESSAGE 'Attached policy to the IAM role.' TYPE 'I'.
    CATCH /aws1/cx_iaminvalidinputex.
        MESSAGE 'The request contains a non-valid parameter.' TYPE 'E'.
    CATCH /aws1/cx_iamnosuchentityex.
        MESSAGE 'The requested resource entity does not exist.' TYPE 'E'.
    CATCH /aws1/cx_iamplynottattachableex.
        MESSAGE 'Service role policies can only be attached to the service-
linked role for their service.' TYPE 'E'.
    CATCH /aws1/cx_iamunmodableentityex.
        MESSAGE 'Service that depends on the service-linked role is not
modifiable.' TYPE 'E'.
    ENDTRY.

    " Create a Lambda function and upload handler code. "
    " Lambda function performs 'increment' action on a number. "
    TRY.
        lo_lmd->createfunction(
            iv_functionname = iv_function_name
            iv_runtime = `python3.9`
            iv_role = lo_create_role_output->get_role( )->get_arn( )
            iv_handler = iv_handler
            io_code = io_initial_zip_file
            iv_description = 'AWS Lambda code example'
        ).
        MESSAGE 'Lambda function created.' TYPE 'I'.
    CATCH /aws1/cx_lmdcodestorageexcdex.
        MESSAGE 'Maximum total code size per account exceeded.' TYPE 'E'.
    CATCH /aws1/cx_lmdinvparamvalueex.
        MESSAGE 'The request contains a non-valid parameter.' TYPE 'E'.
    CATCH /aws1/cx_lmdresourcenotfoundex.
        MESSAGE 'The requested resource does not exist.' TYPE 'E'.
    ENDTRY.
```

```

" Verify the function is in Active state "
WHILE lo_lmd->getfunction( iv_functionname = iv_function_name )-
>get_configuration( )->ask_state( ) <> 'Active'.
  IF sy-index = 10.
    EXIT.          " Maximum 10 seconds. "
  ENDIF.
  WAIT UP TO 1 SECONDS.
ENDWHILE.

"Invoke the function with a single parameter and get results."
TRY.
  DATA(lv_json) = /aws1/cl_rt_util=>string_to_xstring(
    `{` ` &&
      `"action": "increment",` ` &&
      `"number": 10` ` &&
    `}` `
  ).
  DATA(lo_initial_invoke_output) = lo_lmd->invoke(
    iv_functionname = iv_function_name
    iv_payload = lv_json
  ).
  ov_initial_invoke_payload = lo_initial_invoke_output->get_payload( ).
  " ov_initial_invoke_payload is returned for testing purposes. "
  DATA(lo_writer_json) = cl_sxml_string_writer=>create( type =
if_sxml=>co_xt_json ).
  CALL TRANSFORMATION id SOURCE XML ov_initial_invoke_payload RESULT
XML lo_writer_json.
  DATA(lv_result) = cl_abap_codepage=>convert_from( lo_writer_json-
>get_output( ) ).
  MESSAGE 'Lambda function invoked.' TYPE 'I'.
  CATCH /aws1/cx_lmdinvparamvalueex.
  MESSAGE 'The request contains a non-valid parameter.' TYPE 'E'.
  CATCH /aws1/cx_lmdinvrequestcontex.
  MESSAGE 'Unable to parse request body as JSON.' TYPE 'E'.
  CATCH /aws1/cx_lmdresourcenotfoundex.
  MESSAGE 'The requested resource does not exist.' TYPE 'E'.
  CATCH /aws1/cx_lmdunsuppedmediatyp00.
  MESSAGE 'Invoke request body does not have JSON as its content type.'
TYPE 'E'.
ENDTRY.

" Update the function code and configure its Lambda environment with an
environment variable. "
" Lambda function is updated to perform 'decrement' action also. "

```

```

    TRY.
        lo_lmd->updatefunctioncode(
            iv_functionname = iv_function_name
            iv_zipfile = io_updated_zip_file
        ).
        WAIT UP TO 10 SECONDS.           " Make sure that the update is
completed. "
        MESSAGE 'Lambda function code updated.' TYPE 'I'.
    CATCH /aws1/cx_lmdcodestorageexcdex.
        MESSAGE 'Maximum total code size per account exceeded.' TYPE 'E'.
    CATCH /aws1/cx_lmdinvparamvalueex.
        MESSAGE 'The request contains a non-valid parameter.' TYPE 'E'.
    CATCH /aws1/cx_lmdresourcenotfoundex.
        MESSAGE 'The requested resource does not exist.' TYPE 'E'.
    ENDTRY.

    TRY.
        DATA lt_variables TYPE /aws1/
cl_lmdenvironmentvaria00=>tt_environmentvariables.
        DATA ls_variable LIKE LINE OF lt_variables.
        ls_variable-key = 'LOG_LEVEL'.
        ls_variable-value = NEW /aws1/cl_lmdenvironmentvaria00( iv_value =
'info' ).
        INSERT ls_variable INTO TABLE lt_variables.

        lo_lmd->updatefunctionconfiguration(
            iv_functionname = iv_function_name
            io_environment = NEW /aws1/cl_lmdenvironment( it_variables =
lt_variables )
        ).
        WAIT UP TO 10 SECONDS.           " Make sure that the update is
completed. "
        MESSAGE 'Lambda function configuration/settings updated.' TYPE 'I'.
    CATCH /aws1/cx_lmdinvparamvalueex.
        MESSAGE 'The request contains a non-valid parameter.' TYPE 'E'.
    CATCH /aws1/cx_lmdresourceconflictex.
        MESSAGE 'Resource already exists or another operation is in
progress.' TYPE 'E'.
    CATCH /aws1/cx_lmdresourcenotfoundex.
        MESSAGE 'The requested resource does not exist.' TYPE 'E'.
    ENDTRY.

    "Invoke the function with new parameters and get results. Display the
execution log that's returned from the invocation."

```

```

TRY.
  lv_json = /aws1/cl_rt_util=>string_to_xstring(
    `{` &&
    ` "action": "decrement",` &&
    ` "number": 10` &&
    `}`
  ).
  DATA(lo_updated_invoke_output) = lo_lmd->invoke(
    iv_functionname = iv_function_name
    iv_payload = lv_json
  ).
  ov_updated_invoke_payload = lo_updated_invoke_output->get_payload( ).
  " ov_updated_invoke_payload is returned for testing purposes. "
  lo_writer_json = cl_sxml_string_writer=>create( type =
if_sxml=>co_xt_json ).
  CALL TRANSFORMATION id SOURCE XML ov_updated_invoke_payload RESULT
XML lo_writer_json.
  lv_result = cl_abap_codepage=>convert_from( lo_writer_json-
>get_output( ) ).
  MESSAGE 'Lambda function invoked.' TYPE 'I'.
CATCH /aws1/cx_lmdinvparamvalueex.
  MESSAGE 'The request contains a non-valid parameter.' TYPE 'E'.
CATCH /aws1/cx_lmdinvrequestcontex.
  MESSAGE 'Unable to parse request body as JSON.' TYPE 'E'.
CATCH /aws1/cx_lmdresourcenotfoundex.
  MESSAGE 'The requested resource does not exist.' TYPE 'E'.
CATCH /aws1/cx_lmdunsuppmediatyp00.
  MESSAGE 'Invoke request body does not have JSON as its content type.'
TYPE 'E'.
ENDTRY.

" List the functions for your account. "
TRY.
  DATA(lo_list_output) = lo_lmd->listfunctions( ).
  DATA(lt_functions) = lo_list_output->get_functions( ).
  MESSAGE 'Retrieved list of Lambda functions.' TYPE 'I'.
CATCH /aws1/cx_lmdinvparamvalueex.
  MESSAGE 'The request contains a non-valid parameter.' TYPE 'E'.
ENDTRY.

" Delete the Lambda function. "
TRY.
  lo_lmd->deletefunction( iv_functionname = iv_function_name ).
  MESSAGE 'Lambda function deleted.' TYPE 'I'.

```

```

    CATCH /aws1/cx_lmdinvparamvalueex.
      MESSAGE 'The request contains a non-valid parameter.' TYPE 'E'.
    CATCH /aws1/cx_lmdresourcenotfoundex.
      MESSAGE 'The requested resource does not exist.' TYPE 'E'.
  ENDTRY.

" Detach role policy. "
TRY.
  lo_iam->detachrolepolicy(
    iv_rolename = iv_role_name
    iv_policyarn = 'arn:aws:iam::aws:policy/service-role/
AWSLambdaBasicExecutionRole'
  ).
  MESSAGE 'Detached policy from the IAM role.' TYPE 'I'.
  CATCH /aws1/cx_iaminvalidinputex.
    MESSAGE 'The request contains a non-valid parameter.' TYPE 'E'.
  CATCH /aws1/cx_iamnosuchentityex.
    MESSAGE 'The requested resource entity does not exist.' TYPE 'E'.
  CATCH /aws1/cx_iamplynotattachableex.
    MESSAGE 'Service role policies can only be attached to the service-
linked role for their service.' TYPE 'E'.
  CATCH /aws1/cx_iamunmodableentityex.
    MESSAGE 'Service that depends on the service-linked role is not
modifiable.' TYPE 'E'.
  ENDTRY.

" Delete the IAM role. "
TRY.
  lo_iam->deleterole( iv_rolename = iv_role_name ).
  MESSAGE 'IAM role deleted.' TYPE 'I'.
  CATCH /aws1/cx_iamnosuchentityex.
    MESSAGE 'The requested resource entity does not exist.' TYPE 'E'.
  CATCH /aws1/cx_iamunmodableentityex.
    MESSAGE 'Service that depends on the service-linked role is not
modifiable.' TYPE 'E'.
  ENDTRY.

  CATCH /aws1/cx_rt_service_generic INTO lo_exception.
    DATA(lv_error) = lo_exception->get_longtext( ).
    MESSAGE lv_error TYPE 'E'.
  ENDTRY.

```

- For API details, see the following topics in *AWS SDK for SAP ABAP API reference*.

- [CreateFunction](#)
- [DeleteFunction](#)
- [GetFunction](#)
- [Invoke](#)
- [ListFunctions](#)
- [UpdateFunctionCode](#)
- [UpdateFunctionConfiguration](#)

For a complete list of AWS SDK developer guides and code examples, see [Using Lambda with an AWS SDK](#). This topic also includes information about getting started and details about previous SDK versions.

Actions for Lambda using AWS SDKs

The following code examples demonstrate how to perform individual Lambda actions with AWS SDKs. Each example includes a link to GitHub, where you can find instructions for setting up and running the code.

These excerpts call the Lambda API and are code excerpts from larger programs that must be run in context. You can see actions in context in [Scenarios for Lambda using AWS SDKs](#).

The following examples include only the most commonly used actions. For a complete list, see the [AWS Lambda API Reference](#).

Examples

- [Use CreateAlias with a CLI](#)
- [Use CreateFunction with an AWS SDK or CLI](#)
- [Use DeleteAlias with a CLI](#)
- [Use DeleteFunction with an AWS SDK or CLI](#)
- [Use DeleteFunctionConcurrency with a CLI](#)
- [Use DeleteProvisionedConcurrencyConfig with a CLI](#)
- [Use GetAccountSettings with a CLI](#)
- [Use GetAlias with a CLI](#)
- [Use GetFunction with an AWS SDK or CLI](#)
- [Use GetFunctionConcurrency with a CLI](#)

- [Use GetFunctionConfiguration with a CLI](#)
- [Use GetPolicy with a CLI](#)
- [Use GetProvisionedConcurrencyConfig with a CLI](#)
- [Use Invoke with an AWS SDK or CLI](#)
- [Use ListFunctions with an AWS SDK or CLI](#)
- [Use ListProvisionedConcurrencyConfigs with a CLI](#)
- [Use ListTags with a CLI](#)
- [Use ListVersionsByFunction with a CLI](#)
- [Use PublishVersion with a CLI](#)
- [Use PutFunctionConcurrency with a CLI](#)
- [Use PutProvisionedConcurrencyConfig with a CLI](#)
- [Use RemovePermission with a CLI](#)
- [Use TagResource with a CLI](#)
- [Use UntagResource with a CLI](#)
- [Use UpdateAlias with a CLI](#)
- [Use UpdateFunctionCode with an AWS SDK or CLI](#)
- [Use UpdateFunctionConfiguration with an AWS SDK or CLI](#)

Use CreateAlias with a CLI

The following code examples show how to use CreateAlias.

CLI

AWS CLI

To create an alias for a Lambda function

The following `create-alias` example creates an alias named `LIVE` that points to version 1 of the `my-function` Lambda function.

```
aws lambda create-alias \  
  --function-name my-function \  
  --description "alias for live version of function" \  
  --function-version 1 \  
  --name LIVE \  
  --target-version 1
```

```
--name LIVE
```

Output:

```
{
  "FunctionVersion": "1",
  "Name": "LIVE",
  "AliasArn": "arn:aws:lambda:us-west-2:123456789012:function:my-
function:LIVE",
  "RevisionId": "873282ed-4cd3-4dc8-a069-d0c647e470c6",
  "Description": "alias for live version of function"
}
```

For more information, see [Configuring AWS Lambda Function Aliases](#) in the *AWS Lambda Developer Guide*.

- For API details, see [CreateAlias](#) in *AWS CLI Command Reference*.

PowerShell

Tools for PowerShell

Example 1: This example creates a New Lambda Alias for specified version and routing configuration to specify the percentage of invocation requests that it receives.

```
New-LMAlias -FunctionName "MylambdaFunction123" -
RoutingConfig_AdditionalVersionWeight @{Name="1";Value="0.6"} -Description "Alias
for version 4" -FunctionVersion 4 -Name "PowershellAlias"
```

- For API details, see [CreateAlias](#) in *AWS Tools for PowerShell Cmdlet Reference*.

For a complete list of AWS SDK developer guides and code examples, see [Using Lambda with an AWS SDK](#). This topic also includes information about getting started and details about previous SDK versions.

Use CreateFunction with an AWS SDK or CLI

The following code examples show how to use CreateFunction.

Action examples are code excerpts from larger programs and must be run in context. You can see this action in context in the following code example:

- [Learn the basics](#)

.NET

AWS SDK for .NET

Note

There's more on GitHub. Find the complete example and learn how to set up and run in the [AWS Code Examples Repository](#).

```
/// <summary>
/// Creates a new Lambda function.
/// </summary>
/// <param name="functionName">The name of the function.</param>
/// <param name="s3Bucket">The Amazon Simple Storage Service (Amazon S3)
/// bucket where the zip file containing the code is located.</param>
/// <param name="s3Key">The Amazon S3 key of the zip file.</param>
/// <param name="role">The Amazon Resource Name (ARN) of a role with the
/// appropriate Lambda permissions.</param>
/// <param name="handler">The name of the handler function.</param>
/// <returns>The Amazon Resource Name (ARN) of the newly created
/// Lambda function.</returns>
public async Task<string> CreateLambdaFunctionAsync(
    string functionName,
    string s3Bucket,
    string s3Key,
    string role,
    string handler)
{
    // Defines the location for the function code.
    // S3Bucket - The S3 bucket where the file containing
    //           the source code is stored.
    // S3Key    - The name of the file containing the code.
    var functionCode = new FunctionCode
    {
        S3Bucket = s3Bucket,
        S3Key = s3Key,
    };

    var createFunctionRequest = new CreateFunctionRequest
```

```
    {
        FunctionName = functionName,
        Description = "Created by the Lambda .NET API",
        Code = functionCode,
        Handler = handler,
        Runtime = Runtime.Dotnet6,
        Role = role,
    };

    var reponse = await
_lambdaService.CreateFunctionAsync(createFunctionRequest);
    return reponse.FunctionArn;
}
```

- For API details, see [CreateFunction](#) in *AWS SDK for .NET API Reference*.

C++

SDK for C++

Note

There's more on GitHub. Find the complete example and learn how to set up and run in the [AWS Code Examples Repository](#).

```
Aws::Client::ClientConfiguration clientConfig;
// Optional: Set to the AWS Region in which the bucket was created
// (overrides config file).
// clientConfig.region = "us-east-1";

Aws::Lambda::LambdaClient client(clientConfig);

Aws::Lambda::Model::CreateFunctionRequest request;
request.SetFunctionName(LAMBDA_NAME);
request.SetDescription(LAMBDA_DESCRIPTION); // Optional.
#if USE_CPP_LAMBDA_FUNCTION
    request.SetRuntime(Aws::Lambda::Model::Runtime::provided_al2);
    request.SetTimeout(15);
    request.SetMemorySize(128);
```

```

        // Assume the AWS Lambda function was built in Docker with same
architecture
        // as this code.
#if defined(__x86_64__)
        request.SetArchitectures({Aws::Lambda::Model::Architecture::x86_64});
#elif defined(__aarch64__)
        request.SetArchitectures({Aws::Lambda::Model::Architecture::arm64});
#else
#error "Unimplemented architecture"
#endif // defined(architecture)
#else
        request.SetRuntime(Aws::Lambda::Model::Runtime::python3_9);
#endif

        request.SetRole(roleArn);
        request.SetHandler(LAMBDA_HANDLER_NAME);
        request.SetPublish(true);
        Aws::Lambda::Model::FunctionCode code;
        std::ifstream ifstream(INCREMENT_LAMBDA_CODE.c_str(),
                                std::ios_base::in | std::ios_base::binary);
        if (!ifstream.is_open()) {
            std::cerr << "Error opening file " << INCREMENT_LAMBDA_CODE << "." <<
std::endl;
}

#if USE_CPP_LAMBDA_FUNCTION
        std::cerr
            << "The cpp Lambda function must be built following the
instructions in the cpp_lambda/README.md file. "
            << std::endl;
#endif

        deleteIamRole(clientConfig);
        return false;
    }

    Aws::StringStream buffer;
    buffer << ifstream.rdbuf();

    code.SetZipFile(Aws::Utils::ByteBuffer((unsigned char *)
buffer.str().c_str(),
                                buffer.str().length()));

    request.SetCode(code);

    Aws::Lambda::Model::CreateFunctionOutcome outcome =
client.CreateFunction(

```

```
        request);

    if (outcome.IsSuccess()) {
        std::cout << "The lambda function was successfully created. " <<
seconds
                << " seconds elapsed." << std::endl;
        break;
    }

    else {
        std::cerr << "Error with CreateFunction. "
                << outcome.GetError().GetMessage()
                << std::endl;
        deleteIamRole(clientConfig);
        return false;
    }
}
```

- For API details, see [CreateFunction](#) in *AWS SDK for C++ API Reference*.

CLI

AWS CLI

To create a Lambda function

The following `create-function` example creates a Lambda function named `my-function`.

```
aws lambda create-function \
  --function-name my-function \
  --runtime nodejs18.x \
  --zip-file fileb://my-function.zip \
  --handler my-function.handler \
  --role arn:aws:iam::123456789012:role/service-role/MyTestFunction-role-tges6bf4
```

Contents of `my-function.zip`:

This file is a deployment package that contains your function code and any dependencies.

Output:

```
{
  "TracingConfig": {
    "Mode": "PassThrough"
  },
  "CodeSha256": "PFn4S+er27qk+UuZSTKEQfNKG/XNn7QJs90mJgq6oH8=",
  "FunctionName": "my-function",
  "CodeSize": 308,
  "RevisionId": "873282ed-4cd3-4dc8-a069-d0c647e470c6",
  "MemorySize": 128,
  "FunctionArn": "arn:aws:lambda:us-west-2:123456789012:function:my-function",
  "Version": "$LATEST",
  "Role": "arn:aws:iam::123456789012:role/service-role/MyTestFunction-role-zgur6bf4",
  "Timeout": 3,
  "LastModified": "2023-10-14T22:26:11.234+0000",
  "Handler": "my-function.handler",
  "Runtime": "nodejs18.x",
  "Description": ""
}
```

For more information, see [AWS Lambda Function Configuration](#) in the *AWS Lambda Developer Guide*.

- For API details, see [CreateFunction](#) in *AWS CLI Command Reference*.

Go

SDK for Go V2

Note

There's more on GitHub. Find the complete example and learn how to set up and run in the [AWS Code Examples Repository](#).

```
import (
    "bytes"
    "context"
    "encoding/json"
```

```
"errors"  
"log"  
"time"  
  
"github.com/aws/aws-sdk-go-v2/aws"  
"github.com/aws/aws-sdk-go-v2/service/lambda"  
"github.com/aws/aws-sdk-go-v2/service/lambda/types"  
)  
  
// FunctionWrapper encapsulates function actions used in the examples.  
// It contains an AWS Lambda service client that is used to perform user actions.  
type FunctionWrapper struct {  
    LambdaClient *lambda.Client  
}  
  
// CreateFunction creates a new Lambda function from code contained in the  
// zipPackage  
// buffer. The specified handlerName must match the name of the file and function  
// contained in the uploaded code. The role specified by iamRoleArn is assumed by  
// Lambda and grants specific permissions.  
// When the function already exists, types.StateActive is returned.  
// When the function is created, a lambda.FunctionActiveV2Waiter is used to wait  
// until the  
// function is active.  
func (wrapper FunctionWrapper) CreateFunction(ctx context.Context, functionName  
    string, handlerName string,  
    iamRoleArn *string, zipPackage *bytes.Buffer) types.State {  
    var state types.State  
    _, err := wrapper.LambdaClient.CreateFunction(ctx, &lambda.CreateFunctionInput{  
        Code:          &types.FunctionCode{ZipFile: zipPackage.Bytes()},  
        FunctionName:   aws.String(functionName),  
        Role:           iamRoleArn,  
        Handler:       aws.String(handlerName),  
        Publish:       true,  
        Runtime:       types.RuntimePython39,  
    })  
    if err != nil {  
        var resConflict *types.ResourceConflictException  
        if errors.As(err, &resConflict) {  
            log.Printf("Function %v already exists.\n", functionName)  
            state = types.StateActive  
        } else {
```



```

    log.Panicf("Couldn't create function %v. Here's why: %v\n", functionName, err)
}
} else {
    waiter := lambda.NewFunctionActiveV2Waiter(wrapper.LambdaClient)
    funcOutput, err := waiter.WaitForOutput(ctx, &lambda.GetFunctionInput{
        FunctionName: aws.String(functionName)}, 1*time.Minute)
    if err != nil {
        log.Panicf("Couldn't wait for function %v to be active. Here's why: %v\n",
functionName, err)
    } else {
        state = funcOutput.Configuration.State
    }
}
return state
}

```

- For API details, see [CreateFunction](#) in *AWS SDK for Go API Reference*.

Java

SDK for Java 2.x

Note

There's more on GitHub. Find the complete example and learn how to set up and run in the [AWS Code Examples Repository](#).

```

/**
 * Creates a new Lambda function in AWS using the AWS Lambda Java API.
 *
 * @param awsLambda    the AWS Lambda client used to interact with the AWS
Lambda service
 * @param functionName the name of the Lambda function to create
 * @param key          the S3 key of the function code
 * @param bucketName  the name of the S3 bucket containing the function code
 * @param role        the IAM role to assign to the Lambda function
 * @param handler      the fully qualified class name of the function handler
 * @return the Amazon Resource Name (ARN) of the created Lambda function
 */

```

```
public static String createLambdaFunction(LambdaClient awsLambda,
                                         String functionName,
                                         String key,
                                         String bucketName,
                                         String role,
                                         String handler) {

    try {
        LambdaWaiter waiter = awsLambda.waiter();
        FunctionCode code = FunctionCode.builder()
            .s3Key(key)
            .s3Bucket(bucketName)
            .build();

        CreateFunctionRequest functionRequest =
        CreateFunctionRequest.builder()
            .functionName(functionName)
            .description("Created by the Lambda Java API")
            .code(code)
            .handler(handler)
            .runtime(Runtime.JAVA17)
            .role(role)
            .build();

        // Create a Lambda function using a waiter
        CreateFunctionResponse functionResponse =
        awsLambda.createFunction(functionRequest);
        GetFunctionRequest getFunctionRequest = GetFunctionRequest.builder()
            .functionName(functionName)
            .build();
        WaiterResponse<GetFunctionResponse> waiterResponse =
        waiter.waitUntilFunctionExists(getFunctionRequest);
        waiterResponse.matched().response().ifPresent(System.out::println);
        return functionResponse.functionArn();

    } catch (LambdaException e) {
        System.err.println(e.getMessage());
        System.exit(1);
    }
    return "";
}
```

- For API details, see [CreateFunction](#) in *AWS SDK for Java 2.x API Reference*.

JavaScript

SDK for JavaScript (v3)

Note

There's more on GitHub. Find the complete example and learn how to set up and run in the [AWS Code Examples Repository](#).

```
const createFunction = async (funcName, roleArn) => {
  const client = new LambdaClient({});
  const code = await readFile(`${dirname}../functions/${funcName}.zip`);

  const command = new CreateFunctionCommand({
    Code: { ZipFile: code },
    FunctionName: funcName,
    Role: roleArn,
    Architectures: [Architecture.arm64],
    Handler: "index.handler", // Required when sending a .zip file
    PackageType: PackageType.Zip, // Required when sending a .zip file
    Runtime: Runtime.nodejs16x, // Required when sending a .zip file
  });

  return client.send(command);
};
```

- For API details, see [CreateFunction](#) in *AWS SDK for JavaScript API Reference*.

Kotlin

SDK for Kotlin

Note

There's more on GitHub. Find the complete example and learn how to set up and run in the [AWS Code Examples Repository](#).

```
suspend fun createNewFunction(
    myFunctionName: String,
    s3BucketName: String,
    myS3Key: String,
    myHandler: String,
    myRole: String,
): String? {
    val functionCode =
        FunctionCode {
            s3Bucket = s3BucketName
            s3Key = myS3Key
        }

    val request =
        CreateFunctionRequest {
            functionName = myFunctionName
            code = functionCode
            description = "Created by the Lambda Kotlin API"
            handler = myHandler
            role = myRole
            runtime = Runtime.Java8
        }

    LambdaClient { region = "us-west-2" }.use { awsLambda ->
        val functionResponse = awsLambda.createFunction(request)
        awsLambda.waitForFunctionActive {
            functionName = myFunctionName
        }
        return functionResponse.functionArn
    }
}
```

- For API details, see [CreateFunction](#) in *AWS SDK for Kotlin API reference*.

PHP

SDK for PHP

Note

There's more on GitHub. Find the complete example and learn how to set up and run in the [AWS Code Examples Repository](#).

```
public function createFunction($functionName, $role, $bucketName, $handler)
{
    //This assumes the Lambda function is in an S3 bucket.
    return $this->customWaiter(function () use ($functionName, $role,
$bucketName, $handler) {
        return $this->lambdaClient->createFunction([
            'Code' => [
                'S3Bucket' => $bucketName,
                'S3Key' => $functionName,
            ],
            'FunctionName' => $functionName,
            'Role' => $role['Arn'],
            'Runtime' => 'python3.9',
            'Handler' => "$handler.lambda_handler",
        ]);
    });
}
```

- For API details, see [CreateFunction](#) in *AWS SDK for PHP API Reference*.

PowerShell

Tools for PowerShell

Example 1: This example creates a new C# (dotnetcore1.0 runtime) function named **MyFunction** in AWS Lambda, providing the compiled binaries for the function from a zip file on the local file system (relative or absolute paths may be used). C# Lambda functions specify the handler for the function using the designation **AssemblyName::Namespace.ClassName::MethodName**. You should replace the assembly

name (without .dll suffix), namespace, class name and method name parts of the handler spec appropriately. The new function will have environment variables 'envvar1' and 'envvar2' set up from the provided values.

```
Publish-LMFunction -Description "My C# Lambda Function" `
  -FunctionName MyFunction `
  -ZipFilename .\MyFunctionBinaries.zip `
  -Handler "AssemblyName::Namespace.ClassName::MethodName" `
  -Role "arn:aws:iam::123456789012:role/LambdaFullExecRole" `
  -Runtime dotnetcore1.0 `
  -Environment_Variable @{ "envvar1"="value";"envvar2"="value" }
```

Output:

```
CodeSha256      : /NgBMd...gq71I=
CodeSize       : 214784
DeadLetterConfig :
Description    : My C# Lambda Function
Environment    : Amazon.Lambda.Model.EnvironmentResponse
FunctionArn    : arn:aws:lambda:us-west-2:123456789012:function:ToUpper
FunctionName   : MyFunction
Handler       : AssemblyName::Namespace.ClassName::MethodName
KMSKeyArn     :
LastModified   : 2016-12-29T23:50:14.207+0000
MemorySize    : 128
Role          : arn:aws:iam::123456789012:role/LambdaFullExecRole
Runtime       : dotnetcore1.0
Timeout       : 3
Version       : $LATEST
VpcConfig    :
```

Example 2: This example is similar to the previous one except the function binaries are first uploaded to an Amazon S3 bucket (which must be in the same region as the intended Lambda function) and the resulting S3 object is then referenced when creating the function.

```
Write-S3Object -BucketName amzn-s3-demo-bucket -Key MyFunctionBinaries.zip -
File .\MyFunctionBinaries.zip
Publish-LMFunction -Description "My C# Lambda Function" `
  -FunctionName MyFunction `
  -BucketName amzn-s3-demo-bucket `
```

```
-Key MyFunctionBinaries.zip `
-Handler "AssemblyName::Namespace.ClassName::MethodName" `
-Role "arn:aws:iam::123456789012:role/LambdaFullExecRole" `
-Runtime dotnetcore1.0 `
-Environment_Variable @{ "envvar1"="value";"envvar2"="value" }
```

- For API details, see [CreateFunction](#) in *AWS Tools for PowerShell Cmdlet Reference*.

Python

SDK for Python (Boto3)

Note

There's more on GitHub. Find the complete example and learn how to set up and run in the [AWS Code Examples Repository](#).

```
class LambdaWrapper:
    def __init__(self, lambda_client, iam_resource):
        self.lambda_client = lambda_client
        self.iam_resource = iam_resource

    def create_function(
        self, function_name, handler_name, iam_role, deployment_package
    ):
        """
        Deploys a Lambda function.

        :param function_name: The name of the Lambda function.
        :param handler_name: The fully qualified name of the handler function.
        This
                               must include the file name and the function name.
        :param iam_role: The IAM role to use for the function.
        :param deployment_package: The deployment package that contains the
        function
                               code in .zip format.
        :return: The Amazon Resource Name (ARN) of the newly created function.
        """
        try:
            response = self.lambda_client.create_function(
```

```

        FunctionName=function_name,
        Description="AWS Lambda doc example",
        Runtime="python3.9",
        Role=iam_role.arn,
        Handler=handler_name,
        Code={"ZipFile": deployment_package},
        Publish=True,
    )
    function_arn = response["FunctionArn"]
    waiter = self.lambda_client.get_waiter("function_active_v2")
    waiter.wait(FunctionName=function_name)
    logger.info(
        "Created function '%s' with ARN: '%s'."
        % function_name,
        response["FunctionArn"],
    )
except ClientError:
    logger.error("Couldn't create function %s.", function_name)
    raise
else:
    return function_arn

```

- For API details, see [CreateFunction](#) in *AWS SDK for Python (Boto3) API Reference*.

Ruby

SDK for Ruby

Note

There's more on GitHub. Find the complete example and learn how to set up and run in the [AWS Code Examples Repository](#).

```

class LambdaWrapper
  attr_accessor :lambda_client, :cloudwatch_client, :iam_client

  def initialize
    @lambda_client = Aws::Lambda::Client.new
    @cloudwatch_client = Aws::CloudWatchLogs::Client.new(region: 'us-east-1')
  end
end

```



```

    @iam_client = Aws::IAM::Client.new(region: 'us-east-1')
    @logger = Logger.new($stdout)
    @logger.level = Logger::WARN
end

# Deploys a Lambda function.
#
# @param function_name: The name of the Lambda function.
# @param handler_name: The fully qualified name of the handler function.
# @param role_arn: The IAM role to use for the function.
# @param deployment_package: The deployment package that contains the function
code in .zip format.
# @return: The Amazon Resource Name (ARN) of the newly created function.
def create_function(function_name, handler_name, role_arn, deployment_package)
  response = @lambda_client.create_function({
                                role: role_arn.to_s,
                                function_name: function_name,
                                handler: handler_name,
                                runtime: 'ruby2.7',
                                code: {
                                  zip_file: deployment_package
                                },
                                environment: {
                                  variables: {
                                    'LOG_LEVEL' => 'info'
                                  }
                                }
                              })

  @lambda_client.wait_until(:function_active_v2, { function_name:
function_name }) do |w|
    w.max_attempts = 5
    w.delay = 5
  end
  response
rescue Aws::Lambda::Errors::ServiceException => e
  @logger.error("There was an error creating #{function_name}:\n #{e.message}")
rescue Aws::Waiters::Errors::WaiterFailed => e
  @logger.error("Failed waiting for #{function_name} to activate:\n
#{e.message}")
end
end

```

- For API details, see [CreateFunction](#) in *AWS SDK for Ruby API Reference*.

Rust

SDK for Rust

 **Note**

There's more on GitHub. Find the complete example and learn how to set up and run in the [AWS Code Examples Repository](#).

```
/**
 * Create a function, uploading from a zip file.
 */
pub async fn create_function(&self, zip_file: PathBuf) -> Result<String,
anyhow::Error> {
    let code = self.prepare_function(zip_file, None).await?;

    let key = code.s3_key().unwrap().to_string();

    let role = self.create_role().await.map_err(|e| anyhow!(e))?;

    info!("Created iam role, waiting 15s for it to become active");
    tokio::time::sleep(Duration::from_secs(15)).await;

    info!("Creating lambda function {}", self.lambda_name);
    let _ = self
        .lambda_client
        .create_function()
        .function_name(self.lambda_name.clone())
        .code(code)
        .role(role.arn())
        .runtime(aws_sdk_lambda::types::Runtime::ProvidedAl2)
        .handler("_unused")
        .send()
        .await
        .map_err(anyhow::Error::from)?;

    self.wait_for_function_ready().await?;

    self.lambda_client
        .publish_version()
        .function_name(self.lambda_name.clone())
```

```
        .send()
        .await?;

    Ok(key)
}

/**
 * Upload function code from a path to a zip file.
 * The zip file must have an AL2 Linux-compatible binary called `bootstrap`.
 * The easiest way to create such a zip is to use `cargo lambda build --
output-format Zip`.
 */
async fn prepare_function(
    &self,
    zip_file: PathBuf,
    key: Option<String>,
) -> Result<FunctionCode, anyhow::Error> {
    let body = ByteStream::from_path(zip_file).await?;

    let key = key.unwrap_or_else(|| format!("{}_code", self.lambda_name));

    info!("Uploading function code to s3://{}/{}", self.bucket, key);
    let _ = self
        .s3_client
        .put_object()
        .bucket(self.bucket.clone())
        .key(key.clone())
        .body(body)
        .send()
        .await?;

    Ok(FunctionCode::builder()
        .s3_bucket(self.bucket.clone())
        .s3_key(key)
        .build())
}
```

- For API details, see [CreateFunction](#) in *AWS SDK for Rust API reference*.

SAP ABAP

SDK for SAP ABAP

 **Note**

There's more on GitHub. Find the complete example and learn how to set up and run in the [AWS Code Examples Repository](#).

```
TRY.
  lo_lmd->createfunction(
    iv_functionname = iv_function_name
    iv_runtime = `python3.9`
    iv_role = iv_role_arn
    iv_handler = iv_handler
    io_code = io_zip_file
    iv_description = 'AWS Lambda code example'
  ).
  MESSAGE 'Lambda function created.' TYPE 'I'.
CATCH /aws1/cx_lmdcodesigningcfn00.
  MESSAGE 'Code signing configuration does not exist.' TYPE 'E'.
CATCH /aws1/cx_lmdcodestorageexc00.
  MESSAGE 'Maximum total code size per account exceeded.' TYPE 'E'.
CATCH /aws1/cx_lmdcodeverification00.
  MESSAGE 'Code signature failed one or more validation checks for
signature mismatch or expiration.' TYPE 'E'.
CATCH /aws1/cx_lmdinvalidcodesigex.
  MESSAGE 'Code signature failed the integrity check.' TYPE 'E'.
CATCH /aws1/cx_lmdinvparamvalueex.
  MESSAGE 'The request contains a non-valid parameter.' TYPE 'E'.
CATCH /aws1/cx_lmdresourceconflictex.
  MESSAGE 'Resource already exists or another operation is in progress.'
TYPE 'E'.
CATCH /aws1/cx_lmdresourcenotfoundex.
  MESSAGE 'The requested resource does not exist.' TYPE 'E'.
CATCH /aws1/cx_lmdserviceexception.
  MESSAGE 'An internal problem was encountered by the AWS Lambda service.'
TYPE 'E'.
CATCH /aws1/cx_lmdtoomanyrequestsex.
  MESSAGE 'The maximum request throughput was reached.' TYPE 'E'.
ENDTRY.
```

- For API details, see [CreateFunction](#) in *AWS SDK for SAP ABAP API reference*.

For a complete list of AWS SDK developer guides and code examples, see [Using Lambda with an AWS SDK](#). This topic also includes information about getting started and details about previous SDK versions.

Use DeleteAlias with a CLI

The following code examples show how to use DeleteAlias.

CLI

AWS CLI

To delete an alias of a Lambda function

The following delete-alias example deletes the alias named LIVE from the my-function Lambda function.

```
aws lambda delete-alias \  
  --function-name my-function \  
  --name LIVE
```

This command produces no output.

For more information, see [Configuring AWS Lambda Function Aliases](#) in the *AWS Lambda Developer Guide*.

- For API details, see [DeleteAlias](#) in *AWS CLI Command Reference*.

PowerShell

Tools for PowerShell

Example 1: This example deletes the Lambda function Alias mentioned in the command.

```
Remove-LMAlias -FunctionName "MyLambdaFunction123" -Name "NewAlias"
```

- For API details, see [DeleteAlias](#) in *AWS Tools for PowerShell Cmdlet Reference*.

For a complete list of AWS SDK developer guides and code examples, see [Using Lambda with an AWS SDK](#). This topic also includes information about getting started and details about previous SDK versions.

Use DeleteFunction with an AWS SDK or CLI

The following code examples show how to use DeleteFunction.

Action examples are code excerpts from larger programs and must be run in context. You can see this action in context in the following code example:

- [Learn the basics](#)

.NET

AWS SDK for .NET

Note

There's more on GitHub. Find the complete example and learn how to set up and run in the [AWS Code Examples Repository](#).

```
/// <summary>
/// Delete an AWS Lambda function.
/// </summary>
/// <param name="functionName">The name of the Lambda function to
/// delete.</param>
/// <returns>A Boolean value that indicates the success of the action.</
returns>
public async Task<bool> DeleteFunctionAsync(string functionName)
{
    var request = new DeleteFunctionRequest
    {
        FunctionName = functionName,
    };

    var response = await _lambdaService.DeleteFunctionAsync(request);
```

```
// A return value of NoContent means that the request was processed.  
// In this case, the function was deleted, and the return value  
// is intentionally blank.  
return response.HttpStatusCode == System.Net.HttpStatusCode.NoContent;  
}
```

- For API details, see [DeleteFunction](#) in *AWS SDK for .NET API Reference*.

C++

SDK for C++

Note

There's more on GitHub. Find the complete example and learn how to set up and run in the [AWS Code Examples Repository](#).

```
Aws::Client::ClientConfiguration clientConfig;  
// Optional: Set to the AWS Region in which the bucket was created  
(overrides config file).  
// clientConfig.region = "us-east-1";  
  
Aws::Lambda::LambdaClient client(clientConfig);  
  
Aws::Lambda::Model::DeleteFunctionRequest request;  
request.SetFunctionName(LAMBDA_NAME);  
  
Aws::Lambda::Model::DeleteFunctionOutcome outcome = client.DeleteFunction(  
    request);  
  
if (outcome.IsSuccess()) {  
    std::cout << "The lambda function was successfully deleted." <<  
std::endl;  
}  
else {  
    std::cerr << "Error with Lambda::DeleteFunction. "  
        << outcome.GetError().GetMessage()  
        << std::endl;
```

```
}
```

- For API details, see [DeleteFunction](#) in *AWS SDK for C++ API Reference*.

CLI

AWS CLI

Example 1: To delete a Lambda function by function name

The following `delete-function` example deletes the Lambda function named `my-function` by specifying the function's name.

```
aws lambda delete-function \  
  --function-name my-function
```

This command produces no output.

Example 2: To delete a Lambda function by function ARN

The following `delete-function` example deletes the Lambda function named `my-function` by specifying the function's ARN.

```
aws lambda delete-function \  
  --function-name arn:aws:lambda:us-west-2:123456789012:function:my-function
```

This command produces no output.

Example 3: To delete a Lambda function by partial function ARN

The following `delete-function` example deletes the Lambda function named `my-function` by specifying the function's partial ARN.

```
aws lambda delete-function \  
  --function-name 123456789012:function:my-function
```

This command produces no output.

For more information, see [AWS Lambda Function Configuration](#) in the *AWS Lambda Developer Guide*.

- For API details, see [DeleteFunction](#) in *AWS CLI Command Reference*.

Go

SDK for Go V2

Note

There's more on GitHub. Find the complete example and learn how to set up and run in the [AWS Code Examples Repository](#).

```
import (  
    "bytes"  
    "context"  
    "encoding/json"  
    "errors"  
    "log"  
    "time"  
  
    "github.com/aws/aws-sdk-go-v2/aws"  
    "github.com/aws/aws-sdk-go-v2/service/lambda"  
    "github.com/aws/aws-sdk-go-v2/service/lambda/types"  
)  
  
// FunctionWrapper encapsulates function actions used in the examples.  
// It contains an AWS Lambda service client that is used to perform user actions.  
type FunctionWrapper struct {  
    LambdaClient *lambda.Client  
}  
  
// DeleteFunction deletes the Lambda function specified by functionName.  
func (wrapper FunctionWrapper) DeleteFunction(ctx context.Context, functionName  
    string) {  
    _, err := wrapper.LambdaClient.DeleteFunction(ctx, &lambda.DeleteFunctionInput{  
        FunctionName: aws.String(functionName),  
    })  
    if err != nil {  
        log.Panicf("Couldn't delete function %v. Here's why: %v\n", functionName, err)
```

```
}  
}
```

- For API details, see [DeleteFunction](#) in *AWS SDK for Go API Reference*.

Java

SDK for Java 2.x

Note

There's more on GitHub. Find the complete example and learn how to set up and run in the [AWS Code Examples Repository](#).

```
/**  
 * Deletes an AWS Lambda function.  
 *  
 * @param awsLambda an instance of the {@link LambdaClient} class, which  
 is used to interact with the AWS Lambda service  
 * @param functionName the name of the Lambda function to be deleted  
 *  
 * @throws LambdaException if an error occurs while deleting the Lambda  
 function  
 */  
public static void deleteLambdaFunction(LambdaClient awsLambda, String  
functionName) {  
    try {  
        DeleteFunctionRequest request = DeleteFunctionRequest.builder()  
            .functionName(functionName)  
            .build();  
  
        awsLambda.deleteFunction(request);  
        System.out.println("The " + functionName + " function was deleted");  
  
    } catch (LambdaException e) {  
        System.err.println(e.getMessage());  
        System.exit(1);  
    }  
}
```

- For API details, see [DeleteFunction](#) in *AWS SDK for Java 2.x API Reference*.

JavaScript

SDK for JavaScript (v3)

Note

There's more on GitHub. Find the complete example and learn how to set up and run in the [AWS Code Examples Repository](#).

```
/**
 * @param {string} funcName
 */
const deleteFunction = (funcName) => {
  const client = new LambdaClient({});
  const command = new DeleteFunctionCommand({ FunctionName: funcName });
  return client.send(command);
};
```

- For API details, see [DeleteFunction](#) in *AWS SDK for JavaScript API Reference*.

Kotlin

SDK for Kotlin

Note

There's more on GitHub. Find the complete example and learn how to set up and run in the [AWS Code Examples Repository](#).

```
suspend fun delLambdaFunction(myFunctionName: String) {
    val request =
        DeleteFunctionRequest {
```

```
        functionName = myFunctionName
    }

    LambdaClient { region = "us-west-2" }.use { awsLambda ->
        awsLambda.deleteFunction(request)
        println("$myFunctionName was deleted")
    }
}
```

- For API details, see [DeleteFunction](#) in *AWS SDK for Kotlin API reference*.

PHP

SDK for PHP

Note

There's more on GitHub. Find the complete example and learn how to set up and run in the [AWS Code Examples Repository](#).

```
public function deleteFunction($functionName)
{
    return $this->lambdaClient->deleteFunction([
        'FunctionName' => $functionName,
    ]);
}
```

- For API details, see [DeleteFunction](#) in *AWS SDK for PHP API Reference*.

PowerShell

Tools for PowerShell

Example 1: This example deletes a specific version of a Lambda function

```
Remove-LMFunction -FunctionName "MylambdaFunction123" -Qualifier '3'
```

- For API details, see [DeleteFunction](#) in *AWS Tools for PowerShell Cmdlet Reference*.

Python

SDK for Python (Boto3)

Note

There's more on GitHub. Find the complete example and learn how to set up and run in the [AWS Code Examples Repository](#).

```
class LambdaWrapper:
    def __init__(self, lambda_client, iam_resource):
        self.lambda_client = lambda_client
        self.iam_resource = iam_resource

    def delete_function(self, function_name):
        """
        Deletes a Lambda function.

        :param function_name: The name of the function to delete.
        """
        try:
            self.lambda_client.delete_function(FunctionName=function_name)
        except ClientError:
            logger.exception("Couldn't delete function %s.", function_name)
            raise
```

- For API details, see [DeleteFunction](#) in *AWS SDK for Python (Boto3) API Reference*.

Ruby

SDK for Ruby

Note

There's more on GitHub. Find the complete example and learn how to set up and run in the [AWS Code Examples Repository](#).

```
class LambdaWrapper
  attr_accessor :lambda_client, :cloudwatch_client, :iam_client

  def initialize
    @lambda_client = Aws::Lambda::Client.new
    @cloudwatch_client = Aws::CloudWatchLogs::Client.new(region: 'us-east-1')
    @iam_client = Aws::IAM::Client.new(region: 'us-east-1')
    @logger = Logger.new($stdout)
    @logger.level = Logger::WARN
  end

  # Deletes a Lambda function.
  # @param function_name: The name of the function to delete.
  def delete_function(function_name)
    print "Deleting function: #{function_name}..."
    @lambda_client.delete_function(
      function_name: function_name
    )
    print 'Done!'.green
  rescue Aws::Lambda::Errors::ServiceException => e
    @logger.error("There was an error deleting #{function_name}:\n #{e.message}")
  end
end
```

- For API details, see [DeleteFunction](#) in *AWS SDK for Ruby API Reference*.

Rust

SDK for Rust

 **Note**

There's more on GitHub. Find the complete example and learn how to set up and run in the [AWS Code Examples Repository](#).

```
/** Delete a function and its role, and if possible or necessary, its
associated code object and bucket. */
pub async fn delete_function(
    &self,
    location: Option<String>,
) -> (
    Result<DeleteFunctionOutput, anyhow::Error>,
    Result<DeleteRoleOutput, anyhow::Error>,
    Option<Result<DeleteObjectOutput, anyhow::Error>>,
) {
    info!("Deleting lambda function {}", self.lambda_name);
    let delete_function = self
        .lambda_client
        .delete_function()
        .function_name(self.lambda_name.clone())
        .send()
        .await
        .map_err(anyhow::Error::from);

    info!("Deleting iam role {}", self.role_name);
    let delete_role = self
        .iam_client
        .delete_role()
        .role_name(self.role_name.clone())
        .send()
        .await
        .map_err(anyhow::Error::from);

    let delete_object: Option<Result<DeleteObjectOutput, anyhow::Error>> =
        if let Some(location) = location {
            info!("Deleting object {location}");
            Some(
```

```

        self.s3_client
            .delete_object()
            .bucket(self.bucket.clone())
            .key(location)
            .send()
            .await
            .map_err(anyhow::Error::from),
    )
} else {
    info!(?location, "Skipping delete object");
    None
};

(delete_function, delete_role, delete_object)
}

```

- For API details, see [DeleteFunction](#) in *AWS SDK for Rust API reference*.

SAP ABAP

SDK for SAP ABAP

Note

There's more on GitHub. Find the complete example and learn how to set up and run in the [AWS Code Examples Repository](#).

```

TRY.
    lo_lmd->deletefunction( iv_functionname = iv_function_name ).
    MESSAGE 'Lambda function deleted.' TYPE 'I'.
CATCH /aws1/cx_lmdinvparamvalueex.
    MESSAGE 'The request contains a non-valid parameter.' TYPE 'E'.
CATCH /aws1/cx_lmdresourceconflictex.
    MESSAGE 'Resource already exists or another operation is in progress.'
TYPE 'E'.
CATCH /aws1/cx_lmdresourcenotfoundex.
    MESSAGE 'The requested resource does not exist.' TYPE 'E'.
CATCH /aws1/cx_lmdserviceexception.
    MESSAGE 'An internal problem was encountered by the AWS Lambda service.'
TYPE 'E'.

```



```
CATCH /aws1/cx_lmdtoomanyrequestsex.  
    MESSAGE 'The maximum request throughput was reached.' TYPE 'E'.  
ENDTRY.
```

- For API details, see [DeleteFunction](#) in *AWS SDK for SAP ABAP API reference*.

For a complete list of AWS SDK developer guides and code examples, see [Using Lambda with an AWS SDK](#). This topic also includes information about getting started and details about previous SDK versions.

Use DeleteFunctionConcurrency with a CLI

The following code examples show how to use DeleteFunctionConcurrency.

CLI

AWS CLI

To remove the reserved concurrent execution limit from a function

The following delete-function-concurrency example deletes the reserved concurrent execution limit from the my-function function.

```
aws lambda delete-function-concurrency \  
    --function-name my-function
```

This command produces no output.

For more information, see [Reserving Concurrency for a Lambda Function](#) in the *AWS Lambda Developer Guide*.

- For API details, see [DeleteFunctionConcurrency](#) in *AWS CLI Command Reference*.

PowerShell

Tools for PowerShell

Example 1: This examples removes the Function Concurrency of the Lambda Function.

```
Remove-LMFunctionConcurrency -FunctionName "MyLambdaFunction123"
```

- For API details, see [DeleteFunctionConcurrency](#) in *AWS Tools for PowerShell Cmdlet Reference*.

For a complete list of AWS SDK developer guides and code examples, see [Using Lambda with an AWS SDK](#). This topic also includes information about getting started and details about previous SDK versions.

Use DeleteProvisionedConcurrencyConfig with a CLI

The following code examples show how to use DeleteProvisionedConcurrencyConfig.

CLI

AWS CLI

To delete a provisioned concurrency configuration

The following delete-provisioned-concurrency-config example deletes the provisioned concurrency configuration for the GREEN alias of the specified function.

```
aws lambda delete-provisioned-concurrency-config \  
  --function-name my-function \  
  --qualifier GREEN
```

- For API details, see [DeleteProvisionedConcurrencyConfig](#) in *AWS CLI Command Reference*.

PowerShell

Tools for PowerShell

Example 1: This example removes the Provisioned Concurrency Configuration for a specific Alias.

```
Remove-LMProvisionedConcurrencyConfig -FunctionName "MyLambdaFunction123" -  
Qualifier "NewAlias1"
```

- For API details, see [DeleteProvisionedConcurrencyConfig](#) in *AWS Tools for PowerShell Cmdlet Reference*.

For a complete list of AWS SDK developer guides and code examples, see [Using Lambda with an AWS SDK](#). This topic also includes information about getting started and details about previous SDK versions.

Use `GetAccountSettings` with a CLI

The following code examples show how to use `GetAccountSettings`.

CLI

AWS CLI

To retrieve details about your account in an AWS Region

The following `get-account-settings` example displays the Lambda limits and usage information for your account.

```
aws lambda get-account-settings
```

Output:

```
{
  "AccountLimit": {
    "CodeSizeUnzipped": 262144000,
    "UnreservedConcurrentExecutions": 1000,
    "ConcurrentExecutions": 1000,
    "CodeSizeZipped": 52428800,
    "TotalCodeSize": 80530636800
  },
  "AccountUsage": {
    "FunctionCount": 4,
    "TotalCodeSize": 9426
  }
}
```

For more information, see [AWS Lambda Limits](#) in the *AWS Lambda Developer Guide*.

- For API details, see [GetAccountSettings](#) in *AWS CLI Command Reference*.

PowerShell

Tools for PowerShell

Example 1: This sample displays to compare the Account Limit and Account Usage

```
Get-LMAccountSetting | Select-Object
  @{Name="TotalCodeSizeLimit";Expression={$_.AccountLimit.TotalCodeSize}},
  @{Name="TotalCodeSizeUsed";Expression={$_.AccountUsage.TotalCodeSize}}
```

Output:

```
TotalCodeSizeLimit TotalCodeSizeUsed
-----
          80530636800          15078795
```

- For API details, see [GetAccountSettings](#) in *AWS Tools for PowerShell Cmdlet Reference*.

For a complete list of AWS SDK developer guides and code examples, see [Using Lambda with an AWS SDK](#). This topic also includes information about getting started and details about previous SDK versions.

Use GetAlias with a CLI

The following code examples show how to use GetAlias.

CLI

AWS CLI

To retrieve details about a function alias

The following `get-alias` example displays details for the alias named `LIVE` on the `my-function` Lambda function.

```
aws lambda get-alias \
  --function-name my-function \
  --name LIVE
```

Output:

```
{
  "FunctionVersion": "3",
  "Name": "LIVE",
  "AliasArn": "arn:aws:lambda:us-west-2:123456789012:function:my-
function:LIVE",
  "RevisionId": "594f41fb-b85f-4c20-95c7-6ca5f2a92c93",
  "Description": "alias for live version of function"
}
```

For more information, see [Configuring AWS Lambda Function Aliases](#) in the *AWS Lambda Developer Guide*.

- For API details, see [GetAlias](#) in *AWS CLI Command Reference*.

PowerShell

Tools for PowerShell

Example 1: This example retrieves the Routing Config weights for a specific Lambda Function Alias.

```
Get-LMAlias -FunctionName "MylambdaFunction123" -Name "newlabel1" -Select
RoutingConfig
```

Output:

```
AdditionalVersionWeights
-----
{[1, 0.6]}
```

- For API details, see [GetAlias](#) in *AWS Tools for PowerShell Cmdlet Reference*.

For a complete list of AWS SDK developer guides and code examples, see [Using Lambda with an AWS SDK](#). This topic also includes information about getting started and details about previous SDK versions.

Use GetFunction with an AWS SDK or CLI

The following code examples show how to use `GetFunction`.

Action examples are code excerpts from larger programs and must be run in context. You can see this action in context in the following code example:

- [Learn the basics](#)

.NET

AWS SDK for .NET

Note

There's more on GitHub. Find the complete example and learn how to set up and run in the [AWS Code Examples Repository](#).

```
/// <summary>
/// Gets information about a Lambda function.
/// </summary>
/// <param name="functionName">The name of the Lambda function for
/// which to retrieve information.</param>
/// <returns>Async Task.</returns>
public async Task<FunctionConfiguration> GetFunctionAsync(string
functionName)
{
    var functionRequest = new GetFunctionRequest
    {
        FunctionName = functionName,
    };

    var response = await _lambdaService.GetFunctionAsync(functionRequest);
    return response.Configuration;
}
```

- For API details, see [GetFunction](#) in *AWS SDK for .NET API Reference*.

C++

SDK for C++

 **Note**

There's more on GitHub. Find the complete example and learn how to set up and run in the [AWS Code Examples Repository](#).

```
Aws::Client::ClientConfiguration clientConfig;
// Optional: Set to the AWS Region in which the bucket was created
(overrides config file).
// clientConfig.region = "us-east-1";

Aws::Lambda::LambdaClient client(clientConfig);

Aws::Lambda::Model::GetFunctionRequest request;
request.SetFunctionName(functionName);

Aws::Lambda::Model::GetFunctionOutcome outcome =
client.GetFunction(request);

if (outcome.IsSuccess()) {
    std::cout << "Function retrieve.\n" <<
outcome.GetResult().GetConfiguration().Jsonize().View().WriteReadable()
    << std::endl;
}
else {
    std::cerr << "Error with Lambda::GetFunction. "
    << outcome.GetError().GetMessage()
    << std::endl;
}
```

- For API details, see [GetFunction](#) in *AWS SDK for C++ API Reference*.

CLI

AWS CLI

To retrieve information about a function

The following `get-function` example displays information about the `my-function` function.

```
aws lambda get-function \  
  --function-name my-function
```

Output:

```
{  
  "Concurrency": {  
    "ReservedConcurrentExecutions": 100  
  },  
  "Code": {  
    "RepositoryType": "S3",  
    "Location": "https://awslambda-us-west-2-tasks.s3.us-  
west-2.amazonaws.com/snapshots/123456789012/my-function..."  
  },  
  "Configuration": {  
    "TracingConfig": {  
      "Mode": "PassThrough"  
    },  
    "Version": "$LATEST",  
    "CodeSha256": "5tT2qgzYUHoqwR616pZ2dpkn/0J1FrzJmlKidWaaCgk=",  
    "FunctionName": "my-function",  
    "VpcConfig": {  
      "SubnetIds": [],  
      "VpcId": "",  
      "SecurityGroupIds": []  
    },  
    "MemorySize": 128,  
    "RevisionId": "28f0fb31-5c5c-43d3-8955-03e76c5c1075",  
    "CodeSize": 304,  
    "FunctionArn": "arn:aws:lambda:us-west-2:123456789012:function:my-  
function",  
    "Handler": "index.handler",  
    "Role": "arn:aws:iam::123456789012:role/service-role/helloWorldPython-  
role-uy3l9yq",
```



```
        "Timeout": 3,
        "LastModified": "2019-09-24T18:20:35.054+0000",
        "Runtime": "nodejs10.x",
        "Description": ""
    }
}
```

For more information, see [AWS Lambda Function Configuration](#) in the *AWS Lambda Developer Guide*.

- For API details, see [GetFunction](#) in *AWS CLI Command Reference*.

Go

SDK for Go V2

Note

There's more on GitHub. Find the complete example and learn how to set up and run in the [AWS Code Examples Repository](#).

```
import (
    "bytes"
    "context"
    "encoding/json"
    "errors"
    "log"
    "time"

    "github.com/aws/aws-sdk-go-v2/aws"
    "github.com/aws/aws-sdk-go-v2/service/lambda"
    "github.com/aws/aws-sdk-go-v2/service/lambda/types"
)

// FunctionWrapper encapsulates function actions used in the examples.
// It contains an AWS Lambda service client that is used to perform user actions.
type FunctionWrapper struct {
    LambdaClient *lambda.Client
}
```

```
// GetFunction gets data about the Lambda function specified by functionName.
func (wrapper FunctionWrapper) GetFunction(ctx context.Context, functionName
string) types.State {
    var state types.State
    funcOutput, err := wrapper.LambdaClient.GetFunction(ctx,
    &lambda.GetFunctionInput{
        FunctionName: aws.String(functionName),
    })
    if err != nil {
        log.Panicf("Couldn't get function %v. Here's why: %v\n", functionName, err)
    } else {
        state = funcOutput.Configuration.State
    }
    return state
}
```

- For API details, see [GetFunction](#) in *AWS SDK for Go API Reference*.

Java

SDK for Java 2.x

Note

There's more on GitHub. Find the complete example and learn how to set up and run in the [AWS Code Examples Repository](#).

```
/**
 * Retrieves information about an AWS Lambda function.
 *
 * @param awsLambda an instance of the {@link LambdaClient} class, which
is used to interact with the AWS Lambda service
 * @param functionName the name of the AWS Lambda function to retrieve
information about
 */
public static void getFunction(LambdaClient awsLambda, String functionName) {
    try {
```

```
        GetFunctionRequest functionRequest = GetFunctionRequest.builder()
            .functionName(functionName)
            .build();

        GetFunctionResponse response =
awsLambda.getFunction(functionRequest);
        System.out.println("The runtime of this Lambda function is " +
response.configuration().runtime());

    } catch (LambdaException e) {
        System.err.println(e.getMessage());
        System.exit(1);
    }
}
```

- For API details, see [GetFunction](#) in *AWS SDK for Java 2.x API Reference*.

JavaScript

SDK for JavaScript (v3)

Note

There's more on GitHub. Find the complete example and learn how to set up and run in the [AWS Code Examples Repository](#).

```
const getFunction = (funcName) => {
    const client = new LambdaClient({});
    const command = new GetFunctionCommand({ FunctionName: funcName });
    return client.send(command);
};
```

- For API details, see [GetFunction](#) in *AWS SDK for JavaScript API Reference*.

PHP

SDK for PHP

Note

There's more on GitHub. Find the complete example and learn how to set up and run in the [AWS Code Examples Repository](#).

```
public function getFunction($functionName)
{
    return $this->lambdaClient->getFunction([
        'FunctionName' => $functionName,
    ]);
}
```

- For API details, see [GetFunction](#) in *AWS SDK for PHP API Reference*.

Python

SDK for Python (Boto3)

Note

There's more on GitHub. Find the complete example and learn how to set up and run in the [AWS Code Examples Repository](#).

```
class LambdaWrapper:
    def __init__(self, lambda_client, iam_resource):
        self.lambda_client = lambda_client
        self.iam_resource = iam_resource

    def get_function(self, function_name):
        """
        Gets data about a Lambda function.
```

```

        :param function_name: The name of the function.
        :return: The function data.
        """
        response = None
        try:
            response =
self.lambda_client.get_function(FunctionName=function_name)
        except ClientError as err:
            if err.response["Error"]["Code"] == "ResourceNotFoundException":
                logger.info("Function %s does not exist.", function_name)
            else:
                logger.error(
                    "Couldn't get function %s. Here's why: %s: %s",
                    function_name,
                    err.response["Error"]["Code"],
                    err.response["Error"]["Message"],
                )
                raise
        return response

```

- For API details, see [GetFunction](#) in *AWS SDK for Python (Boto3) API Reference*.

Ruby

SDK for Ruby

Note

There's more on GitHub. Find the complete example and learn how to set up and run in the [AWS Code Examples Repository](#).

```

class LambdaWrapper
  attr_accessor :lambda_client, :cloudwatch_client, :iam_client

  def initialize
    @lambda_client = Aws::Lambda::Client.new
    @cloudwatch_client = Aws::CloudWatchLogs::Client.new(region: 'us-east-1')
    @iam_client = Aws::IAM::Client.new(region: 'us-east-1')
    @logger = Logger.new($stdout)

```

```

    @logger.level = Logger::WARN
  end

  # Gets data about a Lambda function.
  #
  # @param function_name: The name of the function.
  # @return response: The function data, or nil if no such function exists.
  def get_function(function_name)
    @lambda_client.get_function(
      {
        function_name: function_name
      }
    )
  rescue Aws::Lambda::Errors::ResourceNotFoundException => e
    @logger.debug("Could not find function: #{function_name}:\n #{e.message}")
    nil
  end
end

```

- For API details, see [GetFunction](#) in *AWS SDK for Ruby API Reference*.

Rust

SDK for Rust

Note

There's more on GitHub. Find the complete example and learn how to set up and run in the [AWS Code Examples Repository](#).

```

/** Get the Lambda function with this Manager's name. */
pub async fn get_function(&self) -> Result<GetFunctionOutput, anyhow::Error>
{
    info!("Getting lambda function");
    self.lambda_client
        .get_function()
        .function_name(self.lambda_name.clone())
        .send()
        .await
        .map_err(anyhow::Error::from)
}

```

- For API details, see [GetFunction](#) in *AWS SDK for Rust API reference*.

SAP ABAP

SDK for SAP ABAP

Note

There's more on GitHub. Find the complete example and learn how to set up and run in the [AWS Code Examples Repository](#).

```
TRY.  
    oo_result = lo_lmd->getfunction( iv_functionname = iv_function_name ).  
    " oo_result is returned for testing purposes. "  
    MESSAGE 'Lambda function information retrieved.' TYPE 'I'.  
CATCH /aws1/cx_lmdinvparamvalueex.  
    MESSAGE 'The request contains a non-valid parameter.' TYPE 'E'.  
CATCH /aws1/cx_lmdserviceexception.  
    MESSAGE 'An internal problem was encountered by the AWS Lambda service.'  
TYPE 'E'.  
CATCH /aws1/cx_lmdtoomanyrequestsex.  
    MESSAGE 'The maximum request throughput was reached.' TYPE 'E'.  
ENDTRY.
```

- For API details, see [GetFunction](#) in *AWS SDK for SAP ABAP API reference*.

For a complete list of AWS SDK developer guides and code examples, see [Using Lambda with an AWS SDK](#). This topic also includes information about getting started and details about previous SDK versions.

Use `GetFunctionConcurrency` with a CLI

The following code examples show how to use `GetFunctionConcurrency`.

CLI

AWS CLI

To view the reserved concurrency setting for a function

The following `get-function-concurrency` example retrieves the reserved concurrency setting for the specified function.

```
aws lambda get-function-concurrency \  
  --function-name my-function
```

Output:

```
{  
  "ReservedConcurrentExecutions": 250  
}
```

- For API details, see [GetFunctionConcurrency](#) in *AWS CLI Command Reference*.

PowerShell

Tools for PowerShell

Example 1: This examples gets the Reserved concurrency for the Lambda Function

```
Get-LMFunctionConcurrency -FunctionName "MylambdaFunction123" -Select *
```

Output:

```
ReservedConcurrentExecutions  
-----  
100
```

- For API details, see [GetFunctionConcurrency](#) in *AWS Tools for PowerShell Cmdlet Reference*.

For a complete list of AWS SDK developer guides and code examples, see [Using Lambda with an AWS SDK](#). This topic also includes information about getting started and details about previous SDK versions.

Use GetFunctionConfiguration with a CLI

The following code examples show how to use GetFunctionConfiguration.

CLI

AWS CLI

To retrieve the version-specific settings of a Lambda function

The following `get-function-configuration` example displays the settings for version 2 of the `my-function` function.

```
aws lambda get-function-configuration \  
  --function-name my-function:2
```

Output:

```
{  
  "FunctionName": "my-function",  
  "LastModified": "2019-09-26T20:28:40.438+0000",  
  "RevisionId": "e52502d4-9320-4688-9cd6-152a6ab7490d",  
  "MemorySize": 256,  
  "Version": "2",  
  "Role": "arn:aws:iam::123456789012:role/service-role/my-function-role-uy3l9qyq",  
  "Timeout": 3,  
  "Runtime": "nodejs10.x",  
  "TracingConfig": {  
    "Mode": "PassThrough"  
  },  
  "CodeSha256": "5tT2qgzYUHaqwR716pZ2dpkn/0J1FrzJmLKidWoaCgk=",  
  "Description": "",  
  "VpcConfig": {  
    "SubnetIds": [],  
    "VpcId": "",  
    "SecurityGroupIds": []  
  },  
  "CodeSize": 304,  
  "FunctionArn": "arn:aws:lambda:us-west-2:123456789012:function:my-function:2",  
  "Handler": "index.handler"  
}
```

For more information, see [AWS Lambda Function Configuration](#) in the *AWS Lambda Developer Guide*.

- For API details, see [GetFunctionConfiguration](#) in *AWS CLI Command Reference*.

PowerShell

Tools for PowerShell

Example 1: This example returns the version specific configuration of a Lambda Function.

```
Get-LMFunctionConfiguration -FunctionName "MylambdaFunction123" -Qualifier
"PowershellAlias"
```

Output:

```
CodeSha256           : uW0W0R7z+f0VyLuUg7+/D08hkMFsq0SF4seuyUZJ/R8=
CodeSize             : 1426
DeadLetterConfig     : Amazon.Lambda.Model.DeadLetterConfig
Description          : Verson 3 to test Aliases
Environment          : Amazon.Lambda.Model.EnvironmentResponse
FunctionArn          : arn:aws:lambda:us-
east-1:123456789012:function:MylambdaFunction123
                    : PowershellAlias
FunctionName         : MylambdaFunction123
Handler              : lambda_function.launch_instance
KMSKeyArn            :
LastModified         : 2019-12-25T09:52:59.872+0000
LastUpdateStatus    : Successful
LastUpdateStatusReason :
LastUpdateStatusReasonCode :
Layers               : {}
MasterArn            :
MemorySize           : 128
RevisionId           : 5d7de38b-87f2-4260-8f8a-e87280e10c33
Role                 : arn:aws:iam::123456789012:role/service-role/lambda
Runtime              : python3.8
State                : Active
StateReason          :
StateReasonCode      :
Timeout              : 600
TracingConfig        : Amazon.Lambda.Model.TracingConfigResponse
Version              : 4
```

```
VpcConfig : Amazon.Lambda.Model.VpcConfigDetail
```

- For API details, see [GetFunctionConfiguration](#) in *AWS Tools for PowerShell Cmdlet Reference*.

For a complete list of AWS SDK developer guides and code examples, see [Using Lambda with an AWS SDK](#). This topic also includes information about getting started and details about previous SDK versions.

Use GetPolicy with a CLI

The following code examples show how to use GetPolicy.

CLI

AWS CLI

To retrieve the resource-based IAM policy for a function, version, or alias

The following `get-policy` example displays policy information about the `my-function` Lambda function.

```
aws lambda get-policy \  
  --function-name my-function
```

Output:

```
{  
  "Policy": {  
    "Version": "2012-10-17",  
    "Id": "default",  
    "Statement": [  
      {  
        "Sid": "iot-events",  
        "Effect": "Allow",  
        "Principal": {"Service": "iotevents.amazonaws.com"},  
        "Action": "lambda:InvokeFunction",  
        "Resource": "arn:aws:lambda:us-west-2:123456789012:function:my-  
function"  
      }  
    ]  
  }  
}
```

```
    ],  
    },  
    "RevisionId": "93017fc9-59cb-41dc-901b-4845ce4bf668"  
  }  
}
```

For more information, see [Using Resource-based Policies for AWS Lambda](#) in the *AWS Lambda Developer Guide*.

- For API details, see [GetPolicy](#) in *AWS CLI Command Reference*.

PowerShell

Tools for PowerShell

Example 1: This sample displays the Function policy of the Lambda function

```
Get-LMPolicy -FunctionName test -Select Policy
```

Output:

```
{"Version":"2012-10-17","Id":"default","Statement":  
[{"Sid":"xxxx","Effect":"Allow","Principal":  
{"Service":"sns.amazonaws.com"},"Action":"lambda:InvokeFunction","Resource":"arn:aws:lambda:  
east-1:123456789102:function:test"}]}
```

- For API details, see [GetPolicy](#) in *AWS Tools for PowerShell Cmdlet Reference*.

For a complete list of AWS SDK developer guides and code examples, see [Using Lambda with an AWS SDK](#). This topic also includes information about getting started and details about previous SDK versions.

Use GetProvisionedConcurrencyConfig with a CLI

The following code examples show how to use `GetProvisionedConcurrencyConfig`.

CLI

AWS CLI

To view a provisioned concurrency configuration

The following `get-provisioned-concurrency-config` example displays details for the provisioned concurrency configuration for the BLUE alias of the specified function.

```
aws lambda get-provisioned-concurrency-config \  
  --function-name my-function \  
  --qualifier BLUE
```

Output:

```
{  
  "RequestedProvisionedConcurrentExecutions": 100,  
  "AvailableProvisionedConcurrentExecutions": 100,  
  "AllocatedProvisionedConcurrentExecutions": 100,  
  "Status": "READY",  
  "LastModified": "2019-12-31T20:28:49+0000"  
}
```

- For API details, see [GetProvisionedConcurrencyConfig](#) in *AWS CLI Command Reference*.

PowerShell

Tools for PowerShell

Example 1: This example gets the provisioned Concurrency Configuration for the specified Alias of the Lambda Function.

```
C:\>Get-LMProvisionedConcurrencyConfig -FunctionName "MyLambdaFunction123" -  
Qualifier "NewAlias1"
```

Output:

```
AllocatedProvisionedConcurrentExecutions : 0  
AvailableProvisionedConcurrentExecutions : 0  
LastModified                             : 2020-01-15T03:21:26+0000  
RequestedProvisionedConcurrentExecutions : 70  
Status                                    : IN_PROGRESS  
StatusReason                              :
```

- For API details, see [GetProvisionedConcurrencyConfig](#) in *AWS Tools for PowerShell Cmdlet Reference*.

For a complete list of AWS SDK developer guides and code examples, see [Using Lambda with an AWS SDK](#). This topic also includes information about getting started and details about previous SDK versions.

Use Invoke with an AWS SDK or CLI

The following code examples show how to use Invoke.

Action examples are code excerpts from larger programs and must be run in context. You can see this action in context in the following code example:

- [Learn the basics](#)

.NET

AWS SDK for .NET

Note

There's more on GitHub. Find the complete example and learn how to set up and run in the [AWS Code Examples Repository](#).

```
/// <summary>
/// Invoke a Lambda function.
/// </summary>
/// <param name="functionName">The name of the Lambda function to
/// invoke.</param>
/// <param name="parameters">The parameter values that will be passed to the
function.</param>
/// <returns>A System Threading Task.</returns>
public async Task<string> InvokeFunctionAsync(
    string functionName,
    string parameters)
{
    var payload = parameters;
    var request = new InvokeRequest
    {
        FunctionName = functionName,
        Payload = payload,
    };
};
```

```
var response = await _lambdaService.InvokeAsync(request);
MemoryStream stream = response.Payload;
string returnValue =
System.Text.Encoding.UTF8.GetString(stream.ToArray());
return returnValue;
}
```

- For API details, see [Invoke](#) in *AWS SDK for .NET API Reference*.

C++

SDK for C++

Note

There's more on GitHub. Find the complete example and learn how to set up and run in the [AWS Code Examples Repository](#).

```
Aws::Client::ClientConfiguration clientConfig;
// Optional: Set to the AWS Region in which the bucket was created
(overrides config file).
// clientConfig.region = "us-east-1";

Aws::Lambda::LambdaClient client(clientConfig);

Aws::Lambda::Model::InvokeRequest request;
request.SetFunctionName(LAMBDA_NAME);
request.SetLogType(logType);
std::shared_ptr<Aws::IOStream> payload =
Aws::MakeShared<Aws::StringStream>(
    "FunctionTest");
*payload << jsonPayload.View().WriteReadable();
request.SetBody(payload);
request.SetContentType("application/json");
Aws::Lambda::Model::InvokeOutcome outcome = client.Invoke(request);

if (outcome.IsSuccess()) {
    invokeResult = std::move(outcome.GetResult());
}
```

```
        result = true;
        break;
    }

    else {
        std::cerr << "Error with Lambda::InvokeRequest. "
                  << outcome.GetError().GetMessage()
                  << std::endl;
        break;
    }
}
```

- For API details, see [Invoke](#) in *AWS SDK for C++ API Reference*.

CLI

AWS CLI

Example 1: To invoke a Lambda function synchronously

The following `invoke` example invokes the `my-function` function synchronously. The `cli-binary-format` option is required if you're using AWS CLI version 2. For more information, see [AWS CLI supported global command line options](#) in the *AWS Command Line Interface User Guide*.

```
aws lambda invoke \
  --function-name my-function \
  --cli-binary-format raw-in-base64-out \
  --payload '{ "name": "Bob" }' \
  response.json
```

Output:

```
{
  "ExecutedVersion": "$LATEST",
  "StatusCode": 200
}
```

For more information, see [Synchronous Invocation](#) in the *AWS Lambda Developer Guide*.

Example 2: To invoke a Lambda function asynchronously

The following `invoke` example invokes the `my-function` function asynchronously. The `cli-binary-format` option is required if you're using AWS CLI version 2. For more information, see [AWS CLI supported global command line options](#) in the *AWS Command Line Interface User Guide*.

```
aws lambda invoke \  
  --function-name my-function \  
  --invocation-type Event \  
  --cli-binary-format raw-in-base64-out \  
  --payload '{ "name": "Bob" }' \  
  response.json
```

Output:

```
{  
  "StatusCode": 202  
}
```

For more information, see [Asynchronous Invocation](#) in the *AWS Lambda Developer Guide*.

- For API details, see [Invoke](#) in *AWS CLI Command Reference*.

Go

SDK for Go V2

Note

There's more on GitHub. Find the complete example and learn how to set up and run in the [AWS Code Examples Repository](#).

```
import (  
  "bytes"  
  "context"  
  "encoding/json"  
  "errors"  
  "log"  
  "time"
```

```
"github.com/aws/aws-sdk-go-v2/aws"
"github.com/aws/aws-sdk-go-v2/service/lambda"
"github.com/aws/aws-sdk-go-v2/service/lambda/types"
)

// FunctionWrapper encapsulates function actions used in the examples.
// It contains an AWS Lambda service client that is used to perform user actions.
type FunctionWrapper struct {
    LambdaClient *lambda.Client
}

// Invoke invokes the Lambda function specified by functionName, passing the
// parameters
// as a JSON payload. When getLog is true, types.LogTypeTail is specified, which
// tells
// Lambda to include the last few log lines in the returned result.
func (wrapper FunctionWrapper) Invoke(ctx context.Context, functionName string,
    parameters any, getLog bool) *lambda.InvokeOutput {
    logType := types.LogTypeNone
    if getLog {
        logType = types.LogTypeTail
    }
    payload, err := json.Marshal(parameters)
    if err != nil {
        log.Panicf("Couldn't marshal parameters to JSON. Here's why %v\n", err)
    }
    invokeOutput, err := wrapper.LambdaClient.Invoke(ctx, &lambda.InvokeInput{
        FunctionName: aws.String(functionName),
        LogType:      logType,
        Payload:      payload,
    })
    if err != nil {
        log.Panicf("Couldn't invoke function %v. Here's why: %v\n", functionName, err)
    }
    return invokeOutput
}
```

- For API details, see [Invoke](#) in *AWS SDK for Go API Reference*.

Java

SDK for Java 2.x

 **Note**

There's more on GitHub. Find the complete example and learn how to set up and run in the [AWS Code Examples Repository](#).

```
/**
 * Invokes a specific AWS Lambda function.
 *
 * @param awsLambda an instance of {@link LambdaClient} to interact with
 the AWS Lambda service
 * @param functionName the name of the AWS Lambda function to be invoked
 */
public static void invokeFunction(LambdaClient awsLambda, String
functionName) {
    InvokeResponse res;
    try {
        // Need a SdkBytes instance for the payload.
        JSONObject jsonObj = new JSONObject();
        jsonObj.put("inputValue", "2000");
        String json = jsonObj.toString();
        SdkBytes payload = SdkBytes.fromUtf8String(json);

        InvokeRequest request = InvokeRequest.builder()
            .functionName(functionName)
            .payload(payload)
            .build();

        res = awsLambda.invoke(request);
        String value = res.payload().asUtf8String();
        System.out.println(value);

    } catch (LambdaException e) {
        System.err.println(e.getMessage());
        System.exit(1);
    }
}
```

- For API details, see [Invoke](#) in *AWS SDK for Java 2.x API Reference*.

JavaScript

SDK for JavaScript (v3)

Note

There's more on GitHub. Find the complete example and learn how to set up and run in the [AWS Code Examples Repository](#).

```
const invoke = async (funcName, payload) => {
  const client = new LambdaClient({});
  const command = new InvokeCommand({
    FunctionName: funcName,
    Payload: JSON.stringify(payload),
    LogType: LogType.Tail,
  });

  const { Payload, LogResult } = await client.send(command);
  const result = Buffer.from(Payload).toString();
  const logs = Buffer.from(LogResult, "base64").toString();
  return { logs, result };
};
```

- For API details, see [Invoke](#) in *AWS SDK for JavaScript API Reference*.

Kotlin

SDK for Kotlin

Note

There's more on GitHub. Find the complete example and learn how to set up and run in the [AWS Code Examples Repository](#).

```
suspend fun invokeFunction(functionNameVal: String) {
    val json = """"{"inputValue":"1000"}""""
    val byteArray = json.trimIndent().encodeToByteArray()
    val request =
        InvokeRequest {
            functionName = functionNameVal
            logType = LogType.Tail
            payload = byteArray
        }

    LambdaClient { region = "us-west-2" }.use { awsLambda ->
        val res = awsLambda.invoke(request)
        println("${res.payload?.toString(Charsets.UTF_8)}")
        println("The log result is ${res.logResult}")
    }
}
```

- For API details, see [Invoke](#) in *AWS SDK for Kotlin API reference*.

PHP

SDK for PHP

Note

There's more on GitHub. Find the complete example and learn how to set up and run in the [AWS Code Examples Repository](#).

```
public function invoke($functionName, $params, $logType = 'None')
{
    return $this->lambdaClient->invoke([
        'FunctionName' => $functionName,
        'Payload' => json_encode($params),
        'LogType' => $logType,
    ]);
}
```

- For API details, see [Invoke](#) in *AWS SDK for PHP API Reference*.

Python

SDK for Python (Boto3)

 **Note**

There's more on GitHub. Find the complete example and learn how to set up and run in the [AWS Code Examples Repository](#).

```
class LambdaWrapper:
    def __init__(self, lambda_client, iam_resource):
        self.lambda_client = lambda_client
        self.iam_resource = iam_resource

    def invoke_function(self, function_name, function_params, get_log=False):
        """
        Invokes a Lambda function.

        :param function_name: The name of the function to invoke.
        :param function_params: The parameters of the function as a dict. This
        dict
                               is serialized to JSON before it is sent to
        Lambda.
        :param get_log: When true, the last 4 KB of the execution log are
        included in
                               the response.
        :return: The response from the function invocation.
        """
        try:
            response = self.lambda_client.invoke(
                FunctionName=function_name,
                Payload=json.dumps(function_params),
                LogType="Tail" if get_log else "None",
            )
            logger.info("Invoked function %s.", function_name)
        except ClientError:
            logger.exception("Couldn't invoke function %s.", function_name)
            raise
        return response
```

- For API details, see [Invoke](#) in *AWS SDK for Python (Boto3) API Reference*.

Ruby

SDK for Ruby

Note

There's more on GitHub. Find the complete example and learn how to set up and run in the [AWS Code Examples Repository](#).

```
class LambdaWrapper
  attr_accessor :lambda_client, :cloudwatch_client, :iam_client

  def initialize
    @lambda_client = Aws::Lambda::Client.new
    @cloudwatch_client = Aws::CloudWatchLogs::Client.new(region: 'us-east-1')
    @iam_client = Aws::IAM::Client.new(region: 'us-east-1')
    @logger = Logger.new($stdout)
    @logger.level = Logger::WARN
  end

  # Invokes a Lambda function.
  # @param function_name [String] The name of the function to invoke.
  # @param payload [nil] Payload containing runtime parameters.
  # @return [Object] The response from the function invocation.
  def invoke_function(function_name, payload = nil)
    params = { function_name: function_name }
    params[:payload] = payload unless payload.nil?
    @lambda_client.invoke(params)
  rescue Aws::Lambda::Errors::ServiceException => e
    @logger.error("There was an error executing #{function_name}:\n
    #{e.message}")
  end
end
```

- For API details, see [Invoke](#) in *AWS SDK for Ruby API Reference*.

Rust

SDK for Rust

Note

There's more on GitHub. Find the complete example and learn how to set up and run in the [AWS Code Examples Repository](#).

```
/** Invoke the lambda function using calculator InvokeArgs. */
pub async fn invoke(&self, args: InvokeArgs) -> Result<InvokeOutput,
anyhow::Error> {
    info!(?args, "Invoking {}", self.lambda_name);
    let payload = serde_json::to_string(&args)?;
    debug!(?payload, "Sending payload");
    self.lambda_client
        .invoke()
        .function_name(self.lambda_name.clone())
        .payload(Blob::new(payload))
        .send()
        .await
        .map_err(anyhow::Error::from)
}

fn log_invoke_output(invoke: &InvokeOutput, message: &str) {
    if let Some(payload) = invoke.payload().cloned() {
        let payload = String::from_utf8(payload.into_inner());
        info!(?payload, message);
    } else {
        info!("Could not extract payload")
    }
    if let Some(logs) = invoke.log_result() {
        debug!(?logs, "Invoked function logs")
    } else {
        debug!("Invoked function had no logs")
    }
}
```

- For API details, see [Invoke](#) in *AWS SDK for Rust API reference*.

SAP ABAP

SDK for SAP ABAP

 **Note**

There's more on GitHub. Find the complete example and learn how to set up and run in the [AWS Code Examples Repository](#).

```

TRY.
  DATA(lv_json) = /aws1/cl_rt_util=>string_to_xstring(
    `{` &&
    ` "action": "increment",` &&
    ` "number": 10` &&
    `}`
  ).
  oo_result = lo_lmd->invoke(
    " oo_result is returned for
testing purposes. "
    iv_functionname = iv_function_name
    iv_payload = lv_json
  ).
  MESSAGE 'Lambda function invoked.' TYPE 'I'.
CATCH /aws1/cx_lmdinvparamvalueex.
  MESSAGE 'The request contains a non-valid parameter.' TYPE 'E'.
CATCH /aws1/cx_lmdinvrequestcontex.
  MESSAGE 'Unable to parse request body as JSON.' TYPE 'E'.
CATCH /aws1/cx_lmdinvalidzipfileex.
  MESSAGE 'The deployment package could not be unzipped.' TYPE 'E'.
CATCH /aws1/cx_lmdrequesttoolargeex.
  MESSAGE 'Invoke request body JSON input limit was exceeded by the request
payload.' TYPE 'E'.
CATCH /aws1/cx_lmdresourceconflictex.
  MESSAGE 'Resource already exists or another operation is in progress.'
TYPE 'E'.
CATCH /aws1/cx_lmdresourcenotfoundex.
  MESSAGE 'The requested resource does not exist.' TYPE 'E'.
CATCH /aws1/cx_lmdserviceexception.
  MESSAGE 'An internal problem was encountered by the AWS Lambda service.'
TYPE 'E'.
CATCH /aws1/cx_lmdtoomanyrequestsex.
  MESSAGE 'The maximum request throughput was reached.' TYPE 'E'.

```

```
CATCH /aws1/cx_lmdunsuppedmediatyp00.  
    MESSAGE 'Invoke request body does not have JSON as its content type.'  
TYPE 'E'.  
ENDTRY.
```

- For API details, see [Invoke](#) in *AWS SDK for SAP ABAP API reference*.

For a complete list of AWS SDK developer guides and code examples, see [Using Lambda with an AWS SDK](#). This topic also includes information about getting started and details about previous SDK versions.

Use ListFunctions with an AWS SDK or CLI

The following code examples show how to use ListFunctions.

Action examples are code excerpts from larger programs and must be run in context. You can see this action in context in the following code example:

- [Learn the basics](#)

.NET

AWS SDK for .NET

Note

There's more on GitHub. Find the complete example and learn how to set up and run in the [AWS Code Examples Repository](#).

```
/// <summary>  
/// Get a list of Lambda functions.  
/// </summary>  
/// <returns>A list of FunctionConfiguration objects.</returns>  
public async Task<List<FunctionConfiguration>> ListFunctionsAsync()  
{  
    var functionList = new List<FunctionConfiguration>();  
  
    var functionPaginator =
```

```
        _lambdaService.Paginators.ListFunctions(new ListFunctionsRequest());
    await foreach (var function in functionPaginator.Functions)
    {
        functionList.Add(function);
    }

    return functionList;
}
```

- For API details, see [ListFunctions](#) in *AWS SDK for .NET API Reference*.

C++

SDK for C++

Note

There's more on GitHub. Find the complete example and learn how to set up and run in the [AWS Code Examples Repository](#).

```
Aws::Client::ClientConfiguration clientConfig;
// Optional: Set to the AWS Region in which the bucket was created
(overrides config file).
// clientConfig.region = "us-east-1";

Aws::Lambda::LambdaClient client(clientConfig);

std::vector<Aws::String> functions;
Aws::String marker;

do {
    Aws::Lambda::Model::ListFunctionsRequest request;
    if (!marker.empty()) {
        request.SetMarker(marker);
    }

    Aws::Lambda::Model::ListFunctionsOutcome outcome = client.ListFunctions(
        request);
```

```

        if (outcome.IsSuccess()) {
            const Aws::Lambda::Model::ListFunctionsResult &result =
outcome.GetResult();
            std::cout << result.GetFunctions().size()
                << " lambda functions were retrieved." << std::endl;

            for (const Aws::Lambda::Model::FunctionConfiguration
&functionConfiguration: result.GetFunctions()) {
                functions.push_back(functionConfiguration.GetFunctionName());
                std::cout << functions.size() << " "
                    << functionConfiguration.GetDescription() << std::endl;
                std::cout << "    "
                    <<
Aws::Lambda::Model::RuntimeMapper::GetNameForRuntime(
                    functionConfiguration.GetRuntime()) << ": "
                    << functionConfiguration.GetHandler()
                    << std::endl;
            }
            marker = result.GetNextMarker();
        }
        else {
            std::cerr << "Error with Lambda::ListFunctions. "
                << outcome.GetError().GetMessage()
                << std::endl;
        }
    } while (!marker.empty());

```

- For API details, see [ListFunctions](#) in *AWS SDK for C++ API Reference*.

CLI

AWS CLI

To retrieve a list of Lambda functions

The following `list-functions` example displays a list of all of the functions for the current user.

```
aws lambda list-functions
```

Output:

```

{
  "Functions": [
    {
      "TracingConfig": {
        "Mode": "PassThrough"
      },
      "Version": "$LATEST",
      "CodeSha256": "dBG9m8SGdmlEjw/JYXlhhvCrAv5TxvXsbl/RMr0fT/I=",
      "FunctionName": "helloworld",
      "MemorySize": 128,
      "RevisionId": "1718e831-badf-4253-9518-d0644210af7b",
      "CodeSize": 294,
      "FunctionArn": "arn:aws:lambda:us-
west-2:123456789012:function:helloworld",
      "Handler": "helloworld.handler",
      "Role": "arn:aws:iam::123456789012:role/service-role/MyTestFunction-
role-zgur6bf4",
      "Timeout": 3,
      "LastModified": "2023-09-23T18:32:33.857+0000",
      "Runtime": "nodejs18.x",
      "Description": ""
    },
    {
      "TracingConfig": {
        "Mode": "PassThrough"
      },
      "Version": "$LATEST",
      "CodeSha256": "sU0cJ2/h0ZevwV/1TxCuQqK3gDZP3i8gUoqUUVmY6E=",
      "FunctionName": "my-function",
      "VpcConfig": {
        "SubnetIds": [],
        "VpcId": "",
        "SecurityGroupIds": []
      },
      "MemorySize": 256,
      "RevisionId": "93017fc9-59cb-41dc-901b-4845ce4bf668",
      "CodeSize": 266,
      "FunctionArn": "arn:aws:lambda:us-west-2:123456789012:function:my-
function",
      "Handler": "index.handler",
      "Role": "arn:aws:iam::123456789012:role/service-role/
helloWorldPython-role-uy3l9qqq",
      "Timeout": 3,

```

```
    "LastModified": "2023-10-01T16:47:28.490+0000",
    "Runtime": "nodejs18.x",
    "Description": ""
  },
  {
    "Layers": [
      {
        "CodeSize": 41784542,
        "Arn": "arn:aws:lambda:us-west-2:420165488524:layer:AWSLambda-Python37-SciPy1x:2"
      },
      {
        "CodeSize": 4121,
        "Arn": "arn:aws:lambda:us-west-2:123456789012:layer:pythonLayer:1"
      }
    ],
    "TracingConfig": {
      "Mode": "PassThrough"
    },
    "Version": "$LATEST",
    "CodeSha256": "ZQukCqxtkqFgyF2cU41Avj99TKQ/hNihPtDtRcc08mI=",
    "FunctionName": "my-python-function",
    "VpcConfig": {
      "SubnetIds": [],
      "VpcId": "",
      "SecurityGroupIds": []
    },
    "MemorySize": 128,
    "RevisionId": "80b4eabc-acf7-4ea8-919a-e874c213707d",
    "CodeSize": 299,
    "FunctionArn": "arn:aws:lambda:us-west-2:123456789012:function:my-python-function",
    "Handler": "lambda_function.lambda_handler",
    "Role": "arn:aws:iam::123456789012:role/service-role/my-python-function-role-z5g7dr6n",
    "Timeout": 3,
    "LastModified": "2023-10-01T19:40:41.643+0000",
    "Runtime": "python3.11",
    "Description": ""
  }
]
}
```

For more information, see [AWS Lambda Function Configuration](#) in the *AWS Lambda Developer Guide*.

- For API details, see [ListFunctions](#) in *AWS CLI Command Reference*.

Go

SDK for Go V2

Note

There's more on GitHub. Find the complete example and learn how to set up and run in the [AWS Code Examples Repository](#).

```
import (  
    "bytes"  
    "context"  
    "encoding/json"  
    "errors"  
    "log"  
    "time"  
  
    "github.com/aws/aws-sdk-go-v2/aws"  
    "github.com/aws/aws-sdk-go-v2/service/lambda"  
    "github.com/aws/aws-sdk-go-v2/service/lambda/types"  
)  
  
// FunctionWrapper encapsulates function actions used in the examples.  
// It contains an AWS Lambda service client that is used to perform user actions.  
type FunctionWrapper struct {  
    LambdaClient *lambda.Client  
}  
  
// ListFunctions lists up to maxItems functions for the account. This function  
// uses a  
// lambda.ListFunctionsPaginator to paginate the results.  
func (wrapper FunctionWrapper) ListFunctions(ctx context.Context, maxItems int)  
    []types.FunctionConfiguration {
```

```
var functions []types.FunctionConfiguration
paginator := lambda.NewListFunctionsPaginator(wrapper.LambdaClient,
&lambda.ListFunctionsInput{
    MaxItems: aws.Int32(int32(maxItems)),
})
for paginator.HasMorePages() && len(functions) < maxItems {
    pageOutput, err := paginator.NextPage(ctx)
    if err != nil {
        log.Panicf("Couldn't list functions for your account. Here's why: %v\n", err)
    }
    functions = append(functions, pageOutput.Functions...)
}
return functions
}
```

- For API details, see [ListFunctions](#) in *AWS SDK for Go API Reference*.

JavaScript

SDK for JavaScript (v3)

Note

There's more on GitHub. Find the complete example and learn how to set up and run in the [AWS Code Examples Repository](#).

```
const listFunctions = () => {
    const client = new LambdaClient({});
    const command = new ListFunctionsCommand({});

    return client.send(command);
};
```

- For API details, see [ListFunctions](#) in *AWS SDK for JavaScript API Reference*.

PHP

SDK for PHP

 **Note**

There's more on GitHub. Find the complete example and learn how to set up and run in the [AWS Code Examples Repository](#).

```
public function listFunctions($maxItems = 50, $marker = null)
{
    if (is_null($marker)) {
        return $this->lambdaClient->listFunctions([
            'MaxItems' => $maxItems,
        ]);
    }

    return $this->lambdaClient->listFunctions([
        'Marker' => $marker,
        'MaxItems' => $maxItems,
    ]);
}
```

- For API details, see [ListFunctions](#) in *AWS SDK for PHP API Reference*.

PowerShell

Tools for PowerShell

Example 1: This sample displays all the Lambda functions with sorted code size

```
Get-LMFunctionList | Sort-Object -Property CodeSize | Select-Object FunctionName,
    RunTime, Timeout, CodeSize
```

Output:

FunctionName	Runtime	Timeout
CodeSize		

```

-----
-----
test                python2.7          3
  243
MyLambdaFunction123 python3.8          600
  659
myfuncpython1       python3.8          303
  675

```

- For API details, see [ListFunctions](#) in *AWS Tools for PowerShell Cmdlet Reference*.

Python

SDK for Python (Boto3)

Note

There's more on GitHub. Find the complete example and learn how to set up and run in the [AWS Code Examples Repository](#).

```

class LambdaWrapper:
    def __init__(self, lambda_client, iam_resource):
        self.lambda_client = lambda_client
        self.iam_resource = iam_resource

    def list_functions(self):
        """
        Lists the Lambda functions for the current account.
        """
        try:
            func_paginator = self.lambda_client.get_paginator("list_functions")
            for func_page in func_paginator.paginate():
                for func in func_page["Functions"]:
                    print(func["FunctionName"])
                    desc = func.get("Description")
                    if desc:
                        print(f"\t{desc}")
                        print(f"\t{func['Runtime']}: {func['Handler']}")
        except ClientError as err:
            logger.error(

```

```
        "Couldn't list functions. Here's why: %s: %s",
        err.response["Error"]["Code"],
        err.response["Error"]["Message"],
    )
    raise
```

- For API details, see [ListFunctions](#) in *AWS SDK for Python (Boto3) API Reference*.

Ruby

SDK for Ruby

Note

There's more on GitHub. Find the complete example and learn how to set up and run in the [AWS Code Examples Repository](#).

```
class LambdaWrapper
  attr_accessor :lambda_client, :cloudwatch_client, :iam_client

  def initialize
    @lambda_client = Aws::Lambda::Client.new
    @cloudwatch_client = Aws::CloudWatchLogs::Client.new(region: 'us-east-1')
    @iam_client = Aws::IAM::Client.new(region: 'us-east-1')
    @logger = Logger.new($stdout)
    @logger.level = Logger::WARN
  end

  # Lists the Lambda functions for the current account.
  def list_functions
    functions = []
    @lambda_client.list_functions.each do |response|
      response['functions'].each do |function|
        functions.append(function['function_name'])
      end
    end
    functions
  end

  rescue Aws::Lambda::Errors::ServiceException => e
    @logger.error("There was an error listing functions:\n #{e.message}")
  end
end
```

```
end
```

- For API details, see [ListFunctions](#) in *AWS SDK for Ruby API Reference*.

Rust

SDK for Rust

Note

There's more on GitHub. Find the complete example and learn how to set up and run in the [AWS Code Examples Repository](#).

```
/** List all Lambda functions in the current Region. */
pub async fn list_functions(&self) -> Result<ListFunctionsOutput,
anyhow::Error> {
    info!("Listing lambda functions");
    self.lambda_client
        .list_functions()
        .send()
        .await
        .map_err(anyhow::Error::from)
}
```

- For API details, see [ListFunctions](#) in *AWS SDK for Rust API reference*.

SAP ABAP

SDK for SAP ABAP

Note

There's more on GitHub. Find the complete example and learn how to set up and run in the [AWS Code Examples Repository](#).

```

TRY.
    oo_result = lo_lmd->listfunctions( ).      " oo_result is returned for
testing purposes. "
    DATA(lt_functions) = oo_result->get_functions( ).
    MESSAGE 'Retrieved list of Lambda functions.' TYPE 'I'.
CATCH /aws1/cx_lmdinvparamvalueex.
    MESSAGE 'The request contains a non-valid parameter.' TYPE 'E'.
CATCH /aws1/cx_lmdserviceexception.
    MESSAGE 'An internal problem was encountered by the AWS Lambda service.'
TYPE 'E'.
CATCH /aws1/cx_lmdtoomanyrequestsex.
    MESSAGE 'The maximum request throughput was reached.' TYPE 'E'.
ENDTRY.

```

- For API details, see [ListFunctions](#) in *AWS SDK for SAP ABAP API reference*.

For a complete list of AWS SDK developer guides and code examples, see [Using Lambda with an AWS SDK](#). This topic also includes information about getting started and details about previous SDK versions.

Use ListProvisionedConcurrencyConfigs with a CLI

The following code examples show how to use ListProvisionedConcurrencyConfigs.

CLI

AWS CLI

To get a list of provisioned concurrency configurations

The following list-provisioned-concurrency-configs example lists the provisioned concurrency configurations for the specified function.

```
aws lambda list-provisioned-concurrency-configs \
  --function-name my-function
```

Output:

```
{
```

```
"ProvisionedConcurrencyConfigs": [  
  {  
    "FunctionArn": "arn:aws:lambda:us-east-2:123456789012:function:my-  
function:GREEN",  
    "RequestedProvisionedConcurrentExecutions": 100,  
    "AvailableProvisionedConcurrentExecutions": 100,  
    "AllocatedProvisionedConcurrentExecutions": 100,  
    "Status": "READY",  
    "LastModified": "2019-12-31T20:29:00+0000"  
  },  
  {  
    "FunctionArn": "arn:aws:lambda:us-east-2:123456789012:function:my-  
function:BLUE",  
    "RequestedProvisionedConcurrentExecutions": 100,  
    "AvailableProvisionedConcurrentExecutions": 100,  
    "AllocatedProvisionedConcurrentExecutions": 100,  
    "Status": "READY",  
    "LastModified": "2019-12-31T20:28:49+0000"  
  }  
]
```

- For API details, see [ListProvisionedConcurrencyConfigs](#) in *AWS CLI Command Reference*.

PowerShell

Tools for PowerShell

Example 1: This example retrieves the list of provisioned concurrency configurations for a Lambda function.

```
Get-LMProvisionedConcurrencyConfigList -FunctionName "MyLambdaFunction123"
```

- For API details, see [ListProvisionedConcurrencyConfigs](#) in *AWS Tools for PowerShell Cmdlet Reference*.

For a complete list of AWS SDK developer guides and code examples, see [Using Lambda with an AWS SDK](#). This topic also includes information about getting started and details about previous SDK versions.

Use ListTags with a CLI

The following code examples show how to use ListTags.

CLI

AWS CLI

To retrieve the list of tags for a Lambda function

The following `list-tags` example displays the tags attached to the `my-function` Lambda function.

```
aws lambda list-tags \  
  --resource arn:aws:lambda:us-west-2:123456789012:function:my-function
```

Output:

```
{  
  "Tags": {  
    "Category": "Web Tools",  
    "Department": "Sales"  
  }  
}
```

For more information, see [Tagging Lambda Functions](#) in the *AWS Lambda Developer Guide*.

- For API details, see [ListTags](#) in *AWS CLI Command Reference*.

PowerShell

Tools for PowerShell

Example 1: Retrieves the tags and their values currently set on the specified function.

```
Get-LMResourceTag -Resource "arn:aws:lambda:us-  
west-2:123456789012:function:MyFunction"
```

Output:

Key	Value
---	-----

```
California Sacramento
Oregon Salem
Washington Olympia
```

- For API details, see [ListTags](#) in *AWS Tools for PowerShell Cmdlet Reference*.

For a complete list of AWS SDK developer guides and code examples, see [Using Lambda with an AWS SDK](#). This topic also includes information about getting started and details about previous SDK versions.

Use ListVersionsByFunction with a CLI

The following code examples show how to use ListVersionsByFunction.

CLI

AWS CLI

To retrieve a list of versions of a function

The following `list-versions-by-function` example displays the list of versions for the `my-function` Lambda function.

```
aws lambda list-versions-by-function \
  --function-name my-function
```

Output:

```
{
  "Versions": [
    {
      "TracingConfig": {
        "Mode": "PassThrough"
      },
      "Version": "$LATEST",
      "CodeSha256": "sU0cJ2/h0ZevwV/1TxCuQqK3gDZP3i8gUoqUUVmY6E=",
      "FunctionName": "my-function",
      "VpcConfig": {
        "SubnetIds": [],
        "VpcId": "",
        "SecurityGroupIds": []
      },
    },
  ],
}
```



```

        "MemorySize": 256,
        "RevisionId": "93017fc9-59cb-41dc-901b-4845ce4bf668",
        "CodeSize": 266,
        "FunctionArn": "arn:aws:lambda:us-west-2:123456789012:function:my-
function:$LATEST",
        "Handler": "index.handler",
        "Role": "arn:aws:iam::123456789012:role/service-role/
helloWorldPython-role-uy3l9qqq",
        "Timeout": 3,
        "LastModified": "2019-10-01T16:47:28.490+0000",
        "Runtime": "nodejs10.x",
        "Description": ""
    },
    {
        "TracingConfig": {
            "Mode": "PassThrough"
        },
        "Version": "1",
        "CodeSha256": "5tT2qgzYUHoqwR616pZ2dpkn/0J1FrzJmlKidWaaCgk=",
        "FunctionName": "my-function",
        "VpcConfig": {
            "SubnetIds": [],
            "VpcId": "",
            "SecurityGroupIds": []
        },
        "MemorySize": 256,
        "RevisionId": "949c8914-012e-4795-998c-e467121951b1",
        "CodeSize": 304,
        "FunctionArn": "arn:aws:lambda:us-west-2:123456789012:function:my-
function:1",
        "Handler": "index.handler",
        "Role": "arn:aws:iam::123456789012:role/service-role/
helloWorldPython-role-uy3l9qqq",
        "Timeout": 3,
        "LastModified": "2019-09-26T20:28:40.438+0000",
        "Runtime": "nodejs10.x",
        "Description": "new version"
    },
    {
        "TracingConfig": {
            "Mode": "PassThrough"
        },
        "Version": "2",
        "CodeSha256": "sU0cJ2/h0ZevwV/1TxCuQqK3gDZP3i8gUoqUUVrMY6E=",

```

```

        "FunctionName": "my-function",
        "VpcConfig": {
            "SubnetIds": [],
            "VpcId": "",
            "SecurityGroupIds": []
        },
        "MemorySize": 256,
        "RevisionId": "cd669f21-0f3d-4e1c-9566-948837f2e2ea",
        "CodeSize": 266,
        "FunctionArn": "arn:aws:lambda:us-west-2:123456789012:function:my-
function:2",
        "Handler": "index.handler",
        "Role": "arn:aws:iam::123456789012:role/service-role/
helloWorldPython-role-uy3l9yq",
        "Timeout": 3,
        "LastModified": "2019-10-01T16:47:28.490+0000",
        "Runtime": "nodejs10.x",
        "Description": "newer version"
    }
]
}

```

For more information, see [Configuring AWS Lambda Function Aliases](#) in the *AWS Lambda Developer Guide*.

- For API details, see [ListVersionsByFunction](#) in *AWS CLI Command Reference*.

PowerShell

Tools for PowerShell

Example 1: This example returns the list of version specific configurations for each version of the Lambda Function.

```
Get-LMVersionsByFunction -FunctionName "MylambdaFunction123"
```

Output:

FunctionName	Runtime	MemorySize	Timeout	CodeSize	LastModified
RoleName					
-----	-----	-----	-----	-----	-----

```

MyLambdaFunction123 python3.8      128    600    659
2020-01-10T03:20:56.390+0000 lambda
MyLambdaFunction123 python3.8      128     5    1426
2019-12-25T09:19:02.238+0000 lambda
MyLambdaFunction123 python3.8      128     5    1426
2019-12-25T09:39:36.779+0000 lambda
MyLambdaFunction123 python3.8      128    600    1426
2019-12-25T09:52:59.872+0000 lambda

```

- For API details, see [ListVersionsByFunction](#) in *AWS Tools for PowerShell Cmdlet Reference*.

For a complete list of AWS SDK developer guides and code examples, see [Using Lambda with an AWS SDK](#). This topic also includes information about getting started and details about previous SDK versions.

Use PublishVersion with a CLI

The following code examples show how to use PublishVersion.

CLI

AWS CLI

To publish a new version of a function

The following publish-version example publishes a new version of the my-function Lambda function.

```
aws lambda publish-version \
  --function-name my-function
```

Output:

```
{
  "TracingConfig": {
    "Mode": "PassThrough"
  },
  "CodeSha256": "dBG9m8SGdm1Ejw/JYX1hhvCrAv5TxvXsBL/RM1r0fT/I=",
  "FunctionName": "my-function",
  "CodeSize": 294,
  "RevisionId": "f31d3d39-cc63-4520-97d4-43cd44c94c20",
  "MemorySize": 128,
}
```

```
"FunctionArn": "arn:aws:lambda:us-west-2:123456789012:function:my-  
function:3",  
  "Version": "2",  
  "Role": "arn:aws:iam::123456789012:role/service-role/MyTestFunction-role-  
zgur6bf4",  
  "Timeout": 3,  
  "LastModified": "2019-09-23T18:32:33.857+0000",  
  "Handler": "my-function.handler",  
  "Runtime": "nodejs10.x",  
  "Description": ""  
}
```

For more information, see [Configuring AWS Lambda Function Aliases](#) in the *AWS Lambda Developer Guide*.

- For API details, see [PublishVersion](#) in *AWS CLI Command Reference*.

PowerShell

Tools for PowerShell

Example 1: This example creates a version for the existing snapshot of Lambda Function Code

```
Publish-LMVersion -FunctionName "MylambdaFunction123" -Description "Publishing  
Existing Snapshot of function code as a new version through Powershell"
```

- For API details, see [PublishVersion](#) in *AWS Tools for PowerShell Cmdlet Reference*.

For a complete list of AWS SDK developer guides and code examples, see [Using Lambda with an AWS SDK](#). This topic also includes information about getting started and details about previous SDK versions.

Use PutFunctionConcurrency with a CLI

The following code examples show how to use PutFunctionConcurrency.

CLI

AWS CLI

To configure a reserved concurrency limit for a function

The following `put-function-concurrency` example configures 100 reserved concurrent executions for the `my-function` function.

```
aws lambda put-function-concurrency \  
  --function-name my-function \  
  --reserved-concurrent-executions 100
```

Output:

```
{  
  "ReservedConcurrentExecutions": 100  
}
```

For more information, see [Reserving Concurrency for a Lambda Function](#) in the *AWS Lambda Developer Guide*.

- For API details, see [PutFunctionConcurrency](#) in *AWS CLI Command Reference*.

PowerShell

Tools for PowerShell

Example 1: This example applies the concurrency settings for the Function as a whole.

```
Write-LMFunctionConcurrency -FunctionName "MyLambdaFunction123" -  
ReservedConcurrentExecution 100
```

- For API details, see [PutFunctionConcurrency](#) in *AWS Tools for PowerShell Cmdlet Reference*.

For a complete list of AWS SDK developer guides and code examples, see [Using Lambda with an AWS SDK](#). This topic also includes information about getting started and details about previous SDK versions.

Use `PutProvisionedConcurrencyConfig` with a CLI

The following code examples show how to use `PutProvisionedConcurrencyConfig`.

CLI

AWS CLI

To allocate provisioned concurrency

The following `put-provisioned-concurrency-config` example allocates 100 provisioned concurrency for the BLUE alias of the specified function.

```
aws lambda put-provisioned-concurrency-config \  
  --function-name my-function \  
  --qualifier BLUE \  
  --provisioned-concurrent-executions 100
```

Output:

```
{  
  "Requested ProvisionedConcurrentExecutions": 100,  
  "Allocated ProvisionedConcurrentExecutions": 0,  
  "Status": "IN_PROGRESS",  
  "LastModified": "2019-11-21T19:32:12+0000"  
}
```

- For API details, see [PutProvisionedConcurrencyConfig](#) in *AWS CLI Command Reference*.

PowerShell

Tools for PowerShell

Example 1: This example adds a provisioned concurrency configuration to a Function's Alias

```
Write-LMProvisionedConcurrencyConfig -FunctionName "MyLambdaFunction123" -  
  ProvisionedConcurrentExecution 20 -Qualifier "NewAlias1"
```

- For API details, see [PutProvisionedConcurrencyConfig](#) in *AWS Tools for PowerShell Cmdlet Reference*.

For a complete list of AWS SDK developer guides and code examples, see [Using Lambda with an AWS SDK](#). This topic also includes information about getting started and details about previous SDK versions.

Use RemovePermission with a CLI

The following code examples show how to use RemovePermission.

CLI

AWS CLI

To remove permissions from an existing Lambda function

The following `remove-permission` example removes permission to invoke a function named `my-function`.

```
aws lambda remove-permission \  
  --function-name my-function \  
  --statement-id sns
```

This command produces no output.

For more information, see [Using Resource-based Policies for AWS Lambda](#) in the *AWS Lambda Developer Guide*.

- For API details, see [RemovePermission](#) in *AWS CLI Command Reference*.

PowerShell

Tools for PowerShell

Example 1: This example removes the function policy for the specified StatementId of a Lambda Function.

```
$policy = Get-LMPolicy -FunctionName "MylambdaFunction123" -Select Policy |  
  ConvertFrom-Json | Select-Object -ExpandProperty Statement  
Remove-LMPPermission -FunctionName "MylambdaFunction123" -StatementId  
  $policy[0].Sid
```

- For API details, see [RemovePermission](#) in *AWS Tools for PowerShell Cmdlet Reference*.

For a complete list of AWS SDK developer guides and code examples, see [Using Lambda with an AWS SDK](#). This topic also includes information about getting started and details about previous SDK versions.

Use TagResource with a CLI

The following code examples show how to use TagResource.

CLI

AWS CLI

To add tags to an existing Lambda function

The following tag-resource example adds a tag with the key name DEPARTMENT and a value of Department A to the specified Lambda function.

```
aws lambda tag-resource \  
  --resource arn:aws:lambda:us-west-2:123456789012:function:my-function \  
  --tags "DEPARTMENT=Department A"
```

This command produces no output.

For more information, see [Tagging Lambda Functions](#) in the *AWS Lambda Developer Guide*.

- For API details, see [TagResource](#) in *AWS CLI Command Reference*.

PowerShell

Tools for PowerShell

Example 1: Adds the three tags (Washington, Oregon and California) and their associated values to the specified function identified by its ARN.

```
Add-LMResourceTag -Resource "arn:aws:lambda:us-  
west-2:123456789012:function:MyFunction" -Tag @{ "Washington" = "Olympia";  
  "Oregon" = "Salem"; "California" = "Sacramento" }
```

- For API details, see [TagResource](#) in *AWS Tools for PowerShell Cmdlet Reference*.

For a complete list of AWS SDK developer guides and code examples, see [Using Lambda with an AWS SDK](#). This topic also includes information about getting started and details about previous SDK versions.

Use UntagResource with a CLI

The following code examples show how to use UntagResource.

CLI

AWS CLI

To remove tags from an existing Lambda function

The following `untag-resource` example removes the tag with the key name `DEPARTMENT` tag from the `my-function` Lambda function.

```
aws lambda untag-resource \  
  --resource arn:aws:lambda:us-west-2:123456789012:function:my-function \  
  --tag-keys DEPARTMENT
```

This command produces no output.

For more information, see [Tagging Lambda Functions](#) in the *AWS Lambda Developer Guide*.

- For API details, see [UntagResource](#) in *AWS CLI Command Reference*.

PowerShell

Tools for PowerShell

Example 1: Removes the supplied tags from a function. The cmdlet will prompt for confirmation before proceeding unless the `-Force` switch is specified. A single call is made to the service to remove the tags.

```
Remove-LMResourceTag -Resource "arn:aws:lambda:us-  
west-2:123456789012:function:MyFunction" -TagKey  
  "Washington", "Oregon", "California"
```

Example 2: Removes the supplied tags from a function. The cmdlet will prompt for confirmation before proceeding unless the `-Force` switch is specified. Once call to the service is made per supplied tag.

```
"Washington","Oregon","California" | Remove-LMResourceTag -Resource
"arn:aws:lambda:us-west-2:123456789012:function:MyFunction"
```

- For API details, see [UntagResource](#) in *AWS Tools for PowerShell Cmdlet Reference*.

For a complete list of AWS SDK developer guides and code examples, see [Using Lambda with an AWS SDK](#). This topic also includes information about getting started and details about previous SDK versions.

Use UpdateAlias with a CLI

The following code examples show how to use UpdateAlias.

CLI

AWS CLI

To update a function alias

The following update-alias example updates the alias named LIVE to point to version 3 of the my-function Lambda function.

```
aws lambda update-alias \  
  --function-name my-function \  
  --function-version 3 \  
  --name LIVE
```

Output:

```
{  
  "FunctionVersion": "3",  
  "Name": "LIVE",  
  "AliasArn": "arn:aws:lambda:us-west-2:123456789012:function:my-  
function:LIVE",  
  "RevisionId": "594f41fb-b85f-4c20-95c7-6ca5f2a92c93",  
  "Description": "alias for live version of function"  
}
```

For more information, see [Configuring AWS Lambda Function Aliases](#) in the *AWS Lambda Developer Guide*.

- For API details, see [UpdateAlias](#) in *AWS CLI Command Reference*.

PowerShell

Tools for PowerShell

Example 1: This example updates the Configuration of an existing Lambda function Alias. It updates the RoutingConfiguration value to shift 60% (0.6) of traffic to version 1

```
Update-LMAlias -FunctionName "MyLambdaFunction123" -Description  
  " Alias for version 2" -FunctionVersion 2 -Name "newlabel1" -  
RoutingConfig_AdditionalVersionWeight @{Name="1";Value="0.6}
```

- For API details, see [UpdateAlias](#) in *AWS Tools for PowerShell Cmdlet Reference*.

For a complete list of AWS SDK developer guides and code examples, see [Using Lambda with an AWS SDK](#). This topic also includes information about getting started and details about previous SDK versions.

Use UpdateFunctionCode with an AWS SDK or CLI

The following code examples show how to use UpdateFunctionCode.

Action examples are code excerpts from larger programs and must be run in context. You can see this action in context in the following code example:

- [Learn the basics](#)

.NET

AWS SDK for .NET

Note

There's more on GitHub. Find the complete example and learn how to set up and run in the [AWS Code Examples Repository](#).

```
/// <summary>
```

```

    /// Update an existing Lambda function.
    /// </summary>
    /// <param name="functionName">The name of the Lambda function to update.</
param>
    /// <param name="bucketName">The bucket where the zip file containing
    /// the Lambda function code is stored.</param>
    /// <param name="key">The key name of the source code file.</param>
    /// <returns>Async Task.</returns>
    public async Task UpdateFunctionCodeAsync(
        string functionName,
        string bucketName,
        string key)
    {
        var functionCodeRequest = new UpdateFunctionCodeRequest
        {
            FunctionName = functionName,
            Publish = true,
            S3Bucket = bucketName,
            S3Key = key,
        };

        var response = await
        _lambdaService.UpdateFunctionCodeAsync(functionCodeRequest);
        Console.WriteLine($"The Function was last modified at
        {response.LastModified}.");
    }

```

- For API details, see [UpdateFunctionCode](#) in *AWS SDK for .NET API Reference*.

C++

SDK for C++

Note

There's more on GitHub. Find the complete example and learn how to set up and run in the [AWS Code Examples Repository](#).

```
Aws::Client::ClientConfiguration clientConfig;
```

```

        // Optional: Set to the AWS Region in which the bucket was created
        (overrides config file).
        // clientConfig.region = "us-east-1";

    Aws::Lambda::LambdaClient client(clientConfig);

    Aws::Lambda::Model::UpdateFunctionCodeRequest request;
    request.SetFunctionName(LAMBDA_NAME);
    std::ifstream ifstream(CALCULATOR_LAMBDA_CODE.c_str(),
                          std::ios_base::in | std::ios_base::binary);
    if (!ifstream.is_open()) {
        std::cerr << "Error opening file " << INCREMENT_LAMBDA_CODE << "." <<
std::endl;
}

#ifdef USE_CPP_LAMBDA_FUNCTION
    std::cerr
        << "The cpp Lambda function must be built following the
instructions in the cpp_lambda/README.md file. "
        << std::endl;
#endif

    deleteLambdaFunction(client);
    deleteIamRole(clientConfig);
    return false;
}

    Aws::StringStream buffer;
    buffer << ifstream.rdbuf();
    request.SetZipFile(
        Aws::Utils::ByteBuffer((unsigned char *) buffer.str().c_str(),
                               buffer.str().length()));

    request.SetPublish(true);

    Aws::Lambda::Model::UpdateFunctionCodeOutcome outcome =
client.UpdateFunctionCode(
    request);

    if (outcome.IsSuccess()) {
        std::cout << "The lambda code was successfully updated." <<
std::endl;
    }
    else {
        std::cerr << "Error with Lambda::UpdateFunctionCode. "
        << outcome.GetError().GetMessage()
        << std::endl;
    }
}

```

```
}
```

- For API details, see [UpdateFunctionCode](#) in *AWS SDK for C++ API Reference*.

CLI

AWS CLI

To update the code of a Lambda function

The following `update-function-code` example replaces the code of the unpublished (`$LATEST`) version of the `my-function` function with the contents of the specified zip file.

```
aws lambda update-function-code \  
  --function-name my-function \  
  --zip-file fileb://my-function.zip
```

Output:

```
{  
  "FunctionName": "my-function",  
  "LastModified": "2019-09-26T20:28:40.438+0000",  
  "RevisionId": "e52502d4-9320-4688-9cd6-152a6ab7490d",  
  "MemorySize": 256,  
  "Version": "$LATEST",  
  "Role": "arn:aws:iam::123456789012:role/service-role/my-function-role-  
uy3l9qqq",  
  "Timeout": 3,  
  "Runtime": "nodejs10.x",  
  "TracingConfig": {  
    "Mode": "PassThrough"  
  },  
  "CodeSha256": "5tT2qgzYUHaqWR716pZ2dpkn/0J1FrzJm1KidWoaCgk=",  
  "Description": "",  
  "VpcConfig": {  
    "SubnetIds": [],  
    "VpcId": "",  
    "SecurityGroupIds": []  
  },  
  "CodeSize": 304,  
  "FunctionArn": "arn:aws:lambda:us-west-2:123456789012:function:my-function",
```

```
"Handler": "index.handler"
}
```

For more information, see [AWS Lambda Function Configuration](#) in the *AWS Lambda Developer Guide*.

- For API details, see [UpdateFunctionCode](#) in *AWS CLI Command Reference*.

Go

SDK for Go V2

Note

There's more on GitHub. Find the complete example and learn how to set up and run in the [AWS Code Examples Repository](#).

```
import (
    "bytes"
    "context"
    "encoding/json"
    "errors"
    "log"
    "time"

    "github.com/aws/aws-sdk-go-v2/aws"
    "github.com/aws/aws-sdk-go-v2/service/lambda"
    "github.com/aws/aws-sdk-go-v2/service/lambda/types"
)

// FunctionWrapper encapsulates function actions used in the examples.
// It contains an AWS Lambda service client that is used to perform user actions.
type FunctionWrapper struct {
    LambdaClient *lambda.Client
}

// UpdateFunctionCode updates the code for the Lambda function specified by
// functionName.
```

```
// The existing code for the Lambda function is entirely replaced by the code in
// the
// zipPackage buffer. After the update action is called, a
// lambda.FunctionUpdatedV2Waiter
// is used to wait until the update is successful.
func (wrapper FunctionWrapper) UpdateFunctionCode(ctx context.Context,
functionName string, zipPackage *bytes.Buffer) types.State {
var state types.State
_, err := wrapper.LambdaClient.UpdateFunctionCode(ctx,
&lambda.UpdateFunctionCodeInput{
    FunctionName: aws.String(functionName), ZipFile: zipPackage.Bytes(),
})
if err != nil {
    log.Panicf("Couldn't update code for function %v. Here's why: %v\n",
functionName, err)
} else {
    waiter := lambda.NewFunctionUpdatedV2Waiter(wrapper.LambdaClient)
    funcOutput, err := waiter.WaitForOutput(ctx, &lambda.GetFunctionInput{
        FunctionName: aws.String(functionName)}, 1*time.Minute)
    if err != nil {
        log.Panicf("Couldn't wait for function %v to be active. Here's why: %v\n",
functionName, err)
    } else {
        state = funcOutput.Configuration.State
    }
}
return state
}
```

- For API details, see [UpdateFunctionCode](#) in *AWS SDK for Go API Reference*.

Java

SDK for Java 2.x

Note

There's more on GitHub. Find the complete example and learn how to set up and run in the [AWS Code Examples Repository](#).

```
/**
 * Retrieves information about an AWS Lambda function.
 *
 * @param awsLambda an instance of the {@link LambdaClient} class, which
 is used to interact with the AWS Lambda service
 * @param functionName the name of the AWS Lambda function to retrieve
 information about
 */
public static void getFunction(LambdaClient awsLambda, String functionName) {
    try {
        GetFunctionRequest functionRequest = GetFunctionRequest.builder()
            .functionName(functionName)
            .build();

        GetFunctionResponse response =
awsLambda.getFunction(functionRequest);
        System.out.println("The runtime of this Lambda function is " +
response.configuration().runtime());

    } catch (LambdaException e) {
        System.err.println(e.getMessage());
        System.exit(1);
    }
}
```

- For API details, see [UpdateFunctionCode](#) in *AWS SDK for Java 2.x API Reference*.

JavaScript

SDK for JavaScript (v3)

Note

There's more on GitHub. Find the complete example and learn how to set up and run in the [AWS Code Examples Repository](#).

```
const updateFunctionCode = async (funcName, newFunc) => {
    const client = new LambdaClient({});
    const code = await readFile(`${dirname}../functions/${newFunc}.zip`);
```

```
const command = new UpdateFunctionCodeCommand({
  ZipFile: code,
  FunctionName: funcName,
  Architectures: [Architecture.arm64],
  Handler: "index.handler", // Required when sending a .zip file
  PackageType: PackageType.Zip, // Required when sending a .zip file
  Runtime: Runtime.nodejs16x, // Required when sending a .zip file
});

return client.send(command);
};
```

- For API details, see [UpdateFunctionCode](#) in *AWS SDK for JavaScript API Reference*.

PHP

SDK for PHP

Note

There's more on GitHub. Find the complete example and learn how to set up and run in the [AWS Code Examples Repository](#).

```
public function updateFunctionCode($functionName, $s3Bucket, $s3Key)
{
    return $this->lambdaClient->updateFunctionCode([
        'FunctionName' => $functionName,
        'S3Bucket' => $s3Bucket,
        'S3Key' => $s3Key,
    ]);
}
```

- For API details, see [UpdateFunctionCode](#) in *AWS SDK for PHP API Reference*.

PowerShell

Tools for PowerShell

Example 1: Updates the function named 'MyFunction' with new content contained in the specified zip file. For a C# .NET Core Lambda function the zip file should contain the compiled assembly.

```
Update-LMFunctionCode -FunctionName MyFunction -ZipFilename .\UpdatedCode.zip
```

Example 2: This example is similar to the previous one but uses an Amazon S3 object containing the updated code to update the function.

```
Update-LMFunctionCode -FunctionName MyFunction -BucketName amzn-s3-demo-bucket -  
Key UpdatedCode.zip
```

- For API details, see [UpdateFunctionCode](#) in *AWS Tools for PowerShell Cmdlet Reference*.

Python

SDK for Python (Boto3)

Note

There's more on GitHub. Find the complete example and learn how to set up and run in the [AWS Code Examples Repository](#).

```
class LambdaWrapper:  
    def __init__(self, lambda_client, iam_resource):  
        self.lambda_client = lambda_client  
        self.iam_resource = iam_resource  
  
    def update_function_code(self, function_name, deployment_package):  
        """  
        Updates the code for a Lambda function by submitting a .zip archive that  
        contains  
        the code for the function.  
        """
```

```

        :param function_name: The name of the function to update.
        :param deployment_package: The function code to update, packaged as bytes
in
        .zip format.
        :return: Data about the update, including the status.
        """
    try:
        response = self.lambda_client.update_function_code(
            FunctionName=function_name, ZipFile=deployment_package
        )
    except ClientError as err:
        logger.error(
            "Couldn't update function %s. Here's why: %s: %s",
            function_name,
            err.response["Error"]["Code"],
            err.response["Error"]["Message"],
        )
        raise
    else:
        return response

```

- For API details, see [UpdateFunctionCode](#) in *AWS SDK for Python (Boto3) API Reference*.

Ruby

SDK for Ruby

Note

There's more on GitHub. Find the complete example and learn how to set up and run in the [AWS Code Examples Repository](#).

```

class LambdaWrapper
  attr_accessor :lambda_client, :cloudwatch_client, :iam_client

  def initialize
    @lambda_client = Aws::Lambda::Client.new
    @cloudwatch_client = Aws::CloudWatchLogs::Client.new(region: 'us-east-1')
    @iam_client = Aws::IAM::Client.new(region: 'us-east-1')
  end
end

```

```

    @logger = Logger.new($stdout)
    @logger.level = Logger::WARN
  end

  # Updates the code for a Lambda function by submitting a .zip archive that
  # contains
  # the code for the function.
  #
  # @param function_name: The name of the function to update.
  # @param deployment_package: The function code to update, packaged as bytes in
  #                             .zip format.
  # @return: Data about the update, including the status.
  def update_function_code(function_name, deployment_package)
    @lambda_client.update_function_code(
      function_name: function_name,
      zip_file: deployment_package
    )
    @lambda_client.wait_until(:function_updated_v2, { function_name:
function_name }) do |w|
      w.max_attempts = 5
      w.delay = 5
    end
    rescue Aws::Lambda::Errors::ServiceException => e
      @logger.error("There was an error updating function code for:
#{function_name}:\n #{e.message}")
      nil
    rescue Aws::Waiters::Errors::WaiterFailed => e
      @logger.error("Failed waiting for #{function_name} to update:\n
#{e.message}")
    end
  end

```

- For API details, see [UpdateFunctionCode](#) in *AWS SDK for Ruby API Reference*.

Rust

SDK for Rust

Note

There's more on GitHub. Find the complete example and learn how to set up and run in the [AWS Code Examples Repository](#).

```

    /** Given a Path to a zip file, update the function's code and wait for the
    update to finish. */
    pub async fn update_function_code(
        &self,
        zip_file: PathBuf,
        key: String,
    ) -> Result<UpdateFunctionCodeOutput, anyhow::Error> {
        let function_code = self.prepare_function(zip_file, Some(key)).await?;

        info!("Updating code for {}", self.lambda_name);
        let update = self
            .lambda_client
            .update_function_code()
            .function_name(self.lambda_name.clone())
            .s3_bucket(self.bucket.clone())
            .s3_key(function_code.s3_key().unwrap().to_string())
            .send()
            .await
            .map_err(anyhow::Error::from)?;

        self.wait_for_function_ready().await?;

        Ok(update)
    }

    /**
     * Upload function code from a path to a zip file.
     * The zip file must have an AL2 Linux-compatible binary called `bootstrap`.
     * The easiest way to create such a zip is to use `cargo lambda build --
    output-format Zip`.
     */
    async fn prepare_function(
        &self,
        zip_file: PathBuf,
        key: Option<String>,
    ) -> Result<FunctionCode, anyhow::Error> {
        let body = ByteStream::from_path(zip_file).await?;

        let key = key.unwrap_or_else(|| format!("{}", self.lambda_name));

        info!("Uploading function code to s3://{}/{}", self.bucket, key);
        let _ = self
            .s3_client

```

```

        .put_object()
        .bucket(self.bucket.clone())
        .key(key.clone())
        .body(body)
        .send()
        .await?;

    Ok(FunctionCode::builder()
        .s3_bucket(self.bucket.clone())
        .s3_key(key)
        .build())
}

```

- For API details, see [UpdateFunctionCode](#) in *AWS SDK for Rust API reference*.

SAP ABAP

SDK for SAP ABAP

Note

There's more on GitHub. Find the complete example and learn how to set up and run in the [AWS Code Examples Repository](#).

```

TRY.
    oo_result = lo_lmd->updatefunctioncode(      " oo_result is returned for
testing purposes. "
        iv_functionname = iv_function_name
        iv_zipfile = io_zip_file
    ).

    MESSAGE 'Lambda function code updated.' TYPE 'I'.
CATCH /aws1/cx_lmdcodesigningcfgno00.
    MESSAGE 'Code signing configuration does not exist.' TYPE 'E'.
CATCH /aws1/cx_lmdcodestorageexcdex.
    MESSAGE 'Maximum total code size per account exceeded.' TYPE 'E'.
CATCH /aws1/cx_lmdcodeverification00.
    MESSAGE 'Code signature failed one or more validation checks for
signature mismatch or expiration.' TYPE 'E'.
CATCH /aws1/cx_lmdinvalidcodesigex.

```

```
    MESSAGE 'Code signature failed the integrity check.' TYPE 'E'.
  CATCH /aws1/cx_lmdinvparamvalueex.
    MESSAGE 'The request contains a non-valid parameter.' TYPE 'E'.
  CATCH /aws1/cx_lmdresourceconflictex.
    MESSAGE 'Resource already exists or another operation is in progress.'
TYPE 'E'.
  CATCH /aws1/cx_lmdresourcenotfoundex.
    MESSAGE 'The requested resource does not exist.' TYPE 'E'.
  CATCH /aws1/cx_lmdserviceexception.
    MESSAGE 'An internal problem was encountered by the AWS Lambda service.'
TYPE 'E'.
  CATCH /aws1/cx_lmdtoomanyrequestsex.
    MESSAGE 'The maximum request throughput was reached.' TYPE 'E'.
  ENDRTRY.
```

- For API details, see [UpdateFunctionCode](#) in *AWS SDK for SAP ABAP API reference*.

For a complete list of AWS SDK developer guides and code examples, see [Using Lambda with an AWS SDK](#). This topic also includes information about getting started and details about previous SDK versions.

Use UpdateFunctionConfiguration with an AWS SDK or CLI

The following code examples show how to use UpdateFunctionConfiguration.

Action examples are code excerpts from larger programs and must be run in context. You can see this action in context in the following code example:

- [Learn the basics](#)

.NET

AWS SDK for .NET

Note

There's more on GitHub. Find the complete example and learn how to set up and run in the [AWS Code Examples Repository](#).

```
/// <summary>
/// Update the code of a Lambda function.
/// </summary>
/// <param name="functionName">The name of the function to update.</param>
/// <param name="functionHandler">The code that performs the function's
actions.</param>
/// <param name="environmentVariables">A dictionary of environment
variables.</param>
/// <returns>A Boolean value indicating the success of the action.</returns>
public async Task<bool> UpdateFunctionConfigurationAsync(
    string functionName,
    string functionHandler,
    Dictionary<string, string> environmentVariables)
{
    var request = new UpdateFunctionConfigurationRequest
    {
        Handler = functionHandler,
        FunctionName = functionName,
        Environment = new Amazon.Lambda.Model.Environment { Variables =
environmentVariables },
    };

    var response = await
_lambdaService.UpdateFunctionConfigurationAsync(request);

    Console.WriteLine(response.LastModified);

    return response.HttpStatusCode == System.Net.HttpStatusCode.OK;
}
```

- For API details, see [UpdateFunctionConfiguration](#) in *AWS SDK for .NET API Reference*.

C++

SDK for C++

 **Note**

There's more on GitHub. Find the complete example and learn how to set up and run in the [AWS Code Examples Repository](#).

```
Aws::Client::ClientConfiguration clientConfig;
// Optional: Set to the AWS Region in which the bucket was created
(overrides config file).
// clientConfig.region = "us-east-1";

Aws::Lambda::LambdaClient client(clientConfig);

Aws::Lambda::Model::UpdateFunctionConfigurationRequest request;
request.SetFunctionName(LAMBDA_NAME);
Aws::Lambda::Model::Environment environment;
environment.AddVariables("LOG_LEVEL", "DEBUG");
request.SetEnvironment(environment);

Aws::Lambda::Model::UpdateFunctionConfigurationOutcome outcome =
client.UpdateFunctionConfiguration(
    request);

if (outcome.IsSuccess()) {
    std::cout << "The lambda configuration was successfully updated."
              << std::endl;
    break;
}

else {
    std::cerr << "Error with Lambda::UpdateFunctionConfiguration. "
              << outcome.GetError().GetMessage()
              << std::endl;
}
```

- For API details, see [UpdateFunctionConfiguration](#) in *AWS SDK for C++ API Reference*.

CLI

AWS CLI

To modify the configuration of a function

The following `update-function-configuration` example modifies the memory size to be 256 MB for the unpublished (`$LATEST`) version of the `my-function` function.

```
aws lambda update-function-configuration \  
  --function-name my-function \  
  --memory-size 256
```

Output:

```
{  
  "FunctionName": "my-function",  
  "LastModified": "2019-09-26T20:28:40.438+0000",  
  "RevisionId": "e52502d4-9320-4688-9cd6-152a6ab7490d",  
  "MemorySize": 256,  
  "Version": "$LATEST",  
  "Role": "arn:aws:iam::123456789012:role/service-role/my-function-role-  
uy3l9qqq",  
  "Timeout": 3,  
  "Runtime": "nodejs10.x",  
  "TracingConfig": {  
    "Mode": "PassThrough"  
  },  
  "CodeSha256": "5tT2qgzYUHaqwR716pZ2dpkn/0J1FrzJm1KidWoaCgk=",  
  "Description": "",  
  "VpcConfig": {  
    "SubnetIds": [],  
    "VpcId": "",  
    "SecurityGroupIds": []  
  },  
  "CodeSize": 304,  
  "FunctionArn": "arn:aws:lambda:us-west-2:123456789012:function:my-function",  
  "Handler": "index.handler"  
}
```

For more information, see [AWS Lambda Function Configuration](#) in the *AWS Lambda Developer Guide*.

- For API details, see [UpdateFunctionConfiguration](#) in *AWS CLI Command Reference*.

Go

SDK for Go V2

Note

There's more on GitHub. Find the complete example and learn how to set up and run in the [AWS Code Examples Repository](#).

```
import (  
    "bytes"  
    "context"  
    "encoding/json"  
    "errors"  
    "log"  
    "time"  
  
    "github.com/aws/aws-sdk-go-v2/aws"  
    "github.com/aws/aws-sdk-go-v2/service/lambda"  
    "github.com/aws/aws-sdk-go-v2/service/lambda/types"  
)  
  
// FunctionWrapper encapsulates function actions used in the examples.  
// It contains an AWS Lambda service client that is used to perform user actions.  
type FunctionWrapper struct {  
    LambdaClient *lambda.Client  
}  
  
// UpdateFunctionConfiguration updates a map of environment variables configured  
// for  
// the Lambda function specified by functionName.  
func (wrapper FunctionWrapper) UpdateFunctionConfiguration(ctx context.Context,  
    functionName string, envVars map[string]string) {  
    _, err := wrapper.LambdaClient.UpdateFunctionConfiguration(ctx,  
        &lambda.UpdateFunctionConfigurationInput{  
            FunctionName: aws.String(functionName),
```

```

    Environment: &types.Environment{Variables: envVars},
  })
  if err != nil {
    log.Panicf("Couldn't update configuration for %v. Here's why: %v",
      functionName, err)
  }
}

```

- For API details, see [UpdateFunctionConfiguration](#) in *AWS SDK for Go API Reference*.

Java

SDK for Java 2.x

Note

There's more on GitHub. Find the complete example and learn how to set up and run in the [AWS Code Examples Repository](#).

```

/**
 * Updates the configuration of an AWS Lambda function.
 *
 * @param awsLambda      the {@link LambdaClient} instance to use for the AWS
Lambda operation
 * @param functionName  the name of the AWS Lambda function to update
 * @param handler        the new handler for the AWS Lambda function
 *
 * @throws LambdaException if there is an error while updating the function
configuration
 */
public static void updateFunctionConfiguration(LambdaClient awsLambda, String
functionName, String handler) {
    try {
        UpdateFunctionConfigurationRequest configurationRequest =
UpdateFunctionConfigurationRequest.builder()
            .functionName(functionName)
            .handler(handler)
            .runtime(Runtime.JAVA17)
            .build();
    }
}

```

```
        awsLambda.updateFunctionConfiguration(configurationRequest);

    } catch (LambdaException e) {
        System.err.println(e.getMessage());
        System.exit(1);
    }
}
```

- For API details, see [UpdateFunctionConfiguration](#) in *AWS SDK for Java 2.x API Reference*.

JavaScript

SDK for JavaScript (v3)

Note

There's more on GitHub. Find the complete example and learn how to set up and run in the [AWS Code Examples Repository](#).

```
const updateFunctionConfiguration = (funcName) => {
    const client = new LambdaClient({});
    const config = readFileSync(`${dirname}../functions/config.json`).toString();
    const command = new UpdateFunctionConfigurationCommand({
        ...JSON.parse(config),
        FunctionName: funcName,
    });
    const result = client.send(command);
    waitForFunctionUpdated({ FunctionName: funcName });
    return result;
};
```

- For API details, see [UpdateFunctionConfiguration](#) in *AWS SDK for JavaScript API Reference*.

PHP

SDK for PHP

Note

There's more on GitHub. Find the complete example and learn how to set up and run in the [AWS Code Examples Repository](#).

```
public function updateFunctionConfiguration($functionName, $handler,
$environment = '')
{
    return $this->lambdaClient->updateFunctionConfiguration([
        'FunctionName' => $functionName,
        'Handler' => "$handler.lambda_handler",
        'Environment' => $environment,
    ]);
}
```

- For API details, see [UpdateFunctionConfiguration](#) in *AWS SDK for PHP API Reference*.

PowerShell

Tools for PowerShell

Example 1: This example updates the existing Lambda Function Configuration

```
Update-LMFunctionConfiguration -FunctionName "MylambdaFunction123" -Handler
"lambda_function.launch_instance" -Timeout 600 -Environment_Variable
@{ "envvar1"="value";"envvar2"="value" } -Role arn:aws:iam::123456789101:role/
service-role/lambda -DeadLetterConfig_TargetArn arn:aws:sns:us-east-1:
123456789101:MyfirstTopic
```

- For API details, see [UpdateFunctionConfiguration](#) in *AWS Tools for PowerShell Cmdlet Reference*.

Python

SDK for Python (Boto3)

Note

There's more on GitHub. Find the complete example and learn how to set up and run in the [AWS Code Examples Repository](#).

```
class LambdaWrapper:
    def __init__(self, lambda_client, iam_resource):
        self.lambda_client = lambda_client
        self.iam_resource = iam_resource

    def update_function_configuration(self, function_name, env_vars):
        """
        Updates the environment variables for a Lambda function.

        :param function_name: The name of the function to update.
        :param env_vars: A dict of environment variables to update.
        :return: Data about the update, including the status.
        """
        try:
            response = self.lambda_client.update_function_configuration(
                FunctionName=function_name, Environment={"Variables": env_vars}
            )
        except ClientError as err:
            logger.error(
                "Couldn't update function configuration %s. Here's why: %s: %s",
                function_name,
                err.response["Error"]["Code"],
                err.response["Error"]["Message"],
            )
            raise
        else:
            return response
```

- For API details, see [UpdateFunctionConfiguration](#) in *AWS SDK for Python (Boto3) API Reference*.

Ruby

SDK for Ruby

Note

There's more on GitHub. Find the complete example and learn how to set up and run in the [AWS Code Examples Repository](#).

```
class LambdaWrapper
  attr_accessor :lambda_client, :cloudwatch_client, :iam_client

  def initialize
    @lambda_client = Aws::Lambda::Client.new
    @cloudwatch_client = Aws::CloudWatchLogs::Client.new(region: 'us-east-1')
    @iam_client = Aws::IAM::Client.new(region: 'us-east-1')
    @logger = Logger.new($stdout)
    @logger.level = Logger::WARN
  end

  # Updates the environment variables for a Lambda function.
  # @param function_name: The name of the function to update.
  # @param log_level: The log level of the function.
  # @return: Data about the update, including the status.
  def update_function_configuration(function_name, log_level)
    @lambda_client.update_function_configuration({
      function_name: function_name,
      environment: {
        variables: {
          'LOG_LEVEL' => log_level
        }
      }
    })

    @lambda_client.wait_until(:function_updated_v2, { function_name:
function_name }) do |w|
      w.max_attempts = 5
      w.delay = 5
    end
  end
end
```

```

end
rescue Aws::Lambda::Errors::ServiceException => e
  @logger.error("There was an error updating configurations for
#{function_name}:\n #{e.message}")
  rescue Aws::Waiters::Errors::WaiterFailed => e
    @logger.error("Failed waiting for #{function_name} to activate:\n
#{e.message}")
  end
end

```

- For API details, see [UpdateFunctionConfiguration](#) in *AWS SDK for Ruby API Reference*.

Rust

SDK for Rust

Note

There's more on GitHub. Find the complete example and learn how to set up and run in the [AWS Code Examples Repository](#).

```

/** Update the environment for a function. */
pub async fn update_function_configuration(
    &self,
    environment: Environment,
) -> Result<UpdateFunctionConfigurationOutput, anyhow::Error> {
    info!(
        ?environment,
        "Updating environment for {}", self.lambda_name
    );
    let updated = self
        .lambda_client
        .update_function_configuration()
        .function_name(self.lambda_name.clone())
        .environment(environment)
        .send()
        .await
        .map_err(anyhow::Error::from)?;

    self.wait_for_function_ready().await?;
}

```

```
Ok(updated)
}
```

- For API details, see [UpdateFunctionConfiguration](#) in *AWS SDK for Rust API reference*.

SAP ABAP

SDK for SAP ABAP

Note

There's more on GitHub. Find the complete example and learn how to set up and run in the [AWS Code Examples Repository](#).

```
TRY.
    oo_result = lo_lmd->updatefunctionconfiguration(      " oo_result is
returned for testing purposes. "
        iv_functionname = iv_function_name
        iv_runtime       = iv_runtime
        iv_description   = 'Updated Lambda function'
        iv_memorysize   = iv_memory_size
    ).

    MESSAGE 'Lambda function configuration/settings updated.' TYPE 'I'.
    CATCH /aws1/cx_lmdcodesigningcfigno00.
    MESSAGE 'Code signing configuration does not exist.' TYPE 'E'.
    CATCH /aws1/cx_lmdcodeverification00.
    MESSAGE 'Code signature failed one or more validation checks for
signature mismatch or expiration.' TYPE 'E'.
    CATCH /aws1/cx_lmdinvalidcodesigex.
    MESSAGE 'Code signature failed the integrity check.' TYPE 'E'.
    CATCH /aws1/cx_lmdinvparamvalueex.
    MESSAGE 'The request contains a non-valid parameter.' TYPE 'E'.
    CATCH /aws1/cx_lmdresourceconflictex.
    MESSAGE 'Resource already exists or another operation is in progress.'
TYPE 'E'.
    CATCH /aws1/cx_lmdresourcenotfoundex.
    MESSAGE 'The requested resource does not exist.' TYPE 'E'.
    CATCH /aws1/cx_lmdserviceexception.
```

```
    MESSAGE 'An internal problem was encountered by the AWS Lambda service.'  
TYPE 'E'.  
    CATCH /aws1/cx_lmdtoomanyrequestsex.  
    MESSAGE 'The maximum request throughput was reached.' TYPE 'E'.  
ENDTRY.
```

- For API details, see [UpdateFunctionConfiguration](#) in *AWS SDK for SAP ABAP API reference*.

For a complete list of AWS SDK developer guides and code examples, see [Using Lambda with an AWS SDK](#). This topic also includes information about getting started and details about previous SDK versions.

Scenarios for Lambda using AWS SDKs

The following code examples show you how to implement common scenarios in Lambda with AWS SDKs. These scenarios show you how to accomplish specific tasks by calling multiple functions within Lambda or combined with other AWS services. Each scenario includes a link to the complete source code, where you can find instructions on how to set up and run the code.

Scenarios target an intermediate level of experience to help you understand service actions in context.

Examples

- [Automatically confirm known Amazon Cognito users with a Lambda function using an AWS SDK](#)
- [Automatically migrate known Amazon Cognito users with a Lambda function using an AWS SDK](#)
- [Create an API Gateway REST API to track COVID-19 data](#)
- [Create a lending library REST API](#)
- [Create a messenger application with Step Functions](#)
- [Create a photo asset management application that lets users manage photos using labels](#)
- [Create a websocket chat application with API Gateway](#)
- [Create an application that analyzes customer feedback and synthesizes audio](#)
- [Invoke a Lambda function from a browser](#)
- [Transform data for your application with S3 Object Lambda](#)
- [Use API Gateway to invoke a Lambda function](#)
- [Use Step Functions to invoke Lambda functions](#)

- [Use scheduled events to invoke a Lambda function](#)
- [Write custom activity data with a Lambda function after Amazon Cognito user authentication using an AWS SDK](#)

Automatically confirm known Amazon Cognito users with a Lambda function using an AWS SDK

The following code examples show how to automatically confirm known Amazon Cognito users with a Lambda function.

- Configure a user pool to call a Lambda function for the PreSignUp trigger.
- Sign up a user with Amazon Cognito.
- The Lambda function scans a DynamoDB table and automatically confirms known users.
- Sign in as the new user, then clean up resources.

Go

SDK for Go V2

Note

There's more on GitHub. Find the complete example and learn how to set up and run in the [AWS Code Examples Repository](#).

Run an interactive scenario at a command prompt.

```
import (  
    "context"  
    "errors"  
    "log"  
    "strings"  
    "user_pools_and_lambda_triggers/actions"  
  
    "github.com/aws/aws-sdk-go-v2/aws"  
    "github.com/aws/aws-sdk-go-v2/service/cognitoidentityprovider"  
    "github.com/aws/aws-sdk-go-v2/service/cognitoidentityprovider/types"
```

```
"github.com/awsdocs/aws-doc-sdk-examples/gov2/demotools"
)

// AutoConfirm separates the steps of this scenario into individual functions so
// that
// they are simpler to read and understand.
type AutoConfirm struct {
    helper      IScenarioHelper
    questioner  demotools.IQuestioner
    resources   Resources
    cognitoActor *actions.CognitoActions
}

// NewAutoConfirm constructs a new auto confirm runner.
func NewAutoConfirm(sdkConfig aws.Config, questioner demotools.IQuestioner,
    helper IScenarioHelper) AutoConfirm {
    scenario := AutoConfirm{
        helper:      helper,
        questioner:  questioner,
        resources:   Resources{},
        cognitoActor: &actions.CognitoActions{CognitoClient:
            cognitoidentityprovider.NewFromConfig(sdkConfig)},
    }
    scenario.resources.init(scenario.cognitoActor, questioner)
    return scenario
}

// AddPreSignUpTrigger adds a Lambda handler as an invocation target for the
// PreSignUp trigger.
func (runner *AutoConfirm) AddPreSignUpTrigger(ctx context.Context, userPoolId
    string, functionArn string) {
    log.Printf("Let's add a Lambda function to handle the PreSignUp trigger from
    Cognito.\n" +
        "This trigger happens when a user signs up, and lets your function take action
    before the main Cognito\n" +
        "sign up processing occurs.\n")
    err := runner.cognitoActor.UpdateTriggers(
        ctx, userPoolId,
        actions.TriggerInfo{Trigger: actions.PreSignUp, HandlerArn:
            aws.String(functionArn)})
    if err != nil {
        panic(err)
    }
}
```

```
log.Printf("Lambda function %v added to user pool %v to handle the PreSignUp
trigger.\n",
    functionArn, userPoolId)
}

// SignUpUser signs up a user from the known user table with a password you
specify.
func (runner *AutoConfirm) SignUpUser(ctx context.Context, clientId string,
usersTable string) (string, string) {
log.Println("Let's sign up a user to your Cognito user pool. When the user's
email matches an email in the\n" +
    "DynamoDB known users table, it is automatically verified and the user is
confirmed.")

knownUsers, err := runner.helper.GetKnownUsers(ctx, usersTable)
if err != nil {
    panic(err)
}
userChoice := runner.questioner.AskChoice("Which user do you want to use?\n",
knownUsers.UserNameList())
user := knownUsers.Users[userChoice]

var signedUp bool
var userConfirmed bool
password := runner.questioner.AskPassword("Enter a password that has at least
eight characters, uppercase, lowercase, numbers and symbols.\n"+
    "(the password will not display as you type):", 8)
for !signedUp {
    log.Printf("Signing up user '%v' with email '%v' to Cognito.\n", user.UserName,
user.UserEmail)
    userConfirmed, err = runner.cognitoActor.SignUp(ctx, clientId, user.UserName,
password, user.UserEmail)
    if err != nil {
        var invalidPassword *types.InvalidPasswordException
        if errors.As(err, &invalidPassword) {
            password = runner.questioner.AskPassword("Enter another password:", 8)
        } else {
            panic(err)
        }
    } else {
        signedUp = true
    }
}
log.Printf("User %v signed up, confirmed = %v.\n", user.UserName, userConfirmed)
```

```
log.Println(strings.Repeat("-", 88))

return user.UserName, password
}

// SignInUser signs in a user.
func (runner *AutoConfirm) SignInUser(ctx context.Context, clientId string,
  userName string, password string) string {
  runner.questioner.Ask("Press Enter when you're ready to continue.")
  log.Printf("Let's sign in as %v...\n", userName)
  authResult, err := runner.cognitoActor.SignIn(ctx, clientId, userName, password)
  if err != nil {
    panic(err)
  }
  log.Printf("Successfully signed in. Your access token starts with: %v...\n",
    (*authResult.AccessToken)[:10])
  log.Println(strings.Repeat("-", 88))
  return *authResult.AccessToken
}

// Run runs the scenario.
func (runner *AutoConfirm) Run(ctx context.Context, stackName string) {
  defer func() {
    if r := recover(); r != nil {
      log.Println("Something went wrong with the demo.")
      runner.resources.Cleanup(ctx)
    }
  }()

  log.Println(strings.Repeat("-", 88))
  log.Printf("Welcome\n")

  log.Println(strings.Repeat("-", 88))

  stackOutputs, err := runner.helper.GetStackOutputs(ctx, stackName)
  if err != nil {
    panic(err)
  }
  runner.resources.userPoolId = stackOutputs["UserPoolId"]
  runner.helper.PopulateUserTable(ctx, stackOutputs["TableName"])

  runner.AddPreSignUpTrigger(ctx, stackOutputs["UserPoolId"],
    stackOutputs["AutoConfirmFunctionArn"])
```



```

runner.resources.triggers = append(runner.resources.triggers, actions.PreSignUp)
userName, password := runner.SignUpUser(ctx, stackOutputs["UserPoolClientId"],
stackOutputs["TableName"])
runner.helper.ListRecentLogEvents(ctx, stackOutputs["AutoConfirmFunction"])
runner.resources.userAccessTokens = append(runner.resources.userAccessTokens,
runner.SignInUser(ctx, stackOutputs["UserPoolClientId"], userName, password))

runner.resources.Cleanup(ctx)

log.Println(strings.Repeat("-", 88))
log.Println("Thanks for watching!")
log.Println(strings.Repeat("-", 88))
}

```

Handle the PreSignUp trigger with a Lambda function.

```

import (
    "context"
    "log"
    "os"

    "github.com/aws/aws-lambda-go/events"
    "github.com/aws/aws-lambda-go/lambda"
    "github.com/aws/aws-sdk-go-v2/aws"
    "github.com/aws/aws-sdk-go-v2/config"
    "github.com/aws/aws-sdk-go-v2/feature/dynamodb/attributevalue"
    "github.com/aws/aws-sdk-go-v2/service/dynamodb"
    dynamodbtypes "github.com/aws/aws-sdk-go-v2/service/dynamodb/types"
)

const TABLE_NAME = "TABLE_NAME"

// UserInfo defines structured user data that can be marshalled to a DynamoDB
// format.
type UserInfo struct {
    UserName string `dynamodbav:"UserName"`
    UserEmail string `dynamodbav:"UserEmail"`
}

// GetKey marshals the user email value to a DynamoDB key format.

```

```
func (user UserInfo) GetKey() map[string]dynamodbtypes.AttributeValue {
    userEmail, err := attributevalue.Marshal(user.UserEmail)
    if err != nil {
        panic(err)
    }
    return map[string]dynamodbtypes.AttributeValue{"UserEmail": userEmail}
}

type handler struct {
    dynamoClient *dynamodb.Client
}

// HandleRequest handles the PreSignUp event by looking up a user in an Amazon
// DynamoDB table and
// specifying whether they should be confirmed and verified.
func (h *handler) HandleRequest(ctx context.Context, event
events.CognitoEventUserPoolsPreSignup) (events.CognitoEventUserPoolsPreSignup,
error) {
    log.Printf("Received presignup from %v for user '%v'", event.TriggerSource,
event.UserName)
    if event.TriggerSource != "PreSignUp_SignUp" {
        // Other trigger sources, such as PreSignUp_AdminInitiateAuth, ignore the
        // response from this handler.
        return event, nil
    }
    tableName := os.Getenv(TABLE_NAME)
    user := UserInfo{
        UserEmail: event.Request.UserAttributes["email"],
    }
    log.Printf("Looking up email %v in table %v.\n", user.UserEmail, tableName)
    output, err := h.dynamoClient.GetItem(ctx, &dynamodb.GetItemInput{
        Key:      user.GetKey(),
        TableName: aws.String(tableName),
    })
    if err != nil {
        log.Printf("Error looking up email %v.\n", user.UserEmail)
        return event, err
    }
    if output.Item == nil {
        log.Printf("Email %v not found. Email verification is required.\n",
user.UserEmail)
        return event, err
    }
}
```

```

err = attributevalue.UnmarshalMap(output.Item, &user)
if err != nil {
    log.Printf("Couldn't unmarshal DynamoDB item. Here's why: %v\n", err)
    return event, err
}

if user.UserName != event.UserName {
    log.Printf("UserEmail %v found, but stored UserName '%v' does not match
supplied UserName '%v'. Verification is required.\n",
    user.UserEmail, user.UserName, event.UserName)
} else {
    log.Printf("UserEmail %v found with matching UserName %v. User is confirmed.
\n", user.UserEmail, user.UserName)
    event.Response.AutoConfirmUser = true
    event.Response.AutoVerifyEmail = true
}

return event, err
}

func main() {
    ctx := context.Background()
    sdkConfig, err := config.LoadDefaultConfig(ctx)
    if err != nil {
        log.Panicln(err)
    }
    h := handler{
        dynamoClient: dynamodb.NewFromConfig(sdkConfig),
    }
    lambda.Start(h.HandleRequest)
}

```

Create a struct that performs common tasks.

```

import (
    "context"
    "log"
    "strings"
    "time"
    "user_pools_and_lambda_triggers/actions"

```

```

"github.com/aws/aws-sdk-go-v2/aws"
"github.com/aws/aws-sdk-go-v2/service/cloudformation"
"github.com/aws/aws-sdk-go-v2/service/cloudwatchlogs"
"github.com/aws/aws-sdk-go-v2/service/dynamodb"
"github.com/awsdocs/aws-doc-sdk-examples/gov2/demotools"
)

// IScenarioHelper defines common functions used by the workflows in this
// example.
type IScenarioHelper interface {
    Pause(secs int)
    GetStackOutputs(ctx context.Context, stackName string) (actions.StackOutputs,
    error)
    PopulateUserTable(ctx context.Context, tableName string)
    GetKnownUsers(ctx context.Context, tableName string) (actions.UserList, error)
    AddKnownUser(ctx context.Context, tableName string, user actions.User)
    ListRecentLogEvents(ctx context.Context, functionName string)
}

// ScenarioHelper contains AWS wrapper structs used by the workflows in this
// example.
type ScenarioHelper struct {
    questioner demotools.IQuestioner
    dynamoActor *actions.DynamoActions
    cfnActor     *actions.CloudFormationActions
    cwlActor     *actions.CloudWatchLogsActions
    isTestRun   bool
}

// NewScenarioHelper constructs a new scenario helper.
func NewScenarioHelper(sdkConfig aws.Config, questioner demotools.IQuestioner)
ScenarioHelper {
    scenario := ScenarioHelper{
        questioner: questioner,
        dynamoActor: &actions.DynamoActions{DynamoClient:
        dynamodb.NewFromConfig(sdkConfig)},
        cfnActor:     &actions.CloudFormationActions{CfnClient:
        cloudformation.NewFromConfig(sdkConfig)},
        cwlActor:     &actions.CloudWatchLogsActions{CwlClient:
        cloudwatchlogs.NewFromConfig(sdkConfig)},
    }
    return scenario
}

```

```
// Pause waits for the specified number of seconds.
func (helper ScenarioHelper) Pause(secs int) {
    if !helper.isTestRun {
        time.Sleep(time.Duration(secs) * time.Second)
    }
}

// GetStackOutputs gets the outputs from the specified CloudFormation stack in a
// structured format.
func (helper ScenarioHelper) GetStackOutputs(ctx context.Context, stackName
    string) (actions.StackOutputs, error) {
    return helper.cfnActor.GetOutputs(ctx, stackName), nil
}

// PopulateUserTable fills the known user table with example data.
func (helper ScenarioHelper) PopulateUserTable(ctx context.Context, tableName
    string) {
    log.Printf("First, let's add some users to the DynamoDB %v table we'll use for
        this example.\n", tableName)
    err := helper.dynamoActor.PopulateTable(ctx, tableName)
    if err != nil {
        panic(err)
    }
}

// GetKnownUsers gets the users from the known users table in a structured
// format.
func (helper ScenarioHelper) GetKnownUsers(ctx context.Context, tableName string)
    (actions.UserList, error) {
    knownUsers, err := helper.dynamoActor.Scan(ctx, tableName)
    if err != nil {
        log.Printf("Couldn't get known users from table %v. Here's why: %v\n",
            tableName, err)
    }
    return knownUsers, err
}

// AddKnownUser adds a user to the known users table.
func (helper ScenarioHelper) AddKnownUser(ctx context.Context, tableName string,
    user actions.User) {
    log.Printf("Adding user '%v' with email '%v' to the DynamoDB known users
        table...\n",
        user.UserName, user.UserEmail)
```

```

err := helper.dynamoActor.AddUser(ctx, tableName, user)
if err != nil {
    panic(err)
}
}

// ListRecentLogEvents gets the most recent log stream and events for the
// specified Lambda function and displays them.
func (helper ScenarioHelper) ListRecentLogEvents(ctx context.Context,
functionName string) {
    log.Println("Waiting a few seconds to let Lambda write to CloudWatch Logs...")
    helper.Pause(10)
    log.Println("Okay, let's check the logs to find what's happened recently with
your Lambda function.")
    logStream, err := helper.cwlActor.GetLatestLogStream(ctx, functionName)
    if err != nil {
        panic(err)
    }
    log.Printf("Getting some recent events from log stream %v\n",
*logStream.LogStreamName)
    events, err := helper.cwlActor.GetLogEvents(ctx, functionName,
*logStream.LogStreamName, 10)
    if err != nil {
        panic(err)
    }
    for _, event := range events {
        log.Printf("\t%v", *event.Message)
    }
    log.Println(strings.Repeat("-", 88))
}

```

Create a struct that wraps Amazon Cognito actions.

```

import (
    "context"
    "errors"
    "log"

    "github.com/aws/aws-sdk-go-v2/aws"
    "github.com/aws/aws-sdk-go-v2/service/cognitoidentityprovider"

```

```
"github.com/aws/aws-sdk-go-v2/service/cognitoidentityprovider/types"
)

type CognitoActions struct {
    CognitoClient *cognitoidentityprovider.Client
}

// Trigger and TriggerInfo define typed data for updating an Amazon Cognito
// trigger.
type Trigger int

const (
    PreSignUp Trigger = iota
    UserMigration
    PostAuthentication
)

type TriggerInfo struct {
    Trigger    Trigger
    HandlerArn *string
}

// UpdateTriggers adds or removes Lambda triggers for a user pool. When a trigger
// is specified with a `nil` value,
// it is removed from the user pool.
func (actor CognitoActions) UpdateTriggers(ctx context.Context, userPoolId
string, triggers ...TriggerInfo) error {
    output, err := actor.CognitoClient.DescribeUserPool(ctx,
&cognitoidentityprovider.DescribeUserPoolInput{
    UserPoolId: aws.String(userPoolId),
})
    if err != nil {
        log.Printf("Couldn't get info about user pool %v. Here's why: %v\n",
userPoolId, err)
        return err
    }
    lambdaConfig := output.UserPool.LambdaConfig
    for _, trigger := range triggers {
        switch trigger.Trigger {
        case PreSignUp:
            lambdaConfig.PreSignUp = trigger.HandlerArn
        case UserMigration:
```

```

    lambdaConfig.UserMigration = trigger.HandlerArn
    case PostAuthentication:
        lambdaConfig.PostAuthentication = trigger.HandlerArn
    }
}
_, err = actor.CognitoClient.UpdateUserPool(ctx,
&cognitoidentityprovider.UpdateUserPoolInput{
    UserPoolId:  aws.String(userPoolId),
    LambdaConfig: lambdaConfig,
})
if err != nil {
    log.Printf("Couldn't update user pool %v. Here's why: %v\n", userPoolId, err)
}
return err
}

// SignUp signs up a user with Amazon Cognito.
func (actor CognitoActions) SignUp(ctx context.Context, clientId string, userName
string, password string, userEmail string) (bool, error) {
    confirmed := false
    output, err := actor.CognitoClient.SignUp(ctx,
&cognitoidentityprovider.SignUpInput{
        ClientId: aws.String(clientId),
        Password: aws.String(password),
        Username: aws.String(userName),
        UserAttributes: []types.AttributeType{
            {Name: aws.String("email"), Value: aws.String(userEmail)},
        },
    })
    if err != nil {
        var invalidPassword *types.InvalidPasswordException
        if errors.As(err, &invalidPassword) {
            log.Println(*invalidPassword.Message)
        } else {
            log.Printf("Couldn't sign up user %v. Here's why: %v\n", userName, err)
        }
    } else {
        confirmed = output.UserConfirmed
    }
    return confirmed, err
}

```



```
// SignIn signs in a user to Amazon Cognito using a username and password
authentication flow.
func (actor CognitoActions) SignIn(ctx context.Context, clientId string, userName
string, password string) (*types.AuthenticationResultType, error) {
var authResult *types.AuthenticationResultType
output, err := actor.CognitoClient.InitiateAuth(ctx,
&cognitoidentityprovider.InitiateAuthInput{
AuthFlow:      "USER_PASSWORD_AUTH",
ClientId:      aws.String(clientId),
AuthParameters: map[string]string{"USERNAME": userName, "PASSWORD": password},
})
if err != nil {
var resetRequired *types.PasswordResetRequiredException
if errors.As(err, &resetRequired) {
log.Println(*resetRequired.Message)
} else {
log.Printf("Couldn't sign in user %v. Here's why: %v\n", userName, err)
}
} else {
authResult = output.AuthenticationResult
}
return authResult, err
}

// ForgotPassword starts a password recovery flow for a user. This flow typically
sends a confirmation code
// to the user's configured notification destination, such as email.
func (actor CognitoActions) ForgotPassword(ctx context.Context, clientId string,
userName string) (*types.CodeDeliveryDetailsType, error) {
output, err := actor.CognitoClient.ForgotPassword(ctx,
&cognitoidentityprovider.ForgotPasswordInput{
ClientId: aws.String(clientId),
Username: aws.String(userName),
})
if err != nil {
log.Printf("Couldn't start password reset for user '%v'. Here;s why: %v\n",
userName, err)
}
return output.CodeDeliveryDetails, err
}
```

```
// ConfirmForgotPassword confirms a user with a confirmation code and a new
password.
func (actor CognitoActions) ConfirmForgotPassword(ctx context.Context, clientId
string, code string, userName string, password string) error {
    _, err := actor.CognitoClient.ConfirmForgotPassword(ctx,
&cognitoidentityprovider.ConfirmForgotPasswordInput{
    ClientId:      aws.String(clientId),
    ConfirmationCode: aws.String(code),
    Password:      aws.String(password),
    Username:      aws.String(userName),
})
    if err != nil {
        var invalidPassword *types.InvalidPasswordException
        if errors.As(err, &invalidPassword) {
            log.Println(*invalidPassword.Message)
        } else {
            log.Printf("Couldn't confirm user %v. Here's why: %v", userName, err)
        }
    }
    return err
}

// DeleteUser removes a user from the user pool.
func (actor CognitoActions) DeleteUser(ctx context.Context, userAccessToken
string) error {
    _, err := actor.CognitoClient.DeleteUser(ctx,
&cognitoidentityprovider.DeleteUserInput{
    AccessToken: aws.String(userAccessToken),
})
    if err != nil {
        log.Printf("Couldn't delete user. Here's why: %v\n", err)
    }
    return err
}

// AdminCreateUser uses administrator credentials to add a user to a user pool.
This method leaves the user
```

```
// in a state that requires they enter a new password next time they sign in.
func (actor CognitoActions) AdminCreateUser(ctx context.Context, userPoolId
string, userName string, userEmail string) error {
    _, err := actor.CognitoClient.AdminCreateUser(ctx,
    &cognitoidentityprovider.AdminCreateUserInput{
        UserPoolId:    aws.String(userPoolId),
        Username:      aws.String(userName),
        MessageAction: types.MessageActionTypeSuppress,
        UserAttributes: []types.AttributeType{{Name: aws.String("email"), Value:
aws.String(userEmail)}}},
    })
    if err != nil {
        var userExists *types.UsernameExistsException
        if errors.As(err, &userExists) {
            log.Printf("User %v already exists in the user pool.", userName)
            err = nil
        } else {
            log.Printf("Couldn't create user %v. Here's why: %v\n", userName, err)
        }
    }
    return err
}

// AdminSetUserPassword uses administrator credentials to set a password for a
// user without requiring a
// temporary password.
func (actor CognitoActions) AdminSetUserPassword(ctx context.Context, userPoolId
string, userName string, password string) error {
    _, err := actor.CognitoClient.AdminSetUserPassword(ctx,
    &cognitoidentityprovider.AdminSetUserPasswordInput{
        Password:    aws.String(password),
        UserPoolId: aws.String(userPoolId),
        Username:    aws.String(userName),
        Permanent:  true,
    })
    if err != nil {
        var invalidPassword *types.InvalidPasswordException
        if errors.As(err, &invalidPassword) {
            log.Println(*invalidPassword.Message)
        } else {
            log.Printf("Couldn't set password for user %v. Here's why: %v\n", userName,
err)
        }
    }
}
```

```

    }
  }
  return err
}

```

Create a struct that wraps DynamoDB actions.

```

import (
    "context"
    "fmt"
    "log"

    "github.com/aws/aws-sdk-go-v2/aws"
    "github.com/aws/aws-sdk-go-v2/feature/dynamodb/attributevalue"
    "github.com/aws/aws-sdk-go-v2/service/dynamodb"
    "github.com/aws/aws-sdk-go-v2/service/dynamodb/types"
)

// DynamoActions encapsulates the Amazon Simple Notification Service (Amazon SNS)
// actions
// used in the examples.
type DynamoActions struct {
    DynamoClient *dynamodb.Client
}

// User defines structured user data.
type User struct {
    UserName    string
    UserEmail  string
    LastLogin  *LoginInfo `dynamodbav:",omitempty"`
}

// LoginInfo defines structured custom login data.
type LoginInfo struct {
    UserPoolId string
    ClientId   string
    Time      string
}

// UserList defines a list of users.

```

```
type UserList struct {
    Users []User
}

// UserNameList returns the usernames contained in a UserList as a list of
strings.
func (users *UserList) UserNameList() []string {
    names := make([]string, len(users.Users))
    for i := 0; i < len(users.Users); i++ {
        names[i] = users.Users[i].UserName
    }
    return names
}

// PopulateTable adds a set of test users to the table.
func (actor DynamoActions) PopulateTable(ctx context.Context, tableName string)
error {
    var err error
    var item map[string]types.AttributeValue
    var writeReqs []types.WriteRequest
    for i := 1; i < 4; i++ {
        item, err = attributevalue.MarshalMap(User{UserName: fmt.Sprintf("test_user_
        %v", i), userEmail: fmt.Sprintf("test_email_%v@example.com", i)})
        if err != nil {
            log.Printf("Couldn't marshall user into DynamoDB format. Here's why: %v\n",
            err)
            return err
        }
        writeReqs = append(writeReqs, types.WriteRequest{PutRequest:
        &types.PutRequest{Item: item}})
    }
    _, err = actor.DynamoClient.BatchWriteItem(ctx, &dynamodb.BatchWriteItemInput{
    RequestItems: map[string][]types.WriteRequest{tableName: writeReqs},
    })
    if err != nil {
        log.Printf("Couldn't populate table %v with users. Here's why: %v\n",
        tableName, err)
    }
    return err
}

// Scan scans the table for all items.
func (actor DynamoActions) Scan(ctx context.Context, tableName string) (UserList,
error) {
```

```

var userList UserList
output, err := actor.DynamoClient.Scan(ctx, &dynamodb.ScanInput{
    TableName: aws.String(tableName),
})
if err != nil {
    log.Printf("Couldn't scan table %v for items. Here's why: %v\n", tableName,
err)
} else {
    err = attributevalue.UnmarshalListOfMaps(output.Items, &userList.Users)
    if err != nil {
        log.Printf("Couldn't unmarshal items into users. Here's why: %v\n", err)
    }
}
return userList, err
}

// AddUser adds a user item to a table.
func (actor DynamoActions) AddUser(ctx context.Context, tableName string, user
User) error {
    userItem, err := attributevalue.MarshalMap(user)
    if err != nil {
        log.Printf("Couldn't marshall user to item. Here's why: %v\n", err)
    }
    _, err = actor.DynamoClient.PutItem(ctx, &dynamodb.PutItemInput{
        Item:      userItem,
        TableName: aws.String(tableName),
    })
    if err != nil {
        log.Printf("Couldn't put item in table %v. Here's why: %v", tableName, err)
    }
    return err
}

```

Create a struct that wraps CloudWatch Logs actions.

```

import (
    "context"
    "fmt"
    "log"

```

```

"github.com/aws/aws-sdk-go-v2/aws"
"github.com/aws/aws-sdk-go-v2/service/cloudwatchlogs"
"github.com/aws/aws-sdk-go-v2/service/cloudwatchlogs/types"
)

type CloudWatchLogsActions struct {
    CwlClient *cloudwatchlogs.Client
}

// GetLatestLogStream gets the most recent log stream for a Lambda function.
func (actor CloudWatchLogsActions) GetLatestLogStream(ctx context.Context,
    functionName string) (types.LogStream, error) {
    var logStream types.LogStream
    logGroupName := fmt.Sprintf("/aws/lambda/%s", functionName)
    output, err := actor.CwlClient.DescribeLogStreams(ctx,
        &cloudwatchlogs.DescribeLogStreamsInput{
            Descending:    aws.Bool(true),
            Limit:         aws.Int32(1),
            LogGroupName: aws.String(logGroupName),
            OrderBy:      types.OrderByLastEventTime,
        })
    if err != nil {
        log.Printf("Couldn't get log streams for log group %v. Here's why: %v\n",
            logGroupName, err)
    } else {
        logStream = output.LogStreams[0]
    }
    return logStream, err
}

// GetLogEvents gets the most recent eventCount events from the specified log
// stream.
func (actor CloudWatchLogsActions) GetLogEvents(ctx context.Context, functionName
    string, logStreamName string, eventCount int32) (
    []types.OutputLogEvent, error) {
    var events []types.OutputLogEvent
    logGroupName := fmt.Sprintf("/aws/lambda/%s", functionName)
    output, err := actor.CwlClient.GetLogEvents(ctx,
        &cloudwatchlogs.GetLogEventsInput{
            LogStreamName: aws.String(logStreamName),
            Limit:         aws.Int32(eventCount),
            LogGroupName: aws.String(logGroupName),
        })
    if err != nil {

```

```

    log.Printf("Couldn't get log event for log stream %v. Here's why: %v\n",
logStreamName, err)
} else {
    events = output.Events
}
return events, err
}

```

Create a struct that wraps AWS CloudFormation actions.

```

import (
    "context"
    "log"

    "github.com/aws/aws-sdk-go-v2/aws"
    "github.com/aws/aws-sdk-go-v2/service/cloudformation"
)

// StackOutputs defines a map of outputs from a specific stack.
type StackOutputs map[string]string

type CloudFormationActions struct {
    CfnClient *cloudformation.Client
}

// GetOutputs gets the outputs from a CloudFormation stack and puts them into a
structured format.
func (actor CloudFormationActions) GetOutputs(ctx context.Context, stackName
string) StackOutputs {
    output, err := actor.CfnClient.DescribeStacks(ctx,
&cloudformation.DescribeStacksInput{
        StackName: aws.String(stackName),
    })
    if err != nil || len(output.Stacks) == 0 {
        log.Panicf("Couldn't find a CloudFormation stack named %v. Here's why: %v\n",
stackName, err)
    }
    stackOutputs := StackOutputs{}
    for _, out := range output.Stacks[0].Outputs {
        stackOutputs[*out.OutputKey] = *out.OutputValue
    }
}

```



```

}
return stackOutputs
}

```

Clean up resources.

```

import (
    "context"
    "log"
    "user_pools_and_lambda_triggers/actions"

    "github.com/awsdocs/aws-doc-sdk-examples/gov2/demotools"
)

// Resources keeps track of AWS resources created during an example and handles
// cleanup when the example finishes.
type Resources struct {
    userPoolId      string
    userAccessTokens []string
    triggers        []actions.Trigger

    cognitoActor *actions.CognitoActions
    questioner   demotools.IQuestioner
}

func (resources *Resources) init(cognitoActor *actions.CognitoActions, questioner
demotools.IQuestioner) {
    resources.userAccessTokens = []string{}
    resources.triggers = []actions.Trigger{}
    resources.cognitoActor = cognitoActor
    resources.questioner = questioner
}

// Cleanup deletes all AWS resources created during an example.
func (resources *Resources) Cleanup(ctx context.Context) {
    defer func() {
        if r := recover(); r != nil {
            log.Printf("Something went wrong during cleanup.\n%v\n", r)
            log.Println("Use the AWS Management Console to remove any remaining resources
\n" +

```

```
    "that were created for this scenario.")
}
}()

wantDelete := resources.questioner.AskBool("Do you want to remove all of the AWS
resources that were created "+
"during this demo (y/n)?", "y")
if wantDelete {
    for _, accessToken := range resources.userAccessTokens {
        err := resources.cognitoActor.DeleteUser(ctx, accessToken)
        if err != nil {
            log.Println("Couldn't delete user during cleanup.")
            panic(err)
        }
        log.Println("Deleted user.")
    }
    triggerList := make([]actions.TriggerInfo, len(resources.triggers))
    for i := 0; i < len(resources.triggers); i++ {
        triggerList[i] = actions.TriggerInfo{Trigger: resources.triggers[i],
HandlerArn: nil}
    }
    err := resources.cognitoActor.UpdateTriggers(ctx, resources.userPoolId,
triggerList...)
    if err != nil {
        log.Println("Couldn't update Cognito triggers during cleanup.")
        panic(err)
    }
    log.Println("Removed Cognito triggers from user pool.")
} else {
    log.Println("Be sure to remove resources when you're done with them to avoid
unexpected charges!")
}
}
```

- For API details, see the following topics in *AWS SDK for Go API Reference*.
 - [DeleteUser](#)
 - [InitiateAuth](#)
 - [SignUp](#)
 - [UpdateUserPool](#)

JavaScript

SDK for JavaScript (v3)

Note

There's more on GitHub. Find the complete example and learn how to set up and run in the [AWS Code Examples Repository](#).

Configure an interactive "Scenario" run. The JavaScript (v3) examples share a Scenario runner to streamline complex examples. The complete source code is on GitHub.

```
import { AutoConfirm } from "./scenario-auto-confirm.js";

/**
 * The context is passed to every scenario. Scenario steps
 * will modify the context.
 */
const context = {
  errors: [],
  users: [
    {
      UserName: "test_user_1",
      UserEmail: "test_email_1@example.com",
    },
    {
      UserName: "test_user_2",
      UserEmail: "test_email_2@example.com",
    },
    {
      UserName: "test_user_3",
      UserEmail: "test_email_3@example.com",
    },
  ],
};

/**
 * Three Scenarios are created for the workflow. A Scenario is an orchestration
 * class
 * that simplifies running a series of steps.
 */
```

```

export const scenarios = {
  // Demonstrate automatically confirming known users in a database.
  "auto-confirm": AutoConfirm(context),
};

// Call function if run directly
import { fileURLToPath } from "node:url";
import { parseScenarioArgs } from "@aws-doc-sdk-examples/lib/scenario/index.js";

if (process.argv[1] === fileURLToPath(import.meta.url)) {
  parseScenarioArgs(scenarios, {
    name: "Cognito user pools and triggers",
    description:
      "Demonstrate how to use the AWS SDKs to customize Amazon Cognito authentication behavior.",
  });
}

```

This Scenario demonstrates auto-confirming a known user. It orchestrates the example steps.

```

import { wait } from "@aws-doc-sdk-examples/lib/utils/util-timers.js";
import {
  Scenario,
  ScenarioAction,
  ScenarioInput,
  ScenarioOutput,
} from "@aws-doc-sdk-examples/lib/scenario/scenario.js";

import {
  getStackOutputs,
  logCleanupReminder,
  promptForStackName,
  promptForStackRegion,
  skipWhenErrors,
} from "./steps-common.js";
import { populateTable } from "./actions/dynamodb-actions.js";
import {
  addPreSignUpHandler,
  deleteUser,
  getUser,
  signIn,

```

```

    signUpUser,
  } from "./actions/cognito-actions.js";
import {
  getLatestLogStreamForLambda,
  getLogEvents,
} from "./actions/cloudwatch-logs-actions.js";

/**
 * @typedef {{
 *   errors: Error[],
 *   password: string,
 *   users: { Username: string, UserEmail: string }[],
 *   selectedUser?: string,
 *   stackName?: string,
 *   stackRegion?: string,
 *   token?: string,
 *   confirmDeleteSignedInUser?: boolean,
 *   TableName?: string,
 *   UserPoolClientId?: string,
 *   UserPoolId?: string,
 *   UserPoolArn?: string,
 *   AutoConfirmHandlerArn?: string,
 *   AutoConfirmHandlerName?: string
 * }} State
 */

const greeting = new ScenarioOutput(
  "greeting",
  (/** @type {State} */ state) => `This demo will populate some users into the \
database created as part of the "${state.stackName}" stack. \
Then the autoConfirmHandler will be linked to the PreSignUp \
trigger from Cognito. Finally, you will choose a user to sign up.` ,
  { skipWhen: skipWhenErrors },
);

const logPopulatingUsers = new ScenarioOutput(
  "logPopulatingUsers",
  "Populating the DynamoDB table with some users.",
  { skipWhenErrors: skipWhenErrors },
);

const logPopulatingUsersComplete = new ScenarioOutput(
  "logPopulatingUsersComplete",
  "Done populating users.",

```

```
    { skipWhen: skipWhenErrors },
  );

const populateUsers = new ScenarioAction(
  "populateUsers",
  async (** @type {State} */ state) => {
    const [_, err] = await populateTable({
      region: state.stackRegion,
      tableName: state.TableName,
      items: state.users,
    });
    if (err) {
      state.errors.push(err);
    }
  },
  {
    skipWhen: skipWhenErrors,
  },
);

const logSetupSignUpTrigger = new ScenarioOutput(
  "logSetupSignUpTrigger",
  "Setting up the PreSignUp trigger for the Cognito User Pool.",
  { skipWhen: skipWhenErrors },
);

const setupSignUpTrigger = new ScenarioAction(
  "setupSignUpTrigger",
  async (** @type {State} */ state) => {
    const [_, err] = await addPreSignUpHandler({
      region: state.stackRegion,
      userPoolId: state.UserPoolId,
      handlerArn: state.AutoConfirmHandlerArn,
    });
    if (err) {
      state.errors.push(err);
    }
  },
  {
    skipWhen: skipWhenErrors,
  },
);

const logSetupSignUpTriggerComplete = new ScenarioOutput(
```

```
"logSetupSignUpTriggerComplete",
(
  /** @type {State} */ state,
) => `The lambda function "${state.AutoConfirmHandlerName}" \
has been configured as the PreSignUp trigger handler for the user pool
"${state.UserPoolId}".`,
{ skipWhen: skipWhenErrors },
);

const selectUser = new ScenarioInput(
  "selectedUser",
  "Select a user to sign up.",
  {
    type: "select",
    choices: (/** @type {State} */ state) => state.users.map((u) => u.UserName),
    skipWhen: skipWhenErrors,
    default: (/** @type {State} */ state) => state.users[0].UserName,
  },
);

const checkIfUserAlreadyExists = new ScenarioAction(
  "checkIfUserAlreadyExists",
  async (/** @type {State} */ state) => {
    const [user, err] = await getUser({
      region: state.stackRegion,
      userPoolId: state.UserPoolId,
      username: state.selectedUser,
    });

    if (err?.name === "UserNotFoundException") {
      // Do nothing. We're not expecting the user to exist before
      // sign up is complete.
      return;
    }

    if (err) {
      state.errors.push(err);
      return;
    }

    if (user) {
      state.errors.push(
        new Error(
```

```

        `The user "${state.selectedUser}" already exists in the user pool
        "${state.UserPoolId}".`,
        ),
    );
}
},
{
    skipWhen: skipWhenErrors,
},
);

const createPassword = new ScenarioInput(
    "password",
    "Enter a password that has at least eight characters, uppercase, lowercase,
    numbers and symbols.",
    { type: "password", skipWhen: skipWhenErrors, default: "Abcd1234!" },
);

const logSignUpExistingUser = new ScenarioOutput(
    "logSignUpExistingUser",
    (/** @type {State} */ state) => `Signing up user "${state.selectedUser}".`,
    { skipWhen: skipWhenErrors },
);

const signUpExistingUser = new ScenarioAction(
    "signUpExistingUser",
    async (/** @type {State} */ state) => {
        const signUp = (password) =>
            signUpUser({
                region: state.stackRegion,
                userPoolClientId: state.UserPoolClientId,
                username: state.selectedUser,
                email: state.users.find((u) => u.UserName === state.selectedUser)
                    .UserEmail,
                password,
            });

        let [_, err] = await signUp(state.password);

        while (err?.name === "InvalidPasswordException") {
            console.warn("The password you entered was invalid.");
            await createPassword.handle(state);
            [_, err] = await signUp(state.password);
        }
    }
);

```



```
    if (err) {
      state.errors.push(err);
    }
  },
  { skipWhen: skipWhenErrors },
);

const logSignUpExistingUserComplete = new ScenarioOutput(
  "logSignUpExistingUserComplete",
  (/** @type {State} */ state) =>
    `_${state.selectedUser} was signed up successfully.` ,
  { skipWhen: skipWhenErrors },
);

const logLambdaLogs = new ScenarioAction(
  "logLambdaLogs",
  async (/** @type {State} */ state) => {
    console.log(
      "Waiting a few seconds to let Lambda write to CloudWatch Logs...\n",
    );
    await wait(10);

    const [logStream, logStreamErr] = await getLatestLogStreamForLambda({
      functionName: state.AutoConfirmHandlerName,
      region: state.stackRegion,
    });
    if (logStreamErr) {
      state.errors.push(logStreamErr);
      return;
    }

    console.log(
      `Getting some recent events from log stream "${logStream.logStreamName}"`,
    );
    const [logEvents, logEventsErr] = await getLogEvents({
      functionName: state.AutoConfirmHandlerName,
      region: state.stackRegion,
      eventCount: 10,
      logStreamName: logStream.logStreamName,
    });
    if (logEventsErr) {
      state.errors.push(logEventsErr);
      return;
    }
  }
);
```

```
    }

    console.log(logEvents.map((ev) => `\t${ev.message}`).join(""));
  },
  { skipWhen: skipWhenErrors },
);

const logSignInUser = new ScenarioOutput(
  "logSignInUser",
  (/** @type {State} */ state) => `Let's sign in as ${state.selectedUser}`,
  { skipWhen: skipWhenErrors },
);

const signInUser = new ScenarioAction(
  "signInUser",
  async (/** @type {State} */ state) => {
    const [response, err] = await signIn({
      region: state.stackRegion,
      clientId: state.UserPoolClientId,
      username: state.selectedUser,
      password: state.password,
    });

    if (err?.name === "PasswordResetRequiredException") {
      state.errors.push(new Error("Please reset your password."));
      return;
    }

    if (err) {
      state.errors.push(err);
      return;
    }

    state.token = response?.AuthenticationResult?.AccessToken;
  },
  { skipWhen: skipWhenErrors },
);

const logSignInUserComplete = new ScenarioOutput(
  "logSignInUserComplete",
  (/** @type {State} */ state) =>
    `Successfully signed in. Your access token starts with:
${state.token.slice(0, 11)}`,
  { skipWhen: skipWhenErrors },
);
```

```
);

const confirmDeleteSignedInUser = new ScenarioInput(
  "confirmDeleteSignedInUser",
  "Do you want to delete the currently signed in user?",
  { type: "confirm", skipWhen: skipWhenErrors },
);

const deleteSignedInUser = new ScenarioAction(
  "deleteSignedInUser",
  async (** @type {State} */ state) => {
    const [, err] = await deleteUser({
      region: state.stackRegion,
      accessToken: state.token,
    });

    if (err) {
      state.errors.push(err);
    }
  },
  {
    skipWhen: (** @type {State} */ state) =>
      skipWhenErrors(state) || !state.confirmDeleteSignedInUser,
  },
);

const logErrors = new ScenarioOutput(
  "logErrors",
  (** @type {State}*/ state) => {
    const errorList = state.errors
      .map((err) => ` - ${err.name}: ${err.message}`)
      .join("\n");
    return `Scenario errors found:\n${errorList}`;
  },
  {
    // Don't log errors when there aren't any!
    skipWhen: (** @type {State} */ state) => state.errors.length === 0,
  },
);

export const AutoConfirm = (context) =>
  new Scenario(
    "AutoConfirm",
    [
```

```

    promptForStackName,
    promptForStackRegion,
    getStackOutputs,
    greeting,
    logPopulatingUsers,
    populateUsers,
    logPopulatingUsersComplete,
    logSetupSignUpTrigger,
    setupSignUpTrigger,
    logSetupSignUpTriggerComplete,
    selectUser,
    checkIfUserAlreadyExists,
    createPassword,
    logSignUpExistingUser,
    signUpExistingUser,
    logSignUpExistingUserComplete,
    logLambdaLogs,
    logSignInUser,
    signInUser,
    logSignInUserComplete,
    confirmDeleteSignedInUser,
    deleteSignedInUser,
    logCleanUpReminder,
    logErrors,
  ],
  context,
);

```

These are steps that are shared with other Scenarios.

```

import {
  ScenarioAction,
  ScenarioInput,
  ScenarioOutput,
} from "@aws-doc-sdk-examples/lib/scenario/scenario.js";
import { getCfnOutputs } from "@aws-doc-sdk-examples/lib/sdk/cfn-outputs.js";

export const skipWhenErrors = (state) => state.errors.length > 0;

export const getStackOutputs = new ScenarioAction(
  "getStackOutputs",
  async (state) => {

```

```

    if (!state.stackName || !state.stackRegion) {
      state.errors.push(
        new Error(
          "No stack name or region provided. The stack name and \
region are required to fetch CFN outputs relevant to this example.",
        ),
      );
      return;
    }

    const outputs = await getCfnOutputs(state.stackName, state.stackRegion);
    Object.assign(state, outputs);
  },
);

export const promptForStackName = new ScenarioInput(
  "stackName",
  "Enter the name of the stack you deployed earlier.",
  { type: "input", default: "PoolsAndTriggersStack" },
);

export const promptForStackRegion = new ScenarioInput(
  "stackRegion",
  "Enter the region of the stack you deployed earlier.",
  { type: "input", default: "us-east-1" },
);

export const logCleanUpReminder = new ScenarioOutput(
  "logCleanUpReminder",
  "All done. Remember to run 'cdk destroy' to teardown the stack.",
  { skipWhen: skipWhenErrors },
);

```

A handler for the PreSignUp trigger with a Lambda function.

```

import type { PreSignUpTriggerEvent, Handler } from "aws-lambda";
import type { UserRepository } from "./user-repository";
import { DynamoDBUserRepository } from "./user-repository";

export class PreSignUpHandler {
  private userRepository: UserRepository;

```

```
constructor(userRepository: UserRepository) {
    this.userRepository = userRepository;
}

private isPreSignUpTriggerSource(event: PreSignUpTriggerEvent): boolean {
    return event.triggerSource === "PreSignUp_SignUp";
}

private getEventUserEmail(event: PreSignUpTriggerEvent): string {
    return event.request.userAttributes.email;
}

async handlePreSignUpTriggerEvent(
    event: PreSignUpTriggerEvent,
): Promise<PreSignUpTriggerEvent> {
    console.log(
        `Received presignup from ${event.triggerSource} for user
'${event.userName}'`,
    );

    if (!this.isPreSignUpTriggerSource(event)) {
        return event;
    }

    const eventEmail = this.getEventUserEmail(event);
    console.log(`Looking up email ${eventEmail}.`);
    const storedUserInfo =
        await this.userRepository.getUserInfoByEmail(eventEmail);

    if (!storedUserInfo) {
        console.log(
            `Email ${eventEmail} not found. Email verification is required.`,
        );
        return event;
    }

    if (storedUserInfo.UserName !== event.userName) {
        console.log(
            `UserEmail ${eventEmail} found, but stored UserName
'${storedUserInfo.UserName}' does not match supplied UserName
'${event.userName}'. Verification is required.`,
        );
    } else {
        console.log(
```

```

        `UserEmail ${eventEmail} found with matching UserName
        ${storedUserInfo.UserName}. User is confirmed.` ,
        );
        event.response.autoConfirmUser = true;
        event.response.autoVerifyEmail = true;
    }
    return event;
}
}

const createPreSignUpHandler = (): PreSignUpHandler => {
    const tableName = process.env.TABLE_NAME;
    if (!tableName) {
        throw new Error("TABLE_NAME environment variable is not set");
    }

    const userRepository = new DynamoDBUserRepository(tableName);
    return new PreSignUpHandler(userRepository);
};

export const handler: Handler = async (event: PreSignUpTriggerEvent) => {
    const preSignUpHandler = createPreSignUpHandler();
    return preSignUpHandler.handlePreSignUpTriggerEvent(event);
};

```

Module of CloudWatch Logs actions.

```

import {
    CloudWatchLogsClient,
    GetLogEventsCommand,
    OrderBy,
    paginateDescribeLogStreams,
} from "@aws-sdk/client-cloudwatch-logs";

/**
 * Get the latest log stream for a Lambda function.
 * @param {{ functionName: string, region: string }} config
 * @returns {Promise<[import("@aws-sdk/client-cloudwatch-logs").LogStream | null,
    unknown]>}
 */
export const getLatestLogStreamForLambda = async ({ functionName, region }) => {

```

```
try {
  const logGroupName = `/aws/lambda/${functionName}`;
  const cwlClient = new CloudWatchLogsClient({ region });
  const paginator = paginateDescribeLogStreams(
    { client: cwlClient },
    {
      descending: true,
      limit: 1,
      orderBy: OrderBy.LastEventTime,
      logGroupName,
    },
  );

  for await (const page of paginator) {
    return [page.logStreams[0], null];
  }
} catch (err) {
  return [null, err];
}
};

/**
 * Get the log events for a Lambda function's log stream.
 * @param {{
 *   functionName: string,
 *   logStreamName: string,
 *   eventCount: number,
 *   region: string
 * }} config
 * @returns {Promise<[import("@aws-sdk/client-cloudwatch-logs").OutputLogEvent[]
 * | null, unknown]>}
 */
export const getLogEvents = async ({
  functionName,
  logStreamName,
  eventCount,
  region,
}) => {
  try {
    const cwlClient = new CloudWatchLogsClient({ region });
    const logGroupName = `/aws/lambda/${functionName}`;
    const response = await cwlClient.send(
      new GetLogEventsCommand({
        logStreamName: logStreamName,
```



```

        limit: eventCount,
        logGroupName: logGroupName,
    })),
    );

    return [response.events, null];
} catch (err) {
    return [null, err];
}
};

```

Module of Amazon Cognito actions.

```

import {
    AdminGetUserCommand,
    CognitoIdentityProviderClient,
    DeleteUserCommand,
    InitiateAuthCommand,
    SignUpCommand,
    UpdateUserPoolCommand,
} from "@aws-sdk/client-cognito-identity-provider";

/**
 * Connect a Lambda function to the PreSignUp trigger for a Cognito user pool
 * @param {{ region: string, userPoolId: string, handlerArn: string }} config
 * @returns {Promise<[import("@aws-sdk/client-cognito-identity-provider").UpdateUserPoolCommandOutput | null, unknown]>}
 */
export const addPreSignUpHandler = async ({
    region,
    userPoolId,
    handlerArn,
}) => {
    try {
        const cognitoClient = new CognitoIdentityProviderClient({
            region,
        });

        const command = new UpdateUserPoolCommand({
            UserPoolId: userPoolId,
            LambdaConfig: {

```

```
        PreSignUp: handlerArn,
    },
});

    const response = await cognitoClient.send(command);
    return [response, null];
} catch (err) {
    return [null, err];
}
};

/**
 * Attempt to register a user to a user pool with a given username and password.
 * @param {{
 *   region: string,
 *   userPoolClientId: string,
 *   username: string,
 *   email: string,
 *   password: string
 * }} config
 * @returns {Promise<[import("@aws-sdk/client-cognito-identity-provider").SignUpCommandOutput | null, unknown]>}
 */
export const signUpUser = async ({
    region,
    userPoolClientId,
    username,
    email,
    password,
}) => {
    try {
        const cognitoClient = new CognitoIdentityProviderClient({
            region,
        });

        const response = await cognitoClient.send(
            new SignUpCommand({
                ClientId: userPoolClientId,
                Username: username,
                Password: password,
                UserAttributes: [{ Name: "email", Value: email }],
            }),
        );
    }
    return [response, null];
}
```

```
    } catch (err) {
      return [null, err];
    }
  };

/**
 * Sign in a user to Amazon Cognito using a username and password authentication
 * flow.
 * @param {{ region: string, clientId: string, username: string, password:
 * string }} config
 * @returns {Promise<[import("@aws-sdk/client-cognito-identity-
 * provider").InitiateAuthCommandOutput | null, unknown]>}
 */
export const signIn = async ({ region, clientId, username, password }) => {
  try {
    const cognitoClient = new CognitoIdentityProviderClient({ region });
    const response = await cognitoClient.send(
      new InitiateAuthCommand({
        AuthFlow: "USER_PASSWORD_AUTH",
        ClientId: clientId,
        AuthParameters: { USERNAME: username, PASSWORD: password },
      }),
    );
    return [response, null];
  } catch (err) {
    return [null, err];
  }
};

/**
 * Retrieve an existing user from a user pool.
 * @param {{ region: string, userPoolId: string, username: string }} config
 * @returns {Promise<[import("@aws-sdk/client-cognito-identity-
 * provider").AdminGetUserCommandOutput | null, unknown]>}
 */
export const getUser = async ({ region, userPoolId, username }) => {
  try {
    const cognitoClient = new CognitoIdentityProviderClient({ region });
    const response = await cognitoClient.send(
      new AdminGetUserCommand({
        UserPoolId: userPoolId,
        Username: username,
      }),
    );
  }
};
```

```

    return [response, null];
  } catch (err) {
    return [null, err];
  }
};

/**
 * Delete the signed-in user. Useful for allowing a user to delete their
 * own profile.
 * @param {{ region: string, accessToken: string }} config
 * @returns {Promise<[import("@aws-sdk/client-cognito-identity-
provider").DeleteUserCommandOutput | null, unknown]>}
 */
export const deleteUser = async ({ region, accessToken }) => {
  try {
    const client = new CognitoIdentityProviderClient({ region });
    const response = await client.send(
      new DeleteUserCommand({ AccessToken: accessToken }),
    );
    return [response, null];
  } catch (err) {
    return [null, err];
  }
};

```

Module of DynamoDB actions.

```

import { DynamoDBClient } from "@aws-sdk/client-dynamodb";
import {
  BatchWriteCommand,
  DynamoDBDocumentClient,
} from "@aws-sdk/lib-dynamodb";

/**
 * Populate a DynamoDB table with provide items.
 * @param {{ region: string, tableName: string, items: Record<string,
unknown>[] }} config
 * @returns {Promise<[import("@aws-sdk/lib-dynamodb").BatchWriteCommandOutput |
null, unknown]>}
 */
export const populateTable = async ({ region, tableName, items }) => {

```

```
try {
  const ddbClient = new DynamoDBClient({ region });
  const docClient = DynamoDBDocumentClient.from(ddbClient);
  const response = await docClient.send(
    new BatchWriteCommand({
      RequestItems: {
        [tableName]: items.map((item) => ({
          PutRequest: {
            Item: item,
          },
        })),
      },
    }),
  );
  return [response, null];
} catch (err) {
  return [null, err];
}
```

- For API details, see the following topics in *AWS SDK for JavaScript API Reference*.
 - [DeleteUser](#)
 - [InitiateAuth](#)
 - [SignUp](#)
 - [UpdateUserPool](#)

For a complete list of AWS SDK developer guides and code examples, see [Using Lambda with an AWS SDK](#). This topic also includes information about getting started and details about previous SDK versions.

Automatically migrate known Amazon Cognito users with a Lambda function using an AWS SDK

The following code example shows how to automatically migrate known Amazon Cognito users with a Lambda function.

- Configure a user pool to call a Lambda function for the `MigrateUser` trigger.
- Sign in to Amazon Cognito with a username and email that is not in the user pool.

- The Lambda function scans a DynamoDB table and automatically migrates known users to the user pool.
- Perform the forgot password flow to reset the password for the migrated user.
- Sign in as the new user, then clean up resources.

Go

SDK for Go V2

Note

There's more on GitHub. Find the complete example and learn how to set up and run in the [AWS Code Examples Repository](#).

Run an interactive scenario at a command prompt.

```
import (
    "context"
    "errors"
    "fmt"
    "log"
    "strings"
    "user_pools_and_lambda_triggers/actions"

    "github.com/aws/aws-sdk-go-v2/aws"
    "github.com/aws/aws-sdk-go-v2/service/cognitoidentityprovider"
    "github.com/aws/aws-sdk-go-v2/service/cognitoidentityprovider/types"
    "github.com/awsdocs/aws-doc-sdk-examples/gov2/demotools"
)

// MigrateUser separates the steps of this scenario into individual functions so
// that
// they are simpler to read and understand.
type MigrateUser struct {
    helper          IScenarioHelper
    questioner     demotools.IQuestioner
    resources       Resources
    cognitoActor   *actions.CognitoActions
}
```

```

// NewMigrateUser constructs a new migrate user runner.
func NewMigrateUser(sdkConfig aws.Config, questioner demotools.IQuestioner,
helper IScenarioHelper) MigrateUser {
    scenario := MigrateUser{
        helper:      helper,
        questioner:  questioner,
        resources:   Resources{},
        cognitoActor: &actions.CognitoActions{CognitoClient:
cognitoidentityprovider.NewFromConfig(sdkConfig)},
    }
    scenario.resources.init(scenario.cognitoActor, questioner)
    return scenario
}

// AddMigrateUserTrigger adds a Lambda handler as an invocation target for the
MigrateUser trigger.
func (runner *MigrateUser) AddMigrateUserTrigger(ctx context.Context, userPoolId
string, functionArn string) {
    log.Printf("Let's add a Lambda function to handle the MigrateUser trigger from
Cognito.\n" +
        "This trigger happens when an unknown user signs in, and lets your function
take action before Cognito\n" +
        "rejects the user.\n\n")
    err := runner.cognitoActor.UpdateTriggers(
        ctx, userPoolId,
        actions.TriggerInfo{Trigger: actions.UserMigration, HandlerArn:
aws.String(functionArn)})
    if err != nil {
        panic(err)
    }
    log.Printf("Lambda function %v added to user pool %v to handle the MigrateUser
trigger.\n",
        functionArn, userPoolId)

    log.Println(strings.Repeat("-", 88))
}

// SignInUser adds a new user to the known users table and signs that user in to
Amazon Cognito.
func (runner *MigrateUser) SignInUser(ctx context.Context, usersTable string,
clientId string) (bool, actions.User) {
    log.Println("Let's sign in a user to your Cognito user pool. When the username
and email matches an entry in the\n" +

```

```
"DynamoDB known users table, the email is automatically verified and the user
is migrated to the Cognito user pool.")

user := actions.User{}
user.UserName = runner.questioner.Ask("\nEnter a username:")
user.UserEmail = runner.questioner.Ask("\nEnter an email that you own. This
email will be used to confirm user migration\n" +
"during this example:")

runner.helper.AddKnownUser(ctx, usersTable, user)

var err error
var resetRequired *types.PasswordResetRequiredException
var authResult *types.AuthenticationResultType
signedIn := false
for !signedIn && resetRequired == nil {
    log.Printf("Signing in to Cognito as user '%v'. The expected result is a
PasswordResetRequiredException.\n\n", user.UserName)
    authResult, err = runner.cognitoActor.SignIn(ctx, clientId, user.UserName, "_")
    if err != nil {
        if errors.As(err, &resetRequired) {
            log.Printf("\nUser '%v' is not in the Cognito user pool but was found in the
DynamoDB known users table.\n"+
"User migration is started and a password reset is required.",
user.UserName)
        } else {
            panic(err)
        }
    } else {
        log.Printf("User '%v' successfully signed in. This is unexpected and probably
means you have not\n"+
"cleaned up a previous run of this scenario, so the user exist in the Cognito
user pool.\n"+
"You can continue this example and select to clean up resources, or manually
remove\n"+
"the user from your user pool and try again.", user.UserName)
        runner.resources.userAccessTokens = append(runner.resources.userAccessTokens,
*authResult.AccessToken)
        signedIn = true
    }
}

log.Println(strings.Repeat("-", 88))
return resetRequired != nil, user
```



```

}

// ResetPassword starts a password recovery flow.
func (runner *MigrateUser) ResetPassword(ctx context.Context, clientId string,
    user actions.User) {
    wantCode := runner.questioner.AskBool(fmt.Sprintf("In order to migrate the user
    to Cognito, you must be able to receive a confirmation\n"+
    "code by email at %v. Do you want to send a code (y/n)?", user.UserEmail), "y")
    if !wantCode {
        log.Println("To complete this example and successfully migrate a user to
        Cognito, you must enter an email\n" +
        "you own that can receive a confirmation code.")
        return
    }
    codeDelivery, err := runner.cognitoActor.ForgotPassword(ctx, clientId,
    user.UserName)
    if err != nil {
        panic(err)
    }
    log.Printf("\nA confirmation code has been sent to %v.",
    *codeDelivery.Destination)
    code := runner.questioner.Ask("Check your email and enter it here:")

    confirmed := false
    password := runner.questioner.AskPassword("\nEnter a password that has at least
    eight characters, uppercase, lowercase, numbers and symbols.\n"+
    "(the password will not display as you type):", 8)
    for !confirmed {
        log.Printf("\nConfirming password reset for user '%v'.\n", user.UserName)
        err = runner.cognitoActor.ConfirmForgotPassword(ctx, clientId, code,
        user.UserName, password)
        if err != nil {
            var invalidPassword *types.InvalidPasswordException
            if errors.As(err, &invalidPassword) {
                password = runner.questioner.AskPassword("\nEnter another password:", 8)
            } else {
                panic(err)
            }
        } else {
            confirmed = true
        }
    }
    log.Printf("User '%v' successfully confirmed and migrated.\n", user.UserName)
    log.Println("Signing in with your username and password...")
}

```

```
authResult, err := runner.cognitoActor.SignIn(ctx, clientId, user.UserName,
password)
if err != nil {
    panic(err)
}
log.Printf("Successfully signed in. Your access token starts with: %v...\n",
(*authResult.AccessToken)[:10])
runner.resources.userAccessTokens = append(runner.resources.userAccessTokens,
*authResult.AccessToken)

log.Println(strings.Repeat("-", 88))
}

// Run runs the scenario.
func (runner *MigrateUser) Run(ctx context.Context, stackName string) {
defer func() {
    if r := recover(); r != nil {
        log.Println("Something went wrong with the demo.")
        runner.resources.Cleanup(ctx)
    }
}()

log.Println(strings.Repeat("-", 88))
log.Printf("Welcome\n")

log.Println(strings.Repeat("-", 88))

stackOutputs, err := runner.helper.GetStackOutputs(ctx, stackName)
if err != nil {
    panic(err)
}
runner.resources.userPoolId = stackOutputs["UserPoolId"]

runner.AddMigrateUserTrigger(ctx, stackOutputs["UserPoolId"],
stackOutputs["MigrateUserFunctionArn"])
runner.resources.triggers = append(runner.resources.triggers,
actions.UserMigration)
resetNeeded, user := runner.SignInUser(ctx, stackOutputs["TableName"],
stackOutputs["UserPoolClientId"])
if resetNeeded {
    runner.helper.ListRecentLogEvents(ctx, stackOutputs["MigrateUserFunction"])
    runner.ResetPassword(ctx, stackOutputs["UserPoolClientId"], user)
}
```

```
runner.resources.Cleanup(ctx)

log.Println(strings.Repeat("-", 88))
log.Println("Thanks for watching!")
log.Println(strings.Repeat("-", 88))
}
```

Handle the `MigrateUser` trigger with a Lambda function.

```
import (
    "context"
    "log"
    "os"

    "github.com/aws/aws-lambda-go/events"
    "github.com/aws/aws-lambda-go/lambda"
    "github.com/aws/aws-sdk-go-v2/aws"
    "github.com/aws/aws-sdk-go-v2/config"
    "github.com/aws/aws-sdk-go-v2/feature/dynamodb/attributevalue"
    "github.com/aws/aws-sdk-go-v2/feature/dynamodb/expression"
    "github.com/aws/aws-sdk-go-v2/service/dynamodb"
)

const TABLE_NAME = "TABLE_NAME"

// UserInfo defines structured user data that can be marshalled to a DynamoDB
// format.
type UserInfo struct {
    UserName string `dynamodbav:"UserName"`
    UserEmail string `dynamodbav:"UserEmail"`
}

type handler struct {
    dynamoClient *dynamodb.Client
}

// HandleRequest handles the MigrateUser event by looking up a user in an Amazon
// DynamoDB table and
// specifying whether they should be migrated to the user pool.
```

```

func (h *handler) HandleRequest(ctx context.Context, event
events.CognitoEventUserPoolsMigrateUser)
(events.CognitoEventUserPoolsMigrateUser, error) {
log.Printf("Received migrate trigger from %v for user '%v'",
event.TriggerSource, event.UserName)
if event.TriggerSource != "UserMigration_Authentication" {
return event, nil
}
tableName := os.Getenv(TABLE_NAME)
user := UserInfo{
UserName: event.UserName,
}
log.Printf("Looking up user '%v' in table %v.\n", user.UserName, tableName)
filterEx := expression.Name("UserName").Equal(expression.Value(user.UserName))
expr, err := expression.NewBuilder().WithFilter(filterEx).Build()
if err != nil {
log.Printf("Error building expression to query for user '%v'.\n",
user.UserName)
return event, err
}
output, err := h.dynamoClient.Scan(ctx, &dynamodb.ScanInput{
TableName:          aws.String(tableName),
FilterExpression:   expr.Filter(),
ExpressionAttributeNames: expr.Names(),
ExpressionAttributeValues: expr.Values(),
})
if err != nil {
log.Printf("Error looking up user '%v'.\n", user.UserName)
return event, err
}
if len(output.Items) == 0 {
log.Printf("User '%v' not found, not migrating user.\n", user.UserName)
return event, err
}

var users []UserInfo
err = attributevalue.UnmarshalListOfMaps(output.Items, &users)
if err != nil {
log.Printf("Couldn't unmarshal DynamoDB items. Here's why: %v\n", err)
return event, err
}

user = users[0]

```

```

log.Printf("UserName '%v' found with email %v. User is migrated and must reset
password.\n", user.UserName, user.UserEmail)
event.CognitoEventUserPoolsMigrateUserResponse.UserAttributes =
map[string]string{
    "email":          user.UserEmail,
    "email_verified": "true", // email_verified is required for the forgot password
flow.
}
event.CognitoEventUserPoolsMigrateUserResponse.FinalUserStatus =
"RESET_REQUIRED"
event.CognitoEventUserPoolsMigrateUserResponse.MessageAction = "SUPPRESS"

return event, err
}

func main() {
    ctx := context.Background()
    sdkConfig, err := config.LoadDefaultConfig(ctx)
    if err != nil {
        log.Panicln(err)
    }
    h := handler{
        dynamoClient: dynamodb.NewFromConfig(sdkConfig),
    }
    lambda.Start(h.HandleRequest)
}

```

Create a struct that performs common tasks.

```

import (
    "context"
    "log"
    "strings"
    "time"
    "user_pools_and_lambda_triggers/actions"

    "github.com/aws/aws-sdk-go-v2/aws"
    "github.com/aws/aws-sdk-go-v2/service/cloudformation"
    "github.com/aws/aws-sdk-go-v2/service/cloudwatchlogs"
    "github.com/aws/aws-sdk-go-v2/service/dynamodb"

```

```
"github.com/awsdocs/aws-doc-sdk-examples/gov2/demotools"
)

// IScenarioHelper defines common functions used by the workflows in this
// example.
type IScenarioHelper interface {
    Pause(secs int)
    GetStackOutputs(ctx context.Context, stackName string) (actions.StackOutputs,
        error)
    PopulateUserTable(ctx context.Context, tableName string)
    GetKnownUsers(ctx context.Context, tableName string) (actions.UserList, error)
    AddKnownUser(ctx context.Context, tableName string, user actions.User)
    ListRecentLogEvents(ctx context.Context, functionName string)
}

// ScenarioHelper contains AWS wrapper structs used by the workflows in this
// example.
type ScenarioHelper struct {
    questioner demotools.IQuestioner
    dynamoActor *actions.DynamoActions
    cfnActor     *actions.CloudFormationActions
    cwlActor     *actions.CloudWatchLogsActions
    isTestRun   bool
}

// NewScenarioHelper constructs a new scenario helper.
func NewScenarioHelper(sdkConfig aws.Config, questioner demotools.IQuestioner)
    ScenarioHelper {
    scenario := ScenarioHelper{
        questioner: questioner,
        dynamoActor: &actions.DynamoActions{DynamoClient:
            dynamodb.NewFromConfig(sdkConfig)},
        cfnActor: &actions.CloudFormationActions{CfnClient:
            cloudformation.NewFromConfig(sdkConfig)},
        cwlActor: &actions.CloudWatchLogsActions{CwlClient:
            cloudwatchlogs.NewFromConfig(sdkConfig)},
    }
    return scenario
}

// Pause waits for the specified number of seconds.
func (helper ScenarioHelper) Pause(secs int) {
    if !helper.isTestRun {
        time.Sleep(time.Duration(secs) * time.Second)
    }
}
```

```
    }  
  }  
  
  // GetStackOutputs gets the outputs from the specified CloudFormation stack in a  
  // structured format.  
  func (helper ScenarioHelper) GetStackOutputs(ctx context.Context, stackName  
    string) (actions.StackOutputs, error) {  
    return helper.cfnActor.GetOutputs(ctx, stackName), nil  
  }  
  
  // PopulateUserTable fills the known user table with example data.  
  func (helper ScenarioHelper) PopulateUserTable(ctx context.Context, tableName  
    string) {  
    log.Printf("First, let's add some users to the DynamoDB %v table we'll use for  
    this example.\n", tableName)  
    err := helper.dynamoActor.PopulateTable(ctx, tableName)  
    if err != nil {  
      panic(err)  
    }  
  }  
  
  // GetKnownUsers gets the users from the known users table in a structured  
  // format.  
  func (helper ScenarioHelper) GetKnownUsers(ctx context.Context, tableName string)  
    (actions.UserList, error) {  
    knownUsers, err := helper.dynamoActor.Scan(ctx, tableName)  
    if err != nil {  
      log.Printf("Couldn't get known users from table %v. Here's why: %v\n",  
        tableName, err)  
    }  
    return knownUsers, err  
  }  
  
  // AddKnownUser adds a user to the known users table.  
  func (helper ScenarioHelper) AddKnownUser(ctx context.Context, tableName string,  
    user actions.User) {  
    log.Printf("Adding user '%v' with email '%v' to the DynamoDB known users  
    table...\n",  
      user.UserName, user.UserEmail)  
    err := helper.dynamoActor.AddUser(ctx, tableName, user)  
    if err != nil {  
      panic(err)  
    }  
  }  
}
```

```
// ListRecentLogEvents gets the most recent log stream and events for the
// specified Lambda function and displays them.
func (helper ScenarioHelper) ListRecentLogEvents(ctx context.Context,
    functionName string) {
    log.Println("Waiting a few seconds to let Lambda write to CloudWatch Logs...")
    helper.Pause(10)
    log.Println("Okay, let's check the logs to find what's happened recently with
    your Lambda function.")
    logStream, err := helper.cwlActor.GetLatestLogStream(ctx, functionName)
    if err != nil {
        panic(err)
    }
    log.Printf("Getting some recent events from log stream %v\n",
        *logStream.LogStreamName)
    events, err := helper.cwlActor.GetLogEvents(ctx, functionName,
        *logStream.LogStreamName, 10)
    if err != nil {
        panic(err)
    }
    for _, event := range events {
        log.Printf("\t%v", *event.Message)
    }
    log.Println(strings.Repeat("-", 88))
}
```

Create a struct that wraps Amazon Cognito actions.

```
import (
    "context"
    "errors"
    "log"

    "github.com/aws/aws-sdk-go-v2/aws"
    "github.com/aws/aws-sdk-go-v2/service/cognitoidentityprovider"
    "github.com/aws/aws-sdk-go-v2/service/cognitoidentityprovider/types"
)

type CognitoActions struct {
    CognitoClient *cognitoidentityprovider.Client
```



```
}

// Trigger and TriggerInfo define typed data for updating an Amazon Cognito
// trigger.
type Trigger int

const (
    PreSignUp Trigger = iota
    UserMigration
    PostAuthentication
)

type TriggerInfo struct {
    Trigger    Trigger
    HandlerArn *string
}

// UpdateTriggers adds or removes Lambda triggers for a user pool. When a trigger
// is specified with a `nil` value,
// it is removed from the user pool.
func (actor CognitoActions) UpdateTriggers(ctx context.Context, userPoolId
string, triggers ...TriggerInfo) error {
    output, err := actor.CognitoClient.DescribeUserPool(ctx,
&cognitoidentityprovider.DescribeUserPoolInput{
    UserPoolId: aws.String(userPoolId),
})
    if err != nil {
        log.Printf("Couldn't get info about user pool %v. Here's why: %v\n",
userPoolId, err)
        return err
    }
    lambdaConfig := output.UserPool.LambdaConfig
    for _, trigger := range triggers {
        switch trigger.Trigger {
        case PreSignUp:
            lambdaConfig.PreSignUp = trigger.HandlerArn
        case UserMigration:
            lambdaConfig.UserMigration = trigger.HandlerArn
        case PostAuthentication:
            lambdaConfig.PostAuthentication = trigger.HandlerArn
        }
    }
}
```

```
_, err = actor.CognitoClient.UpdateUserPool(ctx,
&cognitoidentityprovider.UpdateUserPoolInput{
    UserPoolId:  aws.String(userPoolId),
    LambdaConfig: lambdaConfig,
})
if err != nil {
    log.Printf("Couldn't update user pool %v. Here's why: %v\n", userPoolId, err)
}
return err
}

// SignUp signs up a user with Amazon Cognito.
func (actor CognitoActions) SignUp(ctx context.Context, clientId string, userName
string, password string, userEmail string) (bool, error) {
    confirmed := false
    output, err := actor.CognitoClient.SignUp(ctx,
&cognitoidentityprovider.SignUpInput{
    ClientId: aws.String(clientId),
    Password: aws.String(password),
    Username: aws.String(userName),
    UserAttributes: []types.AttributeType{
        {Name: aws.String("email"), Value: aws.String(userEmail)},
    },
})
    if err != nil {
        var invalidPassword *types.InvalidPasswordException
        if errors.As(err, &invalidPassword) {
            log.Println(*invalidPassword.Message)
        } else {
            log.Printf("Couldn't sign up user %v. Here's why: %v\n", userName, err)
        }
    } else {
        confirmed = output.UserConfirmed
    }
    return confirmed, err
}

// SignIn signs in a user to Amazon Cognito using a username and password
authentication flow.
```

```
func (actor CognitoActions) SignIn(ctx context.Context, clientId string, userName
string, password string) (*types.AuthenticationResultType, error) {
    var authResult *types.AuthenticationResultType
    output, err := actor.CognitoClient.InitiateAuth(ctx,
    &cognitoidentityprovider.InitiateAuthInput{
        AuthFlow:      "USER_PASSWORD_AUTH",
        ClientId:      aws.String(clientId),
        AuthParameters: map[string]string{"USERNAME": userName, "PASSWORD": password},
    })
    if err != nil {
        var resetRequired *types.PasswordResetRequiredException
        if errors.As(err, &resetRequired) {
            log.Println(*resetRequired.Message)
        } else {
            log.Printf("Couldn't sign in user %v. Here's why: %v\n", userName, err)
        }
    } else {
        authResult = output.AuthenticationResult
    }
    return authResult, err
}

// ForgotPassword starts a password recovery flow for a user. This flow typically
// sends a confirmation code
// to the user's configured notification destination, such as email.
func (actor CognitoActions) ForgotPassword(ctx context.Context, clientId string,
userName string) (*types.CodeDeliveryDetailsType, error) {
    output, err := actor.CognitoClient.ForgotPassword(ctx,
    &cognitoidentityprovider.ForgotPasswordInput{
        ClientId: aws.String(clientId),
        Username: aws.String(userName),
    })
    if err != nil {
        log.Printf("Couldn't start password reset for user '%v'. Here;s why: %v\n",
        userName, err)
    }
    return output.CodeDeliveryDetails, err
}
```

```
// ConfirmForgotPassword confirms a user with a confirmation code and a new
password.
func (actor CognitoActions) ConfirmForgotPassword(ctx context.Context, clientId
string, code string, userName string, password string) error {
_, err := actor.CognitoClient.ConfirmForgotPassword(ctx,
&cognitoidentityprovider.ConfirmForgotPasswordInput{
    ClientId:      aws.String(clientId),
    ConfirmationCode: aws.String(code),
    Password:      aws.String(password),
    Username:      aws.String(userName),
})
if err != nil {
    var invalidPassword *types.InvalidPasswordException
    if errors.As(err, &invalidPassword) {
        log.Println(*invalidPassword.Message)
    } else {
        log.Printf("Couldn't confirm user %v. Here's why: %v", userName, err)
    }
}
return err
}

// DeleteUser removes a user from the user pool.
func (actor CognitoActions) DeleteUser(ctx context.Context, userAccessToken
string) error {
_, err := actor.CognitoClient.DeleteUser(ctx,
&cognitoidentityprovider.DeleteUserInput{
    AccessToken: aws.String(userAccessToken),
})
if err != nil {
    log.Printf("Couldn't delete user. Here's why: %v\n", err)
}
return err
}

// AdminCreateUser uses administrator credentials to add a user to a user pool.
This method leaves the user
// in a state that requires they enter a new password next time they sign in.
func (actor CognitoActions) AdminCreateUser(ctx context.Context, userPoolId
string, userName string, userEmail string) error {
```

```

_, err := actor.CognitoClient.AdminCreateUser(ctx,
&cognitoidentityprovider.AdminCreateUserInput{
    UserPoolId:    aws.String(userPoolId),
    Username:     aws.String(userName),
    MessageAction: types.MessageActionTypeSuppress,
    UserAttributes: []types.AttributeType{{Name: aws.String("email"), Value:
aws.String(userEmail)}}},
})
if err != nil {
    var userExists *types.UsernameExistsException
    if errors.As(err, &userExists) {
        log.Printf("User %v already exists in the user pool.", userName)
        err = nil
    } else {
        log.Printf("Couldn't create user %v. Here's why: %v\n", userName, err)
    }
}
return err
}

// AdminSetUserPassword uses administrator credentials to set a password for a
// user without requiring a
// temporary password.
func (actor CognitoActions) AdminSetUserPassword(ctx context.Context, userPoolId
string, userName string, password string) error {
_, err := actor.CognitoClient.AdminSetUserPassword(ctx,
&cognitoidentityprovider.AdminSetUserPasswordInput{
    Password:    aws.String(password),
    UserPoolId: aws.String(userPoolId),
    Username:   aws.String(userName),
    Permanent:  true,
})
if err != nil {
    var invalidPassword *types.InvalidPasswordException
    if errors.As(err, &invalidPassword) {
        log.Println(*invalidPassword.Message)
    } else {
        log.Printf("Couldn't set password for user %v. Here's why: %v\n", userName,
err)
    }
}
return err
}

```

```
}
```

Create a struct that wraps DynamoDB actions.

```
import (
    "context"
    "fmt"
    "log"

    "github.com/aws/aws-sdk-go-v2/aws"
    "github.com/aws/aws-sdk-go-v2/feature/dynamodb/attributevalue"
    "github.com/aws/aws-sdk-go-v2/service/dynamodb"
    "github.com/aws/aws-sdk-go-v2/service/dynamodb/types"
)

// DynamoActions encapsulates the Amazon Simple Notification Service (Amazon SNS)
// actions
// used in the examples.
type DynamoActions struct {
    DynamoClient *dynamodb.Client
}

// User defines structured user data.
type User struct {
    UserName    string
    UserEmail   string
    LastLogin   *LoginInfo `dynamodbav:",omitempty"`
}

// LoginInfo defines structured custom login data.
type LoginInfo struct {
    UserPoolId string
    ClientId   string
    Time       string
}

// UserList defines a list of users.
type UserList struct {
    Users []User
}
```

```
// UserNameList returns the usernames contained in a UserList as a list of
strings.
func (users *UserList) UserNameList() []string {
    names := make([]string, len(users.Users))
    for i := 0; i < len(users.Users); i++ {
        names[i] = users.Users[i].UserName
    }
    return names
}

// PopulateTable adds a set of test users to the table.
func (actor DynamoActions) PopulateTable(ctx context.Context, tableName string)
error {
    var err error
    var item map[string]types.AttributeValue
    var writeReqs []types.WriteRequest
    for i := 1; i < 4; i++ {
        item, err = attributevalue.MarshalMap(User{UserName: fmt.Sprintf("test_user_
%v", i), userEmail: fmt.Sprintf("test_email_%v@example.com", i)})
        if err != nil {
            log.Printf("Couldn't marshall user into DynamoDB format. Here's why: %v\n",
err)
            return err
        }
        writeReqs = append(writeReqs, types.WriteRequest{PutRequest:
&types.PutRequest{Item: item}})
    }
    _, err = actor.DynamoClient.BatchWriteItem(ctx, &dynamodb.BatchWriteItemInput{
RequestItems: map[string][]types.WriteRequest{tableName: writeReqs},
})
    if err != nil {
        log.Printf("Couldn't populate table %v with users. Here's why: %v\n",
tableName, err)
    }
    return err
}

// Scan scans the table for all items.
func (actor DynamoActions) Scan(ctx context.Context, tableName string) (UserList,
error) {
    var userList UserList
    output, err := actor.DynamoClient.Scan(ctx, &dynamodb.ScanInput{
TableName: aws.String(tableName),
```

```

    })
    if err != nil {
        log.Printf("Couldn't scan table %v for items. Here's why: %v\n", tableName,
            err)
    } else {
        err = attributevalue.UnmarshalListOfMaps(output.Items, &userList.Users)
        if err != nil {
            log.Printf("Couldn't unmarshal items into users. Here's why: %v\n", err)
        }
    }
    return userList, err
}

// AddUser adds a user item to a table.
func (actor DynamoActions) AddUser(ctx context.Context, tableName string, user
    User) error {
    userItem, err := attributevalue.MarshalMap(user)
    if err != nil {
        log.Printf("Couldn't marshall user to item. Here's why: %v\n", err)
    }
    _, err = actor.DynamoClient.PutItem(ctx, &dynamodb.PutItemInput{
        Item:      userItem,
        TableName: aws.String(tableName),
    })
    if err != nil {
        log.Printf("Couldn't put item in table %v. Here's why: %v", tableName, err)
    }
    return err
}

```

Create a struct that wraps CloudWatch Logs actions.

```

import (
    "context"
    "fmt"
    "log"

    "github.com/aws/aws-sdk-go-v2/aws"
    "github.com/aws/aws-sdk-go-v2/service/cloudwatchlogs"
    "github.com/aws/aws-sdk-go-v2/service/cloudwatchlogs/types"

```



```
)

type CloudWatchLogsActions struct {
    CwlClient *cloudwatchlogs.Client
}

// GetLatestLogStream gets the most recent log stream for a Lambda function.
func (actor CloudWatchLogsActions) GetLatestLogStream(ctx context.Context,
    functionName string) (types.LogStream, error) {
    var logStream types.LogStream
    logGroupName := fmt.Sprintf("/aws/lambda/%s", functionName)
    output, err := actor.CwlClient.DescribeLogStreams(ctx,
        &cloudwatchlogs.DescribeLogStreamsInput{
            Descending:    aws.Bool(true),
            Limit:         aws.Int32(1),
            LogGroupName: aws.String(logGroupName),
            OrderBy:      types.OrderByLastEventTime,
        })
    if err != nil {
        log.Printf("Couldn't get log streams for log group %v. Here's why: %v\n",
            logGroupName, err)
    } else {
        logStream = output.LogStreams[0]
    }
    return logStream, err
}

// GetLogEvents gets the most recent eventCount events from the specified log
// stream.
func (actor CloudWatchLogsActions) GetLogEvents(ctx context.Context, functionName
    string, logStreamName string, eventCount int32) (
    []types.OutputLogEvent, error) {
    var events []types.OutputLogEvent
    logGroupName := fmt.Sprintf("/aws/lambda/%s", functionName)
    output, err := actor.CwlClient.GetLogEvents(ctx,
        &cloudwatchlogs.GetLogEventsInput{
            LogStreamName: aws.String(logStreamName),
            Limit:        aws.Int32(eventCount),
            LogGroupName: aws.String(logGroupName),
        })
    if err != nil {
        log.Printf("Couldn't get log event for log stream %v. Here's why: %v\n",
            logStreamName, err)
    } else {
```

```

    events = output.Events
}
return events, err
}

```

Create a struct that wraps AWS CloudFormation actions.

```

import (
    "context"
    "log"

    "github.com/aws/aws-sdk-go-v2/aws"
    "github.com/aws/aws-sdk-go-v2/service/cloudformation"
)

// StackOutputs defines a map of outputs from a specific stack.
type StackOutputs map[string]string

type CloudFormationActions struct {
    CfnClient *cloudformation.Client
}

// GetOutputs gets the outputs from a CloudFormation stack and puts them into a
// structured format.
func (actor CloudFormationActions) GetOutputs(ctx context.Context, stackName
string) StackOutputs {
    output, err := actor.CfnClient.DescribeStacks(ctx,
&cloudformation.DescribeStacksInput{
        StackName: aws.String(stackName),
    })
    if err != nil || len(output.Stacks) == 0 {
        log.Panicf("Couldn't find a CloudFormation stack named %v. Here's why: %v\n",
stackName, err)
    }
    stackOutputs := StackOutputs{}
    for _, out := range output.Stacks[0].Outputs {
        stackOutputs[*out.OutputKey] = *out.OutputValue
    }
    return stackOutputs
}

```

Clean up resources.

```
import (
    "context"
    "log"
    "user_pools_and_lambda_triggers/actions"

    "github.com/awsdocs/aws-doc-sdk-examples/gov2/demotools"
)

// Resources keeps track of AWS resources created during an example and handles
// cleanup when the example finishes.
type Resources struct {
    userPoolId      string
    userAccessTokens []string
    triggers        []actions.Trigger

    cognitoActor *actions.CognitoActions
    questioner   demotools.IQuestioner
}

func (resources *Resources) init(cognitoActor *actions.CognitoActions, questioner
demotools.IQuestioner) {
    resources.userAccessTokens = []string{}
    resources.triggers = []actions.Trigger{}
    resources.cognitoActor = cognitoActor
    resources.questioner = questioner
}

// Cleanup deletes all AWS resources created during an example.
func (resources *Resources) Cleanup(ctx context.Context) {
    defer func() {
        if r := recover(); r != nil {
            log.Printf("Something went wrong during cleanup.\n%v\n", r)
            log.Println("Use the AWS Management Console to remove any remaining resources
\n" +
                "that were created for this scenario.")
        }
    }()
}
```

```
wantDelete := resources.questioner.AskBool("Do you want to remove all of the AWS
resources that were created "+
"during this demo (y/n)?", "y")
if wantDelete {
for _, accessToken := range resources.userAccessTokens {
err := resources.cognitoActor.DeleteUser(ctx, accessToken)
if err != nil {
log.Println("Couldn't delete user during cleanup.")
panic(err)
}
log.Println("Deleted user.")
}
triggerList := make([]actions.TriggerInfo, len(resources.triggers))
for i := 0; i < len(resources.triggers); i++ {
triggerList[i] = actions.TriggerInfo{Trigger: resources.triggers[i],
HandlerArn: nil}
}
err := resources.cognitoActor.UpdateTriggers(ctx, resources.userPoolId,
triggerList...)
if err != nil {
log.Println("Couldn't update Cognito triggers during cleanup.")
panic(err)
}
log.Println("Removed Cognito triggers from user pool.")
} else {
log.Println("Be sure to remove resources when you're done with them to avoid
unexpected charges!")
}
}
```

- For API details, see the following topics in *AWS SDK for Go API Reference*.
 - [ConfirmForgotPassword](#)
 - [DeleteUser](#)
 - [ForgotPassword](#)
 - [InitiateAuth](#)
 - [SignUp](#)
 - [UpdateUserPool](#)

For a complete list of AWS SDK developer guides and code examples, see [Using Lambda with an AWS SDK](#). This topic also includes information about getting started and details about previous SDK versions.

Create an API Gateway REST API to track COVID-19 data

The following code example shows how to create a REST API that simulates a system to track daily cases of COVID-19 in the United States, using fictional data.

Python

SDK for Python (Boto3)

Shows how to use AWS Chalice with the AWS SDK for Python (Boto3) to create a serverless REST API that uses Amazon API Gateway, AWS Lambda, and Amazon DynamoDB. The REST API simulates a system that tracks daily cases of COVID-19 in the United States, using fictional data. Learn how to:

- Use AWS Chalice to define routes in Lambda functions that are called to handle REST requests that come through API Gateway.
- Use Lambda functions to retrieve and store data in a DynamoDB table to serve REST requests.
- Define table structure and security role resources in an AWS CloudFormation template.
- Use AWS Chalice and CloudFormation to package and deploy all necessary resources.
- Use CloudFormation to clean up all created resources.

For complete source code and instructions on how to set up and run, see the full example on [GitHub](#).

Services used in this example

- API Gateway
- AWS CloudFormation
- DynamoDB
- Lambda

For a complete list of AWS SDK developer guides and code examples, see [Using Lambda with an AWS SDK](#). This topic also includes information about getting started and details about previous SDK versions.

Create a lending library REST API

The following code example shows how to create a lending library where patrons can borrow and return books by using a REST API backed by an Amazon Aurora database.

Python

SDK for Python (Boto3)

Shows how to use the AWS SDK for Python (Boto3) with the Amazon Relational Database Service (Amazon RDS) API and AWS Chalice to create a REST API backed by an Amazon Aurora database. The web service is fully serverless and represents a simple lending library where patrons can borrow and return books. Learn how to:

- Create and manage a serverless Aurora database cluster.
- Use AWS Secrets Manager to manage database credentials.
- Implement a data storage layer that uses Amazon RDS to move data into and out of the database.
- Use AWS Chalice to deploy a serverless REST API to Amazon API Gateway and AWS Lambda.
- Use the Requests package to send requests to the web service.

For complete source code and instructions on how to set up and run, see the full example on [GitHub](#).

Services used in this example

- API Gateway
- Aurora
- Lambda
- Secrets Manager

For a complete list of AWS SDK developer guides and code examples, see [Using Lambda with an AWS SDK](#). This topic also includes information about getting started and details about previous SDK versions.

Create a messenger application with Step Functions

The following code example shows how to create an AWS Step Functions messenger application that retrieves message records from a database table.

Python

SDK for Python (Boto3)

Shows how to use the AWS SDK for Python (Boto3) with AWS Step Functions to create a messenger application that retrieves message records from an Amazon DynamoDB table and sends them with Amazon Simple Queue Service (Amazon SQS). The state machine integrates with an AWS Lambda function to scan the database for unsent messages.

- Create a state machine that retrieves and updates message records from an Amazon DynamoDB table.
- Update the state machine definition to also send messages to Amazon Simple Queue Service (Amazon SQS).
- Start and stop state machine runs.
- Connect to Lambda, DynamoDB, and Amazon SQS from a state machine by using service integrations.

For complete source code and instructions on how to set up and run, see the full example on [GitHub](#).

Services used in this example

- DynamoDB
- Lambda
- Amazon SQS
- Step Functions

For a complete list of AWS SDK developer guides and code examples, see [Using Lambda with an AWS SDK](#). This topic also includes information about getting started and details about previous SDK versions.

Create a photo asset management application that lets users manage photos using labels

The following code examples show how to create a serverless application that lets users manage photos using labels.

.NET

AWS SDK for .NET

Shows how to develop a photo asset management application that detects labels in images using Amazon Rekognition and stores them for later retrieval.

For complete source code and instructions on how to set up and run, see the full example on [GitHub](#).

For a deep dive into the origin of this example see the post on [AWS Community](#).

Services used in this example

- API Gateway
- DynamoDB
- Lambda
- Amazon Rekognition
- Amazon S3
- Amazon SNS

C++

SDK for C++

Shows how to develop a photo asset management application that detects labels in images using Amazon Rekognition and stores them for later retrieval.

For complete source code and instructions on how to set up and run, see the full example on [GitHub](#).

For a deep dive into the origin of this example see the post on [AWS Community](#).

Services used in this example

- API Gateway
- DynamoDB
- Lambda
- Amazon Rekognition
- Amazon S3
- Amazon SNS

Java

SDK for Java 2.x

Shows how to develop a photo asset management application that detects labels in images using Amazon Rekognition and stores them for later retrieval.

For complete source code and instructions on how to set up and run, see the full example on [GitHub](#).

For a deep dive into the origin of this example see the post on [AWS Community](#).

Services used in this example

- API Gateway
- DynamoDB
- Lambda
- Amazon Rekognition
- Amazon S3
- Amazon SNS

JavaScript

SDK for JavaScript (v3)

Shows how to develop a photo asset management application that detects labels in images using Amazon Rekognition and stores them for later retrieval.

For complete source code and instructions on how to set up and run, see the full example on [GitHub](#).

For a deep dive into the origin of this example see the post on [AWS Community](#).

Services used in this example

- API Gateway
- DynamoDB
- Lambda
- Amazon Rekognition
- Amazon S3
- Amazon SNS

Kotlin

SDK for Kotlin

Shows how to develop a photo asset management application that detects labels in images using Amazon Rekognition and stores them for later retrieval.

For complete source code and instructions on how to set up and run, see the full example on [GitHub](#).

For a deep dive into the origin of this example see the post on [AWS Community](#).

Services used in this example

- API Gateway
- DynamoDB
- Lambda
- Amazon Rekognition
- Amazon S3
- Amazon SNS

PHP

SDK for PHP

Shows how to develop a photo asset management application that detects labels in images using Amazon Rekognition and stores them for later retrieval.

For complete source code and instructions on how to set up and run, see the full example on [GitHub](#).

For a deep dive into the origin of this example see the post on [AWS Community](#).

Services used in this example

- API Gateway
- DynamoDB
- Lambda
- Amazon Rekognition
- Amazon S3
- Amazon SNS

Rust

SDK for Rust

Shows how to develop a photo asset management application that detects labels in images using Amazon Rekognition and stores them for later retrieval.

For complete source code and instructions on how to set up and run, see the full example on [GitHub](#).

For a deep dive into the origin of this example see the post on [AWS Community](#).

Services used in this example

- API Gateway
- DynamoDB
- Lambda
- Amazon Rekognition
- Amazon S3
- Amazon SNS

For a complete list of AWS SDK developer guides and code examples, see [Using Lambda with an AWS SDK](#). This topic also includes information about getting started and details about previous SDK versions.

Create a websocket chat application with API Gateway

The following code example shows how to create a chat application that is served by a websocket API built on Amazon API Gateway.

Python

SDK for Python (Boto3)

Shows how to use the AWS SDK for Python (Boto3) with Amazon API Gateway V2 to create a websocket API that integrates with AWS Lambda and Amazon DynamoDB.

- Create a websocket API served by API Gateway.
- Define a Lambda handler that stores connections in DynamoDB and posts messages to other chat participants.
- Connect to the websocket chat application and send messages with the Websockets package.

For complete source code and instructions on how to set up and run, see the full example on [GitHub](#).

Services used in this example

- API Gateway
- DynamoDB
- Lambda

For a complete list of AWS SDK developer guides and code examples, see [Using Lambda with an AWS SDK](#). This topic also includes information about getting started and details about previous SDK versions.

Create an application that analyzes customer feedback and synthesizes audio

The following code examples show how to create an application that analyzes customer comment cards, translates them from their original language, determines their sentiment, and generates an audio file from the translated text.

.NET

AWS SDK for .NET

This example application analyzes and stores customer feedback cards. Specifically, it fulfills the need of a fictitious hotel in New York City. The hotel receives feedback from guests in various languages in the form of physical comment cards. That feedback is uploaded into the app through a web client. After an image of a comment card is uploaded, the following steps occur:

- Text is extracted from the image using Amazon Textract.
- Amazon Comprehend determines the sentiment of the extracted text and its language.
- The extracted text is translated to English using Amazon Translate.
- Amazon Polly synthesizes an audio file from the extracted text.

The full app can be deployed with the AWS CDK. For source code and deployment instructions, see the project in [GitHub](#).

Services used in this example

- Amazon Comprehend
- Lambda
- Amazon Polly
- Amazon Textract
- Amazon Translate

Java

SDK for Java 2.x

This example application analyzes and stores customer feedback cards. Specifically, it fulfills the need of a fictitious hotel in New York City. The hotel receives feedback from guests in various languages in the form of physical comment cards. That feedback is uploaded into the app through a web client. After an image of a comment card is uploaded, the following steps occur:

- Text is extracted from the image using Amazon Textract.
- Amazon Comprehend determines the sentiment of the extracted text and its language.
- The extracted text is translated to English using Amazon Translate.

- Amazon Polly synthesizes an audio file from the extracted text.

The full app can be deployed with the AWS CDK. For source code and deployment instructions, see the project in [GitHub](#).

Services used in this example

- Amazon Comprehend
- Lambda
- Amazon Polly
- Amazon Textract
- Amazon Translate

JavaScript

SDK for JavaScript (v3)

This example application analyzes and stores customer feedback cards. Specifically, it fulfills the need of a fictitious hotel in New York City. The hotel receives feedback from guests in various languages in the form of physical comment cards. That feedback is uploaded into the app through a web client. After an image of a comment card is uploaded, the following steps occur:

- Text is extracted from the image using Amazon Textract.
- Amazon Comprehend determines the sentiment of the extracted text and its language.
- The extracted text is translated to English using Amazon Translate.
- Amazon Polly synthesizes an audio file from the extracted text.

The full app can be deployed with the AWS CDK. For source code and deployment instructions, see the project in [GitHub](#). The following excerpts show how the AWS SDK for JavaScript is used inside of Lambda functions.

```
import {
  ComprehendClient,
  DetectDominantLanguageCommand,
  DetectSentimentCommand,
} from "@aws-sdk/client-comprehend";

/**
```

```

* Determine the language and sentiment of the extracted text.
*
* @param {{ source_text: string}} extractTextOutput
*/
export const handler = async (extractTextOutput) => {
  const comprehendClient = new ComprehendClient({});

  const detectDominantLanguageCommand = new DetectDominantLanguageCommand({
    Text: extractTextOutput.source_text,
  });

  // The source language is required for sentiment analysis and
  // translation in the next step.
  const { Languages } = await comprehendClient.send(
    detectDominantLanguageCommand,
  );

  const languageCode = Languages[0].LanguageCode;

  const detectSentimentCommand = new DetectSentimentCommand({
    Text: extractTextOutput.source_text,
    LanguageCode: languageCode,
  });

  const { Sentiment } = await comprehendClient.send(detectSentimentCommand);

  return {
    sentiment: Sentiment,
    language_code: languageCode,
  };
};

```

```

import {
  DetectDocumentTextCommand,
  TextractClient,
} from "@aws-sdk/client-textract";

/**
* Fetch the S3 object from the event and analyze it using Amazon Textract.
*
* @param {import("@types/aws-lambda").EventBridgeEvent<"Object Created">}
eventBridgeS3Event
*/

```

```

export const handler = async (eventBridgeS3Event) => {
  const textractClient = new TextractClient();

  const detectDocumentTextCommand = new DetectDocumentTextCommand({
    Document: {
      S3object: {
        Bucket: eventBridgeS3Event.bucket,
        Name: eventBridgeS3Event.object,
      },
    },
  });

  // Textract returns a list of blocks. A block can be a line, a page, word, etc.
  // Each block also contains geometry of the detected text.
  // For more information on the Block type, see https://docs.aws.amazon.com/
  // textract/latest/dg/API_Block.html.
  const { Blocks } = await textractClient.send(detectDocumentTextCommand);

  // For the purpose of this example, we are only interested in words.
  const extractedWords = Blocks.filter((b) => b.BlockType === "WORD").map(
    (b) => b.Text,
  );

  return extractedWords.join(" ");
};

```

```

import { PollyClient, SynthesizeSpeechCommand } from "@aws-sdk/client-polly";
import { S3Client } from "@aws-sdk/client-s3";
import { Upload } from "@aws-sdk/lib-storage";

/**
 * Synthesize an audio file from text.
 *
 * @param {{ bucket: string, translated_text: string, object: string }}
 * sourceDestinationConfig
 */
export const handler = async (sourceDestinationConfig) => {
  const pollyClient = new PollyClient({});

  const synthesizeSpeechCommand = new SynthesizeSpeechCommand({
    Engine: "neural",
    Text: sourceDestinationConfig.translated_text,
    VoiceId: "Ruth",
  });

```



```
    OutputFormat: "mp3",
  });

  const { AudioStream } = await pollyClient.send(synthesizeSpeechCommand);

  const audioKey = `${sourceDestinationConfig.object}.mp3`;

  // Store the audio file in S3.
  const s3Client = new S3Client();
  const upload = new Upload({
    client: s3Client,
    params: {
      Bucket: sourceDestinationConfig.bucket,
      Key: audioKey,
      Body: AudioStream,
      ContentType: "audio/mp3",
    },
  });

  await upload.done();
  return audioKey;
};
```

```
import {
  TranslateClient,
  TranslateTextCommand,
} from "@aws-sdk/client-translate";

/**
 * Translate the extracted text to English.
 *
 * @param {{ extracted_text: string, source_language_code: string }}
  textAndSourceLanguage
 */
export const handler = async (textAndSourceLanguage) => {
  const translateClient = new TranslateClient({});

  const translateCommand = new TranslateTextCommand({
    SourceLanguageCode: textAndSourceLanguage.source_language_code,
    TargetLanguageCode: "en",
    Text: textAndSourceLanguage.extracted_text,
  });
```

```
const { TranslatedText } = await translateClient.send(translateCommand);

return { translated_text: TranslatedText };
};
```

Services used in this example

- Amazon Comprehend
- Lambda
- Amazon Polly
- Amazon Textract
- Amazon Translate

Ruby

SDK for Ruby

This example application analyzes and stores customer feedback cards. Specifically, it fulfills the need of a fictitious hotel in New York City. The hotel receives feedback from guests in various languages in the form of physical comment cards. That feedback is uploaded into the app through a web client. After an image of a comment card is uploaded, the following steps occur:

- Text is extracted from the image using Amazon Textract.
- Amazon Comprehend determines the sentiment of the extracted text and its language.
- The extracted text is translated to English using Amazon Translate.
- Amazon Polly synthesizes an audio file from the extracted text.

The full app can be deployed with the AWS CDK. For source code and deployment instructions, see the project in [GitHub](#).

Services used in this example

- Amazon Comprehend
- Lambda
- Amazon Polly
- Amazon Textract

- Amazon Translate

For a complete list of AWS SDK developer guides and code examples, see [Using Lambda with an AWS SDK](#). This topic also includes information about getting started and details about previous SDK versions.

Invoke a Lambda function from a browser

The following code example shows how to invoke an AWS Lambda function from a browser.

JavaScript

SDK for JavaScript (v2)

You can create a browser-based application that uses an AWS Lambda function to update an Amazon DynamoDB table with user selections.

For complete source code and instructions on how to set up and run, see the full example on [GitHub](#).

Services used in this example

- DynamoDB
- Lambda

SDK for JavaScript (v3)

You can create a browser-based application that uses an AWS Lambda function to update an Amazon DynamoDB table with user selections. This app uses AWS SDK for JavaScript v3.

For complete source code and instructions on how to set up and run, see the full example on [GitHub](#).

Services used in this example

- DynamoDB
- Lambda

For a complete list of AWS SDK developer guides and code examples, see [Using Lambda with an AWS SDK](#). This topic also includes information about getting started and details about previous SDK versions.

Transform data for your application with S3 Object Lambda

The following code example shows how to transform data for your application with S3 Object Lambda.

.NET

AWS SDK for .NET

Shows how to add custom code to standard S3 GET requests to modify the requested object retrieved from S3 so that the object suit the needs of the requesting client or application.

For complete source code and instructions on how to set up and run, see the full example on [GitHub](#).

Services used in this example

- Lambda
- Amazon S3

For a complete list of AWS SDK developer guides and code examples, see [Using Lambda with an AWS SDK](#). This topic also includes information about getting started and details about previous SDK versions.

Use API Gateway to invoke a Lambda function

The following code examples show how to create an AWS Lambda function invoked by Amazon API Gateway.

Java

SDK for Java 2.x

Shows how to create an AWS Lambda function by using the Lambda Java runtime API. This example invokes different AWS services to perform a specific use case. This example demonstrates how to create a Lambda function invoked by Amazon API Gateway that scans an Amazon DynamoDB table for work anniversaries and uses Amazon Simple Notification Service (Amazon SNS) to send a text message to your employees that congratulates them at their one year anniversary date.

For complete source code and instructions on how to set up and run, see the full example on [GitHub](#).

Services used in this example

- API Gateway
- DynamoDB
- Lambda
- Amazon SNS

JavaScript

SDK for JavaScript (v3)

Shows how to create an AWS Lambda function by using the Lambda JavaScript runtime API. This example invokes different AWS services to perform a specific use case. This example demonstrates how to create a Lambda function invoked by Amazon API Gateway that scans an Amazon DynamoDB table for work anniversaries and uses Amazon Simple Notification Service (Amazon SNS) to send a text message to your employees that congratulates them at their one year anniversary date.

For complete source code and instructions on how to set up and run, see the full example on [GitHub](#).

This example is also available in the [AWS SDK for JavaScript v3 developer guide](#).

Services used in this example

- API Gateway
- DynamoDB
- Lambda
- Amazon SNS

Python

SDK for Python (Boto3)

This example shows how to create and use an Amazon API Gateway REST API that targets an AWS Lambda function. The Lambda handler demonstrates how to route based on HTTP

methods; how to get data from the query string, header, and body; and how to return a JSON response.

- Deploy a Lambda function.
- Create an API Gateway REST API.
- Create a REST resource that targets the Lambda function.
- Grant permission to let API Gateway invoke the Lambda function.
- Use the Requests package to send requests to the REST API.
- Clean up all resources created during the demo.

This example is best viewed on GitHub. For complete source code and instructions on how to set up and run, see the full example on [GitHub](#).

Services used in this example

- API Gateway
- Lambda

For a complete list of AWS SDK developer guides and code examples, see [Using Lambda with an AWS SDK](#). This topic also includes information about getting started and details about previous SDK versions.

Use Step Functions to invoke Lambda functions

The following code example shows how to create an AWS Step Functions state machine that invokes AWS Lambda functions in sequence.

Java

SDK for Java 2.x

Shows how to create an AWS serverless workflow by using AWS Step Functions and the AWS SDK for Java 2.x. Each workflow step is implemented using an AWS Lambda function.

For complete source code and instructions on how to set up and run, see the full example on [GitHub](#).

Services used in this example

- DynamoDB
- Lambda

- Amazon SES
- Step Functions

For a complete list of AWS SDK developer guides and code examples, see [Using Lambda with an AWS SDK](#). This topic also includes information about getting started and details about previous SDK versions.

Use scheduled events to invoke a Lambda function

The following code examples show how to create an AWS Lambda function invoked by an Amazon EventBridge scheduled event.

Java

SDK for Java 2.x

Shows how to create an Amazon EventBridge scheduled event that invokes an AWS Lambda function. Configure EventBridge to use a cron expression to schedule when the Lambda function is invoked. In this example, you create a Lambda function by using the Lambda Java runtime API. This example invokes different AWS services to perform a specific use case. This example demonstrates how to create an app that sends a mobile text message to your employees that congratulates them at the one year anniversary date.

For complete source code and instructions on how to set up and run, see the full example on [GitHub](#).

Services used in this example

- DynamoDB
- EventBridge
- Lambda
- Amazon SNS

JavaScript

SDK for JavaScript (v3)

Shows how to create an Amazon EventBridge scheduled event that invokes an AWS Lambda function. Configure EventBridge to use a cron expression to schedule when the Lambda

function is invoked. In this example, you create a Lambda function by using the Lambda JavaScript runtime API. This example invokes different AWS services to perform a specific use case. This example demonstrates how to create an app that sends a mobile text message to your employees that congratulates them at the one year anniversary date.

For complete source code and instructions on how to set up and run, see the full example on [GitHub](#).

This example is also available in the [AWS SDK for JavaScript v3 developer guide](#).

Services used in this example

- DynamoDB
- EventBridge
- Lambda
- Amazon SNS

Python

SDK for Python (Boto3)

This example shows how to register an AWS Lambda function as the target of a scheduled Amazon EventBridge event. The Lambda handler writes a friendly message and the full event data to Amazon CloudWatch Logs for later retrieval.

- Deploys a Lambda function.
- Creates an EventBridge scheduled event and makes the Lambda function the target.
- Grants permission to let EventBridge invoke the Lambda function.
- Prints the latest data from CloudWatch Logs to show the result of the scheduled invocations.
- Cleans up all resources created during the demo.

This example is best viewed on GitHub. For complete source code and instructions on how to set up and run, see the full example on [GitHub](#).

Services used in this example

- CloudWatch Logs
- EventBridge
- Lambda

For a complete list of AWS SDK developer guides and code examples, see [Using Lambda with an AWS SDK](#). This topic also includes information about getting started and details about previous SDK versions.

Write custom activity data with a Lambda function after Amazon Cognito user authentication using an AWS SDK

The following code example shows how to write custom activity data with a Lambda function after Amazon Cognito user authentication.

- Use administrator functions to add a user to a user pool.
- Configure a user pool to call a Lambda function for the `PostAuthentication` trigger.
- Sign the new user in to Amazon Cognito.
- The Lambda function writes custom information to CloudWatch Logs and to an DynamoDB table.
- Get and display custom data from the DynamoDB table, then clean up resources.

Go

SDK for Go V2

Note

There's more on GitHub. Find the complete example and learn how to set up and run in the [AWS Code Examples Repository](#).

Run an interactive scenario at a command prompt.

```
import (  
    "context"  
    "errors"  
    "log"  
    "strings"  
    "user_pools_and_lambda_triggers/actions"  
  
    "github.com/aws/aws-sdk-go-v2/aws"  
    "github.com/aws/aws-sdk-go-v2/service/cognitoidentityprovider"
```

```

"github.com/aws/aws-sdk-go-v2/service/cognitoidentityprovider/types"
"github.com/awsdocs/aws-doc-sdk-examples/gov2/demotools"
)

// ActivityLog separates the steps of this scenario into individual functions so
// that
// they are simpler to read and understand.
type ActivityLog struct {
    helper      IScenarioHelper
    questioner  demotools.IQuestioner
    resources   Resources
    cognitoActor *actions.CognitoActions
}

// NewActivityLog constructs a new activity log runner.
func NewActivityLog(sdkConfig aws.Config, questioner demotools.IQuestioner,
    helper IScenarioHelper) ActivityLog {
    scenario := ActivityLog{
        helper:      helper,
        questioner:  questioner,
        resources:   Resources{},
        cognitoActor: &actions.CognitoActions{CognitoClient:
cognitoidentityprovider.NewFromConfig(sdkConfig)},
    }
    scenario.resources.init(scenario.cognitoActor, questioner)
    return scenario
}

// AddUserToPool selects a user from the known users table and uses administrator
// credentials to add the user to the user pool.
func (runner *ActivityLog) AddUserToPool(ctx context.Context, userPoolId string,
    tableName string) (string, string) {
    log.Println("To facilitate this example, let's add a user to the user pool using
administrator privileges.")
    users, err := runner.helper.GetKnownUsers(ctx, tableName)
    if err != nil {
        panic(err)
    }
    user := users.Users[0]
    log.Printf("Adding known user %v to the user pool.\n", user.UserName)
    err = runner.cognitoActor.AdminCreateUser(ctx, userPoolId, user.UserName,
user.UserEmail)
    if err != nil {
        panic(err)
    }
}

```

```
}
pwSet := false
password := runner.questioner.AskPassword("\nEnter a password that has at least
eight characters, uppercase, lowercase, numbers and symbols.\n"+
"(the password will not display as you type):", 8)
for !pwSet {
    log.Printf("\nSetting password for user '%v'.\n", user.UserName)
    err = runner.cognitoActor.AdminSetUserPassword(ctx, userPoolId, user.UserName,
password)
    if err != nil {
        var invalidPassword *types.InvalidPasswordException
        if errors.As(err, &invalidPassword) {
            password = runner.questioner.AskPassword("\nEnter another password:", 8)
        } else {
            panic(err)
        }
    } else {
        pwSet = true
    }
}

log.Println(strings.Repeat("-", 88))

return user.UserName, password
}

// AddActivityLogTrigger adds a Lambda handler as an invocation target for the
PostAuthentication trigger.
func (runner *ActivityLog) AddActivityLogTrigger(ctx context.Context, userPoolId
string, activityLogArn string) {
    log.Println("Let's add a Lambda function to handle the PostAuthentication
trigger from Cognito.\n" +
"This trigger happens after a user is authenticated, and lets your function
take action, such as logging\n" +
"the outcome.")
    err := runner.cognitoActor.UpdateTriggers(
        ctx, userPoolId,
        actions.TriggerInfo{Trigger: actions.PostAuthentication, HandlerArn:
aws.String(activityLogArn)})
    if err != nil {
        panic(err)
    }
    runner.resources.triggers = append(runner.resources.triggers,
actions.PostAuthentication)
```

```
log.Printf("Lambda function %v added to user pool %v to handle
PostAuthentication Cognito trigger.\n",
    activityLogArn, userPoolId)

log.Println(strings.Repeat("-", 88))
}

// SignInUser signs in as the specified user.
func (runner *ActivityLog) SignInUser(ctx context.Context, clientId string,
    userName string, password string) {
    log.Printf("Now we'll sign in user %v and check the results in the logs and the
    DynamoDB table.", userName)
    runner.questioner.Ask("Press Enter when you're ready.")
    authResult, err := runner.cognitoActor.SignIn(ctx, clientId, userName, password)
    if err != nil {
        panic(err)
    }
    log.Println("Sign in successful.",
        "The PostAuthentication Lambda handler writes custom information to CloudWatch
        Logs.")

    runner.resources.userAccessTokens = append(runner.resources.userAccessTokens,
        *authResult.AccessToken)
}

// GetKnownUserLastLogin gets the login info for a user from the Amazon DynamoDB
table and displays it.
func (runner *ActivityLog) GetKnownUserLastLogin(ctx context.Context, tableName
    string, userName string) {
    log.Println("The PostAuthentication handler also writes login data to the
    DynamoDB table.")
    runner.questioner.Ask("Press Enter when you're ready to continue.")
    users, err := runner.helper.GetKnownUsers(ctx, tableName)
    if err != nil {
        panic(err)
    }
    for _, user := range users.Users {
        if user.UserName == userName {
            log.Println("The last login info for the user in the known users table is:")
            log.Printf("\t%+v", *user.LastLogin)
        }
    }
    log.Println(strings.Repeat("-", 88))
}
```

```
// Run runs the scenario.
func (runner *ActivityLog) Run(ctx context.Context, stackName string) {
    defer func() {
        if r := recover(); r != nil {
            log.Println("Something went wrong with the demo.")
            runner.resources.Cleanup(ctx)
        }
    }()

    log.Println(strings.Repeat("-", 88))
    log.Printf("Welcome\n")

    log.Println(strings.Repeat("-", 88))

    stackOutputs, err := runner.helper.GetStackOutputs(ctx, stackName)
    if err != nil {
        panic(err)
    }
    runner.resources.userPoolId = stackOutputs["UserPoolId"]
    runner.helper.PopulateUserTable(ctx, stackOutputs["TableName"])
    userName, password := runner.AddUserToPool(ctx, stackOutputs["UserPoolId"],
        stackOutputs["TableName"])

    runner.AddActivityLogTrigger(ctx, stackOutputs["UserPoolId"],
        stackOutputs["ActivityLogFunctionArn"])
    runner.SignInUser(ctx, stackOutputs["UserPoolClientId"], userName, password)
    runner.helper.ListRecentLogEvents(ctx, stackOutputs["ActivityLogFunction"])
    runner.GetKnownUserLastLogin(ctx, stackOutputs["TableName"], userName)

    runner.resources.Cleanup(ctx)

    log.Println(strings.Repeat("-", 88))
    log.Println("Thanks for watching!")
    log.Println(strings.Repeat("-", 88))
}
}
```

Handle the `PostAuthentication` trigger with a Lambda function.

```
import (
```

```

"context"
"fmt"
"log"
"os"
"time"

"github.com/aws/aws-lambda-go/events"
"github.com/aws/aws-lambda-go/lambda"
"github.com/aws/aws-sdk-go-v2/aws"
"github.com/aws/aws-sdk-go-v2/config"
"github.com/aws/aws-sdk-go-v2/feature/dynamodb/attributevalue"
"github.com/aws/aws-sdk-go-v2/service/dynamodb"
dynamodbtypes "github.com/aws/aws-sdk-go-v2/service/dynamodb/types"
)

const TABLE_NAME = "TABLE_NAME"

// LoginInfo defines structured login data that can be marshalled to a DynamoDB
// format.
type LoginInfo struct {
    UserPoolId string `dynamodbav:"UserPoolId"`
    ClientId   string `dynamodbav:"ClientId"`
    Time      string `dynamodbav:"Time"`
}

// UserInfo defines structured user data that can be marshalled to a DynamoDB
// format.
type UserInfo struct {
    UserName   string `dynamodbav:"UserName"`
    UserEmail  string `dynamodbav:"UserEmail"`
    LastLogin  LoginInfo `dynamodbav:"LastLogin"`
}

// GetKey marshals the user email value to a DynamoDB key format.
func (user UserInfo) GetKey() map[string]dynamodbtypes.AttributeValue {
    userEmail, err := attributevalue.Marshal(user.UserEmail)
    if err != nil {
        panic(err)
    }
    return map[string]dynamodbtypes.AttributeValue{"UserEmail": userEmail}
}

type handler struct {
    dynamoClient *dynamodb.Client

```

```
}

// HandleRequest handles the PostAuthentication event by writing custom data to
// the logs and
// to an Amazon DynamoDB table.
func (h *handler) HandleRequest(ctx context.Context,
    event events.CognitoEventUserPoolsPostAuthentication)
    (events.CognitoEventUserPoolsPostAuthentication, error) {
    log.Printf("Received post authentication trigger from %v for user '%v'",
        event.TriggerSource, event.UserName)
    tableName := os.Getenv(TABLE_NAME)
    user := UserInfo{
        UserName:    event.UserName,
        UserEmail:   event.Request.UserAttributes["email"],
        LastLogin:   LoginInfo{
            UserPoolId: event.UserPoolID,
            ClientId:   event CallerContext.ClientID,
            Time:       time.Now().Format(time.UnixDate),
        },
    }
}
// Write to CloudWatch Logs.
fmt.Printf("%#v", user)

// Also write to an external system. This examples uses DynamoDB to demonstrate.
userMap, err := attributevalue.MarshalMap(user)
if err != nil {
    log.Printf("Couldn't marshal to DynamoDB map. Here's why: %v\n", err)
} else if len(userMap) == 0 {
    log.Printf("User info marshaled to an empty map.")
} else {
    _, err := h.dynamoClient.PutItem(ctx, &dynamodb.PutItemInput{
        Item:      userMap,
        TableName: aws.String(tableName),
    })
    if err != nil {
        log.Printf("Couldn't write to DynamoDB. Here's why: %v\n", err)
    } else {
        log.Printf("Wrote user info to DynamoDB table %v.\n", tableName)
    }
}

return event, nil
}
```

```
func main() {
    ctx := context.Background()
    sdkConfig, err := config.LoadDefaultConfig(ctx)
    if err != nil {
        log.Panicln(err)
    }
    h := handler{
        dynamoClient: dynamodb.NewFromConfig(sdkConfig),
    }
    lambda.Start(h.HandleRequest)
}
```

Create a struct that performs common tasks.

```
import (
    "context"
    "log"
    "strings"
    "time"
    "user_pools_and_lambda_triggers/actions"

    "github.com/aws/aws-sdk-go-v2/aws"
    "github.com/aws/aws-sdk-go-v2/service/cloudformation"
    "github.com/aws/aws-sdk-go-v2/service/cloudwatchlogs"
    "github.com/aws/aws-sdk-go-v2/service/dynamodb"
    "github.com/awsdocs/aws-doc-sdk-examples/gov2/demotools"
)

// IScenarioHelper defines common functions used by the workflows in this
// example.
type IScenarioHelper interface {
    Pause(secs int)
    GetStackOutputs(ctx context.Context, stackName string) (actions.StackOutputs,
        error)
    PopulateUserTable(ctx context.Context, tableName string)
    GetKnownUsers(ctx context.Context, tableName string) (actions.UserList, error)
    AddKnownUser(ctx context.Context, tableName string, user actions.User)
    ListRecentLogEvents(ctx context.Context, functionName string)
}
```



```
// ScenarioHelper contains AWS wrapper structs used by the workflows in this
// example.
type ScenarioHelper struct {
    questioner demotools.IQuestioner
    dynamoActor *actions.DynamoActions
    cfnActor     *actions.CloudFormationActions
    cwlActor     *actions.CloudWatchLogsActions
    isTestRun    bool
}

// NewScenarioHelper constructs a new scenario helper.
func NewScenarioHelper(sdkConfig aws.Config, questioner demotools.IQuestioner)
    ScenarioHelper {
    scenario := ScenarioHelper{
        questioner: questioner,
        dynamoActor: &actions.DynamoActions{DynamoClient:
            dynamodb.NewFromConfig(sdkConfig)},
        cfnActor: &actions.CloudFormationActions{CfnClient:
            cloudformation.NewFromConfig(sdkConfig)},
        cwlActor: &actions.CloudWatchLogsActions{CwlClient:
            cloudwatchlogs.NewFromConfig(sdkConfig)},
    }
    return scenario
}

// Pause waits for the specified number of seconds.
func (helper ScenarioHelper) Pause(secs int) {
    if !helper.isTestRun {
        time.Sleep(time.Duration(secs) * time.Second)
    }
}

// GetStackOutputs gets the outputs from the specified CloudFormation stack in a
// structured format.
func (helper ScenarioHelper) GetStackOutputs(ctx context.Context, stackName
    string) (actions.StackOutputs, error) {
    return helper.cfnActor.GetOutputs(ctx, stackName), nil
}

// PopulateUserTable fills the known user table with example data.
func (helper ScenarioHelper) PopulateUserTable(ctx context.Context, tableName
    string) {
    log.Printf("First, let's add some users to the DynamoDB %v table we'll use for
    this example.\n", tableName)
}
```

```
err := helper.dynamoActor.PopulateTable(ctx, tableName)
if err != nil {
    panic(err)
}

// GetKnownUsers gets the users from the known users table in a structured
// format.
func (helper ScenarioHelper) GetKnownUsers(ctx context.Context, tableName string)
(actions.UserList, error) {
    knownUsers, err := helper.dynamoActor.Scan(ctx, tableName)
    if err != nil {
        log.Printf("Couldn't get known users from table %v. Here's why: %v\n",
            tableName, err)
    }
    return knownUsers, err
}

// AddKnownUser adds a user to the known users table.
func (helper ScenarioHelper) AddKnownUser(ctx context.Context, tableName string,
    user actions.User) {
    log.Printf("Adding user '%v' with email '%v' to the DynamoDB known users
        table...\n",
        user.UserName, user.UserEmail)
    err := helper.dynamoActor.AddUser(ctx, tableName, user)
    if err != nil {
        panic(err)
    }
}

// ListRecentLogEvents gets the most recent log stream and events for the
// specified Lambda function and displays them.
func (helper ScenarioHelper) ListRecentLogEvents(ctx context.Context,
    functionName string) {
    log.Println("Waiting a few seconds to let Lambda write to CloudWatch Logs...")
    helper.Pause(10)
    log.Println("Okay, let's check the logs to find what's happened recently with
        your Lambda function.")
    logStream, err := helper.cwlActor.GetLatestLogStream(ctx, functionName)
    if err != nil {
        panic(err)
    }
    log.Printf("Getting some recent events from log stream %v\n",
        *logStream.LogStreamName)
```

```

events, err := helper.cwlActor.GetLogEvents(ctx, functionName,
*logStream.LogStreamName, 10)
if err != nil {
    panic(err)
}
for _, event := range events {
    log.Printf("\t%v", *event.Message)
}
log.Println(strings.Repeat("-", 88))
}

```

Create a struct that wraps Amazon Cognito actions.

```

import (
    "context"
    "errors"
    "log"

    "github.com/aws/aws-sdk-go-v2/aws"
    "github.com/aws/aws-sdk-go-v2/service/cognitoidentityprovider"
    "github.com/aws/aws-sdk-go-v2/service/cognitoidentityprovider/types"
)

type CognitoActions struct {
    CognitoClient *cognitoidentityprovider.Client
}

// Trigger and TriggerInfo define typed data for updating an Amazon Cognito
trigger.
type Trigger int

const (
    PreSignUp Trigger = iota
    UserMigration
    PostAuthentication
)

type TriggerInfo struct {

```

```
    Trigger    Trigger
    HandlerArn *string
}

// UpdateTriggers adds or removes Lambda triggers for a user pool. When a trigger
// is specified with a `nil` value,
// it is removed from the user pool.
func (actor CognitoActions) UpdateTriggers(ctx context.Context, userPoolId
    string, triggers ...TriggerInfo) error {
    output, err := actor.CognitoClient.DescribeUserPool(ctx,
    &cognitoidentityprovider.DescribeUserPoolInput{
        UserPoolId: aws.String(userPoolId),
    })
    if err != nil {
        log.Printf("Couldn't get info about user pool %v. Here's why: %v\n",
        userPoolId, err)
        return err
    }
    lambdaConfig := output.UserPool.LambdaConfig
    for _, trigger := range triggers {
        switch trigger.Trigger {
        case PreSignUp:
            lambdaConfig.PreSignUp = trigger.HandlerArn
        case UserMigration:
            lambdaConfig.UserMigration = trigger.HandlerArn
        case PostAuthentication:
            lambdaConfig.PostAuthentication = trigger.HandlerArn
        }
    }
    _, err = actor.CognitoClient.UpdateUserPool(ctx,
    &cognitoidentityprovider.UpdateUserPoolInput{
        UserPoolId:    aws.String(userPoolId),
        LambdaConfig:  lambdaConfig,
    })
    if err != nil {
        log.Printf("Couldn't update user pool %v. Here's why: %v\n", userPoolId, err)
    }
    return err
}

// SignUp signs up a user with Amazon Cognito.
```

```
func (actor CognitoActions) SignUp(ctx context.Context, clientId string, userName
string, password string, userEmail string) (bool, error) {
    confirmed := false
    output, err := actor.CognitoClient.SignUp(ctx,
    &cognitoidentityprovider.SignUpInput{
        ClientId: aws.String(clientId),
        Password: aws.String(password),
        Username: aws.String(userName),
        UserAttributes: []types.AttributeType{
            {Name: aws.String("email"), Value: aws.String(userEmail)},
        },
    })
    if err != nil {
        var invalidPassword *types.InvalidPasswordException
        if errors.As(err, &invalidPassword) {
            log.Println(*invalidPassword.Message)
        } else {
            log.Printf("Couldn't sign up user %v. Here's why: %v\n", userName, err)
        }
    } else {
        confirmed = output.UserConfirmed
    }
    return confirmed, err
}

// SignIn signs in a user to Amazon Cognito using a username and password
authentication flow.
func (actor CognitoActions) SignIn(ctx context.Context, clientId string, userName
string, password string) (*types.AuthenticationResultType, error) {
    var authResult *types.AuthenticationResultType
    output, err := actor.CognitoClient.InitiateAuth(ctx,
    &cognitoidentityprovider.InitiateAuthInput{
        AuthFlow:      "USER_PASSWORD_AUTH",
        ClientId:      aws.String(clientId),
        AuthParameters: map[string]string{"USERNAME": userName, "PASSWORD": password},
    })
    if err != nil {
        var resetRequired *types.PasswordResetRequiredException
        if errors.As(err, &resetRequired) {
            log.Println(*resetRequired.Message)
        } else {
            log.Printf("Couldn't sign in user %v. Here's why: %v\n", userName, err)
        }
    }
}
```

```
    }
  } else {
    authResult = output.AuthenticationResult
  }
  return authResult, err
}

// ForgotPassword starts a password recovery flow for a user. This flow typically
// sends a confirmation code
// to the user's configured notification destination, such as email.
func (actor CognitoActions) ForgotPassword(ctx context.Context, clientId string,
  userName string) (*types.CodeDeliveryDetailsType, error) {
  output, err := actor.CognitoClient.ForgotPassword(ctx,
    &cognitoidentityprovider.ForgotPasswordInput{
      ClientId: aws.String(clientId),
      Username: aws.String(userName),
    })
  if err != nil {
    log.Printf("Couldn't start password reset for user '%v'. Here's why: %v\n",
      userName, err)
  }
  return output.CodeDeliveryDetails, err
}

// ConfirmForgotPassword confirms a user with a confirmation code and a new
// password.
func (actor CognitoActions) ConfirmForgotPassword(ctx context.Context, clientId
  string, code string, userName string, password string) error {
  _, err := actor.CognitoClient.ConfirmForgotPassword(ctx,
    &cognitoidentityprovider.ConfirmForgotPasswordInput{
      ClientId:      aws.String(clientId),
      ConfirmationCode: aws.String(code),
      Password:      aws.String(password),
      Username:      aws.String(userName),
    })
  if err != nil {
    var invalidPassword *types.InvalidPasswordException
    if errors.As(err, &invalidPassword) {
      log.Println(*invalidPassword.Message)
    } else {

```

```
    log.Printf("Couldn't confirm user %v. Here's why: %v", userName, err)
  }
}
return err
}

// DeleteUser removes a user from the user pool.
func (actor CognitoActions) DeleteUser(ctx context.Context, userAccessToken
string) error {
  _, err := actor.CognitoClient.DeleteUser(ctx,
&cognitoidentityprovider.DeleteUserInput{
  AccessToken: aws.String(userAccessToken),
})
  if err != nil {
    log.Printf("Couldn't delete user. Here's why: %v\n", err)
  }
  return err
}

// AdminCreateUser uses administrator credentials to add a user to a user pool.
This method leaves the user
// in a state that requires they enter a new password next time they sign in.
func (actor CognitoActions) AdminCreateUser(ctx context.Context, userPoolId
string, userName string, userEmail string) error {
  _, err := actor.CognitoClient.AdminCreateUser(ctx,
&cognitoidentityprovider.AdminCreateUserInput{
  UserPoolId:      aws.String(userPoolId),
  Username:        aws.String(userName),
  MessageAction:   types.MessageActionTypeSuppress,
  UserAttributes: []types.AttributeType{{Name: aws.String("email"), Value:
aws.String(userEmail)}}},
})
  if err != nil {
    var userExists *types.UsernameExistsException
    if errors.As(err, &userExists) {
      log.Printf("User %v already exists in the user pool.", userName)
      err = nil
    } else {
      log.Printf("Couldn't create user %v. Here's why: %v\n", userName, err)
    }
  }
}
```

```

    }
    return err
}

// AdminSetUserPassword uses administrator credentials to set a password for a
// user without requiring a
// temporary password.
func (actor CognitoActions) AdminSetUserPassword(ctx context.Context, userPoolId
string, userName string, password string) error {
    _, err := actor.CognitoClient.AdminSetUserPassword(ctx,
&cognitoidentityprovider.AdminSetUserPasswordInput{
    Password:    aws.String(password),
    UserPoolId:  aws.String(userPoolId),
    Username:    aws.String(userName),
    Permanent:   true,
})
    if err != nil {
        var invalidPassword *types.InvalidPasswordException
        if errors.As(err, &invalidPassword) {
            log.Println(*invalidPassword.Message)
        } else {
            log.Printf("Couldn't set password for user %v. Here's why: %v\n", userName,
err)
        }
    }
    return err
}

```

Create a struct that wraps DynamoDB actions.

```

import (
    "context"
    "fmt"
    "log"

    "github.com/aws/aws-sdk-go-v2/aws"
    "github.com/aws/aws-sdk-go-v2/feature/dynamodb/attributevalue"
    "github.com/aws/aws-sdk-go-v2/service/dynamodb"

```



```
"github.com/aws/aws-sdk-go-v2/service/dynamodb/types"
)

// DynamoActions encapsulates the Amazon Simple Notification Service (Amazon SNS)
actions
// used in the examples.
type DynamoActions struct {
    DynamoClient *dynamodb.Client
}

// User defines structured user data.
type User struct {
    UserName string
    UserEmail string
    LastLogin *LoginInfo `dynamodbav:",omitempty"`
}

// LoginInfo defines structured custom login data.
type LoginInfo struct {
    UserPoolId string
    ClientId string
    Time string
}

// UserList defines a list of users.
type UserList struct {
    Users []User
}

// UserNameList returns the usernames contained in a UserList as a list of
strings.
func (users *UserList) UserNameList() []string {
    names := make([]string, len(users.Users))
    for i := 0; i < len(users.Users); i++ {
        names[i] = users.Users[i].UserName
    }
    return names
}

// PopulateTable adds a set of test users to the table.
func (actor DynamoActions) PopulateTable(ctx context.Context, tableName string)
error {
    var err error
    var item map[string]types.AttributeValue
```

```
var writeReqs []types.WriteRequest
for i := 1; i < 4; i++ {
    item, err = attributevalue.MarshalMap(User{UserName: fmt.Sprintf("test_user_
%v", i), userEmail: fmt.Sprintf("test_email_%v@example.com", i)})
    if err != nil {
        log.Printf("Couldn't marshall user into DynamoDB format. Here's why: %v\n",
err)
        return err
    }
    writeReqs = append(writeReqs, types.WriteRequest{PutRequest:
&types.PutRequest{Item: item}})
}
_, err = actor.DynamoClient.BatchWriteItem(ctx, &dynamodb.BatchWriteItemInput{
    RequestItems: map[string][]types.WriteRequest{tableName: writeReqs},
})
if err != nil {
    log.Printf("Couldn't populate table %v with users. Here's why: %v\n",
tableName, err)
}
return err
}

// Scan scans the table for all items.
func (actor DynamoActions) Scan(ctx context.Context, tableName string) (UserList,
error) {
    var userList UserList
    output, err := actor.DynamoClient.Scan(ctx, &dynamodb.ScanInput{
        TableName: aws.String(tableName),
    })
    if err != nil {
        log.Printf("Couldn't scan table %v for items. Here's why: %v\n", tableName,
err)
    } else {
        err = attributevalue.UnmarshalListOfMaps(output.Items, &userList.Users)
        if err != nil {
            log.Printf("Couldn't unmarshal items into users. Here's why: %v\n", err)
        }
    }
    return userList, err
}

// AddUser adds a user item to a table.
func (actor DynamoActions) AddUser(ctx context.Context, tableName string, user
User) error {
```

```

userItem, err := attributevalue.MarshalMap(user)
if err != nil {
    log.Printf("Couldn't marshall user to item. Here's why: %v\n", err)
}
_, err = actor.DynamoClient.PutItem(ctx, &dynamodb.PutItemInput{
    Item:      userItem,
    TableName: aws.String(tableName),
})
if err != nil {
    log.Printf("Couldn't put item in table %v. Here's why: %v", tableName, err)
}
return err
}

```

Create a struct that wraps CloudWatch Logs actions.

```

import (
    "context"
    "fmt"
    "log"

    "github.com/aws/aws-sdk-go-v2/aws"
    "github.com/aws/aws-sdk-go-v2/service/cloudwatchlogs"
    "github.com/aws/aws-sdk-go-v2/service/cloudwatchlogs/types"
)

type CloudWatchLogsActions struct {
    CwlClient *cloudwatchlogs.Client
}

// GetLatestLogStream gets the most recent log stream for a Lambda function.
func (actor CloudWatchLogsActions) GetLatestLogStream(ctx context.Context,
    functionName string) (types.LogStream, error) {
    var logStream types.LogStream
    logGroupName := fmt.Sprintf("/aws/lambda/%s", functionName)
    output, err := actor.CwlClient.DescribeLogStreams(ctx,
    &cloudwatchlogs.DescribeLogStreamsInput{
        Descending:  aws.Bool(true),
        Limit:       aws.Int32(1),
        LogGroupName: aws.String(logGroupName),
    })

```

```

    OrderBy:      types.OrderByLastEventTime,
  })
  if err != nil {
    log.Printf("Couldn't get log streams for log group %v. Here's why: %v\n",
      logGroupName, err)
  } else {
    logStream = output.LogStreams[0]
  }
  return logStream, err
}

// GetLogEvents gets the most recent eventCount events from the specified log
// stream.
func (actor CloudWatchLogsActions) GetLogEvents(ctx context.Context, functionName
  string, logStreamName string, eventCount int32) (
  []types.OutputLogEvent, error) {
  var events []types.OutputLogEvent
  logGroupName := fmt.Sprintf("/aws/lambda/%s", functionName)
  output, err := actor.CwlClient.GetLogEvents(ctx,
    &cloudwatchlogs.GetLogEventsInput{
      LogStreamName: aws.String(logStreamName),
      Limit:         aws.Int32(eventCount),
      LogGroupName:  aws.String(logGroupName),
    })
  if err != nil {
    log.Printf("Couldn't get log event for log stream %v. Here's why: %v\n",
      logStreamName, err)
  } else {
    events = output.Events
  }
  return events, err
}

```

Create a struct that wraps AWS CloudFormation actions.

```

import (
  "context"
  "log"

  "github.com/aws/aws-sdk-go-v2/aws"

```

```

    "github.com/aws/aws-sdk-go-v2/service/cloudformation"
)

// StackOutputs defines a map of outputs from a specific stack.
type StackOutputs map[string]string

type CloudFormationActions struct {
    CfnClient *cloudformation.Client
}

// GetOutputs gets the outputs from a CloudFormation stack and puts them into a
// structured format.
func (actor CloudFormationActions) GetOutputs(ctx context.Context, stackName
string) StackOutputs {
    output, err := actor.CfnClient.DescribeStacks(ctx,
&cloudformation.DescribeStacksInput{
    StackName: aws.String(stackName),
})
    if err != nil || len(output.Stacks) == 0 {
        log.Panicf("Couldn't find a CloudFormation stack named %v. Here's why: %v\n",
stackName, err)
    }
    stackOutputs := StackOutputs{}
    for _, out := range output.Stacks[0].Outputs {
        stackOutputs[*out.OutputKey] = *out.OutputValue
    }
    return stackOutputs
}

```

Clean up resources.

```

import (
    "context"
    "log"
    "user_pools_and_lambda_triggers/actions"

    "github.com/awsdocs/aws-doc-sdk-examples/gov2/demotools"
)

// Resources keeps track of AWS resources created during an example and handles

```

```

// cleanup when the example finishes.
type Resources struct {
    userPoolId      string
    userAccessTokens []string
    triggers        []actions.Trigger

    cognitoActor *actions.CognitoActions
    questioner   demotools.IQuestioner
}

func (resources *Resources) init(cognitoActor *actions.CognitoActions, questioner
demotools.IQuestioner) {
    resources.userAccessTokens = []string{}
    resources.triggers = []actions.Trigger{}
    resources.cognitoActor = cognitoActor
    resources.questioner = questioner
}

// Cleanup deletes all AWS resources created during an example.
func (resources *Resources) Cleanup(ctx context.Context) {
    defer func() {
        if r := recover(); r != nil {
            log.Printf("Something went wrong during cleanup.\n%v\n", r)
            log.Println("Use the AWS Management Console to remove any remaining resources
\n" +
                "that were created for this scenario.")
        }
    }()

    wantDelete := resources.questioner.AskBool("Do you want to remove all of the AWS
resources that were created "+
        "during this demo (y/n)?", "y")
    if wantDelete {
        for _, accessToken := range resources.userAccessTokens {
            err := resources.cognitoActor.DeleteUser(ctx, accessToken)
            if err != nil {
                log.Println("Couldn't delete user during cleanup.")
                panic(err)
            }
            log.Println("Deleted user.")
        }
        triggerList := make([]actions.TriggerInfo, len(resources.triggers))
        for i := 0; i < len(resources.triggers); i++ {

```

```
    triggerList[i] = actions.TriggerInfo{Trigger: resources.triggers[i],
HandlerArn: nil}
}
err := resources.cognitoActor.UpdateTriggers(ctx, resources.userPoolId,
triggerList...)
if err != nil {
    log.Println("Couldn't update Cognito triggers during cleanup.")
    panic(err)
}
log.Println("Removed Cognito triggers from user pool.")
} else {
    log.Println("Be sure to remove resources when you're done with them to avoid
unexpected charges!")
}
}
```

- For API details, see the following topics in *AWS SDK for Go API Reference*.
 - [AdminCreateUser](#)
 - [AdminSetUserPassword](#)
 - [DeleteUser](#)
 - [InitiateAuth](#)
 - [UpdateUserPool](#)

For a complete list of AWS SDK developer guides and code examples, see [Using Lambda with an AWS SDK](#). This topic also includes information about getting started and details about previous SDK versions.

Serverless examples for Lambda using AWS SDKs

The following code examples show how to use Lambda with AWS SDKs.

Examples

- [Connecting to an Amazon RDS database in a Lambda function](#)
- [Invoke a Lambda function from a Kinesis trigger](#)
- [Invoke a Lambda function from a DynamoDB trigger](#)
- [Invoke a Lambda function from a Amazon DocumentDB trigger](#)

- [Invoke a Lambda function from an Amazon MSK trigger](#)
- [Invoke a Lambda function from an Amazon S3 trigger](#)
- [Invoke a Lambda function from an Amazon SNS trigger](#)
- [Invoke a Lambda function from an Amazon SQS trigger](#)
- [Reporting batch item failures for Lambda functions with a Kinesis trigger](#)
- [Reporting batch item failures for Lambda functions with a DynamoDB trigger](#)
- [Reporting batch item failures for Lambda functions with an Amazon SQS trigger](#)

Connecting to an Amazon RDS database in a Lambda function

The following code examples show how to implement a Lambda function that connects to an RDS database. The function makes a simple database request and returns the result.

.NET

AWS SDK for .NET

Note

There's more on GitHub. Find the complete example and learn how to set up and run in the [Serverless examples](#) repository.

Connecting to an Amazon RDS database in a Lambda function using .NET.

```
using System.Data;
using System.Text.Json;
using Amazon.Lambda.APIGatewayEvents;
using Amazon.Lambda.Core;
using MySql.Data.MySqlClient;

// Assembly attribute to enable the Lambda function's JSON input to be converted
// into a .NET class.
[assembly:
    LambdaSerializer(typeof(Amazon.Lambda.Serialization.SystemTextJson.DefaultLambdaJsonSerializer))]

namespace aws_rds;

public class InputModel
```



```
{
    public string key1 { get; set; }
    public string key2 { get; set; }
}

public class Function
{
    /// <summary>
    // Handles the Lambda function execution for connecting to RDS using IAM
    authentication.
    /// </summary>
    /// <param name="input">The input event data passed to the Lambda function</
    param>
    /// <param name="context">The Lambda execution context that provides runtime
    information</param>
    /// <returns>A response object containing the execution result</returns>

    public async Task<APIGatewayProxyResponse>
    FunctionHandler(APIGatewayProxyRequest request, ILambdaContext context)
    {
        // Sample Input: {"body": "{\"key1\": \"20\", \"key2\": \"25\"}"}
        var input = JsonSerializer.Deserialize<InputModel>(request.Body);

        /// Obtain authentication token
        var authToken = RDSAuthTokenGenerator.GenerateAuthToken(
            Environment.GetEnvironmentVariable("RDS_ENDPOINT"),
            Convert.ToInt32(Environment.GetEnvironmentVariable("RDS_PORT")),
            Environment.GetEnvironmentVariable("RDS_USERNAME")
        );

        /// Build the Connection String with the Token
        string connectionString =
        $"Server={Environment.GetEnvironmentVariable("RDS_ENDPOINT")};" +
        $"Port={Environment.GetEnvironmentVariable("RDS_PORT")};" +
        $"Uid={Environment.GetEnvironmentVariable("RDS_USERNAME")};" +
            $"Pwd={authToken}";

        try
        {
            await using var connection = new MySqlConnection(connectionString);
            await connection.OpenAsync();
        }
    }
}
```

```
        const string sql = "SELECT @param1 + @param2 AS Sum";

        await using var command = new MySqlCommand(sql, connection);
        command.Parameters.AddWithValue("@param1", int.Parse(input.key1 ??
"0"));
        command.Parameters.AddWithValue("@param2", int.Parse(input.key2 ??
"0"));

        await using var reader = await command.ExecuteReaderAsync();
        if (await reader.ReadAsync())
        {
            int result = reader.GetInt32("Sum");

            //Sample Response: {"statusCode":200,"body":{"\message\":"The
sum is: 45\"},"isBase64Encoded":false}
            return new APIGatewayProxyResponse
            {
                StatusCode = 200,
                Body = JsonSerializer.Serialize(new { message = $"The sum is:
{result}" })
            };
        }
    }
    catch (Exception ex)
    {
        Console.WriteLine($"Error: {ex.Message}");
    }

    return new APIGatewayProxyResponse
    {
        StatusCode = 500,
        Body = JsonSerializer.Serialize(new { error = "Internal server
error" })
    };
}
}
```

Go

SDK for Go V2

Note

There's more on GitHub. Find the complete example and learn how to set up and run in the [Serverless examples](#) repository.

Connecting to an Amazon RDS database in a Lambda function using Go.

```
/*
Golang v2 code here.
*/

package main

import (
    "context"
    "database/sql"
    "encoding/json"
    "fmt"
    "os"

    "github.com/aws/aws-lambda-go/lambda"
    "github.com/aws/aws-sdk-go-v2/config"
    "github.com/aws/aws-sdk-go-v2/feature/rds/auth"
    _ "github.com/go-sql-driver/mysql"
)

type MyEvent struct {
    Name string `json:"name"`
}

func HandleRequest(event *MyEvent) (map[string]interface{}, error) {

    var dbName string = os.Getenv("DatabaseName")
    var dbUser string = os.Getenv("DatabaseUser")
    var dbHost string = os.Getenv("DBHost") // Add hostname without https
    var dbPort int = os.Getenv("Port") // Add port number
    var dbEndpoint string = fmt.Sprintf("%s:%d", dbHost, dbPort)
    var region string = os.Getenv("AWS_REGION")
```

```
cfg, err := config.LoadDefaultConfig(context.TODO())
if err != nil {
    panic("configuration error: " + err.Error())
}

authenticationToken, err := auth.BuildAuthToken(
    context.TODO(), dbEndpoint, region, dbUser, cfg.Credentials)
if err != nil {
    panic("failed to create authentication token: " + err.Error())
}

dsn := fmt.Sprintf("%s:%s@tcp(%s)/%s?tls=true&allowCleartextPasswords=true",
    dbUser, authenticationToken, dbEndpoint, dbName,
)

db, err := sql.Open("mysql", dsn)
if err != nil {
    panic(err)
}

defer db.Close()

var sum int
err = db.QueryRow("SELECT ?+? AS sum", 3, 2).Scan(&sum)
if err != nil {
    panic(err)
}
s := fmt.Sprint(sum)
message := fmt.Sprintf("The selected sum is: %s", s)

messageBytes, err := json.Marshal(message)
if err != nil {
    return nil, err
}

messageString := string(messageBytes)
return map[string]interface{}{
    "statusCode": 200,
    "headers":    map[string]string{"Content-Type": "application/json"},
    "body":       messageString,
}, nil
}
```

```
func main() {
    lambda.Start(HandleRequest)
}
```

Java

SDK for Java 2.x

Note

There's more on GitHub. Find the complete example and learn how to set up and run in the [Serverless examples](#) repository.

Connecting to an Amazon RDS database in a Lambda function using Java.

```
import com.amazonaws.services.lambda.runtime.Context;
import com.amazonaws.services.lambda.runtime.RequestHandler;
import com.amazonaws.services.lambda.runtime.events.APIGatewayProxyRequestEvent;
import com.amazonaws.services.lambda.runtime.events.APIGatewayProxyResponseEvent;
import software.amazon.awssdk.auth.credentials.DefaultCredentialsProvider;
import software.amazon.awssdk.regions.Region;
import software.amazon.awssdk.services.rdsdata.RdsDataClient;
import software.amazon.awssdk.services.rdsdata.model.ExecuteStatementRequest;
import software.amazon.awssdk.services.rdsdata.model.ExecuteStatementResponse;
import software.amazon.awssdk.services.rdsdata.model.Field;

import java.sql.Connection;
import java.sql.DriverManager;
import java.sql.PreparedStatement;
import java.sql.ResultSet;

public class RdsLambdaHandler implements
    RequestHandler<APIGatewayProxyRequestEvent, APIGatewayProxyResponseEvent> {

    @Override
    public APIGatewayProxyResponseEvent handleRequest(APIGatewayProxyRequestEvent
        event, Context context) {
        APIGatewayProxyResponseEvent response = new
            APIGatewayProxyResponseEvent();
    }
}
```

```
    try {
        // Obtain auth token
        String token = createAuthToken();

        // Define connection configuration
        String connectionString = String.format("jdbc:mysql://%s:%s/%s?
useSSL=true&requireSSL=true",
            System.getenv("ProxyHostName"),
            System.getenv("Port"),
            System.getenv("DBName"));

        // Establish a connection to the database
        try (Connection connection =
DriverManager.getConnection(connectionString, System.getenv("DBUserName"),
token);
            PreparedStatement statement =
connection.prepareStatement("SELECT ? + ? AS sum")) {

            statement.setInt(1, 3);
            statement.setInt(2, 2);

            try (ResultSet resultSet = statement.executeQuery()) {
                if (resultSet.next()) {
                    int sum = resultSet.getInt("sum");
                    response.setStatusCode(200);
                    response.setBody("The selected sum is: " + sum);
                }
            }
        }

    } catch (Exception e) {
        response.setStatusCode(500);
        response.setBody("Error: " + e.getMessage());
    }

    return response;
}

private String createAuthToken() {
    // Create RDS Data Service client
    RdsDataClient rdsDataClient = RdsDataClient.builder()
        .region(Region.of(System.getenv("AWS_REGION")))
        .credentialsProvider(DefaultCredentialsProvider.create())
        .build();
}
```

```

    // Define authentication request
    ExecuteStatementRequest request = ExecuteStatementRequest.builder()
        .resourceArn(System.getenv("ProxyHostName"))
        .secretArn(System.getenv("DBUserName"))
        .database(System.getenv("DBName"))
        .sql("SELECT 'RDS IAM Authentication'")
        .build();

    // Execute request and obtain authentication token
    ExecuteStatementResponse response =
rdsDataClient.executeStatement(request);
    Field tokenField = response.records().get(0).get(0);

    return tokenField.stringValue();
}
}

```

JavaScript

SDK for JavaScript (v3)

Note

There's more on GitHub. Find the complete example and learn how to set up and run in the [Serverless examples](#) repository.

Connecting to an Amazon RDS database in a Lambda function using JavaScript.

```

// Copyright Amazon.com, Inc. or its affiliates. All Rights Reserved.
// SPDX-License-Identifier: Apache-2.0
/*
Node.js code here.
*/
// ES6+ example
import { Signer } from "@aws-sdk/rds-signer";
import mysql from 'mysql2/promise';

async function createAuthToken() {
    // Define connection authentication parameters

```

```
const dbinfo = {

  hostname: process.env.ProxyHostName,
  port: process.env.Port,
  username: process.env.DBUserName,
  region: process.env.AWS_REGION,

}

// Create RDS Signer object
const signer = new Signer(dbinfo);

// Request authorization token from RDS, specifying the username
const token = await signer.getAuthToken();
return token;
}

async function dbOps() {

  // Obtain auth token
  const token = await createAuthToken();
  // Define connection configuration
  let connectionConfig = {
    host: process.env.ProxyHostName,
    user: process.env.DBUserName,
    password: token,
    database: process.env.DBName,
    ssl: 'Amazon RDS'
  }
  // Create the connection to the DB
  const conn = await mysql.createConnection(connectionConfig);
  // Obtain the result of the query
  const [res,] = await conn.execute('select ?+? as sum', [3, 2]);
  return res;

}

export const handler = async (event) => {
  // Execute database flow
  const result = await dbOps();
  // Return result
  return {
    statusCode: 200,
    body: JSON.stringify("The selected sum is: " + result[0].sum)
  }
}
```



```
}  
};
```

Connecting to an Amazon RDS database in a Lambda function using TypeScript.

```
import { Signer } from "@aws-sdk/rds-signer";  
import mysql from 'mysql2/promise';  
  
// RDS settings  
// Using '!' (non-null assertion operator) to tell the TypeScript compiler that  
// the DB settings are not null or undefined,  
const proxy_host_name = process.env.PROXY_HOST_NAME!  
const port = parseInt(process.env.PORT!)  
const db_name = process.env.DB_NAME!  
const db_user_name = process.env.DB_USER_NAME!  
const aws_region = process.env.AWS_REGION!  
  
async function createAuthToken(): Promise<string> {  
  
    // Create RDS Signer object  
    const signer = new Signer({  
        hostname: proxy_host_name,  
        port: port,  
        region: aws_region,  
        username: db_user_name  
    });  
  
    // Request authorization token from RDS, specifying the username  
    const token = await signer.getAuthToken();  
    return token;  
}  
  
async function dbOps(): Promise<mysql.QueryResult | undefined> {  
    try {  
        // Obtain auth token  
        const token = await createAuthToken();  
        const conn = await mysql.createConnection({  
            host: proxy_host_name,  
            user: db_user_name,  
            password: token,  

```

```
        database: db_name,
        ssl: 'Amazon RDS' // Ensure you have the CA bundle for SSL connection
    });
    const [rows, fields] = await conn.execute('SELECT ? + ? AS sum', [3, 2]);
    console.log('result:', rows);
    return rows;
}
catch (err) {
    console.log(err);
}
}

export const lambdaHandler = async (event: any): Promise<{ statusCode: number;
body: string }> => {
    // Execute database flow
    const result = await dbOps();

    // Return error if result is undefined
    if (result == undefined)
        return {
            statusCode: 500,
            body: JSON.stringify(`Error with connection to DB host`)
        }

    // Return result
    return {
        statusCode: 200,
        body: JSON.stringify(`The selected sum is: ${result[0].sum}`)
    };
};
```

PHP

SDK for PHP

Note

There's more on GitHub. Find the complete example and learn how to set up and run in the [Serverless examples](#) repository.

Connecting to an Amazon RDS database in a Lambda function using PHP.

```
<?php
# Copyright Amazon.com, Inc. or its affiliates. All Rights Reserved.
# SPDX-License-Identifier: Apache-2.0

# using bref/bref and bref/logger for simplicity

use Bref\Context\Context;
use Bref\Event\Handler as StdHandler;
use Bref\Logger\StderrLogger;
use Aws\Rds\AuthTokenGenerator;
use Aws\Credentials\CredentialProvider;

require __DIR__ . '/vendor/autoload.php';

class Handler implements StdHandler
{
    private StderrLogger $logger;
    public function __construct(StderrLogger $logger)
    {
        $this->logger = $logger;
    }

    private function getAuthToken(): string {
        // Define connection authentication parameters
        $dbConnection = [
            'hostname' => getenv('DB_HOSTNAME'),
            'port' => getenv('DB_PORT'),
            'username' => getenv('DB_USERNAME'),
            'region' => getenv('AWS_REGION'),
        ];

        // Create RDS AuthTokenGenerator object
        $generator = new
AuthTokenGenerator(CredentialProvider::defaultProvider());

        // Request authorization token from RDS, specifying the username
        return $generator->createToken(
            $dbConnection['hostname'] . ':' . $dbConnection['port'],
            $dbConnection['region'],
            $dbConnection['username']
        );
    }
}
```

```
private function getQueryResults() {
    // Obtain auth token
    $token = $this->getAuthToken();

    // Define connection configuration
    $connectionConfig = [
        'host' => getenv('DB_HOSTNAME'),
        'user' => getenv('DB_USERNAME'),
        'password' => $token,
        'database' => getenv('DB_NAME'),
    ];

    // Create the connection to the DB
    $conn = new PDO(
        "mysql:host={$connectionConfig['host']};dbname={$connectionConfig['database']}",
        $connectionConfig['user'],
        $connectionConfig['password'],
        [
            PDO::MYSQL_ATTR_SSL_CA => '/path/to/rds-ca-2019-root.pem',
            PDO::MYSQL_ATTR_SSL_VERIFY_SERVER_CERT => true,
        ]
    );

    // Obtain the result of the query
    $stmt = $conn->prepare('SELECT ?+? AS sum');
    $stmt->execute([3, 2]);

    return $stmt->fetch(PDO::FETCH_ASSOC);
}

/**
 * @param mixed $event
 * @param Context $context
 * @return array
 */
public function handle(mixed $event, Context $context): array
{
    $this->logger->info("Processing query");

    // Execute database flow
    $result = $this->getQueryResults();
}
```

```
        return [
            'sum' => $result['sum']
        ];
    }
}

$logger = new StderrLogger();
return new Handler($logger);
```

Python

SDK for Python (Boto3)

Note

There's more on GitHub. Find the complete example and learn how to set up and run in the [Serverless examples](#) repository.

Connecting to an Amazon RDS database in a Lambda function using Python.

```
import json
import os
import boto3
import pymysql

# RDS settings
proxy_host_name = os.environ['PROXY_HOST_NAME']
port = int(os.environ['PORT'])
db_name = os.environ['DB_NAME']
db_user_name = os.environ['DB_USER_NAME']
aws_region = os.environ['AWS_REGION']

# Fetch RDS Auth Token
def get_auth_token():
    client = boto3.client('rds')
    token = client.generate_db_auth_token(
        DBHostname=proxy_host_name,
        Port=port
        DBUsername=db_user_name
        Region=aws_region
```

```
)
return token

def lambda_handler(event, context):
    token = get_auth_token()
    try:
        connection = pymysql.connect(
            host=proxy_host_name,
            user=db_user_name,
            password=token,
            db=db_name,
            port=port,
            ssl={'ca': 'Amazon RDS'} # Ensure you have the CA bundle for SSL
connection
        )

        with connection.cursor() as cursor:
            cursor.execute('SELECT %s + %s AS sum', (3, 2))
            result = cursor.fetchone()

        return result

    except Exception as e:
        return (f"Error: {str(e)}") # Return an error message if an exception
occurs
```

Ruby

SDK for Ruby

Note

There's more on GitHub. Find the complete example and learn how to set up and run in the [Serverless examples](#) repository.

Connecting to an Amazon RDS database in a Lambda function using Ruby.

```
# Ruby code here.

require 'aws-sdk-rds'
```

```
require 'json'
require 'mysql2'

def lambda_handler(event:, context:)
  endpoint = ENV['DBEndpoint'] # Add the endpoint without https"
  port = ENV['Port']           # 3306
  user = ENV['DBUser']
  region = ENV['DBRegion']     # 'us-east-1'
  db_name = ENV['DBName']

  credentials = Aws::Credentials.new(
    ENV['AWS_ACCESS_KEY_ID'],
    ENV['AWS_SECRET_ACCESS_KEY'],
    ENV['AWS_SESSION_TOKEN']
  )
  rds_client = Aws::RDS::AuthTokenGenerator.new(
    region: region,
    credentials: credentials
  )

  token = rds_client.auth_token(
    endpoint: endpoint+ ':' + port,
    user_name: user,
    region: region
  )

  begin
    conn = Mysql2::Client.new(
      host: endpoint,
      username: user,
      password: token,
      port: port,
      database: db_name,
      sslca: '/var/task/global-bundle.pem',
      sslverify: true,
      enableCleartextPlugin: true
    )
    a = 3
    b = 2
    result = conn.query("SELECT #{a} + #{b} AS sum").first['sum']
    puts result
    conn.close
  {
    statusCode: 200,
```

```

    body: result.to_json
  }
  rescue => e
    puts "Database connection failed due to #{e}"
  end
end
end

```

Rust

SDK for Rust

Note

There's more on GitHub. Find the complete example and learn how to set up and run in the [Serverless examples](#) repository.

Connecting to an Amazon RDS database in a Lambda function using Rust.

```

use aws_config::BehaviorVersion;
use aws_credential_types::provider::ProvideCredentials;
use aws_sigv4::{
    http_request::{sign, SignableBody, SignableRequest, SigningSettings},
    sign::v4,
};
use lambda_runtime::{run, service_fn, Error, LambdaEvent};
use serde_json::{json, Value};
use sqlx::postgres::PgConnectOptions;
use std::env;
use std::time::{Duration, SystemTime};

const RDS_CERTS: &[u8] = include_bytes!("global-bundle.pem");

async fn generate_rds_iam_token(
    db_hostname: &str,
    port: u16,
    db_username: &str,
) -> Result<String, Error> {
    let config = aws_config::load_defaults(BehaviorVersion::v2024_03_28()).await;

    let credentials = config
        .credentials_provider()

```



```
        .expect("no credentials provider found")
        .provide_credentials()
        .await
        .expect("unable to load credentials");
let identity = credentials.into();
let region = config.region().unwrap().to_string();

let mut signing_settings = SigningSettings::default();
signing_settings.expires_in = Some(Duration::from_secs(900));
signing_settings.signature_location =
aws_sigv4::http_request::SignatureLocation::QueryParams;

let signing_params = v4::SigningParams::builder()
    .identity(&identity)
    .region(&region)
    .name("rds-db")
    .time(SystemTime::now())
    .settings(signing_settings)
    .build()?;

let url = format!(
    "https://{db_hostname}:{port}/?Action=connect&DBUser={db_user}",
    db_hostname = db_hostname,
    port = port,
    db_user = db_username
);

let signable_request =
    SignableRequest::new("GET", &url, std::iter::empty(),
SignableBody::Bytes(&[]))
        .expect("signable request");

let (signing_instructions, _signature) =
    sign(signable_request, &signing_params.into())?.into_parts();

let mut url = url::Url::parse(&url).unwrap();
for (name, value) in signing_instructions.params() {
    url.query_pairs_mut().append_pair(name, &value);
}

let response = url.to_string().split_off("https://".len());

Ok(response)
}
```

```
#[tokio::main]
async fn main() -> Result<(), Error> {
    run(service_fn(handler)).await
}

async fn handler(_event: LambdaEvent<Value>) -> Result<Value, Error> {
    let db_host = env::var("DB_HOSTNAME").expect("DB_HOSTNAME must be set");
    let db_port = env::var("DB_PORT")
        .expect("DB_PORT must be set")
        .parse::<u16>()
        .expect("PORT must be a valid number");
    let db_name = env::var("DB_NAME").expect("DB_NAME must be set");
    let db_user_name = env::var("DB_USERNAME").expect("DB_USERNAME must be set");

    let token = generate_rds_iam_token(&db_host, db_port, &db_user_name).await?;

    let opts = PgConnectOptions::new()
        .host(&db_host)
        .port(db_port)
        .username(&db_user_name)
        .password(&token)
        .database(&db_name)
        .ssl_root_cert_from_pem(RDS_CERTS.to_vec())
        .ssl_mode(sqlx::postgres::PgSslMode::Require);

    let pool = sqlx::postgres::PgPoolOptions::new()
        .connect_with(opts)
        .await?;

    let result: i32 = sqlx::query_scalar("SELECT $1 + $2")
        .bind(3)
        .bind(2)
        .fetch_one(&pool)
        .await?;

    println!("Result: {:?}", result);

    Ok(json!({
        "statusCode": 200,
        "content-type": "text/plain",
        "body": format!("The selected sum is: {result}")
    })))
}
```

For a complete list of AWS SDK developer guides and code examples, see [Using Lambda with an AWS SDK](#). This topic also includes information about getting started and details about previous SDK versions.

Invoke a Lambda function from a Kinesis trigger

The following code examples show how to implement a Lambda function that receives an event triggered by receiving records from a Kinesis stream. The function retrieves the Kinesis payload, decodes from Base64, and logs the record contents.

.NET

AWS SDK for .NET

Note

There's more on GitHub. Find the complete example and learn how to set up and run in the [Serverless examples](#) repository.

Consuming a Kinesis event with Lambda using .NET.

```
// Copyright Amazon.com, Inc. or its affiliates. All Rights Reserved.
// SPDX-License-Identifier: Apache-2.0
using System.Text;
using Amazon.Lambda.Core;
using Amazon.Lambda.KinesisEvents;
using AWS.Lambda.Powertools.Logging;

// Assembly attribute to enable the Lambda function's JSON input to be converted
// into a .NET class.
[assembly:
    LambdaSerializer(typeof(Amazon.Lambda.Serialization.SystemTextJson.DefaultLambdaJsonSerializer))]

namespace KinesisIntegrationSampleCode;

public class Function
{
    // Powertools Logger requires an environment variables against your function
```

```
// POWERTOOLS_SERVICE_NAME
[Logging(LogEvent = true)]
public async Task FunctionHandler(KinesisEvent evnt, ILambdaContext context)
{
    if (evnt.Records.Count == 0)
    {
        Logger.LogInformation("Empty Kinesis Event received");
        return;
    }

    foreach (var record in evnt.Records)
    {
        try
        {
            Logger.LogInformation($"Processed Event with EventId:
{record.EventId}");
            string data = await GetRecordDataAsync(record.Kinesis, context);
            Logger.LogInformation($"Data: {data}");
            // TODO: Do interesting work based on the new data
        }
        catch (Exception ex)
        {
            Logger.LogError($"An error occurred {ex.Message}");
            throw;
        }
    }
    Logger.LogInformation($"Successfully processed {evnt.Records.Count}
records.");
}

private async Task<string> GetRecordDataAsync(KinesisEvent.Record record,
ILambdaContext context)
{
    byte[] bytes = record.Data.ToArray();
    string data = Encoding.UTF8.GetString(bytes);
    await Task.CompletedTask; //Placeholder for actual async work
    return data;
}
}
```

Go

SDK for Go V2

Note

There's more on GitHub. Find the complete example and learn how to set up and run in the [Serverless examples](#) repository.

Consuming a Kinesis event with Lambda using Go.

```
// Copyright Amazon.com, Inc. or its affiliates. All Rights Reserved.
// SPDX-License-Identifier: Apache-2.0
package main

import (
    "context"
    "log"

    "github.com/aws/aws-lambda-go/events"
    "github.com/aws/aws-lambda-go/lambda"
)

func handler(ctx context.Context, kinesisEvent events.KinesisEvent) error {
    if len(kinesisEvent.Records) == 0 {
        log.Printf("empty Kinesis event received")
        return nil
    }

    for _, record := range kinesisEvent.Records {
        log.Printf("processed Kinesis event with EventId: %v", record.EventID)
        recordDataBytes := record.Kinesis.Data
        recordDataText := string(recordDataBytes)
        log.Printf("record data: %v", recordDataText)
        // TODO: Do interesting work based on the new data
    }
    log.Printf("successfully processed %v records", len(kinesisEvent.Records))
    return nil
}

func main() {
    lambda.Start(handler)
}
```

```
}
```

Java

SDK for Java 2.x

Note

There's more on GitHub. Find the complete example and learn how to set up and run in the [Serverless examples](#) repository.

Consuming a Kinesis event with Lambda using Java.

```
// Copyright Amazon.com, Inc. or its affiliates. All Rights Reserved.
// SPDX-License-Identifier: Apache-2.0
package example;

import com.amazonaws.services.lambda.runtime.Context;
import com.amazonaws.services.lambda.runtime.LambdaLogger;
import com.amazonaws.services.lambda.runtime.RequestHandler;
import com.amazonaws.services.lambda.runtime.events.KinesisEvent;

public class Handler implements RequestHandler<KinesisEvent, Void> {
    @Override
    public Void handleRequest(final KinesisEvent event, final Context context) {
        LambdaLogger logger = context.getLogger();
        if (event.getRecords().isEmpty()) {
            logger.log("Empty Kinesis Event received");
            return null;
        }
        for (KinesisEvent.KinesisEventRecord record : event.getRecords()) {
            try {
                logger.log("Processed Event with EventId: "+record.getEventID());
                String data = new String(record.getKinesis().getData().array());
                logger.log("Data:"+ data);
                // TODO: Do interesting work based on the new data
            }
            catch (Exception ex) {
                logger.log("An error occurred:"+ex.getMessage());
                throw ex;
            }
        }
    }
}
```

```
    }
  }
  logger.log("Successfully processed:"+event.getRecords().size()+"
records");
  return null;
}
}
```

JavaScript

SDK for JavaScript (v3)

Note

There's more on GitHub. Find the complete example and learn how to set up and run in the [Serverless examples](#) repository.

Consuming a Kinesis event with Lambda using JavaScript.

```
// Copyright Amazon.com, Inc. or its affiliates. All Rights Reserved.
// SPDX-License-Identifier: Apache-2.0
exports.handler = async (event, context) => {
  for (const record of event.Records) {
    try {
      console.log(`Processed Kinesis Event - EventID: ${record.eventID}`);
      const recordData = await getRecordDataAsync(record.kinesis);
      console.log(`Record Data: ${recordData}`);
      // TODO: Do interesting work based on the new data
    } catch (err) {
      console.error(`An error occurred ${err}`);
      throw err;
    }
  }
  console.log(`Successfully processed ${event.Records.length} records.`);
};

async function getRecordDataAsync(payload) {
  var data = Buffer.from(payload.data, "base64").toString("utf-8");
  await Promise.resolve(1); //Placeholder for actual async work
}
```

```
    return data;
  }
```

Consuming a Kinesis event with Lambda using TypeScript.

```
// Copyright Amazon.com, Inc. or its affiliates. All Rights Reserved.
// SPDX-License-Identifier: Apache-2.0
import {
  KinesisStreamEvent,
  Context,
  KinesisStreamHandler,
  KinesisStreamRecordPayload,
} from "aws-lambda";
import { Buffer } from "buffer";
import { Logger } from "@aws-lambda-powertools/logger";

const logger = new Logger({
  logLevel: "INFO",
  serviceName: "kinesis-stream-handler-sample",
});

export const functionHandler: KinesisStreamHandler = async (
  event: KinesisStreamEvent,
  context: Context
): Promise<void> => {
  for (const record of event.Records) {
    try {
      logger.info(`Processed Kinesis Event - EventID: ${record.eventID}`);
      const recordData = await getRecordDataAsync(record.kinesis);
      logger.info(`Record Data: ${recordData}`);
      // TODO: Do interesting work based on the new data
    } catch (err) {
      logger.error(`An error occurred ${err}`);
      throw err;
    }
    logger.info(`Successfully processed ${event.Records.length} records.`);
  }
};

async function getRecordDataAsync(
  payload: KinesisStreamRecordPayload
): Promise<string> {
```



```
var data = Buffer.from(payload.data, "base64").toString("utf-8");
await Promise.resolve(1); //Placeholder for actual async work
return data;
}
```

PHP

SDK for PHP

Note

There's more on GitHub. Find the complete example and learn how to set up and run in the [Serverless examples](#) repository.

Consuming an Kinesis event with Lambda using PHP.

```
// Copyright Amazon.com, Inc. or its affiliates. All Rights Reserved.
// SPDX-License-Identifier: Apache-2.0
<?php

# using bref/bref and bref/logger for simplicity

use Bref\Context\Context;
use Bref\Event\Kinesis\KinesisEvent;
use Bref\Event\Kinesis\KinesisHandler;
use Bref\Logger\StderrLogger;

require __DIR__ . '/vendor/autoload.php';

class Handler extends KinesisHandler
{
    private StderrLogger $logger;
    public function __construct(StderrLogger $logger)
    {
        $this->logger = $logger;
    }

    /**
     * @throws JsonException
     * @throws \Bref\Event\InvalidLambdaEvent
     */
}
```

```
*/
public function handleKinesis(KinesisEvent $event, Context $context): void
{
    $this->logger->info("Processing records");
    $records = $event->getRecords();
    foreach ($records as $record) {
        $data = $record->getData();
        $this->logger->info(json_encode($data));
        // TODO: Do interesting work based on the new data

        // Any exception thrown will be logged and the invocation will be
marked as failed
    }
    $totalRecords = count($records);
    $this->logger->info("Successfully processed $totalRecords records");
}
}

$logger = new StderrLogger();
return new Handler($logger);
```

Python

SDK for Python (Boto3)

Note

There's more on GitHub. Find the complete example and learn how to set up and run in the [Serverless examples](#) repository.

Consuming a Kinesis event with Lambda using Python.

```
# Copyright Amazon.com, Inc. or its affiliates. All Rights Reserved.
# SPDX-License-Identifier: Apache-2.0
import base64
def lambda_handler(event, context):

    for record in event['Records']:
        try:
            print(f"Processed Kinesis Event - EventID: {record['eventID']}")
```

```

        record_data = base64.b64decode(record['kinesis']
['data']).decode('utf-8')
        print(f"Record Data: {record_data}")
        # TODO: Do interesting work based on the new data
    except Exception as e:
        print(f"An error occurred {e}")
        raise e
    print(f"Successfully processed {len(event['Records'])} records.")

```

Ruby

SDK for Ruby

Note

There's more on GitHub. Find the complete example and learn how to set up and run in the [Serverless examples](#) repository.

Consuming an Kinesis event with Lambda using Ruby.

```

# Copyright Amazon.com, Inc. or its affiliates. All Rights Reserved.
# SPDX-License-Identifier: Apache-2.0
require 'aws-sdk'

def lambda_handler(event:, context:)
  event['Records'].each do |record|
    begin
      puts "Processed Kinesis Event - EventID: #{record['eventID']}"
      record_data = get_record_data_async(record['kinesis'])
      puts "Record Data: #{record_data}"
      # TODO: Do interesting work based on the new data
    rescue => err
      $stderr.puts "An error occurred #{err}"
      raise err
    end
  end
  puts "Successfully processed #{event['Records'].length} records."
end

def get_record_data_async(payload)

```

```
data = Base64.decode64(payload['data']).force_encoding('UTF-8')
# Placeholder for actual async work
# You can use Ruby's asynchronous programming tools like async/await or fibers
here.
return data
end
```

Rust

SDK for Rust

Note

There's more on GitHub. Find the complete example and learn how to set up and run in the [Serverless examples](#) repository.

Consuming an Kinesis event with Lambda using Rust.

```
// Copyright Amazon.com, Inc. or its affiliates. All Rights Reserved.
// SPDX-License-Identifier: Apache-2.0
use aws_lambda_events::event::kinesis::KinesisEvent;
use lambda_runtime::{run, service_fn, Error, LambdaEvent};

async fn function_handler(event: LambdaEvent<KinesisEvent>) -> Result<(), Error>
{
    if event.payload.records.is_empty() {
        tracing::info!("No records found. Exiting.");
        return Ok(());
    }

    event.payload.records.iter().for_each(|record| {
        tracing::info!("EventId:
{}", record.event_id.as_deref().unwrap_or_default());

        let record_data = std::str::from_utf8(&record.kinesis.data);

        match record_data {
            Ok(data) => {
                // log the record data
                tracing::info!("Data: {}", data);
            }
        }
    });
}
```

```
        Err(e) => {
            tracing::error!("Error: {}", e);
        }
    });

    tracing::info!(
        "Successfully processed {} records",
        event.payload.records.len()
    );

    Ok(())
}

#[tokio::main]
async fn main() -> Result<(), Error> {
    tracing_subscriber::fmt()
        .with_max_level(tracing::Level::INFO)
        // disable printing the name of the module in every log line.
        .with_target(false)
        // disabling time is handy because CloudWatch will add the ingestion
time.
        .without_time()
        .init();

    run(service_fn(function_handler)).await
}
```

For a complete list of AWS SDK developer guides and code examples, see [Using Lambda with an AWS SDK](#). This topic also includes information about getting started and details about previous SDK versions.

Invoke a Lambda function from a DynamoDB trigger

The following code examples show how to implement a Lambda function that receives an event triggered by receiving records from a DynamoDB stream. The function retrieves the DynamoDB payload and logs the record contents.

.NET

AWS SDK for .NET

Note

There's more on GitHub. Find the complete example and learn how to set up and run in the [Serverless examples](#) repository.

Consuming a DynamoDB event with Lambda using .NET.

```
// Copyright Amazon.com, Inc. or its affiliates. All Rights Reserved.
// SPDX-License-Identifier: Apache-2.0
using System.Text.Json;
using System.Text;
using Amazon.Lambda.Core;
using Amazon.Lambda.DynamoDBEvents;

// Assembly attribute to enable the Lambda function's JSON input to be converted
// into a .NET class.
[assembly: LambdaSerializer(typeof(Amazon.Lambda.Serialization.SystemTextJson.DefaultLambdaJsonSerializer))]

namespace AWSLambda_DDB;

public class Function
{
    public void FunctionHandler(DynamoDBEvent dynamoEvent, ILambdaContext context)
    {
        context.Logger.LogInformation($"Beginning to process {dynamoEvent.Records.Count} records...");

        foreach (var record in dynamoEvent.Records)
        {
            context.Logger.LogInformation($"Event ID: {record.EventID}");
            context.Logger.LogInformation($"Event Name: {record.EventName}");

            context.Logger.LogInformation(JsonSerializer.Serialize(record));
        }

        context.Logger.LogInformation("Stream processing complete.");
    }
}
```

```
}  
}
```

Go

SDK for Go V2

Note

There's more on GitHub. Find the complete example and learn how to set up and run in the [Serverless examples](#) repository.

Consuming a DynamoDB event with Lambda using Go.

```
// Copyright Amazon.com, Inc. or its affiliates. All Rights Reserved.  
// SPDX-License-Identifier: Apache-2.0  
package main  
  
import (  
    "context"  
    "github.com/aws/aws-lambda-go/lambda"  
    "github.com/aws/aws-lambda-go/events"  
    "fmt"  
)  
  
func HandleRequest(ctx context.Context, event events.DynamoDBEvent) (*string,  
error) {  
    if len(event.Records) == 0 {  
        return nil, fmt.Errorf("received empty event")  
    }  
  
    for _, record := range event.Records {  
        LogDynamoDBRecord(record)  
    }  
  
    message := fmt.Sprintf("Records processed: %d", len(event.Records))  
    return &message, nil  
}  
  
func main() {
```

```
lambda.Start(HandleRequest)
}

func LogDynamoDBRecord(record events.DynamoDBEventRecord){
    fmt.Println(record.EventID)
    fmt.Println(record.EventName)
    fmt.Printf("%+v\n", record.Change)
}
```

Java

SDK for Java 2.x

Note

There's more on GitHub. Find the complete example and learn how to set up and run in the [Serverless examples](#) repository.

Consuming a DynamoDB event with Lambda using Java.

```
import com.amazonaws.services.lambda.runtime.Context;
import com.amazonaws.services.lambda.runtime.RequestHandler;
import com.amazonaws.services.lambda.runtime.events.DynamodbEvent;
import
    com.amazonaws.services.lambda.runtime.events.DynamodbEvent.DynamodbStreamRecord;
import com.google.gson.Gson;
import com.google.gson.GsonBuilder;

public class example implements RequestHandler<DynamodbEvent, Void> {

    private static final Gson GSON = new
        GsonBuilder().setPrettyPrinting().create();

    @Override
    public Void handleRequest(DynamodbEvent event, Context context) {
        System.out.println(GSON.toJson(event));
        event.getRecords().forEach(this::logDynamoDBRecord);
        return null;
    }

    private void logDynamoDBRecord(DynamodbStreamRecord record) {
```



```
        System.out.println(record.getEventID());
        System.out.println(record.getEventName());
        System.out.println("DynamoDB Record: " +
    GSON.toJson(record.getDynamodb()));
    }
}
```

JavaScript

SDK for JavaScript (v3)

Note

There's more on GitHub. Find the complete example and learn how to set up and run in the [Serverless examples](#) repository.

Consuming a DynamoDB event with Lambda using JavaScript.

```
// Copyright Amazon.com, Inc. or its affiliates. All Rights Reserved.
// SPDX-License-Identifier: Apache-2.0
exports.handler = async (event, context) => {
    console.log(JSON.stringify(event, null, 2));
    event.Records.forEach(record => {
        logDynamoDBRecord(record);
    });
};

const logDynamoDBRecord = (record) => {
    console.log(record.eventID);
    console.log(record.eventName);
    console.log(`DynamoDB Record: ${JSON.stringify(record.dynamodb)}`);
};
```

Consuming a DynamoDB event with Lambda using TypeScript.

```
export const handler = async (event, context) => {
    console.log(JSON.stringify(event, null, 2));
    event.Records.forEach(record => {
        logDynamoDBRecord(record);
    });
};
```

```
});  
}  
const logDynamoDBRecord = (record) => {  
  console.log(record.eventID);  
  console.log(record.eventName);  
  console.log(`DynamoDB Record: ${JSON.stringify(record.dynamodb)}`);  
};
```

PHP

SDK for PHP

Note

There's more on GitHub. Find the complete example and learn how to set up and run in the [Serverless examples](#) repository.

Consuming a DynamoDB event with Lambda using PHP.

```
<?php  
  
# using bref/bref and bref/logger for simplicity  
  
use Bref\Context\Context;  
use Bref\Event\DynamoDb\DynamoDbEvent;  
use Bref\Event\DynamoDb\DynamoDbHandler;  
use Bref\Logger\StderrLogger;  
  
require __DIR__ . '/vendor/autoload.php';  
  
class Handler extends DynamoDbHandler  
{  
  private StderrLogger $logger;  
  
  public function __construct(StderrLogger $logger)  
  {  
    $this->logger = $logger;  
  }  
  
  /**  
   * @throws JsonException
```

```
* @throws \Bref\Event\InvalidLambdaEvent
*/
public function handleDynamoDb(DynamoDbEvent $event, Context $context): void
{
    $this->logger->info("Processing DynamoDb table items");
    $records = $event->getRecords();

    foreach ($records as $record) {
        $eventName = $record->getEventName();
        $keys = $record->getKeys();
        $old = $record->getOldImage();
        $new = $record->getNewImage();

        $this->logger->info("Event Name:". $eventName. "\n");
        $this->logger->info("Keys:". json_encode($keys). "\n");
        $this->logger->info("Old Image:". json_encode($old). "\n");
        $this->logger->info("New Image:". json_encode($new));

        // TODO: Do interesting work based on the new data

        // Any exception thrown will be logged and the invocation will be
        marked as failed
    }

    $totalRecords = count($records);
    $this->logger->info("Successfully processed $totalRecords items");
}

}

$logger = new StderrLogger();
return new Handler($logger);
```

Python

SDK for Python (Boto3)

Note

There's more on GitHub. Find the complete example and learn how to set up and run in the [Serverless examples](#) repository.

Consuming a DynamoDB event with Lambda using Python.

```
import json

def lambda_handler(event, context):
    print(json.dumps(event, indent=2))

    for record in event['Records']:
        log_dynamodb_record(record)

def log_dynamodb_record(record):
    print(record['eventID'])
    print(record['eventName'])
    print(f"DynamoDB Record: {json.dumps(record['dynamodb'])}")
```

Ruby

SDK for Ruby

Note

There's more on GitHub. Find the complete example and learn how to set up and run in the [Serverless examples](#) repository.

Consuming a DynamoDB event with Lambda using Ruby.

```
def lambda_handler(event:, context:)
  return 'received empty event' if event['Records'].empty?

  event['Records'].each do |record|
    log_dynamodb_record(record)
  end

  "Records processed: #{event['Records'].length}"
end

def log_dynamodb_record(record)
```

```
puts record['eventID']
puts record['eventName']
puts "DynamoDB Record: #{JSON.generate(record['dynamodb'])}"
end
```

Rust

SDK for Rust

Note

There's more on GitHub. Find the complete example and learn how to set up and run in the [Serverless examples](#) repository.

Consuming a DynamoDB event with Lambda using Rust.

```
use lambda_runtime::{service_fn, tracing, Error, LambdaEvent};
use aws_lambda_events::{
    event::dynamodb::{Event, EventRecord},
};

// Built with the following dependencies:
//lambda_runtime = "0.11.1"
//serde_json = "1.0"
//tokio = { version = "1", features = ["macros"] }
//tracing = { version = "0.1", features = ["log"] }
//tracing-subscriber = { version = "0.3", default-features = false, features =
    ["fmt"] }
//aws_lambda_events = "0.15.0"

async fn function_handler(event: LambdaEvent<Event>) ->Result<(), Error> {

    let records = &event.payload.records;
    tracing::info!("event payload: {:?}",records);
    if records.is_empty() {
        tracing::info!("No records found. Exiting.");
        return Ok(());
    }
}
```

```
    for record in records{
        log_dynamo_dbrecord(record);
    }

    tracing::info!("Dynamo db records processed");

    // Prepare the response
    Ok(())
}

fn log_dynamo_dbrecord(record: &EventRecord)-> Result<(), Error>{
    tracing::info!("EventId: {}", record.event_id);
    tracing::info!("EventName: {}", record.event_name);
    tracing::info!("DynamoDB Record: {:?}", record.change );
    Ok(())
}

#[tokio::main]
async fn main() -> Result<(), Error> {
    tracing_subscriber::fmt()
        .with_max_level(tracing::Level::INFO)
        .with_target(false)
        .without_time()
        .init();

    let func = service_fn(function_handler);
    lambda_runtime::run(func).await?;
    Ok(())
}
```

For a complete list of AWS SDK developer guides and code examples, see [Using Lambda with an AWS SDK](#). This topic also includes information about getting started and details about previous SDK versions.

Invoke a Lambda function from a Amazon DocumentDB trigger

The following code examples show how to implement a Lambda function that receives an event triggered by receiving records from a DocumentDB change stream. The function retrieves the DocumentDB payload and logs the record contents.

.NET

AWS SDK for .NET

Note

There's more on GitHub. Find the complete example and learn how to set up and run in the [Serverless examples](#) repository.

Consuming a Amazon DocumentDB event with Lambda using .NET.

```
using Amazon.Lambda.Core;
using System.Text.Json;
using System;
using System.Collections.Generic;
using System.Text.Json.Serialization;
//Assembly attribute to enable the Lambda function's JSON input to be converted
//into a .NET class.
[assembly:
    LambdaSerializer(typeof(Amazon.Lambda.Serialization.SystemTextJson.DefaultLambdaJsonSerializer))]

namespace LambdaDocDb;

public class Function
{
    /// <summary>
    /// Lambda function entry point to process Amazon DocumentDB events.
    /// </summary>
    /// <param name="event">The Amazon DocumentDB event.</param>
    /// <param name="context">The Lambda context object.</param>
    /// <returns>A string to indicate successful processing.</returns>
    public string FunctionHandler(Event evnt, ILambdaContext context)
    {
```

```
        foreach (var record in evnt.Events)
        {
            ProcessDocumentDBEvent(record, context);
        }

        return "OK";
    }

    private void ProcessDocumentDBEvent(DocumentDBEventRecord record,
    ILambdaContext context)
    {

        var eventData = record.Event;
        var operationType = eventData.OperationType;
        var databaseName = eventData.Ns.Db;
        var collectionName = eventData.Ns.Coll;
        var fullDocument = JsonSerializer.Serialize(eventData.FullDocument, new
    JsonSerializerOptions { WriteIndented = true });

        context.Logger.LogLine($"Operation type: {operationType}");
        context.Logger.LogLine($"Database: {databaseName}");
        context.Logger.LogLine($"Collection: {collectionName}");
        context.Logger.LogLine($"Full document:\n{fullDocument}");
    }

    public class Event
    {
        [JsonPropertyName("eventSourceArn")]
        public string EventSourceArn { get; set; }

        [JsonPropertyName("events")]
        public List<DocumentDBEventRecord> Events { get; set; }

        [JsonPropertyName("eventSource")]
        public string EventSource { get; set; }
    }

    public class DocumentDBEventRecord
    {
        [JsonPropertyName("event")]
        public EventData Event { get; set; }
    }
}
```



```
public class EventData
{
    [JsonPropertyName("_id")]
    public IdData Id { get; set; }

    [JsonPropertyName("clusterTime")]
    public ClusterTime ClusterTime { get; set; }

    [JsonPropertyName("documentKey")]
    public DocumentKey DocumentKey { get; set; }

    [JsonPropertyName("fullDocument")]
    public Dictionary<string, object> FullDocument { get; set; }

    [JsonPropertyName("ns")]
    public Namespace Namespace { get; set; }

    [JsonPropertyName("operationType")]
    public string OperationType { get; set; }
}

public class IdData
{
    [JsonPropertyName("_data")]
    public string Data { get; set; }
}

public class ClusterTime
{
    [JsonPropertyName("$timestamp")]
    public Timestamp Timestamp { get; set; }
}

public class Timestamp
{
    [JsonPropertyName("t")]
    public long T { get; set; }

    [JsonPropertyName("i")]
    public int I { get; set; }
}

public class DocumentKey
```

```
{
    [JsonPropertyName("_id")]
    public Id Id { get; set; }
}

public class Id
{
    [JsonPropertyName("$oid")]
    public string Oid { get; set; }
}

public class Namespace
{
    [JsonPropertyName("db")]
    public string Db { get; set; }

    [JsonPropertyName("coll")]
    public string Coll { get; set; }
}
}
```

Go

SDK for Go V2

Note

There's more on GitHub. Find the complete example and learn how to set up and run in the [Serverless examples](#) repository.

Consuming a Amazon DocumentDB event with Lambda using Go.

```
package main

import (
    "context"
    "encoding/json"
    "fmt"
```

```
"github.com/aws/aws-lambda-go/lambda"
)

type Event struct {
    Events []Record `json:"events"`
}

type Record struct {
    Event struct {
        OperationType string `json:"operationType"`
        NS             struct {
            DB string `json:"db"`
            Coll string `json:"coll"`
        } `json:"ns"`
        FullDocument interface{} `json:"fullDocument"`
    } `json:"event"`
}

func main() {
    lambda.Start(handler)
}

func handler(ctx context.Context, event Event) (string, error) {
    fmt.Println("Loading function")
    for _, record := range event.Events {
        logDocumentDBEvent(record)
    }

    return "OK", nil
}

func logDocumentDBEvent(record Record) {
    fmt.Printf("Operation type: %s\n", record.Event.OperationType)
    fmt.Printf("db: %s\n", record.Event.NS.DB)
    fmt.Printf("collection: %s\n", record.Event.NS.Coll)
    docBytes, _ := json.MarshalIndent(record.Event.FullDocument, "", " ")
    fmt.Printf("Full document: %s\n", string(docBytes))
}
```

Java

SDK for Java 2.x

 **Note**

There's more on GitHub. Find the complete example and learn how to set up and run in the [Serverless examples](#) repository.

Consuming a Amazon DocumentDB event with Lambda using Java.

```
import java.util.List;
import java.util.Map;

import com.amazonaws.services.lambda.runtime.Context;
import com.amazonaws.services.lambda.runtime.RequestHandler;

public class Example implements RequestHandler<Map<String, Object>, String> {

    @SuppressWarnings("unchecked")
    @Override
    public String handleRequest(Map<String, Object> event, Context context) {
        List<Map<String, Object>> events = (List<Map<String, Object>>)
event.get("events");
        for (Map<String, Object> record : events) {
            Map<String, Object> eventData = (Map<String, Object>)
record.get("event");
            processEventData(eventData);
        }

        return "OK";
    }

    @SuppressWarnings("unchecked")
    private void processEventData(Map<String, Object> eventData) {
        String operationType = (String) eventData.get("operationType");
        System.out.println("operationType: %s".formatted(operationType));

        Map<String, Object> ns = (Map<String, Object>) eventData.get("ns");

        String db = (String) ns.get("db");
        System.out.println("db: %s".formatted(db));
    }
}
```

```
String coll = (String) ns.get("coll");
System.out.println("coll: %s".formatted(coll));

Map<String, Object> fullDocument = (Map<String, Object>)
eventData.get("fullDocument");
System.out.println("fullDocument: %s".formatted(fullDocument));
}
}
```

JavaScript

SDK for JavaScript (v3)

Note

There's more on GitHub. Find the complete example and learn how to set up and run in the [Serverless examples](#) repository.

Consuming a Amazon DocumentDB event with Lambda using JavaScript.

```
console.log('Loading function');
exports.handler = async (event, context) => {
  event.events.forEach(record => {
    logDocumentDBEvent(record);
  });
  return 'OK';
};

const logDocumentDBEvent = (record) => {
  console.log('Operation type: ' + record.event.operationType);
  console.log('db: ' + record.event.ns.db);
  console.log('collection: ' + record.event.ns.coll);
  console.log('Full document:', JSON.stringify(record.event.fullDocument, null,
  2));
};
```

Consuming a Amazon DocumentDB event with Lambda using TypeScript

```
import { DocumentDBEventRecord, DocumentDBEventSubscriptionContext } from 'aws-lambda';

console.log('Loading function');

export const handler = async (
  event: DocumentDBEventSubscriptionContext,
  context: any
): Promise<string> => {
  event.events.forEach((record: DocumentDBEventRecord) => {
    logDocumentDBEvent(record);
  });
  return 'OK';
};

const logDocumentDBEvent = (record: DocumentDBEventRecord): void => {
  console.log('Operation type: ' + record.event.operationType);
  console.log('db: ' + record.event.ns.db);
  console.log('collection: ' + record.event.ns.coll);
  console.log('Full document:', JSON.stringify(record.event.fullDocument, null, 2));
};
```

PHP

SDK for PHP

Note

There's more on GitHub. Find the complete example and learn how to set up and run in the [Serverless examples](#) repository.

Consuming a Amazon DocumentDB event with Lambda using PHP.

```
<?php

require __DIR__.'./vendor/autoload.php';
```

```
use Bref\Context\Context;
use Bref\Event\Handler;

class DocumentDBEventHandler implements Handler
{
    public function handle($event, Context $context): string
    {
        $events = $event['events'] ?? [];
        foreach ($events as $record) {
            $this->logDocumentDBEvent($record['event']);
        }
        return 'OK';
    }

    private function logDocumentDBEvent($event): void
    {
        // Extract information from the event record

        $operationType = $event['operationType'] ?? 'Unknown';
        $db = $event['ns']['db'] ?? 'Unknown';
        $collection = $event['ns']['coll'] ?? 'Unknown';
        $fullDocument = $event['fullDocument'] ?? [];

        // Log the event details

        echo "Operation type: $operationType\n";
        echo "Database: $db\n";
        echo "Collection: $collection\n";
        echo "Full document: " . json_encode($fullDocument, JSON_PRETTY_PRINT) .
        "\n";
    }
}

return new DocumentDBEventHandler();
```

Python

SDK for Python (Boto3)

Note

There's more on GitHub. Find the complete example and learn how to set up and run in the [Serverless examples](#) repository.

Consuming a Amazon DocumentDB event with Lambda using Python.

```
import json

def lambda_handler(event, context):
    for record in event.get('events', []):
        log_document_db_event(record)
    return 'OK'

def log_document_db_event(record):
    event_data = record.get('event', {})
    operation_type = event_data.get('operationType', 'Unknown')
    db = event_data.get('ns', {}).get('db', 'Unknown')
    collection = event_data.get('ns', {}).get('coll', 'Unknown')
    full_document = event_data.get('fullDocument', {})

    print(f"Operation type: {operation_type}")
    print(f"db: {db}")
    print(f"collection: {collection}")
    print("Full document:", json.dumps(full_document, indent=2))
```

Ruby

SDK for Ruby

Note

There's more on GitHub. Find the complete example and learn how to set up and run in the [Serverless examples](#) repository.

Consuming a Amazon DocumentDB event with Lambda using Ruby.

```
require 'json'

def lambda_handler(event:, context:)
  event['events'].each do |record|
    log_document_db_event(record)
  end
  'OK'
end

def log_document_db_event(record)
  event_data = record['event'] || {}
  operation_type = event_data['operationType'] || 'Unknown'
  db = event_data.dig('ns', 'db') || 'Unknown'
  collection = event_data.dig('ns', 'coll') || 'Unknown'
  full_document = event_data['fullDocument'] || {}

  puts "Operation type: #{operation_type}"
  puts "db: #{db}"
  puts "collection: #{collection}"
  puts "Full document: #{JSON.pretty_generate(full_document)}"
end
```

Rust

SDK for Rust

Note

There's more on GitHub. Find the complete example and learn how to set up and run in the [Serverless examples](#) repository.

Consuming a Amazon DocumentDB event with Lambda using Rust.

```
use lambda_runtime::{service_fn, tracing, Error, LambdaEvent};
use aws_lambda_events::{
    event::documentdb::{DocumentDbEvent, DocumentDbInnerEvent},
};
```

```
// Built with the following dependencies:
//lambda_runtime = "0.11.1"
//serde_json = "1.0"
//tokio = { version = "1", features = ["macros"] }
//tracing = { version = "0.1", features = ["log"] }
//tracing-subscriber = { version = "0.3", default-features = false, features =
  ["fmt"] }
//aws_lambda_events = "0.15.0"

async fn function_handler(event: LambdaEvent<DocumentDbEvent>) ->Result<(),
  Error> {

    tracing::info!("Event Source ARN: {:?}", event.payload.event_source_arn);
    tracing::info!("Event Source: {:?}", event.payload.event_source);

    let records = &event.payload.events;

    if records.is_empty() {
        tracing::info!("No records found. Exiting.");
        return Ok(());
    }

    for record in records{
        log_document_db_event(record);
    }

    tracing::info!("Document db records processed");

    // Prepare the response
    Ok(())

}

fn log_document_db_event(record: &DocumentDbInnerEvent)-> Result<(), Error>{
    tracing::info!("Change Event: {:?}", record.event);

    Ok(())

}

#[tokio::main]
async fn main() -> Result<(), Error> {
```

```
tracing_subscriber::fmt()
  .with_max_level(tracing::Level::INFO)
  .with_target(false)
  .without_time()
  .init();

let func = service_fn(function_handler);
lambda_runtime::run(func).await?;
Ok(())
}
```

For a complete list of AWS SDK developer guides and code examples, see [Using Lambda with an AWS SDK](#). This topic also includes information about getting started and details about previous SDK versions.

Invoke a Lambda function from an Amazon MSK trigger

The following code examples show how to implement a Lambda function that receives an event triggered by receiving records from an Amazon MSK cluster. The function retrieves the MSK payload and logs the record contents.

.NET

AWS SDK for .NET

Note

There's more on GitHub. Find the complete example and learn how to set up and run in the [Serverless examples](#) repository.

Consuming an Amazon MSK event with Lambda using .NET.

```
using System.Text;
using Amazon.Lambda.Core;
using Amazon.Lambda.KafkaEvents;
```

```
// Assembly attribute to enable the Lambda function's JSON input to be converted
// into a .NET class.
[assembly:
    LambdaSerializer(typeof(Amazon.Lambda.Serialization.SystemTextJson.DefaultLambdaJsonSerializer))]

namespace MSKLambda;

public class Function
{
    /// <param name="input">The event for the Lambda function handler to
    /// process.</param>
    /// <param name="context">The ILambdaContext that provides methods for
    /// logging and describing the Lambda environment.</param>
    /// <returns></returns>
    public void FunctionHandler(KafkaEvent evnt, ILambdaContext context)
    {
        foreach (var record in evnt.Records)
        {
            Console.WriteLine("Key:" + record.Key);
            foreach (var eventRecord in record.Value)
            {
                var valueBytes = eventRecord.Value.ToArray();
                var valueText = Encoding.UTF8.GetString(valueBytes);

                Console.WriteLine("Message:" + valueText);
            }
        }
    }
}
```

Go

SDK for Go V2

 **Note**

There's more on GitHub. Find the complete example and learn how to set up and run in the [Serverless examples](#) repository.

Consuming an Amazon MSK event with Lambda using Go.

```
package main

import (
    "encoding/base64"
    "fmt"

    "github.com/aws/aws-lambda-go/events"
    "github.com/aws/aws-lambda-go/lambda"
)

func handler(event events.KafkaEvent) {
    for key, records := range event.Records {
        fmt.Println("Key:", key)

        for _, record := range records {
            fmt.Println("Record:", record)

            decodedValue, _ := base64.StdEncoding.DecodeString(record.Value)
            message := string(decodedValue)
            fmt.Println("Message:", message)
        }
    }
}

func main() {
    lambda.Start(handler)
}
```

Java

SDK for Java 2.x

 **Note**

There's more on GitHub. Find the complete example and learn how to set up and run in the [Serverless examples](#) repository.

Consuming an Amazon MSK event with Lambda using Java.

```
import com.amazonaws.services.lambda.runtime.Context;
import com.amazonaws.services.lambda.runtime.RequestHandler;
import com.amazonaws.services.lambda.runtime.events.KafkaEvent;
import com.amazonaws.services.lambda.runtime.events.KafkaEvent.KafkaEventRecord;

import java.util.Base64;
import java.util.Map;

public class Example implements RequestHandler<KafkaEvent, Void> {

    @Override
    public Void handleRequest(KafkaEvent event, Context context) {
        for (Map.Entry<String, java.util.List<KafkaEventRecord>> entry :
            event.getRecords().entrySet()) {
            String key = entry.getKey();
            System.out.println("Key: " + key);

            for (KafkaEventRecord record : entry.getValue()) {
                System.out.println("Record: " + record);

                byte[] value = Base64.getDecoder().decode(record.getValue());
                String message = new String(value);
                System.out.println("Message: " + message);
            }
        }

        return null;
    }
}
```

JavaScript

SDK for JavaScript (v3)

Note

There's more on GitHub. Find the complete example and learn how to set up and run in the [Serverless examples](#) repository.

Consuming an Amazon MSK event with Lambda using JavaScript.

```
exports.handler = async (event) => {
  // Iterate through keys
  for (let key in event.records) {
    console.log('Key: ', key)
    // Iterate through records
    event.records[key].map((record) => {
      console.log('Record: ', record)
      // Decode base64
      const msg = Buffer.from(record.value, 'base64').toString()
      console.log('Message:', msg)
    })
  }
}
```

PHP

SDK for PHP

Note

There's more on GitHub. Find the complete example and learn how to set up and run in the [Serverless examples](#) repository.

Consuming an Amazon MSK event with Lambda using PHP.

```
<?php
// Copyright Amazon.com, Inc. or its affiliates. All Rights Reserved.
// SPDX-License-Identifier: Apache-2.0

// using bref/bref and bref/logger for simplicity

use Bref\Context\Context;
use Bref\Event\Kafka\KafkaEvent;
use Bref\Event\Handler as StdHandler;
use Bref\Logger\StderrLogger;

require __DIR__ . '/vendor/autoload.php';

class Handler implements StdHandler
{
    private StderrLogger $logger;
    public function __construct(StderrLogger $logger)
    {
        $this->logger = $logger;
    }

    /**
     * @throws JsonException
     * @throws \Bref\Event\InvalidLambdaEvent
     */
    public function handle(mixed $event, Context $context): void
    {
        $kafkaEvent = new KafkaEvent($event);
        $this->logger->info("Processing records");
        $records = $kafkaEvent->getRecords();

        foreach ($records as $record) {
            try {
                $key = $record->getKey();
                $this->logger->info("Key: $key");

                $values = $record->getValue();
                $this->logger->info(json_encode($values));

                foreach ($values as $value) {
                    $this->logger->info("Value: $value");
                }
            }
        }
    }
}
```



```
        } catch (Exception $e) {
            $this->logger->error($e->getMessage());
        }
    }
    $totalRecords = count($records);
    $this->logger->info("Successfully processed $totalRecords records");
}
}

$logger = new StderrLogger();
return new Handler($logger);
```

Python

SDK for Python (Boto3)

Note

There's more on GitHub. Find the complete example and learn how to set up and run in the [Serverless examples](#) repository.

Consuming an Amazon MSK event with Lambda using Python.

```
import base64

def lambda_handler(event, context):
    # Iterate through keys
    for key in event['records']:
        print('Key:', key)
        # Iterate through records
        for record in event['records'][key]:
            print('Record:', record)
            # Decode base64
            msg = base64.b64decode(record['value']).decode('utf-8')
            print('Message:', msg)
```

Ruby

SDK for Ruby

Note

There's more on GitHub. Find the complete example and learn how to set up and run in the [Serverless examples](#) repository.

Consuming an Amazon MSK event with Lambda using Ruby.

```
require 'base64'

def lambda_handler(event:, context:)
  # Iterate through keys
  event['records'].each do |key, records|
    puts "Key: #{key}"

    # Iterate through records
    records.each do |record|
      puts "Record: #{record}"

      # Decode base64
      msg = Base64.decode64(record['value'])
      puts "Message: #{msg}"
    end
  end
end
```

Rust

SDK for Rust

Note

There's more on GitHub. Find the complete example and learn how to set up and run in the [Serverless examples](#) repository.

Consuming an Amazon MSK event with Lambda using Rust.

```
use aws_lambda_events::event::kafka::KafkaEvent;
use lambda_runtime::{run, service_fn, tracing, Error, LambdaEvent};
use base64::prelude::*;
use serde_json::{Value};
use tracing::{info};

/// Pre-Requisites:
/// 1. Install Cargo Lambda - see https://www.cargo-lambda.info/guide/getting-started.html
/// 2. Add packages tracing, tracing-subscriber, serde_json, base64
///
/// This is the main body for the function.
/// Write your code inside it.
/// There are some code example in the following URLs:
/// - https://github.com/awslabs/aws-lambda-rust-runtime/tree/main/examples
/// - https://github.com/aws-samples/serverless-rust-demo/

async fn function_handler(event: LambdaEvent<KafkaEvent>) -> Result<Value, Error>
{
    let payload = event.payload.records;

    for (_name, records) in payload.iter() {

        for record in records {

            let record_text = record.value.as_ref().ok_or("Value is None")?;
            info!("Record: {}", &record_text);

            // perform Base64 decoding
            let record_bytes = BASE64_STANDARD.decode(record_text)?;
            let message = std::str::from_utf8(&record_bytes)?;

            info!("Message: {}", message);
        }
    }

    Ok(().into())
}

#[tokio::main]
```

```
async fn main() -> Result<(), Error> {  
  
    // required to enable CloudWatch error logging by the runtime  
    tracing::init_default_subscriber();  
    info!("Setup CW subscriber!");  
  
    run(service_fn(function_handler)).await  
}
```

For a complete list of AWS SDK developer guides and code examples, see [Using Lambda with an AWS SDK](#). This topic also includes information about getting started and details about previous SDK versions.

Invoke a Lambda function from an Amazon S3 trigger

The following code examples show how to implement a Lambda function that receives an event triggered by uploading an object to an S3 bucket. The function retrieves the S3 bucket name and object key from the event parameter and calls the Amazon S3 API to retrieve and log the content type of the object.

.NET

AWS SDK for .NET

Note

There's more on GitHub. Find the complete example and learn how to set up and run in the [Serverless examples](#) repository.

Consuming an S3 event with Lambda using .NET.

```
// Copyright Amazon.com, Inc. or its affiliates. All Rights Reserved.  
// SPDX-License-Identifier: Apache-2.0  
using System.Threading.Tasks;  
using Amazon.Lambda.Core;  
using Amazon.S3;  
using System;  
using Amazon.Lambda.S3Events;  
using System.Web;
```

```
// Assembly attribute to enable the Lambda function's JSON input to be converted
// into a .NET class.
[assembly:
    LambdaSerializer(typeof(Amazon.Lambda.Serialization.SystemTextJson.DefaultLambdaJsonSerializer))]

namespace S3Integration
{
    public class Function
    {
        private static AmazonS3Client _s3Client;
        public Function() : this(null)
        {
        }

        internal Function(AmazonS3Client s3Client)
        {
            _s3Client = s3Client ?? new AmazonS3Client();
        }

        public async Task<string> Handler(S3Event evt, ILambdaContext context)
        {
            try
            {
                if (evt.Records.Count <= 0)
                {
                    context.Logger.LogLine("Empty S3 Event received");
                    return string.Empty;
                }

                var bucket = evt.Records[0].S3.Bucket.Name;
                var key = HttpUtility.UrlDecode(evt.Records[0].S3.Object.Key);

                context.Logger.LogLine($"Request is for {bucket} and {key}");

                var objectResult = await _s3Client.GetObjectAsync(bucket, key);

                context.Logger.LogLine($"Returning {objectResult.Key}");

                return objectResult.Key;
            }
            catch (Exception e)
            {
            }
        }
    }
}
```

```
        context.Logger.LogLine($"Error processing request -
    {e.Message}");
        return string.Empty;
    }
}
}
```

Go

SDK for Go V2

Note

There's more on GitHub. Find the complete example and learn how to set up and run in the [Serverless examples](#) repository.

Consuming an S3 event with Lambda using Go.

```
// Copyright Amazon.com, Inc. or its affiliates. All Rights Reserved.
// SPDX-License-Identifier: Apache-2.0
package main

import (
    "context"
    "log"

    "github.com/aws/aws-lambda-go/events"
    "github.com/aws/aws-lambda-go/lambda"
    "github.com/aws/aws-sdk-go-v2/config"
    "github.com/aws/aws-sdk-go-v2/service/s3"
)

func handler(ctx context.Context, s3Event events.S3Event) error {
    sdkConfig, err := config.LoadDefaultConfig(ctx)
    if err != nil {
        log.Printf("failed to load default config: %s", err)
        return err
    }
    s3Client := s3.NewFromConfig(sdkConfig)
```

```
for _, record := range s3Event.Records {
    bucket := record.S3.Bucket.Name
    key := record.S3.Object.URLDecodedKey
    headOutput, err := s3Client.HeadObject(ctx, &s3.HeadObjectInput{
        Bucket: &bucket,
        Key:     &key,
    })
    if err != nil {
        log.Printf("error getting head of object %s/%s: %s", bucket, key, err)
        return err
    }
    log.Printf("successfully retrieved %s/%s of type %s", bucket, key,
        *headOutput.ContentType)
}

return nil
}

func main() {
    lambda.Start(handler)
}
```

Java

SDK for Java 2.x

Note

There's more on GitHub. Find the complete example and learn how to set up and run in the [Serverless examples](#) repository.

Consuming an S3 event with Lambda using Java.

```
// Copyright Amazon.com, Inc. or its affiliates. All Rights Reserved.
// SPDX-License-Identifier: Apache-2.0
package example;

import software.amazon.awssdk.services.s3.model.HeadObjectRequest;
import software.amazon.awssdk.services.s3.model.HeadObjectResponse;
```

```
import software.amazon.awssdk.services.s3.S3Client;

import com.amazonaws.services.lambda.runtime.Context;
import com.amazonaws.services.lambda.runtime.RequestHandler;
import com.amazonaws.services.lambda.runtime.events.S3Event;
import
    com.amazonaws.services.lambda.runtime.events.models.s3.S3EventNotification.S3EventNotifi

import org.slf4j.Logger;
import org.slf4j.LoggerFactory;

public class Handler implements RequestHandler<S3Event, String> {
    private static final Logger logger = LoggerFactory.getLogger(Handler.class);
    @Override
    public String handleRequest(S3Event s3event, Context context) {
        try {
            S3EventNotificationRecord record = s3event.getRecords().get(0);
            String srcBucket = record.getS3().getBucket().getName();
            String srcKey = record.getS3().getObject().getUrlDecodedKey();

            S3Client s3Client = S3Client.builder().build();
            HeadObjectResponse headObject = getHeadObject(s3Client, srcBucket,
srcKey);

            logger.info("Successfully retrieved " + srcBucket + "/" + srcKey + " of
type " + headObject.contentType());

            return "Ok";
        } catch (Exception e) {
            throw new RuntimeException(e);
        }
    }

    private HeadObjectResponse getHeadObject(S3Client s3Client, String bucket,
String key) {
        HeadObjectRequest headObjectRequest = HeadObjectRequest.builder()
            .bucket(bucket)
            .key(key)
            .build();
        return s3Client.headObject(headObjectRequest);
    }
}
```

JavaScript

SDK for JavaScript (v3)

Note

There's more on GitHub. Find the complete example and learn how to set up and run in the [Serverless examples](#) repository.

Consuming an S3 event with Lambda using JavaScript.

```
import { S3Client, HeadObjectCommand } from "@aws-sdk/client-s3";

const client = new S3Client();

export const handler = async (event, context) => {

  // Get the object from the event and show its content type
  const bucket = event.Records[0].s3.bucket.name;
  const key = decodeURIComponent(event.Records[0].s3.object.key.replace(/\+/g,
  ' '));

  try {
    const { ContentType } = await client.send(new HeadObjectCommand({
      Bucket: bucket,
      Key: key,
    }));

    console.log('CONTENT TYPE:', ContentType);
    return ContentType;

  } catch (err) {
    console.log(err);
    const message = `Error getting object ${key} from bucket ${bucket}. Make
    sure they exist and your bucket is in the same region as this function.`;
    console.log(message);
    throw new Error(message);
  }
};
```

Consuming an S3 event with Lambda using TypeScript.

```
// Copyright Amazon.com, Inc. or its affiliates. All Rights Reserved.
// SPDX-License-Identifier: Apache-2.0
import { S3Event } from 'aws-lambda';
import { S3Client, HeadObjectCommand } from '@aws-sdk/client-s3';

const s3 = new S3Client({ region: process.env.AWS_REGION });

export const handler = async (event: S3Event): Promise<string | undefined> => {
  // Get the object from the event and show its content type
  const bucket = event.Records[0].s3.bucket.name;
  const key = decodeURIComponent(event.Records[0].s3.object.key.replace(/\+/g, '
  '));
  const params = {
    Bucket: bucket,
    Key: key,
  };
  try {
    const { ContentType } = await s3.send(new HeadObjectCommand(params));
    console.log('CONTENT TYPE:', ContentType);
    return ContentType;
  } catch (err) {
    console.log(err);
    const message = `Error getting object ${key} from bucket ${bucket}. Make sure
    they exist and your bucket is in the same region as this function.`;
    console.log(message);
    throw new Error(message);
  }
};
```

PHP

SDK for PHP

Note

There's more on GitHub. Find the complete example and learn how to set up and run in the [Serverless examples](#) repository.

Consuming an S3 event with Lambda using PHP.

```
<?php

use Bref\Context\Context;
use Bref\Event\S3\S3Event;
use Bref\Event\S3\S3Handler;
use Bref\Logger\StderrLogger;

require __DIR__ . '/vendor/autoload.php';

class Handler extends S3Handler
{
    private StderrLogger $logger;
    public function __construct(StderrLogger $logger)
    {
        $this->logger = $logger;
    }

    public function handleS3(S3Event $event, Context $context) : void
    {
        $this->logger->info("Processing S3 records");

        // Get the object from the event and show its content type
        $records = $event->getRecords();

        foreach ($records as $record)
        {
            $bucket = $record->getBucket()->getName();
            $key = urldecode($record->getObject()->getKey());

            try {
                $fileSize = urldecode($record->getObject()->getSize());
                echo "File Size: " . $fileSize . "\n";
                // TODO: Implement your custom processing logic here
            } catch (Exception $e) {
                echo $e->getMessage() . "\n";
                echo 'Error getting object ' . $key . ' from bucket ' .
                $bucket . '. Make sure they exist and your bucket is in the same region as this
                function.' . "\n";
                throw $e;
            }
        }
    }
}
```

```
    }  
  }  
  
  $logger = new StderrLogger();  
  return new Handler($logger);
```

Python

SDK for Python (Boto3)

Note

There's more on GitHub. Find the complete example and learn how to set up and run in the [Serverless examples](#) repository.

Consuming an S3 event with Lambda using Python.

```
# Copyright Amazon.com, Inc. or its affiliates. All Rights Reserved.  
# SPDX-License-Identifier: Apache-2.0  
import json  
import urllib.parse  
import boto3  
  
print('Loading function')  
  
s3 = boto3.client('s3')  
  
def lambda_handler(event, context):  
    #print("Received event: " + json.dumps(event, indent=2))  
  
    # Get the object from the event and show its content type  
    bucket = event['Records'][0]['s3']['bucket']['name']  
    key = urllib.parse.unquote_plus(event['Records'][0]['s3']['object']['key'],  
    encoding='utf-8')  
    try:  
        response = s3.get_object(Bucket=bucket, Key=key)  
        print("CONTENT TYPE: " + response['ContentType'])  
        return response['ContentType']  
    except Exception as e:
```

```
print(e)
print('Error getting object {} from bucket {}. Make sure they exist and
your bucket is in the same region as this function.'.format(key, bucket))
raise e
```

Ruby

SDK for Ruby

Note

There's more on GitHub. Find the complete example and learn how to set up and run in the [Serverless examples](#) repository.

Consuming an S3 event with Lambda using Ruby.

```
require 'json'
require 'uri'
require 'aws-sdk'

puts 'Loading function'

def lambda_handler(event:, context:)
  s3 = Aws::S3::Client.new(region: 'region') # Your AWS region
  # puts "Received event: #{JSON.dump(event)}"

  # Get the object from the event and show its content type
  bucket = event['Records'][0]['s3']['bucket']['name']
  key = URI.decode_www_form_component(event['Records'][0]['s3']['object']['key'],
Encoding::UTF_8)
  begin
    response = s3.get_object(bucket: bucket, key: key)
    puts "CONTENT TYPE: #{response.content_type}"
    return response.content_type
  rescue StandardError => e
    puts e.message
    puts "Error getting object #{key} from bucket #{bucket}. Make sure they exist
and your bucket is in the same region as this function."
    raise e
  end
end
```

```
end
```

Rust

SDK for Rust

Note

There's more on GitHub. Find the complete example and learn how to set up and run in the [Serverless examples](#) repository.

Consuming an S3 event with Lambda using Rust.

```
// Copyright Amazon.com, Inc. or its affiliates. All Rights Reserved.
// SPDX-License-Identifier: Apache-2.0
use aws_lambda_events::event::s3::S3Event;
use aws_sdk_s3::{Client};
use lambda_runtime::{run, service_fn, Error, LambdaEvent};

/// Main function
#[tokio::main]
async fn main() -> Result<(), Error> {
    tracing_subscriber::fmt()
        .with_max_level(tracing::Level::INFO)
        .with_target(false)
        .without_time()
        .init();

    // Initialize the AWS SDK for Rust
    let config = aws_config::load_from_env().await;
    let s3_client = Client::new(&config);

    let res = run(service_fn(|request: LambdaEvent<S3Event>| {
        function_handler(&s3_client, request)
    })).await;

    res
}
```

```
async fn function_handler(
    s3_client: &Client,
    evt: LambdaEvent<S3Event>
) -> Result<(), Error> {
    tracing::info!(records = ?evt.payload.records.len(), "Received request from
    SQS");

    if evt.payload.records.len() == 0 {
        tracing::info!("Empty S3 event received");
    }

    let bucket = evt.payload.records[0].s3.bucket.name.as_ref().expect("Bucket
    name to exist");
    let key = evt.payload.records[0].s3.object.key.as_ref().expect("Object key to
    exist");

    tracing::info!("Request is for {} and object {}", bucket, key);

    let s3_get_object_result = s3_client
        .get_object()
        .bucket(bucket)
        .key(key)
        .send()
        .await;

    match s3_get_object_result {
        Ok(_) => tracing::info!("S3 Get Object success, the s3GetObjectResult
        contains a 'body' property of type ByteStream"),
        Err(_) => tracing::info!("Failure with S3 Get Object request")
    }

    Ok(())
}
```

For a complete list of AWS SDK developer guides and code examples, see [Using Lambda with an AWS SDK](#). This topic also includes information about getting started and details about previous SDK versions.

Invoke a Lambda function from an Amazon SNS trigger

The following code examples show how to implement a Lambda function that receives an event triggered by receiving messages from an SNS topic. The function retrieves the messages from the event parameter and logs the content of each message.

.NET

AWS SDK for .NET

Note

There's more on GitHub. Find the complete example and learn how to set up and run in the [Serverless examples](#) repository.

Consuming an SNS event with Lambda using .NET.

```
// Copyright Amazon.com, Inc. or its affiliates. All Rights Reserved.
// SPDX-License-Identifier: Apache-2.0
using Amazon.Lambda.Core;
using Amazon.Lambda.SNSEvents;

// Assembly attribute to enable the Lambda function's JSON input to be converted
// into a .NET class.
[assembly:
    LambdaSerializer(typeof(Amazon.Lambda.Serialization.SystemTextJson.DefaultLambdaJsonSerializer))]

namespace SnsIntegration;

public class Function
{
    public async Task FunctionHandler(SNSEvent evnt, ILambdaContext context)
    {
        foreach (var record in evnt.Records)
        {
            await ProcessRecordAsync(record, context);
        }
        context.Logger.LogInformation("done");
    }
}
```



```
private async Task ProcessRecordAsync(SNSEvent.SNSRecord record,
ILambdaContext context)
{
    try
    {
        context.Logger.LogInformation($"Processed record
{record.Sns.Message}");

        // TODO: Do interesting work based on the new message
        await Task.CompletedTask;
    }
    catch (Exception e)
    {
        //You can use Dead Letter Queue to handle failures. By configuring a
Lambda DLQ.
        context.Logger.LogError($"An error occurred");
        throw;
    }
}
}
```

Go

SDK for Go V2

Note

There's more on GitHub. Find the complete example and learn how to set up and run in the [Serverless examples](#) repository.

Consuming an SNS event with Lambda using Go.

```
// Copyright Amazon.com, Inc. or its affiliates. All Rights Reserved.
// SPDX-License-Identifier: Apache-2.0
package main

import (
    "context"
    "fmt"

    "github.com/aws/aws-lambda-go/events"
}
```

```
"github.com/aws/aws-lambda-go/lambda"
)

func handler(ctx context.Context, snsEvent events.SNSEvent) {
    for _, record := range snsEvent.Records {
        processMessage(record)
    }
    fmt.Println("done")
}

func processMessage(record events.SNSEventRecord) {
    message := record.SNS.Message
    fmt.Printf("Processed message: %s\n", message)
    // TODO: Process your record here
}

func main() {
    lambda.Start(handler)
}
```

Java

SDK for Java 2.x

Note

There's more on GitHub. Find the complete example and learn how to set up and run in the [Serverless examples](#) repository.

Consuming an SNS event with Lambda using Java.

```
// Copyright Amazon.com, Inc. or its affiliates. All Rights Reserved.
// SPDX-License-Identifier: Apache-2.0
package example;

import com.amazonaws.services.lambda.runtime.Context;
import com.amazonaws.services.lambda.runtime.LambdaLogger;
import com.amazonaws.services.lambda.runtime.RequestHandler;
import com.amazonaws.services.lambda.runtime.events.SNSEvent;
import com.amazonaws.services.lambda.runtime.events.SNSEvent.SNSRecord;
```

```
import java.util.Iterator;
import java.util.List;

public class SNSEventHandler implements RequestHandler<SNSEvent, Boolean> {
    LambdaLogger logger;

    @Override
    public Boolean handleRequest(SNSEvent event, Context context) {
        logger = context.getLogger();
        List<SNSRecord> records = event.getRecords();
        if (!records.isEmpty()) {
            Iterator<SNSRecord> recordsIter = records.iterator();
            while (recordsIter.hasNext()) {
                processRecord(recordsIter.next());
            }
        }
        return Boolean.TRUE;
    }

    public void processRecord(SNSRecord record) {
        try {
            String message = record.getSNS().getMessage();
            logger.log("message: " + message);
        } catch (Exception e) {
            throw new RuntimeException(e);
        }
    }
}
```

JavaScript

SDK for JavaScript (v3)

Note

There's more on GitHub. Find the complete example and learn how to set up and run in the [Serverless examples](#) repository.

Consuming an SNS event with Lambda using JavaScript.

```
// Copyright Amazon.com, Inc. or its affiliates. All Rights Reserved.
// SPDX-License-Identifier: Apache-2.0
exports.handler = async (event, context) => {
  for (const record of event.Records) {
    await processMessageAsync(record);
  }
  console.info("done");
};

async function processMessageAsync(record) {
  try {
    const message = JSON.stringify(record.Sns.Message);
    console.log(`Processed message ${message}`);
    await Promise.resolve(1); //Placeholder for actual async work
  } catch (err) {
    console.error("An error occurred");
    throw err;
  }
}
```

Consuming an SNS event with Lambda using TypeScript.

```
// Copyright Amazon.com, Inc. or its affiliates. All Rights Reserved.
// SPDX-License-Identifier: Apache-2.0
import { SNSEvent, Context, SNSHandler, SNSEventRecord } from "aws-lambda";

export const functionHandler: SNSHandler = async (
  event: SNSEvent,
  context: Context
```

```
    ): Promise<void> => {
      for (const record of event.Records) {
        await processMessageAsync(record);
      }
      console.info("done");
    };

    async function processMessageAsync(record: SNSEventRecord): Promise<any> {
      try {
        const message: string = JSON.stringify(record.Sns.Message);
        console.log(`Processed message ${message}`);
        await Promise.resolve(1); //Placeholder for actual async work
      } catch (err) {
        console.error("An error occurred");
        throw err;
      }
    }
  }
}
```

PHP

SDK for PHP

Note

There's more on GitHub. Find the complete example and learn how to set up and run in the [Serverless examples](#) repository.

Consuming an SNS event with Lambda using PHP.

```
// Copyright Amazon.com, Inc. or its affiliates. All Rights Reserved.
// SPDX-License-Identifier: Apache-2.0
<?php

/*
Since native PHP support for AWS Lambda is not available, we are utilizing Bref's
PHP functions runtime for AWS Lambda.
For more information on Bref's PHP runtime for Lambda, refer to: https://bref.sh/
docs/runtimes/function

Another approach would be to create a custom runtime.
```

```
A practical example can be found here: https://aws.amazon.com/blogs/apn/aws-lambda-custom-runtime-for-php-a-practical-example/
*/

// Additional composer packages may be required when using Bref or any other PHP
// functions runtime.
// require __DIR__ . '/vendor/autoload.php';

use Bref\Context\Context;
use Bref\Event\Sns\SnsEvent;
use Bref\Event\Sns\SnsHandler;

class Handler extends SnsHandler
{
    public function handleSns(SnsEvent $event, Context $context): void
    {
        foreach ($event->getRecords() as $record) {
            $message = $record->getMessage();

            // TODO: Implement your custom processing logic here
            // Any exception thrown will be logged and the invocation will be
            // marked as failed

            echo "Processed Message: $message" . PHP_EOL;
        }
    }
}

return new Handler();
```

Python

SDK for Python (Boto3)

Note

There's more on GitHub. Find the complete example and learn how to set up and run in the [Serverless examples](#) repository.

Consuming an SNS event with Lambda using Python.

```
# Copyright Amazon.com, Inc. or its affiliates. All Rights Reserved.
# SPDX-License-Identifier: Apache-2.0
def lambda_handler(event, context):
    for record in event['Records']:
        process_message(record)
    print("done")

def process_message(record):
    try:
        message = record['Sns']['Message']
        print(f"Processed message {message}")
        # TODO; Process your record here

    except Exception as e:
        print("An error occurred")
        raise e
```

Ruby

SDK for Ruby

Note

There's more on GitHub. Find the complete example and learn how to set up and run in the [Serverless examples](#) repository.

Consuming an SNS event with Lambda using Ruby.

```
# Copyright Amazon.com, Inc. or its affiliates. All Rights Reserved.
# SPDX-License-Identifier: Apache-2.0
def lambda_handler(event:, context:)
    event['Records'].map { |record| process_message(record) }
end

def process_message(record)
    message = record['Sns']['Message']
    puts("Processing message: #{message}")
rescue StandardError => e
    puts("Error processing message: #{e}")
```

```
    raise
end
```

Rust

SDK for Rust

Note

There's more on GitHub. Find the complete example and learn how to set up and run in the [Serverless examples](#) repository.

Consuming an SNS event with Lambda using Rust.

```
// Copyright Amazon.com, Inc. or its affiliates. All Rights Reserved.
// SPDX-License-Identifier: Apache-2.0
use aws_lambda_events::event::sns::SnsEvent;
use aws_lambda_events::sns::SnsRecord;
use lambda_runtime::{run, service_fn, Error, LambdaEvent};
use tracing::info;

// Built with the following dependencies:
// aws_lambda_events = { version = "0.10.0", default-features = false, features
//   = ["sns"] }
// lambda_runtime = "0.8.1"
// tokio = { version = "1", features = ["macros"] }
// tracing = { version = "0.1", features = ["log"] }
// tracing-subscriber = { version = "0.3", default-features = false, features =
//   ["fmt"] }

async fn function_handler(event: LambdaEvent<SnsEvent>) -> Result<(), Error> {
    for event in event.payload.records {
        process_record(&event)?;
    }

    Ok(())
}

fn process_record(record: &SnsRecord) -> Result<(), Error> {
    info!("Processing SNS Message: {}", record.sns.message);
}
```



```
    // Implement your record handling code here.

    Ok(())
}

#[tokio::main]
async fn main() -> Result<(), Error> {
    tracing_subscriber::fmt()
        .with_max_level(tracing::Level::INFO)
        .with_target(false)
        .without_time()
        .init();

    run(service_fn(function_handler)).await
}
```

For a complete list of AWS SDK developer guides and code examples, see [Using Lambda with an AWS SDK](#). This topic also includes information about getting started and details about previous SDK versions.

Invoke a Lambda function from an Amazon SQS trigger

The following code examples show how to implement a Lambda function that receives an event triggered by receiving messages from an SQS queue. The function retrieves the messages from the event parameter and logs the content of each message.

.NET

AWS SDK for .NET

Note

There's more on GitHub. Find the complete example and learn how to set up and run in the [Serverless examples](#) repository.

Consuming an SQS event with Lambda using .NET.

```
// Copyright Amazon.com, Inc. or its affiliates. All Rights Reserved.
// SPDX-License-Identifier: Apache-2.0
```

```
using Amazon.Lambda.Core;
using Amazon.Lambda.SQSEvents;

// Assembly attribute to enable the Lambda function's JSON input to be converted
// into a .NET class.
[assembly:
    LambdaSerializer(typeof(Amazon.Lambda.Serialization.SystemTextJson.DefaultLambdaJsonSerializer))]

namespace SqsIntegrationSampleCode
{
    public async Task FunctionHandler(SQSEvent evnt, ILambdaContext context)
    {
        foreach (var message in evnt.Records)
        {
            await ProcessMessageAsync(message, context);
        }

        context.Logger.LogInformation("done");
    }

    private async Task ProcessMessageAsync(SQSEvent.SQSMessage message,
        ILambdaContext context)
    {
        try
        {
            context.Logger.LogInformation($"Processed message {message.Body}");

            // TODO: Do interesting work based on the new message
            await Task.CompletedTask;
        }
        catch (Exception e)
        {
            //You can use Dead Letter Queue to handle failures. By configuring a
            //Lambda DLQ.
            context.Logger.LogError($"An error occurred");
            throw;
        }
    }
}
```

Go

SDK for Go V2

 **Note**

There's more on GitHub. Find the complete example and learn how to set up and run in the [Serverless examples](#) repository.

Consuming an SQS event with Lambda using Go.

```
// Copyright Amazon.com, Inc. or its affiliates. All Rights Reserved.
// SPDX-License-Identifier: Apache-2.0
package integration_sqs_to_lambda

import (
    "fmt"
    "github.com/aws/aws-lambda-go/events"
    "github.com/aws/aws-lambda-go/lambda"
)

func handler(event events.SQSEvent) error {
    for _, record := range event.Records {
        err := processMessage(record)
        if err != nil {
            return err
        }
    }
    fmt.Println("done")
    return nil
}

func processMessage(record events.SQSMessage) error {
    fmt.Printf("Processed message %s\n", record.Body)
    // TODO: Do interesting work based on the new message
    return nil
}

func main() {
    lambda.Start(handler)
}
```

Java

SDK for Java 2.x

 **Note**

There's more on GitHub. Find the complete example and learn how to set up and run in the [Serverless examples](#) repository.

Consuming an SQS event with Lambda using Java.

```
// Copyright Amazon.com, Inc. or its affiliates. All Rights Reserved.
// SPDX-License-Identifier: Apache-2.0
import com.amazonaws.services.lambda.runtime.Context;
import com.amazonaws.services.lambda.runtime.RequestHandler;
import com.amazonaws.services.lambda.runtime.events.SQSEvent;
import com.amazonaws.services.lambda.runtime.events.SQSEvent.SQSMessage;

public class Function implements RequestHandler<SQSEvent, Void> {
    @Override
    public Void handleRequest(SQSEvent sqsEvent, Context context) {
        for (SQSMessage msg : sqsEvent.getRecords()) {
            processMessage(msg, context);
        }
        context.getLogger().log("done");
        return null;
    }

    private void processMessage(SQSMessage msg, Context context) {
        try {
            context.getLogger().log("Processed message " + msg.getBody());

            // TODO: Do interesting work based on the new message

        } catch (Exception e) {
            context.getLogger().log("An error occurred");
            throw e;
        }
    }
}
```

```
}  
}
```

JavaScript

SDK for JavaScript (v3)

Note

There's more on GitHub. Find the complete example and learn how to set up and run in the [Serverless examples](#) repository.

Consuming an SQS event with Lambda using JavaScript.

```
// Copyright Amazon.com, Inc. or its affiliates. All Rights Reserved.  
// SPDX-License-Identifier: Apache-2.0  
exports.handler = async (event, context) => {  
  for (const message of event.Records) {  
    await processMessageAsync(message);  
  }  
  console.info("done");  
};  
  
async function processMessageAsync(message) {  
  try {  
    console.log(`Processed message ${message.body}`);  
    // TODO: Do interesting work based on the new message  
    await Promise.resolve(1); //Placeholder for actual async work  
  } catch (err) {  
    console.error("An error occurred");  
    throw err;  
  }  
}
```

Consuming an SQS event with Lambda using TypeScript.

```
// Copyright Amazon.com, Inc. or its affiliates. All Rights Reserved.  
// SPDX-License-Identifier: Apache-2.0  
import { SQSEvent, Context, SQSHandler, SQSRecord } from "aws-lambda";
```

```
export const functionHandler: SQSHandler = async (
  event: SQSEvent,
  context: Context
): Promise<void> => {
  for (const message of event.Records) {
    await processMessageAsync(message);
  }
  console.info("done");
};

async function processMessageAsync(message: SQSRecord): Promise<any> {
  try {
    console.log(`Processed message ${message.body}`);
    // TODO: Do interesting work based on the new message
    await Promise.resolve(1); //Placeholder for actual async work
  } catch (err) {
    console.error("An error occurred");
    throw err;
  }
}
```

PHP

SDK for PHP

Note

There's more on GitHub. Find the complete example and learn how to set up and run in the [Serverless examples](#) repository.

Consuming an SQS event with Lambda using PHP.

```
// Copyright Amazon.com, Inc. or its affiliates. All Rights Reserved.
// SPDX-License-Identifier: Apache-2.0
<?php

# using bref/bref and bref/logger for simplicity

use Bref\Context\Context;
```

```
use Bref\Event\InvalidLambdaEvent;
use Bref\Event\Sqs\SqsEvent;
use Bref\Event\Sqs\SqsHandler;
use Bref\Logger\StderrLogger;

require __DIR__ . '/vendor/autoload.php';

class Handler extends SqsHandler
{
    private StderrLogger $logger;
    public function __construct(StderrLogger $logger)
    {
        $this->logger = $logger;
    }

    /**
     * @throws InvalidLambdaEvent
     */
    public function handleSqs(SqsEvent $event, Context $context): void
    {
        foreach ($event->getRecords() as $record) {
            $body = $record->getBody();
            // TODO: Do interesting work based on the new message
        }
    }
}

$logger = new StderrLogger();
return new Handler($logger);
```

Python

SDK for Python (Boto3)

Note

There's more on GitHub. Find the complete example and learn how to set up and run in the [Serverless examples](#) repository.

Consuming an SQS event with Lambda using Python.

```
# Copyright Amazon.com, Inc. or its affiliates. All Rights Reserved.
# SPDX-License-Identifier: Apache-2.0
def lambda_handler(event, context):
    for message in event['Records']:
        process_message(message)
    print("done")

def process_message(message):
    try:
        print(f"Processed message {message['body']}")
        # TODO: Do interesting work based on the new message
    except Exception as err:
        print("An error occurred")
        raise err
```

Ruby

SDK for Ruby

Note

There's more on GitHub. Find the complete example and learn how to set up and run in the [Serverless examples](#) repository.

Consuming an SQS event with Lambda using Ruby.

```
# Copyright Amazon.com, Inc. or its affiliates. All Rights Reserved.
# SPDX-License-Identifier: Apache-2.0
def lambda_handler(event:, context:)
    event['Records'].each do |message|
        process_message(message)
    end
    puts "done"
end

def process_message(message)
    begin
        puts "Processed message #{message['body']}"
        # TODO: Do interesting work based on the new message
    end
```



```

rescue StandardError => err
  puts "An error occurred"
  raise err
end
end

```

Rust

SDK for Rust

Note

There's more on GitHub. Find the complete example and learn how to set up and run in the [Serverless examples](#) repository.

Consuming an SQS event with Lambda using Rust.

```

// Copyright Amazon.com, Inc. or its affiliates. All Rights Reserved.
// SPDX-License-Identifier: Apache-2.0
use aws_lambda_events::event::sqs::SqsEvent;
use lambda_runtime::{run, service_fn, Error, LambdaEvent};

async fn function_handler(event: LambdaEvent<SqsEvent>) -> Result<(), Error> {
    event.payload.records.iter().for_each(|record| {
        // process the record
        tracing::info!("Message body: {}",
            record.body.as_deref().unwrap_or_default())
    });

    Ok(())
}

#[tokio::main]
async fn main() -> Result<(), Error> {
    tracing_subscriber::fmt()
        .with_max_level(tracing::Level::INFO)
        // disable printing the name of the module in every log line.
        .with_target(false)
        // disabling time is handy because CloudWatch will add the ingestion
        time.
        .without_time()
}

```

```
        .init();

        run(service_fn(function_handler)).await
    }
```

For a complete list of AWS SDK developer guides and code examples, see [Using Lambda with an AWS SDK](#). This topic also includes information about getting started and details about previous SDK versions.

Reporting batch item failures for Lambda functions with a Kinesis trigger

The following code examples show how to implement partial batch response for Lambda functions that receive events from a Kinesis stream. The function reports the batch item failures in the response, signaling to Lambda to retry those messages later.

.NET

AWS SDK for .NET

Note

There's more on GitHub. Find the complete example and learn how to set up and run in the [Serverless examples](#) repository.

Reporting Kinesis batch item failures with Lambda using .NET.

```
// Copyright Amazon.com, Inc. or its affiliates. All Rights Reserved.
// SPDX-License-Identifier: Apache-2.0
using System.Text;
using System.Text.Json.Serialization;
using Amazon.Lambda.Core;
using Amazon.Lambda.KinesisEvents;
using AWS.Lambda.Powertools.Logging;

// Assembly attribute to enable the Lambda function's JSON input to be converted
// into a .NET class.
[assembly:
    LambdaSerializer(typeof(Amazon.Lambda.Serialization.SystemTextJson.DefaultLambdaJsonSerializer))
]
```

```
namespace KinesisIntegration;

public class Function
{
    // Powertools Logger requires an environment variables against your function
    // POWERTOOLS_SERVICE_NAME
    [Logging(LogEvent = true)]
    public async Task<StreamsEventResponse> FunctionHandler(KinesisEvent evnt,
        ILambdaContext context)
    {
        if (evnt.Records.Count == 0)
        {
            Logger.LogInformation("Empty Kinesis Event received");
            return new StreamsEventResponse();
        }

        foreach (var record in evnt.Records)
        {
            try
            {
                Logger.LogInformation($"Processed Event with EventId:
{record.EventId}");
                string data = await GetRecordDataAsync(record.Kinesis, context);
                Logger.LogInformation($"Data: {data}");
                // TODO: Do interesting work based on the new data
            }
            catch (Exception ex)
            {
                Logger.LogError($"An error occurred {ex.Message}");
                /* Since we are working with streams, we can return the failed
item immediately.
                Lambda will immediately begin to retry processing from this
failed item onwards. */
                return new StreamsEventResponse
                {
                    BatchItemFailures = new
List<StreamsEventResponse.BatchItemFailure>
                {
                    new StreamsEventResponse.BatchItemFailure
{ ItemIdentifier = record.Kinesis.SequenceNumber }
                }
                };
            }
        }
    }
}
```

```

    }
    Logger.LogInformation($"Successfully processed {evnt.Records.Count}
records.");
    return new StreamsEventResponse();
}

private async Task<string> GetRecordDataAsync(KinesisEvent.Record record,
ILambdaContext context)
{
    byte[] bytes = record.Data.ToArray();
    string data = Encoding.UTF8.GetString(bytes);
    await Task.CompletedTask; //Placeholder for actual async work
    return data;
}
}

public class StreamsEventResponse
{
    [JsonPropertyName("batchItemFailures")]
    public IList<BatchItemFailure> BatchItemFailures { get; set; }
    public class BatchItemFailure
    {
        [JsonPropertyName("itemIdentifier")]
        public string ItemIdentifier { get; set; }
    }
}
}

```

Go

SDK for Go V2

Note

There's more on GitHub. Find the complete example and learn how to set up and run in the [Serverless examples](#) repository.

Reporting Kinesis batch item failures with Lambda using Go.

```

// Copyright Amazon.com, Inc. or its affiliates. All Rights Reserved.
// SPDX-License-Identifier: Apache-2.0
package main

```

```
import (
    "context"
    "fmt"
    "github.com/aws/aws-lambda-go/events"
    "github.com/aws/aws-lambda-go/lambda"
)

func handler(ctx context.Context, kinesisEvent events.KinesisEvent)
    (map[string]interface{}, error) {
    batchItemFailures := []map[string]interface{}{}

    for _, record := range kinesisEvent.Records {
        curRecordSequenceNumber := ""

        // Process your record
        if /* Your record processing condition here */ {
            curRecordSequenceNumber = record.Kinesis.SequenceNumber
        }

        // Add a condition to check if the record processing failed
        if curRecordSequenceNumber != "" {
            batchItemFailures = append(batchItemFailures, map[string]interface{}{
                "itemIdentifier": curRecordSequenceNumber})
        }
    }

    kinesisBatchResponse := map[string]interface{}{
        "batchItemFailures": batchItemFailures,
    }
    return kinesisBatchResponse, nil
}

func main() {
    lambda.Start(handler)
}
```

Java

SDK for Java 2.x

 **Note**

There's more on GitHub. Find the complete example and learn how to set up and run in the [Serverless examples](#) repository.

Reporting Kinesis batch item failures with Lambda using Java.

```
// Copyright Amazon.com, Inc. or its affiliates. All Rights Reserved.
// SPDX-License-Identifier: Apache-2.0
import com.amazonaws.services.lambda.runtime.Context;
import com.amazonaws.services.lambda.runtime.RequestHandler;
import com.amazonaws.services.lambda.runtime.events.KinesisEvent;
import com.amazonaws.services.lambda.runtime.events.StreamsEventResponse;

import java.io.Serializable;
import java.util.ArrayList;
import java.util.List;

public class ProcessKinesisRecords implements RequestHandler<KinesisEvent,
StreamsEventResponse> {

    @Override
    public StreamsEventResponse handleRequest(KinesisEvent input, Context
context) {

        List<StreamsEventResponse.BatchItemFailure> batchItemFailures = new
ArrayList<>();
        String curRecordSequenceNumber = "";

        for (KinesisEvent.KinesisEventRecord kinesisEventRecord :
input.getRecords()) {
            try {
                //Process your record
                KinesisEvent.Record kinesisRecord =
kinesisEventRecord.getKinesis();
                curRecordSequenceNumber = kinesisRecord.getSequenceNumber();

            } catch (Exception e) {
```

```

        /* Since we are working with streams, we can return the failed
        item immediately.
           Lambda will immediately begin to retry processing from this
        failed item onwards. */
        batchItemFailures.add(new
StreamsEventResponse.BatchItemFailure(curRecordSequenceNumber));
        return new StreamsEventResponse(batchItemFailures);
    }
}

return new StreamsEventResponse(batchItemFailures);
}
}

```

JavaScript

SDK for JavaScript (v3)

Note

There's more on GitHub. Find the complete example and learn how to set up and run in the [Serverless examples](#) repository.

Reporting Kinesis batch item failures with Lambda using Javascript.

```

// Copyright Amazon.com, Inc. or its affiliates. All Rights Reserved.
// SPDX-License-Identifier: Apache-2.0
exports.handler = async (event, context) => {
  for (const record of event.Records) {
    try {
      console.log(`Processed Kinesis Event - EventID: ${record.eventID}`);
      const recordData = await getRecordDataAsync(record.kinesis);
      console.log(`Record Data: ${recordData}`);
      // TODO: Do interesting work based on the new data
    } catch (err) {
      console.error(`An error occurred ${err}`);
      /* Since we are working with streams, we can return the failed item
      immediately.
         Lambda will immediately begin to retry processing from this failed
      item onwards. */
    }
  }
}

```

```

    return {
      batchItemFailures: [{ itemIdentifier: record.kinesis.sequenceNumber }],
    };
  }
}
console.log(`Successfully processed ${event.Records.length} records.`);
return { batchItemFailures: [] };
};

async function getRecordDataAsync(payload) {
  var data = Buffer.from(payload.data, "base64").toString("utf-8");
  await Promise.resolve(1); //Placeholder for actual async work
  return data;
}

```

Reporting Kinesis batch item failures with Lambda using TypeScript.

```

// Copyright Amazon.com, Inc. or its affiliates. All Rights Reserved.
// SPDX-License-Identifier: Apache-2.0
import {
  KinesisStreamEvent,
  Context,
  KinesisStreamHandler,
  KinesisStreamRecordPayload,
  KinesisStreamBatchResponse,
} from "aws-lambda";
import { Buffer } from "buffer";
import { Logger } from "@aws-lambda-powertools/logger";

const logger = new Logger({
  logLevel: "INFO",
  serviceName: "kinesis-stream-handler-sample",
});

export const functionHandler: KinesisStreamHandler = async (
  event: KinesisStreamEvent,
  context: Context
): Promise<KinesisStreamBatchResponse> => {
  for (const record of event.Records) {
    try {
      logger.info(`Processed Kinesis Event - EventID: ${record.eventID}`);
      const recordData = await getRecordDataAsync(record.kinesis);
    }
  }
}

```



```
    logger.info(`Record Data: ${recordData}`);
    // TODO: Do interesting work based on the new data
  } catch (err) {
    logger.error(`An error occurred ${err}`);
    /* Since we are working with streams, we can return the failed item
    immediately.
        Lambda will immediately begin to retry processing from this failed
    item onwards. */
    return {
      batchItemFailures: [{ itemIdentifier: record.kinesis.sequenceNumber }],
    };
  }
}
logger.info(`Successfully processed ${event.Records.length} records.`);
return { batchItemFailures: [] };
};

async function getRecordDataAsync(
  payload: KinesisStreamRecordPayload
): Promise<string> {
  var data = Buffer.from(payload.data, "base64").toString("utf-8");
  await Promise.resolve(1); //Placeholder for actual async work
  return data;
}
```

PHP

SDK for PHP

Note

There's more on GitHub. Find the complete example and learn how to set up and run in the [Serverless examples](#) repository.

Reporting Kinesis batch item failures with Lambda using PHP.

```
// Copyright Amazon.com, Inc. or its affiliates. All Rights Reserved.
// SPDX-License-Identifier: Apache-2.0
<?php
```

```
# using bref/bref and bref/logger for simplicity

use Bref\Context\Context;
use Bref\Event\Kinesis\KinesisEvent;
use Bref\Event\Handler as StdHandler;
use Bref\Logger\StderrLogger;

require __DIR__ . '/vendor/autoload.php';

class Handler implements StdHandler
{
    private StderrLogger $logger;
    public function __construct(StderrLogger $logger)
    {
        $this->logger = $logger;
    }

    /**
     * @throws JsonException
     * @throws \Bref\Event\InvalidLambdaEvent
     */
    public function handle(mixed $event, Context $context): array
    {
        $kinesisEvent = new KinesisEvent($event);
        $this->logger->info("Processing records");
        $records = $kinesisEvent->getRecords();

        $failedRecords = [];
        foreach ($records as $record) {
            try {
                $data = $record->getData();
                $this->logger->info(json_encode($data));
                // TODO: Do interesting work based on the new data
            } catch (Exception $e) {
                $this->logger->error($e->getMessage());
                // failed processing the record
                $failedRecords[] = $record->getSequenceNumber();
            }
        }
        $totalRecords = count($records);
        $this->logger->info("Successfully processed $totalRecords records");

        // change format for the response
        $failures = array_map(
```

```

        fn(string $sequenceNumber) => ['itemIdentifier' => $sequenceNumber],
        $failedRecords
    );

    return [
        'batchItemFailures' => $failures
    ];
}
}

$logger = new StderrLogger();
return new Handler($logger);

```

Python

SDK for Python (Boto3)

Note

There's more on GitHub. Find the complete example and learn how to set up and run in the [Serverless examples](#) repository.

Reporting Kinesis batch item failures with Lambda using Python.

```

# Copyright Amazon.com, Inc. or its affiliates. All Rights Reserved.
# SPDX-License-Identifier: Apache-2.0
def handler(event, context):
    records = event.get("Records")
    curRecordSequenceNumber = ""

    for record in records:
        try:
            # Process your record
            curRecordSequenceNumber = record["kinesis"]["sequenceNumber"]
        except Exception as e:
            # Return failed record's sequence number
            return {"batchItemFailures":[{"itemIdentifier":
curRecordSequenceNumber}]}

    return {"batchItemFailures":[]}

```

Ruby

SDK for Ruby

Note

There's more on GitHub. Find the complete example and learn how to set up and run in the [Serverless examples](#) repository.

Reporting Kinesis batch item failures with Lambda using Ruby.

```
# Copyright Amazon.com, Inc. or its affiliates. All Rights Reserved.
# SPDX-License-Identifier: Apache-2.0
require 'aws-sdk'

def lambda_handler(event:, context:)
  batch_item_failures = []

  event['Records'].each do |record|
    begin
      puts "Processed Kinesis Event - EventID: #{record['eventID']}"
      record_data = get_record_data_async(record['kinesis'])
      puts "Record Data: #{record_data}"
      # TODO: Do interesting work based on the new data
    rescue StandardError => err
      puts "An error occurred #{err}"
      # Since we are working with streams, we can return the failed item
      # immediately.
      # Lambda will immediately begin to retry processing from this failed item
      # onwards.
      return { batchItemFailures: [{ itemIdentifier: record['kinesis']
['sequenceNumber'] }] }
    end
  end

  puts "Successfully processed #{event['Records'].length} records."
  { batchItemFailures: batch_item_failures }
end
```

```
def get_record_data_async(payload)
  data = Base64.decode64(payload['data']).force_encoding('utf-8')
  # Placeholder for actual async work
  sleep(1)
  data
end
```

Rust

SDK for Rust

Note

There's more on GitHub. Find the complete example and learn how to set up and run in the [Serverless examples](#) repository.

Reporting Kinesis batch item failures with Lambda using Rust.

```
// Copyright Amazon.com, Inc. or its affiliates. All Rights Reserved.
// SPDX-License-Identifier: Apache-2.0
use aws_lambda_events::{
    event::kinesis::KinesisEvent,
    kinesis::KinesisEventRecord,
    streams::{KinesisBatchItemFailure, KinesisEventResponse},
};
use lambda_runtime::{run, service_fn, Error, LambdaEvent};

async fn function_handler(event: LambdaEvent<KinesisEvent>) ->
Result<KinesisEventResponse, Error> {
    let mut response = KinesisEventResponse {
        batch_item_failures: vec![],
    };

    if event.payload.records.is_empty() {
        tracing::info!("No records found. Exiting.");
        return Ok(response);
    }

    for record in &event.payload.records {
        tracing::info!(
            "EventId: {}",
```

```

        record.event_id.as_deref().unwrap_or_default()
    );

    let record_processing_result = process_record(record);

    if record_processing_result.is_err() {
        response.batch_item_failures.push(KinesisBatchItemFailure {
            item_identifier: record.kinesis.sequence_number.clone(),
        });
        /* Since we are working with streams, we can return the failed item
immediately.
        Lambda will immediately begin to retry processing from this failed
item onwards. */
        return Ok(response);
    }

    tracing::info!(
        "Successfully processed {} records",
        event.payload.records.len()
    );

    Ok(response)
}

fn process_record(record: &KinesisEventRecord) -> Result<(), Error> {
    let record_data = std::str::from_utf8(record.kinesis.data.as_slice());

    if let Some(err) = record_data.err() {
        tracing::error!("Error: {}", err);
        return Err(Error::from(err));
    }

    let record_data = record_data.unwrap_or_default();

    // do something interesting with the data
    tracing::info!("Data: {}", record_data);

    Ok(())
}

#[tokio::main]
async fn main() -> Result<(), Error> {
    tracing_subscriber::fmt()

```

```
        .with_max_level(tracing::Level::INFO)
        // disable printing the name of the module in every log line.
        .with_target(false)
        // disabling time is handy because CloudWatch will add the ingestion
time.
        .without_time()
        .init();

    run(service_fn(function_handler)).await
}
```

For a complete list of AWS SDK developer guides and code examples, see [Using Lambda with an AWS SDK](#). This topic also includes information about getting started and details about previous SDK versions.

Reporting batch item failures for Lambda functions with a DynamoDB trigger

The following code examples show how to implement partial batch response for Lambda functions that receive events from a DynamoDB stream. The function reports the batch item failures in the response, signaling to Lambda to retry those messages later.

.NET

AWS SDK for .NET

Note

There's more on GitHub. Find the complete example and learn how to set up and run in the [Serverless examples](#) repository.

Reporting DynamoDB batch item failures with Lambda using .NET.

```
// Copyright Amazon.com, Inc. or its affiliates. All Rights Reserved.
// SPDX-License-Identifier: Apache-2.0
using System.Text.Json;
using System.Text;
using Amazon.Lambda.Core;
using Amazon.Lambda.DynamoDBEvents;
```

```
// Assembly attribute to enable the Lambda function's JSON input to be converted
// into a .NET class.
[assembly:
    LambdaSerializer(typeof(Amazon.Lambda.Serialization.SystemTextJson.DefaultLambdaJsonSerializer))]

namespace AWSLambda_DDB;

public class Function
{
    public StreamsEventResponse FunctionHandler(DynamoDBEvent dynamoEvent,
        ILambdaContext context)
    {
        context.Logger.LogInformation($"Beginning to process
        {dynamoEvent.Records.Count} records...");
        List<StreamsEventResponse.BatchItemFailure> batchItemFailures = new
        List<StreamsEventResponse.BatchItemFailure>();
        StreamsEventResponse streamsEventResponse = new StreamsEventResponse();

        foreach (var record in dynamoEvent.Records)
        {
            try
            {
                var sequenceNumber = record.Dynamodb.SequenceNumber;
                context.Logger.LogInformation(sequenceNumber);
            }
            catch (Exception ex)
            {
                context.Logger.LogError(ex.Message);
                batchItemFailures.Add(new StreamsEventResponse.BatchItemFailure()
                { ItemIdentifier = record.Dynamodb.SequenceNumber });
            }
        }

        if (batchItemFailures.Count > 0)
        {
            streamsEventResponse.BatchItemFailures = batchItemFailures;
        }

        context.Logger.LogInformation("Stream processing complete.");
        return streamsEventResponse;
    }
}
```



```
}
```

Go

SDK for Go V2

Note

There's more on GitHub. Find the complete example and learn how to set up and run in the [Serverless examples](#) repository.

Reporting DynamoDB batch item failures with Lambda using Go.

```
// Copyright Amazon.com, Inc. or its affiliates. All Rights Reserved.
// SPDX-License-Identifier: Apache-2.0
package main

import (
    "context"
    "github.com/aws/aws-lambda-go/events"
    "github.com/aws/aws-lambda-go/lambda"
)

type BatchItemFailure struct {
    ItemIdentifier string `json:"ItemIdentifier"`
}

type BatchResult struct {
    BatchItemFailures []BatchItemFailure `json:"BatchItemFailures"`
}

func HandleRequest(ctx context.Context, event events.DynamoDBEvent)
(*BatchResult, error) {
    var batchItemFailures []BatchItemFailure
    curRecordSequenceNumber := ""

    for _, record := range event.Records {
        // Process your record
        curRecordSequenceNumber = record.Change.SequenceNumber
    }
}
```

```
if curRecordSequenceNumber != "" {
    batchItemFailures = append(batchItemFailures, BatchItemFailure{ItemIdentifier:
curRecordSequenceNumber})
}

batchResult := BatchResult{
    BatchItemFailures: batchItemFailures,
}

return &batchResult, nil
}

func main() {
    lambda.Start(HandleRequest)
}
```

Java

SDK for Java 2.x

Note

There's more on GitHub. Find the complete example and learn how to set up and run in the [Serverless examples](#) repository.

Reporting DynamoDB batch item failures with Lambda using Java.

```
// Copyright Amazon.com, Inc. or its affiliates. All Rights Reserved.
// SPDX-License-Identifier: Apache-2.0
import com.amazonaws.services.lambda.runtime.Context;
import com.amazonaws.services.lambda.runtime.RequestHandler;
import com.amazonaws.services.lambda.runtime.events.DynamodbEvent;
import com.amazonaws.services.lambda.runtime.events.StreamsEventResponse;
import com.amazonaws.services.lambda.runtime.events.models.dynamodb.StreamRecord;

import java.io.Serializable;
import java.util.ArrayList;
import java.util.List;
```

```
public class ProcessDynamodbRecords implements RequestHandler<DynamodbEvent,
    Serializable> {

    @Override
    public StreamsEventResponse handleRequest(DynamodbEvent input, Context
    context) {

        List<StreamsEventResponse.BatchItemFailure> batchItemFailures = new
    ArrayList<>();
        String curRecordSequenceNumber = "";

        for (DynamodbEvent.DynamodbStreamRecord dynamodbStreamRecord :
    input.getRecords()) {
            try {
                //Process your record
                StreamRecord dynamodbRecord = dynamodbStreamRecord.getDynamodb();
                curRecordSequenceNumber = dynamodbRecord.getSequenceNumber();

            } catch (Exception e) {
                /* Since we are working with streams, we can return the failed
    item immediately.
                Lambda will immediately begin to retry processing from this
    failed item onwards. */
                batchItemFailures.add(new
    StreamsEventResponse.BatchItemFailure(curRecordSequenceNumber));
                return new StreamsEventResponse(batchItemFailures);
            }
        }

        return new StreamsEventResponse();
    }
}
```

JavaScript

SDK for JavaScript (v3)

Note

There's more on GitHub. Find the complete example and learn how to set up and run in the [Serverless examples](#) repository.

Reporting DynamoDB batch item failures with Lambda using JavaScript.

```
export const handler = async (event) => {
  const records = event.Records;
  let curRecordSequenceNumber = "";

  for (const record of records) {
    try {
      // Process your record
      curRecordSequenceNumber = record.dynamodb.SequenceNumber;
    } catch (e) {
      // Return failed record's sequence number
      return { batchItemFailures: [{ itemIdentifier:
curRecordSequenceNumber }] };
    }
  }

  return { batchItemFailures: [] };
};
```

Reporting DynamoDB batch item failures with Lambda using TypeScript.

```
import {
  DynamoDBBatchResponse,
  DynamoDBBatchItemFailure,
  DynamoDBStreamEvent,
} from "aws-lambda";

export const handler = async (
  event: DynamoDBStreamEvent
): Promise<DynamoDBBatchResponse> => {
```

```
const batchItemFailures: DynamoDBBatchItemFailure[] = [];  
let curRecordSequenceNumber;  
  
for (const record of event.Records) {  
    curRecordSequenceNumber = record.dynamodb?.SequenceNumber;  
  
    if (curRecordSequenceNumber) {  
        batchItemFailures.push({  
            itemIdentifier: curRecordSequenceNumber,  
        });  
    }  
}  
  
return { batchItemFailures: batchItemFailures };  
};
```

PHP

SDK for PHP

Note

There's more on GitHub. Find the complete example and learn how to set up and run in the [Serverless examples](#) repository.

Reporting DynamoDB batch item failures with Lambda using PHP.

```
<?php  
  
# using bref/bref and bref/logger for simplicity  
  
use Bref\Context\Context;  
use Bref\Event\DynamoDb\DynamoDbEvent;  
use Bref\Event\Handler as StdHandler;  
use Bref\Logger\StderrLogger;  
  
require __DIR__ . '/vendor/autoload.php';  
  
class Handler implements StdHandler  
{
```

```
private StderrLogger $logger;
public function __construct(StderrLogger $logger)
{
    $this->logger = $logger;
}

/**
 * @throws JsonException
 * @throws \Bref\Event\InvalidLambdaEvent
 */
public function handle(mixed $event, Context $context): array
{
    $dynamoDbEvent = new DynamoDbEvent($event);
    $this->logger->info("Processing records");

    $records = $dynamoDbEvent->getRecords();
    $failedRecords = [];
    foreach ($records as $record) {
        try {
            $data = $record->getData();
            $this->logger->info(json_encode($data));
            // TODO: Do interesting work based on the new data
        } catch (Exception $e) {
            $this->logger->error($e->getMessage());
            // failed processing the record
            $failedRecords[] = $record->getSequenceNumber();
        }
    }
    $totalRecords = count($records);
    $this->logger->info("Successfully processed $totalRecords records");

    // change format for the response
    $failures = array_map(
        fn(string $sequenceNumber) => ['itemIdentifier' => $sequenceNumber],
        $failedRecords
    );

    return [
        'batchItemFailures' => $failures
    ];
}

$logger = new StderrLogger();
```

```
return new Handler($logger);
```

Python

SDK for Python (Boto3)

Note

There's more on GitHub. Find the complete example and learn how to set up and run in the [Serverless examples](#) repository.

Reporting DynamoDB batch item failures with Lambda using Python.

```
# Copyright Amazon.com, Inc. or its affiliates. All Rights Reserved.
# SPDX-License-Identifier: Apache-2.0
def handler(event, context):
    records = event.get("Records")
    curRecordSequenceNumber = ""

    for record in records:
        try:
            # Process your record
            curRecordSequenceNumber = record["dynamodb"]["SequenceNumber"]
        except Exception as e:
            # Return failed record's sequence number
            return {"batchItemFailures":[{"itemIdentifier":
curRecordSequenceNumber}]}

    return {"batchItemFailures":[]}
```

Ruby

SDK for Ruby

Note

There's more on GitHub. Find the complete example and learn how to set up and run in the [Serverless examples](#) repository.

Reporting DynamoDB batch item failures with Lambda using Ruby.

```
def lambda_handler(event:, context:)
  records = event["Records"]
  cur_record_sequence_number = ""

  records.each do |record|
    begin
      # Process your record
      cur_record_sequence_number = record["dynamodb"]["SequenceNumber"]
      rescue StandardError => e
      # Return failed record's sequence number
      return {"batchItemFailures" => [{"itemIdentifier" =>
cur_record_sequence_number}]}
    end
  end

  {"batchItemFailures" => []}
end
```

Rust

SDK for Rust

Note

There's more on GitHub. Find the complete example and learn how to set up and run in the [Serverless examples](#) repository.

Reporting DynamoDB batch item failures with Lambda using Rust.

```

use aws_lambda_events::{
    event::dynamodb::{Event, EventRecord, StreamRecord},
    streams::{DynamoDbBatchItemFailure, DynamoDbEventResponse},
};
use lambda_runtime::{run, service_fn, Error, LambdaEvent};

/// Process the stream record
fn process_record(record: &EventRecord) -> Result<(), Error> {
    let stream_record: &StreamRecord = &record.change;

    // process your stream record here...
    tracing::info!("Data: {:?}", stream_record);

    Ok(())
}

/// Main Lambda handler here...
async fn function_handler(event: LambdaEvent<Event>) ->
Result<DynamoDbEventResponse, Error> {
    let mut response = DynamoDbEventResponse {
        batch_item_failures: vec![],
    };

    let records = &event.payload.records;

    if records.is_empty() {
        tracing::info!("No records found. Exiting.");
        return Ok(response);
    }

    for record in records {
        tracing::info!("EventId: {}", record.event_id);

        // Couldn't find a sequence number
        if record.change.sequence_number.is_none() {
            response.batch_item_failures.push(DynamoDbBatchItemFailure {
                item_identifer: Some("").to_string(),
            });
            return Ok(response);
        }

        // Process your record here...

```

```
        if process_record(record).is_err() {
            response.batch_item_failures.push(DynamoDbBatchItemFailure {
                item_identifier: record.change.sequence_number.clone(),
            });
            /* Since we are working with streams, we can return the failed item
            immediately.
            Lambda will immediately begin to retry processing from this failed
            item onwards. */
            return Ok(response);
        }
    }

    tracing::info!("Successfully processed {} record(s)", records.len());

    Ok(response)
}

#[tokio::main]
async fn main() -> Result<(), Error> {
    tracing_subscriber::fmt()
        .with_max_level(tracing::Level::INFO)
        // disable printing the name of the module in every log line.
        .with_target(false)
        // disabling time is handy because CloudWatch will add the ingestion
        time.
        .without_time()
        .init();

    run(service_fn(function_handler)).await
}
```

For a complete list of AWS SDK developer guides and code examples, see [Using Lambda with an AWS SDK](#). This topic also includes information about getting started and details about previous SDK versions.

Reporting batch item failures for Lambda functions with an Amazon SQS trigger

The following code examples show how to implement partial batch response for Lambda functions that receive events from an SQS queue. The function reports the batch item failures in the response, signaling to Lambda to retry those messages later.

.NET

AWS SDK for .NET

Note

There's more on GitHub. Find the complete example and learn how to set up and run in the [Serverless examples](#) repository.

Reporting SQS batch item failures with Lambda using .NET.

```
// Copyright Amazon.com, Inc. or its affiliates. All Rights Reserved.
// SPDX-License-Identifier: Apache-2.0
using Amazon.Lambda.Core;
using Amazon.Lambda.SQSEvents;

// Assembly attribute to enable the Lambda function's JSON input to be converted
// into a .NET class.
[assembly: LambdaSerializer(typeof(Amazon.Lambda.Serialization.SystemTextJson.DefaultLambdaJsonSerializer))]
namespace sqsSample;

public class Function
{
    public async Task<SQSBatchResponse> FunctionHandler(SQSEvent evnt,
        ILambdaContext context)
    {
        List<SQSBatchResponse.BatchItemFailure> batchItemFailures = new
        List<SQSBatchResponse.BatchItemFailure>();
        foreach(var message in evnt.Records)
        {
            try
            {
```

```
        //process your message
        await ProcessMessageAsync(message, context);
    }
    catch (System.Exception)
    {
        //Add failed message identifier to the batchItemFailures list
        batchItemFailures.Add(new
SQSBatchResponse.BatchItemFailure{ItemIdentifier=message.MessageId});
    }
}
return new SQSBatchResponse(batchItemFailures);
}

private async Task ProcessMessageAsync(SQSEvent.SQSMessage message,
ILambdaContext context)
{
    if (String.IsNullOrEmpty(message.Body))
    {
        throw new Exception("No Body in SQS Message.");
    }
    context.Logger.LogInformation($"Processed message {message.Body}");
    // TODO: Do interesting work based on the new message
    await Task.CompletedTask;
}
}
```

Go

SDK for Go V2

Note

There's more on GitHub. Find the complete example and learn how to set up and run in the [Serverless examples](#) repository.

Reporting SQS batch item failures with Lambda using Go.

```
// Copyright Amazon.com, Inc. or its affiliates. All Rights Reserved.
// SPDX-License-Identifier: Apache-2.0
package main
```

```
import (
    "context"
    "encoding/json"
    "fmt"
    "github.com/aws/aws-lambda-go/events"
    "github.com/aws/aws-lambda-go/lambda"
)

func handler(ctx context.Context, sqsEvent events.SQSEvent)
    (map[string]interface{}, error) {
    batchItemFailures := []map[string]interface{}{}

    for _, message := range sqsEvent.Records {

        if /* Your message processing condition here */ {
            batchItemFailures = append(batchItemFailures, map[string]interface{}{
                "itemIdentifier": message.MessageId})
        }
    }

    sqsBatchResponse := map[string]interface{}{
        "batchItemFailures": batchItemFailures,
    }
    return sqsBatchResponse, nil
}

func main() {
    lambda.Start(handler)
}
```

Java

SDK for Java 2.x

Note

There's more on GitHub. Find the complete example and learn how to set up and run in the [Serverless examples](#) repository.

Reporting SQS batch item failures with Lambda using Java.

```
// Copyright Amazon.com, Inc. or its affiliates. All Rights Reserved.
// SPDX-License-Identifier: Apache-2.0
import com.amazonaws.services.lambda.runtime.Context;
import com.amazonaws.services.lambda.runtime.RequestHandler;
import com.amazonaws.services.lambda.runtime.events.SQSEvent;
import com.amazonaws.services.lambda.runtime.events.SQSBatchResponse;

import java.util.ArrayList;
import java.util.List;

public class ProcessSQSMessageBatch implements RequestHandler<SQSEvent,
SQSBatchResponse> {
    @Override
    public SQSBatchResponse handleRequest(SQSEvent sqsEvent, Context context) {

        List<SQSBatchResponse.BatchItemFailure> batchItemFailures = new
ArrayList<SQSBatchResponse.BatchItemFailure>();
        String messageId = "";
        for (SQSEvent.SQSMessage message : sqsEvent.getRecords()) {
            try {
                //process your message
                messageId = message.getMessageId();
            } catch (Exception e) {
                //Add failed message identifier to the batchItemFailures list
                batchItemFailures.add(new
SQSBatchResponse.BatchItemFailure(messageId));
            }
        }
        return new SQSBatchResponse(batchItemFailures);
    }
}
```

JavaScript

SDK for JavaScript (v3)

Note

There's more on GitHub. Find the complete example and learn how to set up and run in the [Serverless examples](#) repository.

Reporting SQS batch item failures with Lambda using JavaScript.

```
// Node.js 20.x Lambda runtime, AWS SDK for Javascript V3
export const handler = async (event, context) => {
  const batchItemFailures = [];
  for (const record of event.Records) {
    try {
      await processMessageAsync(record, context);
    } catch (error) {
      batchItemFailures.push({ itemIdentifier: record.messageId });
    }
  }
  return { batchItemFailures };
};

async function processMessageAsync(record, context) {
  if (record.body && record.body.includes("error")) {
    throw new Error("There is an error in the SQS Message.");
  }
  console.log(`Processed message: ${record.body}`);
}
```

Reporting SQS batch item failures with Lambda using TypeScript.

```
// Copyright Amazon.com, Inc. or its affiliates. All Rights Reserved.
// SPDX-License-Identifier: Apache-2.0
import { SQSEvent, SQSBatchResponse, Context, SQSBatchItemFailure, SQSRecord }
  from 'aws-lambda';

export const handler = async (event: SQSEvent, context: Context):
  Promise<SQSBatchResponse> => {
  const batchItemFailures: SQSBatchItemFailure[] = [];

  for (const record of event.Records) {
    try {
      await processMessageAsync(record);
    } catch (error) {
      batchItemFailures.push({ itemIdentifier: record.messageId });
    }
  }

  return {batchItemFailures: batchItemFailures};
};
```

```
async function processMessageAsync(record: SQSRecord): Promise<void> {
    if (record.body && record.body.includes("error")) {
        throw new Error('There is an error in the SQS Message.');
```

```
    }
```

```
    console.log(`Processed message ${record.body}`);
```

```
}
```

PHP

SDK for PHP

Note

There's more on GitHub. Find the complete example and learn how to set up and run in the [Serverless examples](#) repository.

Reporting SQS batch item failures with Lambda using PHP.

```
// Copyright Amazon.com, Inc. or its affiliates. All Rights Reserved.
// SPDX-License-Identifier: Apache-2.0
<?php

use Bref\Context\Context;
use Bref\Event\Sqs\SqsEvent;
use Bref\Event\Sqs\SqsHandler;
use Bref\Logger\StderrLogger;

require __DIR__ . '/vendor/autoload.php';

class Handler extends SqsHandler
{
    private StderrLogger $logger;
    public function __construct(StderrLogger $logger)
    {
        $this->logger = $logger;
    }

    /**
     * @throws JsonException
```



```

    * @throws \Bref\Event\InvalidLambdaEvent
    */
    public function handleSqs(SqsEvent $event, Context $context): void
    {
        $this->logger->info("Processing SQS records");
        $records = $event->getRecords();

        foreach ($records as $record) {
            try {
                // Assuming the SQS message is in JSON format
                $message = json_decode($record->getBody(), true);
                $this->logger->info(json_encode($message));
                // TODO: Implement your custom processing logic here
            } catch (Exception $e) {
                $this->logger->error($e->getMessage());
                // failed processing the record
                $this->markAsFailed($record);
            }
        }
        $totalRecords = count($records);
        $this->logger->info("Successfully processed $totalRecords SQS records");
    }
}

$logger = new StderrLogger();
return new Handler($logger);

```

Python

SDK for Python (Boto3)

Note

There's more on GitHub. Find the complete example and learn how to set up and run in the [Serverless examples](#) repository.

Reporting SQS batch item failures with Lambda using Python.

```

# Copyright Amazon.com, Inc. or its affiliates. All Rights Reserved.
# SPDX-License-Identifier: Apache-2.0

```

```
def lambda_handler(event, context):
    if event:
        batch_item_failures = []
        sqs_batch_response = {}

        for record in event["Records"]:
            try:
                # process message
            except Exception as e:
                batch_item_failures.append({"itemIdentifier":
record['messageId']})

        sqs_batch_response["batchItemFailures"] = batch_item_failures
        return sqs_batch_response
```

Ruby

SDK for Ruby

Note

There's more on GitHub. Find the complete example and learn how to set up and run in the [Serverless examples](#) repository.

Reporting SQS batch item failures with Lambda using Ruby.

```
# Copyright Amazon.com, Inc. or its affiliates. All Rights Reserved.
# SPDX-License-Identifier: Apache-2.0
require 'json'

def lambda_handler(event:, context:)
    if event
        batch_item_failures = []
        sqs_batch_response = {}

        event["Records"].each do |record|
            begin
                # process message
            rescue StandardError => e
                batch_item_failures << {"itemIdentifier" => record['messageId']}
```

```

        end
    end

    sqs_batch_response["batchItemFailures"] = batch_item_failures
    return sqs_batch_response
end
end

```

Rust

SDK for Rust

Note

There's more on GitHub. Find the complete example and learn how to set up and run in the [Serverless examples](#) repository.

Reporting SQS batch item failures with Lambda using Rust.

```

// Copyright Amazon.com, Inc. or its affiliates. All Rights Reserved.
// SPDX-License-Identifier: Apache-2.0
use aws_lambda_events::{
    event::sqs::{SqsBatchResponse, SqsEvent},
    sqs::{BatchItemFailure, SqsMessage},
};
use lambda_runtime::{run, service_fn, Error, LambdaEvent};

async fn process_record(_: &SqsMessage) -> Result<(), Error> {
    Err(Error::from("Error processing message"))
}

async fn function_handler(event: LambdaEvent<SqsEvent>) ->
Result<SqsBatchResponse, Error> {
    let mut batch_item_failures = Vec::new();
    for record in event.payload.records {
        match process_record(&record).await {
            Ok(_) => (),
            Err(_) => batch_item_failures.push(BatchItemFailure {
                item_identifier: record.message_id.unwrap(),
            }),
        }
    }
}

```

```
    }  
  }  
  
  Ok(SqsBatchResponse {  
    batch_item_failures,  
  })  
}  
  
#[tokio::main]  
async fn main() -> Result<(), Error> {  
  run(service_fn(function_handler)).await  
}
```

For a complete list of AWS SDK developer guides and code examples, see [Using Lambda with an AWS SDK](#). This topic also includes information about getting started and details about previous SDK versions.

AWS community contributions for Lambda using AWS SDKs

AWS community contributions are examples that were created and are maintained by multiple teams across AWS. To provide feedback, use the mechanism provided in the linked repositories.

Examples

- [Build and test a serverless application](#)

Build and test a serverless application

The following code examples show how to build and test a serverless application using API Gateway with Lambda and DynamoDB

.NET

AWS SDK for .NET

Shows how to build and test a serverless application that consists of an API Gateway with Lambda and DynamoDB using the .NET SDK.

For complete source code and instructions on how to set up and run, see the full example on [GitHub](#).

Services used in this example

- API Gateway
- DynamoDB
- Lambda

Go

SDK for Go V2

Shows how to build and test a serverless application that consists of an API Gateway with Lambda and DynamoDB using the Go SDK.

For complete source code and instructions on how to set up and run, see the full example on [GitHub](#).

Services used in this example

- API Gateway
- DynamoDB
- Lambda

Java

SDK for Java 2.x

Shows how to build and test a serverless application that consists of an API Gateway with Lambda and DynamoDB using the Java SDK.

For complete source code and instructions on how to set up and run, see the full example on [GitHub](#).

Services used in this example

- API Gateway
- DynamoDB
- Lambda

Rust

SDK for Rust

Shows how to build and test a serverless application that consists of an API Gateway with Lambda and DynamoDB using the Rust SDK.

For complete source code and instructions on how to set up and run, see the full example on [GitHub](#).

Services used in this example

- API Gateway
- DynamoDB
- Lambda

For a complete list of AWS SDK developer guides and code examples, see [Using Lambda with an AWS SDK](#). This topic also includes information about getting started and details about previous SDK versions.

Lambda quotas

AWS Lambda is designed to scale rapidly to meet demand, allowing your functions to scale up to serve traffic in your application. Lambda is designed for short-lived compute tasks that do not retain or rely upon state between invocations. Code can run for up to 15 minutes in a single invocation and a single function can use up to 10,240 MB of memory.

It's important to understand the guardrails that are put in place to protect your account and the workloads of other customers. Service quotas exist in all AWS services and consist of hard limits, which you cannot change, and soft limits, which you can request increases for. By default, all new accounts are assigned a quota profile that allows exploration of AWS services.

To see the quotas that apply to your account, navigate to the [Service Quotas dashboard](#). Here, you can view your service quotas, request a quota increase, and view current utilization. From here, you can drill down to a specific AWS service, such as Lambda:



AWS Lambda is a compute service that runs your code in response to events and automatically manages the compute resources for you.

Service quotas [info](#) Request Increase at account level

View your applied quota values, default quota values, and request quota increases for quotas. [Learn more](#)

Search by quota name

Quota name	Applied account-level quota value	AWS default quota value	Utilization	Adjustability
<input checked="" type="radio"/> Asynchronous payload	256 kilobytes	256 kilobytes	Not available	Not adjustable
<input checked="" type="radio"/> Concurrency scaling rate	1,000	1,000	Not available	Not adjustable
<input type="radio"/> Concurrent executions	1,000	1,000	0	Account level
<input checked="" type="radio"/> Deployment package size (console editor)	3 megabytes	3 megabytes	Not available	Not adjustable
<input checked="" type="radio"/> Deployment package size (direct upload)	50 megabytes	50 megabytes	Not available	Not adjustable
<input checked="" type="radio"/> Deployment package size (unzipped)	250 megabytes	250 megabytes	Not available	Not adjustable
<input type="radio"/> Elastic network interfaces per VPC	Not available	500	Not available	Account level
<input checked="" type="radio"/> Environment variable size	4 kilobytes	4 kilobytes	Not available	Not adjustable
<input checked="" type="radio"/> File descriptors	1,024	1,024	Not available	Not adjustable
<input type="radio"/> Function and layer storage	75 gigabytes	75 gigabytes	Not available	Account level
<input checked="" type="radio"/> Function layers	5	5	Not available	Not adjustable
<input checked="" type="radio"/> Function resource-based policy	20 kilobytes	20 kilobytes	Not available	Not adjustable
<input checked="" type="radio"/> Function timeout	900	900	Not available	Not adjustable
<input checked="" type="radio"/> Processes and threads	1,024	1,024	Not available	Not adjustable
<input checked="" type="radio"/> Rate of control plane API requests (excludes invocation, GetFunction, and GetPolicy requests)	15	15	Not available	Not adjustable
<input checked="" type="radio"/> Rate of GetFunction API requests	100	100	Not available	Not adjustable
<input checked="" type="radio"/> Rate of GetPolicy API requests	15	15	Not available	Not adjustable
<input checked="" type="radio"/> Synchronous payload	6 megabytes	6 megabytes	Not available	Not adjustable
<input checked="" type="radio"/> Temporary storage	512 megabytes	512 megabytes	Not available	Not adjustable
<input checked="" type="radio"/> Test events (console editor)	10	10	Not available	Not adjustable

Important

New AWS accounts have reduced concurrency and memory quotas. AWS raises these quotas automatically based on your usage.

The following sections list default quotas and limits in Lambda by category.

Topics

- [Compute and storage](#)
- [Function configuration, deployment, and execution](#)
- [Lambda API requests](#)
- [Other services](#)

Compute and storage

Lambda sets quotas for the amount of compute and storage resources that you can use to run and store functions. Quotas for concurrent executions and storage apply per AWS Region. Elastic network interface (ENI) quotas apply per virtual private cloud (VPC), regardless of Region. The following quotas can be increased from their default values. For more information, see [Requesting a quota increase](#) in the *Service Quotas User Guide*.

Resource	Default quota	Can be increased up to
Concurrent executions	1,000	Tens of thousands
Storage for uploaded functions (.zip file archives) and layers. Each function version and layer version consumes storage. For best practices on managing your code storage, see Monitoring Lambda code storage in Serverless Land.	75 GB	Terabytes
Storage for functions defined as container images. These images are stored in Amazon ECR.	See Amazon ECR service quotas .	
Elastic network interfaces per virtual private cloud (VPC) <div style="border: 1px solid #0070C0; border-radius: 10px; padding: 10px; background-color: #E6F2FF;"> <p>Note</p> <p>This quota is shared with other services, such as Amazon Elastic File System (Amazon EFS). See Amazon VPC quotas.</p> </div>	500	Thousands

For details on concurrency and how Lambda scales your function concurrency in response to traffic, see [Understanding Lambda function scaling](#).

Function configuration, deployment, and execution

The following quotas apply to function configuration, deployment, and execution. Except as noted, they can't be changed.

Note

The Lambda documentation, log messages, and console use the abbreviation MB (rather than MiB) to refer to 1,024 KB.

Resource	Quota
Function memory allocation	128 MB to 10,240 MB, in 1-MB increments. Note: Lambda allocates CPU power in proportion to the amount of memory configured. You can increase or decrease the memory and CPU power allocated to your function using the Memory (MB) setting. At 1,769 MB, a function has the equivalent of one vCPU.
Function timeout	900 seconds (15 minutes)
Function environment variables	4 KB, for all environment variables associated with the function, in aggregate
Function resource-based policy	20 KB
Function layers	five layers

Resource	Quota
Function concurrency scaling limit	For each function, 1,000 execution environments every 10 seconds
Invocation payload (request and response)	<p>6 MB each for request and response (synchronous)</p> <p>20 MB for each streamed response (Synchronous. The payload size for streamed responses can be increased from default values. Contact Support to inquire further.)</p> <p>256 KB (asynchronous)</p> <p>1 MB for the total combined size of request line and header values</p>
Bandwidth for streamed responses	<p>Uncapped for the first 6 MB of your function's response</p> <p>For responses larger than 6 MB, 2MBps for the remainder of the response</p>
Deployment package (.zip file archive) size	<p>50 MB (zipped, when uploaded through the Lambda API or SDKs). Upload larger files with Amazon S3.</p> <p>50 MB (when uploaded through the Lambda console)</p> <p>250 MB The maximum size of the contents of a deployment package, including layers and custom runtimes. (unzipped)</p>
Container image settings size	16 KB

Resource	Quota
Container image code package size	10 GB (maximum uncompressed image size, including all layers)
Test events (console editor)	10
/tmp directory storage	Between 512 MB and 10,240 MB, in 1-MB increments
File descriptors	1,024
Execution processes/threads	1,024

Lambda API requests

The following quotas are associated with Lambda API requests.

Resource	Quota
Invocation requests per function per Region (synchronous)	Each instance of your execution environment can serve up to 10 requests per second. In other words, the total invocation limit is 10 times your concurrency limit. See Understanding Lambda function scaling .
Invocation requests per function per Region (asynchronous)	Each instance of your execution environment can serve an unlimited number of requests. In other words, the total invocation limit is based only on concurrency available to your function. See Understanding Lambda function scaling .
Invocation requests per function version or alias (requests per second)	10 x allocated provisioned concurrency

Resource	Quota
	<p>Note</p> <p>This quota applies only to functions that use provisioned concurrency.</p>
GetFunction API requests	100 requests per second. Cannot be increased.
GetPolicy API requests	15 requests per second. Cannot be increased.
Remainder of the control plane API requests (excludes invocation, GetFunction, and GetPolicy requests)	15 requests per second across all APIs (not 15 requests per second per API). Cannot be increased.

Other services

Quotas for other services, such as AWS Identity and Access Management (IAM), Amazon CloudFront (Lambda@Edge), and Amazon Virtual Private Cloud (Amazon VPC), can impact your Lambda functions. For more information, see [AWS service quotas](#) in the *Amazon Web Services General Reference*, and [Invoking Lambda with events from other AWS services](#).

Many applications involving Lambda use multiple AWS services. Because different services have different quotas for various features, it can be challenging to manage these quotas across your entire application. For example, API Gateway has a default throttle limit of 10,000 requests per second, whereas Lambda has a default concurrency limit of 1,000. Due to this mismatch, it's possible to have more incoming requests from API Gateway that Lambda can handle. You can resolve this by requesting a Lambda concurrency limit increase to match the expected level of traffic.

Load testing your application allows you to monitor the performance of your application end-to-end before deploying to production. During a load test, you can identify any quotas that may act as a limiting factor for the traffic levels you expect and take action accordingly.

Document history

The following table describes the important changes to the *AWS Lambda Developer Guide* since May 2018. For notification about updates to this documentation, subscribe to the [RSS feed](#).

Change	Description	Date
Node.js 22.x runtime	Lambda now supports Node.js 22 as a managed runtime and container base image (nodejs22.x).	November 22, 2024
SnapStart support for Python and .NET	Lambda SnapStart is now available for Python and .NET managed runtimes, beginning with python3.12 and dotnet8.	November 18, 2024
Python 3.13 runtime	Lambda now supports Python 3.13 as a managed runtime and container base image.	November 13, 2024
Customer managed encryption for .zip deployment packages	Lambda now supports AWS KMS customer managed key encryption for .zip deployment packages.	November 8, 2024
Support for SnapStart in new Regions	Lambda SnapStart is now available in the following Regions: Europe (Spain), Europe (Zurich), Asia Pacific (Melbourne), Asia Pacific (Hyderabad), and Middle East (UAE).	January 12, 2024
AWS managed policy updates	Service Quotas updated an existing AWS managed policy	January 5, 2024

(`AWSLambdaVPCLambdaAccessExecutionRole`).

[Python 3.12 runtime](#)

Lambda now supports Python 3.12 as a managed runtime and container base image. For more information, see [Python 3.12 runtime now available in AWS Lambda](#) on the AWS Compute Blog.

December 14, 2023

[Java 21 runtime](#)

Lambda now supports Java 21 as a managed runtime and container base image (`java21`).

November 16, 2023

[Node.js 20.x runtime](#)

Lambda now supports Node.js 20 as a managed runtime and container base image (`nodejs20.x`). For more information, see [Node.js 20.x runtime now available in AWS Lambda](#) on the AWS Compute Blog.

November 14, 2023

[provided.al2023 runtime](#)

Lambda now supports Amazon Linux 2023 as a managed runtime and container base image. For more information, see [Introducing the Amazon Linux 2023 runtime for AWS Lambda](#) on the AWS Compute Blog.

November 9, 2023

[IPv6 support for dual-stack subnets](#)

Lambda now supports outbound IPv6 traffic to dual-stack subnets. For more information, see [IPv6 support](#).

October 12, 2023

[Testing serverless functions and applications](#)

Learn about techniques to debug and automate testing serverless functions in the cloud. There is now a testing chapter and resources included in the Python and Typescript language sections. For details, see [Testing serverless functions and applications](#).

June 16, 2023

[Ruby 3.2 runtime](#)

Lambda now supports a new runtime for Ruby 3.2. For more information, see [Building Lambda functions with Ruby](#).

June 7, 2023

[Response streaming](#)

Lambda now supports streaming responses from functions. For more information, see [Configuring a Lambda function to stream responses](#).

April 6, 2023

[Asynchronous invocation metrics](#)

Lambda releases asynchronous invocation metrics. For more information, see [Asynchronous invocation metrics](#).

February 9, 2023

Runtime version controls	Lambda releases new runtime versions that include security updates, bug fixes, and new features. You can now control when your functions get updated to the new runtime versions. For more information, see Lambda runtime updates .	January 23, 2023
Lambda SnapStart	Use Lambda SnapStart to reduce startup time for Java functions without provisioning additional resources or implementing complex performance optimizations. For more information, see Improving startup performance with with Lambda SnapStart .	November 28, 2022
Node.js 18 runtime	Lambda now supports a new runtime for Node.js 18. Node.js 18 uses Amazon Linux 2. For details, see Building Lambda functions with Node.js .	November 18, 2022
lambda:SourceFunctionArn condition key	For an AWS resource, the <code>lambda:SourceFunctionArn</code> condition key filters access to the resource by the ARN of a Lambda function. For details, see Working with Lambda execution environment credentials .	July 1, 2022

Node.js 16 runtime	Lambda now supports a new runtime for Node.js 16. Node.js 16 uses Amazon Linux 2. For details, see Building Lambda functions with Node.js .	May 11, 2022
Lambda function URLs	Lambda now supports function URLs, which are dedicated HTTP(S) endpoints for Lambda functions. For details, see Lambda function URLs .	April 6, 2022
Shared test events in the AWS Lambda console	Lambda now supports sharing test events with other users in the same AWS account. For details, see Testing Lambda functions in the console .	March 16, 2022
PrincipalOrgId in resource-based policies	Lambda now supports granting permissions to an organization in AWS Organizations. For details, see Using resource-based policies for AWS Lambda .	March 11, 2022
.NET 6 runtime	Lambda now supports a new runtime for .NET 6. For details, see Lambda runtimes .	February 23, 2022
Event filtering for Kinesis, DynamoDB, and Amazon SQS event sources	Lambda now supports event filtering for Kinesis, DynamoDB, and Amazon SQS event sources. For details, see Lambda event filtering .	November 24, 2021

mTLS authentication for Amazon MSK and self-managed Apache Kafka event sources	Lambda now supports mTLS authentication for Amazon MSK and self-managed Apache Kafka event sources. For details, see Using Lambda with Amazon MSK .	November 19, 2021
Lambda on Graviton2	Lambda now supports Graviton2 for functions using arm64 architecture. For details, see Lambda instruction set architectures .	September 29, 2021
Python 3.9 runtime	Lambda now supports a new runtime for Python 3.9. For details, see Lambda runtimes .	August 16, 2021
New runtime versions for Node.js, Python, and Java	New runtime versions are available for Node.js, Python, and Java. For details, see Lambda runtimes .	July 21, 2021
Support for RabbitMQ as an event source on Lambda	Lambda now supports Amazon MQ for RabbitMQ as an event source. Amazon MQ is a managed message broker service for Apache ActiveMQ and RabbitMQ that makes it easy to set up and operate message brokers in the cloud. For details, see Using Lambda with Amazon MQ .	July 7, 2021

[SASL/PLAIN authentication for self-managed Kafka on Lambda](#)

SASL/PLAIN is now a supported authentication mechanism for self-managed Kafka event sources on Lambda. Customers already using SASL/PLAIN on their self-managed Kafka cluster can now easily use Lambda to build consumer applications without having to modify the way they authenticate. For details, see [Using Lambda with self-managed Apache Kafka](#).

June 29, 2021

[Lambda Extensions API](#)

General availability for Lambda extensions. Use extensions to augment your Lambda functions. You can use extensions provided by Lambda Partners, or you can create your own Lambda extensions. For details, see [Lambda Extensions API](#).

May 24, 2021

[New Lambda console experience](#)

The Lambda console has been redesigned to improve performance and consistency.

March 2, 2021

[Node.js 14 runtime](#)

Lambda now supports a new runtime for Node.js 14. Node.js 14 uses Amazon Linux 2. For details, see [Building Lambda functions with Node.js](#).

January 27, 2021

[Lambda container images](#)

Lambda now supports functions defined as container images. You can combine the flexibility of container tooling with the agility and operational simplicity of Lambda to build applications. For details, see [Using container images with Lambda](#).

December 1, 2020

[Code signing for Lambda functions](#)

Lambda now supports code signing. Administrators can configure Lambda functions to accept only signed code on deployment. Lambda checks the signatures to ensure that the code is not altered or tampered. Additionally, Lambda ensures that the code is signed by trusted developers before accepting the deployment. For details, see [Configuring code signing for Lambda](#).

November 23, 2020

[Preview: Lambda Runtime Logs API](#)

Lambda now supports the Runtime Logs API. Lambda extensions can use the Logs API to subscribe to log streams in the execution environment. For details, see [Lambda Runtime Logs API](#).

November 12, 2020

[New event source to for Amazon MQ](#)

Lambda now supports Amazon MQ as an event source. Use a Lambda function to process records from your Amazon MQ message broker. For details, see [Using Lambda with Amazon MQ](#).

November 5, 2020

[Preview: Lambda Extensions API](#)

Use Lambda extensions to augment your Lambda functions. You can use extensions provided by Lambda Partners, or you can create your own Lambda extensions. For details, see [Lambda Extensions API](#).

October 8, 2020

[Support for Java 8 and custom runtimes on AL2](#)

Lambda now supports Java 8 and custom runtimes on Amazon Linux 2. For details, see [Lambda runtimes](#).

August 12, 2020

[New event source for Amazon Managed Streaming for Apache Kafka](#)

Lambda now supports Amazon MSK as an event source. Use a Lambda function with Amazon MSK to process records in a Kafka topic. For details, see [Using Lambda with Amazon MSK](#).

August 11, 2020

[IAM condition keys for Amazon VPC settings](#)

You can now use Lambda-specific condition keys for VPC settings. For example, you can require that all functions in your organization are connected to a VPC. You can also specify the subnets and security groups that the function's users can and can't use. For details, see [Configuring VPC for IAM functions](#).

August 10, 2020

[Concurrency settings for Kinesis HTTP/2 stream consumers](#)

You can now use the following concurrency settings for Kinesis consumers with enhanced fan-out (HTTP/2 streams): `ParallelizationFactor`, `MaximumRetryAttempts`, `MaximumRecordAgeInSeconds`, `DestinationConfig`, and `BisectBatchOnFunctionError`. For details, see [Using AWS Lambda with Amazon Kinesis](#).

July 7, 2020

[Batch window for Kinesis HTTP/2 stream consumers](#)

You can now configure a batch window (`MaximumBatchingWindowInSeconds`) for HTTP/2 streams. Lambda reads records from the stream until it has gathered a full batch, or until the batch window expires. For details, see [Using AWS Lambda with Amazon Kinesis](#).

June 18, 2020

[Support for Amazon EFS file systems](#)

You can now connect an Amazon EFS file system to your Lambda functions for shared network file access. For details, see [Configuring file system access for Lambda functions](#).

June 16, 2020

[AWS CDK sample applications in the Lambda console](#)

The Lambda console now includes sample applications that use the AWS Cloud Development Kit (AWS CDK) for TypeScript. The AWS CDK is a framework that enables you to define your application resources in TypeScript, Python, Java, or .NET.

June 1, 2020

[Support for .NET Core 3.1.0 runtime in AWS Lambda](#)

AWS Lambda now supports the .NET Core 3.1.0 runtime. For details, see [.NET Core CLI](#).

March 31, 2020

[Support for API Gateway HTTP APIs](#)

Updated and expanded documentation for using Lambda with API Gateway, including support for HTTP APIs. Added a sample application that creates an API and function with AWS CloudFormation. For details, see [Using Lambda with Amazon API Gateway](#).

March 23, 2020

[Ruby 2.7](#)

A new runtime is available for Ruby 2.7, `ruby2.7`, which is the first Ruby runtime to use Amazon Linux 2. For details, see [Building Lambda functions with Ruby](#).

February 19, 2020

[Concurrency metrics](#)

Lambda now reports the `ConcurrentExecutions` metric for all functions, aliases, and versions. You can view a graph for this metric on the monitoring page for your function. Previously, `ConcurrentExecutions` was only reported at the account level and for functions that use reserved concurrency. For details, see [AWS Lambda function metrics](#).

February 18, 2020

[Update to function states](#)

January 24, 2020

Function states are now enforced for all functions by default. When you connect a function to a VPC, Lambda creates shared elastic network interfaces. This enables your function to scale up without creating additional network interfaces. During this time, you can't perform additional operations on the function, including updating its configuration and publishing versions. In some cases, invocation is also impacted. Details about a function's current state are available from the Lambda API.

This update is being released in phases. For details, see [Updated Lambda states lifecycle for VPC networking](#) on the AWS Compute Blog. For more information about states, see [AWS Lambda function states](#).

[Updates to function configuration API output](#)

Added reason codes to [StateReasonCode](#) (InvalidSubnet, InvalidSecurityGroup) and LastUpdateStatusReasonCode (SubnetOutOfIPAddresses, InvalidSubnet, InvalidSecurityGroup) for functions that connect to a VPC. For more information about states, see [AWS Lambda function states](#).

January 20, 2020

[Provisioned concurrency](#)

You can now allocate provisioned concurrency for a function version or alias. Provisioned concurrency enables a function to scale without fluctuations in latency. For details, see [Managing concurrency for a Lambda function](#).

December 3, 2019

[Create a database proxy](#)

You can now use the Lambda console to create a database proxy for a Lambda function. A database proxy enables a function to reach high concurrency levels without exhausting database connections. For details, see [Configuring database access for a Lambda function](#).

December 3, 2019

[Percentiles support for the duration metric](#)

You can now filter the duration metric based on percentiles. For details, see [AWS Lambda metrics](#).

November 26, 2019

[Increased concurrency for stream event sources](#)

A new option for [DynamoDB stream](#) and [Kinesis stream](#) event source mappings enables you to process more than one batch at a time from each shard. When you increase the number of concurrent batches per shard, your function's concurrency can be up to 10 times the number of shards in your stream. For details, see [Lambda event source mapping](#).

November 25, 2019

[Function states](#)

When you create or update a function, it enters a pending state while Lambda provisions resources to support it. If you connect your function to a VPC, Lambda can create a shared elastic network interface right away, instead of creating network interfaces when your function is invoked. This results in better performance for VPC-connected functions, but might require an update to your automation. For details, see [AWS Lambda function states](#).

November 25, 2019

[Error handling options for asynchronous invocation](#)

New configuration options are available for asynchronous invocation. You can configure Lambda to limit retries and set a maximum event age. For details, see [Configuring error handling for asynchronous invocation](#).

November 25, 2019

[Error handling for stream event sources](#)

New configuration options are available for event source mappings that read from streams. You can configure [DynamoDB stream](#) and [Kinesis stream](#) event source mappings to limit retries and set a maximum record age. When errors occur, you can configure the event source mapping to split batches before retrying, and to send invocation records for failed batches to a queue or topic. For details, see [Lambda event source mapping](#).

November 25, 2019

[Destinations for asynchronous invocation](#)

You can now configure Lambda to send records of asynchronous invocations to another service. Invocation records contain details about the event, context, and function response. You can send invocation records to an SQS queue, SNS topic, Lambda function, or EventBridge event bus. For details, see [Configuring destinations for asynchronous invocation](#).

November 25, 2019

[New runtimes for Node.js, Python, and Java](#)

New runtimes are available for Node.js 12, Python 3.8, and Java 11. For details, see [Lambda runtimes](#).

November 18, 2019

[FIFO queue support for Amazon SQS event sources](#)

You can now create an event source mapping that reads from a first-in, first-out (FIFO) queue. Previously, only standard queues were supported. For details, see [Using Lambda with Amazon SQS](#).

November 18, 2019

[Create applications in the Lambda console](#)

Application creation in the Lambda console is now generally available. For instructions, see [Managing applications in the Lambda console](#).

October 31, 2019

[Create applications in the Lambda console \(beta\)](#)

You can now create a Lambda application with an integrated continuous delivery pipeline in the Lambda console. The console provides sample applications that you can use as a starting point for your own project. Choose between AWS CodeCommit and GitHub for source control. Each time you push changes to your repository, the included pipeline builds and deploys them automatically. For instructions, see [Managing applications in the Lambda console](#).

October 3, 2019

[Performance improvements for VPC-connected functions](#)

Lambda now uses a new type of elastic network interface that is shared by all functions in a virtual private cloud (VPC) subnet. When you connect a function to a VPC, Lambda creates a network interface for each combination of security group and subnet that you choose. When the shared network interfaces are available, the function no longer needs to create additional network interfaces as it scales up. This dramatically improves startup times. For details, see [Configuring a Lambda function to access resources in a VPC](#).

September 3, 2019

[Stream batch settings](#)

You can now configure a batch window for [Amazon DynamoDB](#) and [Amazon Kinesis](#) event source mappings. Configure a batch window of up to five minutes to buffer incoming records until a full batch is available. This reduces the number of times that your function is invoked when the stream is less active.

August 29, 2019

[CloudWatch Logs Insights integration](#)

The monitoring page in the Lambda console now includes reports from Amazon CloudWatch Logs Insights.

June 18, 2019

[Amazon Linux 2018.03](#)

The Lambda execution environment is being updated to use Amazon Linux 2018.03. For details, see [Execution environment](#).

May 21, 2019

[Node.js 10](#)

A new runtime is available for Node.js 10, nodejs10.x. This runtime uses Node.js 10.15 and will be updated with the latest point release of Node.js 10 periodically. Node.js 10 is also the first runtime to use Amazon Linux 2. For details, see [Building Lambda functions with Node.js](#).

May 13, 2019

[GetLayerVersionByArn API](#)

Use the [GetLayerVersionByArn](#) API to download layer version information with the version ARN as input. Compared to [GetLayerVersion](#), [GetLayerVersionByArn](#) lets you use the ARN directly instead of parsing it to get the layer name and version number.

April 25, 2019

[Ruby](#)

AWS Lambda now supports Ruby 2.5 with a new runtime. For details, see [Building Lambda functions with Ruby](#).

November 29, 2018

[Layers](#)

With Lambda layers, you can package and deploy libraries , custom runtimes, and other dependencies separately from your function code. Share your layers with your other accounts or the whole world. For details, see [Lambda layers](#).

November 29, 2018

[Custom runtimes](#)

Build a custom runtime to run Lambda functions in your favorite programming language. For details, see [Custom Lambda runtimes](#).

November 29, 2018

[Application Load Balancer triggers](#)

Elastic Load Balancing now supports Lambda functions as a target for Application Load Balancers. For details, see [Using Lambda with applications on load balancers](#).

November 29, 2018

[Use Kinesis HTTP/2 stream consumers as a trigger](#)

You can use Kinesis HTTP/2 data stream consumers to send events to AWS Lambda. Stream consumers have dedicated read throughput from each shard in your data stream and use HTTP/2 to minimize latency. For details, see [Using Lambda with Kinesis](#).

November 19, 2018

Python 3.7	AWS Lambda now supports Python 3.7 with a new runtime. For more information, see Building Lambda functions with Python .	November 19, 2018
Payload limit increase for asynchronous function invocation	The maximum payload size for asynchronous invocations increased from 128 KB to 256 KB, which matches the maximum message size from an Amazon SNS trigger. For details, see Lambda quotas .	November 16, 2018
AWS GovCloud (US-East) Region	AWS Lambda is now available in the AWS GovCloud (US-East) Region.	November 12, 2018
Moved AWS SAM topics to a separate Developer Guide	A number of topics were focused on building serverless applications using the AWS Serverless Application Model (AWS SAM). These topics have been moved to AWS Serverless Application Model developer guide .	October 25, 2018

[View Lambda applications in the console](#)

You can view the status of your Lambda applications on the [Applications](#) page in the Lambda console. This page shows the status of the AWS CloudFormation stack. It includes links to pages where you can view more information about the resources in the stack. You can also view aggregate metrics for the application and create custom monitoring dashboards.

October 11, 2018

[Function execution timeout limit](#)

To allow for long-running functions, the maximum configurable execution timeout increased from 5 minutes to 15 minutes. For details, see [Lambda limits](#).

October 10, 2018

[Support for PowerShell Core language in AWS Lambda](#)

AWS Lambda now supports the PowerShell Core language. For more information, see [Programming model for authoring Lambda functions in PowerShell](#).

September 11, 2018

[Support for .NET Core 2.1.0 runtime in AWS Lambda](#)

AWS Lambda now supports the .NET Core 2.1.0 runtime. For more information, see [.NET Core CLI](#).

July 9, 2018

[Updates now available over RSS](#)

You can now subscribe to an RSS feed to follow releases for this guide.

July 5, 2018

[Support for Amazon SQS as event source](#)

AWS Lambda now supports Amazon Simple Queue Service (Amazon SQS) as an event source. For more information, see [Invoking Lambda functions](#).

June 28, 2018

[China \(Ningxia\) Region](#)

AWS Lambda is now available in the China (Ningxia) Region. For more information about Lambda Regions and endpoints, see [Regions and endpoints](#) in the *AWS General Reference*.

June 28, 2018

Earlier updates

The following table describes the important changes in each release of the *AWS Lambda Developer Guide* before June 2018.

Change	Description	Date
Runtime support for Node.js runtime 8.10	AWS Lambda now supports Node.js runtime version 8.10. For more information, see Building Lambda functions with Node.js .	April 2, 2018
Function and alias revision IDs	AWS Lambda now supports revision IDs on your function versions and aliases. You can use these IDs to track and apply conditional updates when you are updating your function version or alias resources.	January 25, 2018
Runtime support for Go and .NET 2.0	AWS Lambda has added runtime support for Go and .NET 2.0. For more information, see Building Lambda functions with Go and Building Lambda functions with C# .	January 15, 2018
Console Redesign	AWS Lambda has introduced a new Lambda console to simplify your experience and added a Cloud9 Code Editor	November 30, 2017

Change	Description	Date
	to enhance your ability debug and revise your function code.	
Setting Concurrency Limits on Individual Functions	AWS Lambda now supports setting concurrency limits on individual functions. For more information, see Configuring reserved concurrency for a function .	November 30, 2017
Shifting Traffic with Aliases	AWS Lambda now supports shifting traffic with aliases. For more information, see Create a rolling deployment with weighted aliases .	November 28, 2017
Gradual Code Deployment	AWS Lambda now supports safely deploying new versions of your Lambda function by leveraging Code Deploy. For more information, see Gradual code deployment .	November 28, 2017
China (Beijing) Region	AWS Lambda is now available in the China (Beijing) Region. For more information about Lambda regions and endpoints, see Regions and endpoints in the <i>AWS General Reference</i> .	November 9, 2017
Introducing SAM Local	AWS Lambda introduces SAM Local (now known as SAM CLI), a AWS CLI tool that provides an environment for you to develop, test, and analyze your serverless applications locally before uploading them to the Lambda runtime. For more information, see Testing and debugging serverless applications .	August 11, 2017
Canada (Central) Region	AWS Lambda is now available in the Canada (Central) Region. For more information about Lambda regions and endpoints, see Regions and endpoints in the <i>AWS General Reference</i> .	June 22, 2017
South America (São Paulo) Region	AWS Lambda is now available in the South America (São Paulo) Region. For more information about Lambda regions and endpoints, see Regions and endpoints in the <i>AWS General Reference</i> .	June 6, 2017

Change	Description	Date
AWS Lambda support for AWS X-Ray.	Lambda introduces support for X-Ray, which allows you to detect, analyze, and optimize performance issues with your Lambda applications. For more information, see Visualize Lambda function invocations using AWS X-Ray .	April 19, 2017
Asia Pacific (Mumbai) Region	AWS Lambda is now available in the Asia Pacific (Mumbai) Region. For more information about Lambda regions and endpoints, see Regions and endpoints in the <i>AWS General Reference</i> .	March 28, 2017
AWS Lambda now supports Node.js runtime v6.10	AWS Lambda added support for Node.js runtime v6.10. For more information, see Building Lambda functions with Node.js .	March 22, 2017
Europe (London) Region	AWS Lambda is now available in the Europe (London) Region. For more information about Lambda regions and endpoints, see Regions and endpoints in the <i>AWS General Reference</i> .	February 1, 2017
AWS Lambda support for the .NET runtime, Lambda@Edge (Preview), Dead Letter Queues and automated deployment of serverless applications.	AWS Lambda added support for C#. For more information, see Building Lambda functions with C# . Lambda@Edge allows you to run Lambda functions at the AWS Edge locations in response to CloudFront events. For more information, see Customize at the edge with Lambda@Edge .	December 3, 2016
AWS Lambda adds Amazon Lex as a supported event source.	Using Lambda and Amazon Lex, you can quickly build chat bots for various services like Slack and Facebook.	November 30, 2016

Change	Description	Date
US West (N. California) Region	AWS Lambda is now available in the US West (N. California) Region. For more information about Lambda regions and endpoints, see Regions and endpoints in the <i>AWS General Reference</i> .	November 21, 2016
Introduced the AWS SAM for creating and deploying Lambda-based applications and using environment variables for Lambda function configuration settings.	<p>AWS SAM: You can now use the AWS SAM to define the syntax for expressing resources within a serverless application. In order to deploy your application, simply specify the resources you need as part of your application, along with their associated permissions policies in a AWS CloudFormation template file (written in either JSON or YAML), package your deployment artifacts, and deploy the template.</p> <p>Environment variables: You can use environment variables to specify configuration settings for your Lambda function outside of your function code. For more information, see Create Lambda environment variables.</p>	November 18, 2016
Asia Pacific (Seoul) Region	AWS Lambda is now available in the Asia Pacific (Seoul) Region. For more information about Lambda regions and endpoints, see Regions and endpoints in the <i>AWS General Reference</i> .	August 29, 2016
Asia Pacific (Sydney) Region	Lambda is now available in the Asia Pacific (Sydney) Region. For more information about Lambda regions and endpoints, see Regions and endpoints in the <i>AWS General Reference</i> .	June 23, 2016
Updates to the Lambda console	The Lambda console has been updated to simplify the role-creation process.	June 23, 2016
AWS Lambda now supports Node.js runtime v4.3	AWS Lambda added support for Node.js runtime v4.3. For more information, see Building Lambda functions with Node.js .	April 07, 2016

Change	Description	Date
Europe (Frankfurt) region	Lambda is now available in the Europe (Frankfurt) region. For more information about Lambda regions and endpoints, see Regions and endpoints in the <i>AWS General Reference</i> .	March 14, 2016
VPC support	You can now configure a Lambda function to access resources in your VPC. For more information, see Giving Lambda functions access to resources in an Amazon VPC .	February 11, 2016
Lambda runtime has been updated.	The execution environment has been updated.	November 4, 2015
Versioning support, Python for developing code for Lambda functions, scheduled events, and increase in execution time	<p>You can now develop your Lambda function code using Python. For more information, see Building Lambda functions with Python.</p> <p>Versioning: You can maintain one or more versions of your Lambda function. Versioning allows you to control which Lambda function version is executed in different environments (for example, development, testing, or production). For more information, see Manage Lambda function versions.</p> <p>Scheduled events: You can also set up Lambda to invoke your code on a regular, scheduled basis using the Lambda console. You can specify a fixed rate (number of hours, days, or weeks) or you can specify a cron expression. For more information, see Invoke a Lambda function on a schedule.</p> <p>Increase in execution time: You can now set up your Lambda functions to run for up to five minutes allowing longer running functions such as large volume data ingestion and processing jobs.</p>	October 08, 2015

Change	Description	Date
Support for DynamoDB Streams	DynamoDB Streams is now generally available and you can use it in all the regions where DynamoDB is available . You can enable DynamoDB Streams for your table and use a Lambda function as a trigger for the table. Triggers are custom actions you take in response to updates made to the DynamoDB table. For an example walkthrough, see Tutorial: Using AWS Lambda with Amazon DynamoDB streams .	July 14, 2015
Lambda now supports invoking Lambda functions with REST-compatible clients.	Until now, to invoke your Lambda function from your web, mobile, or IoT application you needed the AWS SDKs (for example, AWS SDK for Java, AWS SDK for Android, or AWS SDK for iOS). Now, Lambda supports invoking a Lambda function with REST-compatible clients through a customized API that you can create using Amazon API Gateway. You can send requests to your Lambda function endpoint URL. You can configure security on the endpoint to allow open access, leverage AWS Identity and Access Management (IAM) to authorize access, or use API keys to meter access to your Lambda functions by others. For an example Getting Started exercise, see Invoking a Lambda function using an Amazon API Gateway endpoint .	July 09, 2015
The Lambda console now provides blueprints to easily create Lambda functions and test them.	Lambda console provides a set of <i>blueprints</i> . Each blueprint provides a sample event source configuration and sample code for your Lambda function that you can use to easily create Lambda-based applications. All of the Lambda Getting Started exercises now use the blueprints.	July 09, 2015
Lambda now supports Java to author your Lambda functions.	You can now author Lambda code in Java. For more information, see Building Lambda functions with Java .	June 15, 2015

Change	Description	Date
Lambda now supports specifying an Amazon S3 object as the function .zip when creating or updating a Lambda function.	You can upload a Lambda function deployment package (.zip file) to an Amazon S3 bucket in the same region where you want to create a Lambda function. Then, you can specify the bucket name and object key name when you create or update a Lambda function.	May 28, 2015
Lambda now generally available with added support for mobile backends	Lambda is now generally available for production use. The release also introduces new features that make it easier to build mobile, tablet, and Internet of Things (IoT) backends using Lambda that scale automatically without provisioning or managing infrastructure. Lambda now supports both real-time (synchronous) and asynchronous events. Additional features include easier event source configuration and management. The permission model and the programming model have been simplified by the introduction of resource policies for your Lambda functions.	April 9, 2015
Preview release	Preview release of the <i>AWS Lambda Developer Guide</i> .	November 13, 2014