

AeroSafety WORLD

PARTIAL-PANEL PUZZLE

MALFUNCTION HOBBLER A319

SMS ON WHEELS

A dynamic model

REPLACING HALON

What can do the job?

POOR TIME TO DOZE

Research sought on sleeping

ENGINE FIRE ON TAKEOFF

Bad starting procedure blamed



Enhancing Safety by Delivering Superior Training and Support in the Areas That Matter Most

Quality • Value • Service • Technology

- ✓ Dedicated to Enhancing Safety Since 1951
- ✓ Programs Tailored to Customer Needs
- ✓ Online Training Program Management

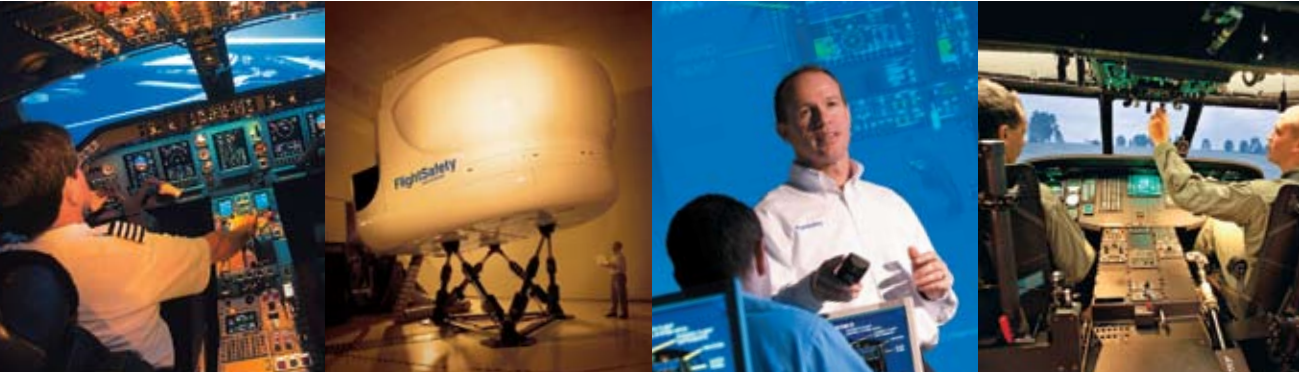

- ✓ Outstanding Customer Service
- ✓ Exceptional Overall Value
- ✓ eLearning Convenience
- ✓ Training to Proficiency

C H E C K O U T T H E F L I G H T S A F E T Y

Advantage

When you choose FlightSafety International, you leverage the unmatched resources of a world leader in aviation training and training equipment. More courses, more instructors, more top-level fully qualified simulators, more training locations. We're the authorized trainer for the majority of aircraft manufacturers, a world-leading supplier of proven advanced technology training devices and a major provider of mission-critical military training programs.

Business. We deliver training that meets or exceeds regulatory requirements – online, on location and at convenient Learning Centers near your aircraft manufacturer or a major service center. We tailor training to meet your specific needs and we train to proficiency for virtually every business aircraft in the air today.

Commercial. FlightSafety provides professional pilot and technician training for a broad range

of commercial aircraft, as well as training for flight attendants and dispatchers. We provide excellent customer service and online training management through myFlightSafety. It all adds up to exceptional value.

Military. Military aircrews that operate a wide variety of fixed-wing and rotor-wing aircraft benefit from FlightSafety's comprehensive, highly cost-effective training media, courseware, sophisticated training devices and innovative distance learning. We have the resources and experience to meet your mission requirements.

Simulation. FlightSafety designs, manufactures and supports the world's most sophisticated simulators, training devices and visual systems, with the most advanced features. We pioneered simulator electric motion and control loading, and we build full flight simulators for all types of aircraft, including rotorcraft.

- ✓ Training for the Vast Majority of Business and Regional Aircraft
- ✓ Worldwide Network of 40 Learning Centers
- ✓ Professional Training for More Than 140 Aircraft Models
- ✓ Serving 85% of Fortune 100 Companies*
- ✓ 1,800 Highly Qualified Instructors
- ✓ Serving All Branches of the U.S. Military
- ✓ 125 Military Fixed and Rotor-Wing Aircraft Simulators in Service
- ✓ Operations at 29 U.S. Military Bases
- ✓ 60 Aircraft Types Simulated in the Past Five Years Alone
- ✓ 99.6% Simulator In-Service Availability
- ✓ 24/7 Worldwide Simulator Support

For information, contact Scott Fera, Vice President Marketing • 718.565.4774
sales@flightsafety.com • flightsafety.com • A Berkshire Hathaway company

FlightSafety
international

*Of those operating business aircraft.

A NEW Beginning

I was privileged to hear Raymond Benjamin, the new secretary general for the International Civil Aviation Organization (ICAO), give his first public address. For those who know the international aviation system well, the speech signaled an important change in direction. It is a change that focuses on collaboration between nations and industry, and will address transparency and the management of risk. ICAO was not built to be swift, but with this leadership it can be relevant.

One of the most interesting parts of the speech was his proclamation that ICAO will become directly involved with sharing safety information. Secretary General Benjamin said, "The third very promising area for improving aviation safety is the sharing of safety-related information, a concept the aviation community has been steadily moving toward. This is perhaps the area I am most excited about. We have the ability now to utilize a huge volume of data to provide information, which will assist the global community in determining *risk*. Safety *risk*."

There are some pretty big points covered by that statement. For one, ICAO is truly embracing the notion of managing risk, no longer just talking about safety management systems but actually participating. That is a courageous step for a United Nations organization. Imagine going into a meeting of international politicians and telling them that some of them have a far greater risk of a plane crash than others. That is a tough thing to do, but ICAO is stepping forward to do it.

It is also interesting to see where ICAO is going regarding the use of safety information. For much of the organization's history, nations' noncompliance with its standards was disclosed voluntarily by

states in the form of a statement of "differences." Next, ICAO began auditing states, but those data initially were kept secret. And while those audits eventually became more transparent, the information provided still was insufficient to manage risk.

Now, ICAO is looking at pulling together data from both regulators and operators to get a more comprehensive picture of where the safety risk really is. This is a big deal. ICAO is positioned to do this in a way that no one else can. As a U.N. organization, ICAO has the legal ability to protect the information given to it. National laws do not apply. If ICAO's member states decide that it should be the repository of safety information, operators and regulators can send that information without fear of disclosure or prosecution. If some of these data were integrated in a sensible way, it could give us early insights about safety issues as they emerge around the world, alerting us when regions start losing ground.

There are countless details to be settled, but what is important is the new direction that ICAO is taking, the new role it is embracing. It is a role the organization ultimately may be well suited for, a role that could make it an active participant in the global safety system. I encourage all of you to give ICAO's leaders your support and give their ideas a chance. This could be the start of something big.



*William R. Voss
President and CEO
Flight Safety Foundation*



contents

September 2009 Vol 4 Issue 9



features

- 12 **CabinSafety** | **Accessible Sky**
- 16 **CoverStory** | **Partial-Panel Puzzle**
- 22 **InSight** | **Going Solo**
- 24 **HumanFactors** | **Asleep at the Wheel**
- 29 **ThreatAnalysis** | **Halon Pressure**
- 34 **MaintenanceMatters** | **Start-Up Problems**
- 40 **SafetyCulture** | **SMS on Wheels**
- 45 **CabinSafety** | **Old World Habits**



departments

- 1 **President'sMessage** | **A New Beginning**
- 5 **EditorialPage** | **Cheap and Safe**
- 7 **SafetyCalendar** | **Industry Events**
- 9 **InBrief** | **Safety News**

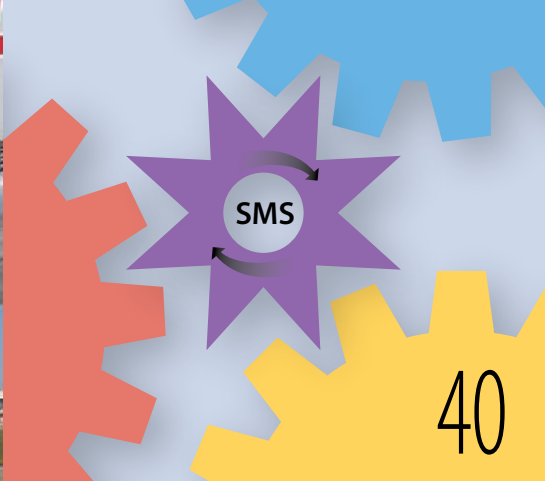

- 48 **DataLink** | **Fire Away**
- 52 **InfoScan** | **Flight Blight**
- 56 **OnRecord** | **Running on Fumes**

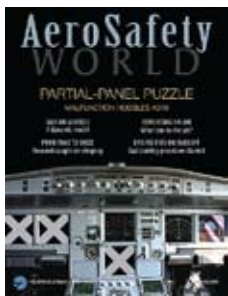

About the Cover
Malfunction knocked out A319's displays and radios.
© Justin Idle/Jetphotos.net

We Encourage Reprints (For permissions, go to <www.flightsafety.org/aerosafety-world-magazine>)

Share Your Knowledge

If you have an article proposal, manuscript or technical paper that you believe would make a useful contribution to the ongoing dialogue about aviation safety, we will be glad to consider it. Send it to Director of Publications J.A. Donoghue, 601 Madison St., Suite 300, Alexandria, VA 22314-1756 USA or donoghue@flightsafety.org. The publications staff reserves the right to edit all submissions for publication. Copyright must be transferred to the Foundation for a contribution to be published, and payment is made to the author upon publication.

Sales Contacts

Europe, Central USA, Latin America
Joan Daly, joan@dalyllc.com, tel. +1.703.983.5907

Northeast USA and Canada
Tony Calamaro, tcalamaro@comcast.net, tel. +1.610.449.3490

Asia Pacific, Western USA
Pat Walker, walkercom1@aol.com, tel. +1.415.387.7593

Regional Advertising Manager
Arlene Braithwaite, arlenetbg@comcast.net, tel. +1.410.772.0820

Subscriptions: Subscribe to *AeroSafety World* and become an individual member of Flight Safety Foundation. One year subscription for 12 issues includes postage and handling — US\$350. Special Introductory Rate — \$310. Single issues are available for \$30 for members, \$50 for nonmembers. For more information, please contact the membership department, Flight Safety Foundation, 601 Madison St., Suite 300, Alexandria, VA 22314-1756 USA, +1 703.739.6700 or membership@flightsafety.org.

AeroSafety World © Copyright 2009 by Flight Safety Foundation Inc. All rights reserved. ISSN 1934-4015 (print)/ ISSN 1937-0830 (digital). Published 12 times a year. Suggestions and opinions expressed in *AeroSafety World* are not necessarily endorsed by Flight Safety Foundation. Nothing in these pages is intended to supersede operators' or manufacturers' policies, practices or requirements, or to supersede government regulations.

AeroSafetyWORLD

telephone: +1 703.739.6700

William R. Voss, publisher,
FSF president and CEO
voss@flightsafety.org

J.A. Donoghue, editor-in-chief,
FSF director of publications
donoghue@flightsafety.org, ext. 116

Mark Lacagnina, senior editor
lacagnina@flightsafety.org, ext. 114

Wayne Rosenkrans, senior editor
rosenkrans@flightsafety.org, ext. 115

Linda Werfelman, senior editor
werfelman@flightsafety.org, ext. 122

Rick Darby, associate editor
darby@flightsafety.org, ext. 113

Karen K. Ehrlich, webmaster and
production coordinator
ehrich@flightsafety.org, ext. 117

Ann L. Mullikin, art director and designer
mullikin@flightsafety.org, ext. 120

Susan D. Reed, production specialist
reed@flightsafety.org, ext. 123

Patricia Setze, librarian
setze@flightsafety.org, ext. 103

Editorial Advisory Board

David North, EAB chairman, consultant

William R. Voss, president and CEO
Flight Safety Foundation

J.A. Donoghue, EAB executive secretary
Flight Safety Foundation

Steven J. Brown, senior vice president—operations
National Business Aviation Association

Barry Eccleston, president and CEO
Airbus North America

Don Phillips, freelance transportation
reporter

Russell B. Rayman, M.D., executive director
Aerospace Medical Association

Managing your air safety risk...

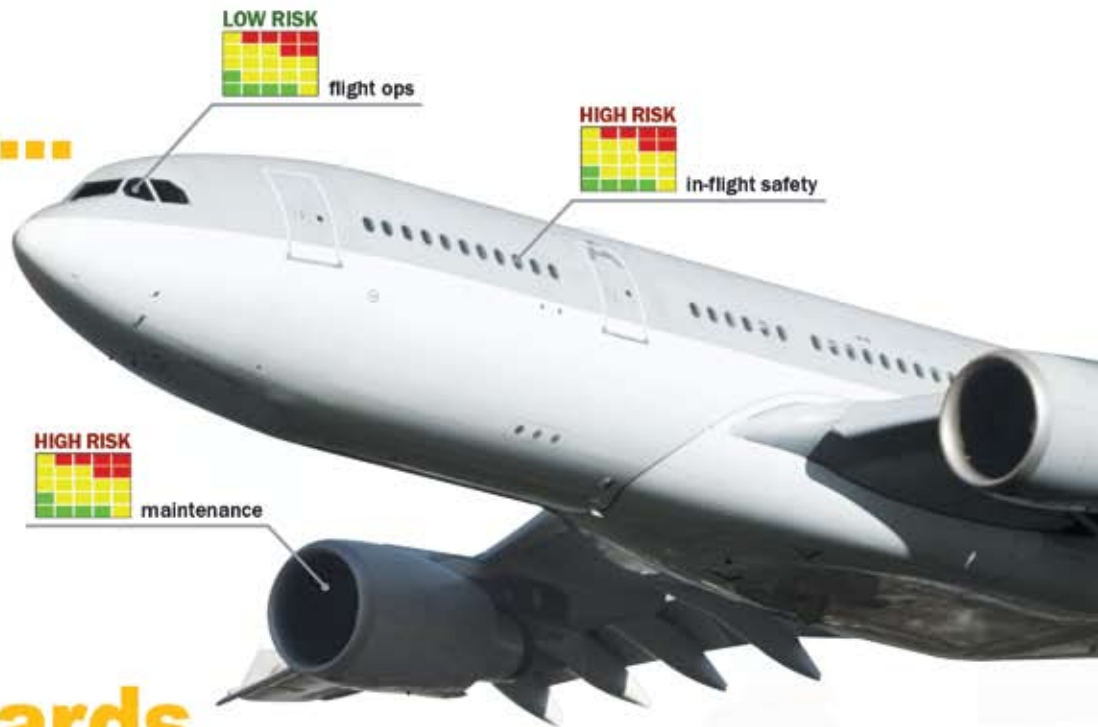

...has its rewards.

EtQ's Air Safety Management System provides visibility into risks across the enterprise

Safety Management

- Safety reporting module integrates incident data across all departments
- Risk assessment calculates and guides decision-making to resolve incidents
- Automatically trigger corrective actions from incidents
- Schedule and execute safety audits (IOSA) across multiple departments
- Consolidate and standardize document control and training across the organization

Quality Management

- Risk assessment determines critical vs. non-critical events, guides decisions
- Schedule and track maintenance and equipment calibration
- Powerful reporting tool with over 50 reports out-of-the-box
- Over 20 integrated modules available:
 - Incidents • Document Control • Employee Training • Corrective Action
 - Audits • Calibration & Maintenance • Centralized Reporting... and more!

Supplier Management

- Foster collaboration with suppliers and contractors
- Create visibility into supplier quality and supplier safety
- Supplier rating automatically updates scorecards based on quality/safety events

Integrated Approach

- Integration of Quality, Safety, Environmental, and Supplier data across the enterprise
- Holistic Integrated Airline Management System



FREE White Paper: An Integrated Approach to Air Safety - Integrated Airline Management Systems



800-354-4476 • 516-293-0949

www.etq.com/aerosafety



CHEAP AND Safe

The recent release of the new Airbus 20-year market forecast shows how resilient the airline industry is.

After yet another decline in world traffic, the third since the early 1990s, airlines once again can expect growth and expansion at least as robust as before the global financial meltdown, and perhaps even a bit more as pent-up demand comes into play. Traffic has doubled every 15 years since the advent of deregulation in the mid-1970s, Airbus said, and will continue to do so in the future, with a 4.7 percent annual increase in revenue passenger kilometers. That means a lot of people flying in a lot of airplanes, requiring a lot of trained personnel, likely bringing back with a vengeance the personnel shortage threat that loomed several years ago.

Most of the new forecast is a minor variation on last year's, but I was struck by the expanded role low cost carriers (LCCs) will be taking in the world market. Already constituting 21 percent of the global airline market in terms of seats offered, Airbus says LCCs and large emerging markets will drive industry growth over the next two decades. Over the next 20 years, Airbus expects, LCCs

will account for 30 percent of the nearly 17,000 single-aisle aircraft that will be sold. Since much of the emerging market growth will be fueled by people able to afford air travel for the first time, it certainly makes sense that LCCs will be the natural business model for capturing this new demand.

Many components of the LCC business model are common to carriers in that segment, one of the most important being a fierce focus on spending. One consequence is that LCCs are reluctant "joiners," preferring to avoid industry commitments that eat into finances and valuable personnel time. They will not sign up just because everyone else does; in fact, LCCs don't automatically do *anything* others — including other LCCs — do without serious consideration.

Unfortunately, this also applies to becoming a member of Flight Safety Foundation. With some notable exceptions I won't list out of fear of missing a couple, LCCs are obviously underrepresented in the FSF membership rolls. We do have a lot of members that are very small airlines with revenues smaller than most LCCs, usually due to home

market size. However, they apparently believe that membership in the Foundation and participation in FSF activities are good safety investments, and I can't argue that. If your safety department is small for any one of a number of valid reasons, it makes sense to supplement it with FSF's resources.

As LCCs become an increasingly important segment of the world airline industry, their participation in industry-wide activities becomes more essential. We will continue to try to coax LCCs into the fold, but we can always use some help. If you work for an LCC, take a few seconds and check the FSF membership list on our new Web site to see if your company's name is there. If you can't find it, consider politely asking your safety department why not.

A handwritten signature in black ink that reads "J.A. Donoghue". The signature is fluid and cursive, with a large, stylized "D".

J.A. Donoghue
Editor-in-Chief
AeroSafety World

DON'T RUN OFF

Runway excursions are far more common than incursions and result in more fatalities. Recognizing the threat, Flight Safety Foundation and the International Air Transport Association have produced the Runway Excursion Risk Reduction Toolkit, a CD based on nearly two years of work by the Foundation's Runway Safety Initiative team.

For the latest and best information on causes and — most important — means of prevention of runway excursions, this is the source.

Runway Excursion Risk Reduction Toolkit

FSF MEMBER US\$42 | NON-MEMBER US\$60



SEPT. 2-3 ➤ Search and Rescue Summit 2009. Rotor & Wing. Reston, Virginia, U.S. Sarah Garwood, <sgarwood@accessintel.com>, <www.aviationtoday.com/sar>, +1 301.340.7136.

SEPT. 2-3 ➤ 21st FAA/ATA International Symposium on Human Factors in Maintenance and Ramp Safety. U.S. Federal Aviation Administration and Air Transport Association of America. San Diego. Sherri Brooks, <sherri.brooks@gmail.com>, <www.airlines.org/operationsandsafety/events/2009hfsymposium.htm>, +1 304.872.5670.

SEPT. 3-4 ➤ Setting Up and Leading a Technical and Safety Committee. International Federation of Air Line Pilots' Associations. Prague, Czech Republic. Gideon Ewers, <gideonewers@ifalpa.org>, <www.ifalpa.org/ifalpa-training.html>, +44 1932 579 041.

SEPT. 5-7 ➤ Accident/Incident Response Preparedness. Austrian Cockpit Association and USC Viterbi School of Engineering. Vienna. <www.aca.or.at>, +43 (0)51766 65799.

SEPT. 7-8 ➤ Safety Management Principles Course. AviAssist Foundation and Zambia Air Services Training Institute. Lusaka, Zambia. Tom Kok, <tom.kok@aviassist.org>, <www.aviassist.org>, +260 (0) 955 711205.

SEPT. 8-10 ➤ Asia Pacific Aviation Training Symposium. Halldale Media. Hong Kong. Jeremy Humphreys, <jeremy@halldale.com>, <www.halldale.com/APATS_AA.aspx>, +44 (0)1252 532009.

SEPT. 8-12 ➤ Aviation Safety Management Systems. Austrian Cockpit Association and USC Viterbi School of Engineering. Vienna. <www.aca.or.at>, +43 (0)51766 65799.

SEPT. 9-11 ➤ Sixth Annual FAA International Aviation Safety Forum. American Association of Airport Executives. Washington. Jacky Sher Raker, <jacky.raker@aaae.org>, <www.aaae.org/meetings/meetings_calendar/mtgdetails.cfm?MtgID=90902&RecID=723>, +1 703.824.0500.

SEPT. 9-25 ➤ Flight Operations Inspector Theory Training. U.K. Civil Aviation Authority. Gatwick Airport. Jenny Ollerhead, <training@caainternational.com>, <www.caainternational.com/site/cms/coursefinder.asp?chapter=134>, +44 (0)1293 573484.

SEPT. 13-15 ➤ Third Annual Aircraft and Airport Recovery Operations Conference and Exposition. American Association of Airport Executives, Memphis-Shelby County Airport Authority and Pavement Performance Products. Memphis, Tennessee, U.S. <aaaameetings@aaae.org>, <events.aaae.org/sites/090604>, +1 703.824.0500.

SEPT. 14-17 ➤ Bird Strike North America Conference. Bird Strike Committee Canada. Victoria, British Columbia, Canada. Carol Liber, <events@theplanner.net>, <www.birdstrikecanada.com/CanadaConference.htm>, +1 604.276.7471.

SEPT. 14-18 ➤ ISASI 2009: Accident Prevention Beyond Investigations. International Society of Air Safety Investigators. Orlando, Florida, U.S. Sharon Morphew, <sharon.morphew@scsi-inc.com>, <www.isasi2009.org/index.html>.

SEPT. 21-24 ➤ 52nd Annual Non-Destructive Testing Forum. Air Transport Association of America. Atlanta. Mark Lopez, <mlopez@airlines.org>, <www.airlines.org/2009NDTForum>, +1 202.626.4125.

SEPT. 22-23 ➤ HFACS Workshop. Wiegmann, Shappell & Associates. Dallas. Diane Kim, <info@hfacs.com>, <www.hfacs.com>, 800.320.0833.

SEPT. 24-25 ➤ VLJ-Europe 2009. Air Taxi Association-Europe and MIU Events. Oxford, England. Alan Perry, <adp@miuevents.com>, <www.miuevents.com/vlj-e09>, +44 (0)20 8332 2211.

SEPT. 28-OCT. 1 ➤ 13th Annual Safety Standdown USA. Bombardier, National Business Aviation Association, U.S. Federal Aviation Administration and U.S. National Transportation Safety Board. Wichita, Kansas, U.S. Janet Schiebelhut or Dawn Pepperd, <safety_standdown@aero.bombardier.com>, +1 316.946.7876.

SEPT. 29-OCT. 1 ➤ Third International Helicopter Safety Symposium. International Helicopter Safety Team. Montreal. Somen Chowdhury, <schowdhury@bellhelicopter.textron.com>, +1 450.971.6500, ext. 2787; Kay Brackins, <kay@vtol.org>, <ihst.rotor.com/Default.aspx?tabid=1507&nnpg2918=1&language=en-US>, +1 703.684.6777.

SEPT. 29-OCT. 1 ➤ Wildlife Hazard Management Workshop. Embry-Riddle Aeronautical University. Athens, Greece. <training@erau.edu>, <worldwide.erau.edu/professional/wildlife-hazard-management.html>, +1 386.226.7694.

OCT. 1-2 ➤ Safety Management System Overview Workshop. ATC Vantage. Orlando, Florida, U.S. <registrations@atcvantage.com>, <www.atcvantage.com>, +1 727.410.4759.

OCT. 4-7 ➤ 54th ATCA Annual Conference and Exposition. Air Traffic Control Association. Washington. Claire Rusk, <claire.rusk@atca.org>, <www.memberservicecenter.org/irmweb/wc.dll/vaaleatca?id=vaaleatca&doc=events/event&kn=25>, +1 703.299.2430.

OCT. 5-8 ➤ Improving Flight Simulator Engineering and Maintenance. ARINC. Cairo, Egypt. Sam Buckwalter, <sbuckwal@arinc.com>, <www.aviation-ia.com/fsemc>, 800.633.6882; +1 410.266.2008.

OCT. 7-8 ➤ International Winter Operations Conference. Air Canada Pilots Association and Canadian Society of Air Safety Investigators. Toronto. Capt. Barry F. Wiszniowski, <bwiszniowski@acpa.ca>, <www.winterops.ca>, 800.634.0944, +1 905.678.9008.

OCT. 7-8 ➤ AQD Customer Conference. Superstructure Group AQD Safety and Risk Management. Louisville, Kentucky, U.S. Liz Swanston, <liz.swanston@superstructuregroup.com>, <www.superstructuregroup.com>, +64 (0)4 3850001.

OCT. 13-14 ➤ Specialized Family Assistance Center Training for Aviation Accidents. Fireside Partners. Cincinnati. <info@firesideteam.com>, <www.firesideteam.com>, +1 302.747.7127.

OCT. 19-21 ➤ 47th Annual Symposium. SAFE Association. San Diego. Jeani Benton, <safe@peak.org>, <www.safeassociation.com>, +1 541.895.3012.

OCT. 19-20 ➤ Accident and Incident Investigation for Airport Professionals. American Association of Airport Executives. Arlington, Virginia, U.S. Stacey Renfroe, <stacey.renfroe@aaae.org>, <www.aaae.org/meetings/meetings_calendar/mtgdetails.cfm?Meeting_ID=090907>, +1 703.824.0500, ext. 196.

OCT. 19-23 ➤ 53rd Annual Meeting of the Human Factors and Ergonomics Society. San Antonio, Texas, U.S. <info@hfes.org>, <www.hfes.org/web/HFESMeetings/09annualmeeting.html>, +1 310.394.1811.

Aviation safety event coming up? Tell industry leaders about it.

If you have a safety-related conference, seminar or meeting, we'll list it. Get the information to us early — we'll keep it on the calendar through the issue dated the month of the event. Send listings to Rick Darby at Flight Safety Foundation, 601 Madison St., Suite 300, Alexandria, VA 22314-1756 USA, or <darby@flightsafety.org>.

Be sure to include a phone number and/or an e-mail address for readers to contact you about the event.

OFFICERS AND STAFF

Chairman,
Board of Governors Amb. Edward W. Stimpson

President and CEO William R. Voss

General Counsel
and Secretary Kenneth P. Quinn, Esq.

Treasurer David J. Barger

ADMINISTRATIVE

Manager,
Support Services Linda Crowley Horger

FINANCIAL

Chief Financial Officer Penny Young

MEMBERSHIP

Director of Membership Ann Hill

Seminar and
Exhibit Coordinator Namratha Apparao

Membership
Services Coordinator Ahlam Wahdan

BUSINESS DEVELOPMENT

Director of Development Susan M. Lausch

COMMUNICATIONS

Director of
Communications Emily McGee

TECHNICAL

Director of
Technical Programs James M. Burin

Technical
Programs Specialist Norma Fields

Technical Specialist/
Safety Auditor Robert Feeler

Manager of
Aviation Safety Audits Darol V. Holsman

Past President Stuart Matthews

Founder Jerome Lederer
1902–2004

Serving Aviation Safety Interests for More Than 60 Years

Flight Safety Foundation is an international membership organization dedicated to the continuous improvement of aviation safety. Nonprofit and independent, the Foundation was launched officially in 1947 in response to the aviation industry's need for a neutral clearinghouse to disseminate objective safety information, and for a credible and knowledgeable body that would identify threats to safety, analyze the problems and recommend practical solutions to them. Since its beginning, the Foundation has acted in the public interest to produce positive influence on aviation safety. Today, the Foundation provides leadership to more than 1,170 individuals and member organizations in 142 countries.

MemberGuide

Flight Safety Foundation
Headquarters: 601 Madison St., Suite 300, Alexandria, VA, 22314-1756 USA
tel: +1 703.739.6700 fax: +1 703.739.6708

www.flightsafety.org



Member enrollment

Ahlam Wahdan, membership services coordinator

ext. 102
wahdan@flightsafety.org

Seminar registration

Namratha Apparao, seminar and exhibit coordinator

ext. 101
apparao@flightsafety.org

Seminar sponsorships/Exhibitor opportunities

Ann Hill, director of membership

ext. 105
hill@flightsafety.org

Donations/Endowments

Susan M. Lausch, director of development

ext. 112
lausch@flightsafety.org

FSF awards programs

Ann Hill, director of membership

ext. 105
hill@flightsafety.org

Technical product orders

Namratha Apparao, seminar and exhibit coordinator

ext. 101
apparao@flightsafety.org

Library services/seminar proceedings

Patricia Setze, librarian

ext. 103
setze@flightsafety.org

Web site

Karen Ehrlich, webmaster and production coordinator

ext. 117
ehrich@flightsafety.org

Regional Office: GPO Box 3026 • Melbourne, Victoria 3001 Australia
Telephone: +61 1300.557.162 • Fax +61 1300.557.182

Paul Fox, regional director

fox@flightsafety.org

Amy Beveridge, event manager

beveridge@flightsafety.org

Safety News

HEMS Recommendations

The U.S. National Transportation Safety Board (NTSB) has issued 19 safety recommendations calling for changes in helicopter emergency medical services (HEMS) operations, including improvements in pilot training and development of a low-altitude airspace infrastructure.

The recommendations follow a public hearing, held in February, to examine HEMS safety issues in the aftermath of the most deadly year ever in U.S. HEMS operations — 12 crashes involving a total of 29 fatalities occurred in 2008.

“The pressure on HEMS operators to conduct their flights quickly in all sorts of environments makes these types of operations inherently more risky than other types of commercial flight operations,” said NTSB Chairwoman Deborah Hersman. “Operators need every available safety tool to conduct these flights and to determine when the risk of flying is just too great.”

The 19 safety recommendations include 10 recommendations to the U.S. Federal Aviation Administration (FAA), calling on the FAA to address issues involving pilot training; collection and analysis of flight data, weather data and safety data; flight data monitoring; development of an infrastructure for low-altitude airspace; and dual pilots, autopilots and night vision imaging systems (NVIS), including night vision goggles.

Two recommendations asked the Centers for Medicare and Medicaid Services within the U.S. Department of Health and Human Services to evaluate the rate structure used in HEMS reimbursement and the relationship between reimbursement and patient transport safety.

Two additional recommendations to the Federal Interagency Committee on Emergency Medical Systems involved coordination of HEMS transport in local and regional emergency medical systems and selection of the most appropriate transportation for trauma victims. The five remaining recommendations were addressed to public HEMS operators and involved improvements in pilot training, flight data monitoring and the use of dual pilots, autopilots and NVIS.

In a related development, Flight Safety Foundation, working with companies in the HEMS industry, has begun a study of the feasibility of flight data monitoring in HEMS operations. The study’s objective is to determine whether enough data can be collected to determine trends, identify risks and develop risk-mitigation strategies.

“We are optimistic that organized data collection from flights will lead to safer operations,” said FSF President and CEO William R. Voss. “We’ve seen that in commercial and corporate aviation with data collection being an integral part of safety management. We are well aware of the safety challenges facing helicopter air ambulance operations and are determined to be part of finding a solution.”



© Terry North/Stockphoto

Unapproved Parts

The U.S. Federal Aviation Administration (FAA) has approved a plan to require Southwest Airlines to replace unapproved parts that were installed on about 50 Boeing 737s.

The FAA and the airline have agreed that the unapproved part — described as being “associated with the hinge fittings for the exhaust

gate assembly which help protect the aircraft flaps from engine heat” — does not interfere with safe operation of the airplanes.

“As a result, the FAA has determined that the airline may continue to operate aircraft with the unapproved part until the parts can be replaced, on the condition that each plane must be

physically inspected for wear and tear every seven days, and the affected parts must all be replaced with an approved part by Dec. 24, 2009,” the FAA said.

The agency also has told Southwest to report to the FAA daily on the results of the inspections and to dispose of additional unapproved parts manufactured by the same vendor.

North Sea Tracking System

Air traffic management provider U.K. NATS and Oil and Gas U.K., a trade association for offshore energy development, are inaugurating a system designed to extend radar coverage to parts of the North Sea that previously were beyond the reach of land-based radar.

Oil and Gas U.K. says that the North Sea Multilateration System is the first system in the world to track offshore flights using multilateration — a process that allows air traffic control (ATC) to process Mode A/C/S transponder data, automatic dependent surveillance–broadcast (ADS-B) data and data from military aircraft.

The system will be used by controllers at Aberdeen (Scotland) Airport, which handles more than 25,000

helicopter flights each year, said John Mayhew, NATS general manager in Aberdeen.

Conventional radar allows ATC to track flights up to 80 nm (148 km) offshore.

“Beyond that range,” Mayhew said, “we have to transfer to radio-only procedures to monitor the helicopters’ position. The new system enables controllers to see the flights they’re controlling all the way to and from the platforms, so it will be easier to ensure that they maintain the correct track and height. And in the event of an emergency, the new system will help us to locate the helicopter.”

Flight trials were scheduled to begin in late September, with the system expected to be fully operational by June 2010.



© Trondur/Dreamstime

Glow-in-the-Dark Blades

Photoluminescent safety paint, which for several years has been used on propellers and rotor blades on military aircraft, is now being applied to civilian aircraft.

Defense Holdings Inc. (DHI), which manufactures a range of glow-in-the-dark devices, planned to apply the paint in late September to the first civilian aircraft — a police helicopter in Virginia, said Gregory Bender, DHI vice president and chief engineer.

The paint — developed under a U.S. Naval Air Systems Command contract and manufactured by Sherwin Williams Aerospace Coatings

— is used on the tips of propeller blades, main rotor blades and tail rotor blades to make the blades visible in the dark. It is intended to help people near the aircraft at night to avoid the injuries and deaths that would result from coming in contact with the blades in the dark (ASW, 8/06, p. 28). In addition, the increased visibility of propellers and rotor blades can help prevent midair collisions, Bender said.

The wavelength of the light emitted by the paint is outside the range of night vision goggles and does not interfere with pilots’ vision.

Battery Ban Urged

North American airline pilots are pressing for a ban on shipments of lithium batteries on passenger and cargo aircraft until new safety regulations are implemented to govern transport of the devices (ASW, 3/08, p. 42).

The Air Line Pilots Association, International (ALPA), which represents pilots at 36 airlines in Canada and the United States, said the ban is needed because of recent fires associated with the battery shipments.

“ALPA has long called for regulations to ensure that safety is the first priority in transporting shipments of lithium batteries aboard airliners,” said Mark Rogers, a first officer who directs ALPA’s dangerous goods program. “Now the evidence of a clear and present danger is mounting. We need an immediate ban on these dangerous goods to protect airline passengers, crews and cargo.”

ALPA said it was not seeking new restrictions on batteries that passengers carry onto aircraft to power laptop computers, cell phones and other items but rather to regulate lithium batteries that are shipped as cargo. Those batteries should be regulated as “dangerous goods” and should be packaged and labeled as such, and pilots should be notified when they are loaded onto their aircraft, ALPA said.



Wayne Rosenkrans

Bounced Landings

Pilots need more training to deal effectively with bounced landings, the Transportation Safety Board of Canada (TSB) said in recommending that the Canadian Department of Transport require air carriers to include bounced landing recovery techniques in manuals and training activities.

The recommendation followed the TSB investigation of a Kelowna Flightcraft Air Charter Boeing 727 cargo jet's hard landing at Hamilton (Ontario) Airport on July 22, 2008. The

airplane touched down hard, bounced and touched down hard again; the pilot then began a go-around, and as he did, the airplane's tail struck the runway. The airplane climbed and returned for a normal landing. No one was injured in the occurrence, which caused minor damage to the airplane.

The investigation determined that although the manufacturer's manual discussed what actions should be taken in case of a bounced landing, the operator's pilots had not practiced the

maneuver or received training on what to do.

"There are risks associated with this type of maneuver, and our investigation shows there is an underlying problem that must be addressed before a more serious accident happens," said Mark Clitsome, TSB director of air investigations. "Pilots rely on training and checklists when problems arise. The best way to ensure the safe outcome of a bounced landing is to make pilots more aware and better prepared."

Recommended Airspace Review

The collision of a sightseeing helicopter and a small private airplane over the Hudson River near New York City has prompted safety recommendations by the U.S. National Transportation Safety Board (NTSB) calling for revised procedures for operations in the area.

Nine people were killed in the Aug. 8, 2009, midair collision of the Eurocopter AS 350BA operated by Liberty Helicopters and the Piper PA-32R-300, operated by a private pilot, and both aircraft were substantially damaged. The collision occurred in a visual flight rules "passageway" through New York's controlled airspace where non-air carrier traffic is permitted to operate without authorization from air traffic control

(ATC). The NTSB's investigation of the accident is continuing.

The NTSB safety recommendations to the U.S. Federal Aviation Administration called for revised ATC standard operating procedures for the passageway; briefings for controllers about the circumstances of the collision, including a discussion of the need to "remain attentive when on duty"; creation of a special flight rules area in the passageway; new requirements for vertical separation between helicopters and airplanes in the area and for special training for pilots before they conduct operations there; and a review of similar airspace configurations "where specific pilot training and familiarization would improve safety."

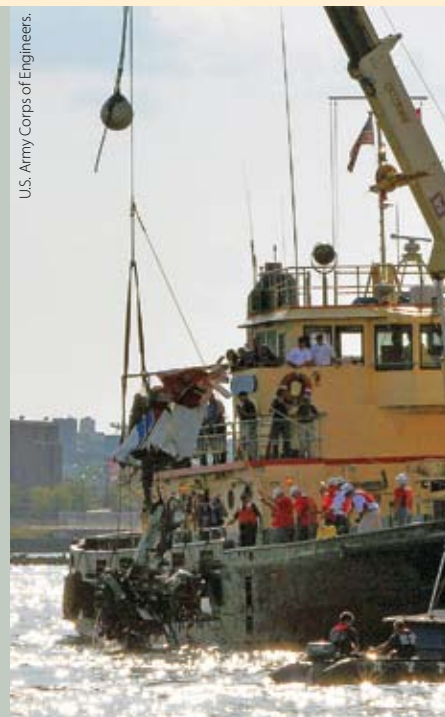

U.S. Army Corps of Engineers.

In Other News ...

The U.S. Federal Aviation Administration has established a new office — the **Accident Investigation and Prevention Service** — to use data gathered in accident and incident investigations to "better understand current and emerging risks across the aviation community." U.S. Transportation Secretary Ray LaHood said the new program

is designed to "give us better tools to spot potential safety problems and head off aviation accidents before they happen." ... The **International Standard for Business Aircraft Operations (IS-BAO)** has been recognized by the European Committee for Standardization (CEN) as the official industry standard for business aircraft operations

in Europe. ... The **SESAR Joint Undertaking** — responsible for developing a new European air traffic management system — has signed agreements with several airlines, manufacturers and aviation organizations to use their technical experts to devise a system that will meet future demand for air transport while also increasing safety levels.

Compiled and edited by Linda Werfelman.



Accessible Sky

Updated U.S. regulation prohibits discrimination against passengers with disabilities except in cases such as a direct threat to airline safety.

BY WAYNE ROSENKRANS

Updates to flight attendant training by major U.S. airlines — which had to be in place by a May 2009 deadline to safely accommodate passengers with disabilities — have tended to be more evolutionary than revolutionary. For the first time, however, all U.S. regional airlines, U.S. on-demand aircraft operators and some non-U.S. airlines must comply with Part 382, a regulation of the U.S. Department of Transportation (DOT) under the Air Carrier Access Act.¹ Regional and on-demand operators that previously complied voluntarily also made straightforward updates.

By comparison, some of the affected non-U.S. airlines have made significant changes because of differences between DOT requirements and their own country's approach to carrying

passengers with disabilities, says Heidi Giles MacFarlane, vice president of strategic development at MedAire. She discussed a few of the safety challenges covered in Part 382 training of non-U.S. airlines during the 2009 International Aircraft Cabin Safety Symposium in Torrance, California, U.S., and discussed others in an ASW interview. Generally, all airline personnel who interact with customers must be trained.

“Under Part 382, we can expect to have more passengers with unique needs,” MacFarlane said. “Its purpose is to open air travel to people who haven't been able to travel in the past. The disability communities throughout the world are very well connected, and they communicate frequently about their rights. The airline community also knows that a number of passengers with disabilities are not aware of the

details of the rule, and it will be important for airline personnel to be able to articulate those details.”

Safety Above All Else

All operations of U.S. air carriers are subject to Part 382, which prohibits carriers from discriminating against an otherwise qualified person with a disability on the basis of that disability—including the person's appearance or involuntary behavior that may offend, annoy or inconvenience crewmembers or other passengers — except as specifically permitted by the regulation.

A critical point, however, is that air carriers “may refuse to provide transportation to any passenger on the basis of safety² ... or to any passenger whose carriage would violate U.S. Federal Aviation Administration [FAA] or Transportation Security Administration

requirements or applicable requirements of a foreign government.”

One acceptable disability-related safety basis for refusing to carry a passenger with a disability is determining that the passenger poses a *direct threat*. This means “a significant risk to the health or safety of others that cannot be eliminated by a modification of policies, practices or procedures, or by the provision of auxiliary aids or services.” Moreover, the direct threat determination must be justified by “an individualized assessment, based on reasonable judgment that relies on current medical knowledge or on the best available objective evidence, to ascertain the nature, duration and severity of the risk; the probability that the potential harm to the health and safety of others will actually occur; and whether reasonable

modifications of policies, practices, or procedures will mitigate the risk.”

The regulation also specifies types of mobility aids and other assistive devices that passengers with a disability must be allowed to bring into the aircraft cabin.

“Part 382 dictates that safety always is the primary factor, and sometimes it’s a mitigating factor in regulatory enforcement,” MacFarlane said. “It’s a matter of finding that middle ground where safety is appropriately considered, and the rights of the individual don’t cancel out safety considerations. It’s a tough tightrope. Many people from non-U.S. airlines come into our Part 382 training with the preconception that a passenger’s rights as a person with a disability come before everything.”

Upper left, MacFarlane; lower left, on-board wheelchairs in 17-in (43.2-cm) and 15-in (38.1-cm) widths; right, accommodation for a passenger with a battery-powered mobility aid.



© Mercury Products (Airchair)



© Open Doors Organization

A few safety-related highlights show the comprehensive scope of Part 382. “With respect to passengers who have mobility impairments, we have clarified the criterion relating to safety assistants to say that the passenger must be capable of physically assisting in his or her own evacuation,” the DOT said. The rule also contains provisions for identifying cases in which people with mental impairments, such as Alzheimer’s disease, and severe hearing and vision impairment or deaf-blind individuals may be required to have a safety assistant accompany them.

Among notable requirements being phased in are movable armrests on at least half the aisle seats in rows that passengers with disabilities may occupy in affected new aircraft; the movable armrests also must be installed when newly manufactured seats replace old seats. The affected air carriers also must provide an on-board wheelchair, also called an aisle chair, aboard any aircraft with more than 60 seats. The DOT explained that “without a means of making a horizontal transfer into aircraft seats, passengers

who board using boarding wheelchairs will have to use the less comfortable, safe and dignified method of being lifted over the armrest.”

Also noteworthy is that all U.S. airlines and affected non-U.S. airlines that conduct passenger-carrying operations — other than on-demand operations — now must allow during all flight phases the use of passenger-owned, battery-powered electronic devices that assist a passenger with respiration, specifically ventilators, respirators, continuous positive airway pressure machines and FAA-approved portable oxygen concentrators, if labeled by the manufacturer as compliant with FAA technical standards.

There is no exemption for aircraft based on size or having no requirement for a flight attendant aboard, and the passenger must carry properly packaged batteries sufficient for 150 percent of the expected maximum flight duration, except when the passenger has contracted for carrier-supplied medical oxygen for in-flight use.

Part 382 significantly helps airline employees to distinguish service animals from pets, identify several types of service animals banned from the cabin and distinguish between service animals allowed to accompany users in the cabin without health care documentation and those that require this documentation in advance of a flight. Non-U.S. air carriers are not required to transport service animals other than dogs.

New communication provisions require high-contrast captioning of safety videos and informational videos, except those not created under the airline’s control, before the end of 2009. Cabin crews also must help to make more types of in-flight announcements accessible, but the DOT said, “The rule expressly relieves the crew from complying [with new in-flight communication requirements for passengers who are deaf, hard of hearing or deaf-blind] when this would interfere with their safety duties under FAA and foreign regulations.”

Complaint resolution officials (CROs) and other categories of airline employees must receive and record specific training. CROs have expertise in interpreting the regulation and accept responsibility for decisions. A CRO does not necessarily have a background in aviation safety

“The passenger must be capable of physically assisting in his or her own evacuation.”

or flight operations, however. “Crew resource management comes into play here,” MacFarlane said. “The CRO talks to all the parties involved but the CRO cannot overrule the captain — that is the fail-safe point.”

New Contingency Training

Training on the basics of the respiratory assistive devices prepares the cabin crew to safely handle some novel situations. Apart from depletion of all available battery power or failure of a portable oxygen concentrator, the primary safety issue would be checking that the passenger has donned a drop-down oxygen mask during a cabin depressurization because the device may not generate its normal rate of oxygen pulses for its life-enhancement purpose, and the duration of in-flight medical oxygen on the aircraft may not be sufficient as a substitute.

Portable respirators and ventilators that fit under an aircraft seat — enabling people to travel with disabilities such as those caused by paralysis — likewise require the cabin crew to have new contingency plans. “If this device does fail for some reason, the individual would have to receive mechanical ventilation with a bag valve mask, possibly directly into the trachea — something that only can be done by someone specifically trained,” MacFarlane said.

MedAire’s Part 382 training aims to prepare CROs, flight attendants and other personnel to pinpoint a safety issue, and then work with the passenger toward the least restrictive solution that mitigates that issue. Safety focus and priorities do not change after flight attendants receive Part 382 training, she added. But a crew’s lack of knowledge about disabilities can lead to DOT regulatory violations. “Making assumptions is where we get lost,” she said. “I saw one passenger board a plane in an aisle chair.

He didn’t have any legs, and so we said, ‘To travel by yourself, you need to be able to physically assist in your own evacuation. Can you do that?’ He jumped right out of his seat and said, ‘Absolutely, look at this. I walk on my hands most of the time; I just didn’t get on the airplane that way. This is how I would evacuate myself.’ He went right up on his hands and walked down the aisle. Because we talked to him, we became confident.”

During the training, students often assume at first that emergency operations, such as evacuations, and even some normal operations inevitably would be problematic if passengers with disabilities are aboard. Yet, evacuation issues can be broken down into simple elements: investigating potential problems before pre-boarding passengers, understanding the capabilities of the individual and being prepared with backup actions, MacFarlane noted. “We address evacuation in terms of the best interest of the individual,” she said. “The flight attendant can say, ‘This is what we do. What do you plan on doing? How can we do this together? What would you need?’”

One possible evacuation scenario that has disturbed flight attendants is expecting the passenger with a disability to physically assist as planned, then realizing that the passenger did not get out. “In training, we say, ‘OK, so you check the cabin and you find someone who, for whatever reason, could not assist in their own evacuation,’ she said. “You would handle that the same way that you would handle any incapacitated passenger who was not incapacitated at the beginning of the flight. It’s really no different. As long as the techniques are safe, the same ones would apply.”

Beneath the surface of some concerns voiced during training was fear of getting involved with the passenger without knowing how to deal with

unfamiliar equipment or situations. “In Part 382 courses, we see the same trepidation that crewmembers have when they come to our medical training,” MacFarlane said. “Everyone has the opportunity in multiple scenarios to play the role of the person with a disability, to play the role of the crewmember, to say the words out loud and to practice in a protected, safe environment.”

Passengers with disabilities often have visualized, and can explain, what to do if a service animal becomes separated from the owner and how to evacuate a service animal down the slide. A guide dog or hearing dog can be expected to join the flow to exit but sense danger at the aircraft door, and typically the dog will have been trained to stop the owner if the owner tries to sit down and move forward onto the slide.

“It’s important for the cabin crew to be aware that they may have to separate animals and owners just to get them down,” MacFarlane said. The training also covers hands-on practice handling, operating, disassembling and reassembling about 20 items of equipment that passengers with disabilities may bring into the aircraft cabin.

Everybody has a responsibility, not just the airlines — and the key is communicating, MacFarlane said. “A lot of work remains to be done in educating the vast disability community,” she added. ➤

Notes

1. Part 382 is shorthand for 14 Code of Federal Regulations Part 382, *Nondiscrimination on the Basis of Disability in Air Travel*. The re-issued regulation, effective May 13, 2009, replaces a final rule issued in 1990 and amended in 1990, 1996, 1997, 1998, 1999, 2000, 2001 and 2003.
2. Details of the basis of safety are provided in 49 U.S. Code 44902 and U.S. Federal Aviation Regulations Part 121.533.

A defective contact — a minor component of a control unit in the Airbus A319-111 electrical power generating system — was identified as the likely cause of an intermittent current-sensing fault that cascaded into an extensive malfunction and left the flight crew without several major systems and unable to communicate with air traffic control.

The severe consequences of the malfunction and the crew's unsuccessful attempts to restore the electrical system were among the findings of the incident investigation that prompted the U.K. Air Accidents Investigation Branch (AAIB) to issue a raft of recommendations that included modifications of the electrical system and its associated minimum equipment list (MEL) provisions, and re-

vision of transport airplane certification standards.

The serious incident occurred on Sept. 15, 2006, during a scheduled flight with 138 passengers and six crewmembers from Alicante, Spain, to Bristol, England. The commander, 42, had 8,800 flight hours, including 393 hours in type. The copilot, 34, had 3,208 flight hours, including 560 hours in type.

Partial-Panel Puzzle

The A319 pilots were powerless to rectify an electrical system gone haywire.

BY MARK LACAGNINA





© Carlos F./Jetphotos.net

The aircraft, operated by easyJet, was less than a year old and had accumulated 1,962 hours of service. It had an “enhanced” electrical power generation system, which is similar to the “classic” system originally used in A320-series aircraft, including the A319 and A321, but has different integrated drive generators with control units providing extra monitoring and control functions.

Independent Networks

A brief description of the electrical system might help in understanding what happened during the incident flight. The system, designed by Hamilton Sundstrand, has two main networks, no. 1 and no. 2. Each network has an engine-driven, 90 kVA (kilovolt-ampere) alternating-current (AC) integrated drive generator (IDG).

Figure 1 (p. 18) shows the system in normal operation, with both engine-driven generators — labeled “IDG1” and “IDG2” in the diagram — on line, the generator line contactors (“GLC1” and “GLC2”) closed and the transfer bus tie contactors (“BTC1” and “BTC2”) open, resulting in each generator powering its own network.

The AC current is converted downstream by transformer rectifiers into 28-volt direct current (DC).

“The no. 1 and no. 2 networks are normally independent of one another, so that the failure of one network should not adversely affect the other,” the report said. “Each generator is individually capable of supplying the aircraft’s electrical requirements after automatic shedding of some galley loads.”

Three instrument displays were among more than 100 components and systems lost in flight.

In addition to powering the no. 1 AC bus and DC bus, the no. 1 generator powers the AC and DC *essential* buses, which feed the aircraft’s most critical electrical subsystems and components.

A 90-kVA auxiliary power unit (APU) AC generator can be used on the ground or in the air to substitute for either of the engine-driven generators. Another in-flight backup is a 5-kVA emergency generator that is driven hydraulically by a ram air turbine (RAT). “The RAT deploys either automatically, usually because of loss of both main AC bus bars, or on manual selection,” the report said.

The electrical system normally is operated automatically by generator and APU control units that govern the associated line contactors and transfer bus tie contactors. Manual operation is accomplished via an overhead control panel on the flight deck.

The system also incorporates two 24-volt, 23-ampere-hour batteries, each of which has a “hot” bus that supplies power continuously to components such as the no. 2 air data and inertial reference system (ADIRS), the parking brake, the engine and APU fire-suppression systems, and the elevator/aileron computer.

Previous Trips

The aircraft’s no. 1 engine-driven generator had tripped off line during a flight to London Stansted Airport the day before the incident, and the generator control unit was replaced that night. The generator tripped off line during subsequent maintenance ground tests, but it was successfully reset, and the aircraft was released for service.

The next morning, the no. 1 generator tripped off line again about 20 minutes after the A319 departed from London for a flight to Alicante. The pilots — not the same as those on the later incident flight — performed the corrective actions displayed by the electronic centralized aircraft monitor (ECAM), including one attempt to reset the generator. The attempt was unsuccessful, so the crew isolated the generator and engaged the APU. Maintenance personnel advised the crew by radio that the flight could be continued with the electrical system in this configuration.

A company engineer in Alicante determined that the malfunction was an acceptable deferred defect under the provisions of the MEL and that the aircraft could continue in service with the no. 1 generator inoperative provided that the APU was operational — to substitute for the inoperative generator — and that the aircraft be flown no higher than Flight Level (FL) 335 (approximately 33,500 ft).

The MEL did not require maintenance action, an investigation of why the generator tripped off line or a review of previous electrical system faults, the report said.

In the dispatch configuration, the no. 1 generator line contactor was open, the APU line contactor was closed, and the no. 1 transfer bus tie contactor was closed, allowing the APU to power the no. 1 network.

“When the two flight crews changed over aircraft at Alicante, the respective commanders had a short discussion about the no. 1 generator problem,” the report said. “A flight plan was filed for FL 320 for the flight from Alicante to Bristol, and the commander asked for extra fuel to be uplifted, to allow for the additional fuel burn of the APU during the flight.”

Normal Configuration of the A319 Electrical System

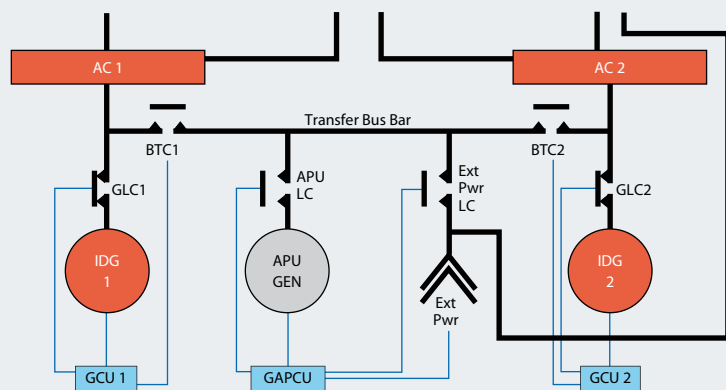

Note: Instead of the normal configuration, the incident aircraft was dispatched for the flight from Spain to England with the no. 1 integrated drive generator (“IDG1”) inoperative and the auxiliary power unit (“APU GEN”) engaged; the no. 1 generator line contactor (“GLC1”) was open, the APU line contactor (“APU LC”) was closed and the no. 1 transfer bus tie contactor (“BTC1”) was closed.

Source: U.K. Air Accidents Investigation Branch

Figure 1

Loud ‘Clunk’

The A319 departed from Alicante at 0926 coordinated universal time as Flight EZY6074. The commander was the pilot flying. The aircraft was in visual meteorological conditions (VMC) at FL 320 near Nantes, France, at 1052 when the crew heard a loud “clunk” and several systems became inoperative.

“The commander’s initial assumption was that either the APU had shut down or the APU generator had failed,” the report said. “He saw that his own electronic instrument displays had blanked and so, after checking that the copilot’s instruments were available, handed over control. The copilot flew the aircraft manually, using manual thrust and without the flight director, which had disappeared.”

Figure 2 shows the condition of the electrical system immediately after the malfunction. Basically, the no. 1 network had been de-energized. The no. 1 transfer bus tie contactor — labeled “BTC1” in the diagram — had opened, isolating the APU generator, which was still operating but was now unable to power the network.

The report lists more than 100 systems and components that were rendered inoperative by the malfunction. Among them were the commander’s primary flight display and navigation display, the no. 1 transponder, the multipurpose control and display unit, the autopilot, the auto-throttles, and most of the captions (annunciators) and lights on the overhead panel.

The ECAM displayed the corrective action: resetting the “AC ESS FEED” selector from normal to alternate. This action was intended to reset the AC essential feed contactor and allow the AC essential bus — and most of the other buses on the no. 1 network — to be powered by the no. 2 engine-driven generator.

Manual Correction Required

The report noted that restoration of the electrical system in A320-series aircraft following such a malfunction is a *manual* operation that requires about one minute, according to Airbus. However, if the no. 1 AC bus fails in newer Airbus models,

Post-Malfunction Configuration of the A319 Electrical System

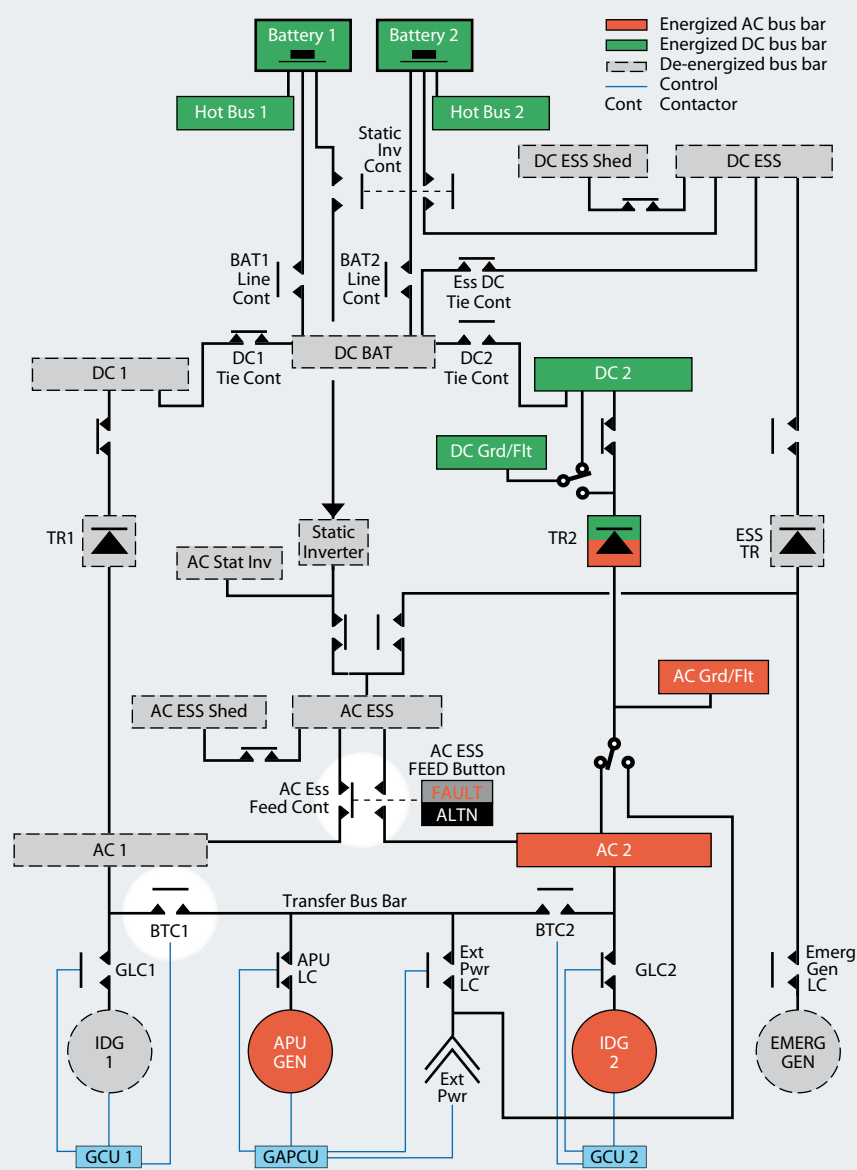

Note: The no. 1 transfer bus tie contactor ("BTC1") was erroneously locked open by a defective control unit ("GCU1"), isolating the auxiliary power unit ("APU GEN") from the no. 1 network. The pilots were unable to restore power to the network by resetting the AC essential bus feed contactor.

Source: U.K. Air Accidents Investigation Branch

Figure 2

the AC essential bus *automatically* is switched to the no. 2 AC bus.

Before attempting to manually restore power to the AC essential bus, the commander noticed that neither of the two captions on the "AC ESS FEED" selector was illuminated. "He also noted

that there were now no lights showing on the overhead panel, except for the 'ON BATTERY' caption light on the ADIRS panel," the report said. "These observations by the commander were confirmed by the copilot, who was monitoring the ECAM actions." The ADIRS,

which is on a hot battery bus, continued to provide navigation guidance.

The selectors on the overhead electrical system control panel are push-button switches. "The physical position of the button does not change significantly between settings," the report said. "When a push-button is released, its physical depression varies by only 1–2 mm [0.04–0.08 in]. ... Annunciator captions in each push-button illuminate to indicate the status or fault condition of the associated function."

The commander pressed the "AC ESS FEED" push-button but noticed no effect. "The push-button selector switch caption remained unlit, and the electrical system failed to reconfigure," the report said. "He stated that he was unable to verify the selection made on the switch ('ALTN' or 'NORMAL') because the button does not remain depressed after making a selection."

The ECAM also indicated that the RAT "was operating, although it had not actually deployed," the report said.

Incommunicado

The commander also noticed that the lights on his radio management panel and both audio control panels no longer were illuminated. He attempted unsuccessfully to contact the Brest (France) Air Traffic Control Center (ATCC) on the no. 1 and no. 2 VHF radios, using the previously assigned frequency. He then declared an emergency on 121.5 MHz but received no response.

"The copilot attempted the same using [his radio management panel], but this also proved unsuccessful," the report said. "The commander then tried switching to the [no. 3 audio control panel] but was still unable to re-establish communications with Brest ATCC."

The crew's efforts to contact ATC likely were driven by concerns related to "the current safety climate," the report said. "They were concerned that they might be intercepted by military aircraft because of the loss of radio communications and that, given the aircraft's degraded status, they might not be able to follow an interceptor or land at another airfield.

"Furthermore, they were concerned that if they deviated from a flight-planned route to divert to an en route airfield, it might be considered a hostile action, which could lead to offensive measures being taken against their aircraft."

The crew's efforts to re-establish radio communication with ATC had the unfavorable result of interrupting and delaying their compliance with the corrective actions displayed by

the ECAM. Consequently, 10 minutes elapsed from the onset of the electrical system malfunction to the commander's selection of the no. 2 transponder, which was on a bus on the no. 2 network and therefore operable. He also selected the emergency transponder code, 7700. However, the crew did not know if the transponder signal was being received by ATC.

Brest ATCC did not have primary radar, and when the secondary radar returns from the aircraft's transponder ceased, the controller handling the aircraft made several attempts to contact the crew by radio. The controller then instructed the flight crew of another aircraft that was westbound at FL 320 to descend to FL 310. A few moments later, one of the pilots in the westbound aircraft told the controller that an easyJet aircraft had passed overhead, northbound.

"The radar controllers were relieved that the [A319] had been found but also alarmed that it had come so close to another aircraft," the report said. At the closest distance, the A319 was 600 ft above the other aircraft and about 2.7 nm (5.0 km) north.

The commander's selection of the no. 2 transponder was successful. Secondary radar contact resumed at about 1103, but radio communication with the aircraft was not re-established.

Pressing Ahead

After reviewing the ECAM messages and the actions that had been taken to restore the inoperative systems and components, the commander made another attempt to reset the AC essential bus feed switch. Again, he noticed no effect.

He consulted the landing performance data in the quick reference handbook and found that the aircraft could be landed safely on the runway at Bristol. "The pilots had already received the weather forecast for Bristol, which was favorable [with visibility more than 10 km (6 mi) and a few clouds at 1,000 ft], and realized that they would not be able to obtain weather information if they diverted," the report said. "The commander thus decided that the best course of action was to continue to Bristol."

Airbus A319



© Chris Sorensen Photography

The A319 is a member of a family of narrowbody, twin-engine, short- to medium-range airliners featuring fly-by-wire flight control systems with sidestick controllers and major primary structures built with composite materials.

The A320 was introduced first, in 1988. The A321, the stretched version, followed in 1993. The A319, which is 3.8 m (12.5 ft) shorter than the A320, entered service in 1996. Maximum passenger accommodations are 180, 220 and 145, respectively.

The incident aircraft is an A319-111, one of nine A319 models that include a corporate jet. It has CFM International CFM56-5B5 engines rated at 97.9 kN (22,014 lb). Standard maximum weights are 64,000 kg (141,094 lb) for takeoff and 61,000 kg (134,481 lb) for landing. Maximum operating speeds are 0.82 Mach and 350 kt. Maximum altitude is 39,000 ft.

Source: *Jane's All the World's Aircraft*

The copilot remained the pilot flying, and the crew was able to remain in VMC for the remainder of the flight, which was conducted according to their flight plan and the normal arrival profile at Bristol. Nearing Bristol, the commander made several unsuccessful attempts to contact ATC with a mobile telephone. However, ATC was tracking the aircraft on secondary radar and had cleared the area of all other aircraft.

The flaps extended normally, but “when the commander selected the landing gear down, none of the gear indicator lights illuminated, and there was no accompanying sound of landing gear deployment,” the report said. “He used the emergency gear extension system to extend the landing gear by gravity.

“Full flap was used for landing, and after touchdown heavy manual braking was applied. The aircraft stopped quickly. It was taxied to a parking stand, where a normal shutdown was attempted, but the engines continued to run after the master switches were selected off. The commander succeeded in shutting them down using the engine fire switches.”

History of Problems

Investigators were unable to determine why the flight crew was unable to restore the electrical system. “The system was subsequently found to operate normally, and testing of the relevant components uncovered no defects,” the report said. “However, it remained possible that a temporary anomaly, that was not repeated or uncovered, had prevented the system from producing the expected effect.”

The malfunction of the electrical system was traced to a defective contact in the no. 1 generator control unit (“GCU1” in the diagram), which performs system testing and monitoring as well as regulating the output of

the engine-driven generator and several system contactors.

The defect had caused the GCU to erroneously detect a “welded” generator line contactor, a condition that occurs if the contactor remains closed after being selected open. Consequently, the GCU locked the no. 1 transfer bus contactor open “to prevent it from closing and potentially creating a hazard by allowing other power sources to motor the IDG through the apparently closed [generator line contactor],” the report said.

This particular GCU had been installed in three different aircraft within a five-month period. “In each case, the unit remained in service for only a short time until it was removed because a fault had been indicated,” the report said.

The incident aircraft had experienced 10 electrical system problems in the month preceding the accident. They included failures of the APU generator to come on line, faults in the no. 1 generator and no. 1 APU control units, and a report of “severe electrical interruptions.”

The report said that a substantial number of control unit problems in the incident aircraft — and in other A320-series aircraft — apparently had been caused by defective static random access memory (SRAM) devices. Airbus in 2006 issued an operators’ information telex (OIT 999.0106/06) listing the serial numbers of 2,200 generator and APU control units potentially affected by the defective SRAM devices.

“Normal practice was for a [generator or APU control unit] rejected from service to be sent by the operator to an overhaul and repair facility and initially subjected to a standard acceptance test,” the report said. “A substantial proportion of such units passed the test and were consequently released back to service [with the notation] ‘no fault found.’” The facility kept no record of

units that were repeatedly rejected, then returned to service.

“Given the history of intermittent faults experienced on the A320-series [electrical systems] caused by [generator control unit] SRAM defects ... it is possible that maintenance personnel considered that the problem on the outbound flight was caused by an intermittent SRAM defect and was therefore not a serious issue,” the report said.

Noting that the incident aircraft was cruising in VMC when the malfunction occurred, the report said that the outcome might have been far more serious if the malfunction had occurred at low altitude during a critical phase of flight, such as approach or departure.

Based on the findings of the investigation, the AAIB issued 14 recommendations, including a call for modification of the A320-series electrical system to automate the transfer of power to the AC essential bus when the no. 1 AC bus is lost. Airbus responded with a service bulletin recommending such a modification, and the European Aviation Safety Agency told AAIB that it will issue an airworthiness directive mandating compliance with the manufacturer’s bulletin.

Among other recommendations were revision of certification standards to ensure that flight deck control selectors provide “immediate and unmistakable indication of the selected position”; reconsideration of A320-series master MEL provisions allowing dispatch with an inoperative engine-driven generator; and revision of maintenance procedures to ensure that control units with excessive rejection rates or recurrent faults are not returned to service. 🌀

This article is based on AAIB Accident Report 4/2009: “Report on the Serious Incident to Airbus A319-111, Registration G-EZAC, Near Nantes, France, on 15 September 2006.” The report is available at <www.aaib.gov.uk>.

Going Solo

BY R. KURT BARNHART

Single-pilot air carrier operations, boosted by technology, could have wider application in the future.

Being involved in the relatively novel unmanned aerial systems (UAS) industry and in the flight training industry, I'm often faced with the question: "Do you think that passenger aircraft will ever fly without a pilot?" To all but the youngest inquirers, I often reply, "Probably not in your lifetime," based on my 25 years of experience as a pilot, although I can be a bit pessimistic when it comes to the pace of change in air transportation — and, to a great extent, we all benefit from a system that is allowed to become more efficient as technology permits.

That question, however, is intriguing and has caused me to look back over the history of commercial air transportation and consider the future possibilities in light of our work with small, but fully autonomous, UAS that now fly in the U.S. national airspace system.

Looking at the history of commercial air travel, it is easy to see several trends. The most obvious change to the flight deck over 60 to 70 years has been the reduction in the number of required flight crewmembers. Most long-range

passenger aircraft of yesteryear, such as the Boeing Stratocruiser, required five flight crewmembers.

In addition to the captain and first officer, there was the second officer or "flight engineer," whose job was to monitor from a sideways-facing seat the complex aircraft systems as displayed on an array of analog gauges. There also was a navigator adept at using charts, manual flight computers, sextants and practical mathematics to keep the captain informed of the aircraft's position. Finally, the radio operator, working closely with the navigator, tuned the bulky communications equipment and made periodic position reports. All of this was necessary because the technology of the day made flying long distances a highly labor-intensive operation.

In the late 1950s and 1960s, as electronics technology improved from large vacuum tubes to miniature vacuum tubes, then to solid state transistors with the accompanying improvement in reliability, the radio operator gradually became unnecessary on longer flights as communications improved and the systems became more



© Chris Sorensen Photography

automated. For over-land flights, the advent of very high frequency (VHF) navigational aids such as the VHF omnidirectional radio gradually eliminated the need for a navigator.

Later, with the advent of the on-board inertial navigation system (INS), long-range navigators began to suffer the same fate. Thus, the three-flight-crew aircraft remained the norm for longer-range aircraft until the availability of the microprocessor in the late 1970s, which further reduced the size and improved the reliability of the on-board systems to the point where manufacturers such as Boeing were ready to move to the two-person flight crew for their 767 and 757 aircraft.

It helped greatly that shorter-range transport aircraft such as the Boeing 737 and the McDonnell Douglas DC-9 had already crossed this threshold in spite of strong labor union opposition, but only after long and detailed study revealed that there was no adverse impact on air safety. In fact, early versions of both the 737 and 767 were configured for three flight crewmembers, as both industry and the government grappled with the issue. At the time, many of those in the system seemed to promote the principle of “more is better” when it came to the number of flight crewmembers. However, though crew resource management was a little-understood concept at the time, we can now see that the more people in the front of an aircraft, the more time and energy needs to be devoted to managing the working relationships created by those people. This created enormous potential to detract from flying duties and erode aviation safety. Indeed, some high-profile air carrier accidents in the 1970s seemed to prove this point.

Needless to say, the two-crewmember flight deck has emerged as the winner even for the longest-range aircraft, but will it ever be possible to move from two to one, or even zero in passenger-carrying transports? Certainly in our current air transportation system, this is far from possible and is a *long way* from being accepted; however, the evolution of technology is radically changing air transportation as most of us have known it, and smaller UAS now operate in the national airspace system, fully automated from takeoff to touchdown.

Designers of modern aircraft have transformed the job of a pilot into largely that of an automation manager, even for smaller, shorter-range aircraft. FedEx has already expressed interest in long-range unmanned cargo aircraft for some of its overwater routes. Demonstrating that capability would go a long way to proving the safety and reliability of the technology and, as digital-savvy generations age, public acceptance of unmanned passenger operations would be almost certain to follow, given enough time.

While I do not foresee unmanned passenger airline operations in my lifetime (I'm 40), I do think it's feasible to get down to one flight crewmember, and I think there will be economic pressure on airlines to pursue this as technology matures and pilots become more scarce. For this to happen, many major hurdles will obviously need to be overcome. For instance, automation will need to become the norm for all operations, with hand flying reserved for emergencies, and neither air traffic control nor flight deck technology is there yet. Also, it will need to be possible to monitor the health of the flight crewmember with the capability to intervene through flight control from the ground. In a conversation with Chad Cundiff, vice president of crew interface for Honeywell International, I learned that efforts are under way to improve ground awareness of flight crew health status. Finally, it should be noted that single-pilot jet aircraft carry passengers every day in all weather and traffic conditions under the general operating and flight rules of U.S. Federal Aviation Regulations Part 91, so would it be such a large leap of faith to add a few more passengers with better, more reliable technology? Would it be detrimental to safety? As we have seen as we have moved from five flight crewmembers to two, technology has a way of answering questions like that for us. 🚀

In addition to serving as the aviation department head at Kansas State University, R. Kurt Barnhart, Ph.D., is the executive director of the Applied Aviation Research Center, where the flagship project is the Unmanned Aerial Systems (UAS) Program Office, working with industry to create solutions to the challenges of integrating UAS into the national airspace system.

InSight is a forum for expressing personal opinions about issues of importance to aviation safety and for stimulating constructive discussion, pro and con, about the expressed opinions.

Send your comments to J.A. Donoghue, director of publications, Flight Safety Foundation, 601 Madison St., Suite 300, Alexandria VA 22314-1756 USA or donoghue@flightsafety.org.



Asleep at the Wheel



To prevent more incidents in which pilots doze off at the controls, the NTSB is seeking new research into fatigue and new steps to identify pilots with obstructive sleep apnea.

BY LINDA WERFELMAN

Cit^Citing the demanding schedules flown by short-haul flight crews, the U.S. National Transportation Safety Board (NTSB) has called for new research into ways in which the “unique characteristics of the job” contribute to pilot fatigue.

The NTSB recommendation followed its investigation of a Feb. 13, 2008, incident involving a go! Airlines Bombardier CL-600-2B19 that flew about 26 nm (48 km) past its destination airport in Hilo, Hawaii, U.S., because its two pilots had unintentionally fallen asleep during the

mid-morning flight from Honolulu. The pilots awakened and turned back to Hilo, where they landed the airplane; no one was injured in the incident, and the airplane was not damaged.

“Although the incident ended without damage or injury, this outcome was dependent on two chance factors,” the NTSB said. First, the airplane had been loaded with enough fuel for a round-trip flight; with that cushion, there was 1.5 hours of fuel remaining when the pilots woke up — without it, there would have been enough fuel for 22.5 minutes of flight.

Second, the report said, “the flight crew fell asleep halfway through the 51-minute flight rather than later in the flight, and they slept 18 to 25 minutes; thus, they flew only three minutes beyond their destination and added just eight minutes to the total duration of the flight. If the flight crew had fallen asleep later in the flight or remained asleep longer, that situation, too, may have led to the exhaustion of available fuel.”

The NTSB concluded that the crew’s work schedule, including several consecutive early morning start times, was one factor that contributed to the incident. Another factor was the captain’s obstructive sleep apnea — a disorder that can disrupt sleep hundreds of times during a typical sleep period — which had not yet been diagnosed at the time of the incident (see “Obstructive Sleep Apnea,” p. 26).

The NTSB said that the fact that the pilots had fallen asleep in the mid-morning — “a time of day normally associated with wakefulness and rising alertness” — indicates that they were fatigued.

“This incident is not an isolated occurrence,” the NTSB said in a letter accompanying the safety recommendations to Randy Babbitt, administrator of the U.S. Federal Aviation Administration (FAA). “Researchers have found and pilots have reported other instances of professional pilots falling asleep on commercial flights.”

The NTSB cited several studies:

- A 2005 study, in which researchers measured pilot brain activity, found 10 episodes of “unplanned sleep or reduced alertness” in 400 person-hours of flight.¹
- A search of the U.S. National Aeronautics and Space Administration (NASA) Aviation Safety Reporting System database for 1995 through 2007 revealed 17 reports in which crewmembers on U.S. Federal Aviation Regulations Part 121 flights said that they had inadvertently fallen asleep during flight. Of the 17 reports, five described events in which both pilots had fallen asleep.²

- A 1999 NASA survey of regional airline pilots found that 80 percent said that they had “nodded off” during a flight, and respondents said that multiple flight segments and “scheduling considerations” contributed to their fatigue.³

The NTSB recommendations called for research specifically aimed at identifying methods of reducing the effects of fatigue on short-haul pilots, such as studying the “interactive effects of shift timing, consecutive days of work, number of legs flown and the availability of rest breaks.”

Multiple Legs, Short Turnarounds

The go! pilots involved in the Hawaii incident routinely flew eight legs during a duty period of slightly more than nine hours, the NTSB said. During those eight legs a considerable amount of time was spent performing the high-workload activities involved in takeoffs and landings.

Turnaround times between legs averaged 17 minutes, a schedule that “limited their

The go! pilots routinely flew eight legs during a duty period of slightly more than nine hours.



© Marco Garcia/Associated Press

Obstructive Sleep Apnea

Many people with obstructive sleep apnea — including the captain of a go! Airlines Bombardier CL-600-2B19 that overflew its destination airport during a Hawaiian Islands flight because both pilots were asleep — are unaware that they have the disorder, which can cause breathing to stop and start hundreds of times during a typical eight-hour sleep period.

Obstructive sleep apnea — by far the most common of two primary types of sleep apnea¹ — occurs when throat muscles relax during sleep and block the upper airway. It is most common in older adults, especially those who are overweight.

Other risk factors include hypertension (high blood pressure), a thick neck or narrow throat, chronic nasal congestion, diabetes, smoking or the use of alcohol or sedatives. The disorder is twice as likely to occur in men, two to three times as likely in people older than 65, and — among those younger than 35 — more common among blacks, Hispanics and Pacific Islanders.²

Symptoms include loud snoring that typically begins soon after falling asleep and is interrupted by silence, followed by a “loud snort and gasp” and a resumption of snoring, medical experts at the U.S. National Institutes of Health (NIH) say.³ The pattern is repeated throughout the sleep period. Other symptoms include unusual daytime sleepiness, morning headaches and difficulty concentrating.

Blood tests and electrocardiograms are among the tests that may be

performed on an individual suspected of having obstructive sleep apnea, which often is confirmed through a polysomnogram (sleep study), in which electrodes are placed at various locations on the head to detect the amount and quality of sleep obtained during a sleep session, which is observed by a health care specialist. Heart rate and breathing also are monitored throughout the session.⁴

Untreated, the sudden decreases in blood oxygen levels that accompany obstructive sleep apnea can cause an increase in blood pressure, a strain on the cardiovascular system and a higher risk of heart attack and stroke.⁵

Treatment of mild cases of obstructive sleep apnea may involve only lifestyle changes, such as losing weight; avoiding alcohol, tobacco and sedatives; or changing the sleeping position. In some cases, an oral appliance, made by a dentist or orthodontist, can be worn to adjust the position of the lower jaw and tongue during sleep.⁶

For individuals with moderate to severe obstructive sleep apnea, the most common treatment is the use of a continuous positive airway pressure (CPAP) device, which consists of a mask over the nose that is connected via a tube to an air blower that directs a steady, gentle stream of air into the throat to keep the airway open.

Notes

1. Central sleep apnea, which accounts for about 5 percent of sleep apnea cases, is a disorder in which breathing

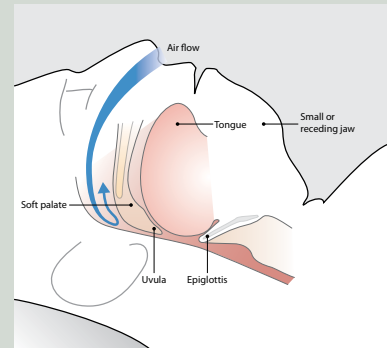

Susan Reed

Obstructive sleep apnea occurs when throat muscles relax and block the upper airway.

stops and starts because the brain does not properly signal the muscles involved in breathing. It typically results from heart failure, stroke and other medical problems.

2. Mayo Clinic. *Obstructive Sleep Apnea: Risk Factors*. <www.mayoclinic.com/health/obstructive-sleep-apnea/DS00968/DSECTION=risk%2Dfactors>.
3. U.S. National Library of Medicine (NLM); NIH. “Obstructive Sleep Apnea.” *Medline Plus*. <www.nlm.nih.gov/medlineplus/ency/article/000811.htm>.
4. NLM; NIH. “Polysomnography.” *Medline Plus*. <www.nlm.nih.gov/medlineplus/ency/article/003932.htm>.
5. U.S. National Heart Lung and Blood Institute (NHLBI). “What Is Sleep Apnea?” *Diseases and Conditions Index*. <www.nhlbi.nih.gov/health/dci/Diseases/SleepApnea/SleepApnea_WhatIs.html>.
6. NHLBI. “How Is Sleep Apnea Treated?” *Diseases and Conditions Index*. <www.nhlbi.nih.gov/health/dci/Diseases/SleepApnea/SleepApnea_Treatments.html>.

— LW

opportunities to eat and attend to physiological needs, which could have interfered with their ability to obtain proper nutrition and avoid dehydration,” the board said.

The NTSB found no research involving pilots flying more than five legs per duty period.

One survey that questioned pilots who flew five legs per duty period found that, by the end of a shift, they felt minor to moderate fatigue, compared with pilots who flew a single leg during a duty period and said they felt “okay” as they neared the end of a workday.⁴

Another study, conducted for the North Atlantic Treaty Organization (NATO), found that pilots who reported for duty before 0600 local time usually slept less than six hours a night and experienced sleep of poorer quality than pilots who reported for duty later in the day.⁵

The NTSB said that, in the case of the go! incident, the operator scheduled pilots to work one of two shifts: beginning at 0540 and ending about 1440 or beginning at 1400 and ending about 2300.

“Pilot schedules were not arranged to minimize individual pilots’ exposure to morning shifts, as recommended by researchers,” the NTSB said. “Rather, schedules were arranged so that some weeks included mostly morning shifts and some included mostly afternoon shifts. As a result, some pilots were required to work five consecutive early morning shifts.”

Current FAA regulations allow two-person crews to be scheduled for as many as eight flight hours a day, but they do not set daily limits on overall duty time, as long as crews are scheduled for at least nine hours of rest between duty

periods. In some cases, eight-hour rest periods are permitted, however.

U.K. Duty Limits

The FAA regulations differ from work rules adopted in 2004 in the United Kingdom, which established maximum daily duty times that vary according to the time of day a pilot reports for duty and the number of legs he or she flies. For example, a flight crew that begins work between 2200 and 0559, is acclimated to the local time zone and flies one leg may work a maximum of 11 hours; if the crew flies four or more legs, they may work no more than nine hours. Crews with several consecutive early morning reporting times also are restricted to nine hours of duty time, regardless of how many legs they fly.

Three of the NTSB safety recommendations called on the FAA to conduct fatigue research specifically relating to short-haul flight operations, to issue interim guidance to operators of multi-segment short-haul flights that provides relevant information that becomes available during the course of the research and, ultimately, to require the operators to incorporate the guidance into their operations specifications.

Sleep Apnea

The three other recommendations resulting from the investigation of the go! incident

Obstructive sleep apnea often is treated with a continuous positive airway pressure (CPAP) device, which consists of a mask to cover the nose, a connecting tube and an air blower that uses a stream of air to keep the upper airway open.



© Robeco/Dreamstime



© Juan Monino/iStockphoto

called on the FAA to take steps to identify pilots at high risk for obstructive sleep apnea. The captain's case was considered severe, and the NTSB said that symptoms existing before the incident could have prompted physicians during at least two medical examinations to determine that he was at risk.

"The captain was experiencing excessive daytime sleepiness and loud nighttime snoring, was obese, ... and had hypertension that was not optimally controlled despite the use of two different blood pressure medications," the NTSB said. He had discussed the snoring with his primary care physician in December 2007, but testing for obstructive sleep apnea was not recommended.

FAA records show that 0.5 percent of pilots with first class medical certificates report having obstructive sleep apnea, compared with 1 percent of active U.S. Air Force pilots and 7 percent of the general adult population. The NTSB said that, considering the Air Force's fitness requirements, civilian pilots are more likely than military pilots to have risk factors, such as obesity and hypertension, associated with obstructive sleep apnea — and that a survey published in 2007 determined that 15 to 24 percent of civilian pilots could be classified as obese.⁶

The FAA's guidance to aviation medical examiners does not include a discussion of risk factors for obstructive sleep apnea, and the application for an airman's medical certificate does not ask pilots if they have a history of obstructive sleep apnea or if they have symptoms of the disorder, the NTSB said.

Federal agencies overseeing other forms of passenger transportation

already gather such information from operators, or are revising forms and guidance as part of plans to begin gathering it, and at least one regional transit agency is conducting a test project to screen operators for obstructive sleep apnea and other sleep disorders. The FAA also should develop this type of guidance, the NTSB said.

"Objective medical data already gathered by the FAA could be used to measure risk for [obstructive sleep apnea] using existing consensus guidance on screening, but the most effective screening would require the FAA to gather additional information and develop additional guidance," the NTSB said. "Because [obstructive sleep apnea] is associated with excessive daytime fatigue, leads to an increased risk of accidents and cognitive impairment, substantially increases the likelihood of critical errors and of actually falling asleep during flight, and because many individuals who have the disorder do not know they have it, the NTSB concludes that efforts to identify and treat the disorder in commercial pilots could improve the safety of the traveling public."

NTSB safety recommendations called on the FAA to modify the application for a pilot medical certificate to include questions about whether the applicant had ever been diagnosed with obstructive sleep apnea and whether he or she had risk factors for the disorder.

The FAA also should implement a program to "identify pilots at high risk for obstructive sleep apnea and require that those pilots provide evidence through the medical certification process of having been appropriately evaluated and, if treatment is needed,

effectively treated ... before being granted unrestricted medical certification," the NTSB said.

Another recommendation said the FAA should disseminate guidance to help pilots, their employers and their physicians to identify individuals at high risk for obstructive sleep apnea, at the same time "emphasizing that pilots who have obstructive sleep apnea that is effectively treated are routinely approved for continued medical certification." 🌐

This article is based on NTSB safety recommendations A-09-61 through A-09-66 and the accompanying letter to the FAA, dated Aug. 7, 2009, and incident report SEA08IA080.

Notes

1. Wright, N. et al. "Avoiding Involuntary Sleep During Civil Air Operations: Validation of a Wrist-Worn Alertness Device." *Aviation, Space, and Environmental Medicine* Volume 76 (no. 9, 2005): 847–856.
2. The NTSB said that it reviewed reports to determine the relevance of all events.
3. Co, E.L., et al. *Crew Factors in Flight Operations XI: A Survey of Fatigue Factors in Regional Airline Operations*, NASA/TM Report no. 1999–208799.
4. Powell, D.M.C. et al. "Pilot Fatigue in Short-Haul Operations: Effects of Number of Sectors, Duty Length, and Time of Day." *Aviation, Space, and Environmental Medicine* Volume 78 (no. 7, 2007): 698–701.
5. Simons, M.; Valk, P.J.L. "Early Starts: Effects on Sleep, Alertness, and Vigilance," Report AGARD-CP-599 (Neuilly-sur-Seine, France: NATO-AGARD, 1998): 6/1–6/5.
6. Bryan, D.A.; Mills, W. "Co-Morbid Conditions in Overweight and Obese Airmen; Trends and Aeromedical Implications." *Aviation, Space, and Environmental Medicine* Volume 78 (no. 7, 2007): 702–705.



HALON PRESSURE

**Environmental deadlines signal impatience
with civil aviation's inability to replace
legacy aircraft fire-suppression agents.**

BY WAYNE ROSENKRANS

The European Union, International Civil Aviation Organization (ICAO) and Underwriters Laboratories recently have taken steps toward withdrawing within a few years the regulatory exemptions allowing commercial transport aircraft to carry halon 1211 and halon 1301. These two halons¹ — clean fire-extinguishing agents for scenarios requiring a streaming or total flooding attack, respectively² — have been the only agents universally accepted for fighting in-flight fires on these aircraft for more than 45 years. Many aviation safety specialists regard them as unmatched in overall performance, worth what they consider negligible risk of serious environmental harm,³ and still indispensable.

For a sense of the quantity of halon carried on current widebody passenger jets, a Boeing 777 typically has 377 lb (171 kg) to protect cargo compartments, 57 lb (26 kg) to protect engines and auxiliary power units (APUs), 10–18 lb (4.5–8 kg) in hand-held extinguishers, and 1.5–3 lb (0.7–1.4 kg) in lavatory trash receptacles.

An analysis for the International Aircraft Systems Fire Protection Working Group (IASFPWG) — which includes specialists from Australia, Brazil, Canada, France, the United

Kingdom and the United States — said that proposed European regulations would apply new limits to exemptions for critical use of halons aboard commercial transport aircraft. The IASFPWG as of mid-2009 was studying the proposal, especially the following mandatory halon-replacement deadlines: The cut-off dates for halon in all new aircraft would be January 2012 for lavatory trash receptacles, hand-held fire extinguishers and engine nacelle/APU compartments, and January 2017 for cargo compartments. The end dates for carrying halons in all existing aircraft would be 2017 for lavatory trash receptacles, 2021 for hand-held fire extinguishers and 2031 for engine nacelle/APU compartments and cargo compartments.

The European rationale for this proposal said in part, “In its 2007 report, the [Scientific Assessment Panel established under the Montreal Protocol on stratospheric ozone-depleting substances] warned the parties that, despite the successes, continued vigilance was required to keep to the newly projected timetable for recovery of the ozone layer, also taking account of the remaining uncertainties, notably about the impact of climate change.

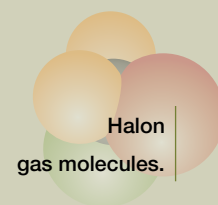
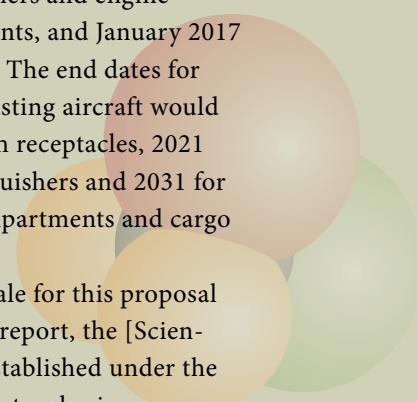
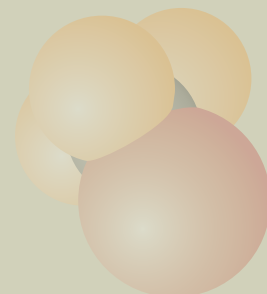
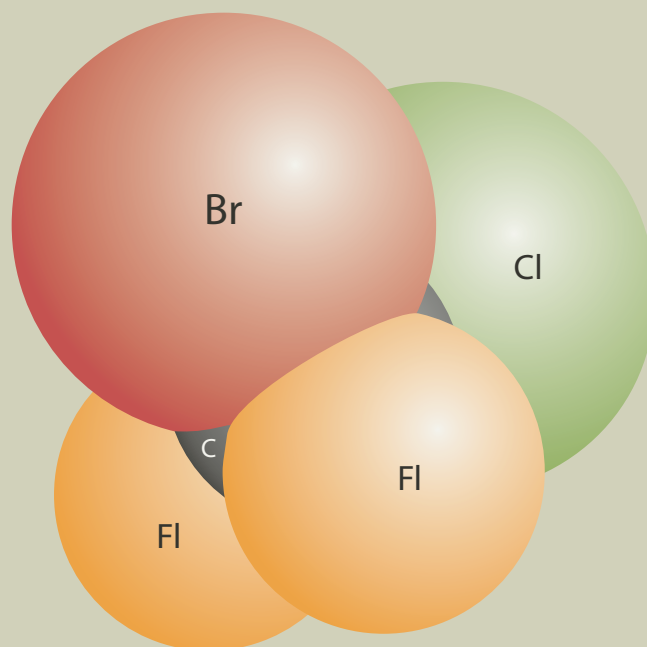

Key remaining challenges relate to the release of ‘banked’ ozone-depleting substances [such as halons]/greenhouse gas emissions into the atmosphere, exempted uses of ozone-depleting substances [such as critical uses in aviation] and new ozone-depleting substances. ... As alternatives are now available to replace halons in fire-protection applications, end dates for existing applications can now be set. ... However, in individual cases it will be possible to grant derogations from these end dates if no technically and economically feasible alternatives are available.”⁴

In March 2008, ICAO asked all states to consider Assembly Resolution A36-12 — Halon Replacement, urging them to “advise their aircraft manufacturers, airlines, chemical suppliers and fire-extinguishing companies to move forward at a faster rate in implementing halon alternatives in engine and [APUs], hand-held extinguishers and lavatories; and investigating additional halon replacements for engines/[APUs], and cargo compartments.” The resolution noted that “much more needs to be done because the available halon supplies are dwindling and the environmental community is becoming more concerned with the lack of substantive progress in aviation [and] no real progress has been made in cargo compartment halon replacement, which is by far the largest application of extinguishing agent.”

The resolution asked the ICAO Council to consider mandatory replacement of halons in 2011 for lavatories of new production aircraft; and also for lavatories, hand-held extinguishers, engines and APUs when aircraft manufacturers apply for a new aircraft type certificate. It also called for mandatory replacement of halon in 2014 for hand-held extinguishers on new production aircraft.

In June 2009, the International Coordinating Council of Aerospace Industries Associations (ICCAIA) asked ICAO to reconsider its “unrealistic timeline” for halon replacement. “After the U.S. Federal Aviation Administration (FAA) and ICCAIA briefing, ICAO’s Air Navigation Commission decided to establish a task force to consider the various halon issues in greater depth,” the council said. “ICCAIA maintains that the ICAO Assembly acted without full consideration of all the ramifications. Appropriate replacement agents are not available ... and some alternatives produce a weight penalty that causes greater fuel burn and more release of carbon dioxide and other emissions more damaging to the environment than the small amount of halon emitted on rare occasions.”

Also responding in June, the IASFPWG said that although there was no foreseeable problem replacing halon 1301 in lavatory trash receptacles, the date for replacing halon 1301 engine nacelle/APU compartment extinguishers would not be feasible, and the date

for replacing halon 1211 hand-held portable extinguishers probably could be met only with significant aircraft structural redesign. Drop-in replacements would not be available in that time frame.

Underwriters Laboratories a year earlier had announced plans to withdraw, and not replace, its “Standard for Halogenated Agent Fire Extinguishers, UL 1093” on the basis of imminent phase-out of halons and in response to mounting environmental concerns about preserving a standards infrastructure allowing indefinite further use of halons. After the organization consulted with representatives of the U.S. commercial airline industry, however, it changed the effective date of this decision from Oct. 1, 2009, to Oct. 1, 2014.⁵

Boeing Commercial Airplanes had told the IASFPWG in November 2008 that UL 1093 was vital to keep as the only standard available to meet FAA regulatory requirements, that related FAA guidance to industry was not expected until 2010 and that significant installation issues would require a minimum of three years before non-halon systems could be installed in airplanes. “Boeing’s goal is to replace fire extinguishers just one time, and with an environmentally acceptable agent,” Boeing representatives said in a May presentation to the working group. “Industry resources are better spent working to develop a drop-in replacement to reduce the overall impact of the change.”⁶

Halon can be used in many ways, including in some of these hand-held extinguishers.



Boeing representatives also said that, contrary to common misconception, FAA approval of an extinguishing agent does not constitute approval for use aboard a specific aircraft. “There are FAA-approved 5BC extinguishers [a capacity and type suitable for hand-held use on flammable liquids and gases and energized electrical equipment], but they are not FAA-approved for installation on Boeing airplanes,” they said. “Boeing must show compliance to multiple FAA regulations related to structure; design and construction; and installation.” They said that issues of performance, such as increased size and weight of non-halon hand-held extinguishers; uncertain future environmental considerations; and economic concerns if old and new technologies are not interchangeable, complicate the process.

Increased size and weight of replacement fire fighting equipment may require “relocation and/or extensive configuration/structural changes to the airplane ... a revised/new installation drawing for each location” and testing to ensure that cabin crewmembers can reach, maneuver and retrieve the new fire extinguishers, they said.

Environmental Impact

Tension between environmental interests and aviation interests on this issue is not new, but has intensified. On one hand, all concerned want to protect the lives of aircraft occupants with the best technology at hand; on the other hand, all concerned want to rapidly halt and reverse life-threatening risks to millions of people and to ecosystems from damage to the Earth’s ozone layer and global warming. The planet’s ozone layer provides a protective barrier to ultraviolet (UV) solar radiation, mostly UVB, which in excessive

amounts has been linked to fatal and non-fatal skin cancer, cataracts and a weakened immune system in humans, and measurable harm to plant and aquatic ecosystems. Global warming similarly affects many aspects of human life on a macro scale, from agriculture and weather to flooding and continued habitability of population centers, according to the U.S. Environmental Protection Agency.⁷

“Ninety percent of the ozone in the Earth’s atmosphere is found in the stratosphere,” the agency explains. “The characteristics of halon and other human-made chemicals that can deplete ozone ... enable them to reach the stratosphere, where they break down, and the chlorine and bromine from them can destroy ozone. Halons are a major source of bromine in the stratosphere.”⁸

When global authorities became aware of the severe stratospheric ozone layer-depleting properties of halons and their lesser global-warming properties, they banned any further production under the Montreal Protocol in 1994 (Table 1, p. 32). Cessation of halon production alone was expected to lead to cessation of all halon uses as replacements were invented, tested and approved. Nearly all uses of halons were phased out, but aircraft in-flight fire fighting was exempted indefinitely pending aviation industry acceptance of fully equivalent solutions for aircraft. So far, only non-halon systems for protecting lavatory trash receptacles on new airplanes have been accepted.

The IASFPWG, like the FAA, has focused on minimum performance standards (MPS) for replacement agents in each aircraft application. Aircraft manufacturers notably are still calling for basic and applied scientific research leading to “drop-in”

replacement agents wherever possible but also have pursued other alternatives.⁹ Other avenues of halon replacement — for some of the four aircraft fire-suppression applications — include engine and APU fire research on applications of 3M Novec 1230 fire protection fluid since 2002.

So far, halon-replacement agents that have passed MPS tests and other FAA tests are larger, heavier, leaving the aviation industry unsatisfied and unconvinced that these solutions will have a long and predictable service life. Subject specialists are now considering advocating the retention of halon 1211 and halon 1301 aboard aircraft until the industry is convinced that comparable or better alternatives meet the whole range of requirements.

Underwriters Laboratories has listed three commercially available hand-held extinguishers as having MPS-compliant replacement agents — HCFC Blend B (Halotron I), HFC-227ea and HFC-236fa — and they have passed full-scale fire tests by the FAA. A new advisory circular about to be released for comment will cover these halon-replacement extinguishers and discuss their safe discharge inside aircraft.

Most halon-replacement products that have passed aviation MPS testing also come from a group of chemical compounds known as hydrochlorofluorocarbons (HCFCs). They do not have the high ozone-depletion potential of halons, but some environmental scientists see their global warming potential as significant. One concern of the IASFPWG is that proposed regulations seeking to accelerate halon replacement shortly afterward will be amended with deadlines for banning aircraft fire-extinguishing agents containing HCFCs, or perhaps requiring discharged-gas

Timeline of Aircraft-Related Halon Replacement Issues

Date	Event/Development	Significance
1959–1977	Halon 1211 marketed as clean fire extinguishing agent in 1973. Scientists and FAA also recognize aircraft firefighting capability of halon 1301.	The new agents begin to displace problematic carbon dioxide and dry powders, but they remain in service as an extinguishing agent aboard aircraft.
Early 1980s	Significant decrease noticed in concentration of ozone in stratosphere over Antarctica.	Harmful ultraviolet solar radiation (primarily UVB) not blocked by ozone layer has increased at Earth’s surface in affected areas.
1987	United Nations drafts the Montreal Protocol on Substances that Deplete the Ozone Layer.	Global debate begins on phase-out of ozone-depleting substances.
1990	Ozone-depleting substances account for about 50 percent of global carbon-dioxide emissions.	Carbon-dioxide equivalent (greenhouse gas) emissions in the atmosphere cause global warming.
1993	FAA forms International Halon Replacement Working Group to produce new MPS.	Work has focused on lavatory trash receptacles, cargo holds, hand-held extinguishers and engine nacelle/APU compartments.
1994	States sign Montreal Protocol.	Production of halons ceases but there is no prohibition on continued use of a finite recycled supply of halons.
Late 1990s	Decreased ozone layer considered severe over North Pole and South Pole; threats measured elsewhere.	Scientists link excessive UV radiation to human health (such as millions of fatal and non-fatal skin cancers, cataracts and immune system suppression) and harm to plant and aquatic ecosystems.
2000	First two halon 1301 replacement agents pass MPS tests.	Boeing and Airbus install lavatory trash receptacle fire systems with these agents on new aircraft.
2003	Renamed International Aircraft Systems Fire Protection Working Group surveys users of hand-held extinguishers.	Research continues on alternative agents focusing on customers and markets for them.
Mid-2000s	First halon 1211 replacement agents pass MPS tests for hand-held fire extinguishers.	Agent volume, weight and dimensions of equivalent extinguishers exceed halon-based solutions by a significant amount.
Late 2000s	Airbus, Boeing and research partners test separate proprietary systems for engine nacelle/APU fire protection.	Manufacturers of halon-replacement agents market them for many applications unrelated to commercial transport aircraft.
2007	ICAO letter urged faster action by states and industry to replace halon, and announced monitoring of progress toward this goal.	For its 2008-2010 work program, ICAO later agreed to continued working group discussion on feasibility of dates in 2011-2014.
2007	Montreal Protocol’s Scientific Assessment Panel says the ozone layer is slowly returning to normal concentration.	Scientists push for more tools to accelerate full recovery of the ozone layers, such as by removing exemptions for halon systems aboard aircraft.
2009	U.S. Environmental Protection Agency issues a proposed endangerment finding.	Some substances used as halon replacements may come under further scrutiny as pollutants.
2009	FAA says it will issue for comment an advisory circular on latest options for replacing halon 1211 hand-held extinguishers.	Scientific research behind the draft advisory circular greatly expanded knowledge of human effects of discharging new agents in the cabin.
2009	FAA shows that three halon 1301 alternative agents met MPS for engine nacelle/APU protection.	Research showed that agent and system weight will be greater than halon-based systems, requiring new design approvals.
2009	Industry testing of cargo compartment agent alternatives to halon 1301 do not identify any agent that meets all MPS requirements.	Research continued on a water mist/nitrogen gas hybrid system as an alternative fire suppression technology in place on one agent.
2010	An update of the Kyoto Protocol to the United Nations Framework Convention on Climate Change is expected. Ozone-depleting substances will account for about 5 percent of global carbon-dioxide emissions.	Scientists push for elimination of remaining ozone-depleting substances and non-ozone-depleting substances that have significant global warming potential, including some of the halon alternatives for aircraft use.
2014	Underwriters Laboratories plans to drop support for its Standard for Halogenated Agent Fire Extinguishers.	FAA regulations have required that aircraft systems meet this standard, so a new basis of continuing use of halon agents would be required.
2015-2040	Targets set for phaseout of hydrochlorofluorocarbons in developed countries.	Some halon alternatives in aviation, especially airports, likely would have to be replaced.
2050	Projected recovery of Arctic and average ozone layers to pre-1980 level.	No ozone-depleting substances released into the atmosphere for any reason.
2060-2075	Projected recovery of Antarctic ozone layer	No ozone-depleting substances released into atmosphere.

APU = auxiliary power unit; FAA = U.S. Federal Aviation Administration; MPS = minimum performance standards

Sources: European Community Regulations; International Civil Aviation Organization; U.S. Federal Aviation Administration; Hughes Associates

Table 1

recovery systems, making costly changes at best only an interim solution.

Elusive 'Magic Bullet'

"After more than 20 years ... a 'magic bullet,' i.e., a one-to-one, drop-in replacement, has yet to be developed," said a 2009 analytical report by Hughes Associates for American Pacific Corp., which makes Halotron I, one of the HCFC products. "All alternatives are either less efficient, have undesirable environmental qualities or cause collateral damage. With supplies of halon 1211 dwindling, the need for an acceptable alternative is becoming more acute. The United Nations Environment Programme (UNEP) Panel has stated that, due to the lengthy process of testing, approval and market acceptance of new fire protection equipment and agents, no additional options are likely to be available in time to have an appreciable impact by the year 2015."¹⁰

In September 2007, the U.S. government and the UNEP Ozone Secretariat had addressed these issues in a working paper to the ICAO Dangerous Goods Panel and the ICAO Assembly on halon replacement in civil aviation aircraft.¹¹ The paper said. "Although the [MPS] are available, there has been little success in developing and installing alternatives to halon in civil transport aircraft. Halon has been the fire-extinguishing agent of choice in civil aviation because it is extremely effective on a per unit-weight basis over a wide range of aircraft environmental conditions; a clean agent (no residue); electrically non-conducting; and of relatively low toxicity.

"It is likely that any known alternative agents for engines/APUs will require more agent and system weight and will require significant design approval activity prior to incorporation

into existing designs. Additionally, the existing alternative extinguishers for hand-helds are larger and heavier than the current halon extinguishers, which will trigger additional requirements for airframe manufacturers (i.e., design change approvals) and airlines (e.g., crew training) prior to incorporation into existing designs."

The MPS to replace halons in cargo compartment protection requires passing test scenarios involving simulations of bulk-loaded cargo, containerized cargo, a surface burning fire and an exploding aerosol container. "Generally, each approach [with alternative agents] had one or more shortcomings compared to halon 1301," the working paper said. "With two of the agents, tests have produced excessively high levels of hydrogen fluoride and a significant weight penalty. During the fire-suppression phase, the smoke layer ignited unexpectedly, producing a 'rollover' and temperature spikes, phenomena never seen with halon 1301. ... Other agents caused toxicity concerns or over-pressurization of aerosol cans or sudden flare-ups."

Some participants in the debate have mentioned another unexpected source of halon-replacement pressure. Banked supplies of recycled halons — while dwindling — currently are adequate and sold at acceptable cost to replenish systems aboard commercial transport aircraft. One specialist told a 2008 FAA meeting, however, that civil aviation now competes directly for this resource with organizations seeking higher profits from the destruction of halons for greenhouse gas emission credits than they receive supplying halons to aircraft operators. "The cost of recycled halon in the United States is currently in the range of \$15 per pound or \$33,000 a ton ... if greenhouse gas credits are

priced at \$20 a ton of carbon-dioxide gas equivalent, a ton of halon 1301 would be worth \$142,800 to destroy," according to a representative of Halon Alternatives Research Corp., the FAA said. ➤

Notes

1. The term is a short form of halogenated hydrocarbon.
2. Halon 1211 is used in aircraft hand-held fire extinguishers. Halon 1301 is used in fixed extinguishing systems. Ideal clean agents quickly evaporate, do not obscure vision, are not electrically conductive and leave no residue.
3. Some aviation safety specialists have argued that the quantities of halons actually discharged during flight operations are too small to justify a near-term ban on them.
4. European Parliament and the Council of the European Union. "Regulation of the European Parliament and of the Council on Substances that Deplete the Ozone Layer (Recast)." No. 2008/0165 (COD). July 7, 2009.
5. Hughes Associates. "The Case for New Production of HCFC-123 Beyond 2020 for use in Production of Halotron I and in Other Niche Fire Protection Applications." July 1, 2009.
6. Carlo, Al; Madden, Mike. "Halon Replacement for Airplane Hand-Held Fire Extinguishers: The Challenges." Presentation to the International Aircraft Systems Fire Protection Working Group, Cologne, Germany. May 20, 2009.
7. EPA. "Guidance for the EPA Halon Emission Reduction Rule: Background for Halon Technicians." United States Air and Radiation EPA430-B-01-001, Environmental Protection (6205). February 2001.
8. EPA.
9. Carlo; Madden.
10. Hughes Associates.
11. United States and United Nations. "Halon Replacement in Civil Aviation Aircraft." Working paper A36-WP/207 TE/64 presented at the 36th Session of the ICAO Assembly. Nov. 5–16, 2007.



START-UP PROBLEMS

An in-flight engine fire followed maintenance technicians' use of an inappropriate procedure to manually start a balky engine on an MD-82.

BY LINDA WERFELMAN

An inappropriate manual engine-start procedure used by American Airlines maintenance personnel on a McDonnell Douglas MD-82 led to the uncommanded opening of an air turbine starter valve (ATSV) and a subsequent engine fire during climb-out, the U.S. National Transportation Safety Board (NTSB) said in its final report on the Sept. 28, 2007, accident at Lambert-St. Louis International Airport.

As the crew returned to the departure runway for an emergency landing, the nose landing gear failed to extend. They conducted a go-around, used emergency procedures to extend the landing gear and then carried out the emergency landing. None of the 143 people in the airplane was injured, but the fire caused substantial damage to the airplane.

The NTSB cited the inappropriate engine-start procedure as the probable cause of the accident and said that the fire was prolonged by the flight crew's "interruption of an emergency checklist to perform nonessential tasks." The NTSB cited as a contributing factor "deficiencies in American Airlines' continuing analysis and surveillance system (CASS) program."

The day of the accident, as the crew prepared for their flight, they were unable to start the left engine. Similar engine-start problems had been reported repeatedly in the days preceding the accident. On this occasion, maintenance personnel manually opened the ATSV while the captain held the engine-start switch in the "START" position; on the second attempt, the engine started.



© Associated Press

Airport vehicles surround an MD-82 after an emergency landing in St. Louis in 2007. Below, an airport worker examines soot near the left engine.

The flight crew told accident investigators that the first indication of a problem came at about 1313 local time, when the first officer told air traffic control that the left engine “ATSV OPEN” light had illuminated. The cockpit voice recorder recorded “a sound similar to the engine fire warning bell” at 1313:55, followed by the first officer’s statement that the “LEFT ENGINE FIRE” warning light had illuminated and the crew’s declaration of an emergency.

The first officer discharged two fire-extinguishing bottles and then lowered the landing gear handle. A controller in the airport’s air traffic control tower said that the nose landing gear had not extended, and as the crew began a go-around, the controller added that he saw “quite a bit of black ... soot ... on that engine.”

About the same time, the airplane lost both electrical power, including the auxiliary power that should have kept the airplane systems operating, and hydraulic power for the right side. The crew — with assistance from an off-duty captain who had flown the accident airplane on the previous flight — performed the “Emergency Gear Extension” checklist and heard the nose gear being extended, although landing gear indication lights did not illuminate.

The airplane landed at 1332, and the crew stopped it on the runway to allow aircraft rescue and fire fighting personnel to apply fire-

extinguishing material to the left engine before passengers were deplaned.

Manufactured in 1988

The accident airplane was manufactured in 1988 and purchased the same year by American Airlines; at the time of the accident, it had 57,744 flight hours and 30,254 cycles. Its two engines were Pratt & Whitney model JT8D-219 dual-rotor turbofans. The left engine had 43,784 total flight hours, with the last major maintenance and inspection performed 5,339 hours before the accident; the right engine had 59,507 flight hours, with the last major maintenance and inspection 76 hours before the accident.

Each engine had an engine-start system consisting of a pneumatic air turbine starter (ATS), an ATSV — which the report described as an “electrically controlled and pneumatically operated butterfly-type valve” that controls airflow into the ATS, an ATSV air-filter assembly, an engine-start switch, an “ATSV-OPEN” light, an engine-start system wiring harness and a pneumatic line that carries air from the pneumatic power source to the ATSV inlet (Figure 1, p. 36).

The ATS on the accident airplane was overhauled and installed in 2006 and had accumulated 3,234 operating hours since overhaul. The ATSV was overhauled on Aug. 29, 2007, and was installed in the accident airplane on Sept. 27, 2007, one day before the accident.

Under normal conditions, the ATS operates “when the electric start switch is held in the ‘ON’ position and supplies 28 volts of electric power to the ATSV solenoid,” the report said. “When the solenoid retracts, it allows the ball valve to unseat and air to flow into the piston/diaphragm housing, causing the piston to move and the butterfly valve to open. When the ATSV butterfly valve is opened, airflow at a pressure of about 30 [psi] is directed into the ATS inlet, causing the ATS turbine to rotate at a high speed and provide rotational power to the engine core. The opening of the butterfly valve closes the ATSV microswitch, completing the indicating light circuit and causing the ‘ATSV-OPEN’ light to illuminate. Once the engine has



U.S. National Transportation Safety Board

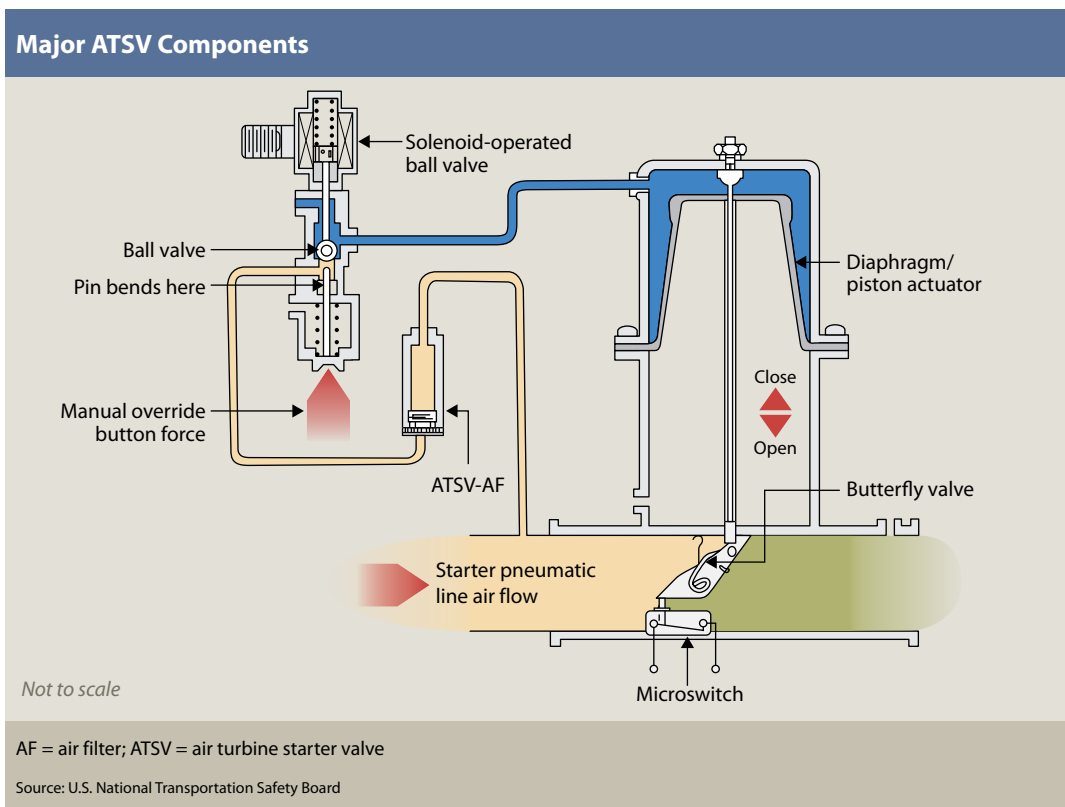

for maintenance personnel to “open the ATSV using an approved, specialized wrench to turn the wrenching flats on the upper end of the butterfly valve shaft and request that the flight crew activate the engine-start switch,” the report said. “The procedure further instructs maintenance personnel to close the ATSV using the wrenching flats and verify that the ATSV is closed.”

After the accident, airline maintenance personnel told investigators that the approved procedure was

Figure 1

reached self-sustaining speed and the pilot shuts off the engine-start switch, the ATSV solenoid is de-energized, causing the ATSV to close and terminate the start cycle. The ‘ATSV-OPEN’ light goes off and stays off as long as the ATSV remains in the closed position.”

With typical pressure during a normal start of 30 to 40 psi, the accompanying temperature is 300 to 400 degrees F (149 to 204 degrees C). If an ATSV is open during takeoff or some other time when the engines are operating at a high-power setting, the pressure can increase to 80 to 90 psi, with a temperature of 560 to 600 degrees F (293 to 316 degrees C). If an ATSV is open while an engine is operating at a high power setting, however, the ATSV would not be connected to the engine; instead, it would be “freewheeling” — or spinning freely at maximum speed.

Manual Engine Starts

The airline’s MD-80 *Maintenance Procedures Manual* described one approved procedure for manually starting an engine. Instructions called

“very time-consuming and could take about 20 to 40 minutes to perform because the required specialized wrench was not part of the standard tool kit and so had to be found; then, the cowl latches and lower door had to be opened, the engine-start sequence performed and the lower door closed.”

The maintenance personnel said that, “instead of using the approved procedure, they usually chose to use a prying device to reach, depress and hold down the ATSV’s manual override button, which is accessed through a small panel located on the forward lower cowl door.”

Boeing Procedures

The Boeing MD-80 *Aircraft Maintenance Manual (AMM)* describes two approved procedures for manually starting engines, one of which resembles the approved procedure used by American Airlines and calls for a special wrench to be used to turn the wrenching flats on the butterfly valve shaft. The second method calls for maintenance personnel to

After a 1996 incident ... Boeing ... cautioned maintenance personnel not to use any tool to depress the manual override button.

depress the manual override button, which activates the ATSV.

After a 1996 incident involving an uncommanded ATSV-open event during climbout, Boeing issued All Operators Letter 9-2549, which cautioned maintenance personnel not to use any tool to depress the manual override button. The investigation of that incident determined that the manual override button had stuck in the override position because its internal pin had been bent.

Boeing added the following to the *AMM*:

Use only hand pressure to depress override button. Use of screwdriver or other type of prying device to depress override button can deform slender pin mechanism inside valve. A deformed override button pin can hold solenoid switcher ball off its seat, which allows valve to open uncommanded when air pressure is available to engine start valve.

After the accident, in April 2008, Honeywell approved an American Airlines plan to redesign the internal override pin to ensure that a prying tool could not be used to push it. The airline began modifying MD-80 ATSVs in February 2009 to incorporate that change; the alterations are expected to be completed by August 2010.

Maintenance Programs

At the time of the accident, the American Airlines maintenance program for its MD-80s included a fixed interval inspection program, which called for a maintenance C check and inspection every 5,000 flight hours. Maintenance records showed that all required checks had been performed, including cleaning of the ATSV air filter on March 16, 2006. Required C check procedures did not include a detailed visual inspection of the filter element — a provision that was added after the accident.

“A review of American Airlines’ ATSV-related maintenance troubleshooting procedures found no specific written guidance relating to a failed ATSV or ATSV air filter,” the report said. “A review of the accident airplane’s maintenance logbooks dated from Sept. 1 to Sept. 27, 2007, indicated

that the ATSV air filter had been removed and replaced on the airplane on Sept. 17; the engine start switch had been changed on Sept. 19; and the ATSV had been replaced six times from Sept. 16 to Sept. 27, 2007 (the same period that the reported engine-start problems occurred.) ...

“The logbook review also revealed that the ATSV [maintenance] was deferred and put on the MEL [minimum equipment list] four times. The deferred status was canceled three times after maintenance was performed (ATSV changed), an operational check was made, and the automatic start sequence was deemed satisfactory. After the accident, American Airlines revised its engine

McDonnell Douglas MD-82



© James Wang/Flickr.com

The MD-82 is one of a series of jet transports that are derivatives of the Douglas DC-9, which first flew in 1965. The MD-80 has longer wings, a longer fuselage and more fuel capacity than the DC-9 and an integrated digital flight control system.

The prototype MD-80 flew in 1979, and the airplane entered production the following year as the MD-81. Production of the MD-82 began in 1981. The airplane, designed for operation at high-density-altitude airports, has Pratt & Whitney JT8D engines.

Production of a second version of the MD-82 began in 1982. The second version of the MD-82 has a greater maximum takeoff weight — 149,500 lb (67,813 kg), compared with the first version’s 147,000 lb (66,679 kg). Both versions have a maximum landing weight of 130,000 lb (58,968 kg).

The MD-82 has a two-pilot flight deck and can accommodate 172 passengers. Maximum cruise speed is 0.8 Mach. Normal cruise speed is 0.76 Mach. Maximum range with 155 passengers is 2,049 nm (3,795 km).

Source: *Jane’s All the World’s Aircraft*

ATSV MEL procedures to require that the air supply line from the ATSV be disconnected and that any of the disconnected lines be capped, which renders the ATSV actuating part inoperable and prevents inadvertent activation on takeoff.”

The airline’s maintenance program also included CASS, which is designed according to federal regulations as a risk management system that provides “a continuous cycle of surveillance, investigations, analysis and corrective action” aimed at maintaining consistently airworthy aircraft and ensuring that all maintenance action is performed in accordance with company manuals.

About four months after the accident, on Jan. 23, 2008, a similar ATSV incident occurred when another American Airlines aircraft was on climb-out from Salt Lake City. The crew returned to the departure airport, and an inspection revealed that there had been no fire but that the ATS was damaged and the filter element had separated from its base.

After that incident, the ATSV air filter assembly from the airplane’s left engine was sent to the manufacturer, PTI Technologies, and then to the NTSB Materials Laboratory for examinations, which found that part of the filter mesh was embedded in the internal threads and that some areas showed “severe rubbing damage.” NTSB examination of seven ATSV air filter assemblies from other American Airlines airplanes found that several were damaged. An examination of 15 assemblies by PTI found that most had minor “dents and dings”; in three, the filter mesh was torn; one filter had dents “consistent with impact damage”; and another had a damaged mesh pack side seal, the NTSB said.

Filter Had Disintegrated

The accident investigation found that the mesh in the accident ATSV air filter “had

disintegrated and that about 70 percent of the material was missing,” the report said.

The investigation also found that American Airlines maintenance personnel did not comply with the company’s procedures for cleaning ATSV air filters during maintenance checks.

“Maintenance records indicated that [the] filter-cleaning procedure had been accomplished on the accident airplane’s left engine ATSV air filter during the last C check,” the report said. “However, the fatigue and fretting damage observed on the accident ATSV air filter element, which had developed over a long period of time, was so extensive that it would have been clearly visible to the naked eye when the filter element was removed from its housing to perform the cleaning procedure, if the cleaning procedure had actually been performed during the previous C check. In fact, given the degree of fatigue and fretting damage, it is unlikely that it was checked in accordance with American Airlines’ procedures during the airplane’s last few C checks, despite what the maintenance records showed.”

Because of the inadequate cleaning, the damaged air filter was not detected, the report said.

The post-accident examination of the ATSV air filter also revealed that the deterioration of the filter mesh had allowed the end cap to separate and to move into a position where it “could block the airflow from the ATSV air filter to the ATSV ... and prevent airflow to the ATS, causing an intermittent engine no-start condition,” the report said.

The report added, “Because no failure of an ATSV air filter had ever been recorded, the condition was not recognized and therefore not properly addressed by maintenance personnel, which allowed an engine no-start to recur the morning of the accident.”

At that point, maintenance personnel used the prying device to push the ATSV manual override button. This procedure bent the manual override button’s internal pin, which allowed the ATSV to open during flight, causing the ATS to freewheel.

The uncommanded ATSV opening, combined with the freewheeling ATS, would have directed a stream of air at a temperature of 600 degrees F (316 degrees C) — and perhaps momentarily as high as 2,000 degrees F (1,093 degrees C) — into the engine nacelle; this could have been an ignition source, the report said. Fire damage precluded a determination of what type of combustible material was involved, although the report noted that it might have been oil, hydraulic fluid or fuel.

The report also criticized the CASS program for its failure to detect “maintenance procedures that were not in accordance with written manuals and guidelines.”

In addition, the report said that Boeing and PTI inspection criteria for the ATSV air filter are “inadequate to detect early-stage fatigue fractures in the outer mesh of the filter element” and that filter design precludes inspection of the inner mesh.

The report included eight safety recommendations to the U.S. Federal Aviation Administration, including one calling for a review of all uncommanded ATSV-open events in MD-80s and another to require Boeing to “establish an appropriate replacement interval for [ATSV] air filters installed on all MD-80 series aircraft” (ASW, 6/09, p. 8). 🌀

This article is based on NTSB accident report NTSB/AAR-09/03, In-Flight Left Engine Fire, American Airlines Flight 1400, Mc-Donnell Douglas DC-9-82, N454AA, St. Louis, Missouri, September 28, 2007. Adopted April 7, 2009.



Using Incidents to Prevent Accidents



Incident analysis on a global scale

IATA STEADES (the Safety Trend Evaluation, Analysis and Data Exchange System) features the largest database of de-identified incident reports available to the industry. Providing a secure forum for the sharing and analysis of safety data, STEADES can be used to develop a comprehensive list of prevention strategies for your organisation.

Integrate STEADES in your business

- Benchmark against comparable organisations
- Make better investment decisions by assessing specific safety issues
- Anticipate operational challenges at specific airports
- Determine whether your safety concerns are shared by others

Become part of a growing community of over 80 airlines that regularly share safety data.

Join STEADES

- Query the Global Incident Database
- Receive Trend Analysis Reports
- Benchmark your airline
- Share safety data

For more information, visit www.iata.org/steades



SMS on Wheels

BY THOMAS ANTHONY

For several years, we have sought to explain the safety management system (SMS) concept using the mental model of pillars. Yet, SMS still remains a mystery to many. This is not a reflection on SMS itself but rather on the ways we have sought to explain it.

Peter M. Senge, a senior lecturer at the Massachusetts Institute

of Technology and founding chair of the Society for Organization Learning, explains the function of mental models as follows:¹

None of us can carry an organization in our minds. ... What we carry in our heads are images, assumptions and stories. ... Our mental models determine not only

how we make sense of the world, but how we take action.

Our mental model of SMS is important not only because it organizes our understanding of SMS but because it directs the action we take and how we move forward with SMS.

With this in mind, let's take a look at the mental model created by the image



of pillars (Figure 1). Pillars are singular supportive components of structures such as buildings and temples. They are strong and often clearly identifiable. These positive characteristics of pillars are what led to their widespread use as a mental model for SMS. But, there are other characteristics of pillars that do not fit the concept of SMS. Pillars are static. They are not dynamic; they do not characterize motion or change. While they may be beautiful in structures such as the Parthenon, their function is to support something else. They do not describe the structure as a whole.

For these reasons, the mental model of pillars has taken us just so far with regard to understanding SMS.

What mental model works better? Wheels. SMS is like a system of wheels or gears, each of which causes the others to turn. Without each one functioning, none of them can turn. This mental model conjures a system in which each element influences the others and in which all the elements must work together for the system to function.

The three wheels of SMS are:

- Hazard identification;
- Risk analysis and assessment; and,
- Risk mitigation by involved management.

Hazard Identification

The first wheel represents all activities of an SMS whereby we collect information and data that help us identify hazards (Figure 2). These activities include hazard reporting systems available to all employees,

A new spin on understanding safety management systems.

Pillars Model of SMS

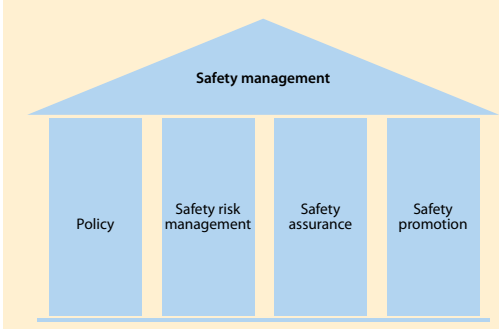

SMS = safety management system
Source: U.S. Federal Aviation Administration/Susan Reed

Figure 1

incident reporting systems such as an aviation safety action program (ASAP), the U.S. National Aeronautics and Space Administration Aviation Safety Reporting System (ASRS) or the U.K.

Hazard Identification, the First Wheel

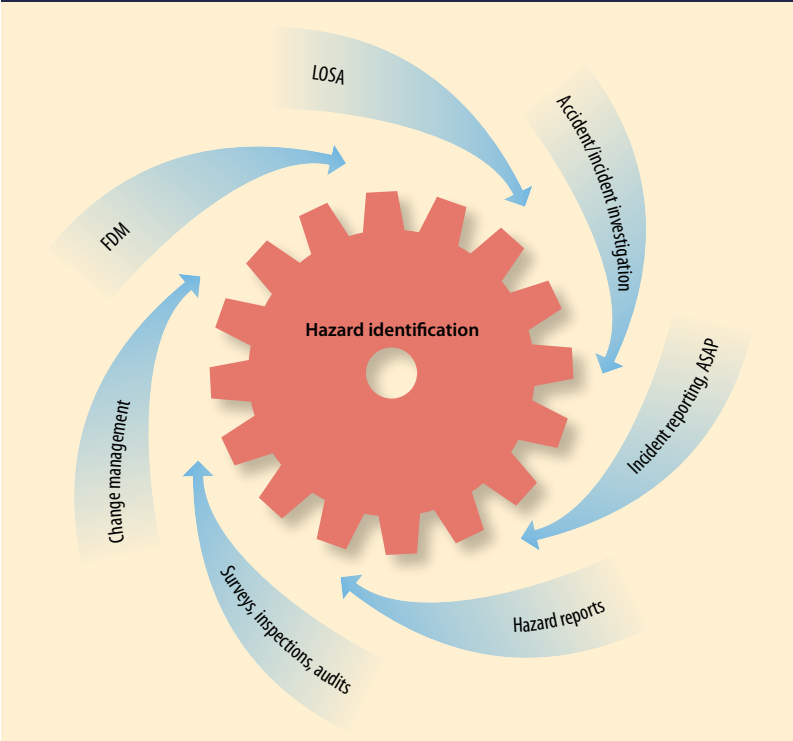

ASAP = aviation safety action program FDM = flight data monitoring
LOSA = line operations safety audit
Source: Thomas Anthony/Susan Reed

Figure 2

Confidential Human Factors Incident Reporting Programme (CHIRP), and flight data monitoring systems such as flight operational quality assurance (FOQA) programs.

Activities that collect information on hazards include surveys, inspections, tests and audits, such as the line operations safety audit (LOSA). These are conducted to identify hazards resulting from operations or performance that do not comply with established standards. The standards may be regulations, approved procedures or company procedures. There is little room for argument that noncompliant performance represents anything other than a hazard. In his research, David Huntzinger, now vice president of safety and security for Baldwin Aviation, has found that 60 percent of fatal accidents involved at least one instance of intentional noncompliance with procedure. Additionally, investigations are conducted to identify hazards that contribute to aviation accidents and incidents.

Finally, the hazard identification wheel includes the change management process. James Reason, professor of psychology at the University of Manchester, states, “Change in one guise or another is a regular feature of error-producing situations.” Aviation is inherently a dynamic and ever-changing industry that is constantly producing hazards even as it strives to reduce them.

All the activities that are part of the hazard identification wheel provide data on conditions that could result in accidents, incidents or loss in aviation operations. How important are these data-collection processes? Daniel Maurino, chief of the International Civil Aviation Organization (ICAO) Integrated Safety Management Section, stated it succinctly: “Without data, you don’t have an SMS.”

In judging whether an organization has adequate hazard identification channels, we can ask: Are there hazard reporting procedures available for all elements of the organization in which actions may create a hazard that contributes to the accident/incident causation chain?

In short, the hazard identification wheel is the SMS stage that includes all the processes we use to *collect* hazard information.

Risk Analysis and Assessment

The second wheel of the SMS model comprises an essentially different type of activity from hazard identification. In the risk analysis and assessment stage, we *process* the data that have been acquired in the first stage (Figure 3).

We begin by validating the hazard data to ascertain that the data are true and to gauge the extent to which the hazards exist. Then we analyze the information according to two criteria:

- How severe will the losses be if this hazard occurs?
- How likely is it that the hazard will occur?

So that this risk assessment is done properly, two more conditions must be met. First, a standard by which hazards are assessed is developed and adopted by the organization. This means that all hazards are assessed using the same measure. This is accomplished when an organization develops a risk assessment matrix upon which to base its decisions regarding *likelihood*

and *severity*. Second, however, is the necessity that the organization devote to the risk assessment process individuals who possess the knowledge and expertise necessary to make reasonable and knowledgeable assessments.

The risk assessment matrix is not a “file and forget” tool. It must be applied by high-performing and responsible individuals with expertise from each of the major areas of the organization. Why not say “all major *operational* areas of the organization”? Because hazards can be created by the budget department, the training department and by human resources. Hazards created by staff offices can be just as deadly as those created by flight operations. Several accident investigations have pointed out that management and administrative practices can present hazards that contribute to the accident causation sequence. Thus, individuals representing all major areas of the organization must participate, as part of the “Safety Action Group,” in risk analysis and assessment.

Just as risk assessment depends on hazard identification for data, it also depends on the third wheel, risk mitigation by involved management, to make available high-functioning and valuable employees to participate in the

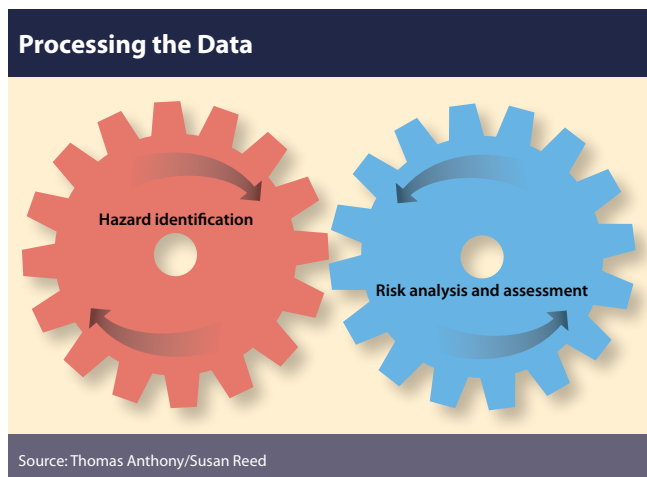

Figure 3

risk assessment process. Additionally, to achieve consistently balanced and objective assessments of risk, a management official with authority over the entire organization should serve as the safety advisor, or head of the Safety Action Group. The safety advisor is well placed as the secretary of the Safety Action Group to provide expertise, organization and guidance.

While the discussion of safety management in ICAO Annex 6, *Operation of Aircraft*, and Annex 14, *Aerodromes*, emphasizes top management's *accountability* for safety, what has been missing from the SMS discussion thus far is that participation in the Safety Action Group risk analysis and assessment process also presents a valuable *opportunity* for management. It is the opportunity to learn about issues that could have the most profound effect upon that particular organization: safety hazards.

Peter Senge, in his book *The Fifth Discipline*, shows how mental models determine how we see our organization, its mission and our role within the organization. Senge points to a study conducted by Royal Dutch Shell in 1982 which found that of the corporations that made up the Fortune 500 in 1970, one-third of them no longer existed in 1982. The reason for their extinction was in large part due to mental models that did not adapt to changing conditions.

To avoid the same fate, organizations must evolve to become *learning organizations*. Participation by top management in the Safety Action Group is an opportunity for shared learning among all significant elements of the organization. There is no quicker step on the route to extinction for an aircraft operator than a major accident. Beyond this, participation in the risk assessment process presents an opportunity to develop a shared vision that has safety as a core element.

It becomes a mechanism of learning for management, line and staff.

In applying the risk assessment matrix in large organizations that produce a great deal of data, it is desirable to use an automated information system to quantify and classify the hazard data and make initial assessments of risk.

Nevertheless, while it is important to classify and quantify the data being reviewed in the risk assessment process, a measure of judgment and perspective must be applied to the data. As an example, the number of aircraft hijackings that occurred in North America from 1991 to August 2001 was zero. Was it correct then to conclude at the end of that nearly 10-year period that the risk of a hijacking was near zero and therefore no additional mitigation measures were necessary? No, the 9/11 hijackings proved that such a conclusion was not appropriate. This level of judgment and perspective is best provided by management, that portion of the organization with responsibility over the entire organization.

Involved-Management Action

ICAO Annex 6, Part 1, Section 3.2.5, has it exactly right in stating:

A safety management system shall clearly define lines of safety accountability throughout the operator's organization, including a direct accountability for safety on the part of senior management.

Likewise, U.S. Federal Aviation Administration (FAA) Advisory Circular 120-92, Paragraph 8.b.(3), recognizes the essential character of management involvement and participation in the SMS process:

Management must plan, organize, direct and control employees' activities, and allocate resources to make safety controls effective. A key factor in both quality and safety management is top management's personal,

material involvement in quality and safety activities.

Management involvement in the safety process is the essential difference between today's SMS and the risk assessment processes of the past. It is through SMS that safety is granted full consideration among the other principal issues that demand top management's attention.

The third wheel in our SMS mental model is the stage in which action is taken to mitigate unacceptable risk as determined in the previous stage (Figure 4, p. 44). There are two preconditions for this stage to be effective. First, the same experienced and knowledgeable individuals must be involved in determining what mitigations will be (a) effective and (b) reasonable to implement. The second precondition is the involvement of top management, because top management has the power to allocate resources for the mitigations and has authority across all competing priorities of the organization.

The third wheel transmits the actions required to mitigate the hazards to the organization.

Lubri-Communication

For a system composed of wheels or gears to continue to operate, lubrication is required. In SMS, this lubrication is communication. Without the free flow of meaningful communication, the system will come to a grinding halt. *Communication* means not simply data, but the meaningful back-and-forth sharing of hazard and risk information.

Management has a special role in creating an organization that encourages the communication of hazard information. This is done by establishing a *reporting culture* and a *learning culture*. A reporting culture ensures a realistic flow of hazard information and data. A learning culture ensures that hazard/risk information generates

Management, the Driving Wheel

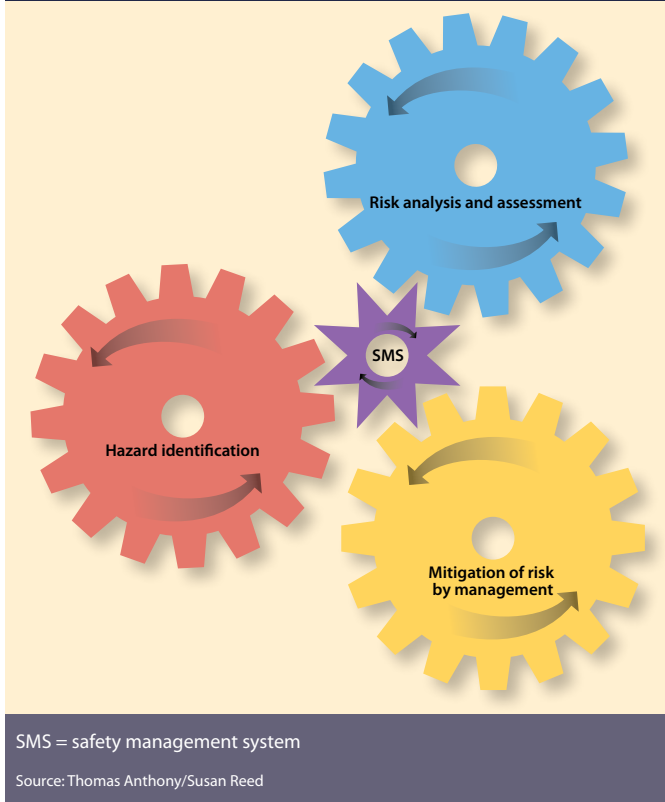

Figure 4

reasonable mitigation measures and that the organization internalizes what it has learned. A learning culture underwrites a viable organization. A learning culture is always asking, Why?

Management establishes a reporting culture both by authoring a safety policy statement that supports SMS and by advocacy and personal example. This means the modeling of behaviors, by example, that encourage the free flow of hazard information. A reporting culture cannot be established or sustained in an environment characterized by fear and reprisal.

Although an organization may possess all the component parts of an SMS, the system will have no positive effect unless there is communication. Communication is influenced by mental models. As Senge says, “Two people

with different mental models can observe the same event and describe it differently.” The perceptions differ because they are viewing the event from the perspectives of two different mental models.

In SMS, the communication intrinsic to the risk assessment stage and the risk mitigation stage forces representatives of different elements of an organization to analyze hazards from a

single basic perspective: *safety*. In this way, the SMS process stimulates the development of a shared mental model of safety within an organization.

Moving Forward

Wheels are made for movement. They are dynamic. They imply progress. They can interact with other wheels, create motion and keep turning. They are the means of moving forward.

The three wheels of SMS work in coordination with each other to produce effective organizational responses to hazards that are inherent and evolving in the aviation environment. The three wheels work together to *collect* hazard information, to *analyze* it in order to ascertain risk and then to *act* upon this assessment in mitigating unacceptable risk. All components of an

SMS fit into one of these three primary functions: collect, analyze and act.

For an effective SMS to continue operating, management must create, encourage and support a reporting culture and a learning culture within its organization. Management is the key. It is the driving wheel of the SMS, enabling the rest of the system to create risk mitigation measures.

Beyond the four safety management pillars shown in Figure 1, ICAO Annex 6 and Annex 14 identify the following five *standards* requiring that an SMS:

- Identifies safety hazards;
- Ensures remedial action necessary to maintain an acceptable level of safety;
- Provides for continuous monitoring and regular assessment;
- Aims to make continuous improvement; and,
- Clearly defines lines of safety accountability, including direct accountability for safety for senior management.

The wheels model integrates all these pillars and standards into three basic functions. It has the advantage of making a clear distinction between the *collection* activities and the *analysis* activities — that is, the hazard identification stage and the risk analysis and assessment stage. And it emphasizes the role of involved management as the driving wheel of SMS. 🚀

Thomas Anthony is director of the Aviation Safety and Security Program at the Viterbi School of Engineering, University of Southern California.

Note

1. Senge, Peter M. *The Fifth Discipline: The Art & Practice of the Learning Organization*. New York: Doubleday/Currency, 2006.

BY WAYNE ROSENKRANS

European operators of large business jets¹ can enhance their margin of safety during charter and corporate flights if they voluntarily set a policy and develop operations specifications on the use of flight attendants, an Austrian training specialist says. The temporary European civil aviation requirements now in effect² only specify carrying flight attendants in charter operations when the airplane has a passenger seating configuration of more than 19 passengers; operators are not required to

have a flight attendant for business aviation operations.

Commercial factors and ingrained cultural norms in these aviation segments sometimes have discouraged European companies and regulators from taking flight attendants seriously, says Brigitte Wieselthaler, head of training services at Jet Alliance Flight Training in Bad Vöslau, Austria. Jet Alliance conducts commercial operations using 32 Austrian-registered business jets. Any flight attendant employed by an airplane owner must meet Jet Alliance

training and currency requirements to fly as a crewmember on these aircraft.

Nearly five years after the chartered Bombardier Challenger 600 takeoff overrun accident³ at Teterboro, New Jersey, U.S., the possibility of such scenarios has attracted the attention of European pilot and flight attendant communities, Wieselthaler said. Two pilots and nine passengers mistakenly assumed that a cabin aide — a customer service representative provided by the operator and dressed in a “crew-member-appearing uniform” — was

Old World Habits

Training specialist advocates wider use of flight attendants in European business jet operations.



qualified to conduct the evacuation from the burning aircraft.

Some European crewmembers also are aware that the U.S. Federal Aviation Administration told U.S. charter operators they are responsible for “clearly identifying to passengers those crewmembers who are safety-qualified and those who are not ... [and ensuring that] passengers are aware that non-safety personnel are not trained or qualified to act in a safety-related capacity.” European cabin services often encompass various types of non-safety-qualified personnel — company representatives serving beverages, conducting customer relations or acting as language interpreters, for example — but current cabin safety principles recommend that these non-safety-qualified individuals be distinguished clearly as not equivalent to airline flight attendants, Wiesenthaler said. Of equal concern is that a flight attendant might be relegated to such a role rather than being assigned as a third crewmember, she said.

Getting Started

- Develop a policy on voluntary use of a flight attendant.
- Require a preflight safety briefing of all cabin personnel.
- Implement cabin communication items in pilot checklists.
- Establish company duty time and rest hours for every crewmember.
- Ensure competence on doors, exits and emergency equipment.
- Explain to passengers the flight attendant’s emergency role.
- Prevent misidentification of non-safety-qualified passengers.
- Encourage pilots and flight attendants to express safety concerns.
- Consider cross-training pilots as flight attendants.

— WR

“A ‘company representative’ is more or less a passenger with the right to serve food and drinks,” Wiesenthaler said. “Downgrading a flight attendant is ridiculous, but often has been done because a company representative not recognized as a crewmember doesn’t have the duty-time limitations of a pilot and is not part of the chain of command.”

In the 1990s, Wiesenthaler moved from a job as a handling agent in business aviation at Vienna International Airport to a flight attendant

position with Austrian Airlines, where she worked for nearly seven years. Later, she spent two and a half as a flight attendant for a business aviation operator, mostly flying long-range trips; she then was a classroom trainer. She also worked for a year in flight operations management for another business operator.

“The first eye-opener in my career was my change to airline operations,” Wiesenthaler recalled. “I was impressed by what it means to be a well-trained flight attendant and by my own self-confidence.”

The second eye-opener, when she left the airline, was the weak approach to cabin safety prevailing among some European operators of business jets. “My airline attitudes met old habits that had not really changed in business aviation,” Wiesenthaler said. “I was shocked by the mindset of my colleagues and the management. They stuck to an ‘official’ culture that said it was sufficient having any good-looking person as a so-called ‘flight attendant.’”

Two days after her return to business aviation, a dispatcher called and asked her to fly a 2.5-hour trip from Vienna but provided hardly any details. Declining to answer any questions about the aircraft type, its location, the destination, passenger needs or how to contact the pilots for a pre-flight briefing, the dispatcher reminded her, “Actually, we do not need a flight attendant.”

“I finally found the airplane in a hangar three hours before the flight, but they had not told me exactly how to open the door,” Wiesenthaler said, noting that trial-and-error force against a handle succeeded. “When I entered the airplane, I thought I would have to check the emergency equipment as I had done at the airline. On this airplane, I didn’t know where it was or where it should be. So I used a passenger safety briefing card to find and check the emergency equipment.

“I found the pilots in a nearby restaurant and requested a preflight briefing. They replied, ‘You want what?’ We had turbulence after takeoff but when I told the pilots I had secured the cabin in response, as at the airline, they were deeply uninterested.”

Later, however, the pilots told her, “It would be very good to write down what you did as cabin procedures and get them implemented within the company.” In time, she found more pilots, flight attendants and non-safety-qualified personnel open to discussion of adopting other cabin safety practices based on airline methods.

Setting a policy on flight attendants seems to be gaining acceptance elsewhere, at least based on an uptick in demand for flight attendant training and assignments from clients in Romania, Russia and Ukraine. “The mindset is changing, and it also is good to see that more European cockpit and cabin crews are demanding such training,” Wieselthaler said. “Today, I often train pilots who are operating without a flight attendant, and they are aware they cannot do that much when they have to fly the airplane into challenging airports such as Samedan Airport, St. Moritz, which is located in the Swiss Alps.⁴ They have a lot to do, and may not have enough time to secure the cabin. Nevertheless, they are responsible.”

Communication can break down for lack of flight attendant-related items in the manufacturer’s guidance on flight crew checklists, with no information passed to the flight attendant to prepare for takeoff, for example. “I often have not even known that we were taking off except by hearing the sound of the engines,” she said. “Joint crew resource management procedures and training help. Pilots may have thousands of hours but not one hour in airline operations, and they are not used to working with a flight attendant.”

When no flight attendant can be assigned to a trip, her preferred alternative is formal training for frequent travelers. “We are now trying to invite customers to train with us to get an idea of the duties of the aircraft crew,” she said.

The greatest challenge in this type of flight attendant training is airplane cabin, door and emergency equipment diversity. “We train a flight attendant on one airplane at a time, and do all the training on that airplane; one cabin mockup would not be enough,” she said.

Door exercises require the maintenance department to allow the subject airplane with a

maintenance technician aboard to be repositioned to Vienna, and post-training cabin door checks by the technician later are required to release the airplane to flight operations. “Training devices for all doors and emergency equipment would make training much easier,” Wieselthaler said.

Many customers have not realized that a measure as simple as having a flight attendant aboard improves cabin safety and accident survival, but once educated, they are more amenable to paying for a flight attendant and, alternatively, to participating in training, she added. ➤

Notes

1. Flight Safety Foundation auditors have found that U.S. corporate/charter operators typically consider voluntarily assigning a flight attendant only when they operate a cabin class airplane, and some specify that the third crewmember will be aboard whenever logistically appropriate in an airplane with a wide cabin and flat floor.
2. From July 2008 until a target date of 2012, European Commission Regulation 8/2008 applies to commercial air transport in airplanes for operators based in European Union member states under a law known as EU-OPS 1 on the harmonization of technical requirements and administrative procedures.
3. U.S. National Transportation Safety Board. “Runway Overrun and Collision, Platinum Jet Management, LLC, Bombardier Challenger CL-600-1A11, N370V, Teterboro, New Jersey, February 2, 2005.” Accident Report NTSB/AAR-06/04, Oct. 31, 2006. The accident and its cabin safety ramifications have been discussed in *ASW*, 3/07, p. 30; *ASW*, 10/07, p. 38; and *ASW*, 7/08, p. 40.
4. A fatal runway excursion accident occurred at 1614 local time on Feb. 12, 2009, at this airport involving a Dassault Falcon 100 operated by Laret Aviation. Two pilots were killed and one passenger survived; the airplane was destroyed, according to preliminary information gathered by the Aviation Safety Network.



Wieselthaler

“I often have not even known that we were taking off except by hearing the sound of the engines.”

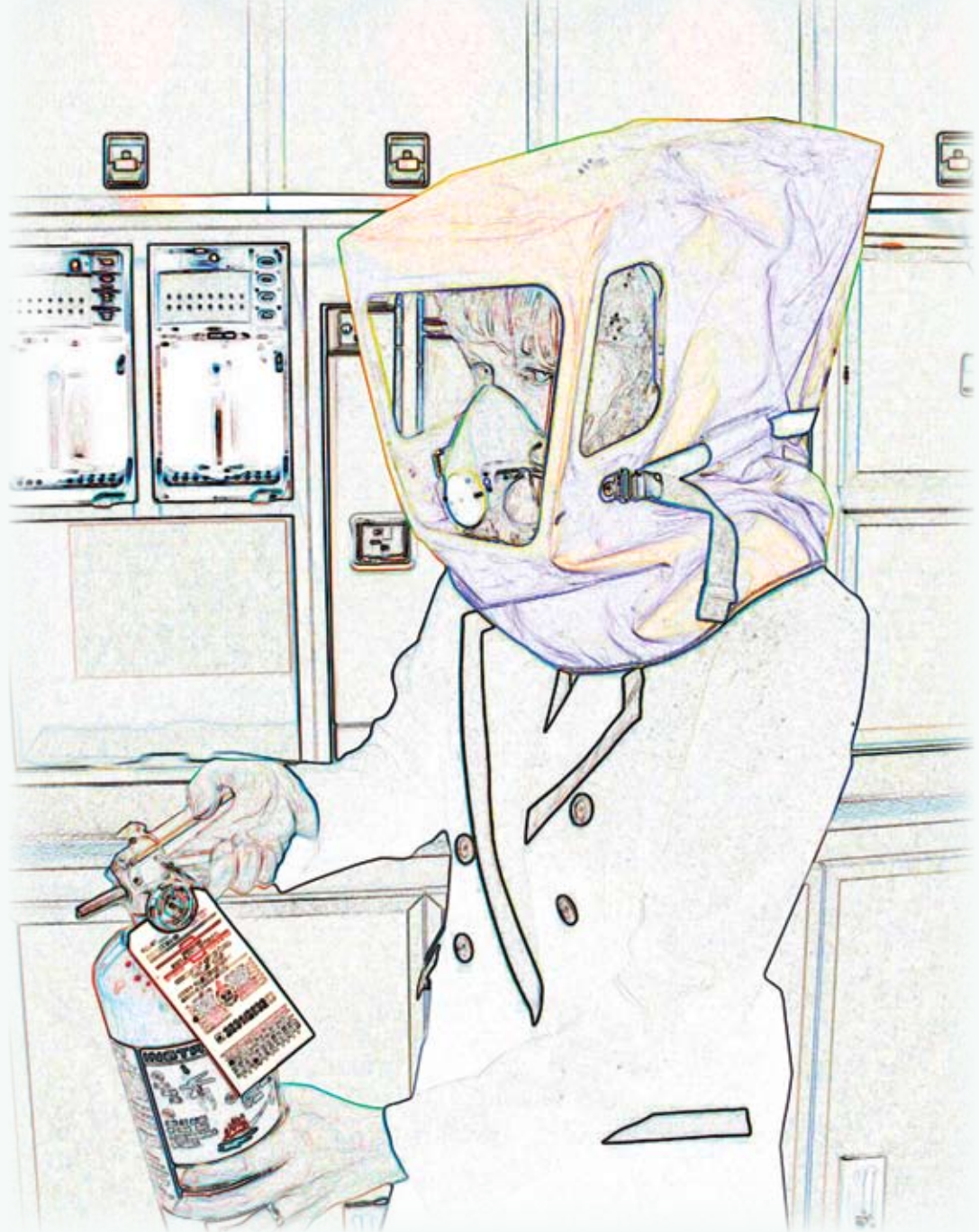

BY RICK DARBY

Fire Away

A survey suggests crewmember skepticism about firefighting training.

Personnel who had experienced an aircraft fire were less convinced about the efficacy of firefighting training than those without similar experience, according to a survey conducted for the U.K. Civil Aviation Authority (CAA).¹

“The broad objectives of this study were to evaluate current and possible future issues, and identify potential improvements to existing fire training in order to ensure that cabin crew have the most appropriate training and procedures to match current and likely future

B/E Aerospace adapted by Ann Mullikin

fire threats,” the CAA report says. An online survey was conducted using a Web page, with cabin crewmembers, flight crewmembers and safety instructors as the majority of respondents. Results were obtained from 66 countries, but because of various factors that made comparisons from different countries problematic, only those from the United Kingdom were analyzed in detail.² All data in this article represent U.K. respondents.

The vast majority, 91 percent, had no experience with in-flight fire; 3 percent had witnessed an in-flight fire; and 6 percent had been involved in fighting an in-flight fire. Most, including 84.4 percent of those without in-flight fire experience and 73.3 percent with in-flight fire experience, said in answer to a survey question that they believed the amount of time spent on theoretical training in fire-fighting was sufficient.

In answer to a question on practical training, 41.4 percent of respondents without in-flight fire experience thought the duration was too short, 56.4 percent thought it was sufficient and 1.5 percent rated it too long. A higher proportion of respondents with in-flight fire experience, 51.4 percent, thought it was too short.

Other questions were based on a rating scale, in which respondents indicated agreement or disagreement with various statements. The scale was from “strongly disagree,” assigned a value of -2, to “strongly agree,” assigned a value of 2. The responses were averaged for each group — those with fire experience and those with no fire experience. The average reflected the group’s overall attitude or perception concerning the statement. For example, an average of 1.5 can be understood as general agreement, although less than strong agreement.

The highest percentages of “agree” responses were for the statement that “the fire training equips cabin crewmembers to extinguish any fire visible in the cabin.” More than 50 percent of the respondents with firefighting experience — the experienced group — and more than 60 percent of those who had no firefighting

experience — the inexperienced group — agreed. In both groups, strong agreement was expressed by about 20 percent.

Less confidence was indicated for more-complex scenarios.

To the statement, “The fire training equips crewmembers to extinguish a fire behind the cabin panels,” the experienced group and the inexperienced group had similar rating averages, 0.41 and 0.4, respectively. That is, both groups agreed to a small extent with the statement.

Similarly, both groups had an overall negative response to the statement, “The fire training equips crewmembers to deal with multiple fires occurring at the same time” (Figure 1). But the experienced group was more dubious.

To the statement, “The training for the management of passengers in the event of in-flight fire is adequate,” the experienced group mildly disagreed with an average of -0.12, while the inexperienced group agreed weakly, with an average of 0.23.

Less confidence was indicated for more-complex scenarios.

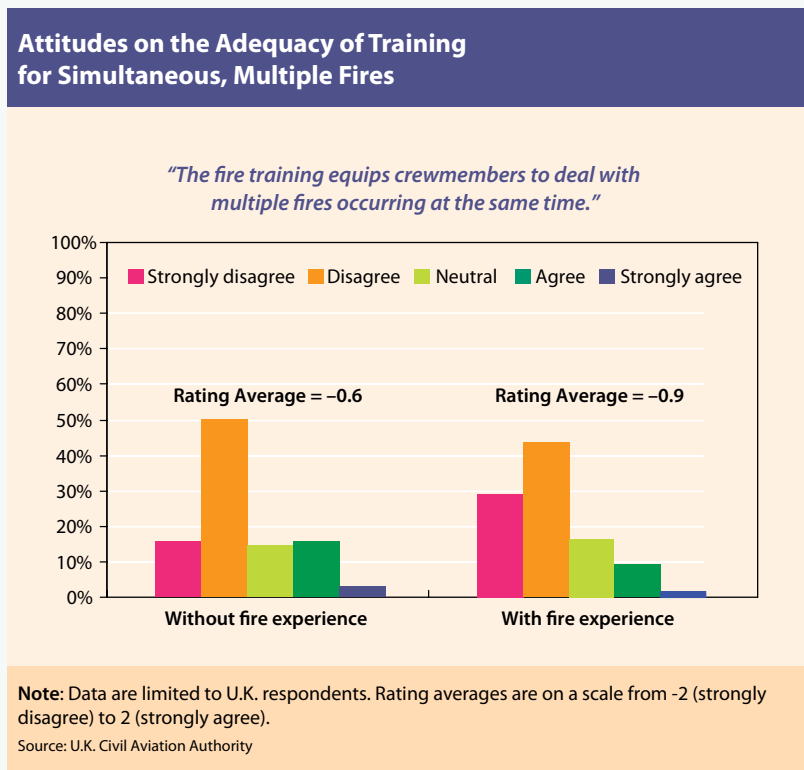

Figure 1

Frequency of Practical Fire Training

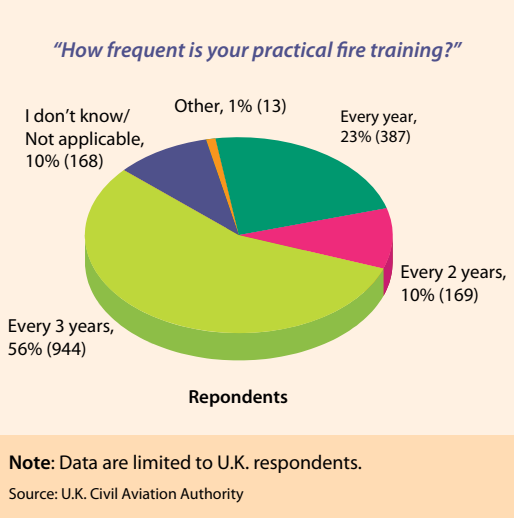

Figure 2

The survey asked respondents how frequent their “practical” fire training had been (Figure 2). The largest proportion, 56 percent, reported they had undergone such training every three years. “Every year” was a more common response than “every two years.”

Respondents were presented with the statement, “The time between practical fire training is such that crewmembers remember everything taught in the training within that period” (Figure 3). Among the inexperienced group, those who received training every year averaged a greater agreement than those who were trained every two or every three years, although in no case did the average rise to an unqualified “agree” score of 1.

For the experienced group responding to the same statement, the averages showed less agreement (Figure 4). The annually trained members of the group had the most favorable opinion of their ability to recall all the practical training.

“Respondents were asked about their perception [of] the realism of fire conditions during their practical training,” the report says. “This was obviously very dependent on their operator/training provider’s training practice and facilities, which might contribute to the polarity of the responses seen in the distributions” (Figure 5).

Attitudes on the Efficacy of Practical Fire Training, Inexperienced Groups

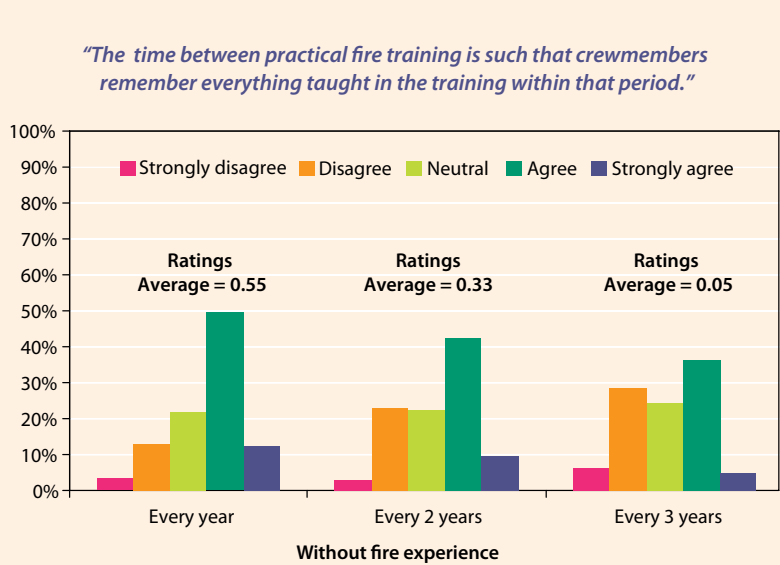

Figure 3

Attitudes on the Efficacy of Practical Fire Training, Experienced Groups

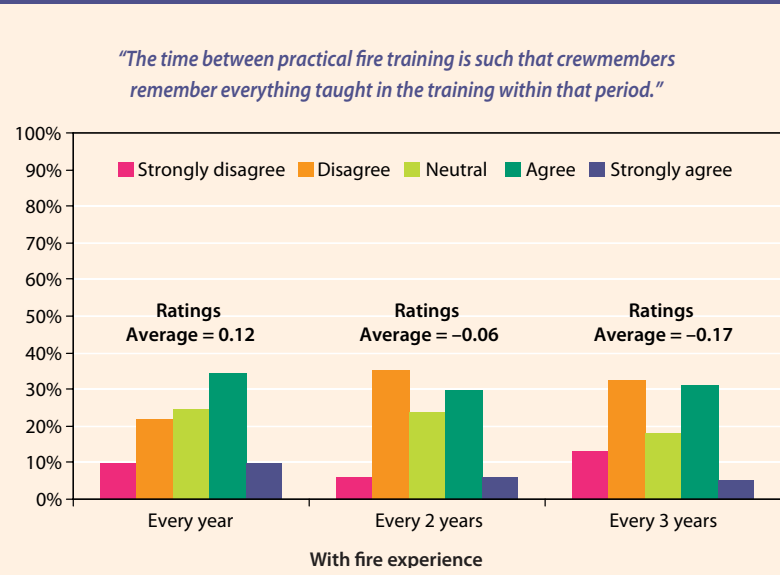
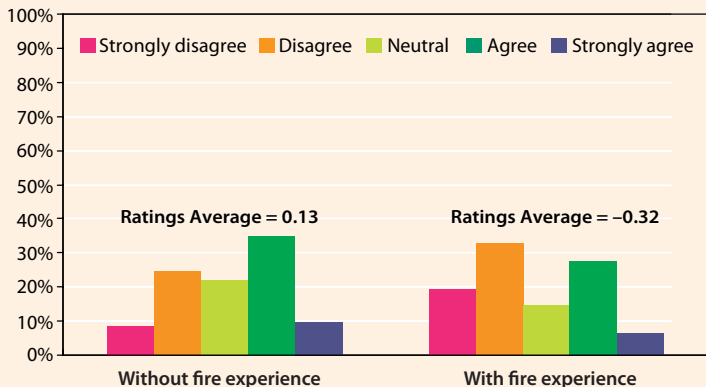

Figure 4

Attitudes on the Realism of Fire Conditions During Training

"The fire conditions experienced during the training are realistic."



Note: Data are limited to U.K. respondents. Rating averages are on a scale from -2 (strongly disagree) to 2 (strongly agree).
Source: U.K. Civil Aviation Authority

Figure 5

Attitudes on the Realism of Smoke Conditions During Training

"The smoke conditions experienced during the training are realistic."

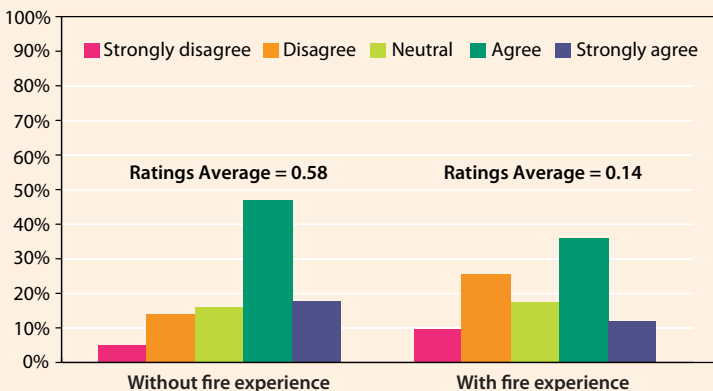

Note: Data are limited to U.K. respondents. Rating averages are on a scale from -2 (strongly disagree) to 2 (strongly agree).
Source: U.K. Civil Aviation Authority

Figure 6

The respondents' attitudes on the realism of smoke conditions during training were positive overall (Figure 6). Again, the inexperienced group was most in agreement.

Besides the numerical scales, the survey included comments from respondents.

A cabin crewmember said, "It is a little unrealistic to simulate a fire from an overhead locker with red/orange LEDs [light-emitting diodes] and lots of smoke."

"Simulating a fire can only go so far, for various reasons including health and safety and a duty of care," said a training manager.

A flight crewmember said, "Briefly handling an extinguisher once a year, and squirting one every three years is insufficient to retain any practical skill — particularly when such ability is to be used under pressure."

A cabin crewmember said, "Practical [exercises] seem to center around toilet and oven fires. I think our practical training for these types of fires is good, but fires behind panels are covered theoretically only."

"Comments indicated that there was a high variability in the standard of training facilities," the report says. "Some fire training facilities involved open-air constructions bearing very little resemblance to an aircraft cabin."

Some comments suggested that fire training should include more than just firefighting techniques — for example, "the communication/coordination procedures and other aspects such as locating [the] fire, locating and removing firefighting equipment, and passenger management. Respondents also suggested training in firefighting while using the appropriate protective equipment such as fire gloves and [protective breathing equipment]."

Some respondents thought a prescriptive chain of command, such as "Firefighter — Assistant Firefighter or Coordinator — Communicator" was too rigid: "It was suggested that it might dissuade cabin crew from using their common sense and judgment."

Notes

1. Asmayawati, Saryani; Butcher, Nicholas; Cherry, Ray. "Cabin Crew Fire Training." U.K. CAA Paper 2009/01. April 2009. Available via the Internet at <www.caa.co.uk/docs/33/2009_01.pdf>.
2. The report notes that self-selection bias should be taken into account, because "those having strong views [were] more likely to respond than those who were less concerned."

Flight Blight

Air rage isn't limited to 'crazy' passengers.

BOOKS

What Goes Around

Anger in the Air: Combating the Air Rage Phenomenon

Hunter, Joyce A. Farnham, Surrey, England, and Burlington, Vermont, U.S.: Ashgate, 2009. 238 pp. References.

On Aug. 25, 2009, “a ‘disturbed man’ on board a Qantas flight from London Heathrow tried to open an emergency exit door as the aircraft approached Sydney [New South Wales, Australia],” a report in the London *Daily Mail* said. “Terrified travelers watched as the man is said to have lunged for the door in the middle of the economy seating area, before cabin crew were able to restrain him. The airline, which confirmed there had been an unruly passenger, denied the man had reached the door, but a passenger on board the 747 jet claimed he grabbed the handle and tried to turn it.”

It would have been physically impossible for the man to open the door with the cabin pressurized. Nevertheless, the need to forcibly restrain a passenger probably left the flight attendants emotionally shaken, and could have resulted in their being injured. The incident happened shortly before the approach and landing, critical phases of flight. Had they been needed in an emergency, the cabin crewmembers might have been in less than optimal condition.

“Air rage has already left airline [flight] attendants with stab wounds, bruises, internal bleeding, torn kneecaps and a broken back and neck,” Hunter says.

Despite airliner cockpit doors being hardened since 9/11, air rage still poses a flight safety risk — as well as a risk to flight attendants and passengers.

Anger in the Air examines the forces that have led to what Hunter believes is a dysfunctional

air travel system that creates psychological and emotional pressures on passengers as well as airline employees. The sources of pervasive stress, Hunter says, are airline policies toward customers and toward their own personnel, as well as passengers’ psychological problems.

Perhaps the single most important lesson here is that air rage behavior is not limited to the occasional psychotic person who boards. Sometimes even “normal” people can act in ways that their self-control would otherwise prevent.

This is a disturbing book, partly from accounts of so many air rage incidents, each seemingly more bizarre than the last. Of course, they are sampled from millions of flights, and the chance of encountering a serious incident on any given flight is slim. Still, the reader who doubts that air rage incidents are an ever-present danger is likely to be convinced otherwise.

More alarming than the descriptions of passengers losing control, however, is the conclusion that is hard to avoid: Rage is partly a product of conditions in the airline industry.

Hunter quotes airline consultant Michael Boyd: “What airlines must understand is that this is not some external societal problem that has now spilled onto the departure concourse. It is essentially a situation that is partially — indeed, predominantly — within the airlines’ control.”

But what is sometimes forgotten about passengers’ discomforts and privations is that the stress does not begin with boarding. Airport stressors also get on everyone’s nerves. The sight and sound of crowds, the distances between terminals, the repetitive security warnings on the loudspeaker, and the attention-seeking design of stores and restaurants take a toll on whatever peace of mind the traveler began the journey with.

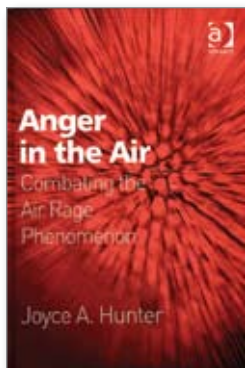

Even in the waiting area at the gate, once past the dreaded security screening, television monitors with restless images and dozens of people talking on mobile phones make it hard to relax. Throw extra waiting time for a delayed flight into the mix, and by the time the passenger finally struggles into a cabin seat, he or she may be primed with annoyance and frustration.

Fliers, especially those who remember air travel in its calmer days, can be shocked by the sometimes rude or impersonal behavior of airline employees. Undoubtedly most employees would like to be pleasant and helpful, and many are. But, Hunter says, “If customer complaints are any measure, airline personnel are suffering from a bit of air rage themselves.”

An airline flight attendant is quoted saying, “Far too many of America’s airline employees are shell shocked, depressed, disillusioned and resentful. In effect, we’re now an industry full of employees going through post-traumatic stress and wondering why we ever thought it was fun. And that, in a nutshell, equates to bad and insensitive service with a ‘who cares’ attitude.”

Hunter says, “Customers want to feel valued, employees want to feel valued — and airline management wants to drive profits. Airlines often act as if these were mutually exclusive goals, as if the only way to make a profit were to demean and undervalue their staff.”

Employees also have to enforce airlines’ rules. “They are the ones on the front lines where painful policies meet angry passengers, where a harried mother finds out it will cost an extra \$50 to take her child’s baby seat on the plane or when the family delayed by a snow-storm finds out their seats have been given away because they’ve arrived two minutes past an arbitrary deadline,” Hunter says.

If passengers and airline personnel feel aggrieved for their own reasons, they are tempted to take it out on each other, having no other target available. If they do, the feedback loop contributes more tension.

“We do know that the upward spiral of hostility between employees and passengers can erupt into sabotage,” Hunter says. She cites

a reporter who wrote that “some rogue ground personnel are known to take revenge on passengers who have inconvenienced them by mis-tagging their luggage so it gets sent to the wrong city, reseating them by the bathroom or in a worst-case scenario, getting them kicked off their flights.”

As in any population, a small percentage of passengers suffer from a mental disorder that would cause them to act inappropriately or dangerously regardless of how they are treated. But many people who express air rage would be considered normal — under normal conditions.

Some are taking medications that can have unusual effects in the cabin-air pressure equivalent to 8,000 ft altitude. The smokers experience nicotine withdrawal symptoms for hours. Some passengers are afraid of flying under the best of conditions, let alone in bad weather or turbulence, and anxiety can make even a reasonable or regulatory-based request from a flight attendant seem threatening.

Hunter says that partial oxygen deprivation is a factor in some air rage episodes. “To work properly, our brains need a certain amount of usable oxygen in our bloodstreams,” she says. “Unfortunately altitude, alcohol, smoking and toxic chemicals all reduce that oxygen level The symptoms of hypoxia range from headaches, nausea, thirst, irritability, rage, sexual excitability and loss of judgment and control to, at the extreme, seizures, paralysis, coma and death.” Other complaints about cabin air are said to be traceable to heated oil and hydraulic fluid fumes leaking into the cabin.

Then there is the issue of alcohol served to passengers.

“Most air rage stories start, ‘When a flight attendant refused to serve him more liquor . . . ,’” Hunter says. “At least 40 percent of all air rage incidents are the result of a passenger getting drunk.” A fairly typical incident was described as follows: “In March 2005, a 35-year-old man was heard swearing as he stumbled onto a flight from Denver to Anchorage, and the pilot notified him that he would not be served any more alcohol during the flight. When the flight attendant later refused to give him a drink, he

Anxiety can make even a reasonable or regulatory-based request from a flight attendant seem threatening.

went on a rampage through the plane, urinating on the floors and breaking trays.”

The lower air pressure of the cabin magnifies the effect of alcohol. So does the lack of food on many flights. So does the combination of alcohol with drugs, including legal prescription or over-the-counter medicines.

Why not just refuse to serve alcohol on planes? Most people who have studied the issue believe that would be trading one set of problems for another. Columnist and pilot Patrick Smith, quoted by Hunter, says, “It seems an easy call: Lock away the liquor and episodes of airborne assault are cut by nine-tenths. Except it’s never so simple. In the absence of alcohol, a portion of those predisposed to belligerence will find other excuses to rant, rave and break things.”

It also seems unfair, and another potential contributor to air rage, to deny the majority of well-behaved, responsible passengers a drink or two.

“The first step towards preventing air rage is realizing that there are three different types of offenders, and we need a different approach for each,” Hunter says. The most common type of air rage is from passengers who explode in anger because of perceived bad service. Though rude and upsetting to cabin crewmembers, they are not in the same category as “disruptive” and “unruly” passengers whose acting out goes beyond the verbal. The third category of offender, and fortunately the rarest, consists of “deranged passengers who are incapable of knowing what they’re doing because they’re blind drunk, on drugs or psychotic.”

She believes most of the air rage in the first category could be reduced by better customer service. She says, “To reduce the most common forms of air rage, airlines need to (a) create a happier atmosphere on board by improving the ‘tangibles’ of the flying experience like crowding and lateness; (b) reduce the sense of cynicism and anonymity among passengers; (c) give passengers realistic expectations of their flight quality and a clear picture of the good behavior that is expected of them on board; (d) prevent intractable ragers from boarding airplanes in the first place and (e) hire, train and support high quality front line employees so they can prevent problems, foster a

positive customer experience, defuse rage and, if all else fails, subdue offenders.”

She says the kind of airline employees who are best at benevolent crowd control “communicate well, listening, asking questions and seeking clarification, providing information and remaining sensitive to people’s need to understand what’s going on.”

That makes sense; unfortunately, it is a picture of the ambience of the airline industry 50 years ago, before mass air travel and price competition. It seems unlikely that the industry can restore that kind of relationship between airlines and customers unless the structure and assumptions of the business change radically.

There is no mystery about the causes of air rage. The mystery is why industry management, employee associations and passenger groups do not get together to change the air travel experience. Taking into account the direct and indirect costs of air rage to airlines — diverted flights, employee physical and emotional injury, lawsuits, and turnover in personnel who just can’t take it any longer — it might even be cost-effective.

— Rick Darby

WEB SITES

A Specialized Reporting System

Aviation Safety Communiqué (SAFECOM),
www.safecom.gov

Aviation Safety Communiqué (SAFECOM) is a voluntary reporting system, similar to the U.S. National Aeronautics and Space



Administration Aviation Safety Reporting System, for agencies of the U.S. Department of the Interior (DOI) and the U.S. Forest Service. “SAFECOMS are an accident prevention tool for everyone associated with DOI and U.S. Forest Service aviation operations,” says the Web site.

Government personnel and contract vendors report aviation mishaps as they occur using the SAFECOM system. Reporting categories include incidents, hazards, maintenance and airspace. Data submitted on reporting forms are added to the SAFECOM database to share information about problems that could cause — and solutions that could prevent — aviation-related accidents or incidents.

The searchable database allows users to search by event or mission details; aircraft type (airplane or helicopter); model and manufacturer; description of occurrence; and more. Search results link to full-text SAFECOM reports containing complete information on events, including mission details, narrative of the mishap and corrective action undertaken or recommended.

The Web site and safety alerts about the system emphasize that “the SAFECOM system is *not* intended for initiating punitive actions. Submitting a SAFECOM is *not* a substitute for ‘on the spot’ correction(s) to a safety concern. It is a tool used to identify, document, track and correct safety-related issues. A SAFECOM *does not* replace the requirement for initiating an accident or incident report.”

— Patricia Setze

Resources for Charters

Air Charter Safety Foundation, <www.acsf.aero>

The Air Charter Safety Foundation (ACSF), a member-supported safety organization, says, “The ACSF vision is to continuously enhance the safety and security practices of charter and shared aircraft owners and operators in the United States and worldwide.”

At its 2009 symposium, ACSF announced its “Top 10 Safety Action Items” for the current year. The first three action items — implementation of safety management systems (SMSs), industry use of risk assessment tools and addressing the risks of unstabilized approaches — were highlighted in

symposium sessions. Select presentations from this safety symposium may be viewed online or downloaded at no cost. Presentations include “SMS Implementation,” by William R. Voss, Flight Safety Foundation

(FSF) president and CEO, and “Safety Consequences of Unstable Approaches,” by James M. Burin, FSF director of technical programs.

The organization has made a considerable amount of information available to non-members at no cost through its Web site. The resource page identifies SMS guidance materials available from the International Civil Aviation Organization and the U.S. Federal Aviation Administration (FAA), articles on various SMS topics and presentations from the FAA-industry SMS focus group. Most of the resources listed contain Internet links to free, full-text documents.

Articles from ACSF newsletters and other resources contain information of interest for members and non-members. Most articles include Internet links to additional resources in full-text, such as FAA and other original-source documents.

ACSF says it developed the Industry Audit Standard “to set the standard for the independent evaluation of an air charter operator’s and/or shared ownership company’s safety and regulatory compliance.” Integral audit documents — the “Operator Standards Manual” originally released in 2008; subsequent updates; appendix A, containing standards with guidance; and appendix B, a regulatory cross-reference index — may be read online or downloaded at no cost.

Owners and operators governed by U.S. Federal Aviation Regulations Part 135 and Part 91K have free access to the AVSiS Aviation Safety Information System software program “that collects detailed safety event data for analysis, response deployment and success measurement, and provides a tool for accounting for the cost savings realized by interventions,” ACSF says.



— Patricia Setze

Running on Fumes

The main fuel tanks were nearly empty when the crew realized their mistake.

BY MARK LACAGNINA

The following information provides an awareness of problems in the hope that they can be avoided in the future. The information is based on final reports by official investigative authorities on aircraft accidents and incidents.



JETS

Center Tank Switches Overlooked

Boeing 737-400. No damage. No injuries.

Stress, fatigue, inadequate crew coordination, systems differences and a vague checklist were among the safety issues identified by the Australian Transport Safety Bureau (ATSB) in an incident that brought the 737 uncomfortably close to fuel starvation near Swan Hill, Victoria, the morning of Aug. 11, 2007.

The aircraft had departed from Perth, Western Australia, at 0544 local time for a scheduled passenger flight to Sydney, New South Wales. About 2 hours and 40 minutes after takeoff, the aircraft was 50 km (27 nm) northwest of Swan Hill at 31,000 ft when the master caution light and a caution light for low output pressure from the main tank fuel pumps illuminated. The engines were being fed from the main tanks, each of which contained only about 100 kg (220 lb) of fuel while 4,700 kg (10,362 lb) of fuel remained in the center tank.

“The pilot-in-command observed that the center tank fuel pump switches on the forward overhead panel were selected to the ‘OFF’ position, and he immediately selected them to the ‘ON’ position,” the ATSB report said. With the center tank feeding the engines, the flight was completed without further incident.

The estimated fuel consumption for the flight was 9,900 kg (21,826 lb). On departure from Perth, the aircraft had about 13,700 kg (30,203 lb) of fuel, including about 4,500 kg (9,921 lb) in both the left and right main tanks, and 4,700 kg in the center tank.

The flight crew had completed two previous flights in a 737-800 that had a different fuel system and fuel control panel than the 737-400 assigned to the flight to Sydney. The -400 had a deactivated auxiliary tank in the aft fuselage and an extra set of fuel pump switches, labeled “INOP” and secured in the “OFF” position, on the fuel control panel. “The center tank fuel pump switches on those other 737 aircraft were located in a similar position to the auxiliary tank fuel pump switches on [the incident aircraft],” the report said.

The center tank fuel pumps must be activated before departure when fuel load exceeds 9,000 kg (19,841 lb). There are no annunciations showing the operating status of the center tank pumps; the only indication is switch position.

Checks of the fuel control panel are among the items included in the “Before Start” checklist and in the standard procedures to be conducted at the top of climb. The copilot told investigators that he looked at the panel both times but did not notice that the center tank pump switches were off. “The pilot-in-command did not provide effective monitoring of the actions of the copilot,” the report said. “There was no cross-check.”

The “Before Start” checklist specified only “pumps on.” It did not “distinguish between the various fuel pump selection options,” the report said. “[Furthermore,] the checklist procedure

did not require flight crew to touch the switches of the fuel pumps to ensure that they were aware of the position of the switches.”

Neither pilot adequately monitored the fuel load during the flight. “Had the copilot or pilot-in-command been monitoring the fuel gauges, they would have realized that the large quantity of fuel in the center tank was not being used,” the report said.

The incident occurred on the last day of a four-day trip sequence. Although adequate rest periods were provided, the pilot-in-command did not fully use them and likely was suffering from fatigue related to sleep deprivation, the report said. “The pilot-in-command also was suffering from chronic stress [from an ongoing divorce and financial problems related to the divorce], and it is probable that this stress affected his ability to operate as a pilot-in-command without him being aware of this.”

Late Flare Leads to Hard Landing

Airbus A320-321. Substantial damage. No injuries.

The aircraft was en route from London on an unscheduled flight to Kos, Greece, the morning of July 5, 2007. There were 180 passengers and six crewmembers aboard, including a line training captain and a cadet copilot, who had 381 flight hours, including 147 in type.

“During the preflight briefing, the commander decided that the copilot should be the pilot flying (PF) for the sector to Kos, where it would be possible for him to carry out a managed approach to fulfill an outstanding training requirement,” said the U.K. Air Accidents Investigation Branch (AAIB) report. “In a managed approach in the A320 aircraft, the flight management guidance system directs the aircraft onto the final approach via the autopilot and autothrottle.”

After departure, the crew flew a holding pattern at 10,000 ft for 45 minutes while resolving an engine bleed-air malfunction. “As the fuel remaining following the hold was now insufficient to continue to Kos with the required reserves, a decision was made to divert to Thessaloniki, where the copilot carried out a manual landing without incident,” the report said.

After refueling, the copilot remained the PF for the continued flight to Kos. The island airport had visual meteorological conditions (VMC), with surface winds at 10 kt from 300 degrees, variable between 190 and 300 degrees. “Runway 32 was in use, and the crew briefed and prepared to fly the VOR/DME [VHF omnidirectional radio/distance measuring equipment] approach using the autopilot,” the report said.

The crew established visual contact with the runway early in the approach, and the copilot disengaged the autopilot at 1,400 ft. The A320 was about 830 ft above ground level (AGL) when the commander told the copilot that the precision approach path indicator lights showed the aircraft above glide path and that he should increase the rate of descent to 1,000 fpm.

The aircraft was at about 80 ft AGL when the wind component changed from a 7 kt crosswind to a 4 kt tail wind. “The copilot’s control inputs resulted in a flare insufficient to arrest the aircraft’s high rate of descent and prevent the heavy landing,” the report said. Rate of descent was 900 fpm and vertical acceleration was 3.15 g (i.e., 3.15 times standard gravitational acceleration) when the A320 touched down on the main landing gear and bounced. The commander took control and completed the landing.

The commander subsequently reported the hard landing, and the operator grounded the aircraft. “Both main landing gear assemblies were replaced before the aircraft returned to service,” the report said.

Seat Belt Fittings Fail in Turbulence

Boeing 737-300. No damage. Six minor injuries.

The 737 encountered severe turbulence while descending through 11,400 ft to land in Las Vegas on Feb. 24, 2008. Three passengers, including an infant being held by his mother, sustained minor injuries when their seat belt attachments failed and they struck overhead baggage compartments.

“Two additional passengers and a flight attendant were injured by rough contact with the airplane structure during the turbulence encounter,” said the report by the U.S. National

The wind component changed from a 7 kt crosswind to a 4 kt tail wind.

Transportation Safety Board (NTSB). The other 136 occupants were not hurt, and the airplane was landed without further incident.

“Medical personnel met the airplane as requested and treated the injured passengers and flight attendant, classifying their injuries as minor,” the report said.

The turbulence encounter had lasted 20 seconds. Recorded flight data showed peak vertical accelerations of -0.8 g and $+1.8$ g. The seat belt signs were illuminated throughout the flight, and about five minutes before the encounter, the captain advised the flight attendants to clean up the cabin early and to take their seats.

Examination of the failed seat belts revealed that the keepers in the D-ring attachments were bent and had allowed the D-rings to unhook from their attachments to the seat frames. Following similar seat belt failures in the 1990s, the U.S. Federal Aviation Administration (FAA) in 2003 issued a special airworthiness information bulletin (SAIB NM-04-37) advising transport category airplane operators to expedite replacement of D-ring-type seat anchors.

The report said that the 737 was among the airplane models listed in the SAIB as possibly having D-ring-type seat anchors but noted that “SAIBs are advisory in nature and compliance is not mandatory.” Nevertheless, NTSB concluded that “the failure of the operator to comply with the SAIB” was a contributing factor in the incident.

Pelican Penetrates Cockpit

Bombardier Challenger 604. Substantial damage. No injuries.

The flight crew said that the Challenger was climbing through 8,000 ft at 230 kt when it struck large white birds while departing from Colorado Springs, Colorado, U.S., for a business flight the afternoon of April 8, 2008. One of the pilots told investigators, “At first, there was a loud bang, followed by a moderately loud wind noise.”

The crew realized that at least one of the birds had penetrated the cockpit. They declared an emergency and, after performing control and systems checks, returned to Colorado Springs

and landed without further incident. None of the five people aboard the airplane was injured.

“Examination of the airframe revealed a hole in the airplane’s forward fuselage below the cockpit windows,” the NTSB report said. “The fuselage skin and forward pressure bulkhead were penetrated and contained bird matter. Bird matter was noted on the cockpit windows, fuselage, vertical and horizontal stabilizers, and in the left engine. The left engine fan blades were damaged, and the spinner was buckled and collapsed.”

The birds were identified as American White Pelicans, which have an average weight of 15 lb (7 kg). “The state of Colorado is located in the migratory path of the American White Pelican,” the report said. “The birds usually travel from Montana/South Dakota to Mexico, paired up for mating, and travel in flocks of four to 12 birds.”

The pilots had received no bird advisories before takeoff. “At the time of the accident, the U.S. Air Force bird avoidance model risk class was moderate for the area,” the report said.

Tires Burst on Takeoff

Gates Learjet 36A. Substantial damage. No injuries.

The Learjet was nearing 120 kt on takeoff roll when the crew heard a loud pop during departure from Runway 20 at Newport News/Williamsburg (Virginia, U.S.) International Airport the morning of March 26, 2007. The airplane veered left, and the PF rejected the takeoff, retarding the throttles and applying maximum wheel braking while the pilot monitoring deployed the drag chute.

“The drag chute appeared to be inoperative, and the pilots were unable to stop the airplane on the runway,” the NTSB report said. “The airplane continued off the right side, impacted a runway light and came to rest in the grass.” The report did not say whether the crew deployed the spoilers during the rejected takeoff or whether the Learjet was equipped with thrust reversers.

Examination of the airplane revealed that the left main landing gear tires had burst, the

The turbulence encounter had lasted 20 seconds.

landing gear had separated and the left wing spar had been damaged. “Due to severe fragmentation of the tires, the origin of the tire failure could not be identified,” the report said. However, airport personnel found rocks and pieces of metal on the runway after the accident. The runway was 6,526 ft (1,989 m) long and 150 ft (46 m) wide.

The report said that the probable cause of the accident was “the failure of the landing gear tires due to [debris] on the runway” and that a contributing factor was the failure of the drag chute. Investigators found that the drag chute strap had separated at the woven loop that attaches it to the airplane.

The airplane manufacturer recommended that drag chutes be deployed on landing at least once every six months, then inspected and repacked. “According to maintenance records, the drag chute [on the accident airplane] was most recently repacked during a routine inspection three months prior to the accident,” the report said. “The drag chute had not been deployed prior to or after the inspection.”

Mechanic Pinned by Nosewheel

Boeing 777-300. No damage. One serious injury.

The 777 was pushed back from the gate, and the engines were started in preparation for departure from San Francisco International Airport the night of Aug. 16, 2008. A ground crewmember was unable to disconnect the tow bar, and an airline mechanic recommended that the airplane be towed forward to straighten the tug and the nosegear.

After asking the flight crew to release the parking brake, the ground crewmember towed the airplane forward but still had difficulty disconnecting the tow bar. “The mechanic came to check the condition of the tow bar, which he reported was half unhooked,” the NTSB report said. “The mechanic tried to disconnect the tow bar by stepping on it.”

When the tow bar eventually disconnected, the 777 rolled forward. “The mechanic shouted to the ground agent to ‘set the parking brake’ and then fell on the ground,” the report said.

“The airplane continued to roll forward and pinned the mechanic’s leg.”

The report said that the probable cause of the accident was the ground crewmember’s failure to follow standard operating procedures for tow bar disconnection. The procedures include setting the parking brakes in both the airplane and the tug, chocking the wheels, and disconnecting the tow bar first from the tug, then from the airplane.

Fairing Separates in Turbulence

Eclipse 500. Minor damage. No injuries.

The pilots heard a loud bang and a rumble when the very light jet encountered light turbulence in cruise flight at 5,000 ft and 250 kt near Rockford, Illinois, U.S., on July 17, 2008. The airplane, which was on an air taxi positioning flight from Pinedale, Wyoming, was landed at the destination, Chicago Executive Airport, without further incident.

Examination of the airplane revealed that the left wing fairing had separated. Three screws in the forward edge of the fairing were missing, and all of the screws in the curved section of the fairing had pulled through the fairing and remained attached to the underlying structure.

The wing fairing is constructed of carbon fiber with a foam core. The screw holes in the fairing have countersunk recesses into which grommets are glued. The NTSB report said that the screws and grommets used for the fairing are smaller than those used in other parts of the airplane.

The wing fairings on the incident airplane had been removed several times by the operator’s maintenance personnel to facilitate work on the fuel system and autopilot system. “The operator reported that the metal grommets begin to loosen when the fairing is repetitively removed,” the report said. “The operator stated that they had not submitted FAA service difficulty [reports] regarding grommet-to-fairing separation.”

The report said that the probable cause of the incident was “improper installation of the forward edge of the [wing fairing]” and that a contributing factor was “the use of small-head screws and grommets in securing the fairing.”

**Three screws
in the forward
edge of the fairing
were missing.**

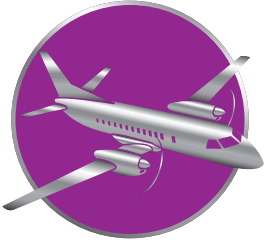

TURBOPROPS

'Outdated' Blades Trash Engine

Beech 1900D. Substantial damage. No injuries.

The aircraft was departing from the airport in Jabiru, Northern Territory, Australia, for a charter flight the morning of Feb. 11, 2008, when the left propeller automatically feathered and the left engine failed at about 600 ft AGL. Witnesses on the ground saw flames coming from the left engine, and the passenger aboard the 1900 told the pilots that "white chunks of metal" were coming out of the exhaust system, said the ATSB report.

The pilots completed a single-engine circuit of the airport and landed the aircraft without further incident.

Examination of the aircraft revealed catastrophic internal damage to the left engine power turbine section. "The initiator of the damage was the release of a power turbine second-stage blade," the report said. Metallurgical inspections showed that the blade had failed because of high-cycle fatigue cracking at its root.

The engine manufacturer, Pratt & Whitney Canada, had issued a service bulletin (SB 14172R1) in 1994 calling for replacement of the second-stage turbine blades in PT6A-67D engines with strengthened blades that also provide more blade-tip clearance. The blade replacement was required during the next overhaul of the power turbine section.

However, the report said that when the incident aircraft's left engine power turbine section was overhauled in May 2005, "outdated" turbine blades were installed, and compliance with the SB was incorrectly noted in the engine's records. This notation resulted in noncompliance with a requirement to inspect the outdated blades every 1,500 hours.

"The involvement of an overseas overhaul facility contributed to the inability of the investigation to establish why the pre-SB blades were installed ... and the reason for the incorrect annotation in the engine's documents," the report said.

Aft Loading Leads to Tail Strike

Saab 340B. Minor damage. No injuries.

The aircraft was scheduled for a flight from Glasgow, Scotland, to Benbecula with 10 passengers, three crewmembers, 660 kg (1,455 lb) of newspapers in the cargo compartments and another 150 kg (331 lb) of newspapers in three "seat converters" at the rear of the passenger compartment.

Before the 340's scheduled departure the morning of Jan. 17, 2009, the airline's central load control facility in Manchester, England, determined that the load sheet required revision, moving some passengers forward and offloading 24 kg (53 lb) of newspapers from the aft cargo compartment, to bring the center of gravity (CG) within limits.

The central load control facility sent the revised load sheet to the airline's dispatch office in Glasgow about 30 minutes before the scheduled departure time. "However, no flight release message was sent from [the central load control facility] to Glasgow, as required," the AAIB report said. "The dispatcher was therefore not aware of the need to move the passengers."

As a result, the aircraft's CG was about 14 index units aft of the aft limit for takeoff and landing, although the original load sheet provided to the flight crew showed the CG about 6 index units forward of the aft limit.

The commander and the copilot, the PF, did not recognize the situation during takeoff or cruise. However, after touching down at Benbecula, the copilot was unable to lower the aircraft's nose, even when he moved his control column full forward. "The commander attempted to lower the aircraft nose using a combination of propeller reverse thrust and wheel brakes," said the report, noting that the reverse thrust likely exacerbated the problem.

The nose did not lower until airspeed decreased to approximately 40 kt. Examination of the 340 revealed that the tail had struck the runway, resulting in abrasion to the fuselage skin and the attachment bracket for the "pogo stick," a device used to support the aircraft's tail during loading.

Flight Control Lock Overlooked

De Havilland DHC-6. Substantial damage. One fatality.

A witness who watched the Twin Otter being taxied to the runway at Hyannis, Massachusetts, U.S., the morning of June 18, 2008, told investigators that he “found it strange that the airplane did not stop and rev up its engines before takeoff, as he thought airplanes normally did, but instead taxied on the taxiway parallel to the runway and then made a 180-degree turn onto the runway without stopping.”

The NTSB report said that the pilot was more than one hour late in initiating the charter flight to Nantucket, Massachusetts, because of a delay in arrival of the cargo at Hyannis.

The Twin Otter entered a steep left bank shortly after lifting off the runway. “The bank steepened, and the airplane descended and impacted the ground,” the report said. “Post-accident examination of the wreckage revealed that the pilot’s four-point restraint was not fastened and that at least a portion of the cockpit flight control lock remained installed on the control column. One of the pre-takeoff checklist items was ‘flight controls unlocked, full travel.’”

The report noted that the airplane manufacturer in 1979 issued SB 6/383, introducing a new control lock that deflects the elevators down to minimize the possibility of the airplane becoming airborne with the lock installed. The next year, the manufacturer issued SB 6/391, recommending installation of a warning flag on the control lock. The SBs later were consolidated.

The accident airplane had not received the modifications. Transport Canada in 1990 issued an airworthiness directive requiring compliance with the SBs. The FAA issued a similar directive after the accident.



PISTON AIRPLANES

Turbocharger Fails on Takeoff

Piper Chieftain. Substantial damage. One serious injury, two minor injuries.

The Chieftain was near its maximum takeoff weight when it departed from Aniak, Alaska, U.S., for a commuter flight to Shageluk the afternoon of Aug. 4, 2008. The pilot said that

the airplane was at about 200 ft AGL when the left engine lost power. Witnesses on the ground saw smoke emerging from the engine.

“The pilot indicated that he feathered the left engine but that the airplane was descending and he elected to make an emergency landing on a gravel bar about 0.5 mi [0.8 km] from the airport,” the NTSB report said.

The nosegear collapsed on landing, and the fuselage and wings were damaged. One passenger was seriously injured, and two passengers sustained minor injuries; four passengers and the pilot escaped injury.

Tests of the left engine revealed that it could not produce manifold pressure above atmospheric pressure. However, after the turbocharger was replaced, the engine produced full rated power. Examination of the original turbocharger showed that one of the turbine shaft bearings had failed and that the turbine shaft and blades were damaged.

Passenger Retracts Gear on Landing

Beech Baron. Substantial damage. No injuries.

The Baron, which was for sale, departed from Jersey, Channel Islands, for a flight to Guernsey the morning of Aug. 4, 2008, with the commander in the right front seat and a prospective buyer in the left seat. The AAIB report said that the prospective buyer was an experienced pilot but was not current in type.

“The departure was normal, and some general handling was carried out by the pilot in the left seat before he handed control back to the aircraft commander for landing,” the report said.

After touchdown and before the commander applied wheel braking, the prospective buyer offered to raise the flaps. “Before the commander could prevent him from doing so, the pilot in the left seat inadvertently selected the landing gear handle instead of the flap lever and moved it to the ‘UP’ position,” the report said. “The commander immediately returned it to the ‘DOWN’ position, but the retraction cycle had commenced, and the aircraft sank onto the runway.”

The landing gear handle in older Barons is on the right side of the center pedestal and the

flap lever is on the left side. The commander told investigators that the prospective buyer likely assumed that the flap lever was in the same place in the Baron as it was in the aircraft that he normally flew.

Attitude Indicator Malfunctions

Cessna P337H Skymaster. Destroyed. Two fatalities.

During his preflight briefing the morning of June 15, 2008, the pilot was told that instrument meteorological conditions (IMC) prevailed along the route from Millinocket, Maine, U.S., to Caldwell, New Jersey. The pilot filed an instrument flight rules (IFR) flight plan but did not activate the flight plan before departing in VMC.

“The pilot subsequently informed air traffic control [ATC] that he was experiencing a problem with the airplane’s artificial horizon and that he wanted to try to conduct the flight under VFR [visual flight rules],” the NTSB report said.

However, about 15 minutes later, the pilot requested and received clearance from ATC to conduct the flight under IFR at 8,000 ft. The Skymaster was in IMC with light to moderate precipitation when radio contact was lost. Recorded ATC radar data showed that the airplane’s heading varied from southwest to northwest and then to southeast. The Skymaster was descending through 7,200 ft when radar contact was lost. It struck the Atlantic Ocean at high speed and was not recovered.

The report said that the probable cause of the accident was “the pilot’s improper decision to continue the flight in IMC after experiencing an attitude indicator malfunction.”

HELICOPTERS

Visual References Lost in Whiteout

Bell 206B-3 JetRanger. Destroyed. One fatality.

Weather conditions were fluctuating between VMC and IMC when the JetRanger was landed on Réservoir Gouin, Quebec, Canada, the morning of March 19, 2008, to retrieve a company Cessna 206 that had been stuck in soft snow and slush on the frozen reservoir for more than a week.

Neither of the two pilots aboard the helicopter held an instrument rating. One pilot took off uneventfully in the airplane and flew it to Alma, about 120 nm (222 km) east. “The weather at the time was estimated at 1 1/2 mi [2,400 m] visibility in light snow showers, ceiling 200 ft AGL,” said the report by the Transportation Safety Board of Canada.

The other pilot departed in the JetRanger shortly thereafter. The helicopter struck the reservoir at a high rate of descent 1.2 nm (2.2 km) from the takeoff point. “It is likely that the pilot lost control of the helicopter while flying in whiteout conditions over the vast snow-covered frozen surface of Réservoir Gouin,” the report said.

Rotor Blade Strikes Ramp Worker

Kaman K-1200. Substantial damage. One fatality.

The pilot had started the engine in preparation for a positioning flight from Santa Clarita, California, U.S., to Los Angeles the morning of Dec. 17, 2008. The engine was at flight idle when the ground crewman, a company maintenance technician, disconnected the external power unit cable from the helicopter.

The pilot said that as the ground crewman walked away from the helicopter, which was facing toward the north-northwest, the Kaman was struck by a gust of about 15 kt from the east-southeast. He felt the right side of the helicopter lifting off the ground. “The pilot applied full right cyclic to counter the up-lifting condition; however, the wind gust continued lifting the helicopter to the left and nose-down until the aircraft came to rest inverted,” the NTSB report said.

As the helicopter rolled over, the main rotor blades struck a fueling truck and separated. One of the blades struck and killed the ground crewman. The pilot was not injured.

Noting that the K-1200 flight manual says that the maximum velocity for a right quartering tail wind is 17 to 25 kt for takeoff and landing, the report said, “The winds at the accident site most likely exceeded the maximum wind allowed.”



Preliminary Reports, July 2009

Date	Location	Aircraft Type	Aircraft Damage	Injuries
July 2	Breckenridge, Colorado, U.S.	Bell 206L-1	substantial	1 serious, 1 minor
The LongRanger was transporting an external load of cargo to a mine at 12,925 ft when it began to rotate, landed hard and rolled over.				
July 3	Maranhão, Brazil	Piper Seneca II	substantial	2 serious
The Seneca crashed short of the runway during an attempt to return to the airport after an engine failed on departure for a cargo flight.				
July 4	Baganara Island, Guyana	Britten-Norman Islander	minor	10 none
The pilot performed an emergency landing after one engine failed during a charter flight.				
July 5	Great Barrier Island, New Zealand	Britten-Norman Trislander	substantial	11 NA
The Trislander was departing on a scheduled flight when the no. 3 propeller separated and struck the fuselage. Two passengers were injured by debris.				
July 5	Raphine, Virginia, U.S.	Pilatus PC-12/45	destroyed	4 fatal
The pilot reportedly lost control of the airplane in IMC at about 31,000 ft after telling ATC, "I lost my panel!"				
July 6	Biak, Papua, Indonesia	Boeing 737-400	minor	111 none
The flight crew landed the 737 without further incident after a nosewheel separated on takeoff.				
July 8	near Port Richey, Florida, U.S.	Cessna 421C	destroyed	5 fatal
The airplane descended into the Gulf of Mexico shortly after the pilot told ATC that it had encountered severe turbulence and was "upside-down."				
July 9	Richmond, British Columbia, Canada	Piper Chieftain	destroyed	2 fatal
The Chieftain was on a night cargo flight when it crashed into an auto mall on approach to Vancouver International Airport.				
July 9	Amarnath Caves, India	Aerospatiale SA 350	destroyed	1 fatal, 5 serious
One person on the ground was killed when the helicopter crashed on approach to a landing pad.				
July 10	Kinmen Island, Taiwan	MBB/Kawasaki BK-117	destroyed	2 fatal, 1 NA
The air ambulance struck the sea during a night approach. The patient and copilot drowned; the pilot was rescued.				
July 10	Fort Myers, Florida, U.S.	Airbus A320-232	none	2 serious, 2 minor, 149 none
The seat belt sign was on when the A320 encountered turbulence while descending through 12,000 ft. One of the seriously injured passengers did not have her seat belt fastened; the other was in a lavatory.				
July 13	Yakutat, Alaska, U.S.	Beech G185	substantial	1 none
The cargo airplane veered off the runway after encountering a gust on touchdown.				
July 13	Charleston, West Virginia, U.S.	Boeing 737-300	substantial	131 none
The 737 was at 30,000 ft, en route from Nashville, Tennessee, to Baltimore, when a small section of upper rear fuselage skin ruptured, causing a rapid decompression. The airplane was landed without further incident at Charleston.				
July 15	Qazvin, Iran	Tupolev 154M	destroyed	168 fatal
The airplane was at 34,000 ft, en route from Tehran to Yerevan, Armenia, when it turned 270 degrees, entered a rapid descent and crashed in an open field.				
July 17	Nunavik, Quebec, Canada	Bell 206L	destroyed	2 fatal
The helicopter crashed in a ravine during a positioning flight from Kangirsuk to Kangiqsujuaq.				
July 17	Willow Creek, California, U.S.	Croman SH-3H	substantial	1 serious, 1 minor
The firefighting helicopter was uploading water when it struck the tank and rolled over.				
July 22	Franklin, Pennsylvania, U.S.	Hughes 369	substantial	1 fatal
The helicopter crashed after its external load became entangled in a tree.				
July 23	Boonsboro, Maryland, U.S.	Robinson R44	destroyed	4 fatal
Night IMC prevailed when the helicopter struck power lines while flying over a highway.				
July 24	Mashhad, Iran	Ilyushin 62M	destroyed	16 fatal, 137 NA
VMC prevailed when the airplane overran the runway on landing and struck a wall.				
July 31	Parma, Italy	Boeing 737-800	none	189 none
The flight crew rejected the takeoff at 105 kt when they saw a bird-control vehicle on the runway.				

NA = not available

This information, gathered from various government and media sources, is subject to change as the investigations of the accidents and incidents are completed.

Smoke, Fire and Fumes Events in the United States and Canada, May–July 2009

Date	Flight Phase	Airport	Classification	Sub-classification	Aircraft	Operator
May 1, 2009	Descent	Pensacola, Florida (PNS)	Descent to arrival airport, landing	Smoke in cabin	B-737	Delta Air Lines
While the airplane was descending through 10,000 ft, a flight attendant reported smoke in the cabin. The flight crew turned off the right air conditioning pack, the smoke dissipated, and an uneventful landing followed.						
May 2, 2009	Unknown	Unknown	Unscheduled landing	Smoke in forward galley area	B-757	United Airlines
The first officer and a flight attendant detected a burning insulation smell in the forward galley area. Circuit breakers were pulled.						
May 9, 2009	Cruise	Detroit (DTW)	Landing at destination	Smoke in galley oven	B-757	Northwest Airlines
The aft galley oven emitted smoke. The crew identified smoke coming from the fan/heating element area of the oven.						
May 15, 2009	Cruise	Unknown	Unscheduled landing	Burning smell in cabin	EMB-145	Continental Express Airlines
The crew reported an electrical burning smell and burning rubber odor upon completion of the climbout.						
May 16, 2009	Cruise	Charlotte, North Carolina (CLT)	Diversion, unscheduled landing	Electrical/burning smell in cockpit	B-757	Allegheny Airlines
During cruise, the crew reported a strong electrical/burning smell in cockpit. They conducted the quick reference handbook checklist and turned off both recirculating fans.						
May 18, 2009	Cruise	Las Vegas (LAS)	Diversion, unscheduled landing	Electrical/burning smell in cockpit	DC-9	Allegiant Air
During cruise, the crew reported a strong electrical/burning smell in the mid-cabin. They diverted to Las Vegas and landed without incident.						
May 23, 2009	Climbout	Philadelphia (PHL)	Diversion, unscheduled landing	Burning smell in cabin	ERJ 170	Unknown
On climbout from PHL, the crew received a bleed leak warning and noticed a smell of burning rubber in the cabin. They declared an emergency and diverted to Norfolk (Virginia) International Airport.						
May 27, 2009	Taxi	Unknown	After landing	Smoke in cabin	EMB 120	Great Lakes Aviation
After landing, the pilots reported that smoke filled the cabin and activated an aural alarm. The pilots shut off the air conditioning packs, and the smoke dissipated.						
May 29, 2009	Climbout	Unknown	Return to airport, unscheduled landing	Odor/smoke in cabin	CL-600	Express Airlines
During climbout, the smoke warning light for the aft lavatory illuminated. The flight crew donned oxygen masks. The cabin crew reported an odor in the cabin; an emergency was declared and the aircraft was returned for landing.						
May 30, 2009	Climbout	Fort Lauderdale, Florida (FLL)	Return to airport, unscheduled landing	Odor/smoke in cabin and cockpit	ERJ 190	JetBlue Airways
On the climbout from FLL, the flight crew noticed a smell of burnt oil in the cockpit and cabin. They declared an emergency and returned to FLL.						
June 11, 2009	Takeoff	Unknown	Return to airport, unscheduled landing	Odor/smoke in cabin and cockpit	EMB 145	American Eagle Airlines
On takeoff, the crew reported cabin and cockpit smoke/fumes with lavatory smoke indication on the engine indicating and crew alerting system. They returned to the departure airport.						
June 12, 2009	Cruise	Waterloo, Iowa (ALO)	Diversion, unscheduled landing	Electrical smoke in cabin	B-757	Northwest Airlines
In cruise, the crew noticed electrical smoke in the cabin. They diverted to ALO and made an uneventful landing.						
June 16, 2009	Cruise	Unknown	Diversion, unscheduled landing	Burning odor in cockpit	MD-10	FedEx
In cruise at 34,000 ft, the crew heard a thumping noise from the radome or avionics area. Almost immediately, a burning odor was detected in the cockpit. The flight was diverted and landed.						
July 13, 2009	Cruise	Unknown	Diversion, unscheduled landing	Smoke in cabin	CL-600	Express Airlines
In cruise at 31,000 ft, the crew heard a pop and saw sparks from the area above the flight attendant jumpseat. They declared an emergency and landed at an alternate airport.						
July 25, 2009	Climbout	Boston (BOS)	Return to airport, unscheduled landing	Odor/smoke in cabin and cockpit	B-757	American Airlines
During climbout, the crew reported smoke in the cabin and cockpit. They declared an emergency and returned to BOS.						

Source: Safety Operating Systems

“MEMBERSHIP IN
FLIGHT SAFETY FOUNDATION
IS A SOUND INVESTMENT,
NOT AN EXPENSE.”

DAVE BARGER, CEO, JETBLUE AIRWAYS

For **EUROCONTROL**, FSF is a partner in safety. In these times of economic restraint, it makes excellent sense to combine scarce resources and share best practices.

— DAVID MCMILLAN, PRESIDENT



FSF membership has made a real difference for the **JOHNSON CONTROLS** aviation team. Having access to the Foundation's expert staff and its global research network has provided us with an in-depth understanding of contemporary safety issues and the ability to employ state-of-the-art safety management tools, such as C-FOQA and TEM. All of which has been vital to fostering a positive safety culture.

— PETER STEIN, CHIEF PILOT



JETBLUE AIRWAYS considers that membership in Flight Safety Foundation is a sound investment, not an expense. Membership brings value, not just to our organization, but to our industry as a whole.

— DAVE BARGER, CHIEF EXECUTIVE OFFICER



CESSNA has worked with FSF for a number of years on safety issues and we especially appreciate that it is a non-profit, non-aligned foundation. Its stellar reputation helps draw members and enlist the assistance of airlines, manufacturers, regulators and others. We supply the Aviation Department Toolkit to customers purchasing new Citations and it's been very well received. Our association with FSF has been valuable to Cessna.

— WILL DIRKS, VICE PRESIDENT, FLIGHT OPERATIONS



At **EMBRY-RIDDLE AERONAUTICAL UNIVERSITY**, we view FSF as a vital partner in safety education. Together, we share goals and ideals that help keep the environment safe for the entire flying public.

— JOHN JOHNSON, PRESIDENT



Flight Safety Foundation is the foremost aviation safety organization committed to reducing accident rates, particularly in the developing economies.

To all civil aviation authorities, aviation service providers, airlines and other stakeholders interested in promoting aviation safety, this is a club you must join.

— DR. HAROLD DEMUREN, DIRECTOR GENERAL,
NIGERIAN CIVIL AVIATION AUTHORITY



Corporate Flight Operational Quality Assurance

C-FOQA



A cost-effective way to measure and improve training, procedures and safety

Using actual performance data to improve safety by identifying:

- Ineffective or improper training;
- Inadequate SOPs;
- Inappropriate published procedures;
- Trends in approach and landing operations;
- Non-compliance with or divergence from SOPs;

- Appropriate use of stabilized-approach procedures; and
- Risks not previously recognized.

Likely reduces maintenance and repair costs.

Accomplishes a critical Safety Management System step and assists in achieving IS-BAO compliance.

For more information, contact: