

Connect with IoT

Microcontrollers Ver.9.0



Microcontrollers

LAPIS Technology's MCU controllers utilize original low power technology cultivated over many years to achieve class-leading* performance. As such they have been widely adopted in a variety of applications, from compact battery-driven devices such as high-performance digital watches to consumer appliances, industrial equipment, and infrastructure, with over 100 million units shipped per year. Going forward, LAPIS Technology will continue to provide MCUs that meet market needs for low power consumption by leveraging the latest technologies.

Feature 1

Broad lineup

<Select according to application>

- 8/16/32bit models offered
- Consumer electronics, industrial equipment, IoT, battery-powered applications
- MCUs with speech playback function available

Feature 2

Multiple peripheral functions and form factors

<Compatible with a wide range of applications>

- LCD drivers suitable for a variety of LCD panels
- Select between package and bare chip form factors to suit application requirements
- High noise immunity against power supply/signal noise
- High fidelity high output voice functionality
- Numerous serial ports
- PWM ideal for IGBT/LED lighting control
- Low-cost, high precision temperature measurement via RC ADC
- Flash memory readable at only 1V

Feature 3

Complete development support system

<Supports software development and Flash programming>

- Reference board available for every product
- Starter kit with emulator, reference board, and software development tools facilitates program development
- Onboard/offboard Flash programmer supports customer program writing during mass production
- Support also provided for program writing during mass production based on customer requirements (i.e. via onboard writing tool, Flash GANG writer)

Feature 4

Low Power consumption high performance original U8/U16 cores

<Easily switch between 8bit and 16bit cores depending on the application>

- Instruction compatibility simplifies program flow
- Built-in multiplication/division co-processor improves computing power



8bit
MCU

16bit
MCU

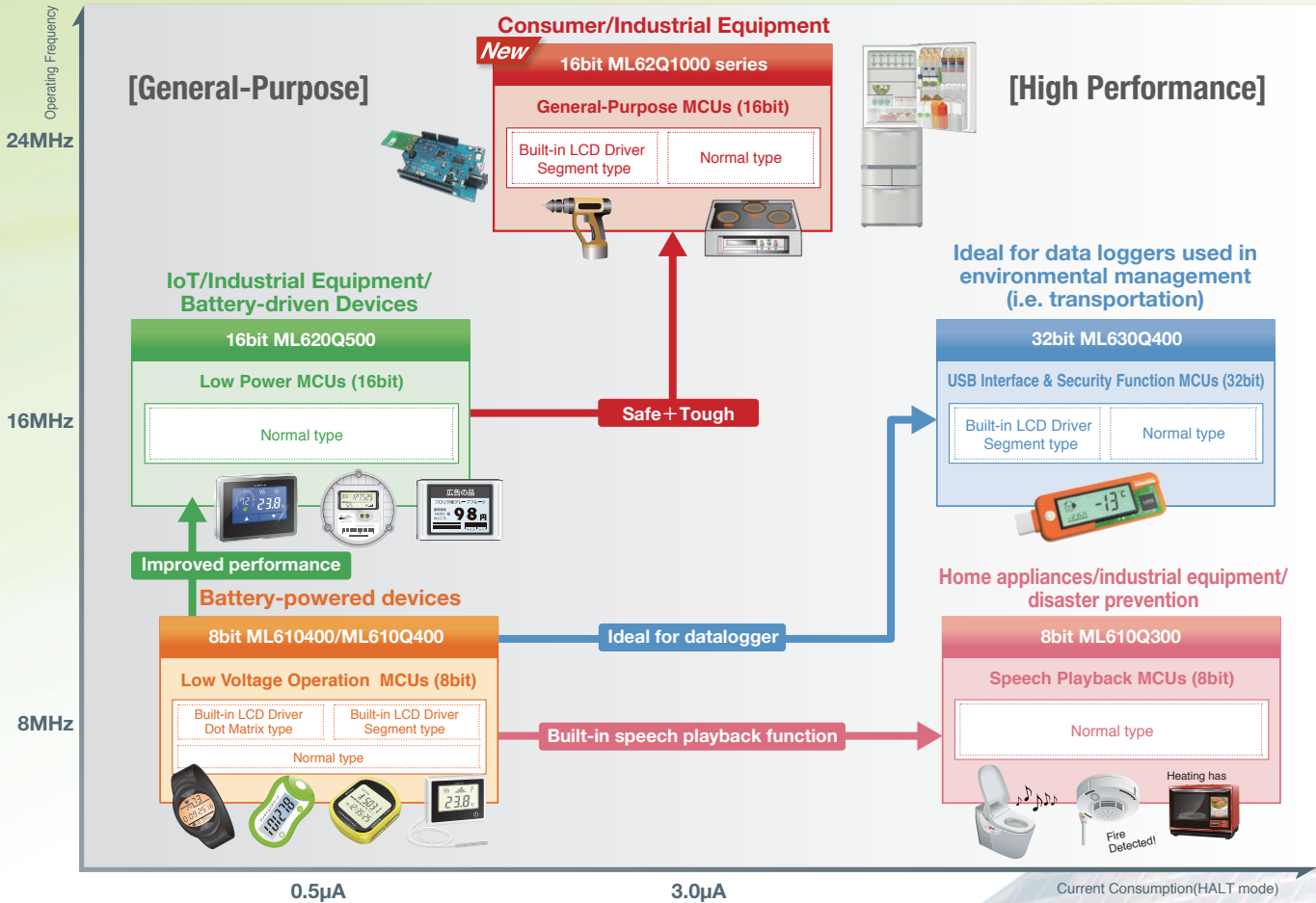

Index

New General-Purpose MCUs (16bit)	ML62Q1000 series	P.3
Low Power MCUs (16bit)	ML620Q500	P.5
Low Voltage Operation MCUs (8bit)	ML610400/ML610Q400	P.7
Speech Playback MCUs (8bit)	ML610Q300	P.9
USB Interface & Security Function MCUs (32bit)	ML630Q400	P.11
8bit/16bit MCU Development Support System		P.12
LAPIS Technology Support Site		P.16
Product Specifications		P.17
Part Number Explanation		P.18 P.29

*LAPIS Technology study

General-Purpose MCUs (16bit)

Expanded functionality, 24MHz (Max) operation at up to 105°C

16bit ML62Q1000 series ML62Q1300 group
ML62Q1500 group ML62Q1700 group ML62Q1800 group

The ML62Q1000 series are high-performance 16bit CMOS microcontrollers utilizing Lapis Technology's RISC-type 16bit CPU 'U16' core. Low Power consumption and multiple peripheral functions provide superior processing capability.

Feature 1: Multiple peripherals

A wide array of peripheral circuits are built-in, including numerous serial communication circuits, multifunction timers, a high accuracy analog function, and flash memory that supports background processing during program execution while writing to the data flash.

Feature 2: Broad lineup

The broad lineup includes several package types, from 16 to 100 pins, in program memory sizes ranging from 16KB to 512KB. Software-compatible peripheral functions are built in. Pin layout is also similar, making it easy to flexibly respond to package and/or program changes.

Feature 3: Safety functions

In addition to functions for preventing crystal oscillation stoppage during inter-terminal leakage and malfunctions at low voltages and/or turn ON, a circuit is added that significantly expands the self-test range.



ML62Q1000 series System Block Diagram

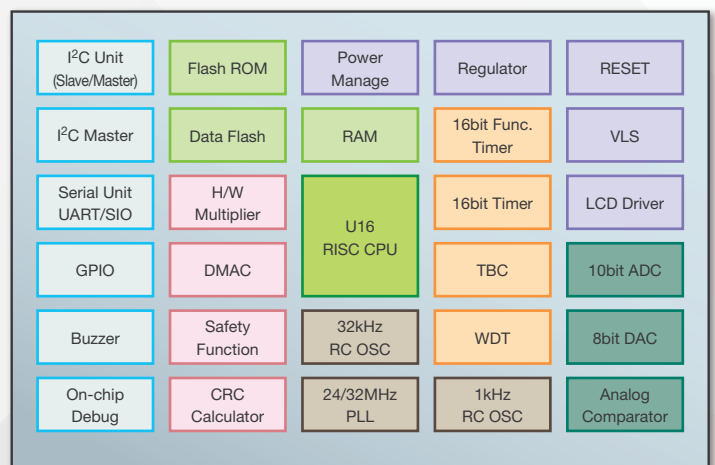

Full dual clock system delivers flexible clock management with Low Power consumption

Full Dual Clock System

⇒ This system enables selection of low-speed and high-speed clocks for each CPU and peripheral circuit. For example, a high-speed clock is typically selected for the CPU and timer operation, but can be stopped quickly if necessary and a low-speed clock used (i.e. for receiving signals through UART). This provides flexible clock management that can help reduce power consumption considerably.

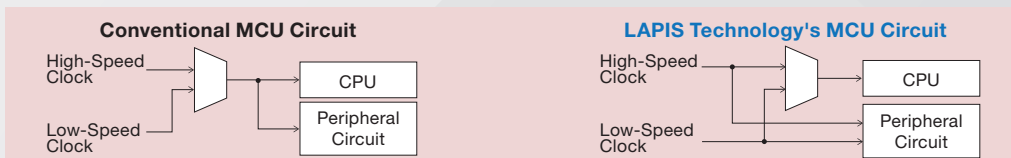

Current Control at Startup

⇒ Controlling the initial current during power ON and utilizing a low-speed clock at MCU startup makes it possible to minimize startup current, allowing for worry-free operation in power supply systems possessing limited current capacity.

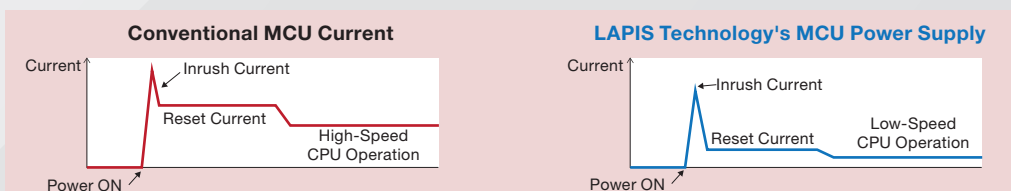

Safety Functions

Expanded safety functions

Self-Diagnostic Functions	Error Detection	Memory Protection
<ul style="list-style-type: none"> Register test UART/SSIO/I²C test A/D converter test Program counter test Oscillation frequency test WDT test GPIO test Interrupt test 	<ul style="list-style-type: none"> Flash memory CRC calculation RAM parity error ROM unused area access 	<ul style="list-style-type: none"> RAM guard SFR (Special Function Register) guard
Peripheral circuit diagnosis detects failures	Detects malfunctions due to memory data errors and invalid memory access	SFR/RAM erroneous write prevention

10 software-based self-diagnostic functions

Sample software is offered, including self-diagnostic software for the MCU that complies with the international standard IEC/UL60730 'Automatic electrical controls for household and similar use' as well as software compatible with IEC60730-1 Annex H Software Class B

Strong against noise and compatible with high temperatures

Cleared the highest class ($\pm 8\text{kV}$) during IEC61000-4-2 ESD noise testing (also cleared $\pm 30\text{kV}$)
 Broad operating temperature range: -40°C to $+105^{\circ}\text{C}$ Compatible with high temperatures

Results of ESD Breakdown Evaluation Tests Based on IEC61000-4-2

Test Level	Test Voltage [kV]	ML62Q1000 series	
		Vertical Coupling Plane Test	Horizontal Coupling Plane Test
1	± 2	Pass	Pass
2	± 4	Pass	Pass
3	± 6	Pass	Pass
4	± 8	Pass	Pass
Reference	± 30	Pass	Pass

U16 CORE ML62Q1000 series										
ROM (Byte)										
512K								ML62Q1729	ML62Q1739	ML62Q1749
								ML62Q1859	ML62Q1869	ML62Q1879
384K								ML62Q1728	ML62Q1738	ML62Q1748
								ML62Q1858	ML62Q1868	ML62Q1878
256K								ML62Q1727	ML62Q1737	ML62Q1747
								ML62Q1557	ML62Q1567	ML62Q1577
192K								ML62Q1726	ML62Q1736	ML62Q1746
								ML62Q1556	ML62Q1566	ML62Q1576
160K								ML62Q1725	ML62Q1735	ML62Q1745
								ML62Q1555	ML62Q1565	ML62Q1575
128K						ML62Q1704	ML62Q1714/C	ML62Q1724/C	ML62Q1734/C	ML62Q1744
						ML62Q1534	ML62Q1544/C	ML62Q1554/C	ML62Q1564/C	ML62Q1574
96K						ML62Q1703	ML62Q1713/C	ML62Q1723/C	ML62Q1733/C	ML62Q1743
						ML62Q1533	ML62Q1543/C	ML62Q1553/C	ML62Q1563/C	ML62Q1573
64K			ML62Q1347	ML62Q1367	ML62Q1702	ML62Q1712	ML62Q1722			
					ML62Q1532	ML62Q1542	ML62Q1552			
48K			ML62Q1346	ML62Q1366	ML62Q1701	ML62Q1711	ML62Q1721			
					ML62Q1531	ML62Q1541	ML62Q1551			
32K	ML62Q1325	ML62Q1335	ML62Q1345	ML62Q1365	ML62Q1700	ML62Q1710	ML62Q1720			
					ML62Q1530	ML62Q1540	ML62Q1550			
24K	ML62Q1324	ML62Q1334								
16K	ML62Q1323	ML62Q1333								
	16pin WQFN16 SSOP16	20pin TSSOP20	24pin WQFN24	32pin WQFN32 TQFP32	48pin TQFP48	52pin TQFP52	64pin QFP64 TQFP64	80pin QFP80	100pin QFP100 TQFP100	

ML62Q1700 group: Built-in LCD Driver Type

ML62Q1300 group: Normal Type

ML62Q1500 group: Normal Type

ML62Q1800 group: Normal Type

Note: Please refer to the manual for each product regarding individual specifications

Low Power MCUs (16bit)

0.45 μ A current consumption in Halt mode/
<250 μ A/MHz operating current

16bit ML620Q500

The ML620Q500 CMOS microcontrollers utilize LAPIS Technology's original 16bit RISC U16 Core to achieve superior performance. The U16 Core is instruction-compatible with the U8 Core and offers parallel processing using a 3-stage pipeline architecture to enable efficient instruction execution with one instruction per clock cycle. ML620Q500 leverage Low Power technology utilized in 8bit U8 Core MCUs to improve processing power and provide high performance operation (16MHz Max) while maintaining ultra-low current consumption (0.45 μ A at Halt, <250 μ A/MHz operation). Additional features include wide operating voltage (1.8V to 5.5V) and temperature (-40°C to +85°C) ranges, enabling support for a variety of applications. A number of peripheral circuits and functions are also built in, such as a successive-approximation-type 12bit ADC, RC-oscillator-type 24bit ADC ideal for temperature/humidity measurement, and multiple serial ports (I²C, UART, SPI). All models integrate flash memory for onboard programming.

U16 CORE ML620Q500 System Block Diagram

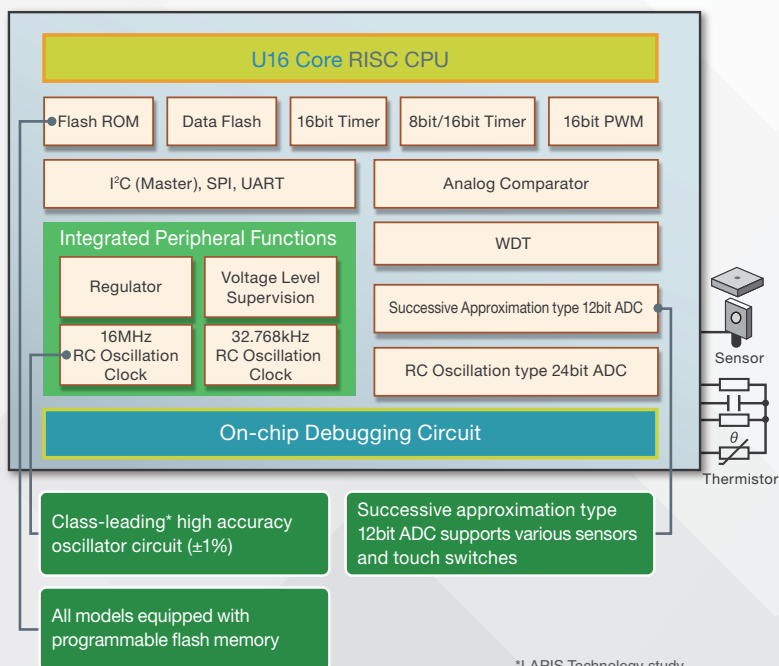

*LAPIS Technology study



ML620Q500 16bit MCUs provide low current consumption through optimized output modes

Numerous power modes reduce power consumption

- Optimal combination of multiple power down modes minimize power consumption
- Power down modes added to Flash ROM and regulator

[Multiple Power Down Modes]

3 power down modes (Deep Halt, Halt-H, Halt) are used in combination to reduce power consumption - even during high-speed (16MHz) operation.

[Flash ROM and Regulator]

The Flash ROM and regulator have been improved by adding newly developed power down modes, reducing standby power consumption even further.

[Reference]

Standby current reduced by 10%, from 0.5 μ A to 0.45 μ A

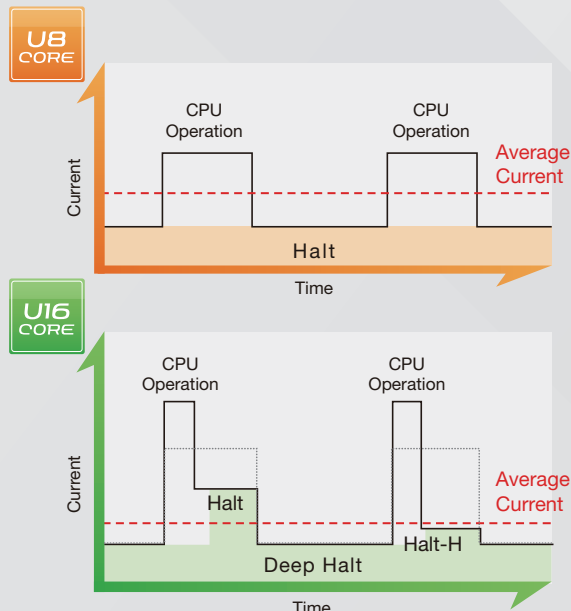

Feature

1

High performance operation with ultra-low current consumption supports a wide range of applications, from battery-driven devices to industrial equipment

- 0.45µA current consumption in Halt mode: <250µA/MHz operating current
- Operating frequency: 16MHz (Max)
- Operating voltage: 1.8V to 5.5V
- Operating temperature: -40°C to +85°C



Feature

2

Multiple peripheral functions support a variety of system requirements

- Successive approximation type 12bit A/D converter
- RC oscillation type 24bit A/D converter
⇒ Enables high accuracy temperature and humidity measurement
- I²C, SPI, UART (Full duplex mode), etc.
⇒ Compatible with a variety of serial I/F

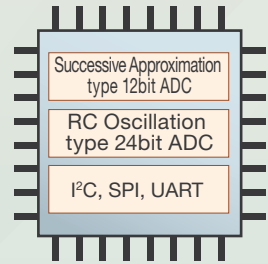

Feature

3

Internal oscillation circuit reduces component costs while improving system safety

- Low-Speed Clock: 32kHz crystal/internal RC oscillation (Selectable)
- High-Speed Clock: 16MHz crystal/internal RC oscillation (Selectable)
- 32kHz RC oscillation provides backup in case of crystal oscillation failure, ensuring continuous system operation

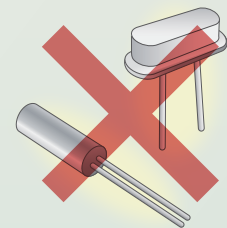

ML620Q500

ROM (Byte)	Normal type					
256K					Thermostats	
128K						
				Electronic Shelf Labels (ESL)		
64K				ML620Q504H		
					Temperature Loggers Health & Fitness	
32K				ML620Q503H		
16K						
	16pin	32pin	48pin	64pin	80pin	100pin

Note: Please refer to the manual for each product regarding individual specifications

Low Voltage Operation MCUs (8bit)

Remarkably low current consumption enables single-battery low-voltage drive
(0.5µA Halt current/operating current <5µA/32kHz)

8bit ML610400/ML610Q400

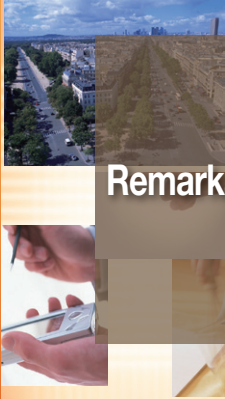

The 8bit ML610400/ML610Q400 of high-performance CMOS microcontrollers integrate LAPIS Technology's original 8bit U8 Core CPU, enabling high efficiency instruction execution(1 instruction/clock) through parallel processing based on a 3-stage pipeline architecture. The clock generator circuit uses a dual clock configuration and features both low-speed mode and Low Power mode operation. These MCUs, which have proven popular in the portable battery-driven and handheld device markets, leverages proprietary Low Power technology and incorporates Flash memory capable of operation at only 1V along with optimized power management functions and a high efficiency RISC CPU to minimize power consumption. In addition, a built-in LCD driver, 2 ADC circuits, on-chip debugger function, and other peripheral circuits make them ideal for portable LCD-equipped devices such as smart watches, activity/heart rate monitors, and thermostats. MCUs with integrated rewritable Flash memory support shorter development and production times while low current consumption translates to smaller, lighter form factors and extensive peripheral circuits contribute to greater set miniaturization. Also, an expanded temperature range (-40°C to +85°C) enables suitability with industrial equipment such as data loggers used for temperature processing for food and other products.



8bit ML610400/ML610Q400 System Block Diagram

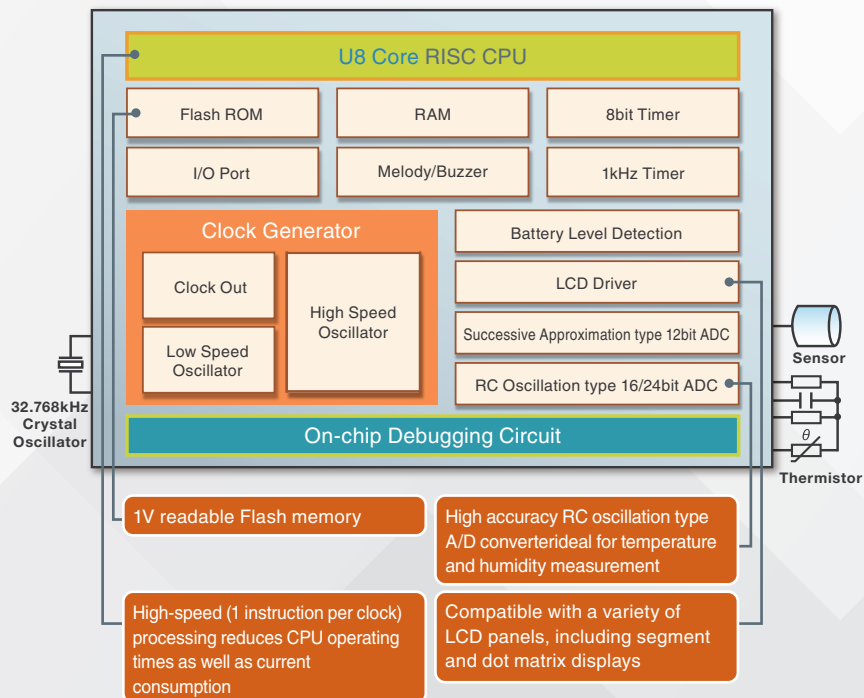

ML610Q400 8bit MCUs deliver low voltage, low current operation

	Conventional 8bit Flash Microcontroller
Operating Voltage	1.8V to 3.6V
Sleep (HALT) Current	2.0µA
Standby (STOP) Current	0.8µA
Operating Current	50µA (32kHz CPU operation) 6mA (4MHz CPU operation)

Reduced by up to **86%***

*LAPIS Technology study



	LAPIS Technology Low Power 8bit Flash Microcontroller
Operating Voltage	1.1V to 3.6V
Sleep (HALT) Current	0.5µA
Standby (STOP) Current	0.15µA
Operating Current	5µA (32kHz CPU operation) 0.8mA (4MHz CPU operation)

Breakthrough low current consumption enables single-battery operation

Feature 1

Ultra Low Power

Class-Leading **Low Power Consumption**

Flash memory operable at 1V, combined with a sleep (Halt) current of only 0.5µA, make this series suitable for a variety of applications-especially portable battery-driven devices.

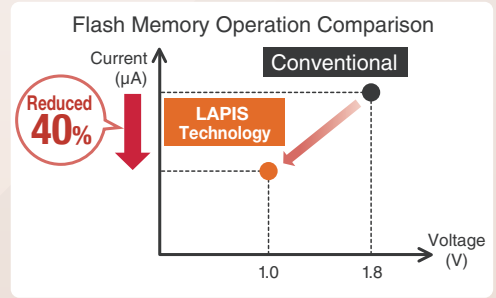

Feature 2

High performance CPU **U8 Core**

LAPIS Technology's original RISC-type CPU utilizes a 3-stage pipeline architecture to enable 1 instruction per clock cycle. As a result, 16bit performance is achieved via 8bit operation.

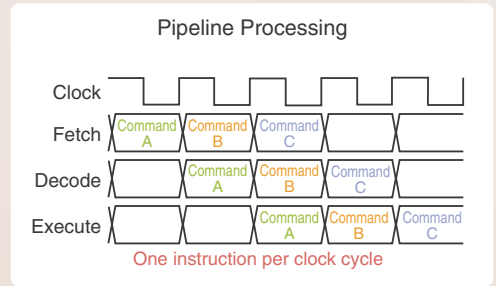

Feature 3

Integrated LCD driver and multiple peripheral functions

In addition to an LCD driver optimized for dot matrix/segment displays, these MCUs integrate an RC oscillator type ADC ideal for temperature measurement as well as a successive approximation type ADC compatible with voltage output sensors, along with a real-time clock, battery level detection circuit, 16bit PWM for backlight dimming, melody output, and more.

Dot Matrix type, Segment type, Standard type

10-bit SA ADC, 12-bit SA ADC, 16-bit PWM, MELODY, 16-bit RC ADC, 24-bit RC ADC, BLD, RTC

UB CORE		ML610400/ML610Q400					
ROM (Byte)	128K	Normal type			ML610Q418 ML610Q418C	High Accuracy Weather Notification Systems	ML610Q438/9
	96K					Thermostats	ML610Q435/6
	64K	ML610482 ML610Q482	Remote Controls for TVs		ML610Q419	Bicycle Meters	ML610Q431/2
	48K	Remote Controls for Heaters		Segment type with LCD Driver (Max 144dot to 192dot)			ML610Q428/9
	40K				ML610Q426	Smart Watches	Electronic Sports (Multifunction) Watches
	32K				ML610Q421/2		Dot Matrix type with LCD Driver (Max 400dot to 1536dot)
	24K						
	16K				ML610Q407/8/9	ML610Q411/2	Token Machines, Calculators, Pedometers
	8K						Calculators, Pedometers
	6K				Temperature Loggers, Clocks, Digital Thermometers	Thermostats	ML610Q: Flash ROM No "Q" : MASK ROM
		48pin	64pin	80pin	100pin	120pin	128pin, 144pin

Note: Please refer to the manual for each product regarding individual specifications

Speech Playback MCUs (8bit)

Sound algorithms HQ-ADPCM*1, 4bit ADPCM2, 8bit PCM(non-linear/straight), 16bit PCM(straight)

8bit ML610Q300

The ML610Q300 of CMOS MCUs with speech output function utilizes a proprietary 8bit U8 core to achieve superior performance. In addition, a hardware-based high fidelity speech playback function and high output speaker amplifier make it possible to provide voice functionality on a single chip, improving audio quality, simplifying control, and maximizing MCU performance. This superior playback functionality, combined with a low power high performance U8 core, 3V/5V compatible power supply and broad peripheral control functions, provide a single-chip solution for both battery- and AC-driven products.



8bit ML610Q300 System Block Diagram

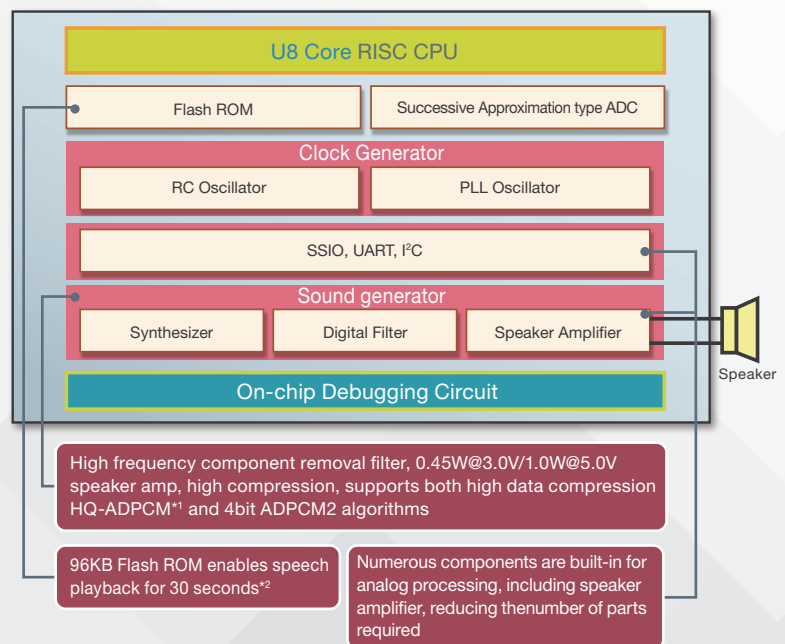

Key Advantage

Integrated peripheral components save space and improve reliability

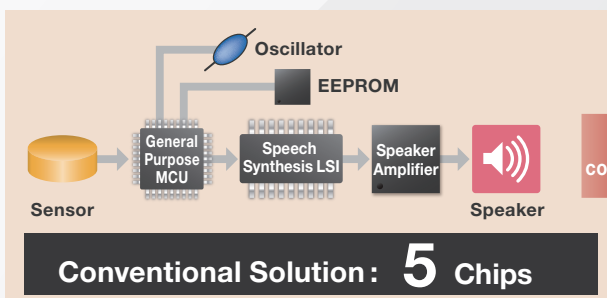

The all-in-one design reduces external component count and saves space while increasing reliability

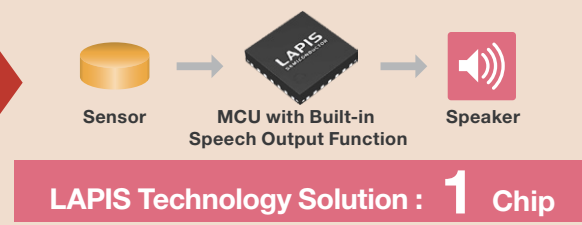

Feature 1

Speech output function on a single chip

- Low-pass filter reduces noise
- Sound algorithms
HQ-ADPCM*1, 4bit ADPCM2, 8bit PCM (non-linear/straight), 16bit PCM (straight)
- 1W speaker amplifier (@5V)
- Power supply voltage range: 2.0V to 5.5V

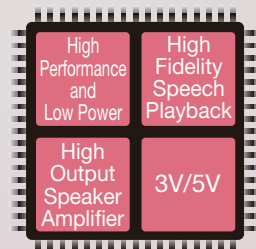

*1: Excluding ML610Q304

*2: Conditions: During 6.4kHz ADPCM2 playback, not including control program capacity

Feature 2

High fidelity, high compression HQ-ADPCM makes it possible to reduce memory capacity

ML610Q305 and ML610Q306 adopt the newly developed high fidelity, high compression sound algorithm HQ-ADPCM that provides a clearer sound and richer audio range while reducing data size compared with conventional ADPCM, providing a more comfortable listening experience. For example, melodies and sound effects that are degraded with ADPCM and cannot be played with uncompressed PCM can be compressed with HQ-ADPCM, ensuring superior sound quality while reducing memory capacity. Up to 80% compression is possible vs. 4bit ADPCM and 20% compared with 16bit ADPCM.

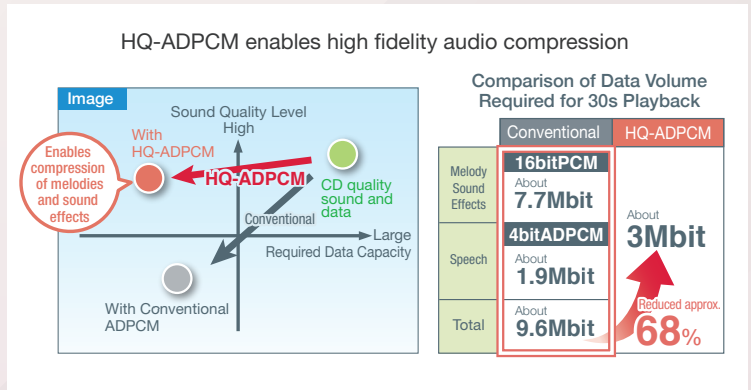

Feature 3

Easy speech playback

- Achieves speech playback functionality by simply setting sound code data in the sound register
- Integrating 16-byte*1/32-byte*2 FIFO into the sound register makes it possible to extend the interval between sound code data request interrupts

Speech Playback Conditions	Sound Code Data Request Interrupt Time*3
16bit PCM at 16kHz	250µs

*1: For ML610Q304
*2: For ML610Q305/ML610Q306
*3: Time from full FIFO to empty

Speech LSI Tools Facilitate Sound Code Data Creation

Run the 'Speech LSI Tools' program on a PC to create sound code data using a speech playback MCU. Speech LSI Tools include a Wave Editor that makes it easy to change (i.e. fade in/out), cut, and connect original sound data (WAVE files) as well as a Speech LSI Utility capable of editing phrases and converting WAVE files to the HQ-ADPCM and ADPCM2 formats.

Speech LSI Tools

- Sound cut/connection
- Fade In/Out, etc.

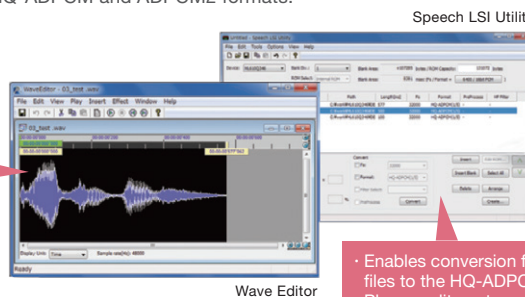

- Enables conversion from WAVE files to the HQ-ADPCM format
- Phrase editor, etc.

Speech LSI Tools Operating Environment

- Microsoft® Windows Windows 7, Windows 8.1, Windows 10
Note: Compatible with 32bit (x86)/64bit (x64) environments
 - Processor and memory Set up according to OS requirements
 - Hard disk space 1GB usable HDD space
 - Audio Windows compatible sound card and speakers
 - USB port
- Note: Program data is developed separately in the LEXIDE-U16 integrated development environment.

UB CORE ML610Q300

ROM (Byte)	Normal type	Fire Alarms	Gas Sensors
96K	ML610Q304	ML610Q305	ML610Q306
	28pin VQFN28	32pin WQFN32 TQFP32	36pin WQFN36

Note: Please refer to the manual for each product regarding individual specifications

[Reference] LAPIS Technology also offers speech synthesis LSIs that can easily be controlled by an MCU

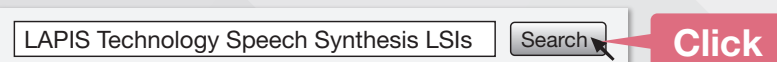

USB Interface & Security Function MCUs (32bit)

Built-in ARM® Cortex®-M0+, USB2.0 Full Speed Device

Provides high performance with Low Power

32bit ML630Q400

ML630Q400 are high-performance 32bit CMOS MCUs that integrate an ARM® Cortex®-M0+.

Feature 1

Low Power Consumption

Achieves a low current consumption of 0.8µA at Halt Mode and 250µA/MHz during normal operation, making it ideal for battery power applications

Feature 2

Multiple Peripherals

Supports a variety of communication methods, including USB2.0 Full Speed, I²C, UART, and SSIO. 2 types of AD converters are built in (RC and SA), along with an LCD driver, making them ideal for data loggers. Also integrates AES and a random number generator necessary for security applications.

Feature 3

High Noise Immunity

Clears ±30kV* during IEC 61000-4-2 electrostatic noise testing, ensuring high noise tolerance.

*Measured by indirect discharge using LAPIS Technology's reference board

32bit ML630Q400 System Block Diagram

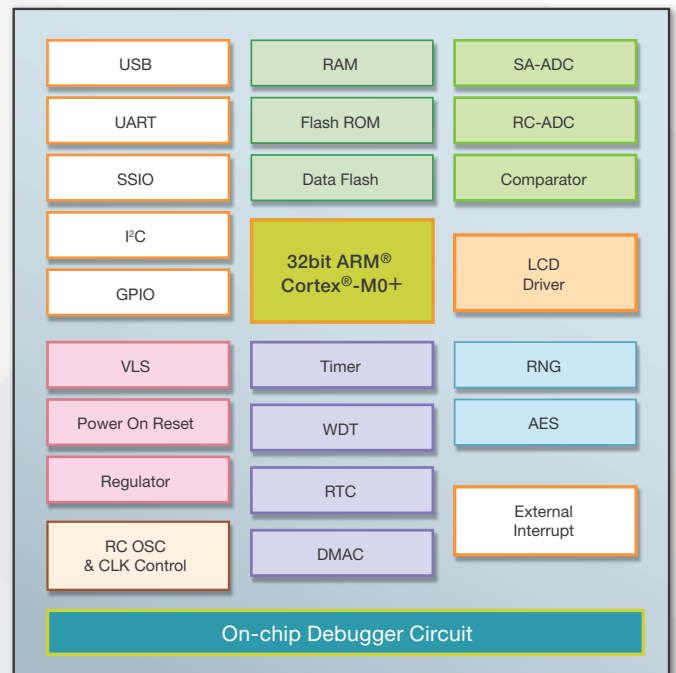

USB PDF Logger Reference Kit

- Software provided for PDF file creation and log data acquisition
- USB mass storage driver makes it possible to access files by connecting to a PC
- Accelerates customer development



[Contents]

- Hardware: ML630Q466 Board
- Hardware Support: Product List, Circuit Diagrams
- Software Support: Source Code (PDF file generation software/USB mass storage device driver/power management driver/RC-ADC driver)

Built-in PDF file generation software

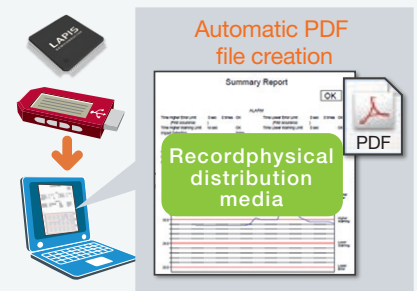

8bit/16bit MCU Development Support System

Consistent support from design and coding to evaluation and ROM code writing

Emulator **EASE1000 V2/Dr.1000**

Reference Board with Built-in Microcontroller and **Software Tools**

LAPIS Technology's program development support system is comprised of software and hardware tools that support program development. The software tools feature a user-friendly interface that makes it possible to efficiently perform a series of tasks from program creation to debugging.

- Integrated software simplifies repeated work required during software development, including programming, building (Object creation), and debugging
- User-friendly graphical user interface
- Supports the open-source Eclipse-based integrated development environment
- Includes enhanced support tools for LCD control development and code generation
- Compact, lightweight on-chip emulator EASE1000 V2
- Full-featured ICE Dr.1000 with enhanced debugging functionality including real-time RAM monitoring and trace functions (Target products: ML62Q1000 series)

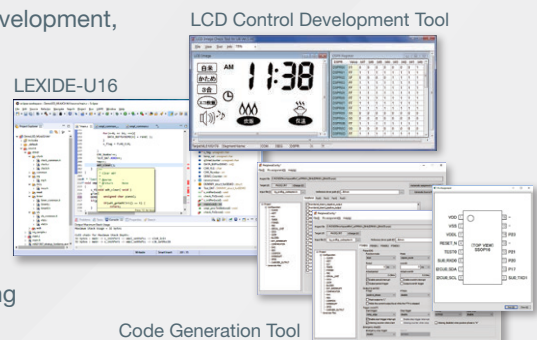

● Program Development Support System

LAPIS Technology provides software for building, debugging, and writing programs.

The LEXIDE-U16 integrated development environment controls the startup of LAPIS Technology's original tools, including build tool settings and tools that enable debugging, Flash writing, and LCD control development support.

The LEXIDE-U16 also integrates project management and editor functions to improve software development operability.

Regarding hardware tools, an on-chip emulator is built in that can rewrite to Flash memory and perform debugging when connected to the actual device along with a full-featured ICE capable of checking all RAM areas without stopping trace or program execution.

LAPIS Technology offers an expansive software development support system that facilitates program development

Development Tools			Support Tools		Boards and Kits	
Integrated Development Environment LEXIDE-U16	On-chip Emulator EASE1000 V2	Full-Featured ICE Dr.1000	Code Generation Tools Startup/Peripheral Setting Tools Startup Setting Tools Peripheral Setting Tools		Reference Board Reference Boards for Each MCU ML62Q1367 Reference Board ML62Q1552 Reference Board	Starter Kit MCU Starter Kit LCD Starter Kit Electrostatic SW Starter Kit
Build Tools <ul style="list-style-type: none"> • CCU8 C Compiler • RASU8 Assembler • RLU8 Linker • OHU8 Converter 	Debugging Tools <ul style="list-style-type: none"> • LEXIDE-U16 debugging function • DTU8 debugger • Simulator 	ROM Code Data Generation Tool <ul style="list-style-type: none"> • HTU8 HEX Converter 	LCD Control Development Support Tools <ul style="list-style-type: none"> • LcdAtU8 LCD image tool 		Online Distributors 	
Flash Programmer Tools			Sample Software <ul style="list-style-type: none"> • Reference software • Self-test sample software and more... 	Materials <ul style="list-style-type: none"> • Replacement Guide for Non-LAPIS MCUs • Code Size Compression Guide • Software Safety Measures • Application Notes and more... 	Online Support Site <ul style="list-style-type: none"> • Provides the latest updates 	
MWU16 Flash Multi Writers Connect up to 32 EASE 1000 V2 units (Free software)			3rd Party Flash Programmer Standalone Writers AF9201 PC-Connected Writers MODEL400+series MODEL308			

Full software tools

LEXIDE-U16 Integrated Development Environment

Our integrated development environment based on open-source Eclipse and CDT plug-in enables high efficiency program development.

- Easy-to-use editor with robust functionality facilitates program editing
- Launch original LAPIS Technology tools such as those for debugging LCD control development, and stack calculation.
- Easily migrate from the existing IDEU8 integrated development environment to LEXIDE-U16.

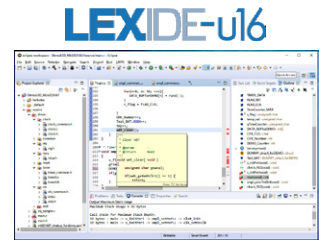

Code Generation Tools

The Code Generation Tool generates various codes, including for the MCU operating mode and initial peripheral settings. Simply set the value in the tool to generate codes that can be immediately verified, enabling efficient program development.

- The Startup Configuration Tool generates setup codes for customizing the startup routine as well as the code option for ML62Q1000 series MCUs.
- The Peripheral Configuration Tool generates code for initializing the general-purpose ports and peripherals of ML62Q1000 series MCUs.

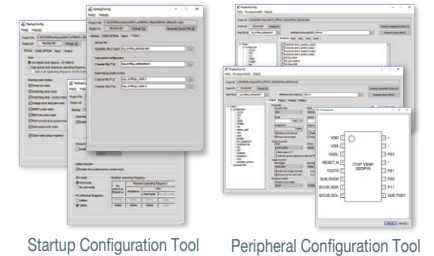

Startup Configuration Tool Peripheral Configuration Tool

LCD image tools LCD control software development support tool

- Inputting a bitmap file of an LCD panel image and LCD panel layout information automatically generates table data for LCD allocation RAM along with a sample control program.
- The LCD image tools efficiently performs complicated mapping operation.
- The LCD image tools consist of an LCD image assignment tool*1 and LCD image verification tool*2.

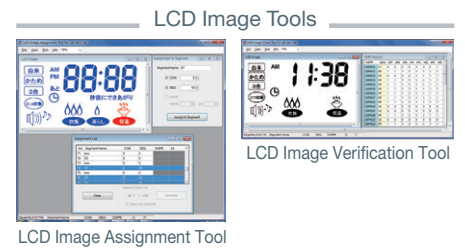

LCD Image Assignment Tool

LCD Image Verification Tool

*1: The LCD image assignment tool supports LCD segment mapping operation with the MCU terminal via an LCD panel image displayed on a PC.
*2: The LCD image verification tool is useful for mapping validation.

Emulators provided for different applications

EASE1000 V2 On-Chip Emulator

On-chip emulator EASE1000 V2 supports Flash rewriting and onboard software debugging by connecting a target device equipped with LAPIS Technology's MCU integrating 8bit/16bit Flash memory with on-chip debugging function.

- Software debugging is possible using emulator and brake functions along with program memory interval/data memory interval/SFR display change functionality
- Connecting to ML62Q1000 series MCUs allows users to carry out real-time watch, branch trace, and stack overshoot/undershoot break functions

Connection Diagram

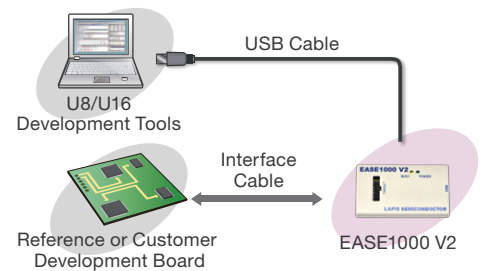

Dr.1000 Full-Featured

The full-featured ICE Dr. 1000 is an emulator for the ML62Q1000 series that supports advanced debugging by including a variety of debugging functions not found in other emulators.

- Efficient debugging is possible using a real-time RAM monitoring function that can verify changes in the entire RAM area without stopping program execution together with a trace function capable of referencing program execution history
- Enables measurement of the execution time for each operating frequency (including standby mode), facilitating low power application development
- Optional flexible cable makes it possible to connect to the mounted IC on the customer's board

Connection Diagram

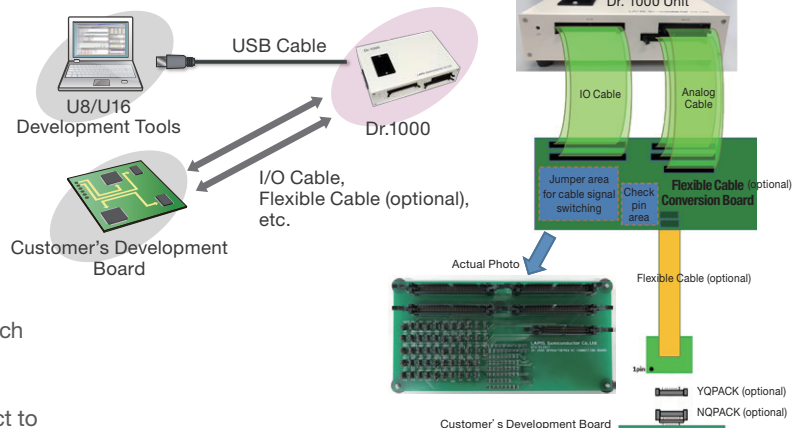

EASE1000 V2 On-Chip Emulator and Full-Featured ICE Dr.1000 Specifications Overview

	EASE1000 V2		New Dr.1000
Compatible Devices	ML620Q500/ML610Q400/ML610Q300	ML62Q1000	ML62Q1000 series (QFP64/TQFP64 or lower package) MCU*2
Operating Voltage	VDD (input voltage to the VTref signal) 1.6V to 5.5V		Internal: 3.3V, External: 1.8V to 5.5V* Operating voltage switching: internal/external voltage via slide switch
Output Voltage for Target LSI	3.3V(Typ) / 100mA(Max)		—
Operating Clock	—		Low-speed clock: 32.768kHz, High-speed clock: 16MHz/24MHz (code option switchable)
Memory	—		Program memory: 512KB*3, Data memory (data RAM): 32KB*3, Data memory (data Flash): 8KB*3
Real-Time Watchdog Function	—	Real-time watch: 2pts Max	Real-time RAM monitor (full area display of data RAM) Real-time watch: Up to 254pts (SFR: Up to 64pts included)
Branch Trace Function	—	Up to 170 branches	—
Trace Function	—	—	Up to 256K steps Internal: Execution address, RAM address, RAM data, PSW, probe, interrupt transition cycle Start Conditions: Free run, RAM data match, PC match, disable, Stop Conditions: PC match, disable, continue/stop switching after trace pointer overflow
Emulation	Real-time emulation/step emulation step in/step out/step over		
Break	Forced break, software breakpoint break, address break, RAM match break		
	Hardware breakpoint break: Up to 4pts (set/release during emulation)		Hardware breakpoint break: Up to 20pts (set/release during emulation: possible)
	Sequential break, stack pointer overflow break, stack pointer underflow break		
	—	Branch trace overflow break, illegal memory access break, RAM parity error break	Trace overflow break, power down break, external break, ROM N area break, RAM N area break
Display/Change	Program memory space/data memory space/SFR		
Execution Time Measurement	Branch Trace	Unit: 100µs Max measurement time: 119hrs (free run)	
	Cycle Counter	—	32bit counter (free run) Cycle counter by operating frequency (free run) Cycle counter between 2 (arbitrary) points (free run)
Coverage Function	—	√*1	512KB total space
Sync Out (Synchronous Signal Output) Function	—		Up to 5 pts, trigger method
User RESET Input	✓		Reset Enable/Disable switchable
Probe	—		Input probes: 2 (external break), sync out: 1, trace: 5
Host Interface	USB2.0 Full-Speed		
Supply Voltage	+5V, 500mA (supplied from USB VBUS on Host PC side)		+5V, 2A (AC adapter)
External Dimensions W×H×D (mm)	50×17×90		260×78×185

*1: Uses branch trace information *2: The ML62Q1300 family and other models are currently under development *3: Valid only for the memory space of the set model

Flash Programmer

MWU16 Flash Multi-Writer*

Supports simultaneous Flash programming of multiple boards of the same type. It can also be set to 'Simple GUI Mode' to prevent accidental operation.

*The requisite number of EASE1000 V2 units must be purchased to use MWU16.

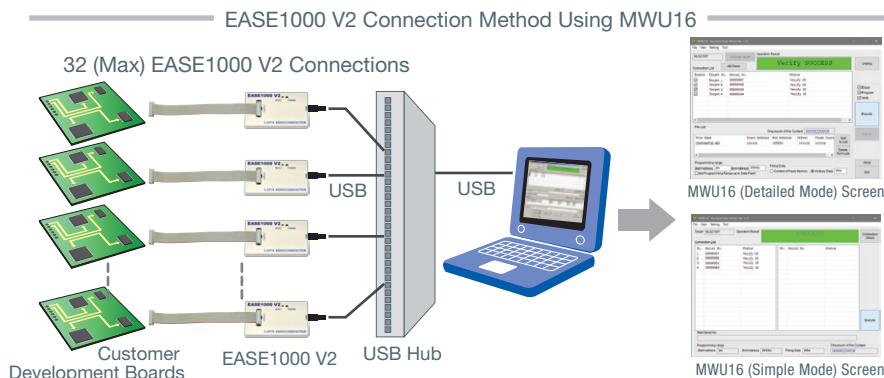

3rd Party Flash Programmer

Supports onboard/offboard writing to Flash memory.

Supports onboard writing to Flash memory without a PC



TOA ELECTRONICS, Inc.
Flash Support Group Company
AF9201

Flash Support Group

<http://www.j-fsg.co.jp/en/>

Supports offboard PC-controlled writing

Minato Advanced Technologies Inc.



MODEL416e+

MODEL400e+series
MODEL404e+
MODEL408e+
MODEL416e+















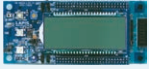

MODEL308

MINATO

MINATO ADVANCED TECHNOLOGIES INC. <https://www.minatoat.co.jp/en/>

Note: Please contact each manufacturer directly for 3rd Party Flash Programmer

Development Support System Product Lineup

Product	Applicable Models	Main Contents				Notes
EASE1000 V2	ML62Q1000 ML620Q500 ML610Q400 ML610Q300	  <p>On-chip Emulator EASE1000 V2</p> <p>U8/U16 Development Tools</p>	EASE1000 V2	1	—	
			EASE1000 V2 Interface Cable	1		
			USB Cable	1		
			U8/U16 Development Tools*1*2	DVD 1		
Reference Board	Please contact LAPIS Technology for applicable models.	 <p>Reference Board with built-in MCU</p>	Reference Board Unit User's Manual*2	1 set	—	
ML62Q1000 MCU Starter Kit	ML62Q1577	   <p>ML62Q1577 Reference Board</p> <p>On-chip Emulator EASE1000 V2</p> <p>U8/U16 Development Tools Sample Program</p>	EASE1000 V2	1	—	
			ML62Q1577 Reference Board	1		
			EASE1000 V2 Interface Cable	1		
			USB Cable	1		
			U8/U16 Development Tools*1*2 Sample Program	DVD 1		
ML62Q1000 LCD Starter Kit	ML62Q1747	   <p>ML62Q1747 Reference Board + ML62Q1000 LCD Board S1</p> <p>On-chip Emulator EASE1000 V2</p> <p>U8/U16 Development Tools Sample Program</p>	EASE1000 V2	1	—	
			ML62Q1747 Reference Board	1		
			ML62Q1000 LCD Board S1	1		
			EASE1000 V2 Interface Cable	1		
			USB Cable	2		
			U8/U16 Development Tools*1*2 Sample Program	DVD 1		
ML62Q1000 Capacitive Switch Starter Kit	ML62Q1367	    <p>ML62Q1367 Capacitive Switch Application Board</p> <p>On-chip Emulator EASE1000 V2</p> <p>U8/U16 Development Tools Sample Program</p> <p>Speaker</p>	ML62Q1367 Capacitive Switch Application Board	1	—	
			EASE1000 V2	1		
			EASE1000 V2 Interface Cable	1		
			USB Cable	2		
			Speaker	1		
			U8/U16 Development Tools*1*2 Sample Program	DVD 1		
New Dr.1000	ML62Q1000 series (QFP64/TQFP64 or lower package) MCU	  <p>Full-Featured ICE Dr.1000</p> <p>U8/U16 Development Tools</p>	Dr. 1000 Unit	1	—	
			IO Cable	1		
			LCD Cable	1		
			Analog Cable	1		
			Monitor Cable	1		
			Probe Cable	1		
			USB Cable	1		
			AC Power Supply Cable	1		
			AC Power Pack	1		
			U8/U16 Development Tools*1*2	DVD 1		
	Optional	Part Name	Package	Part No.	Where to Buy	—
		Flex Cable Conversion Board for QFP64/TQFP64 Packages	QFP64/TQFP64	DR1000-FLQ-64	Please contact to the sales.	
		Flexible Cable (Including Conversion Adapter)	QFP64 TQFP64	TEC-064SA-KC TEC-064SD-KC		
		YQPACK	QFP64 TQFP64	YQPACK064SA YQPACK064SD	Elematec Co., Ltd. (Fukuoka Branch)	
NQPACK	QFP64 TQFP64	NQPACK064SA NQPACK064SD-ND	Contact Information: 2-11-3 Mikasagawa, Onojo City, Fukuoka 816-0912 Tel: +81-92-513-9889			
Code Generation Tools	ML62Q1000	Startup Setting Tools Peripheral Setting Tools			Available for download from LAPIS Technology's support site for low power MCUs.	

*1 The U8/U16 Development Tools package includes the following
 · Project management tool · LcdAtU8LCD image tool
 · Build tool · ROM code generating tool for code entry
 · Debugging tool · User's manual for each tool
 · Flash programming tool

*2 Software and manuals can be downloaded from our Low Power Microcontroller page (registration required)

LAPIS Technology Support Site

LAPIS Technology's support site is a special website that gives registered users quick access to the latest versions of the datasheets, user's manuals, and software tools. Users can also opt to receive notifications of updates via E-mail.

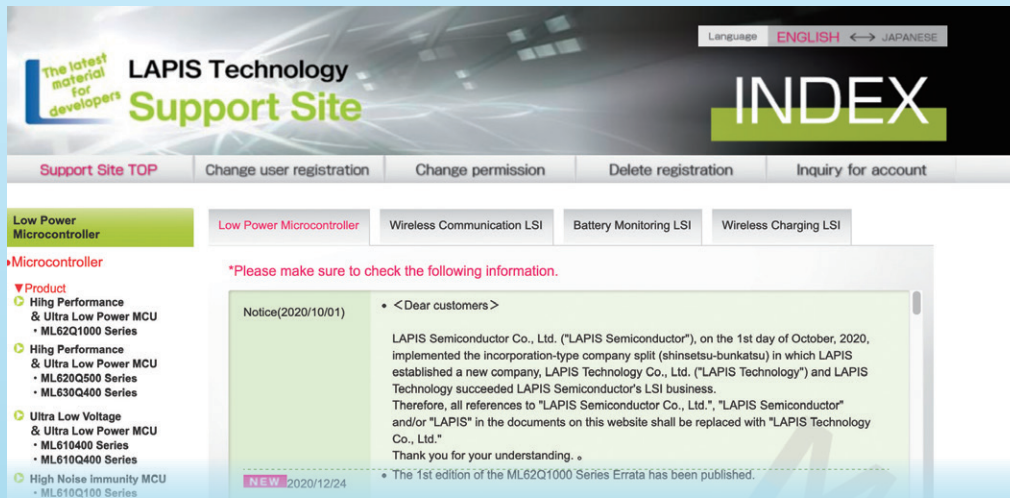

Download materials from our dedicated support site

- ① LSI Datasheets/User's Manuals
Download materials including preliminary datasheets on the newest products
- ② Development Support Site
 - ◆ Software tools
 - Development tools (i.e. integrated development environment, build tools, debuggers, flash programmer, ROM code generation)
 - Support tools (code generation, LCD image)
 - Sample programs (e.g. reference software/self-test/IAP/starter kit sample software)
 - Speech LSI Tools
 - Device information files etc.
 - ◆ Hardware tool manuals
 - On-chip emulator EASE1000 V2
 - MCU reference boards
 - Starter kit etc.
- ③ Various documents and materials
MCU replacement guide, code size compression guide, software safety measures, application notes, and more...

Note: Registration of the development tool serial number is required to download software tools.

Support Site Registration Method

Registration is required to access the site using an ID and Password. Navigate to the support page by clicking on a link on LAPIS Technology's home page or by entering the URL in the browser's address bar. Then click on the 'New registration' link.

Support page URL ► <https://www.lapis-semi.com/cgi-bin/MyLAPIS/regi/login.cgi>



LAPIS Technology Website



Support Site Registration/Login Page

[Registration Procedure Flow]

Register by clicking on the 'New registration' button on the Support Site's Login Page.



Product Specifications

General-Purpose MCUs (16bit) ML62Q1000 series

Normal type ML62Q1300 Group 16bit MCU (Industrial Grade)

Part No.	Operating Voltage (V)	ROM type	ROM Capacity (Byte)	Data Flash Capacity (Byte)	RAM Capacity (Byte)	Port			Operating Frequency (Max)		Minimum Instruction Execution Time	Current Consumption (Typ@HALT)	Operating Temperature (°C)
						Input	Output	Input/Output	Low Speed	High Speed			
New ML62Q1323	1.6 to 5.5	Flash	16K	2K	2K	—	—	12	32.768kHz (Internal RC oscillation)	24MHz (PLL oscillation)	41ns 30.5µs	4.3µA (Internal RC oscillation)	-40 to +105
New ML62Q1324			24K										
New ML62Q1325			32K										
New ML62Q1333	1.6 to 5.5	Flash	16K	2K	2K	—	—	16	32.768kHz (Internal RC oscillation)	24MHz (PLL oscillation)	41ns 30.5µs	4.3µA (Internal RC oscillation)	-40 to +105
New ML62Q1334			24K										
New ML62Q1335			32K										
ML62Q1345	1.6 to 5.5	Flash	32K	2K	4K	—	—	20	32.768kHz (Internal RC oscillation)	24MHz (PLL oscillation)	41ns 30.5µs	4.3µA (Internal RC oscillation)	-40 to +105
ML62Q1346			48K										
ML62Q1347			64K										
ML62Q1365	1.6 to 5.5	Flash	32K	2K	4K	—	—	28	32.768kHz (Internal RC oscillation)	24MHz (PLL oscillation)	41ns 30.5µs	4.3µA (Internal RC oscillation)	-40 to +105
ML62Q1366			48K										
ML62Q1367			64K										

*1 A check mark of halogen free support means that we will be able to ship out the halogen free products. For details, please inquire to the sales.

*2 For use of industrial equipment, please inquire to the sales.

16bit Timer	16bit Multi Functions Timer	WDT	ADC (method)	DAC	Serial Port			Supply Voltage Detection	LCD Driver	External Interrupt Sources	Others	Notes	Package	Chip Support	Halogen Free Support*1	Industrial Grade*2
					PC	SSIO	UART									
4 (8bitx8)	4 (TMR, PWM, IGBT, Capture)	1	10bitx6 (SA type)	-	Master Slavex1 Masterx1	UART Full Duplex/ SSIOx2	VLSx1	-	8	Comparatorx1, DMA, Multiplier/Divider	-	P-SSOP16-0225-0.65	-	✓	✓	
												P-WQFN16-0404-0.50	-	✓	✓	
												P-SSOP16-0225-0.65	-	✓	✓	
4 (8bitx8)	4 (TMR, PWM, IGBT, Capture)	1	10bitx8 (SA type)	-	Master Slavex1 Masterx1	UART Full Duplex/ SSIOx2	VLSx1	-	8	Comparatorx1, DMA, Multiplier/Divider	-	P-TSSOP20-0225-0.65	-	✓	✓	
												P-TSSOP20-0225-0.65	-	✓	✓	
												P-TSSOP20-0225-0.65	-	✓	✓	
6 (8bitx12)	4 (TMR, PWM, IGBT, Capture)	1	10bitx8 (SA type)	8bitx1	Master Slavex1 Masterx1	UART Full Duplex/ SSIOx2	VLSx1	-	8	Comparatorx1, DMA, Multiplier/Divider	-	P-WQFN24-0404-0.50	-	✓	✓	
												P-WQFN24-0404-0.50	-	✓	✓	
												P-WQFN24-0404-0.50	-	✓	✓	
6 (8bitx12)	4 (TMR, PWM, IGBT, Capture)	1	10bitx8 (SA type)	8bitx1	Master Slavex1 Masterx1	UART Full Duplex/ SSIOx2	VLSx1	-	8	Comparatorx1, DMA, Multiplier/Divider	-	P-TQFP32-0707-0.80	-	✓	✓	
												P-WQFN32-0505-0.50	-	✓	✓	
												P-TQFP32-0707-0.80	-	✓	✓	
												P-WQFN32-0505-0.50	-	✓	✓	

16bit
ML62Q1000 series

16bit
ML62Q0500

8bit
ML610400/ML610Q400

8bit
ML6100300

32bit
ML630Q400

ML62Q1000 series Part Number Explanation



① Device type

ML: Bipolar Logic

② CPU Core type

62: 16bit CPU nX-U16/100

③ ROM type

Q: Flash ROM

⑤ Option Code

None to x: Set for product

⑥ ROM Code

NNN: Blank
001 to xxx: Custom Code Number

⑦ Package Code

GD: WQFN
MB: SSOP
TD: TSSOP
TB: TQFP
GA: QFP

⑧ Company's code in LAPIS Technology

④ Part Code

13xx: ML62Q1300 group

2x: 16pin

3x: 20pin

4x: 24pin

6x: 32pin

x3: ROM 16KB

x4: ROM 24KB

x5: ROM 32KB

x6: ROM 48KB

x7: ROM 64KB

15xx: ML62Q1500 group

3x: 48pin

4x: 52pin

5x: 64pin

6x: 80pin

7x: 100pin

x0: ROM 32KB

x1: ROM 48KB

x2: ROM 64KB

x3: ROM 96KB

x4: ROM 128KB

x5: ROM 160KB

x6: ROM 192KB

x7: ROM 256KB

17xx: ML62Q1700 group (Built-in LCD Driver)

0x: 48pin

1x: 52pin

2x: 64pin

3x: 80pin

4x: 100pin

x0: ROM 32KB

x1: ROM 48KB

x2: ROM 64KB

x3: ROM 96KB

x4: ROM 128KB

x5: ROM 160KB

x6: ROM 192KB

x7: ROM 256KB

x8: ROM 384KB

x9: ROM 512KB

18xx: ML62Q1800 group

5x: 64pin

6x: 80pin

7x: 100pin

x8: ROM 384KB

x9: ROM 512KB

Product Specifications

General-Purpose MCUs (16bit) ML62Q1000 series

Normal type ML62Q1500 Group 16bit MCU (Industrial Grade)

Part No.	Operating Voltage (V)	ROM type	ROM Capacity (Byte)	Data Flash Capacity (Byte)	RAM Capacity (Byte)	Port			Operating Frequency (Max)		Minimum Instruction Execution Time	Current Consumption (Typ@HALT)	Operating Temperature (°C)
						Input	Output	Input/Output	Low Speed	High Speed			
ML62Q1530	1.6 to 5.5	Flash	32K	4K	8K	2	-	42	32.768kHz (Internal RC oscillation/ Crystal oscillation)	24MHz (PLL oscillation)	41ns 30.5µs	4.7/3.0µA (Internal RC oscillation/ Crystal oscillation)	-40 to +105
ML62Q1531			48K										
ML62Q1532			64K										
ML62Q1533			96K										
ML62Q1534			128K										
ML62Q1540	1.6 to 5.5	Flash	32K	4K	8K	2	-	46	32.768kHz (Internal RC oscillation/ Crystal oscillation)	24MHz (PLL oscillation)	41ns 30.5µs	4.7/3.0µA (Internal RC oscillation/ Crystal oscillation)	-40 to +105
ML62Q1541			48K										
ML62Q1542			64K										
ML62Q1543			96K										
ML62Q1544			128K										
ML62Q1550	1.6 to 5.5	Flash	32K	4K	8K	2	-	58	32.768kHz (Internal RC oscillation/ Crystal oscillation)	24MHz (PLL oscillation)	41ns 30.5µs	4.7/3.0µA (Internal RC oscillation/ Crystal oscillation)	-40 to +105
ML62Q1551			48K										
ML62Q1552			64K										
ML62Q1553			96K										
ML62Q1554			128K	16K	2	-	58	4.7/3.0µA (Internal RC oscillation/ Crystal oscillation)					
ML62Q1555			160K										
ML62Q1556			192K										
ML62Q1557			256K										
ML62Q1563	1.6 to 5.5	Flash	96K	4K	16K	2	-	72	32.768kHz (Internal RC oscillation/ Crystal oscillation)	24MHz (PLL oscillation)	41ns 30.5µs	5.5/4.5µA (Internal RC oscillation/ Crystal oscillation)	-40 to +105
ML62Q1564			128K										
ML62Q1565			160K										
ML62Q1566			192K										
ML62Q1567			256K										
ML62Q1573	1.6 to 5.5	Flash	96K	4K	16K	2	-	92	32.768kHz (Internal RC oscillation/ Crystal oscillation)	24MHz (PLL oscillation)	41ns 30.5µs	5.5/4.5µA (Internal RC oscillation/ Crystal oscillation)	-40 to +105
ML62Q1574			128K										
ML62Q1575			160K										
ML62Q1576			192K										
ML62Q1577			256K										
New ML62Q1543C	1.6 to 5.5	Flash	96K	4K	8K	2	-	46	32.768kHz (Internal RC oscillation/ Crystal oscillation)	24MHz (PLL oscillation)	41ns 30.5µs	4.3/3.0µA (Internal RC oscillation/Crystal oscillation)	-40 to +105
New ML62Q1544C			128K										
New ML62Q1553C	1.6 to 5.5	Flash	96K	4K	8K	2	-	58	32.768kHz (Internal RC oscillation/ Crystal oscillation)	24MHz (PLL oscillation)	41ns 30.5µs	4.3/3.0µA (Internal RC oscillation/Crystal oscillation)	-40 to +105
New ML62Q1554C			128K										
New ML62Q1563C	1.6 to 5.5	Flash	96K	4K	8K	2	-	74	32.768kHz (Internal RC oscillation/ Crystal oscillation)	24MHz (PLL oscillation)	41ns 30.5µs	4.3/3.0µA (Internal RC oscillation/Crystal oscillation)	-40 to +105
New ML62Q1564C			128K										

*1 A check mark of halogen free support means that we will be able to ship out the halogen free products. For details, please inquire to the sales.
 *2 For use of industrial equipment, please inquire to the sales.

	16bit Timer	16bit Multi Functions Timer	WDT	ADC (method)	DAC	Serial Port			Supply Voltage Detection	LCD Driver	External Interrupt Sources	Others	Notes	Package	Chip Support	Halogen Free Support*1	Industrial Grade*2
						FC	SSIO	UART									
	6 (8bitx12)	6 (TMR, PWM, IGBT, Capture)	1	10bitx12 (SA type)	8bitx1	Master Slavex1 Masterx2	UART Full Duplex/ SSIOx2	VLSx1	-	10	Comparatorx2, DMA, Multiplier/Divider	-	P-TQFP48-0707-0.50	-	✓	✓	
P-TQFP48-0707-0.50													-	✓	✓		
P-TQFP48-0707-0.50													-	✓	✓		
P-TQFP48-0707-0.50													-	✓	✓		
	6 (8bitx12)	6 (TMR, PWM, IGBT, Capture)	1	10bitx12 (SA type)	8bitx1	Master Slavex1 Masterx2	UART Full Duplex/ SSIOx2	VLSx1	-	10	Comparatorx2, DMA, Multiplier/Divider	-	P-TQFP52-1010-0.65	-	✓	✓	
P-TQFP52-1010-0.65													-	✓	✓		
P-TQFP52-1010-0.65													-	✓	✓		
P-TQFP52-1010-0.65													-	✓	✓		
	6 (8bitx12)	6 (TMR, PWM, IGBT, Capture)	1	10bitx12 (SA type)	8bitx1	Master Slavex1 Masterx2	UART Full Duplex/ SSIOx2	VLSx1	-	10	Comparatorx2, DMA, Multiplier/Divider	-	P-QFP64-1414-0.80	-	✓	✓	
P-TQFP64-1010-0.50													-	✓	✓		
P-QFP64-1414-0.80													-	✓	✓		
P-TQFP64-1010-0.50													-	✓	✓		
P-QFP64-1414-0.80													-	✓	✓		
P-TQFP64-1010-0.50													-	✓	✓		
P-QFP64-1414-0.80													-	✓	✓		
P-TQFP64-1010-0.50													-	✓	✓		
P-QFP64-1414-0.80													-	✓	✓		
P-TQFP64-1010-0.50													-	✓	✓		
	8 (8bitx16)	8 (TMR, PWM, IGBT, Capture)	1	10bitx16 (SA type)	8bitx2	Master Slavex1 Masterx2	UART Full Duplex/ SSIOx6	VLSx1	-	12	Comparatorx2, DMA, Multiplier/Divider	-	P-QFP80-1414-0.65	-	✓	✓	
P-QFP80-1414-0.65													-	✓	✓		
P-QFP80-1414-0.65													-	✓	✓		
P-QFP80-1414-0.65													-	✓	✓		
	8 (8bitx16)	8 (TMR, PWM, IGBT, Capture)	1	10bitx16 (SA type)	8bitx2	Master Slavex1 Masterx2	UART Full Duplex/ SSIOx6	VLSx1	-	12	Comparatorx2, DMA, Multiplier/Divider	-	P-QFP100-1420-0.65	-	✓	✓	
P-TQFP100-1414-0.50													-	✓	✓		
P-QFP100-1420-0.65													-	✓	✓		
P-TQFP100-1414-0.50													-	✓	✓		
P-QFP100-1420-0.65													-	✓	✓		
P-TQFP100-1414-0.50													-	✓	✓		
	6 (8bitx12)	6 (TMR, PWM, IGBT, Capture)	1	10bitx12 (SA type)	8bitx1	Master Slavex1 Masterx2	UART Full Duplex/ SSIOx3	VLSx1	-	10	Comparatorx2, DMA, Multiplier/Divider	-	P-TQFP52-1010-0.65	-	✓	✓	
P-TQFP52-1010-0.65													-	✓	✓		
	6 (8bitx12)	6 (TMR, PWM, IGBT, Capture)	1	10bitx12 (SA type)	8bitx1	Master Slavex1 Masterx2	UART Full Duplex/ SSIOx4	VLSx1	-	10	Comparatorx2, DMA, Multiplier/Divider	-	P-QFP64-1414-0.80	-	✓	✓	
P-TQFP64-1010-0.50													-	✓	✓		
P-TQFP64-1010-0.50													-	✓	✓		
	6 (8bitx12)	6 (TMR, PWM, IGBT, Capture)	1	10bitx12 (SA type)	8bitx1	Master Slavex1 Masterx2	UART Full Duplex/ SSIOx4	VLSx1	-	12	Comparatorx2, DMA, Multiplier/Divider	-	P-QFP80-1414-0.65	-	✓	✓	
P-QFP80-1414-0.65													-	✓	✓		

16bit
ML62Q1000 series

16bit
ML62Q0500

8bit
ML610400/ML610Q400

8bit
ML6100300

32bit
ML630Q400

Product Specifications

General-Purpose MCUs (16bit) ML62Q1000 series

Built-in LCD Driver Segments type ML62Q1700 Group 16bit MCU (Industrial Grade)

Part No.	Operating Voltage (V)	ROM type	ROM Capacity (Byte)	Data Flash Capacity (Byte)	RAM Capacity (Byte)	Port			Operating Frequency (Max)		Minimum Instruction Execution Time	Current Consumption (Typ@HALT)	Operating Temperature (°C)
						Input	Output	Input/Output	Low Speed	High Speed			
ML62Q1700	1.6 to 5.5	Flash	32K	4K	8K	2	-	37	32.768kHz (Internal RC oscillation/ Crystal oscillation)	24MHz (PLL oscillation)	41ns 30.5µs	4.9/3.3µA (Internal RC oscillation/ Crystal oscillation)	-40 to +105
ML62Q1701			48K										
ML62Q1702			64K										
ML62Q1703			96K										
ML62Q1704			128K										
ML62Q1710	1.6 to 5.5	Flash	32K	4K	8K	2	-	41	32.768kHz (Internal RC oscillation/ Crystal oscillation)	24MHz (PLL oscillation)	41ns 30.5µs	4.9/3.3µA (Internal RC oscillation/ Crystal oscillation)	-40 to +105
ML62Q1711			48K										
ML62Q1712			64K										
ML62Q1713			96K										
ML62Q1714			128K										
ML62Q1720	1.6 to 5.5	Flash	32K	4K	8K	2	-	53	32.768kHz (Internal RC oscillation/ Crystal oscillation)	24MHz (PLL oscillation)	41ns 30.5µs	4.9/3.3µA (Internal RC oscillation/ Crystal oscillation)	-40 to +105
ML62Q1721			48K										
ML62Q1722			64K										
ML62Q1723			96K										
ML62Q1724			128K										
ML62Q1725			160K	16K									
ML62Q1726			192K										
ML62Q1727			256K										
ML62Q1728			384K		8K							32K	
ML62Q1729			512K										
ML62Q1733	1.6 to 5.5	Flash	96K	4K	16K	2	-	67	32.768kHz (Internal RC oscillation/ Crystal oscillation)	24MHz (PLL oscillation)	41ns 30.5µs	5.7/4.5µA (Internal RC oscillation/ Crystal oscillation)	-40 to +105
ML62Q1734			128K										
ML62Q1735			160K										
ML62Q1736			192K										
ML62Q1737			256K										
ML62Q1738			384K	8K	32K								
ML62Q1739			512K										
ML62Q1743	1.6 to 5.5	Flash	96K	4K	16K	2	-	87	32.768kHz (Internal RC oscillation/ Crystal oscillation)	24MHz (PLL oscillation)	41ns 30.5µs	5.7/4.5µA (Internal RC oscillation/ Crystal oscillation)	-40 to +105
ML62Q1744			128K										
ML62Q1745			160K										
ML62Q1746			192K										
ML62Q1747			256K										
ML62Q1748			384K	8K	32K								
ML62Q1749			512K										
New ML62Q1713C	1.6 to 5.5	Flash	96K	4K	8K	2	-	41	32.768kHz (Internal RC oscillation/ Crystal oscillation)	24MHz (PLL oscillation)	41ns 30.5µs	4.3/3.0µA (Internal RC oscillation/ Crystal oscillation)	-40 to +105
New ML62Q1714C			128K										
New ML62Q1723C	1.6 to 5.5	Flash	96K	4K	8K	2	-	53	32.768kHz (Internal RC oscillation/ Crystal oscillation)	24MHz (PLL oscillation)	41ns 30.5µs	4.3/3.0µA (Internal RC oscillation/ Crystal oscillation)	-40 to +105
New ML62Q1724C			128K										
New ML62Q1733C	1.6 to 5.5	Flash	96K	4K	8K	2	-	69	32.768kHz (Internal RC oscillation/ Crystal oscillation)	24MHz (PLL oscillation)	41ns 30.5µs	4.3/3.0µA (Internal RC oscillation/ Crystal oscillation)	-40 to +105
New ML62Q1734C			128K										

*1 A check mark of halogen free support means that we will be able to ship out the halogen free products. For details, please inquire to the sales.
*2 For use of industrial equipment, please inquire to the sales.

Normal type ML62Q1800 Group 16bit MCU (Industrial Grade)

Part No.	Operating Voltage (V)	ROM type	ROM Capacity (Byte)	Data Flash Capacity (Byte)	RAM Capacity (Byte)	Port			Operating Frequency (Max)		Minimum Instruction Execution Time	Current Consumption (Typ@HALT)	Operating Temperature (°C)
						Input	Output	Input/Output	Low Speed	High Speed			
New ML62Q1858	1.6 to 5.5	Flash	384K	8K	32K	2	-	58	32.768kHz (Internal RC oscillation/ Crystal oscillation)	24MHz (PLL oscillation)	41ns 30.5µs	6.0/4.5µA (Internal RC oscillation/ Crystal oscillation)	-40 to +105
New ML62Q1859			512K										
New ML62Q1868	1.6 to 5.5	Flash	384K	8K	32K	2	-	72	32.768kHz (Internal RC oscillation/ Crystal oscillation)	24MHz (PLL oscillation)	41ns 30.5µs	6.0/4.5µA (Internal RC oscillation/ Crystal oscillation)	-40 to +105
New ML62Q1869			512K										
New ML62Q1878	1.6 to 5.5	Flash	384K	8K	32K	2	-	92	32.768kHz (Internal RC oscillation/ Crystal oscillation)	24MHz (PLL oscillation)	41ns 30.5µs	6.0/4.5µA (Internal RC oscillation/ Crystal oscillation)	-40 to +105
New ML62Q1879			512K										

*1 A check mark of halogen free support means that we will be able to ship out the halogen free products. For details, please inquire to the sales.
*2 For use of industrial equipment, please inquire to the sales.

16bit Timer	16bit Multi Functions Timer	WDT	ADC (method)	DAC	Serial Port			Supply Voltage Detection	LCD Driver	External Interrupt Sources	Others	Notes	Package	Chip Support	Halogen Free Support*1	Industrial Grade*2
					FC	SSIO	UART									
6 (8bitx12)	6 (TMR, PWM, IGBT, Capture)	1	10bitx12 (SA type)	8bitx1	Master Slavex1 Masterx2	UART Full Duplex/ SSIOx2	VLSx1	Max 192dot 24segx 8com	10	Comparatorx2, DMA, Multiplier/Divider	-	P-TQFP48-0707-0.50	-	✓	✓	
												P-TQFP48-0707-0.50	-	✓	✓	
												P-TQFP48-0707-0.50	-	✓	✓	
												P-TQFP48-0707-0.50	-	✓	✓	
6 (8bitx12)	6 (TMR, PWM, IGBT, Capture)	1	10bitx12 (SA type)	8bitx1	Master Slavex1 Masterx2	UART Full Duplex/ SSIOx2	VLSx1	Max 216dot 27segx 8com	10	Comparatorx2, DMA, Multiplier/Divider	-	P-TQFP52-1010-0.65	-	✓	✓	
												P-TQFP52-1010-0.65	-	✓	✓	
												P-TQFP52-1010-0.65	-	✓	✓	
												P-TQFP52-1010-0.65	-	✓	✓	
6 (8bitx12)	6 (TMR, PWM, IGBT, Capture)	1	10bitx12 (SA type)	8bitx1	Master Slavex1 Masterx2	UART Full Duplex/ SSIOx2	VLSx1	Max 280dot 35segx 8com	10	Comparatorx2, DMA, Multiplier/Divider	-	P-QFP64-1414-0.80	-	✓	✓	
												P-TQFP64-1010-0.50	-	✓	✓	
												P-QFP64-1414-0.80	-	✓	✓	
												P-TQFP64-1010-0.50	-	✓	✓	
												P-QFP64-1414-0.80	-	✓	✓	
												P-TQFP64-1010-0.50	-	✓	✓	
												P-QFP64-1414-0.80	-	✓	✓	
												P-TQFP64-1010-0.50	-	✓	✓	
												P-QFP64-1414-0.80	-	✓	✓	
												P-TQFP64-1010-0.50	-	✓	✓	
												P-QFP64-1414-0.80	-	✓	✓	
												P-TQFP64-1010-0.50	-	✓	✓	
8 (8bitx16)	8 (TMR, PWM, IGBT, Capture)	1	10bitx16 (SA type)	8bitx2	Master Slavex1 Masterx2	UART Full Duplex/ SSIOx6	VLSx1	Max 360dot 45segx 8com	12	Comparatorx2, DMA, Multiplier/Divider	-	P-QFP80-1414-0.65	-	✓	✓	
												P-QFP80-1414-0.65	-	✓	✓	
												P-QFP80-1414-0.65	-	✓	✓	
												P-QFP80-1414-0.65	-	✓	✓	
												P-QFP80-1414-0.65	-	✓	✓	
												P-QFP80-1414-0.65	-	✓	✓	
8 (8bitx16)	8 (TMR, PWM, IGBT, Capture)	1	10bitx16 (SA type)	8bitx2	Master Slavex1 Masterx2	UART Full Duplex/ SSIOx6	VLSx1	Max 480dot 60segx 8com	12	Comparatorx2, DMA, Multiplier/Divider	-	P-QFP100-1420-0.65	-	✓	✓	
												P-TQFP100-1414-0.50	-	✓	✓	
												P-QFP100-1420-0.65	-	✓	✓	
												P-TQFP100-1414-0.50	-	✓	✓	
												P-QFP100-1420-0.65	-	✓	✓	
												P-TQFP100-1414-0.50	-	✓	✓	
												P-QFP100-1420-0.65	-	✓	✓	
												P-TQFP100-1414-0.50	-	✓	✓	
6 (8bitx12)	6 (TMR, PWM, IGBT, Capture)	1	10bitx12 (SA type)	8bitx1	Master Slavex1 Masterx2	UART Full Duplex/ SSIOx3	VLSx1	Max 216dot 27segx 8com	10	Comparatorx2, DMA, Multiplier/Divider	-	P-TQFP52-1010-0.65	-	✓	✓	
												P-TQFP52-1010-0.65	-	✓	✓	
6 (8bitx12)	6 (TMR, PWM, IGBT, Capture)	1	10bitx12 (SA type)	8bitx1	Master Slavex1 Masterx2	UART Full Duplex/ SSIOx4	VLSx1	Max 280dot 35segx 8com	10	Comparatorx2, DMA, Multiplier/Divider	-	P-QFP64-1414-0.80	-	✓	✓	
												P-TQFP64-1010-0.50	-	✓	✓	
6 (8bitx12)	6 (TMR, PWM, IGBT, Capture)	1	10bitx12 (SA type)	8bitx1	Master Slavex1 Masterx2	UART Full Duplex/ SSIOx4	VLSx1	Max 360dot 45segx 8com	12	Comparatorx2, DMA, Multiplier/Divider	-	P-QFP80-1414-0.65	-	✓	✓	
												P-QFP80-1414-0.65	-	✓	✓	

16bit Timer	16bit Multi Functions Timer	WDT	ADC (method)	DAC	Serial Port			Supply Voltage Detection	LCD Driver	External Interrupt Sources	Others	Notes	Package	Chip Support	Halogen Free Support*1	Industrial Grade*2
					FC	SSIO	UART									
6 (8bitx12)	6 (TMR, PWM, IGBT, Capture)	1	10bitx12 (SA type)	8bitx1	Master Slavex1 Masterx2	UART Full Duplex/ SSIOx2	VLSx1	-	10	Comparatorx2, DMA, Multiplier/Divider	-	P-QFP64-1414-0.80	-	✓	✓	
												P-TQFP64-1010-0.50	-	✓	✓	
												P-QFP64-1414-0.80	-	✓	✓	
8 (8bitx16)	8 (TMR, PWM, IGBT, Capture)	1	10bitx16 (SA type)	8bitx2	Master Slavex1 Masterx2	UART Full Duplex/ SSIOx6	VLSx1	-	12	Comparatorx2, DMA, Multiplier/Divider	-	P-QFP80-1414-0.65	-	✓	✓	
												P-QFP80-1414-0.65	-	✓	✓	
8 (8bitx16)	8 (TMR, PWM, IGBT, Capture)	1	10bitx16 (SA type)	8bitx2	Master Slavex1 Masterx2	UART Full Duplex/ SSIOx6	VLSx1	-	12	Comparatorx2, DMA, Multiplier/Divider	-	P-QFP100-1420-0.65	-	✓	✓	
												P-TQFP100-1414-0.50	-	✓	✓	
												P-QFP100-1420-0.65	-	✓	✓	

16bit
ML62Q1000 series

16bit
ML62Q0500

8bit
ML610400/ML610Q400

8bit
ML6100300

32bit
ML630Q400

Product Specifications

Low Power MCUs (16bit) ML620Q500

Normal type 16bit MCU (Industrial Grade)

Part No.	Operating Voltage (V)	ROM type	ROM Capacity (Byte)	Data Flash Capacity (Byte)	RAM Capacity (Byte)	Port			Operating Frequency (Max)		Minimum Instruction Execution Time	Current Consumption (Typ@HALT)	Operating Temperature (°C)	Co-processor for Multiplication and Division	8bit Timer	16bit Multi Functions Timer
						Input	Output	Input/Output	Low Speed	High Speed						
ML620Q503H	1.8 to 5.5	Flash	32K	2K	2K	2	-	36	32.768kHz (Internal RC oscillation/ Crystal oscillation/ External input)	16MHz (Internal RC oscillation/ Crystal oscillation/ External input)	62.5ns 30.5µs	0.45µA (Crystal oscillation)	-40 to +85	✓	8 (16bitx4)	4
ML620Q504H			64K		6K											

*1 A check mark of halogen free support means that we will be able to ship out the halogen free products. For details, please inquire to the sales.

*2 For use of industrial equipment, please inquire to the sales.

	PWM	Capture	WDT	ADC (method)	Serial Port				Supply Voltage Detection	LCD Driver	External Interrupt Sources	Others	Notes	Package	Chip Support	Halogen Free Support*1	Industrial Grade*2
					PC	SSIO (SPI)	UART	USB									
	16bit×4 (use 16bit Timer)	16bit×4 (use 16bit Timer)	1	24bit×2 (RC type) 12bit×12 (SA type)	Master x2	2	Full Duplex x2	–	VLS×1 LLD×1	–	8	Low speed frequency correction/ Analog comparator×2/ Melody: Buzzer	–	P-TQFP48-0707-0.50	✓	✓	✓
														P-TQFP48-0707-0.50	✓	✓	✓

16bit
ML62Q1000 series

16bit
ML620Q500

8bit
ML610400/ML610Q400

8bit
ML610Q300

32bit
ML630Q400

Product Specifications

Low Voltage Operation MCUs (8bit) ML610400/ML610Q400

Normal type 8bit MCU

Part No.	Operating Voltage (V)	ROM type	ROM Capacity (Byte)	Data Flash Capacity (Byte)	RAM Capacity (Byte)	Port			Operating Frequency (Max)		Minimum Instruction Execution Time	Current Consumption (Typ@HALT)	Operating Temperature (°C)	8bit Timer	1kHz Timer	PWM	Capture	WDT
						Input	Output	Input/Output	Low Speed	High Speed								
ML610482	1.1 to 3.6	Mask	64K	-	4K	6	4	22	32.768kHz (Crystal oscillation)	4.096MHz 500kHz	0.244µs/ 2µs/ 30.5µs	0.5µA	-20 to +70	4 (16bit×2)	-	16bit×1	-	1
ML610Q482		Flash																

Normal type 8bit MCU (Industrial Grade)

Part No.	Operating Voltage (V)	ROM type	ROM Capacity (Byte)	Data Flash Capacity (Byte)	RAM Capacity (Byte)	Port			Operating Frequency (Max)		Minimum Instruction Execution Time	Current Consumption (Typ@HALT)	Operating Temperature (°C)	8bit Timer	1kHz Timer	PWM	Capture	WDT
						Input	Output	Input/Output	Low Speed	High Speed								
ML610482P	1.1 to 3.6	Mask	64K	-	4K	6	4	22	32.768kHz (Crystal oscillation)	4.096MHz 500kHz	0.244µs/ 2µs/ 30.5µs	0.5µA	-40 to +85	4 (16bit×2)	-	16bit×1	-	1
ML610Q482P		Flash																

Built-in LCD Driver Dot Matrix type 8bit MCU

Part No.	Operating Voltage (V)	ROM type	ROM Capacity (Byte)	Data Flash Capacity (Byte)	RAM Capacity (Byte)	Port			Operating Frequency (Max)		Minimum Instruction Execution Time	Current Consumption (Typ@HALT)	Operating Temperature (°C)	8bit Timer	1kHz Timer	PWM	Capture	WDT
						Input	Output	Input/Output	Low Speed	High Speed								
ML610Q421	1.1 to 3.6	Flash	32K	-	2K	6	3	22	32.768kHz (Crystal oscillation)	4.096MHz 500kHz	0.244µs/ 2µs/ 30.5µs	0.5µA	-20 to +70	4 (16bit×2)	1	16bit×1	2	1
ML610Q422								14										
ML610Q426	1.1 to 3.6	Flash	40K	-	2K	5	-	7	32.768kHz (Crystal oscillation)	1MHz	1µs/ 30.5µs	0.5µA	-20 to +70	4 (16bit×2)	1	16bit×1	-	1
ML610Q426C								13										
ML610Q428	1.1 to 3.6	Flash	48K	-	4K	6	3	14	32.768kHz (Crystal oscillation)	4.096MHz 2MHz	0.244µs/ 0.5µs/ 30.5µs	0.5µA	-20 to +70	2 (16bit×1)	1	16bit×3	-	1
ML610Q429								10										
ML610Q431	1.1 to 3.6	Flash	64K	-	3K	6	3	22	32.768kHz (Crystal oscillation)	4.096MHz 500kHz	0.244µs/ 2µs/ 30.5µs	0.5µA	-20 to +70	4 (16bit×2)	1	16bit×1	2	1
ML610Q431A								14										
ML610Q432																		
ML610Q432A																		
ML610Q435	1.1 to 3.6	Flash	96K	-	3K	6	3	22	32.768kHz (Crystal oscillation)	4.096MHz 500kHz	0.244µs/ 2µs/ 30.5µs	0.5µA	-20 to +70	4 (16bit×2)	1	16bit×1	2	1
ML610Q435A								14										
ML610Q436																		
ML610Q436A																		
ML610Q438	1.1 to 3.6	Flash	128K	-	7K	10	3	20	32.768kHz (Crystal oscillation)	4.096MHz 2MHz	0.244µs/ 0.5µs/ 30.5µs	0.5µA	-20 to +70	4 (16bit×2)	1	16bit×3	2	1
ML610Q439																		

Built-in LCD Driver Dot Matrix type 8bit MCU (Industrial Grade)

Part No.	Operating Voltage (V)	ROM type	ROM Capacity (Byte)	Data Flash Capacity (Byte)	RAM Capacity (Byte)	Port			Operating Frequency (Max)		Minimum Instruction Execution Time	Current Consumption (Typ@HALT)	Operating Temperature (°C)	8bit Timer	1kHz Timer	PWM	Capture	WDT
						Input	Output	Input/Output	Low Speed	High Speed								
ML610Q421P	1.1 to 3.6	Flash	32K	-	2K	6	3	22	32.768kHz (Crystal oscillation)	4.096MHz 500kHz	0.244µs/ 2µs/ 30.5µs	0.5µA	-40 to +85	4 (16bit×2)	1	16bit×1	2	1
ML610Q422P								14										
ML610Q439P								20										

*1 A check mark of halogen free support means that we will be able to ship out the halogen free products. For details, please inquire to the sales.

*2 For use of industrial equipment, please inquire to the sales.

ADC (method)	Serial Port			Supply Voltage Detection	LCD Driver	External Interrupt Sources	Others	Notes	Package	Chip Support	Halogen Free Support*1	Industrial Grade
	PC	SSIO	UART									
24bitx2 (RC type)	Master x1	1	Half Duplex x1	BLDx1	-	5	Low speed frequency correction/ Buzzer	-	-	✓	✓	-
									P-TQFP48-0707-0.50	✓	✓	-

ADC (method)	Serial Port			Supply Voltage Detection	LCD Driver	External Interrupt Sources	Others	Notes	Package	Chip Support	Halogen Free Support*1	Industrial Grade*2
	PC	SSIO	UART									
24bitx2 (RC type)	Master x1	1	Half Duplex x1	BLDx1	-	5	Low speed frequency correction/ Buzzer	-	-	✓	✓	✓
									P-TQFP48-0707-0.50	✓	✓	✓

ADC (method)	Serial Port			Supply Voltage Detection	LCD Driver	External Interrupt Sources	Others	Notes	Package	Chip Support	Halogen Free Support*1	Industrial Grade
	PC	SSIO	UART									
24bitx2 (RC type) 12bitx2 (SA type)	Master x1	1	Half Duplex x1	BLDx1	-	5	Low speed frequency correction/ Melody: Buzzer	-	P-TQFP120-1414-0.40	✓	✓	-
								Low-speed scillation stop detect reset: enable	P-TQFP120-1414-0.40	✓	✓	-
16bitx1 (RC type)	Master x1	1	Half Duplex x1	BLDx1	-	5	Low speed frequency correction/ Melody: Buzzer/ EL Driver/ External input voltage detection	-	-	✓	✓	-
								-	-	✓	✓	-
24bitx2 (RC type)	Master x1	1	Half Duplex x1	BLDx1	-	5	Low speed frequency correction/ Melody: Buzzer	Selectable oscillation stop detection reset: function enable/ disable according to mask option	TQFP128-P-1414-0.40	✓	✓	-
								-	TQFP128-P-1414-0.40	✓	✓	-
24bitx2 (RC type) 12bitx2 (SA type)	Master x1	1	Half Duplex x1	BLDx1	-	5	RTC/ Low speed frequency correction/ Melody: Buzzer	Low-speed oscillation stop detect reset: enable	P-LQFP144-2020-0.50	✓	✓	-
								Low-speed oscillation stop detect reset: disable	-	✓	✓	-
								Low-speed oscillation stop detect reset: enable	P-LQFP144-2020-0.50	✓	✓	-
								Low-speed oscillation stop detect reset: disable	P-LQFP144-2020-0.50	✓	✓	-
24bitx2 (RC type) 12bitx2 (SA type)	Master x1	1	Half Duplex x1	BLDx1	-	5	RTC/ Low speed frequency correction/ Melody: Buzzer	Low-speed oscillation stop detect reset: enable	-	✓	✓	-
								Low-speed oscillation stop detect reset: disable	P-LQFP144-2020-0.50	✓	✓	-
								Low-speed oscillation stop detect reset: enable	-	✓	✓	-
								Low-speed oscillation stop detect reset: disable	P-LQFP144-2020-0.50	✓	✓	-
24bitx2 (RC type) 12bitx2 (SA type)	Master x1	1	Half Duplex x1	BLDx1	-	9	Low speed frequency correction/ Melody: Buzzer	Selectable oscillation stop detection reset: function enable/ disable according to software	P-LQFP144-2020-0.50	✓	✓	-
								-	-	✓	✓	-

ADC (method)	Serial Port			Supply Voltage Detection	LCD Driver	External Interrupt Sources	Others	Notes	Package	Chip Support	Halogen Free Support*1	Industrial Grade*2
	PC	SSIO	UART									
24bitx2 (RC type) 12bitx2 (SA type)	Master x1	1	Half Duplex x1	BLDx1	-	5	Low speed frequency correction/ Melody: Buzzer	-	P-TQFP120-1414-0.40	✓	✓	✓
								Low-speed scillation stop detect reset: enable	P-TQFP120-1414-0.40	✓	✓	✓
								Selectable oscillation stop detection reset: function enable/ disable according to software	P-LQFP144-2020-0.50	-	✓	✓

16bit
ML62Q1000 series

16bit
ML62Q0500

8bit
ML610400/ML610Q400

8bit
ML6100300

32bit
ML630Q400

Product Specifications

Low Voltage Operation MCUs (8bit) ML610400/ML610Q400

Built-in LCD Driver Segments type 8bit MCU

Part No.	Operating Voltage (V)	ROM type	ROM Capacity (Byte)	Data Flash Capacity (Byte)	RAM Capacity (Byte)	Port			Operating Frequency (Max)		Minimum Instruction Execution Time	Current Consumption (Typ@HALT)	Operating Temperature (°C)	8bit Timer	1kHz Timer	PWM	Capture	WDT
						Input	Output	Input/Output	Low Speed	High Speed								
ML610Q407	1.25 to 3.6	Flash	16K	-	1K	5	12	22	32.768kHz (Crystal oscillation)	2MHz	0.5µs/30.5µs	0.9µA	-20 to +70	4 (16bit×2)	-	16bit×1	2	1
ML610Q407A																		
ML610Q407D																		
ML610Q408	1.25 to 3.6	Flash	16K	-	1K	5	8	22	32.768kHz (Crystal oscillation)	2MHz	0.5µs/30.5µs	0.9µA	-20 to +70	4 (16bit×2)	-	16bit×1	2	1
ML610Q409	1.25 to 3.6	Flash	16K	-	1K	5	4	22	32.768kHz (Crystal oscillation)	2MHz	0.5µs/30.5µs	0.9µA	-20 to +70	4 (16bit×2)	-	16bit×1	2	1
ML610Q409A																		
ML610Q411	1.1 to 3.6	Flash	16K	-	1K	6	3	22	32.768kHz (Crystal oscillation)	500kHz	2µs/30.5µs	0.5µA	-20 to +70	4 (16bit×2)	1	16bit×1	2	1
ML610Q412								14										
ML610Q418	1.1 to 3.6	Flash	128K	4K	4K	6	3	18	32.768kHz (Crystal oscillation)	4.096MHz/500kHz	0.244µs/2µs/30.5µs	1.1µA	-20 to +70	4 (16bit×2)	-	16bit×1	2	1
ML610Q418C								26										
ML610Q419	1.1 to 3.6	Flash	64K	4K	2K	6	3	18	32.768kHz (Crystal oscillation)	4.096MHz/500kHz	0.244µs/2µs/30.5µs	0.9µA	-20 to +70	4 (16bit×2)	-	16bit×1	2	1
ML610Q419C								26										

Built-in LCD Driver Segments type 8bit MCU (Industrial Grade)

Part No.	Operating Voltage (V)	ROM type	ROM Capacity (Byte)	Data Flash Capacity (Byte)	RAM Capacity (Byte)	Port			Operating Frequency (Max)		Minimum Instruction Execution Time	Current Consumption (Typ@HALT)	Operating Temperature (°C)	8bit Timer	1kHz Timer	PWM	Capture	WDT
						Input	Output	Input/Output	Low Speed	High Speed								
ML610Q407P	1.25 to 3.6	Flash	16K	-	1K	5	12	22	32.768kHz (Crystal oscillation)	2MHz	0.5µs/30.5µs	0.9µA	-40 to +85	4 (16bit×2)	-	16bit×1	2	1
ML610Q407PA																		
ML610Q408P	1.25 to 3.6	Flash	16K	-	1K	5	8	22	32.768kHz (Crystal oscillation)	2MHz	0.5µs/30.5µs	0.9µA	-40 to +85	4 (16bit×2)	-	16bit×1	2	1
ML610Q409P	1.25 to 3.6	Flash	16K	-	1K	5	4	22	32.768kHz (Crystal oscillation)	2MHz	0.5µs/30.5µs	0.9µA	-40 to +85	4 (16bit×2)	-	16bit×1	2	1
ML610Q411P	1.1 to 3.6	Flash	16K	-	1K	6	3	22	32.768kHz (Crystal oscillation)	500kHz	2µs/30.5µs	0.5µA	-40 to +85	4 (16bit×2)	1	16bit×1	2	1
ML610Q411PA								14										
ML610Q412P								14										

*1 A check mark of halogen free support means that we will be able to ship out the halogen free products. For details, please inquire to the sales.

*2 For use of industrial equipment, please inquire to the sales.

ADC (method)	Serial Port			Supply Voltage Detection	LCD Driver	External Interrupt Sources	Others	Notes	Package	Chip Support	Halogen Free Support*1	Industrial Grade
	FC	SSIO	UART									
16bit×2 (RC type)	-	2	Half Duplex x1	-	Max 145dot 29seg×5com	13 (include 8bit-OR input)	Low speed frequency correction/ Melody: Buzzer	Low-speed scillation stop detect reset: enable LCD bias: 1/3	P-TQFP100-1414-0.50	✓	✓	-
								Low-speed scillation stop detect reset: disable LCD bias: 1/2, 1/3	-	✓	✓	-
								Low-speed scillation stop detect reset: enable LCD bias: 1/2, 1/3	-	✓	✓	-
16bit×2 (RC type)	-	2	Half Duplex x1	-	Max 165dot 33seg×5com	13 (include 8bit-OR input)	Low speed frequency correction/ Melody: Buzzer	Low-speed scillation stop detect reset: enable LCD bias: 1/3	P-TQFP100-1414-0.50	✓	✓	-
16bit×2 (RC type)	-	2	Half Duplex x1	-	Max 185dot 37seg×5com	13 (include 8bit-OR input)	Low speed frequency correction/ Melody: Buzzer	Low-speed scillation stop detect reset: enable LCD bias: 1/3	P-TQFP100-1414-0.50	✓	✓	-
								Low-speed scillation stop detect reset: disable LCD bias: 1/2, 1/3	-	✓	✓	-
24bit×2 (RC type) 12bit×2 (SA type)	Master x1	1	Half Duplex x1	BLD×1	Max 144dot 36seg×4com	5	Low speed frequency correction/ Buzzer	Low-speed scillation stop detect reset: enable	P-TQFP120-1414-0.40	✓	✓	-
					Max 176dot 44seg×4com			-	P-TQFP120-1414-0.40	✓	✓	-
24bit×2 (RC type) 12bit×2 (SA type)	Master x1	2	Half Duplex x1	BLD×1	Max 192dot 48seg×4com	5	Low speed frequency correction/ Melody: Buzzer	-	P-TQFP100-1414-0.50	✓	✓	-
					Max 160dot 40seg×4com			-	P-TQFP100-1414-0.50	✓	✓	-
24bit×2 (RC type) 12bit×4 (SA type)	Master x1	2	Half Duplex x1	BLD×1	Max 192dot 48seg×4com	5	Low speed frequency correction/ Melody: Buzzer	-	P-TQFP100-1414-0.50	✓	✓	-
					Max 160dot 40seg×4com			-	P-TQFP100-1414-0.50	✓	✓	-

ADC (method)	Serial Port			Supply Voltage Detection	LCD Driver	External Interrupt Sources	Others	Notes	Package	Chip Support	Halogen Free Support*1	Industrial Grade*2
	FC	SSIO	UART									
16bit×2 (RC type)	-	2	Half Duplex x1	-	Max 145dot 29seg×5com	13 (include 8bit-OR input)	Low speed frequency correction/ Melody: Buzzer	Low-speed scillation stop detect reset: enable LCD bias: 1/3	P-TQFP100-1414-0.50	✓	✓	✓
				-				Low-speed scillation stop detect reset: disable LCD bias: 1/2, 1/3	-	✓	✓	✓
16bit×2 (RC type)	-	2	Half Duplex x1	-	Max 165dot 33seg×5com	13 (include 8bit-OR input)	Low speed frequency correction/ Melody: Buzzer	Low-speed scillation stop detect reset: enable LCD bias: 1/3	P-TQFP100-1414-0.50	✓	✓	✓
16bit×2 (RC type)	-	2	Half Duplex x1	-	Max 185dot 37seg×5com	13 (include 8bit-OR input)	Low speed frequency correction/ Melody: Buzzer	Low-speed scillation stop detect reset: enable LCD bias: 1/3	P-TQFP100-1414-0.50	✓	✓	✓
24bit×2 (RC type) 12bit×4 (SA type)	Master x1	1	Half Duplex x1	BLD×1	Max 144dot 36seg×4com	5	Low speed frequency correction/ Buzzer	Low-speed oscillation stop detect reset: enable	P-TQFP120-1414-0.40	✓	✓	✓
					Max 176dot 44seg×4com			Low-speed oscillation stop detect reset: disable	P-TQFP120-1414-0.40	✓	✓	✓
					-			-	P-TQFP120-1414-0.40	✓	✓	✓

16bit
ML62Q1000 series

16bit
ML62Q0500

8bit
ML610400/ML610Q400

8bit
ML6100300

32bit
ML630Q400

Product Specifications

Speech Playback MCUs (8bit) ML610Q300

Normal type 8bit MCU (industrial Grade)

Part No.	Operating Voltage (V)	ROM type	ROM Capacity (Byte)	Data Flash Capacity (Byte)	Memory for Sound	RAM Capacity (Byte)	Port			Operating Frequency (Max)		Minimum Instruction Execution Time	Current Consumption (Typ@HALT)	Operating Temperature (°C)
							Input	Output	Input/Output	Low Speed	High Speed			
ML610Q304	2.0 to 5.5	Flash	96K	2K	Flash ROM	1K	1	3	11	32.768kHz (Internal RC oscillation)	8.192MHz	0.122µs/ 30.5µs	2.7µA	-40 to +85
☆ML610Q305									12				(TBD)	
☆ML610Q306									15					

*1 A check mark of halogen free support means that we will be able to ship out the halogen free products. For details, please inquire to the sales.
 *2 For use of industrial equipment, please inquire to the sales.

USB Interface & Security Function MCUs (32bit) ML630Q400 (ARM Cortex®-M0+)

Built-in LCD Driver Dot Matrix type 32bit MCU (Industrial Grade)

Part No.	Operating Voltage (V)	ROM type	ROM Capacity (Byte)	Data Flash Capacity (Byte)	RAM Capacity (Byte)	Port			Operating Frequency (Max)		Minimum Instruction Execution Time	Current Consumption (Typ@HALT)	Operating Temperature (°C)	Co-processor for Multiplication and Division	8bit Timer	16bit Multi Functions Timer
						Input	Output	Input/Output	Low Speed	High Speed						
ML630Q464	1.8 to 3.6	Flash	64K	2K	8K	-	-	38	32.768kHz (Internal RC oscillation/ Crystal oscillation)	16MHz (Internal RC oscillation) 24MHz (PLL)	41.7ns 30.5µs	0.8µA (Crystal oscillation)	-40 to +85	32bit multiplier	8 (16bitx4)	4
ML630Q466			128K		16K											

*1 A check mark of halogen free support means that we will be able to ship out the halogen free products. For details, please inquire to the sales.
 *2 For use of industrial equipment, please inquire to the sales.

ML610/ML610Q/ML620Q/ML630Q Part Number Explanation

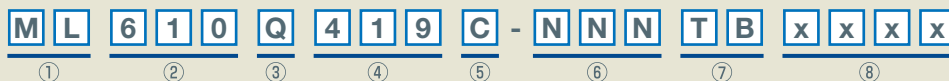

Part Number

- ① **Device type**
ML: Bipolar Logic
- ② **CPU Core type**
610: 8bit CPU nX-U8/100
620: 16bit CPU nX-U16/100
630: 32bit CPU ARM® Cortex® M0+
- ③ **ROM type**
None: Mask ROM
Q: Flash ROM
- ④ **Part Code**
3xx: Speech Playback
4xx: Low Power or Low Voltage Operation
5xx: Low Power
- ⑤ **Operation Code**
None to x: Set for product
- ⑥ **ROM Code**
NNN: Blank
001 to xxx: Custom Code Number
- ⑦ **Package Code**
GD: VQFN, WQFN
MB: SSOP
TD: TSSOP
TB: TQFP
GA: QFP
WA: Chip
- ⑧ **Company's Code in LAPIS Technology**

	8bit Timer	PWM	WDT	ADC (method)	Serial Port			Supply Voltage Detection	LCD Driver	External Interrupt Sources	SP Amp Output (W/ Class)	Others	Notes	Package	Chip Support	Halogen Free Support*1	Industrial Grade*2
					PC	SSIO	UART										
	4 (16bit×2)	-	1	10bit×3 (SA type)	Master/ Slave x1	2	Half Duplex x1	-	-	9	1.0 (@5V)/ D class	Speech function/ ADPCM2 decoder/ Built-in speaker Amplifier	-	P-VQFN28-0505-0.50 P-SSOP30-56-0.65 P-WQFN32-0505-0.50	-	✓	✓
LLD×1				Speech function/ ADPCM2 HQ-ADPCM decoder/ Built-in speaker Amplifier				P-WQFN32-0505-0.50 P-TQFP32-0707-0.80				-		✓	✓		
				10bit×4 (SA type)				P-WQFN36-0606-0.50				-		✓	✓		

☆: Under Development

	PWM	Capture	WDT	ADC (method)	Serial Port				Supply Voltage Detection	LCD Driver	External Interrupt Sources	Others	Notes	Package	Chip Support	Halogen Free Support*1	Industrial Grade*2
					PC	SSIO (SPI)	UART	USB									
	16bit×4 (use 16bit Timer)	16bit×4 (use 16bit Timer)	1	24bit×2 (RC type) 12bit×12 (SA type)	Master/ Slave x2	2	Full Duplex x2	1	VLSx1 LLDx1	Max 400dot 50seg× 8com	8	AES/Random generator/DMA/ RTC/Analog comparator×2/ 1kHz Timer	-	P-TQFP100-1414-0.50	-	✓	✓
				P-TQFP100-1414-0.50										-	✓	✓	

16bit
ML62Q1000 series

16bit
ML620Q500

8bit
ML610400/ML610Q400

8bit
ML610Q300

32bit
ML630Q400

●U8 Core is LAPIS Technology's original RISC-type 8bit CPU. ●U16 Core is LAPIS Technology's original RISC-type 16bit CPU. ●IDE8 and LEXIDE-U16 are LAPIS Technology's project management tools used for program development. ●CCU8 is LAPIS Technology's C compiler used for program development. ●RASU8 is LAPIS Technology's assembler used for program development. ●RLU8 is LAPIS Technology's linker used for program development. ●LIBU8 is LAPIS Technology's librarian (library generation tool) used for program development. ●OHU8 is LAPIS Technology's object converter used for program development. ●LcdAtU8 is LAPIS Technology's program development support tool for LCD control. ●MWU16 is LAPIS Technology's Flash writing tool. ●HTU8 is LAPIS Technology's ROM code generation tool used for code entry (Flash writing). ●DTU8 is LAPIS Technology's debugger used for program development. ●Code Generation Tools are proprietary tools used for LAPIS Technology products. ●EASE1000 V2 is LAPIS Technology's on-chip debug emulators. ●HQ-ADPCM is a high quality audio compression technology developed by Ky's. Ky's is a registered trademark of Kyushu Institute of Technology. "Windows", Windows® Vista, Windows® XP, Windows® 7, Windows® 8.1, and Windows® 10 are registered trademarks of Microsoft Corp. in the US and other countries. ●Intel® Pentium is a registered trademark of Intel Corporation in the US and other countries. *ARM® and Cortex® are registered trademarks of ARM Limited.

- 1) The information contained in this document is current as of November 1st, 2020.
- 2) The information contained herein is subject to change without notice. Before you use our Products, please contact our sales representative (as listed below) and verify the latest specifications.
- 3) Although LAPIS Technology is continuously working to improve product reliability and quality, semiconductors can break down and malfunction due to various factors. Therefore, in order to prevent personal injury or fire arising from failure, please take safety measures such as complying with the derating characteristics, implementing redundant and fire prevention designs, and utilizing backups and fail-safe procedures. LAPIS Technology shall have no responsibility for any damages arising out of the use of our Products beyond the rating specified by LAPIS Technology.
- 4) Examples of application circuits, circuit constants and any other information contained herein are provided only to illustrate the standard usage and operations of the Products. The peripheral conditions must be taken into account when designing circuits for mass production.
- 5) The technical information specified herein is intended only to show the typical functions of and examples of application circuits for the Products. LAPIS Technology does not grant you, explicitly or implicitly, any license to use or exercise intellectual property or other rights held by LAPIS Technology or any other parties. LAPIS Technology shall have no responsibility whatsoever for any dispute arising out of the use of such technical information.
- 6) The Products are intended for use in general electronic equipment (i.e. AV/OA devices, communication, consumer systems, gaming/entertainment sets) as well as the applications indicated in this document.
- 7) The Products specified in this document are not designed to be radiation tolerant.
- 8) For use of our Products in applications requiring a high degree of reliability (as exemplified below), please contact and consult with a LAPIS Technology representative: transportation equipment (i.e. cars, ships, trains), primary communication equipment, traffic lights, fire/crime prevention, safety equipment, medical systems, servers, solar cells, and power transmission systems.
- 9) Do not use our Products in applications requiring extremely high reliability, such as aerospace equipment, nuclear power control systems, and submarine repeaters.
- 10) LAPIS Technology shall have no responsibility for any damages or injury arising from non-compliance with the recommended usage conditions and specifications contained herein.
- 11) LAPIS Technology has used reasonable care to ensure the accuracy of the information contained in this document. However, LAPIS Technology does not warrant that such information is error-free and LAPIS Technology shall have no responsibility for any damages arising from any inaccuracy or misprint of such information.
- 12) Please use the Products in accordance with any applicable environmental laws and regulations, such as the RoHS Directive. For more details, including RoHS compatibility, please contact a LAPIS Technology sales office as listed below. LAPIS Technology shall have no responsibility for any damages or losses resulting non-compliance with any applicable laws or regulations.
- 13) When providing our Products and technologies contained in this document to other countries, you must abide by the procedures and provisions stipulated in all applicable export laws and regulations, including without limitation the US Export Administration Regulations and the Foreign Exchange and Foreign Trade Act.
- 14) This document, in part or in whole, may not be reprinted or reproduced without prior consent of LAPIS Technology.

ROHM Sales Offices

Contact us for further information about the products.

Santa Clara	+1-408-720-1900	France	+33 (0) 1 40 60 87 30	Shenzhen	+86-755-8307-3008	Yokohama	+81-45-476-2121
Atlanta	+1-770-754-5972	United Kingdom	+44-1-908-272400	Hong Kong	+852-2740-6262		
Boston	+1-781-565-1138	Finland	+358-400-726 124	Taiwan	+886-2-2500-6956		
Detroit	+1-248-348-9920	Spain	+34-9375-24320	Singapore	+65-6436-5100		
San Diego	+1-858-625-3600	Hungary	+36-1-950-5859	Philippines	+63-2-8807-6872		
Mexico	+52-33-3123-2001	Italy	+39-039-5783432	Thailand	+66-2-254-4890		
Germany	+49-2154-921-0	Seoul	+82-2-8182-700	Malaysia	+60-3-7931-8155		
Stuttgart	+49-711-7272370	Beijing	+86-10-8525-2483	India	+91-80-4125-0811		
Nuremberg	+49-911-810452-26	Shanghai	+86-21-6072-8612	Kyoto	+81-75-365-1077		

Catalog No.63B7284E 02.2021 PDF © 2021 ROHM Co., Ltd.

ROHM GROUP
LAPIS
 TECHNOLOGY
LAPIS Technology Co., Ltd.
 2-4-8, Shinyokohama, Kouhoku,
 Yokohama, 222-8575 JAPAN
 TEL: +81-45-476-9250 FAX: +81-45-476-9312
www.lapis-tech.com/en/



R2021A