

ROHM Products for
Electric Vehicles

EV Solutions

Ver. 1.3

SiC Tech

SiC devices hold the key in the electric vehicle performance

SiC devices are being increasingly adopted - primarily in DC/DC converters and onboard chargers for electric vehicles. This is due to their superior voltage resistance and loss characteristics which make them ideal for next-generation applications.

SiC Device Performance

Perhaps the biggest challenge for electric vehicles is maximizing cruising distance given the limited battery power.

To this end, it is important to increase electricity costs in lieu of fuel economy. SiC devices are considered key in achieving this goal.

Their superior physical characteristics as a semiconductor material make it possible to exceed the limits of Si devices and provide greater performance in electric vehicles.

Advantages of SiC devices

- Reduced conduction loss
- Lower switching loss
- Supports higher voltages and frequencies

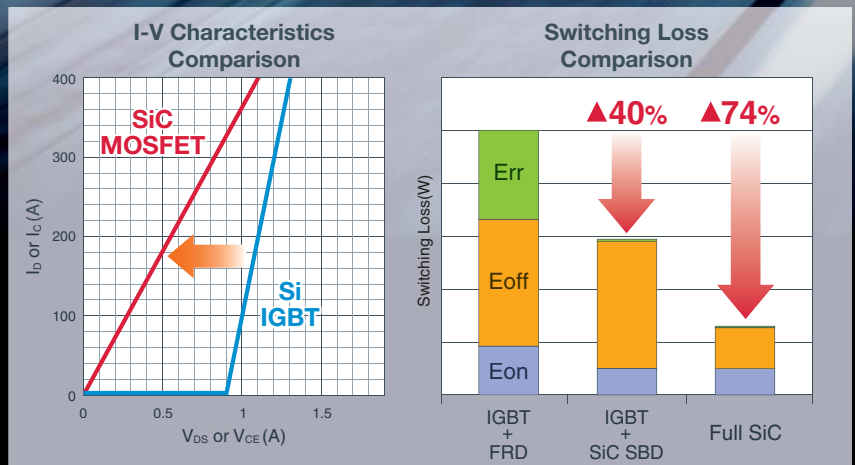

ROHM's Approach to

Dedicated EV units require higher reliability and lower power consumption in a smaller form factor.

ROHM supplies power devices such as SiC and IGBTs together with gate driver ICs designed to drive them.

ROHM also offers a broad lineup of general-purpose products, from power supply ICs optimized for peripheral circuitry and discretes (transistors/diodes) to current detection shunt resistors.

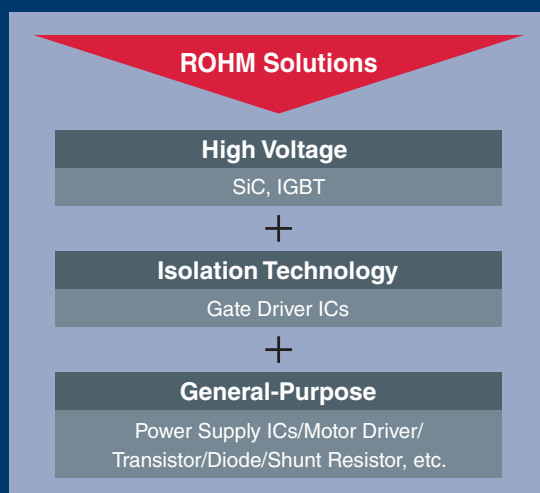

Topics

New SiC MOSFET Evaluation Board

ROHM's solution board includes a control power supply, multiple protection functions, and gate drive circuit optimized for the latest SiC MOSFETs.

Isolated Gate Driver IC (BM6101FV-C)

Flyback Power Supply IC (BD7F200ERJ-LB)

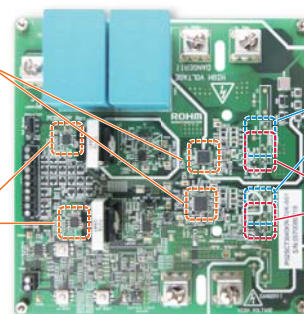

SiC MOSFET (TO-247N)
Insertion points

SiC MOSFET (TO-247L)*
Insertion points
(*4-terminal type with driver source pin)

P02SCT3040KR-EVK-001

Technology

pursuit of

Advantages of SiC devices

- Improved inverter efficiency
- Smaller, lighter cooling system

SiC Reduces Battery Size

50kWh → 46kWh

SiC improves power consumption by 3 to 8%

Reduces battery capacity while maintaining cruising range

Dedicated EV Blocks

ROHM is focused on a variety of applications for electric vehicles, including the main inverter, onboard charger, and DC/DC converter. And going forward, in response to emerging trends such as greater miniaturization due to higher frequency drive, larger battery voltages, and improved set efficiency, the adoption of SiC devices is expected to only increase. ROHM achieves superior quality and stable supply through a vertically integrated production system, from raw materials to finished products.

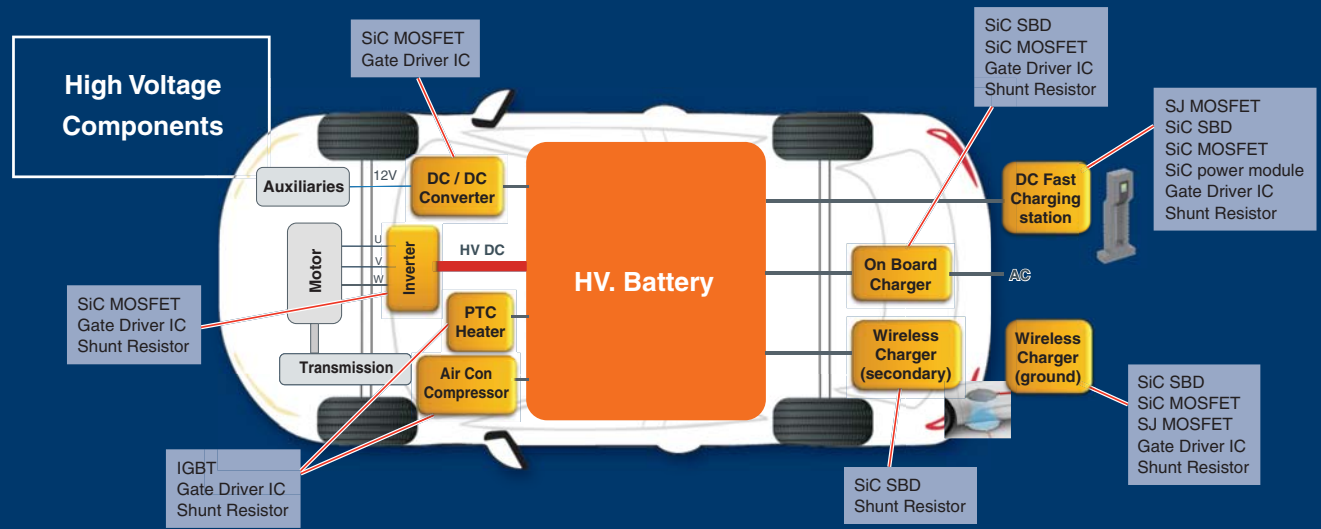

ON-BOARD CHARGER

On-board chargers consist of AC/DC converters that convert an AC voltage (100V to 240V) to a DC voltage in order to charge the high voltage battery.

To ensure worldwide compatibility, the permissible input voltage for many on-board chargers ranges from 85V to 265V.

And to meet market needs for shorter charge times, the voltage specified under fast charging standards is increased, along with battery voltage.

As a result, on-board chargers tend to have higher permissible input voltage, promoting the use of SiC not only for the internal diodes, but MOSFETs as well.

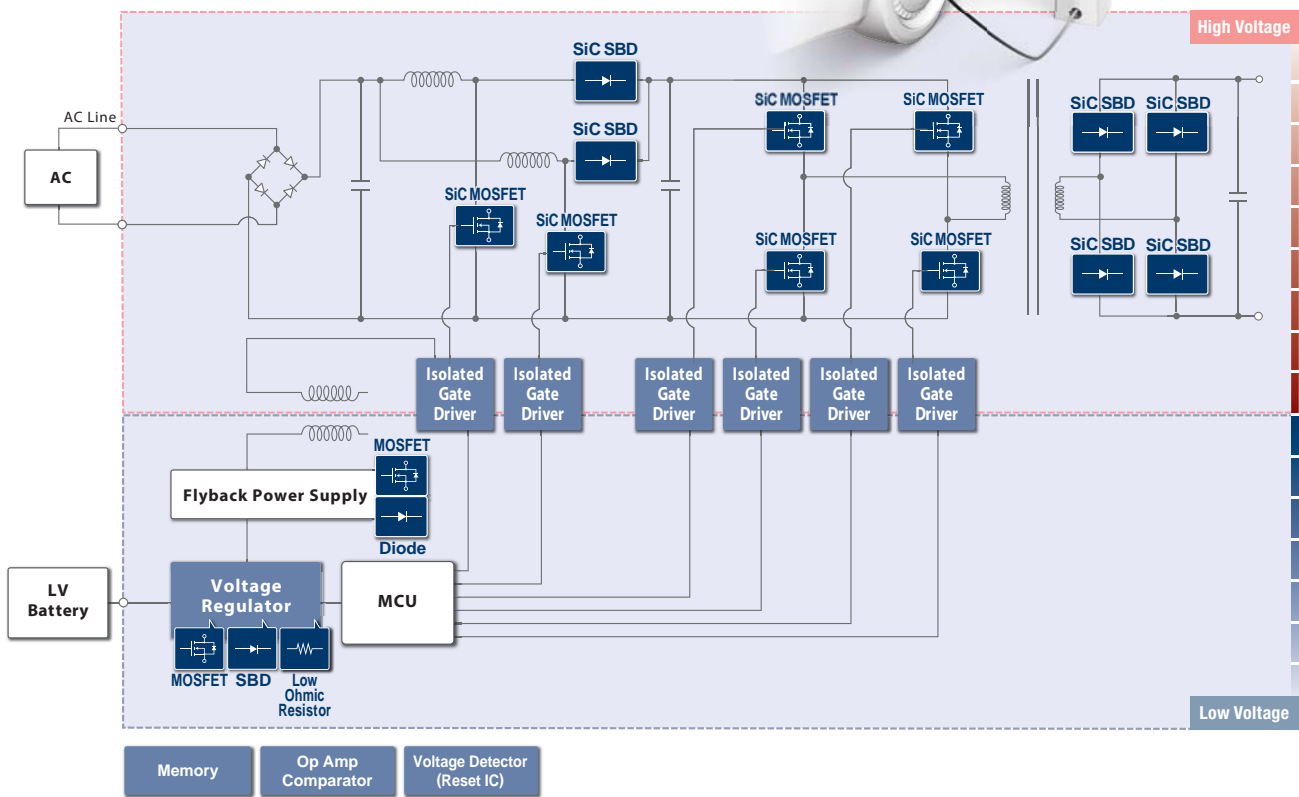

ROHM Products for EV ECUs

Gate Drivers 2,500Vrms Isolated Gate Drivers

BM61S40RFV-C
BM61S41RFV-C
BM61M41RFV-C



ROHM gate drivers integrate an isolated gate driver element that leverages the latest BiC-DMOS processes along with original on-chip transformer technology. This makes it possible to achieve the smallest package size in the industry*, contributing to system miniaturization. In addition, our gate drivers incorporate protection elements and meet automotive quality requirements while providing higher noise immunity, lower current consumption, shorter delay time, and superior temperature characteristics compared to conventional photocoupler types to improve system reliability and reduce design load.

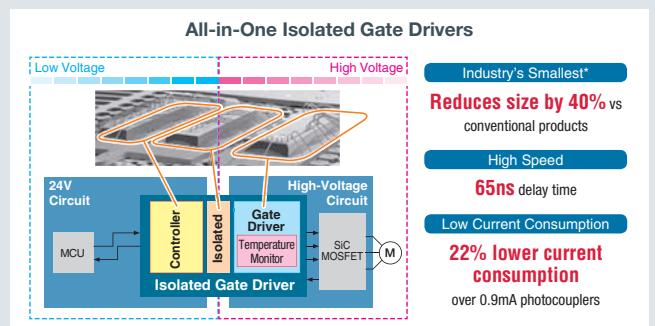

DC/DC CONVERTER

In EVs the engine is replaced by a high voltage battery and motor.
 The DC/DC converter switches power elements and utilizes a transformer to convert the high battery voltage to a lower voltage.
 To protect low voltage electronic circuits, it is necessary to electrically isolate both the signal and ground from the low and high voltage boards.
 ROHM DC/DC converters with built-in SiC MOSFET enable high-speed switching, making it possible to achieve greater miniaturization and higher performance while improving safety.

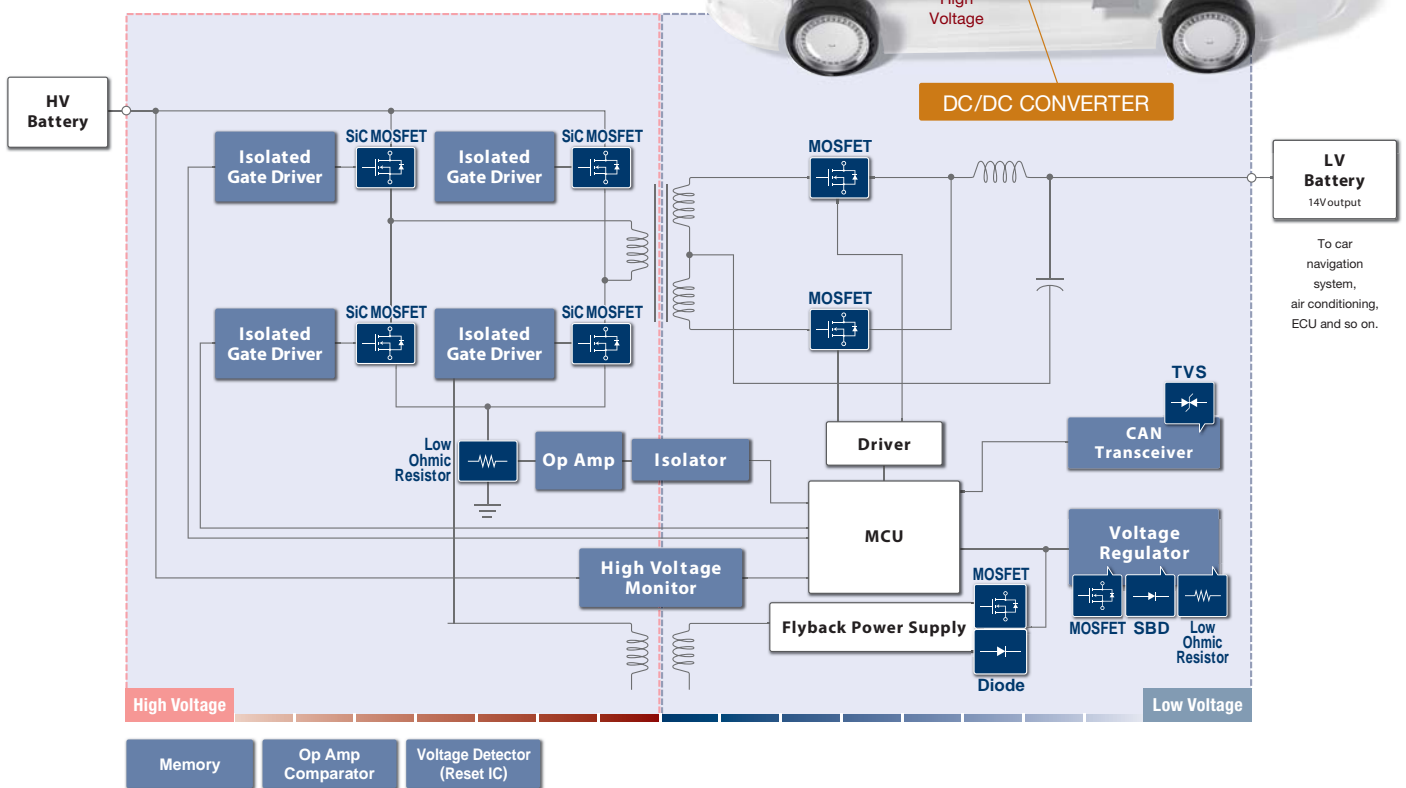
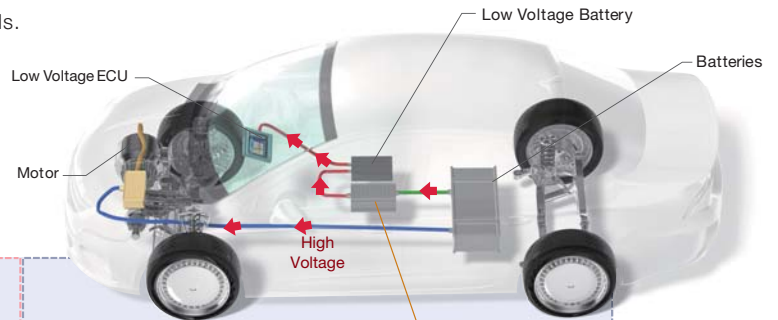

LV Battery
 14V output
 To car navigation system, air conditioning, ECU and so on.

IGBTs Isolated Gate Bipolar Transistor



ROHM IGBTs contribute to greater energy savings and efficiency in a wide range of high voltage high current applications. Original trench gate structure and thin wafer technology are used to achieve low switching loss and $V_{CE(sat)}$. This makes the AEC-Q101 qualified RGS series ideal for a variety of EV systems, including the electric compressor.

IPDs 2ch High Side Intelligent Power Devices



The role of fuses and relays is beginning to change. IPDs are increasingly being used as replacements due to the greater safety and security they provide.

ROHM IPDs are not only ideal for replacing fuses and relays, they contribute to functional safety of the entire system through multi-current control and error flag operation.

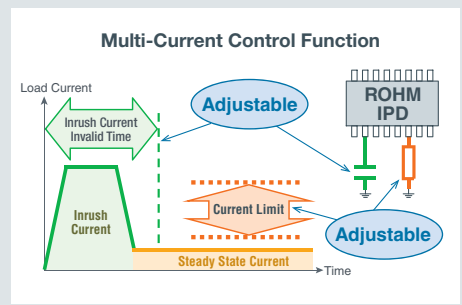

MAIN INVERTER

The main inverter converts DC voltage supplied by the battery into 3-phase AC voltage for driving the motor. Conventional power devices for inverters typically utilize a combination of IGBTs and diodes, but SiC MOSFETs that reduce conduction and switching losses are attracting increased attention.

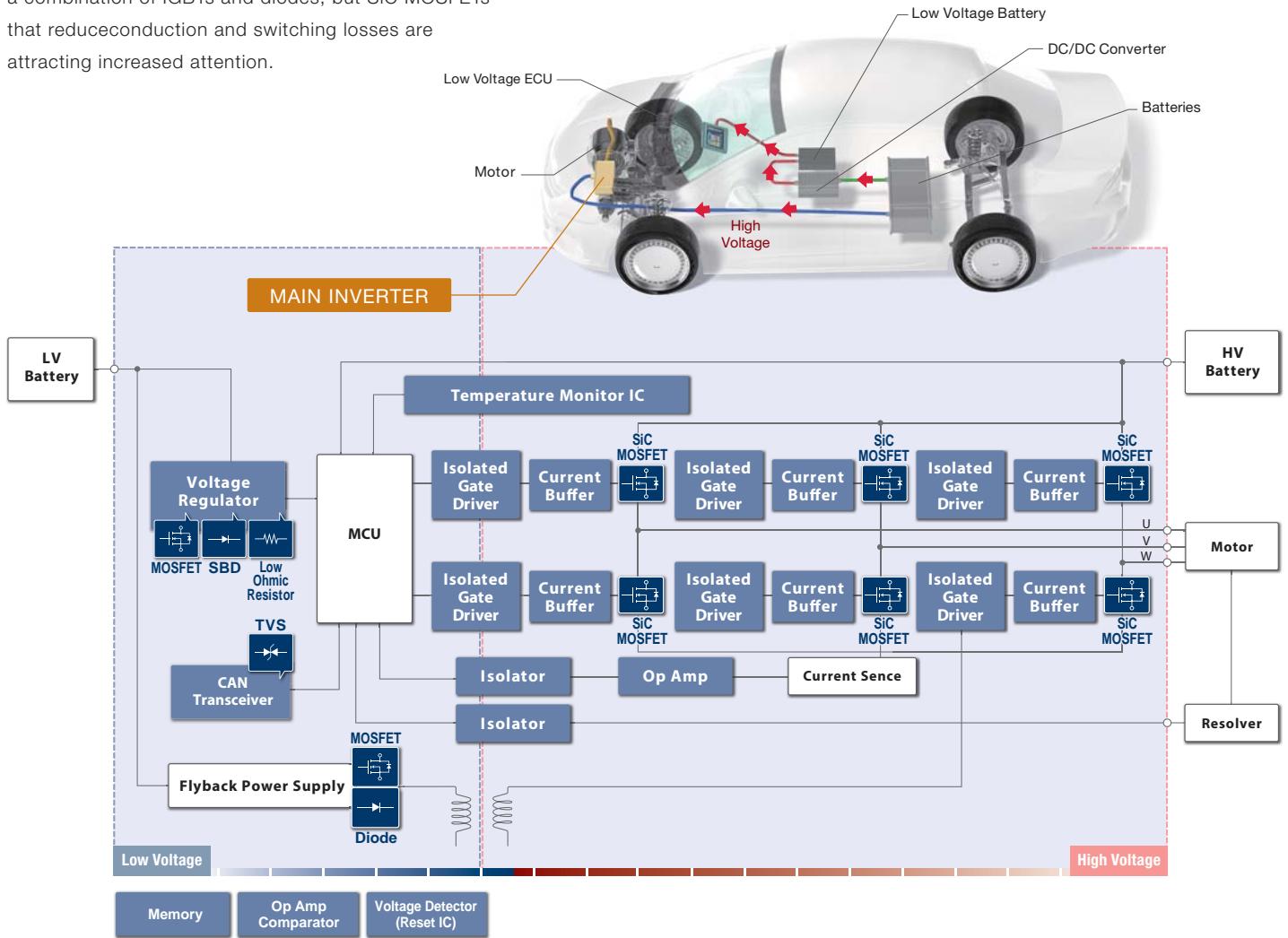

ROHM Products for EV ECUs

LDOs Single Output Low Saturation Regulators

BD4xxM5 series
BD4xxM5W series
BD7xxLx series
BD800M5



Along with greater functionality and accuracy in automotive blocks, ICs that can supply stable power to MCUs and sensors are being increasingly demanded. In response, ROHM offers linear regulators strong against external noise and battery fluctuations. We also offer a broad lineup of class-leading automotive-grade quiescent current regulators that contributes to greater energy savings and enables users to select the ideal product based on application requirements.

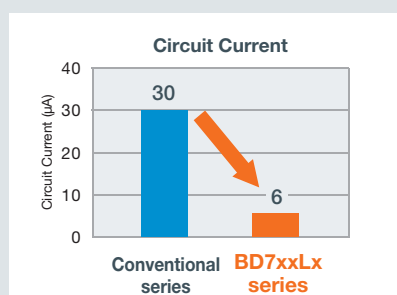

SHUNT P

PSR series



ELECTRIC COMPRESSOR

In EVs, the AC compressor is electric.

High voltage is used to increase motor efficiency, and for inverters that control rotation as well, high voltage, along with high reliability and high efficiency, are important factors. ROHM IGBTs for electric compressors are low-loss devices that achieve superior short-circuit tolerance.

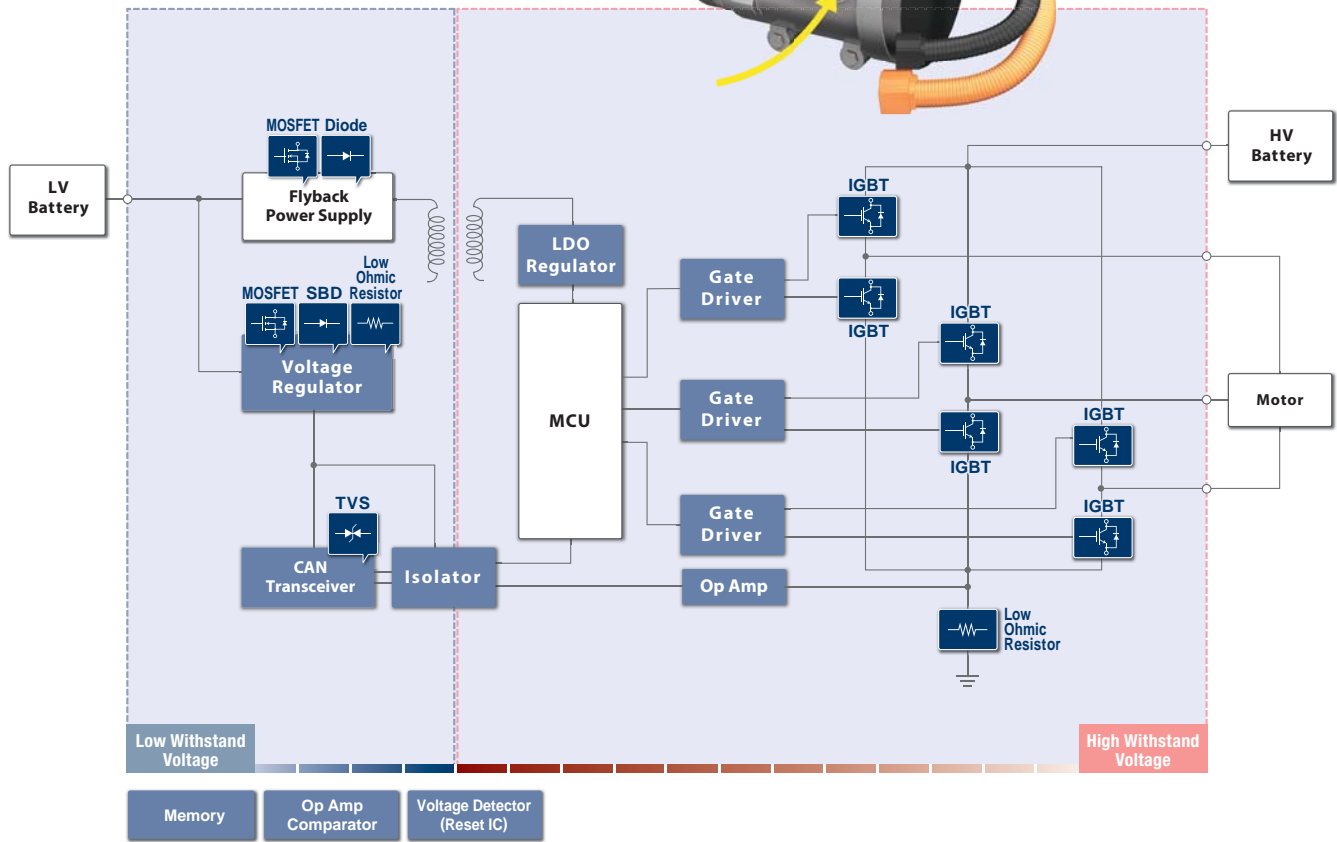
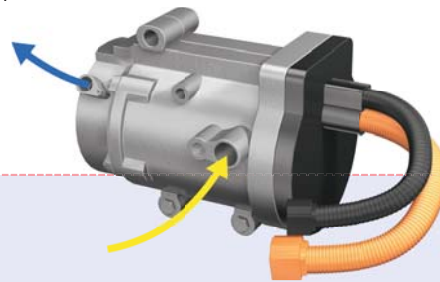

RESISTORS

Features such as high power handling capability and ultra-low resistance are ideal for current detection in high power automotive blocks. High precision welding technology utilized between the resistive element and electrodes allows ROHM's PSR series to deliver excellent temperature coefficient of resistance (TCR) - even in the low-ohmic region.

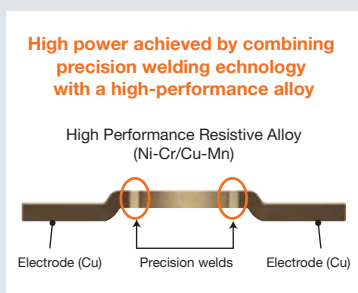

SCHOTTKY BARRIER DIODES

Low V_F series
Ultra-low I_R series



The broad lineup consists of both low V_F and I_R types that allow users to select the ideal product based on set requirements.

MOSFETs

40V series
60V series
100V series



ROHM offers a wide range of MOSFETs that support a variety of motor and drive applications, including low ON resistance models developed utilizing the latest processes.

ROHM Automotive Catalogs

Automotive and Power Device Catalogs are available in addition to this brochure.

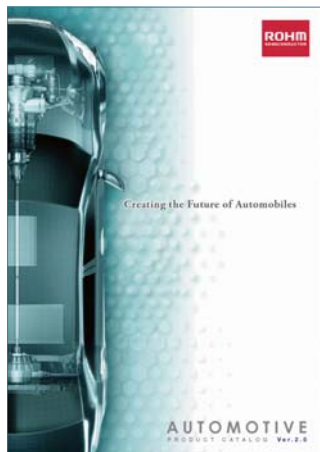

Automotive Catalog

Includes detailed information on the ROHM Group's broad range of automotive products.

We offer an extensive lineup of automotive-grade products and solutions that support the continuing electrification and evolution of today's and next-generation vehicles.



Power Device Catalog

Introduces ROHM's industry-leading products for power applications. Also included are high voltage, high efficiency devices utilizing SiC. Please refer to our next-generation Eco Devices that contribute to greater energy savings and reduced CO₂ emissions.

Creating a safer, more secure automotive society

Acquired development process certification under automotive functional safety standard ISO26262 ~Supports device development with the highest level of safety (ASIL-D)~

ROHM has built a dedicated line for automotive products and performs development that complies with quality management system (IATF 16949) and electronic product reliability (AEC-Q100/101/102) standards. And in 2018 ROHM obtained ISO26262 development process certification (a functional safety standard for automotive applications) from 3rd party certification organization TUV Rheinland (Germany). This allows ROHM's automotive device development process to support the highest safety requirements (ASIL-D). Going forward, ROHM will contribute to greater safety and security in the automotive industry by continuing to apply its ISO 26262 certified development process to products such as power supply and timing controller ICs that require functional safety.

- 1) The information contained in this document is current as of October 1st, 2019.
- 2) The information contained herein is subject to change without notice. Before you use our Products, please contact our sales representative (as listed below) and verify the latest specifications.
- 3) Although ROHM is continuously working to improve product reliability and quality, semiconductors can break down and malfunction due to various factors. Therefore, in order to prevent personal injury or fire arising from failure, please take safety measures such as complying with the derating characteristics, implementing redundant and fire prevention designs, and utilizing backups and fail-safe procedures. ROHM shall have no responsibility for any damages arising out of the use of our Products beyond the rating specified by ROHM.
- 4) Examples of application circuits, circuit constants and any other information contained herein are provided only to illustrate the standard usage and operations of the Products. The peripheral conditions must be taken into account when designing circuits for mass production.
- 5) The technical information specified herein is intended only to show the typical functions of and examples of application circuits for the Products. ROHM does not grant you, explicitly or implicitly, any license to use or exercise intellectual property or other rights held by ROHM or any other parties. ROHM shall have no responsibility whatsoever for any dispute arising out of the use of such technical information.
- 6) The Products are intended for use in general electronic equipment (i.e. AV/OA devices, communication, consumer systems, gaming/entertainment sets) as well as the applications indicated in this document.
- 7) The Products specified in this document are not designed to be radiation tolerant.
- 8) For use of our Products in applications requiring a high degree of reliability (as exemplified below), please contact and consult with a ROHM representative: transportation equipment (i.e. cars, ships, trains), primary communication equipment, traffic lights, fire/crime prevention, safety equipment, medical systems, servers, solar cells, and power transmission systems.
- 9) Do not use our Products in applications requiring extremely high reliability, such as aerospace equipment, nuclear power control systems, and submarine repeaters.
- 10) ROHM shall have no responsibility for any damages or injury arising from non-compliance with the recommended usage conditions and specifications contained herein.
- 11) ROHM has used reasonable care to ensure the accuracy of the information contained in this document. However, ROHM does not warrant that such information is error-free and ROHM shall have no responsibility for any damages arising from any inaccuracy or misprint of such information.
- 12) Please use the Products in accordance with any applicable environmental laws and regulations, such as the RoHS Directive. For more details, including RoHS compatibility, please contact a ROHM sales office as listed below. ROHM shall have no responsibility for any damages or losses resulting from non-compliance with any applicable laws or regulations.
- 13) When providing our Products and technologies contained in this document to other countries, you must abide by the procedures and provisions stipulated in all applicable export laws and regulations, including without limitation the US Export Administration Regulations and the Foreign Exchange and Foreign Trade Act.
- 14) This document, in part or in whole, may not be reprinted or reproduced without prior consent of ROHM.

ROHM Sales Offices

Contact us for further information about the products.

Santa Clara	+1-408-720-1900	Nuremberg	+49-911-810452-26	Shanghai	+86-21-6072-8612	Kyoto	+81-75-365-1077
Atlanta	+1-770-754-5972	France	+33 (0) 1 40 60 87 30	Shenzhen	+86-755-8307-3008	Yokohama	+81-45-476-2121
Boston	+1-781-565-1138	United Kingdom	+44-1-908-272400	Hong Kong	+852-2740-6262		
Chicago	+1-847-368-1006	Finland	+358-400-726 124	Taiwan	+886-2-2500-6956		
Detroit	+1-248-348-9920	Spain	+34-9375-24320	Singapore	+65-6436-5100		
San Diego	+1-858-625-3600	Hungary	+36-1-950-5859	Philippines	+63-2-8807-6872		
Mexico	+52-33-3123-2001	Italy	+39-039-5783432	Thailand	+66-2-254-4890		
Germany	+49-2154-921-0	Seoul	+82-2-8182-700	Malaysia	+60-3-7931-8155		
Stuttgart	+49-711-7272370	Beijing	+86-10-8525-2483	India	+91-80-4125-0811		

Catalog No.62X7248E 11..2019 3000IS © 2019 ROHM Co., Ltd.

R1109A

ROHM Co., Ltd.

21 Saiin Mizosaki-cho, Ukyo-ku,
Kyoto 615-8585 Japan

TEL : +81-75-311-2121 FAX : +81-75-315-0172

www.rohm.com

ROHM
SEMICONDUCTOR