

# FRESH BEATS

CREATING THE WORLD'S THINNEST BOOMBOX

JOE GRAND AKA KINGPIN

  @JOEGRAND



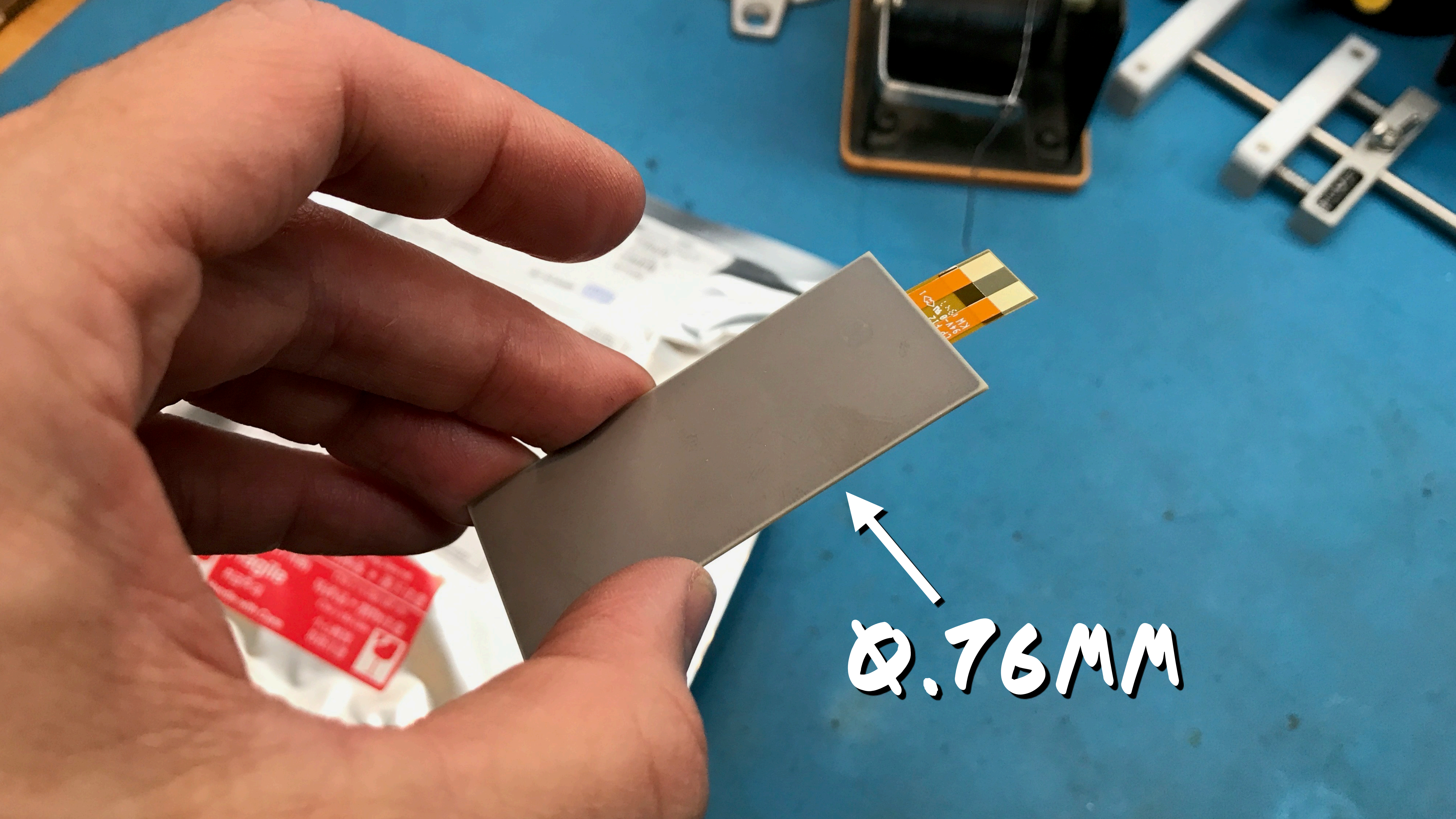

0.76MM



This sound is being reproduced by  
PiezoListen™.

By using the piezoelectric property of  
a change in shape when voltage is applied,



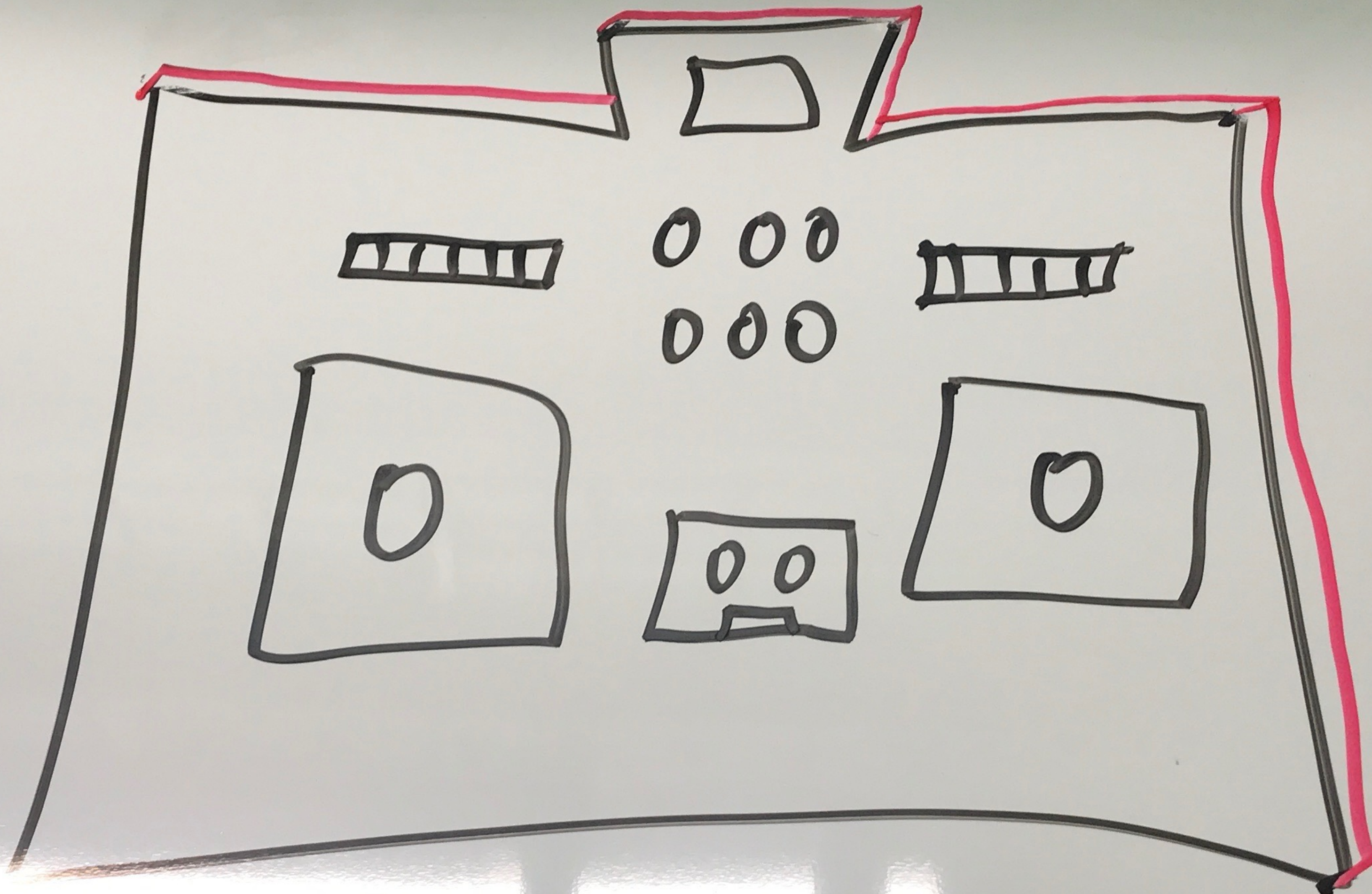







L.L. COOL J

|        | 18.5                         | 19.0 | 20.0 | 21.0 | 22.0 | 23.0 | 24.0 | 25.0 | 26.0 | MHz  |
|--------|------------------------------|------|------|------|------|------|------|------|------|------|
| STEREO | SW <sub>1</sub> SHORT WAVE-3 |      |      |      |      |      |      |      |      |      |
|        | SW <sub>2</sub> SHORT WAVE-1 | 11.0 | 12.0 | 13.0 | 14.0 | 15.0 | 16.0 | 17.0 | 18.0 | 18.5 |
|        | SW <sub>3</sub> SHORT WAVE-4 | 6.0  |      | 7.0  | 8.0  | 9.0  | 10.0 | 11.0 |      |      |
| POWER  | SW <sub>4</sub> SHORT WAVE-2 |      | 5.95 |      | 6.00 | 6.0  | 6.0  | 6.15 | 6.20 | 6.5  |
|        | SW <sub>5</sub> SHORT WAVE-2 | 3.5  |      | 4.0  | 4.5  | 5.0  | 5.5  | 6.0  |      |      |
|        | SW <sub>6</sub> SHORT WAVE-1 | 1.6  | 1.8  | 2.0  |      |      | 3.0  |      |      |      |
| AM     |                              | 540  | 630  | 700  | 800  | 900  | 1000 | 1100 | 1200 | 1300 |
| FM     | AMPLITUDE MODULATION         | 88   | 90   | 92   | 94   | 96   | 98   | 100  | 102  | 104  |



METER/MODE: STEREO, MONO, LEVEL, LOUDNESS (ON/OFF)

BASS: MIN, MAX

TREBLE: MIN, MAX

BALANCE: LEFT, RIGHT

VOLUME: MIN, MAX

FUNCTION: PHONO, RADIO, TAPE

REC SYSTEM: TAPE, TAPE, TAPE

REC LEVEL: LEFT, RIGHT

MIXING MIC LEVEL: MIN, MAX

TAPE: REVERSE, NORMAL

TIME: STANDBY, MULTI MUSIC SCANNER

MULTI MUSIC SCANNER: 1, 2, 3, 4, 5

STOP, REC, PAUSE, REVIEW, PLAY, CUE, REC MUTE

EJECT

FULL LOGIC

JVC

PHONO MC 1, 2









Pirate  
audio

DAC LINE OUT LCD

The Brothers Grimm  
DEFCON 15 Team  
Oogato Badge Hack  
(Ode to the  
DEFCON) Badgez

X

Y

A

B





**AUDIO AMP**

**PI**

**PIEZO**

**ON/OFF**

**NEOPIXEL**

**BATTERY**

**DAC**

**CAP TOUCH**

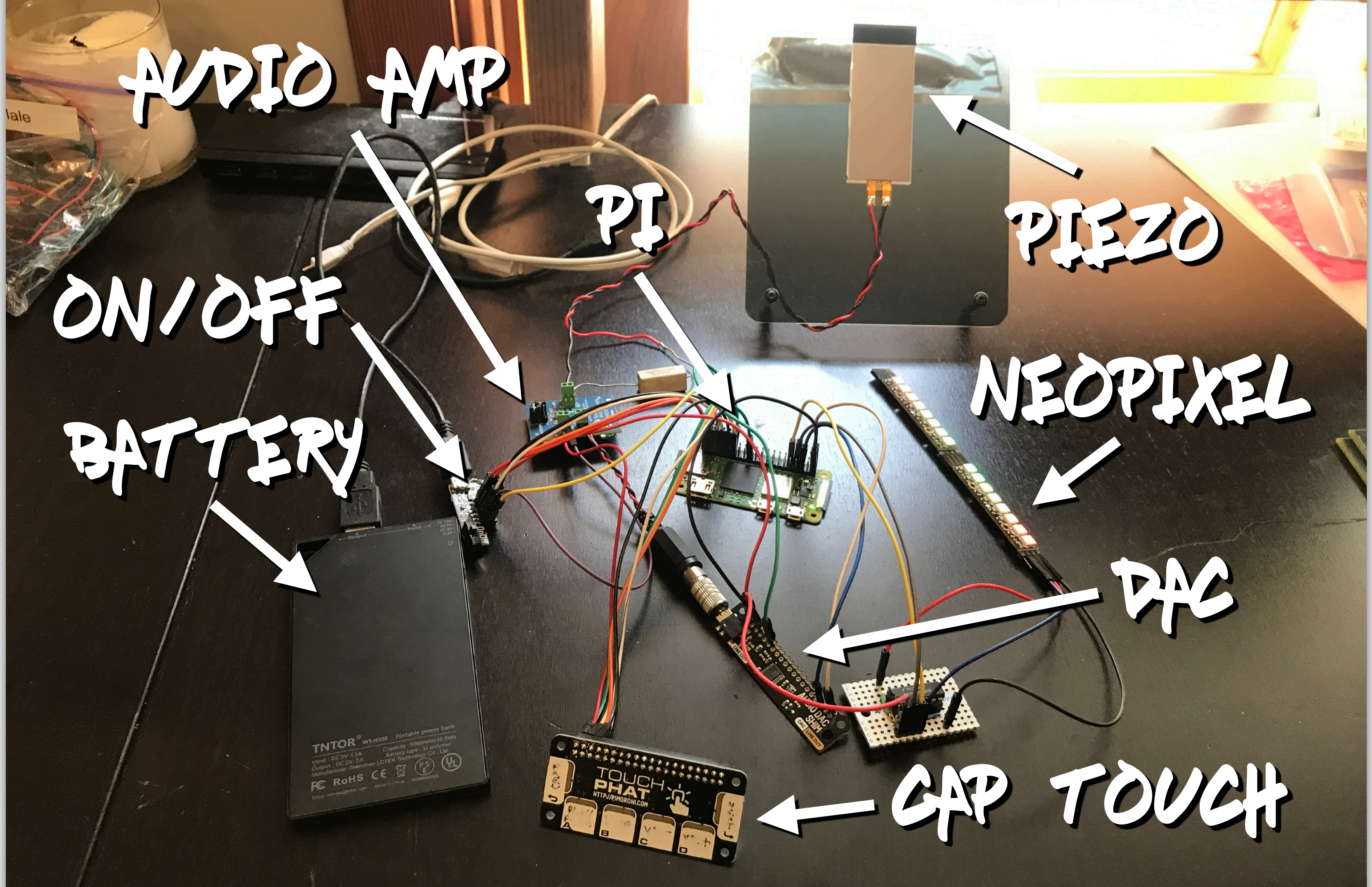



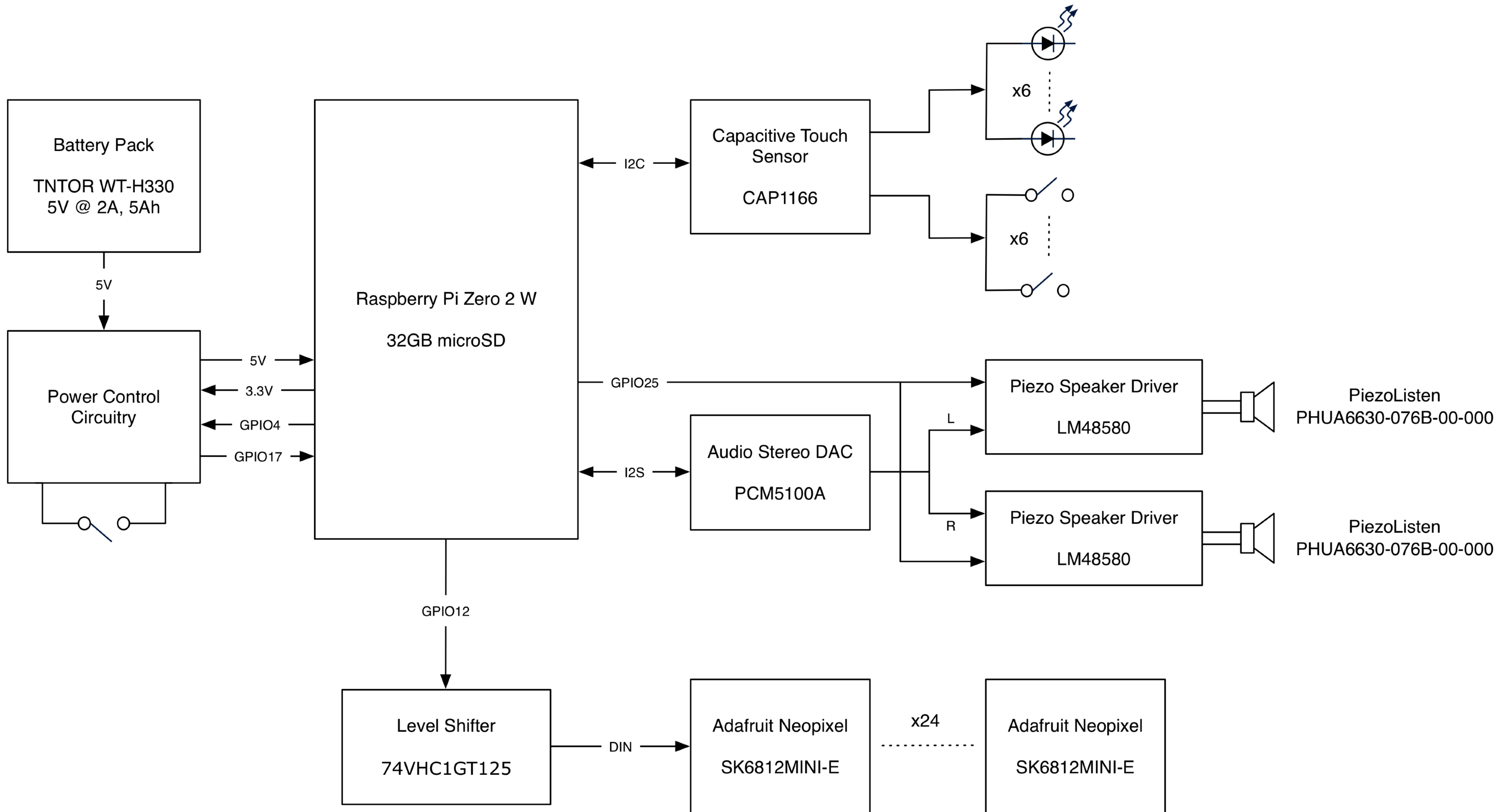







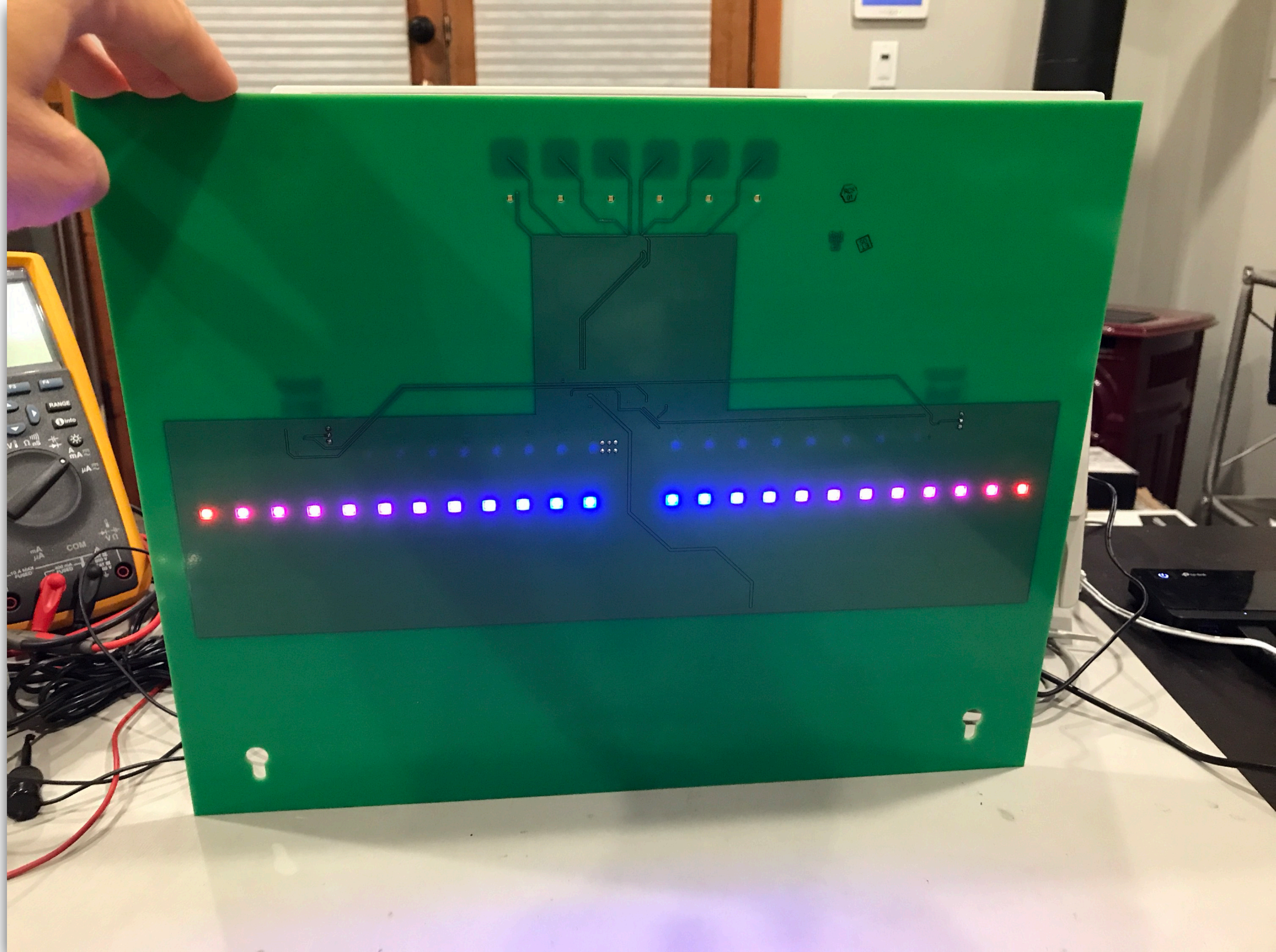



# Mopidy is an extensible music server written in Python.

Mopidy plays music from local disk, Spotify, SoundCloud, TuneIn, and more. You can edit the playlist from any phone, tablet, or computer using a variety of MPD and web clients.



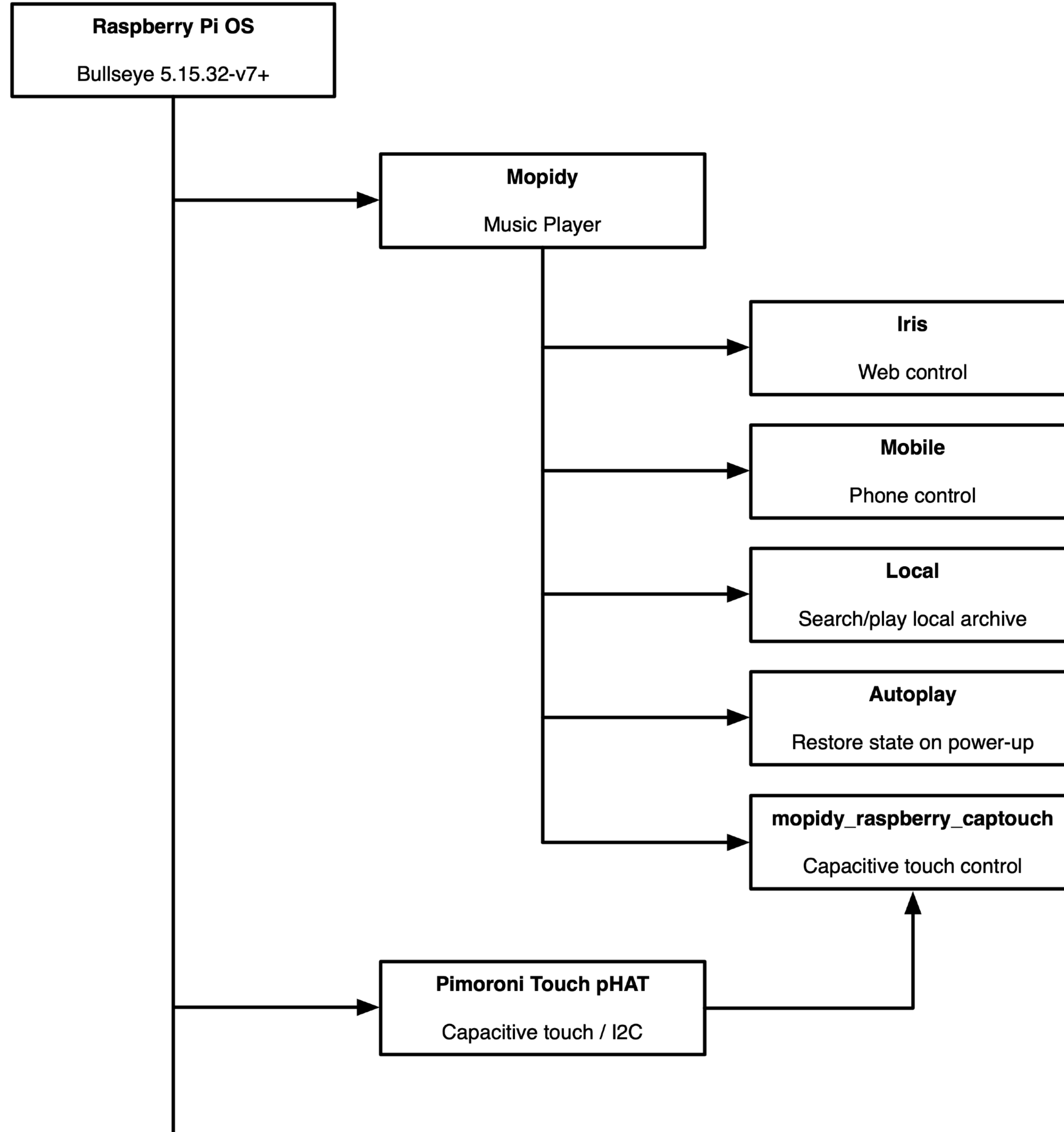



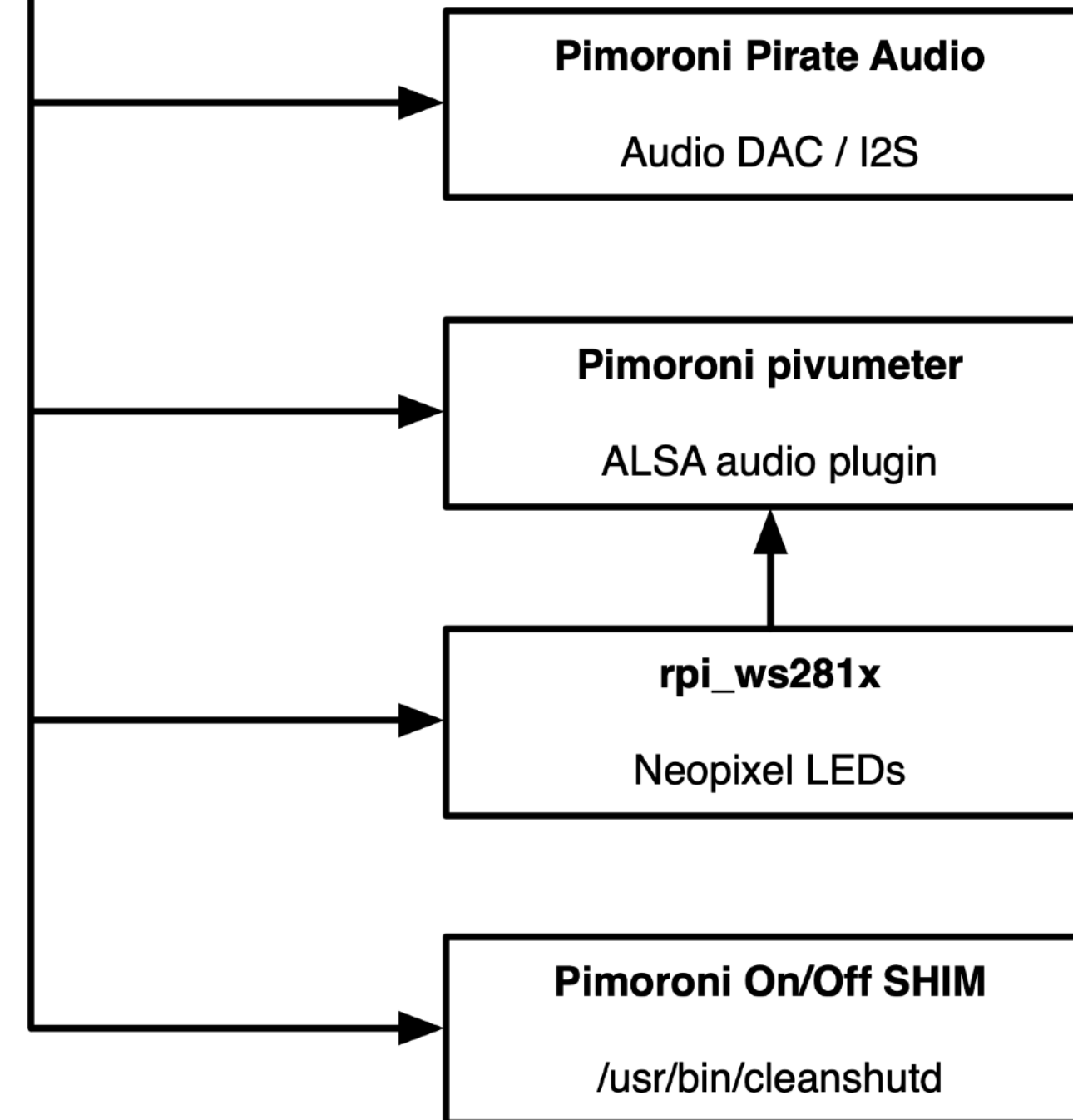





**Mar Williams | Artist**



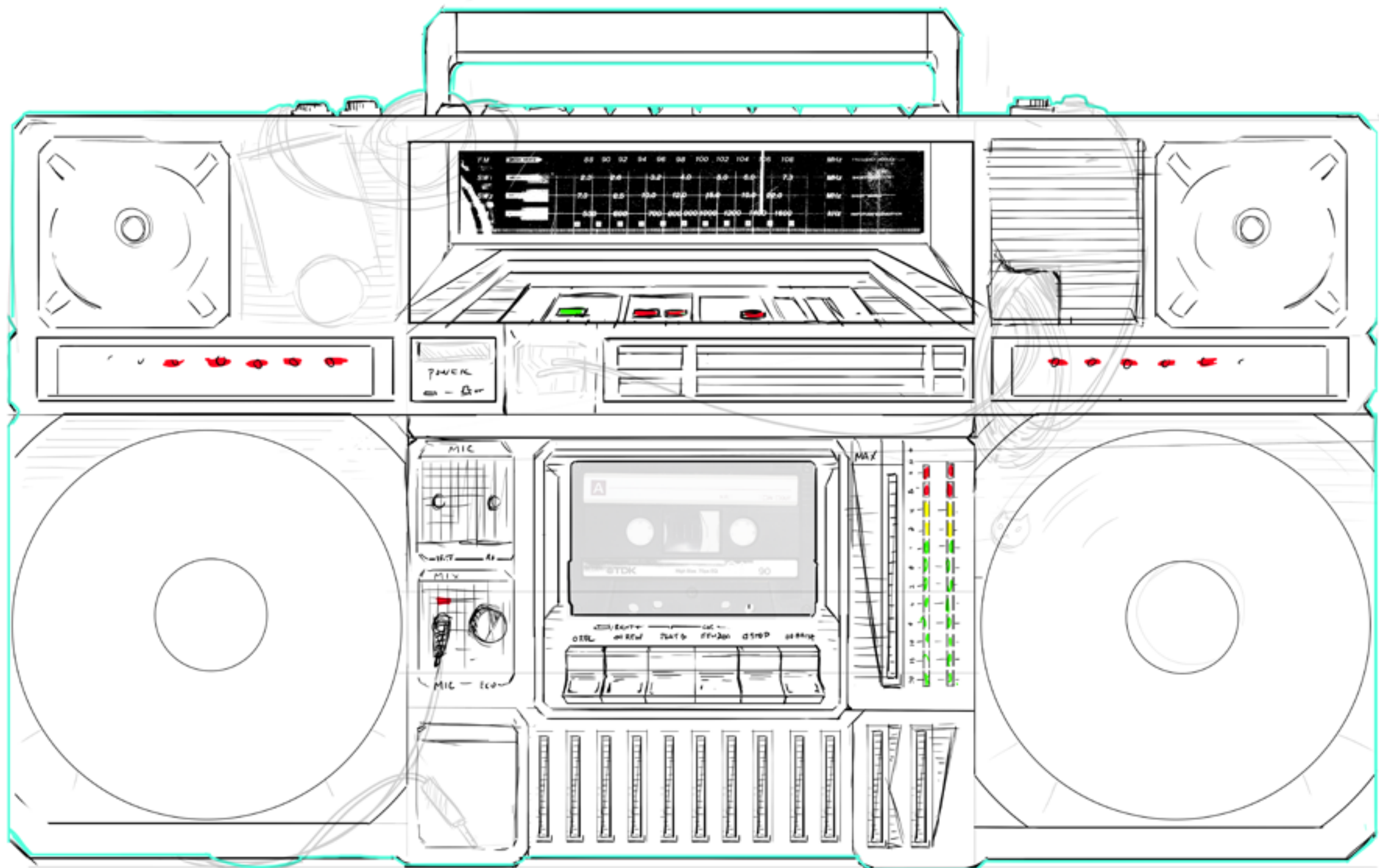



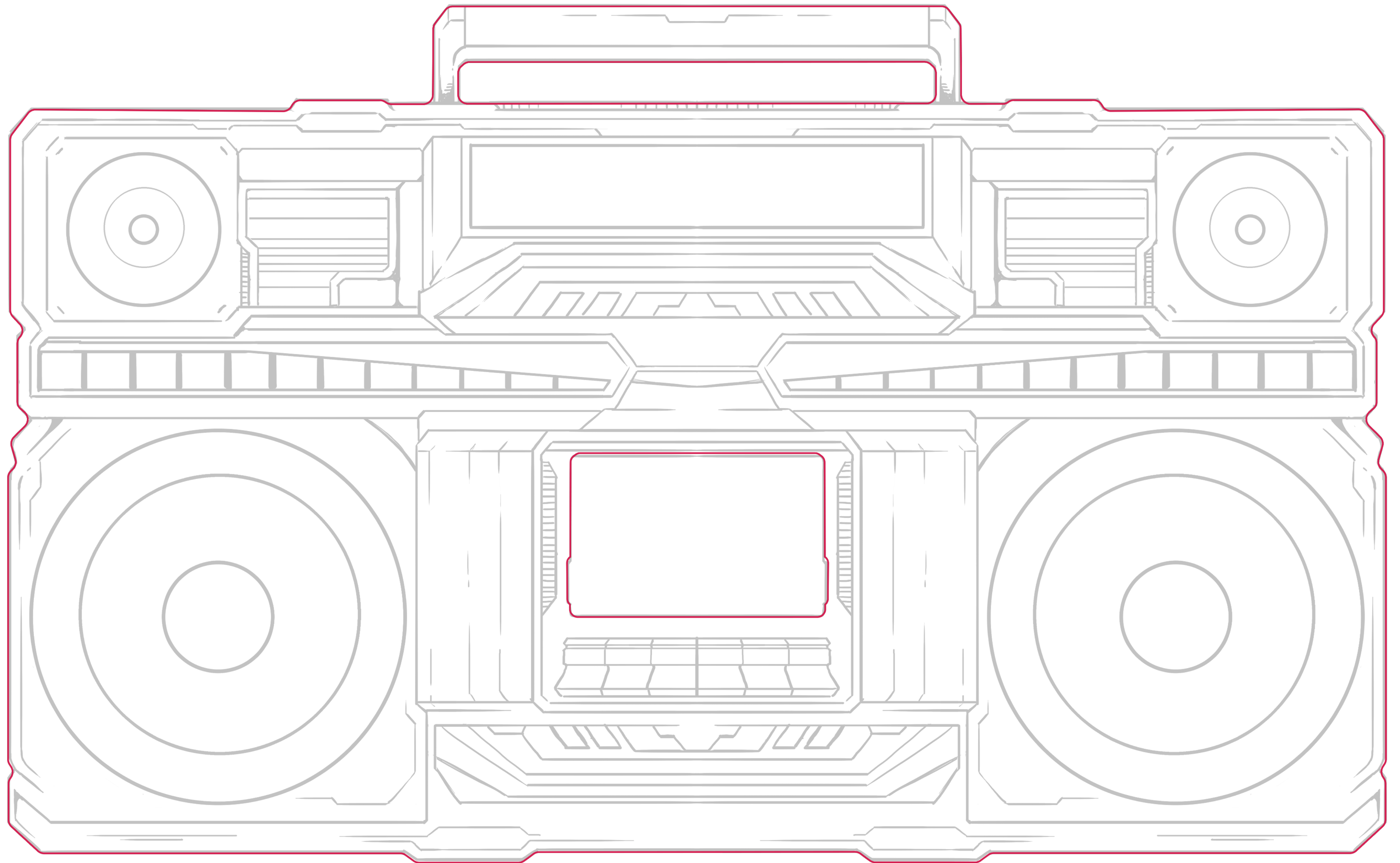



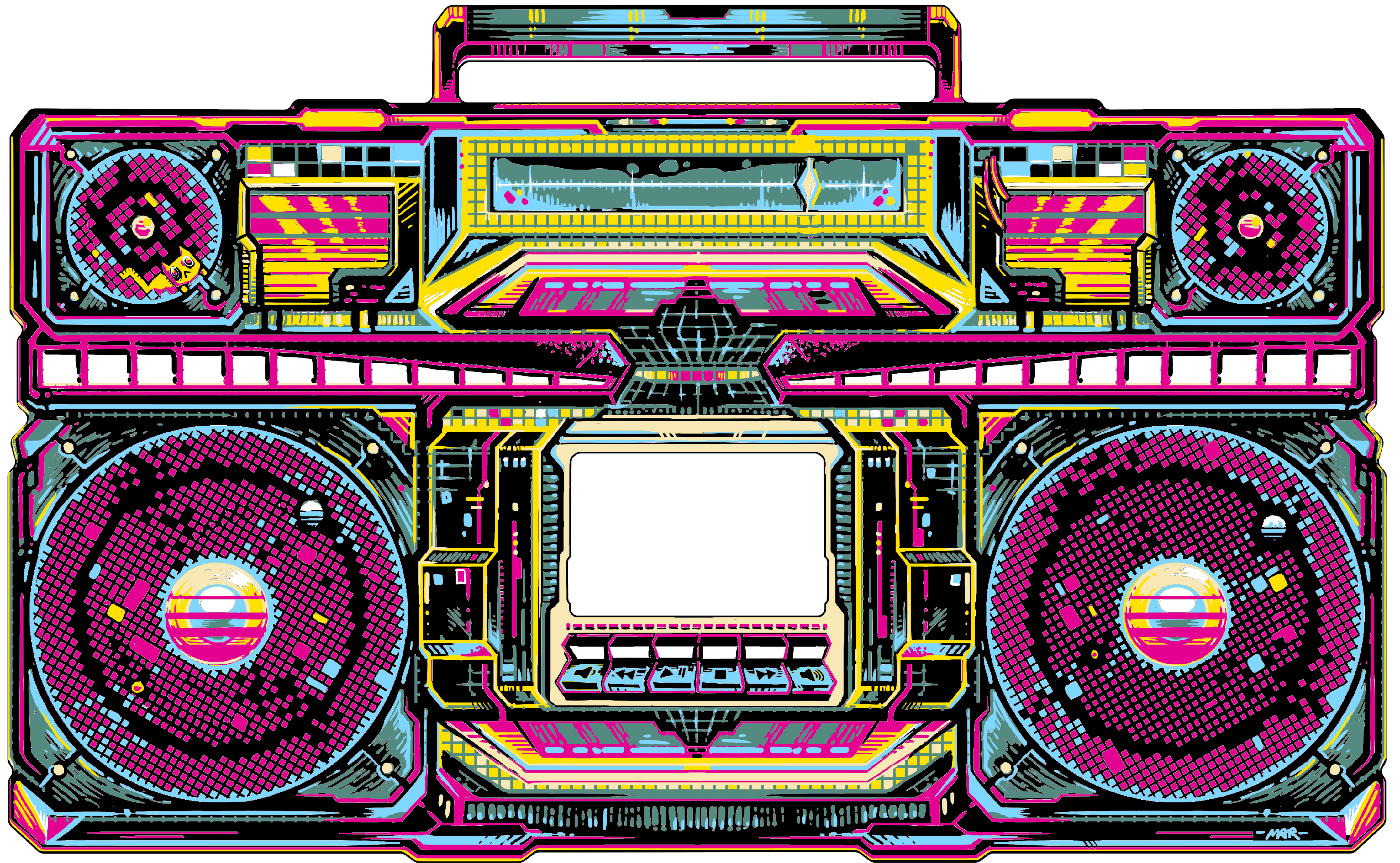

-MRR-





# ROYAL CIRCUIT SOLUTIONS

Customer:

Part Num:

Part Rev:

Job Name:

User Name:

Req. Thick: 125.0

| Layer      | Base CU / Plt | Thick | Type | Stackup | Subs | Imp | Material                            | Dk   | Df    |
|------------|---------------|-------|------|---------|------|-----|-------------------------------------|------|-------|
| Soldermask |               | 0.60  |      |         |      |     | Taiyo-SM - Green                    | 3.90 | 0.033 |
| Lyr1       | 0.5oz / Std   | 2.70  | S    |         |      |     |                                     |      |       |
| Prepreg    |               | 4.12  |      |         |      |     | 370HR - 106_76%<br>370HR - 106_76%  | 3.70 | 0.026 |
| Lyr2       | 1oz           | 1.20  | P    |         |      |     |                                     |      |       |
| Core       |               | 4.00  |      |         |      |     | 370HR - 4.0mils                     | 4.23 | 0.021 |
| Lyr3       | 1oz           | 1.20  | P    |         |      |     |                                     |      |       |
| Prepreg    |               | 4.82  |      |         |      |     | 370HR - 106_76%<br>370HR - 1080_66% | 3.79 | 0.025 |
| Blank      |               | 0.00  | B    |         |      |     |                                     |      |       |
| Core       |               | 90.60 |      |         |      |     | 370HR - 93.0mils                    | 4.04 | 0.021 |
| Blank      |               | 0.00  | B    |         |      |     |                                     |      |       |
| Prepreg    |               | 5.30  |      |         |      |     | 370HR - 1080_66%<br>370HR - 106_76% | 3.79 | 0.025 |
| Blank      |               | 0.00  | B    |         |      |     |                                     |      |       |
| Core       |               | 4.00  |      |         |      |     | 370HR - 4.0mils                     | 4.23 | 0.021 |
| Blank      |               | 0.00  | B    |         |      |     |                                     |      |       |
| Prepreg    |               | 4.60  |      |         |      |     | 370HR - 106_76%<br>370HR - 106_76%  | 3.70 | 0.026 |
| Lyr4       | 0.5oz / Std   | 1.80  | S    |         |      |     |                                     |      |       |
| Soldermask |               | 0.60  |      |         |      |     | Taiyo-SM - Green                    | 3.90 | 0.033 |



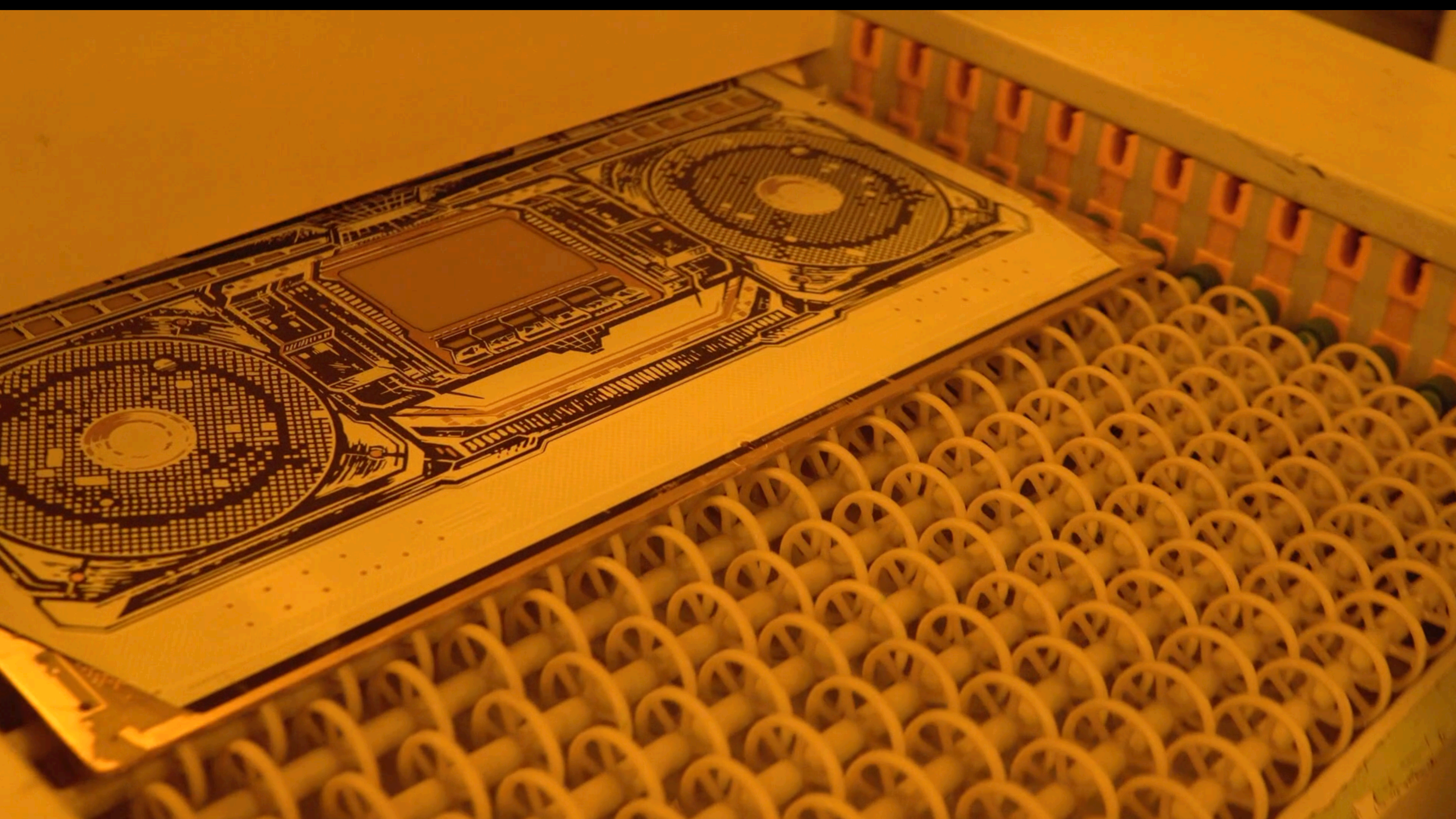



Passed









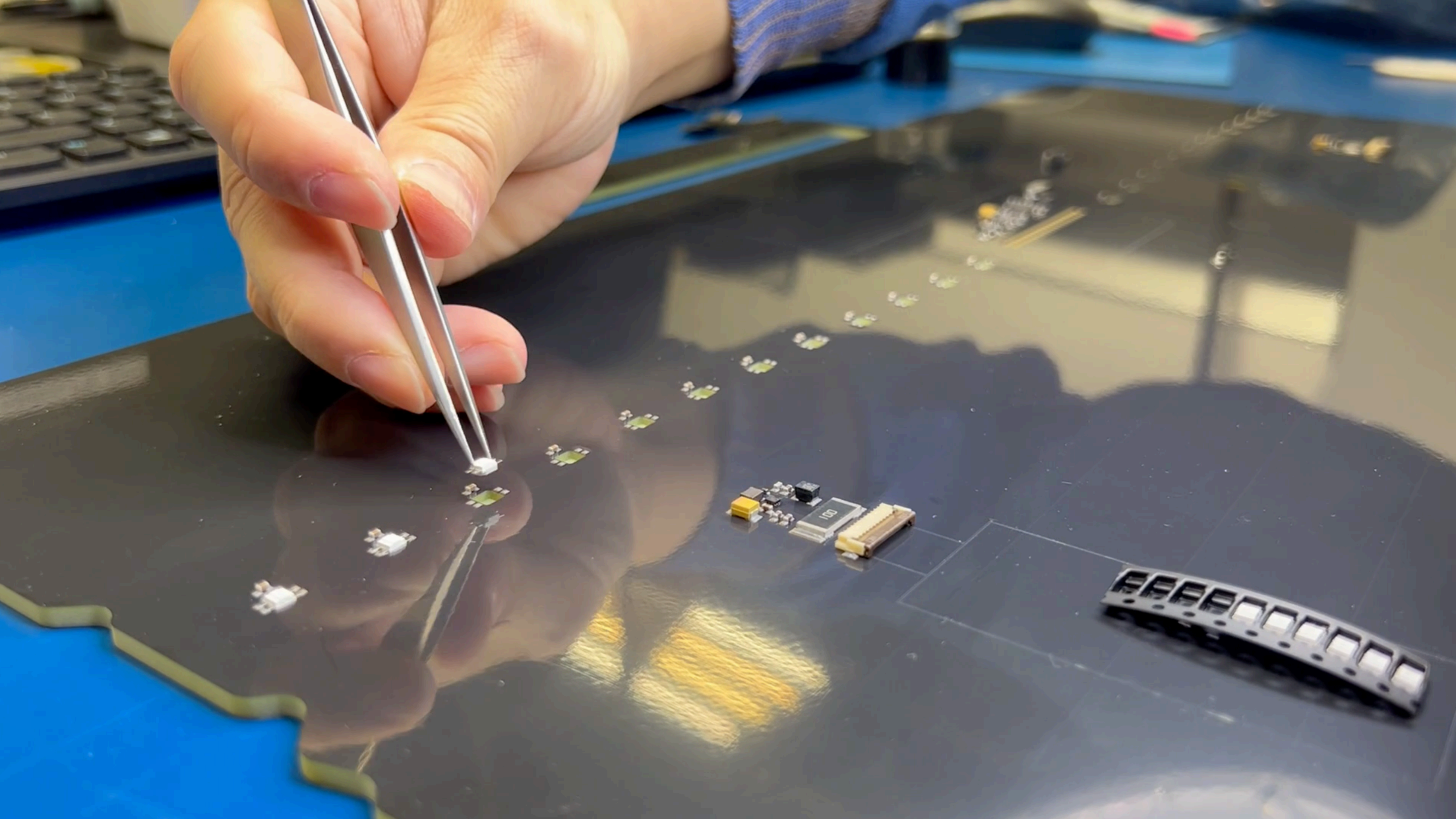



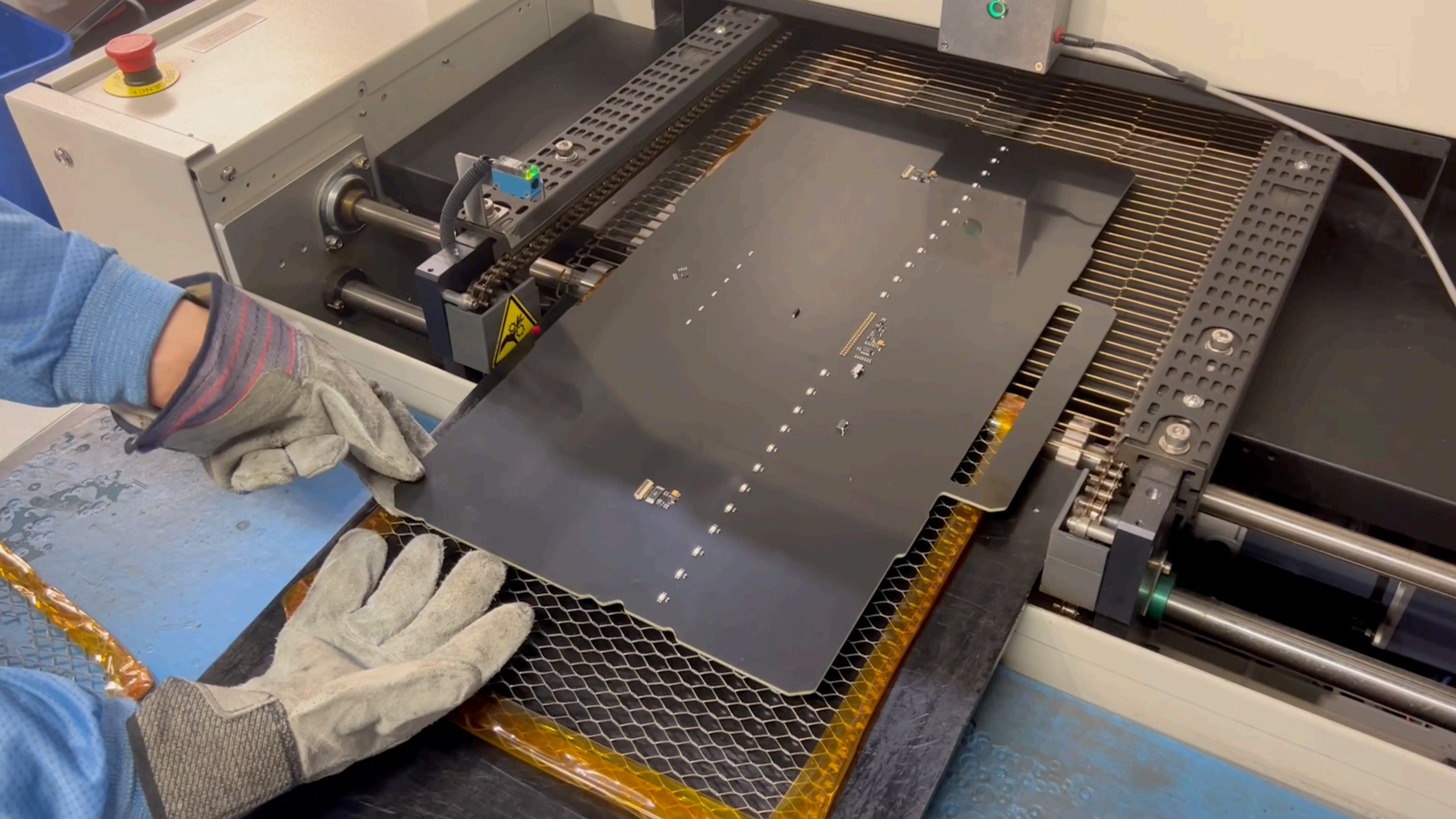



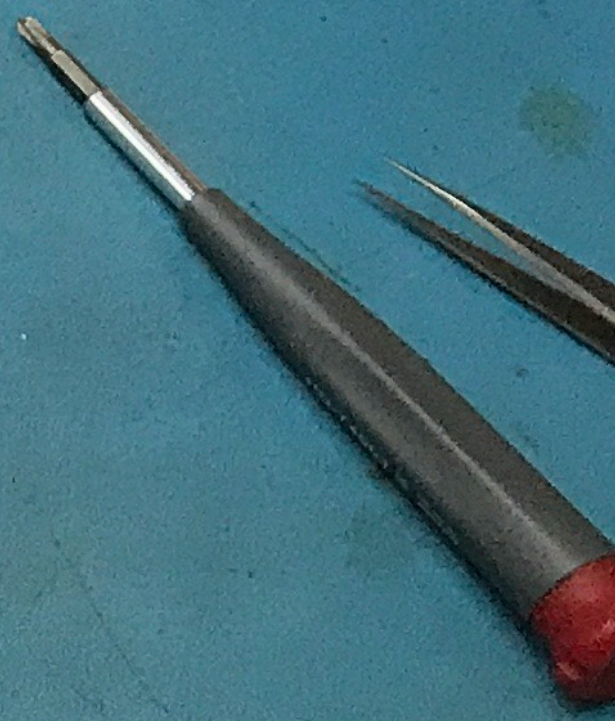
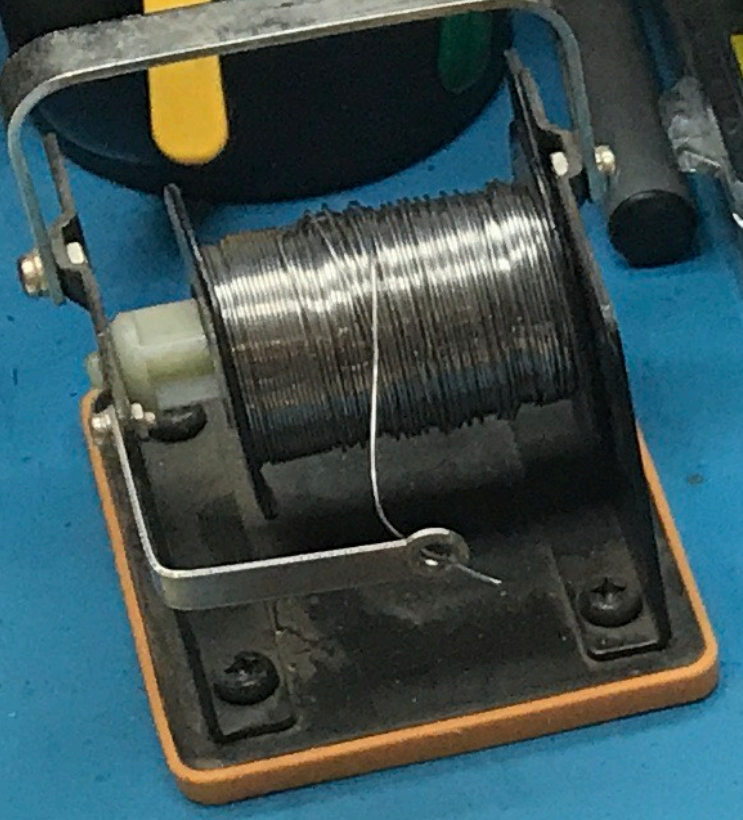
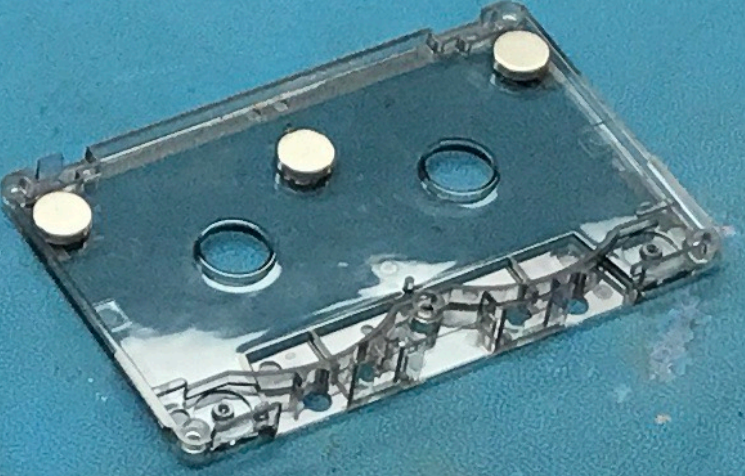
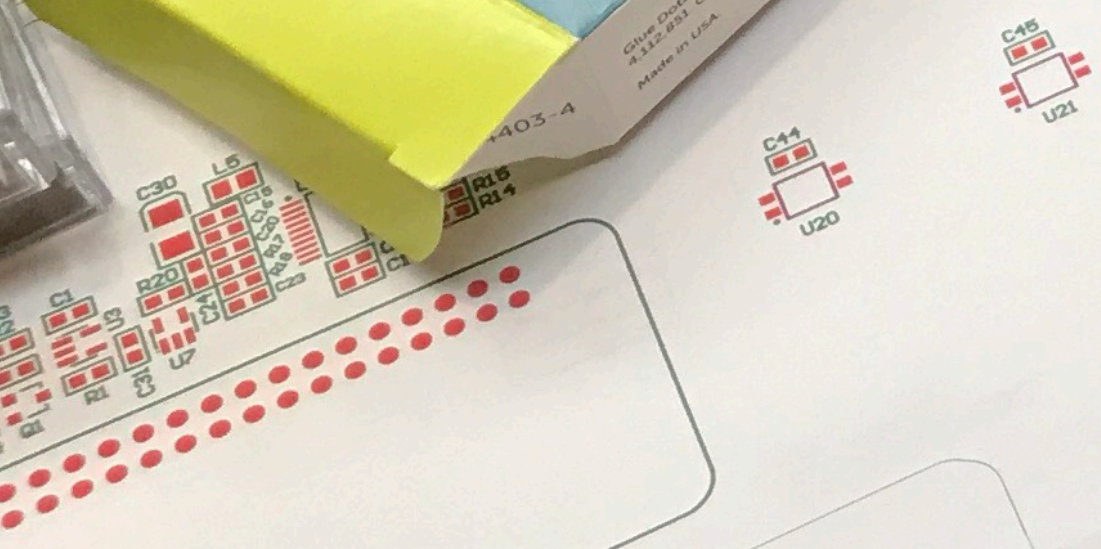











DEMO TIME







# RESPECT

- TDK
- MAR WILLIAMS
- MARK HUGHES
- NEW BIRTH CREW
- DUAL CORE
- SUMMIT INTERCONNECT
- MACDONALD ENTERTAINMENT PARTNERS



# RESOURCES

- JOE'S PROTECT PAGE
- THE WORLD'S THINNEST BOOMBOX (YOUTUBE)
- PIMORONI
- MOPIDY + JOE'S CAPACITIVE TOUCH EXTENSION
- WIKIBOOMBOX
- THE BOOMBOX PROTECT BY LYLE OWERKO



