

Pictures of the Week

2003 – 2010

2003

12/15: Nice meeting
◄ 12/08: Scanning law
◄ 11/24: Microlensing
◄ 11/17: Planet discovery
◄ 11/10: Optics test bench
◄ 11/03: RVS calibration
◄ 10/27: ESTEC
◄ 10/20: Baade's window
◄ 10/13: Quasars
◄ 09/29: First Gaia CCDs
◄ 09/22: Cannibal galaxy
◄ 09/15: All-sky transits
◄ 09/08: Monte Rosa II
◄ 09/01: EADS-Astrium
◄ 08/25: HD70642
◄ 08/18: Catalogues
◄ 08/11: Hipparcos
◄ 08/04: ESOC
◄ 07/28: Light bending
◄ 07/21: NEO 1994 XM1
◄ 07/14: Monte Rosa I
◄ 07/07: SiC facilities
◄ 06/30: CCD centroiding
◄ 06/23: Soyuz launchers

Picture of the Week

The Soyuz family of launchers

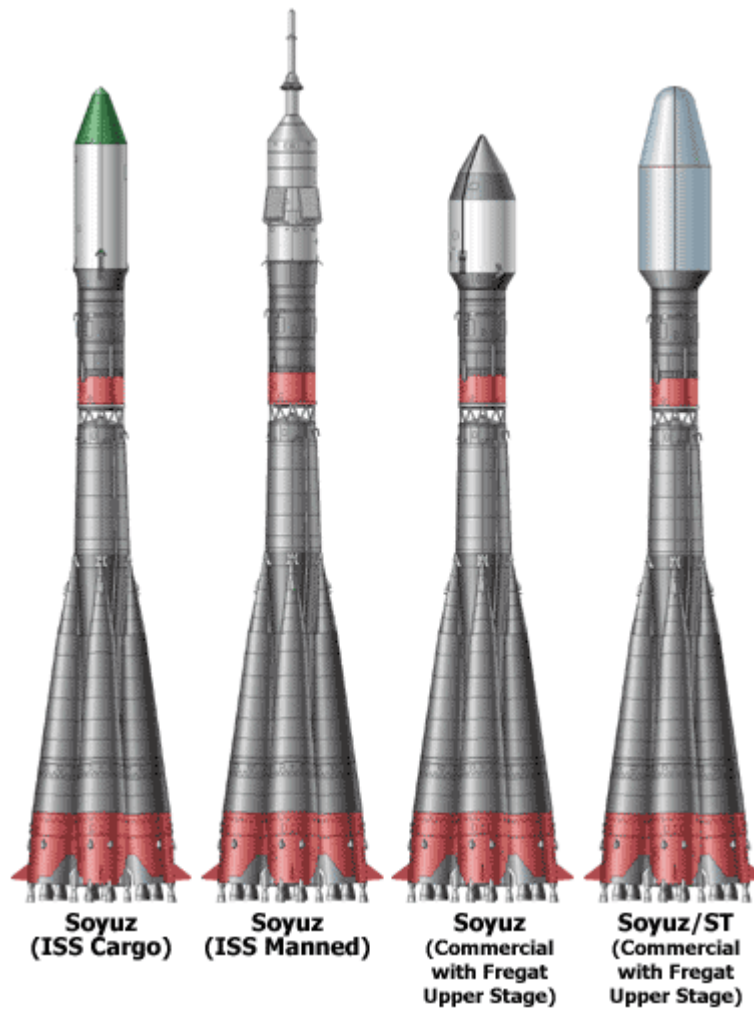

Early this month the [ESA Mars Express](#), Europe's first mission to Mars, was successfully launched from Baikonur on a Soyuz-Fregat rocket.

Gaia will also be launched by a Soyuz-Fregat launcher. The large ST fairing will be used to accommodate the Gaia satellite. Following one revolution in a low altitude parking orbit (200 km) the Fregat upper stage will be fired in order to inject the satellite into the cruise trajectory to L2. The cruise duration will be about 3 months. Insertion around L2 will be performed by the chemical propulsion system on-board Gaia.

For more about the Soyuz family of launchers visit the [STARSEM web site](#).

Image courtesy of STARSEM. [Published: 23/06/2003]

Picture of the Week

CCD centroiding test results

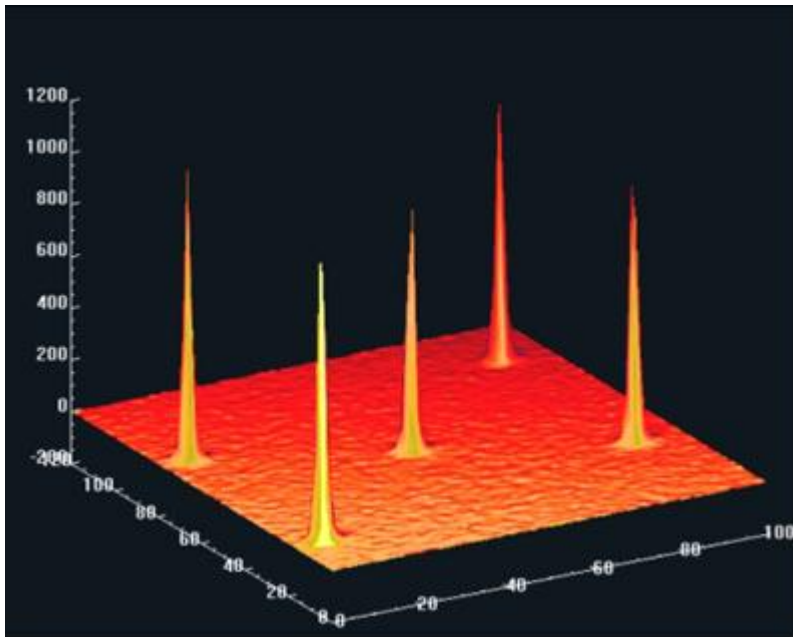

In 2000, EADS-Astrium studied the centroiding performances in TDI mode on non-irradiated and irradiated CCDs operating in 'Gaia mode' ie under conditions which reflect those that Gaia will experience. The CCD used had 13 micron pixels, and was operated at a TDI rate of 2.4 kHz. The rms centroid error, for bright 'stars', was 0.004 pixels, within a factor of 1.2 of the theoretical expectation. Further and more extensive tests will be carried out on the 10 x 30 micron CCDs under development for Gaia by e2v and EADS-Astrium (F), later in 2003.

The figure shown above represents an image of the five spots on the test mask in imaging mode obtained during the EADS-Astrium study.

More information on EADS-Astrium is available from their [web site](#).

Image courtesy of EADS-Astrium (F).

[Published: 30/06/2003]

Picture of the Week

SiC mirror manufacturing chamber, Boostec, Tarbes (France)



The Gaia mirrors and mountings, and the supporting toroidal payload structure will be manufactured from silicon carbide (SiC), a polycrystalline material with fully isotropic microstructure and highly isotropic physical properties. The primary mirror (1.4 m x 0.5 m) will be the largest off-axis mirror to be produced featuring such a large deviation from spherical shape, and will be manufactured by Boostec.

Boostec is the only company in the world producing large lightweight space mirrors made of sintered silicon carbide. It is currently involved in building the 3.5m primary mirror for ESA's Herschel space observatory. More information on Boostec and some of their space related activities are available on their [web site](#).

Image courtesy of Michael Perryman.

[Published: 7/07/2003]

Picture of the Week

Participants at the Monte Rosa conference on "Gaia spectroscopy, science and technology", September 2002



This month sees the publication of the proceedings of a conference on "Gaia spectroscopy, science and technology" held at Gressoney Saint Jean, Valle d'Aosta, Italy, 9-12 September 2002. The conference brought together experts in the scientific and technical aspects of spectroscopy to review areas relevant for Gaia and to evaluate the synergy between Gaia spectroscopy, photometry and astrometry.

The proceedings are published in the Conference Series of the Astronomical Society of the Pacific as GAIA Spectroscopy, Science and Technology ASP Conf. Ser. Vol. 298, 2003 (Ulisse Munari, ed).

More details on the Monte Rosa conference are available [online](#).

Image courtesy of Federico Boschi.

[\[High resolution image available.\]](#)

[Published: 14/07/2003]

Picture of the Week

1994 XM1 - the closest approach of a near-Earth object

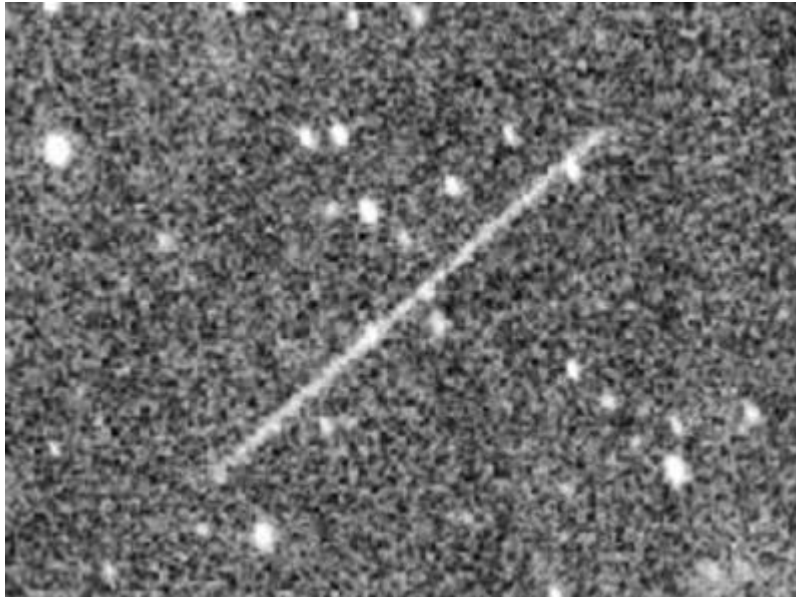

Near-Earth object 1994 XM1 was discovered on 9 December 1994 by astronomer Jim Scotti at the Steward Observatory, Kitt Peak, U.S.A. Observations showed that this object passed by Earth at a distance of 105,000 kilometres. Despite this close approach it is not classified as a "Potentially Hazardous Object" since its size was estimated to be less than 10m. This 150 s exposure image (above) shows a field 5.1 by 4.5 arcmin with 1994 XM1 appearing as a trail in the centre of the image.

Gaia will observe tens of thousand of Solar System objects, including main belt asteroids, Kuiper Belt objects, comets, and near-Earth objects.

The Minor Planet Center maintains a [list of the closest approaches](#) of near-Earth objects. A [list of potentially hazardous objects](#) is also available at the same site.

Image courtesy of Jim Scotti.

[Published: 21/07/2003]

Picture of the Week

Light bending in the Solar System

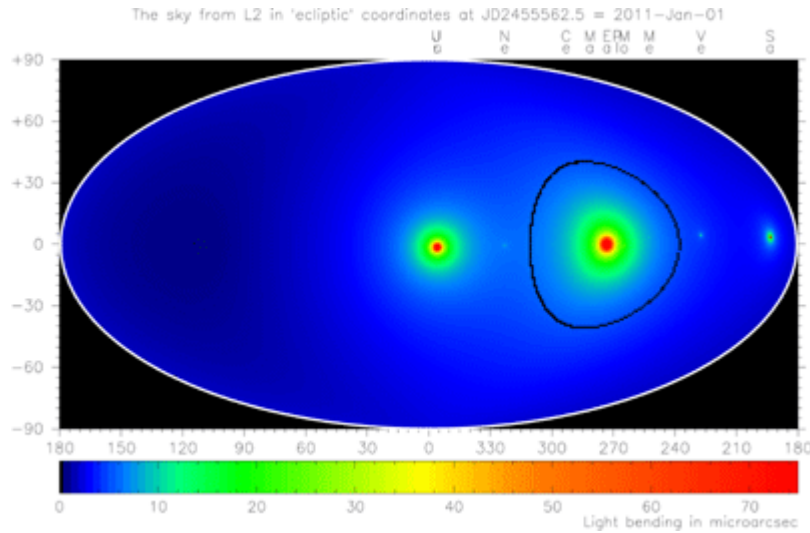

At microarcsecond accuracy levels, such as those measured by Gaia, relativistic effects begin to play a considerable role. In particular, general-relativistic gravitational light deflection due to Solar System bodies will have profound effects on Gaia measurements over the planned 5 year lifetime of the mission. This is vividly illustrated in an animation, created by Jos de Bruijne, from which the image above has been extracted.

The animation can be [downloaded from here](#) for viewing. This animation depicts an all-sky map of the sky as seen from L2 - Gaia will perform its observations from here. Ecliptic coordinates (increasing from left to right, with 0 degrees in the center) are used in a Hammer projection. The integrated amount of light bending due to all planets in the Solar System, plus Ceres and our Moon, is shown with a colour scale (see object names and time scale on image). Contributions from the Sun are excluded. Further details on the contributions from Solar System bodies, and on how the animation was created, can be found in the technical note (Gravitational light deflection; GAIA-JdB-001) prepared by de Bruijne (available on request from the author).

Image courtesy of Jos de Bruijne.

[Published: 28/07/2003]

Picture of the Week

ESOC: the European Space Operations Centre



The Gaia spacecraft, due for launch in mid-2010 and with an operational lifetime of five years, will be controlled by the European Space Operations Centre (ESOC, Darmstadt, Germany).

The mandate of the European Space Operations Centre is to operate ESA satellites and to establish, operate and maintain the necessary ground infrastructure. Experts from ESOC are involved at the earliest phases in the life of a mission, for example providing input to determine the most appropriate orbit for the mission, and investigating any mission critical aspects, such as eclipses.

Following the acceptance of a mission ESOC activities are mostly concentrated on the preparation of satellite navigation plans and developing the operations concept. Software and hardware systems may be developed or modified to monitor and control the satellite. Software simulators are used to allow the operations team to fully test and validate the mission's systems and procedures. Prior to launch all operational systems supporting the spacecraft are integrated and tested.

Once the satellite has separated from the launcher ESOC takes over mission operations. From this time until the end of the mission ESOC is responsible for monitoring and controlling the spacecraft, and for ensuring that the mission products are delivered to the end users.

To learn more about ESOC visit their [web pages](#).

[Published: 04/08/2003]

Picture of the Week

The Hipparcos satellite in the testing facilities at ESTEC, The Netherlands, in 1988

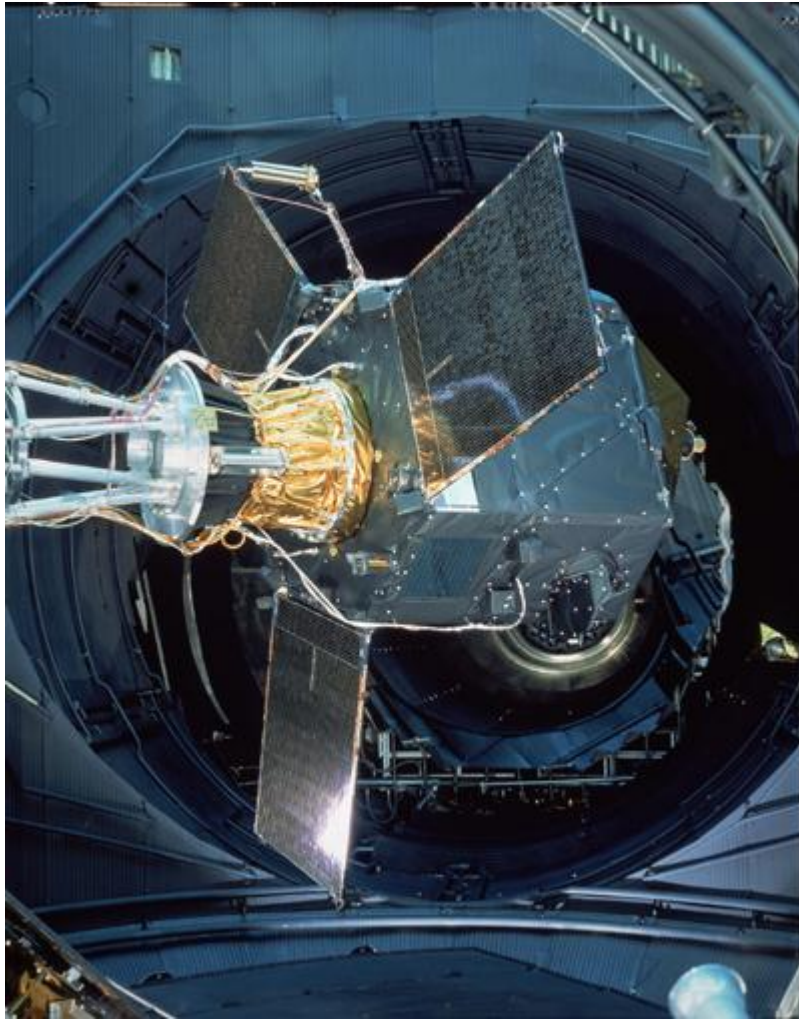

Ten years ago, on 15 August 1993, communications with ESA's Hipparcos satellite were terminated, marking the end of a remarkably successful mission. Hipparcos, the first space astrometry mission, was a uniquely European project. Built for ESA by the European aerospace industry, and launched by an Ariane-4 rocket, the 1.4-tonne Hipparcos satellite operated from 1989 to 1993. Turning slowly on its axis and repeatedly scanning the sky on different slants, Hipparcos measured angles between widely separated stars, and recorded their brightness, which were often variable from one visit to the next. Each star selected for study was typically visited about 100 times over four years. The results from these observations were published in 1997 as The Hipparcos and Tycho Catalogues.

Hipparcos pioneered the techniques of space astrometry and placed Europe at the forefront of this scientific discipline. Gaia builds on this expertise to create a satellite capable of addressing one of the most difficult challenges in modern astronomy: to create an extraordinarily precise

three-dimensional map of more than one billion stars throughout our Galaxy and beyond

To learn more about Hipparcos visit the [Hipparcos website](#).

Image courtesy of ESA.

[Published: 11/08/2003]

Picture of the Week

Improvements in precision of astrometric catalogues

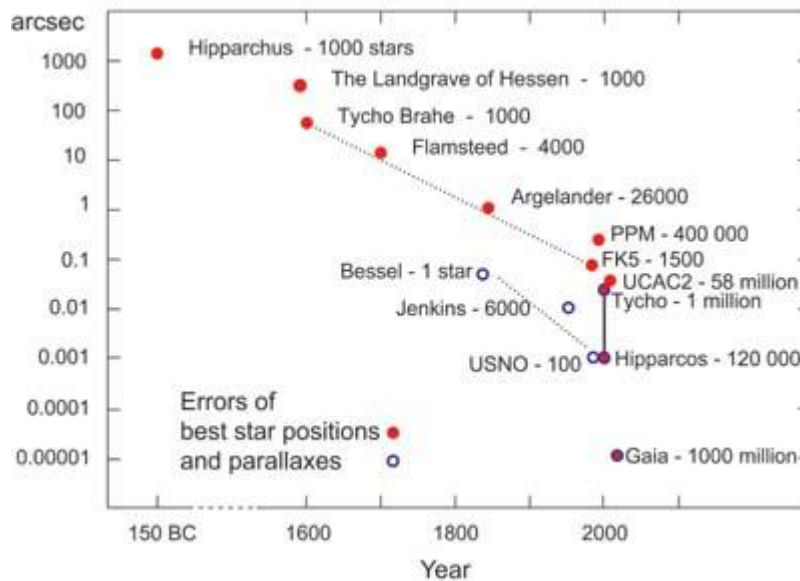

The first recognised astrometric catalogue was compiled in 129 B.C. by the Greek astronomer Hipparchus. His catalogue, of a thousand stars, specified their relative brightness and position with an accuracy of about one degree. Progress in the accuracy of angular measurements was slight until the 16th century when Tycho Brahe (1546-1601), a Danish astronomer, achieved the next leap in accuracy and fixed star positions to about a minute of arc.

During the next four centuries slow but steady progress was made in improving the accuracy of astrometric catalogues. The next breakthrough in astrometric accuracy came with ESA's Hipparcos satellite - the first space experiment dedicated to astrometry. The results from this mission - The Hipparcos and Tycho Catalogues - gave the astronomical community access to astrometric catalogues with an accuracy which would have only been obtained, for such a large number of stars, by the middle of the 23rd Century had the earlier trend been continued!

The next significant breakthrough in astrometry is expected with the Gaia catalogue of stellar positions, parallaxes and proper motions which is expected to be completed about 3 years after the Gaia mission ends. Accuracies of the order of $10\mu\text{as}$ in position and parallax measurements will be available for of order 1 billion objects.

And after Gaia? Who knows what the future will bring, but it is a challenge to foresee how the dramatic improvements in astrometric catalogues brought about by space-based experiments can be improved upon.

For more about The Hipparcos and Tycho Catalogues see the [catalogue page](#) on the [Hipparcos](#)

[web site](#).

Image based on an [original figure](#) by Erik Høg.
High-resolution version of the above image available [here](#).

[Published: 18/08/2003]

Picture of the Week

HD70642: home to other planets



On 3 July 2003, astronomers announced the [discovery](#) of a new planet orbiting the bright Sun-like star HD70642. The planet, with a mass twice that of Jupiter, was determined to be in a nearly circular orbit at a distance of 3.3 AU from its parent star. Such an orbit allows for the possibility of Earth-like planets orbiting within this star's habitable zone. Previously discovered planetary systems had massive planets which typically orbited in disruptive elliptical orbits. At a distance of 27.6 parsec (90 light years), this planetary system would be easily detected by Gaia.

Since 1995 more than 100 [extrasolar planets](#) (planets orbiting stars beyond our Solar System) have been detected. This is an average detection rate of 0.04 new extrasolar planets per day. As part of its indepth census of our local region of the Milky Way galaxy Gaia is expected to detect new extrasolar planets at a rate of about 10-15 per day. Studies have shown that over the 5 year planned lifetime of the mission Gaia will detect up to 20000 to 30000 giant planets within 100-200 pc of the Sun. For many of these new planets Gaia will measure accurate orbital parameters.

This David A. Hardy illustration depicts HD70642 as seen from a hypothetical moon orbiting the newly discovered planet.

Image: [©David A. Hardy, PPARC](#)

[\[High resolution image available\]](#)

[Published: 25/08/2003]

Picture of the Week

Entrance to the premises of EADS-Astrium, Toulouse



EADS-Astrium is one of the two main industrial groups undertaking the present (2002-04) System Level Technical Assistance and Definition Study for Gaia (the other is Alcatel-F/Alenia-I). A team of about 15 people are involved in the system level study at EADS-Astrium, and they work with other industrial teams studying the enabling technology needed for Gaia (e.g. for the CCDs, the optics, etc).

EADS-Astrium Toulouse is also involved in the studies of on-ground verification, the silicon-carbide mirror technology, and the CCDs. Formerly Matra Marconi Space, this company was also prime contractor for the Hipparcos satellite, and undertook the early feasibility studies for Gaia (1997-2002).

Learn more about EADS-Astrium at their [web site](#).

Image courtesy of Michael Perryman.

[\[High resolution image available\]](#)

[Published: 01/09/2003]

Picture of the Week

"Gaia Spectroscopy, Science and Technology"

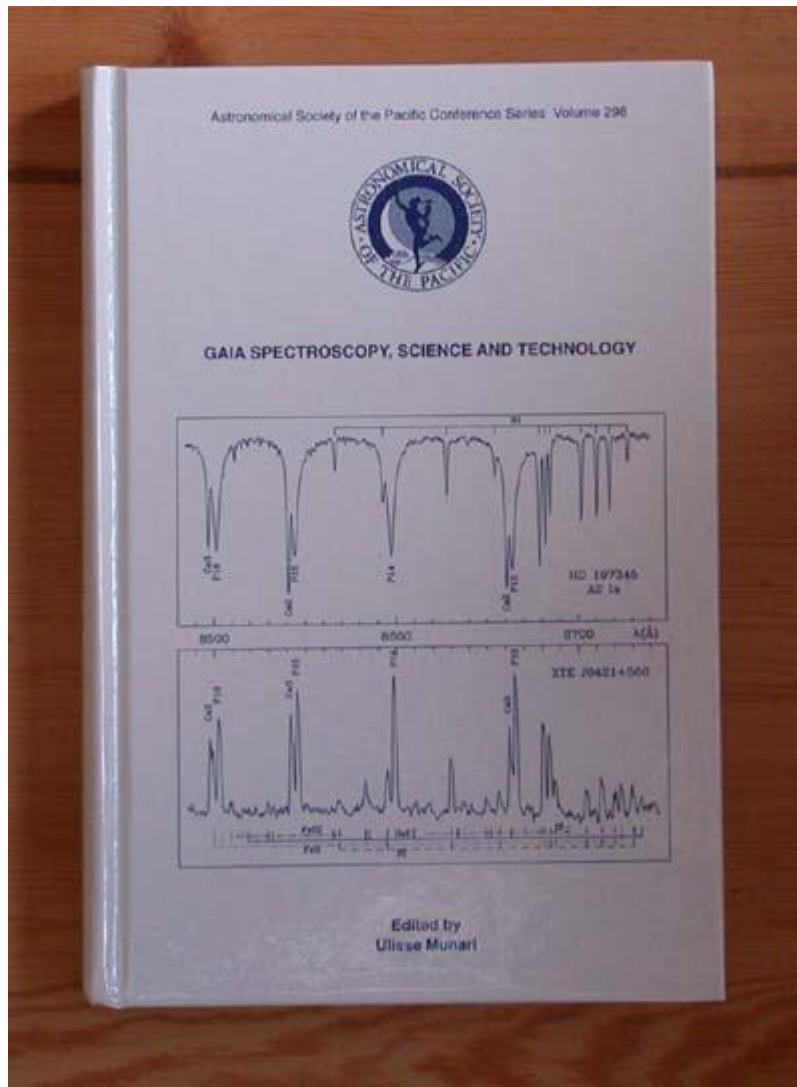

One year ago this week (9-12 September 2002), a large conference was held in Gressoney St Jean, Aosta, Italy (Monte Rosa) to present and discuss various aspects of "Gaia Spectroscopy, Science and Technology". This week see the publication of the proceedings of this meeting, Volume 298 of the ASP Conference Series. Ulisse Munari chaired the Science Organising Committee, and is editor of the Proceedings, a beautifully produced volume with some 50 presented papers and 25 poster papers. Photographs capture the personal face of the meeting and its nearly 150 participants. The volume is a comprehensive record of the status and prospects of the radial velocity instrument on Gaia. The carefully compiled index, and object index, add to the value of this volume.

[Published: 08/09/2003]

Picture of the Week

Predicted astrometric transits during the Gaia mission

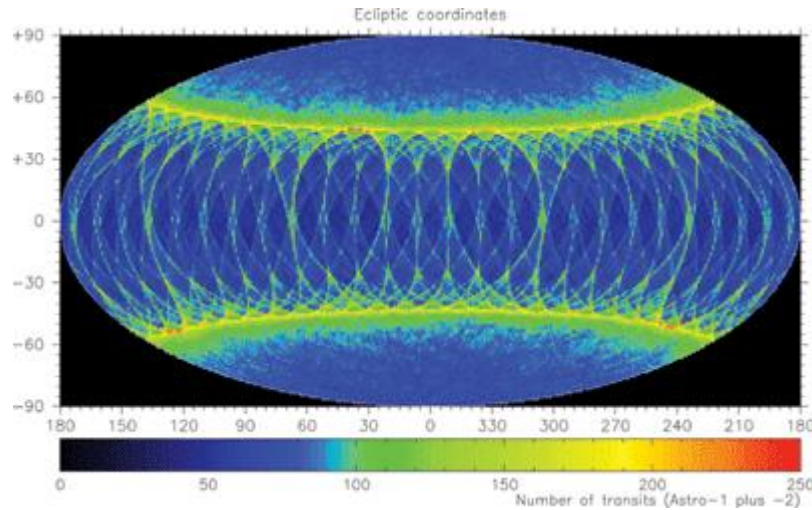

During its operational lifetime, Gaia will continuously scan the sky, roughly along great circles, according to a carefully selected pre-defined scanning law. The characteristics of this law, combined with the across-scan dimension of the astrometric fields of view, result in the above pattern for the distribution of the predicted number of transits on the sky in ecliptic and galactic coordinates. The fixed solar aspect angle ($\xi = 50$ degrees), i.e., the angle between the Sun and Gaia's spin axis, favours transits/observations of stars around ecliptic latitudes plus and minus $90 - \xi = 40$ degrees. (In galactic coordinates this region of favoured transits appears as a ring centered on the ecliptic poles.) The predicted number of astrometric observations, both astrometric fields combined and averaged over the sky, equals 83.

Technical details for these images:

Coordinate system = ecliptic / galactic (the above image alternates between these two coordinate systems);

Sky projection = Hammer;

Transverse size astrometric field of view = 0.65 deg;

$\omega = 60$ arcsec/s;

$\xi = 50$ deg;

$S = 4.095$; $K = 5.200$ revolutions/yr;

Spin axis precession period = $365.25/K = 70.24$ days;

Full mission duration = 5.5 yr (start-to-end of operations, including dead time);

Total dead time = 0.5 yr (randomly selected throughout the mission).

Image courtesy of Jos de Bruijne.

[High resolution versions available: [ecliptic coordinates](#); [galactic coordinates](#)]

[Published: 15/09/2003]

Picture of the Week

The Milky Way as a cannibal

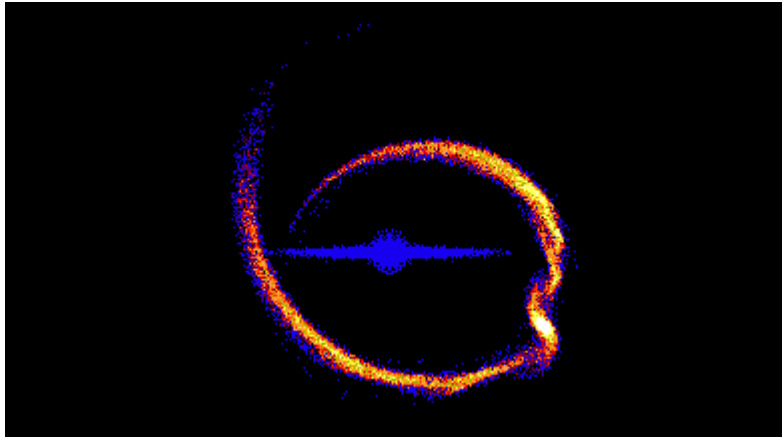

Gaia's enormous census of stars in the Milky Way and throughout the Local Group of galaxies will provide a unique set of measurements with which to unravel the early formation and subsequent evolution of the Milky Way.

One application of this data will be to studying the debris of galaxy mergers. Much information about a galaxy can be gleaned from the tidal streams of disrupting dwarf satellites. These streams provide insight into both the progenitor satellite and the dark matter halo of the parent galaxy. Gaia's measurements will provide kinematic data of tidal stream stars which in turn yield the orbit of the stream and the progenitor.

This image is taken from [an animation](#) (created by Kathryn V. Johnston) of a simulation of a satellite being torn apart by the Milky Way's tidal field. The simulation followed the satellite's evolution for several billion years. In the image, the Milky Way is represented in blue in the center, with the satellite orbiting around it. In the animation the satellite itself appears much larger than it really is because the images were coloured to emphasize the structure of the debris. This particular image is colour coded to show the density of stars being stripped from the satellite. Further information and the original animations and description are available [here](#).

Image courtesy of [Kathryn V. Johnston](#).

[Published: 22/09/2003]

Picture of the Week

First e2v CCDs for Gaia



The first batch of CCD wafers for Gaia's Astro (AF) instrument has recently been completed at the UK headquarters of e2v technologies in Chelmsford. The CCD91-72s represent one of the largest area CCDs produced by e2v. They are nearly 50% bigger than e2v's successful astronomy products used worldwide in ground-based telescopes. The Gaia device is designed to work in TDI (Time Delay and Integrate) mode. This allows an integrated image to be built up by the continuously scanning satellite, an essential concept at the heart of Gaia's mission to map with unprecedented accuracy the space position and motions of over a billion stars.

Under contract to EADS-Astrium (Toulouse) to design and manufacture custom designed chips for both the Astro and Spectro instruments on Gaia, e2v is also working with EADS-Astrium to develop advanced packaging techniques using the unique Silicon Carbide capability of EADS-Astrium. These techniques are necessary to achieve the alignment accuracy required across the huge focal plane in order to allow the TDI concept to work. At approximately 0.5 metre square the Astro focal plane of CCDs will be the biggest ever flown in space.

The 32 high performance, large format imaging devices that will be delivered to EADS-Astrium over the next 10 months will be used to verify the operational concepts in the design of the device. They will also be used in the assembly of a test section of the focal plane to be used in alignment tests.

Pictured above: part of the team from the e2v wafer fabrication area that has produced the initial batch of CCDs. Back row, left to right: Roy Steward, Gaia CCD Project Manager; Pat Mandell, Wafer Fabrication Operative; Sheila Clift, Photolith Inspector; Alan Bidewell, Wafer Fabrication Operative; Glenn Wood, Wafer Fabrication Manager.

Front Row, left to right: Derek Nunn, Team Leader; Phil Etheridge, Line Engineer; Andy Raine, Inplant Operator

Inset: Two CCD91-72 CCDs on a silicon wafer. Each CCD comprises 4500x1966 pixels each 10x30µm in size. (Small test structures are visible on either side of the CCDs.)

Photo courtesy of [e2v technologies](#).

[\[High resolution image available\]](#)

[Published: 29/09/2003]

Picture of the Week

Observations of quasars

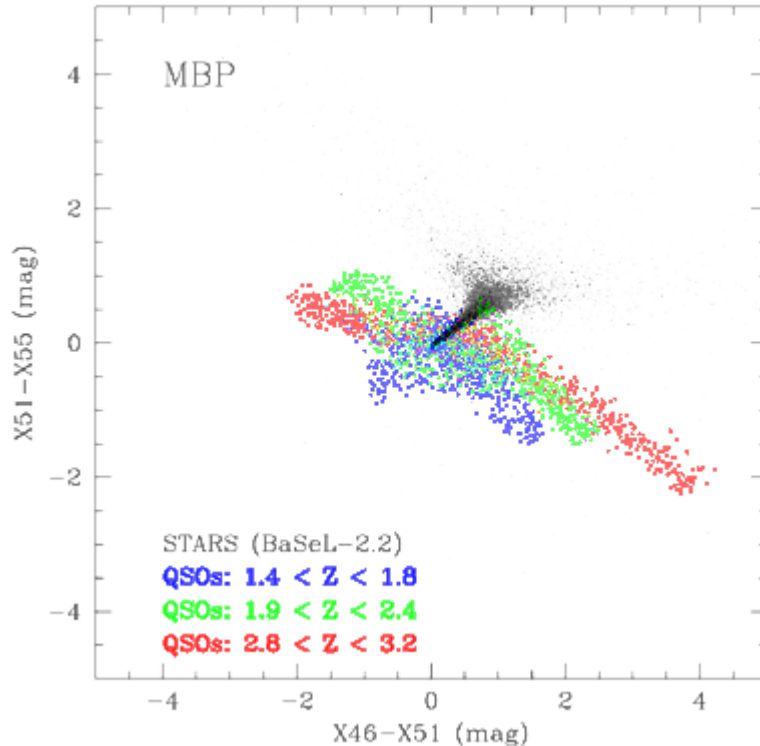

Gaia will provide astrometric and photometric observations for about 500,000 quasars (QSOs) to $G = 20$ mag over the whole sky, 5 times more than the number expected from the Sloan Digital Sky Survey. In the process Gaia will create the first all-sky survey of optically selected Active Galactic Nuclei (AGN) and QSOs.

AGN and QSOs are of prime importance in establishing the relativistic reference frame for the Gaia mission. In addition, the resulting QSO sample will have a profound impact on studies of the large scale structure of the Universe. Gaia also offers the prospect of constraining the value of cosmological parameters from their small angular scale lensing structure.

In Gaia's medium band photometry (MBP) filters, QSO emission lines make strong signatures at specific redshifts. These can be clearly seen in the colour-colour diagram above which shows star and QSO loci ($G = 18$ mag), where the signatures of the CIII], CIV and Ly-alpha emission lines are visible in the distribution of the blue, green and red objects respectively.

For more information see the Information Sheet on [Observations of Quasars](#).

Image courtesy of Jean-François Claeskens & Alain Smette.

[Published: 13/10/2003]

Picture of the Week

Baade's window as seen by Gaia's Astrometric Sky Mappers

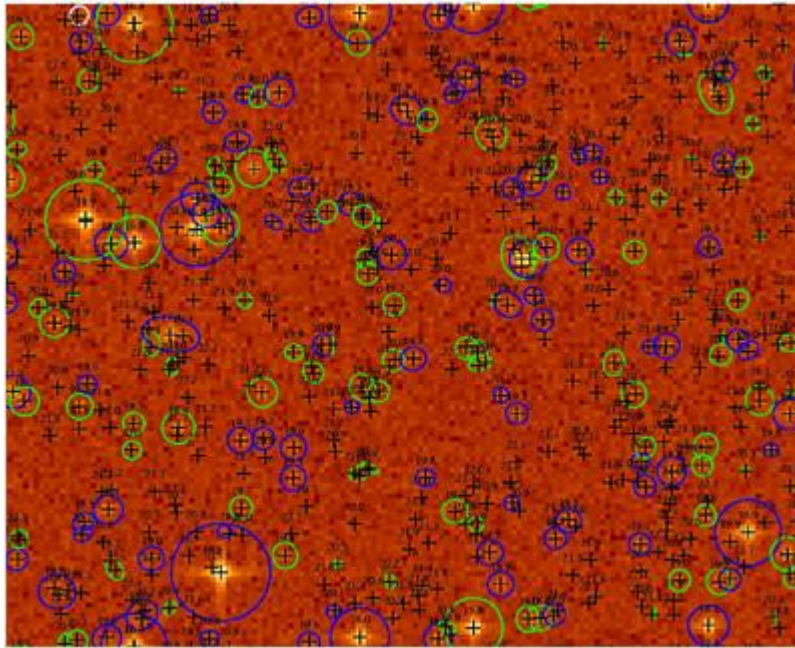

Gaia will detect up to 1 billion stars to magnitude 20 in a unique bandpass. Since there is no existing (or foreseen) catalogue which lists all such stars, let alone transient events such as supernovae or Solar System objects, an input catalogue for identifying stars (as was used in the case of Hipparcos) cannot be used. On-board detection will therefore be required. This will be performed by detecting objects as they pass through the Astrometric Sky Mappers, prior to crossing the astrometric field proper.

The on-board detection algorithm is in an advanced state of development, and aims to optimise the scientific return of Gaia and the on-board processing architecture.

One of the most challenging star fields to handle is that of Baade's window where the stellar density reaches the maximum that can be managed in real-time with Gaia's astrometric telescopes.

The image above shows a 13x32 arcsec image simulated with the Gibis Gaia Simulator (developed by Carine Babusiaux and colleagues) using a star list extracted from a Hubble WFPC2 image. Black crosses refer to stars from magnitude 15 to 23. Detections are shown with blue (single star) and green (double stars) ellipses. A detection rate of 86 per cent at magnitude 20 (with no false detections) was achieved. The incompleteness is due to faint companions too close to a brighter primary star.

See also the Information Sheet on [Object Detection](#).

Image courtesy of Frédéric Arenou.

[\[High resolution image available\]](#)

[Published: 20/10/2003]

Picture of the Week

ESTEC: the European Space Research and Technology Centre



The project teams for each of ESA's scientific missions are based at ESTEC on the west coast of the Netherlands. This is where the Gaia study manager, project scientist, technical officers and other support personnel working on Gaia carry out their day-to-day activities.

The principal activities performed in ESTEC cover areas such as:

- managing space projects & preparing for future projects;
- providing technical support in a wide range of space-related disciplines;
- developing new technology for space missions in collaboration with European industry;
- quality control and testing of satellites (in Europe's largest satellite testing facility).

To learn more about ESTEC visit the [ESTEC web pages](#).

Image courtesy of ESA.

[Published: 27/10/2003]

Picture of the Week

Asteroids as calibration standards for Gaia's RVS

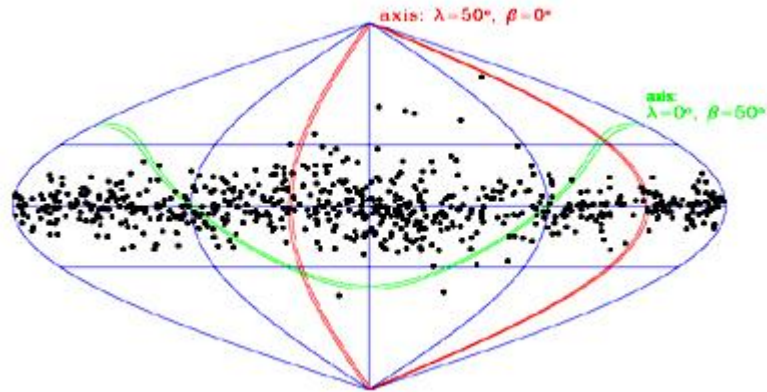

In addition to two astrometric telescopes Gaia will carry a Radial Velocity Spectrometer (RVS). This will be a self-calibrated instrument using spectra obtained during the mission to calibrate the wavelength scale of the instrument. To ensure reliable and consistent calibration a large number of objects with accurately known radial velocities are desirable.

Tomaz Zwitter (University of Ljubljana) and Françoise Crifo (Observatoire de Paris-Meudon) reviewed the suitability of existing radial-velocity standard stars as wavelength calibration standards for the RVS. They concluded, taking into account the saturation limit of the instrument, that few of these stars would be accessible to Gaia. To supplement the stars that remain they propose including RVS observations of suitable asteroids whose radial-velocities are well-known. The distribution of asteroids is such that the RVS will typically observe 1 standard star and 2 bright asteroids in each 6-hour revolution.

The image above shows asteroids (and comets) brighter than $V=15$ on 19 September 2003 at 13h GMT, plotted in ecliptic coordinates centred in the anti-Sun direction. Coloured lines indicate the area covered in one 6-hour rotation of Gaia around its axis. Red: when the satellite axis lies in the ecliptic plane. Green: when the satellite is at the greatest elongation from the ecliptic.

The report *Asteroids as wavelength calibration standards for the radial velocity spectrograph of the Gaia mission* prepared by Tomaz Zwitter & Françoise Crifo is available from the [RVS consortium web site](#)

Image courtesy of Tomaz Zwitter & Françoise Crifo.

[Published: 03/11/2003]

Picture of the Week

High stability optics prototype at TNO TPD, Delft, NL

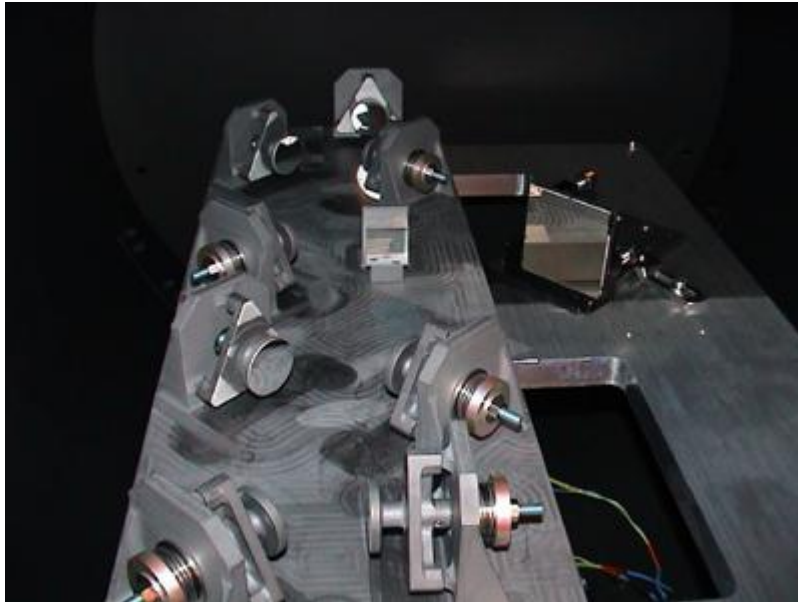

One of the ongoing technology activities is to develop a test bench representative of the technology to be used for Gaia's 'basic angle monitoring system'. Integrated into the payload optical system is a complex dual-arm interferometer, fed by a single laser source, designed to monitor any changes in the angle between the two astrometric viewing directions once the satellite is in orbit. The entire thermal and mechanical stability of the payload is designed to avoid such changes, but although they are not expected, they must still be monitored.

Fabricated from silicon carbide (as are the Gaia optics and optical bench), a prototype monitoring system has been designed and constructed in a collaboration between EADS Astrium (Toulouse) and TNO TPD (Delft). A series of tests, which will be carried out over the coming weeks, are designed to verify that the system can be aligned with the required accuracy, that it can withstand the launch loads without damage or misalignment, and that it provides the thermal stability required for the in-orbit monitoring. Vacuum testing will be carried out between -50 and +50 °C. The requirements are stringent: the path length stability required is below 4 picometers for a temperature stability of 45 microKelvin, and post-launch tilts must be below 5 microradians.

The image shows the test bench in Delft. The overall equipped bench dimensions are 600mm x 190mm x 90mm.

Image courtesy of Joep Pijnenburg, Rob Vink & Ben Braam (TNO TPD Delft), Bertrand Calvel (EADS-Astrium Toulouse) and Bernd Harnisch (ESA-ESTEC)

[\[High resolution image available\]](#)

[Published: 10/11/2003]

Picture of the Week

Gaia planet discovery space

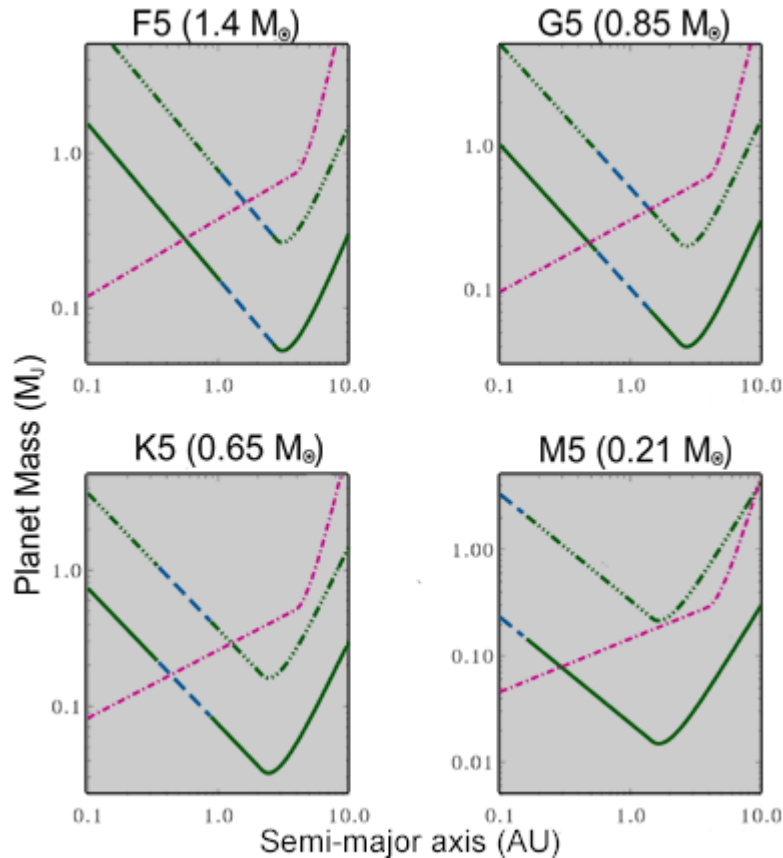

A. Sozzetti and colleagues have evaluated how Gaia observations of nearby stars ($d < 25\text{pc}$) will contribute to the database of stars to be observed by the ESA/NASA Darwin/TPF when it is launched in the middle of the next decade.

Gaia's primary contributions to the population of the Darwin target database will be:

- confirmation of the existence of Jupiter signposts from radial velocity measurements;
- extension of spectroscopic surveys to late K through M dwarfs, complementing ground-based observations;
- providing estimates of the planet mass, thus contributing to models establishing whether or not dynamical interactions would permit an Earth-like planet to form in the habitable zone;
- measuring the inclination of the orbital plane, complementing ground-based studies of exo-zodiacal cloud emission for the extra-solar system. (Potential targets with edge-on orbital inclination will be excluded from the target list.)

The image above shows the Gaia planet discovery space as a function of orbital radius, stellar

spectral type and distance from the observer (green solid line: 5 pc; green dashed-dotted line: 25 pc). The blue dashed line represents the habitable zone of the star. The pink dashed line indicates the planet discovery space for 3 m/s precision radial velocity measurements.

[The Gaia Astrometric Survey of the Solar Neighbourhood and its Contribution to the Target Database for Darwin/TPF](#), A. Sozzetti et al., will appear in Proceedings of the Conference 'Toward Other Earths: DARWIN/TPF and the Search for Extrasolar Terrestrial Planets' to be published as ESA SP-359.

Image courtesy of A. Sozzetti

[Published: 17/11/2003]

Picture of the Week

Astrometric microlensing with Gaia

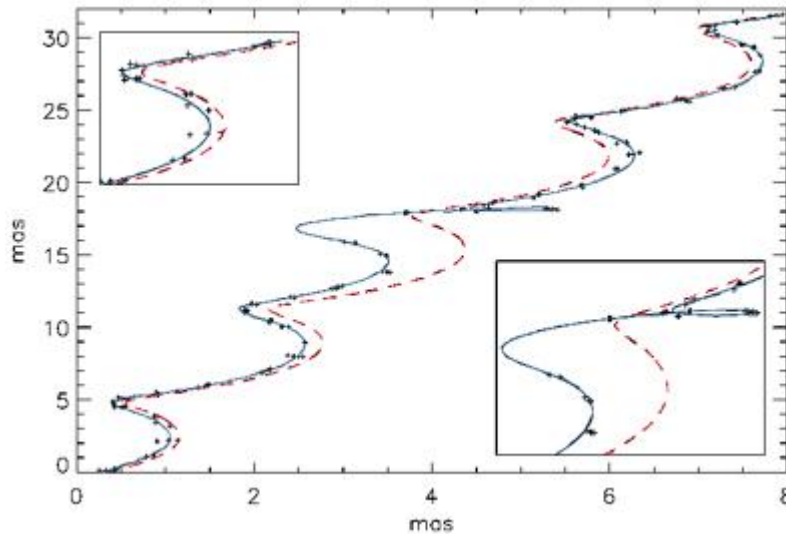

One by-product of the Gaia mission will be a unique inventory of the mass of objects in the solar neighbourhood, irrespective of their luminosity, by way of microlensing. The astrometric microlensing signal measured by Gaia will be sensitive to local populations (within ~ 1 kpc of the Sun) of even the dimmest stars and other dark objects such as isolated neutron stars and black holes.

Simulations by Belokurov & Evans (2002) suggest that ~ 25000 sources will exhibit microlensing events during the 5 years of Gaia's mission. About 10 per cent of these will be of such high quality that the mass of the lens will be recovered with good accuracy.

Gaia measures the small deviation of the centroid of the two images (from a microlensed event) around the trajectory of the source. The image above simulates an astrometric microlensing event as observed by Gaia. Data points include typical sampling astrometric errors for Gaia. The theoretical trajectories of the source are shown with (blue line) and without (red line) the event. The astrometric deviations at the beginning (inset: top left) and the maximum of the event (inset: bottom right) can be clearly detected by Gaia.

Image from [Five years at the Movies](#), N.W. Evans & V. Belokurov, in Proceedings of the Third Sakharov Conference, 2002, eds A. Semikhatov et al., (Scientific World, Moscow).

[Published: 24/11/2003]

Picture of the Week

Gaia's scanning law

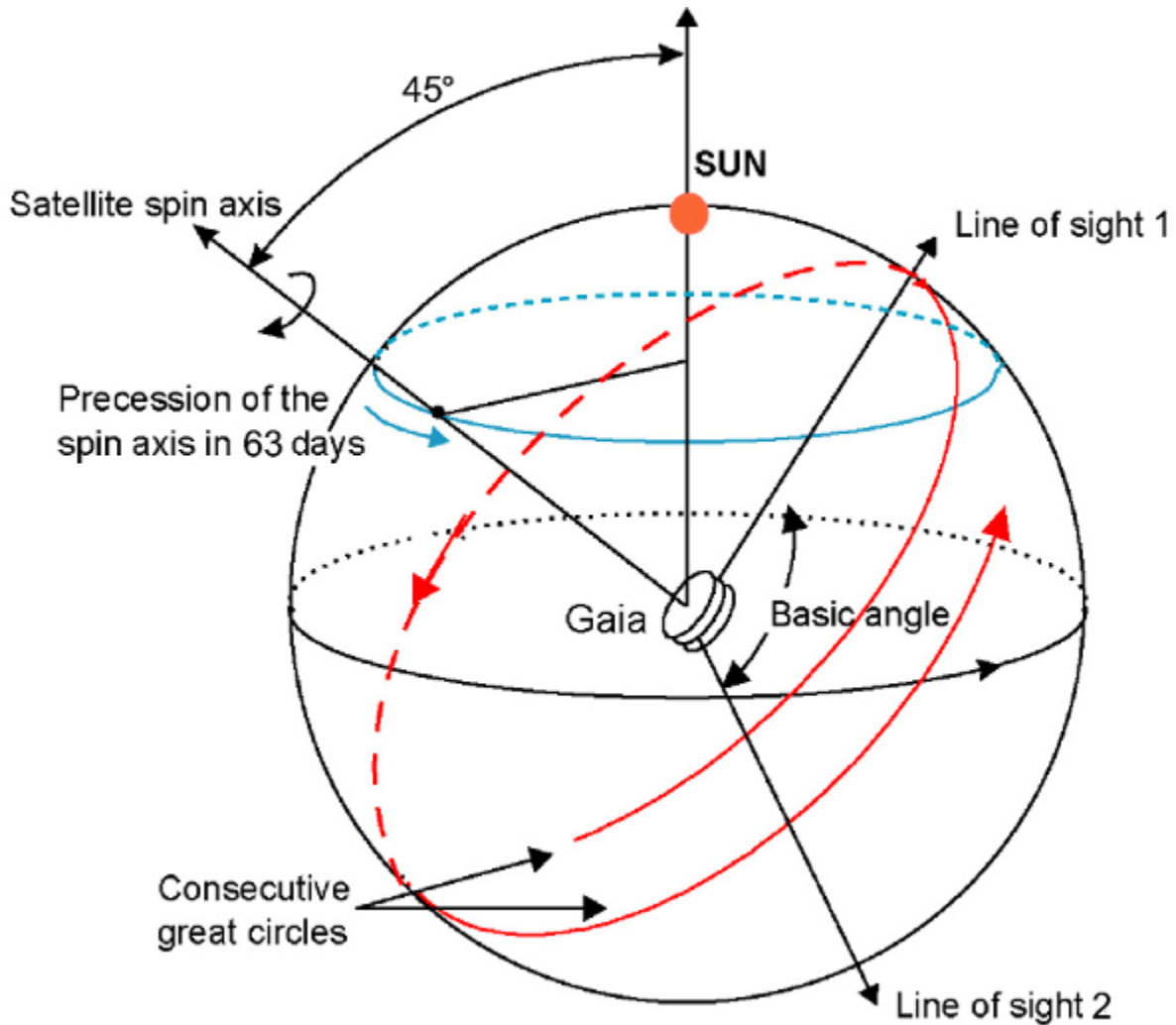

During its five year mission Gaia will observe the sky from an orbit around the L2 Lagrange point of the Sun and Earth-Moon system. In this location the satellite will perform a continuous spinning motion about its principal symmetry axis (the satellite spin axis). The spin rate is constant at 60 arcsec/s, so one full revolution will take 6 hours. In this time the two astrometric viewing directions (Line of sight 1 and Line of sight 2) which are perpendicular to the spin axis and separated from each other by a 'basic angle' of 106.5 degrees, scan one great circle on the sky.

The orientation of the spin axis is not constant but instead precesses about the satellite-Sun vector with a period of 63.12 days while the angle between the spin axis and the Sun direction is kept at a constant value of 45 degrees.

These two independent motions constitute the so-called Nominal Scanning Law. Its free parameters (angles, revolving periods) have been chosen in order to achieve optimal sky coverage during the mission's lifetime.

(See also the information sheet on the [Scanning Law](#).)

[\[High resolution image available\]](#)

[Published: 08/12/2003 | Updated: 16/06/2010]

Picture of the Week

Participants at the joint meeting of the Radial Velocity Spectrometer and Simulation working groups



A joint meeting of the Radial Velocity Spectrometer (RVS) and Simulation working groups was held at the Observatoire de la Côte d'Azur (Nice, France) on 10-12 December 2003.

About 40 people attended the meeting and the topics discussed included simulations of the RVS (spectra, field-of-view and CCDs), the integration of RVS simulations into the Gaia simulator, and RVS telemetry and related topics.

In the photo above participants at the meeting are seen in front of the main entrance of the building housing the large (76 cm) 19th century refractor of the Observatory.

Further details of the meeting and more pictures can be found on the ["Meetings of the Simulation and RVS working groups" web pages](#).

[\[High resolution image available\]](#)

Image courtesy of Tomaz Zwitter.

[Published: 15/12/2003]

2004

12/20: Astro CCD tests
◄ 12/06: FPA baseplate
◄ 11/22: Interconnection module
◄ 11/08: PE Modules
◄ 10/25: Scanning law II
◄ 10/11: Reference frame
◄ 09/20: Testing L3CCDs
◄ 08/30: CCD metrology
◄ 08/23: Gaia Symposium
◄ 06/28: PoW - first year
◄ 06/21: CCD evaluation
◄ 06/14: Artistic spacecraft
◄ 06/07: Star tracking
◄ 05/31: Spectralib
◄ 05/24: Digital Universe
◄ 05/17: Gaia M1 mirror
◄ 05/10: v t CMD
◄ 04/26: Gaia parameter database
◄ 04/19: RVS optics design
◄ 04/12: Supercomputer
◄ 04/05: CCD depletion
◄ 03/29: Giant planets
◄ 03/22: KBO's
◄ 03/01: GS visibility
◄ 02/16: Halo accretion
◄ 02/09: Filter Design
◄ 01/19: Sunshield
◄ 01/12: Lund Map
◄ 01/05: The ICRF

Picture of the Week

The International Celestial Reference Frame

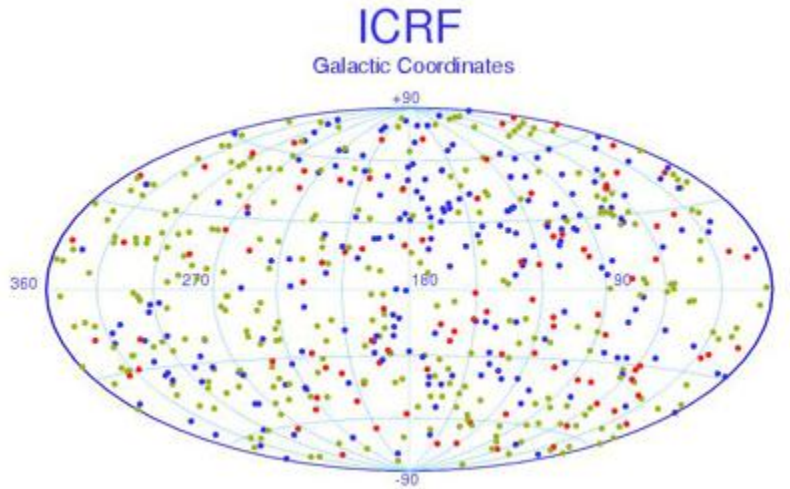

The definition and the creation of the International Celestial Reference Frame (ICRF) was a joint cooperative effort of a sub-group of the International Astronomical Union (IAU) Working Group on Reference Frames. It was formed expressly for the purpose of creating the definitive catalogue of extragalactic radio source positions using the best data and methods available at the time the work was done.

The ICRF was adopted by the International Astronomical Union as the fundamental celestial reference frame, replacing the FK5 optical frame as of 1998 January 1.

The ICRF is the realization of the International Celestial Reference System (ICRS) at radio wavelengths. The [Hipparcos Catalogue](#) (1997), which includes all the FK5 stars, was astrometrically aligned to the ICRF and currently provides the primary realization of ICRS at optical wavelengths. Gaia will create a much denser frame directly in the visible with an average of 20 sources per square degree outside the galactic plane, an increase by a factor of almost a thousand from the current ICRF.

The image above depicts the sky distribution in galactic coordinates of the approximately 660 extragalactic sources that make up the International Celestial Reference Frame (ICRF). These are radio sources observed by long baseline interferometry and are primarily very faint in the visible.

For more about the ICRF see the [International Celestial Reference Frame](#) web pages.

Image courtesy of F. Mignard

[Published: 05/01/2004]

Picture of the Week

The Lund Panorama of the Milky Way

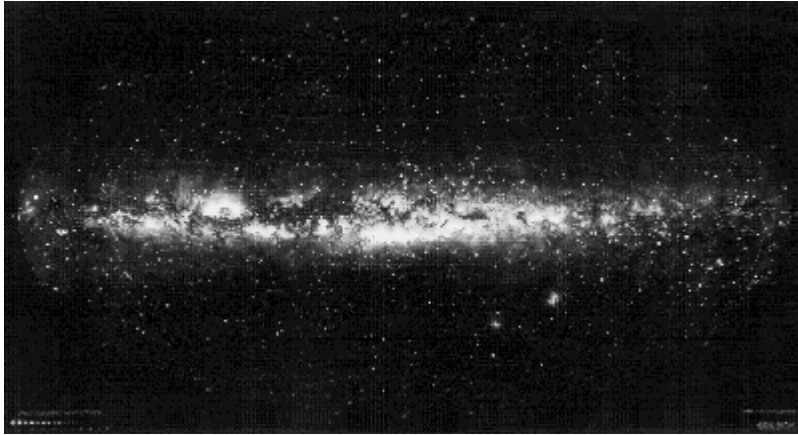

Towards the middle of the last century astronomer Knut Lundmark, of the Lund Observatory in Sweden, supervised a team of draftsmen who painstakingly mapped the positions of about 7000 individual stars to create an unprecedented drawing of the Milky Way. The map took two years to complete, measures 2m by 1m, and is usually referred to as the [Lund Panorama](#) of the Milky Way.

The Gaia mission also aims to produce a map of the Galaxy - but one based on the accurate measurements of the positions and motions of around 1 billion stars. It is unlikely to be reproduced by hand in the same manner as the Lund Panorama!

More information on the construction of the Lund Panorama of the Milky Way is available on the [Lund Observatory web site](#).

See also the [annotated version](#) indicating the areas of influence of the Gaia and Hipparcos missions.

Image credit (and copyright): [Lund Observatory](#)

[Published: 12/01/2004]

Picture of the Week

Deployable sunshield for Gaia

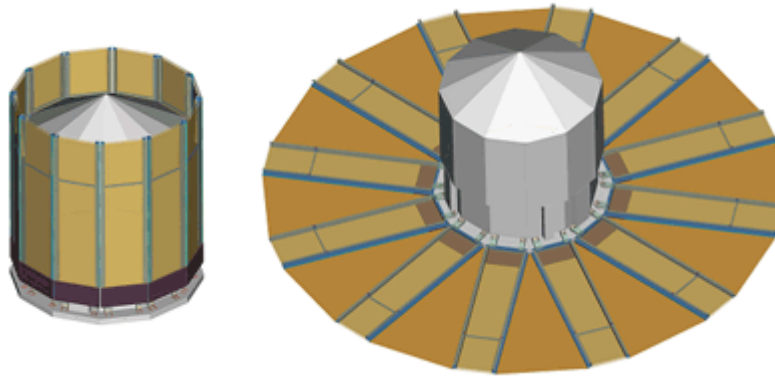

Cornerstone missions in the ESA Science Programme are technically and scientifically challenging projects, building on existing European excellence in many fields and providing the opportunity to develop and test new areas of expertise. Gaia is no exception to this and there are several areas in which European ingenuity will be given an opportunity to shine as solutions are sought for some of the technically challenging aspects of this project. One of these areas is the design and construction of a large, light-weight, deployable sunshield for Gaia.

In order to achieve the mission's scientific goals, the payload thermal stability must be maintained within strict limits. This can be achieved by means of a sunshield which minimizes thermal fluctuations on the payload module. But what is the optimum concept for the Gaia sunshield? This is the question that will be addressed by the Spanish company Sener as part of an on-going activity to study the sunshield assembly for Gaia.

Several constraints are imposed on the sunshield by the design of the satellite:

- The size of the sunshield will be primarily determined by the height of the payload and service modules. Present studies indicate that the sunshield will be of order 10 meters in diameter.
- The sunshield must be folded in some manner in order to fit into the launcher, and deployed once the satellite is launched. The deployment must be smooth so as not to perturb the payload.
- In addition, the mass, power and cost of the sunshield must be compatible with the overall system budgets.

The Sener study is conducted using computer modelling techniques and verifying these models through scaled mockups of the various elements. The image above depicts a concept for a folded (left) and deployed (right) sunshield. An animation produced by Sener shows the deployment of

a sunshield element ([animated gif](#) or [avi format](#)).

Find out more about Sener's activities from their [web site](#).

Images and Animation courtesy of Sener

[Published: 19/01/2004]

Picture of the Week

Heuristic Filter Design applied to Gaia

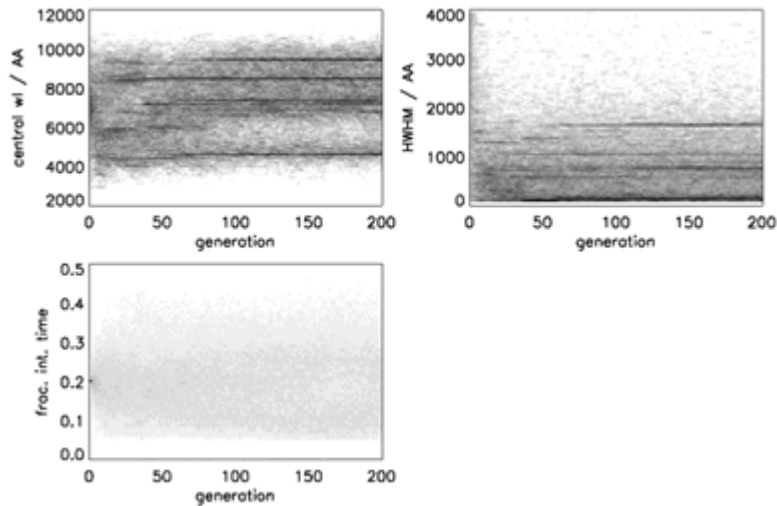

The design of the Gaia photometric systems is a complex task because it must accommodate numerous different requirements. The filter systems are primarily designed to determine astrophysical parameters (such as effective temperature, surface gravity, abundances) for single stars - the main Gaia target. They must do this across a very wide range of spectral types, thus some of the requirements are inevitably conflicting. Designing a system which is the best compromise between these requirements is a challenge.

To address this problem, Coryn Bailer-Jones has developed a novel method to design photometric systems using principles of natural selection from evolutionary biology. By parameterizing a filter system and defining an appropriate Figure-of-Merit (FoM) of its performance, this method uses a population-based approach to search the vast space of possible solutions and to converge on an optimum solution.

The figure above shows how the three filter parameters - central wavelength, filter width (HWHM) and fractional integration time - evolve during the successive generations of the procedure. The run shown is for the optimization of a 5-filter system (i.e. a total of 15 free parameters), using a population of 200 individuals (filter systems). Thus at each generation, there are 1000 different values of each of the three parameter types in the population. These are shown as a grey scale density plot, with darker representing more individuals. As the evolution proceeds, one can see how the central wavelength and HWHM distributions are dominated by a restricted set of values, indicating some kind of convergence.

This method, HFD (Heuristic Filter Design), has the advantage that it turns filter design into a quantitative optimization procedure which makes minimal assumptions about the required filter system. The FoM can be adjusted to reflect the scientific goals of the mission, and the

performance of the filter systems on the different aspects of the problem can be assessed. The systems designed so far appear to perform at least as well as other proposed Gaia systems, although the HFD method has highlighted potential problems with all of these. Ongoing developments of HFD are targeted at addressing such problems.

More information on HFD can be found in the report *Evolutionary design of photometric systems and its application to Gaia* ([PDF format](#), or read the [abstract](#)).

[Published: 09/02/2004]

Picture of the Week

Hints of halo accretion

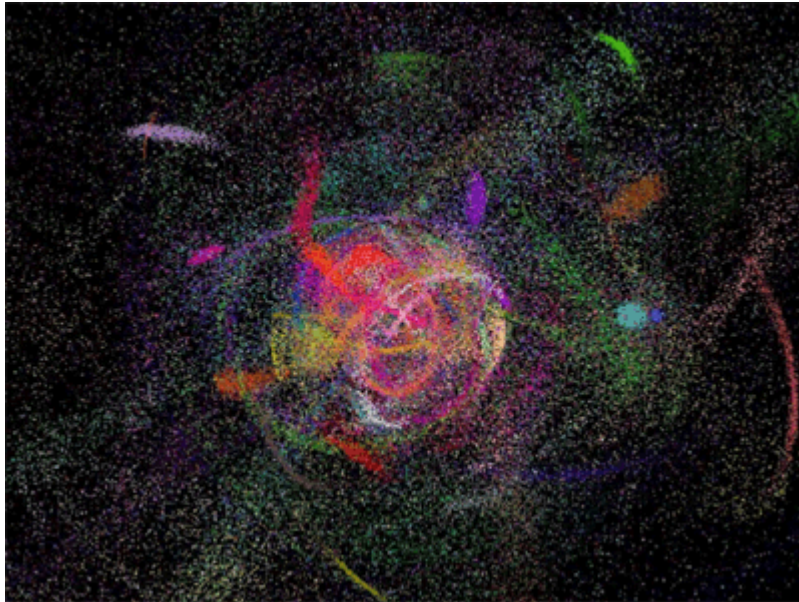

How was our Galaxy formed? This is one of the key areas on which Gaia aims to throw some light. In the search for the answer the Milky Way halo may be the most important component used to distinguish among competing scenarios for the formation of the Galaxy.

Classical formation scenarios consider the monolithic early collapse of a single system with subsequent accretion in the outer Galaxy but this view has been challenged in recent years by alternative models in which galaxies are formed by mergers and accretion of smaller satellite galaxies.

Such merger and accretion events can be identified by the velocity signature of the events. Substructure remains visible in velocity space long after it has disappeared in density space. Thus accurate measurement of the motions of a large number of stars in the Galaxy can identify moving streams of stars whose origin can be traced to an earlier accretion event.

Large-scale CCD surveys, such as the Sloan Digital Sky Survey, are beginning to reveal tantalising evidence of substructure in the outer halo. Gaia will be the first space mission to provide the precision and accuracy required to identify unambiguously a number of moving streams.

The image is created from Paul Harding models and depicts a halo formed by the accretion of 50 dwarf galaxies at various times during the last 10 Gyr.

Image courtesy of Paul Harding.

[\[A high resolution postscript image, with white background, is available.\]](#)

[Published: 16/02/2004]

Picture of the Week

Ground station visibility

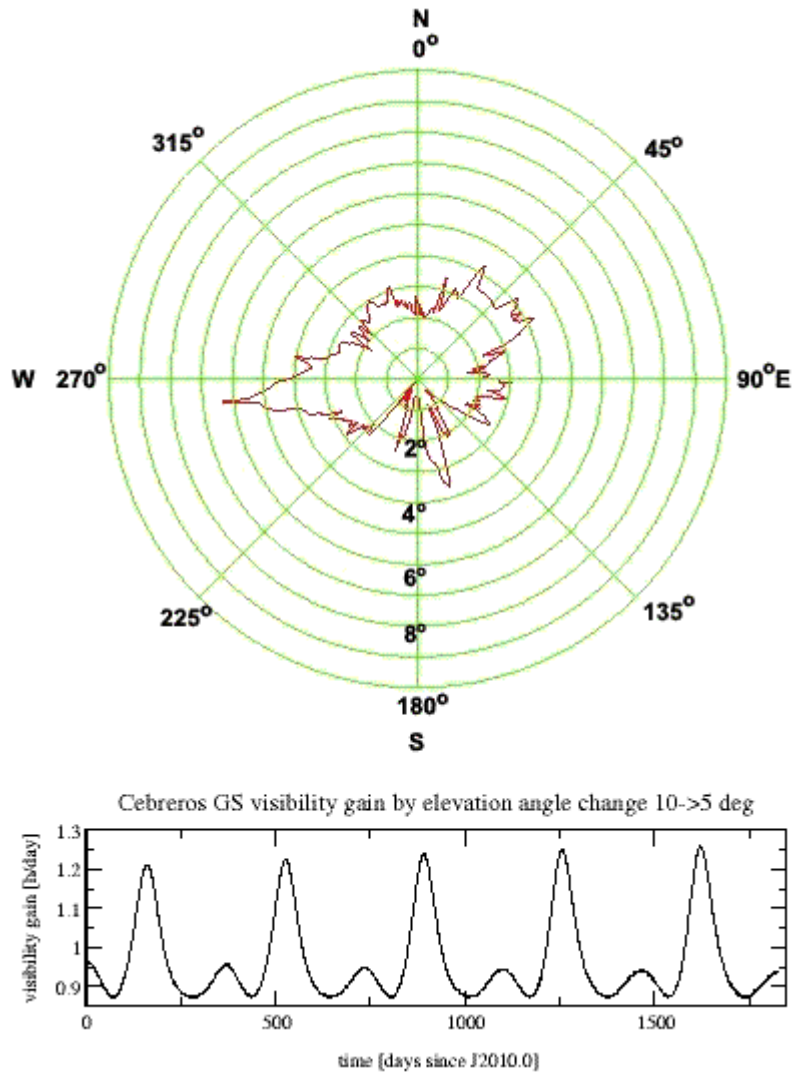

From its Lissajous orbit around L2 the Gaia spacecraft will be in periodic but not continuous contact with a single ground station on the rotating Earth. During these visibility intervals, which have a minimum duration of 8 hours per day, observation data gathered during preceding non-contact periods are transmitted to the ground via a high-capacity downlink channel. This communication is only possible if the spacecraft appears over the horizon at the ground antenna location higher than a minimum elevation angle. The current baseline for the primary Gaia ground station is Cebreros (Spain) with a minimum elevation angle of 10degrees.

Owing to the large data volume that the payload will generate onboard there is a strong interest in maximising the daily contact times. One way to achieve this is to relax the constraints on the

minimum elevation angle, i.e. to begin the data downlink at an even lower elevation angle.

In the figures above the lower curve shows the gain in daily contact time (in units of hours per day) for Cebros when lowering the elevation angle from 10 to 5 degrees over the five year mission duration. A detailed calculation shows that the improvement is about 1 hour per day and increases the average daily contact time from 10 to 11 hours.

Lowering the elevation angle even below 5 degrees appears attractive but there are natural limits which prohibit this. The top image shows a polar altitude profile plot of the landscape around the Cebros antenna in units of elevation angle degrees. It can be seen that for angles lower than 5 degrees, more and more natural obstacles are likely to obstruct the line-of-sight rendering communications unreliable or impossible. A mountain to the West hinders transmission at an elevation angle of 5 degrees.

Images courtesy of Rolf Martin (upper image) & U. Lammers (lower image)

[Published: 01/03/2004]

Picture of the Week

Kuiper Belt Object: 2004 DW

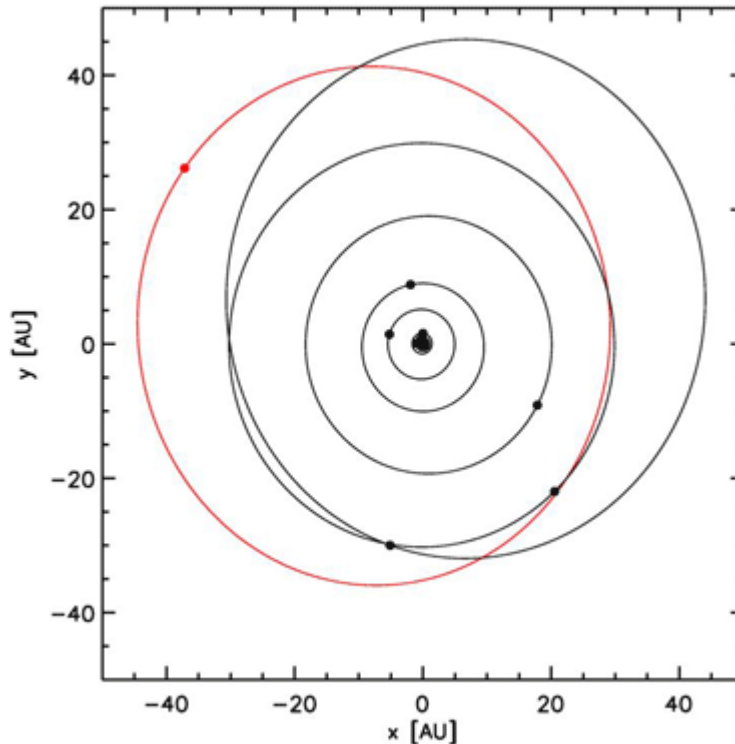

The existence of a belt of material in orbits with semi-major axis between 30-50 AU was suggested independently by G. Kuiper and K. Edgeworth in the late 1940's-early 1950's. With the detection, since 1992, of about 800 small bodies in the outer Solar System the existence of this Kuiper-Edgeworth belt seems well established. These small bodies are also referred to as "trans-Neptunian objects".

Simulations indicate that Gaia will observe a small number of trans-Neptunian objects. Despite this it will make a valuable contribution to the study of the outer Solar System by surveying the entire sky - thus covering areas inaccessible to ground-based instruments. Gaia will also provide the only direct measurement of the size of some objects, thus providing a measure of their albedo. A small number of trans-Neptunian objects detected by Gaia are expected to be binaries. With the astrometric accuracy of Gaia this binarity can be detected, leading to a direct measurement of the mass of these objects.

One of the most recently discovered (17 February 2004) trans-Neptunian objects is 2004 DW. From initial observations it appears that 2004 DW may be one of the largest of the trans-Neptunian objects detected to date, with a diameter of about 1500 km. The orbit - determined from recent observations and serendipitous discovery on old photographic plates - is very similar

to that of Pluto's, as evident from the image above (see also the [FAQ's about 2004 DW](#)). The figure depicts the known planets in black and 2004 DW in red. From currently available data it appears that 2004 DW could be observed by Gaia.

For more about Gaia observations of Kuiper-Belt objects see the [Information sheet on Trans-Neptunian Objects and Centaurs](#).

More about [2004 DW](#) from the discovery team.

Image courtesy of Chad Trujillo.

[Published: 22/03/2004]

Picture of the Week

Relativistic light deflection by giant planets

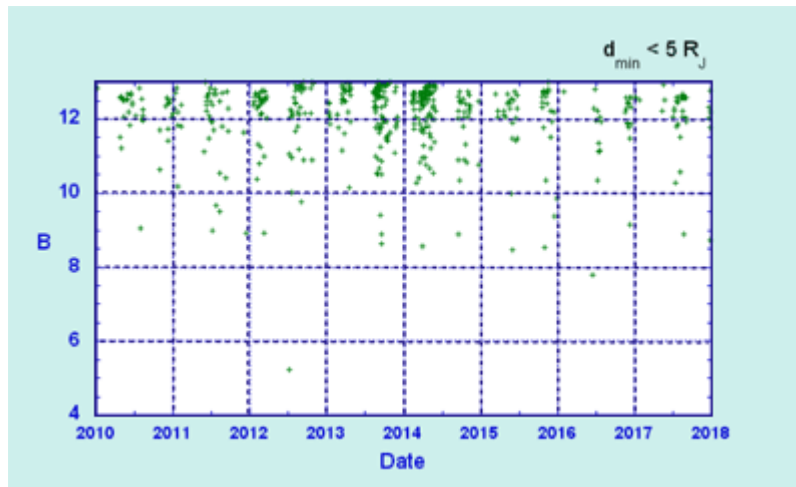

Relativistic light deflection by giant planets will be observed by Gaia during its five-year mission. Due to the difficulty of performing observations in the vicinity of bright and extended sources, only very bright stars will be measured during the planetary transit. An Eddington-like experiment is being studied to see whether even the relativistic quadrupole effect of Jupiter can be seen in the star position. The plot shows all the stars brighter than $B = 13$ that will be seen from L2 at less than 5 Jupiter radii between 2010 and 2018. Due to the particular form of the scanning, stars at solar elongations not observable by Gaia have been removed from the selection.

Image courtesy of F. Mignard.

[\[A larger version of this image is also available.\]](#)

[Published: 29/03/2004]

Picture of the Week

CCD depletion

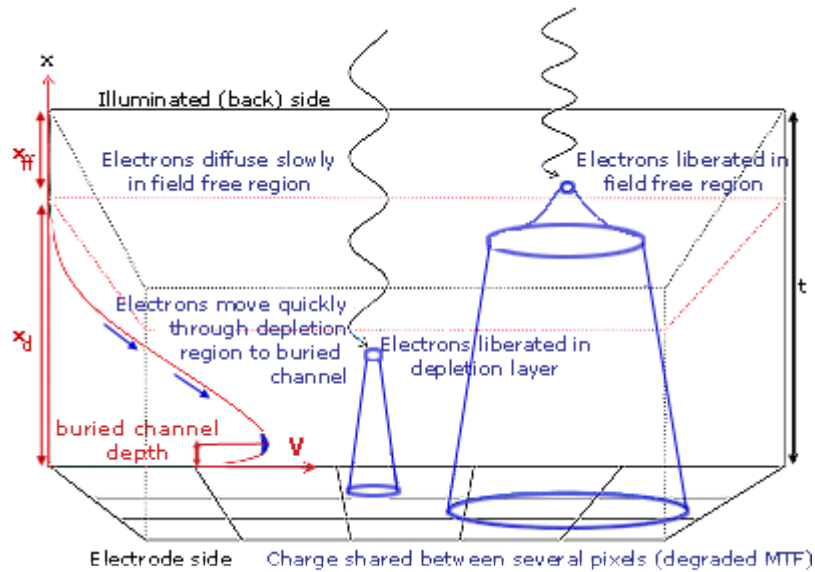

All semiconductor detectors require a photo-sensitive region in which charge carriers liberated by incident photons (Compton effect, photoelectric effect or pair production) will be moved or collected. In the case of Gaia, the detectors are silicon CCDs, the dominant effect (by far) is the photoelectric effect and liberated electrons are collected in potential wells. Because the Gaia CCDs are back illuminated, the photo-sensitive region is essentially the full thickness of the CCD. However, this is divided into a high field (depletion) thickness and a low-field (known as field free) thickness.

The depletion thickness of a semiconductor device is that part of the material that has been depleted of majority carriers due to the presence of an electric potential. The potential may be due to an applied bias, the presence of differently doped semiconductor material (i.e. a pn junction), the presence of an interface with a metal (Schottky diode) or a Metal Oxide Semiconductor structure (MOS device), or more often than not, a combination of the above. Since the depletion region is (by definition) that part of the device that supports the potential gradient (non-zero electric field), it is the part of a device capable of moving (or collecting) electrons quickly. Photon interactions within the depletion region liberate electrons which move quickly to the nearest potential maximum, usually within the same CCD pixel in which they were liberated.

The remaining, undepleted thickness of a CCD is referred to as the field-free region. Electrons liberated by photons incident in the field-free region are also collected (eventually). However, in the absence of a strong electric field, the electrons are also able to spread laterally due to diffusion. This means that electrons liberated by photon interactions in the field free region will often be collected by pixels other than the one in which the interaction took place. In high

energy, spectroscopic (photon counting) applications, many of these events would be rejected, which would constitute an overall loss of efficiency. For an integrating application such as Gaia, the efficiency is not affected as long as all electrons are collected within the relevant PSF. The sharing of electrons between pixels does however constitute a blurring of the image or a reduction in diffusion MTF.

The figure is a schematic representation of charge spreading in the depletion and field-free regions. t is the total device thickness, x_d is the depletion depth and x_{ff} is the field-free thickness.

Image courtesy of Alexander Short.

[\[High resolution version available\]](#)

[Published: 05/04/2004]

Picture of the Week

The Gaia Supercomputer



The Compaq AlphaServer HPC320 (pictured above), is made up of 8 nodes of 4 processors at 833 MHz each, interconnected with a Memory Channel II of 100MB/s, giving a total of 32 processors. This supercomputer has a peak performance of 53.31 Gigaflops. The machine is located at the Super Computing Centre of Catalunya (CESCA) in Barcelona and is being used to run the Gaia Simulator and the GDAAS (Gaia Data Access and Analysis Study) Project. This, however, is only a fraction of what Gaia is expected to need in order to complete the entire data analysis, which is estimated to be of the order of 100 million Teraflops.

Image courtesy of Yolanda Balagué Jordán.

[\[High resolution version available.\]](#)

[Published: 12/04/2004]

Picture of the Week

Designing the optics for the RVS

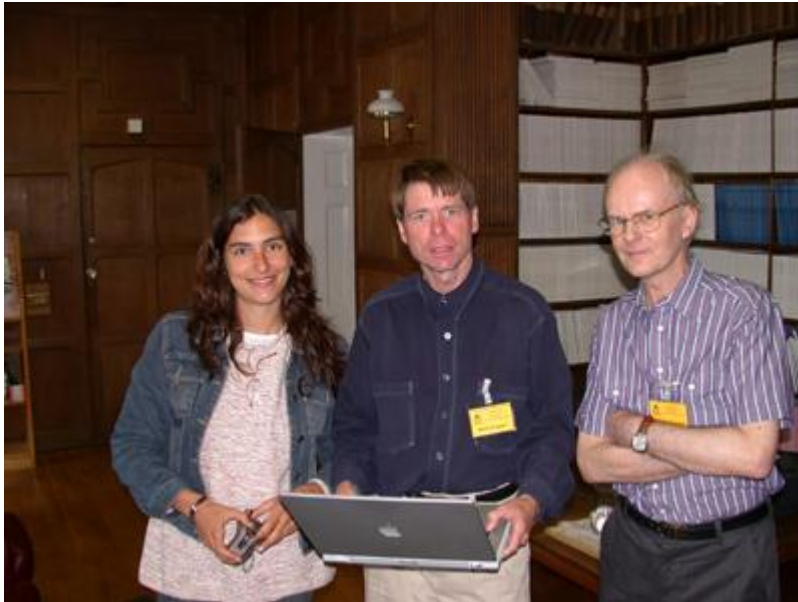

Fanny Chemla (Observatoire de Paris-Meudon), Mark Cropper (MSSL), and Richard Bingham (UCL London) are members of the RVS Consortium (led by Mark Cropper), involved in the optical design of the Radial Velocity Spectrograph on Gaia. Besides the normal attention that has to be paid to the image quality and spectral resolution in the instrument, the RVS optical design has particularly strong requirements on the control of the distortion, and the spatial variation of dispersion, over a large field of view.

(Since this photo was taken Fanny has moved to managing a research and development team involved in ground-based telescope projects and working on the development of high-tech components for astronomy. Sophie Thétas (also at Observatoire de Paris-Meudon) has taken over Fanny's RVS tasks.)

The RVS instrument study consortium web site is [here](#).

Photo courtesy of Michael Perryman.

[Published: 19/04/2004]

Picture of the Week

Gaia parameter database

The screenshot displays the Gaia Parameter Database web interface. The browser address bar shows the URL <http://gaia.esac.esa.int/gpdb/index.php>. The page title is "Gaia Parameter Database". The interface features a sidebar on the left with navigation links for "Versions" (currently showing "live (r.53378)"), "Access (ejoliet)" (with links for "Search (live)" and "Browse (live)"), "Documentation" (with links for "Basics", "Concepts", "User Manual", and "Glossary"), and "Request for" (with links for "New parameter" and "Change parameter"). The main content area is titled "Parameter search in live version" and contains a search form with various filters. The filters include: "Level-1 is:" (dropdown: "-Any-"), "and Level-2 is:" (dropdown: "-Any-"), "and Level-3 is:" (dropdown: "-Any-"), "and Level-4 is:" (dropdown: "-Any-"), "and Class name matches:" (text input), "and Kind is:" (dropdown: "-Any-"), "and Direction is:" (dropdown: "-Any-"), "and Case is:" (dropdown: "-Any-"), "and Status is:" (dropdown: "-Any-"), "and Parameter is:" (radio buttons: "all", "basic", "derived"), "and Parameter is:" (radio buttons: "all", "scalar", "multidimensional"), "and Description matches:" (text input), "and Source matches:" (text input), "and Parameter changed last:" (dropdown: "eternity", "ago"), and "and Unit matches:" (text input). At the bottom, there is a "Render output as:" dropdown set to "HTML" and "Search" and "Reset" buttons.

An important tool is now available to all scientific and industrial participants in the Gaia mission: the [Gaia Parameter Data Base](#). This is an ESA-supplied centralised, on-line, searchable repository of parameters pertaining to the mission and its different elements. It comprises a large variety (many hundreds) of entities ranging from simple scalar numerical constants to multi-dimensional data sets, subdivided into categories, and approved by the GST and relevant working groups.

For example, the "Nature" category contains the adopted values of fundamental physical and mathematical quantities, masses of objects in the solar system, the thermal expansion coefficient of SiC at the operational temperature, etc. The instrument category contains parameters like pixel sizes, QE/MTF, readout rates and readout noise of the CCDs, dimensions of the optics, satellite

spin rate, mirror reflectivities as a function of wavelength, etc.

The data base can be interrogated in two modes: (i) a browse mode when searching for a specific quantity or when a structural overview is sought; (ii) a search mode where a download of all parameter values, or all parameters in a specific category, can be requested. Query results can be returned in HTML (Web browser) format, or in formats suitable for usage with program source code in Fortran (77 or 90), Java, C, C++, or XML. Also, contents rendering to a number of other formats such as PDF is supported.

The goal of the Gaia Parameter Data Base is to have a controlled, up-to-date repository of all parameters (with naming convention) which can be adopted consistently across the project. Versioning control is implemented. The Simulation Working Group and telemetry modeling effort are already using the data base, and GDAAS will move to using it soon. We encourage all involved in Gaia to investigate and use this data base as the primary source for all parameter values. Users are strongly encouraged to report errors, inconsistencies, or omissions.

The data base is accessible on-line at <http://www.rssd.esa.int/Gaia/paramdb/>. Access is via My Portal. Any individual working on Gaia can request a username/password for My Portal from the [Gaia Help Desk](#).

The image above shows a screen shot of the search interface.

[Published: 26/04/2004]

Picture of the Week

Transverse velocity in a colour-magnitude diagram

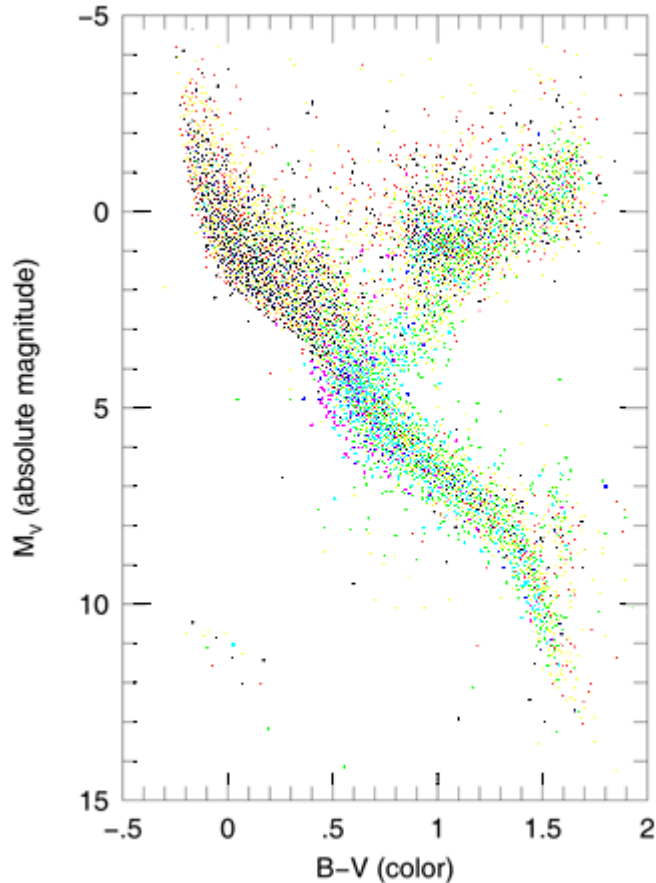

Colour-magnitude diagrams - in which the absolute magnitude (M_v) of a selection of stars is plotted against their colour ($B-V$) - are frequently used in determining fundamental properties of the stars, and are commonly used as a teaching tool for explaining stellar evolution.

In this latter context, Andrew Gould has created an [Hipparcos colour-magnitude diagram](#) (see above) that is colour-coded by transverse velocity, the latter derived from the Hipparcos proper motion measurements. The data are selected to ensure the inclusion of a good sample of luminous stars, a representative sample of local stars, and most of the halo stars observed by Hipparcos.

Colour-coding the data according to the transverse velocity of the stars reveals the connection between the photometric and kinematic properties of the local population. Younger stars, typically found early on the main sequence, tend to move slower than later main sequence stars,

which are mostly older. See [astro-ph/0403506](https://arxiv.org/abs/astro-ph/0403506) for a more thorough description of this figure and details on its interpretation. (A high-resolution image is also available there.)

Gaia's precise astrometric and photometric measurements for more than 1 billion stars in our Galaxy, and beyond, will result in improved constraints on models of stellar evolution.

Image courtesy of Andrew Gould.

[Published: 10/05/2004]

Picture of the Week

Gaia M1 mirror demonstrator after sintering

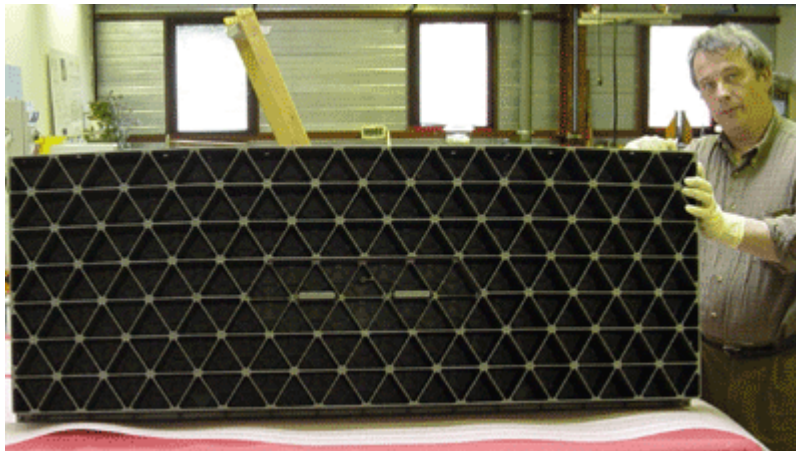

The two Gaia primary mirrors will each be 1.4 m x 0.5 m, constructed from Silicon Carbide, and will be the largest off-axis mirrors to be produced featuring such a large deviation from spherical shape.

A demonstrator model is currently under development led by [EADS Astrium](#), with the French company Boostec responsible for the mirror blank and the optical bench manufacturing.

In the image above Claude Thomas (Boostec) holds the Gaia M1 demonstrator after sintering at the [Boostec premises](#) in Tarbes, France. The back of the mirror is facing the viewer. The two thick horizontal struts are for mounting the mirror on its support structure.

The next stage is for the demonstrator model to be ground and polished to the required finish, and for the reflective coating to be applied. Finally, the model will undergo a series of space qualification tests.

Image courtesy of Michel Bougoin (Boostec).

[\[Larger image available\]](#)

[Published: 17/05/2004]

Picture of the Week

Take a trip through the Digital Universe

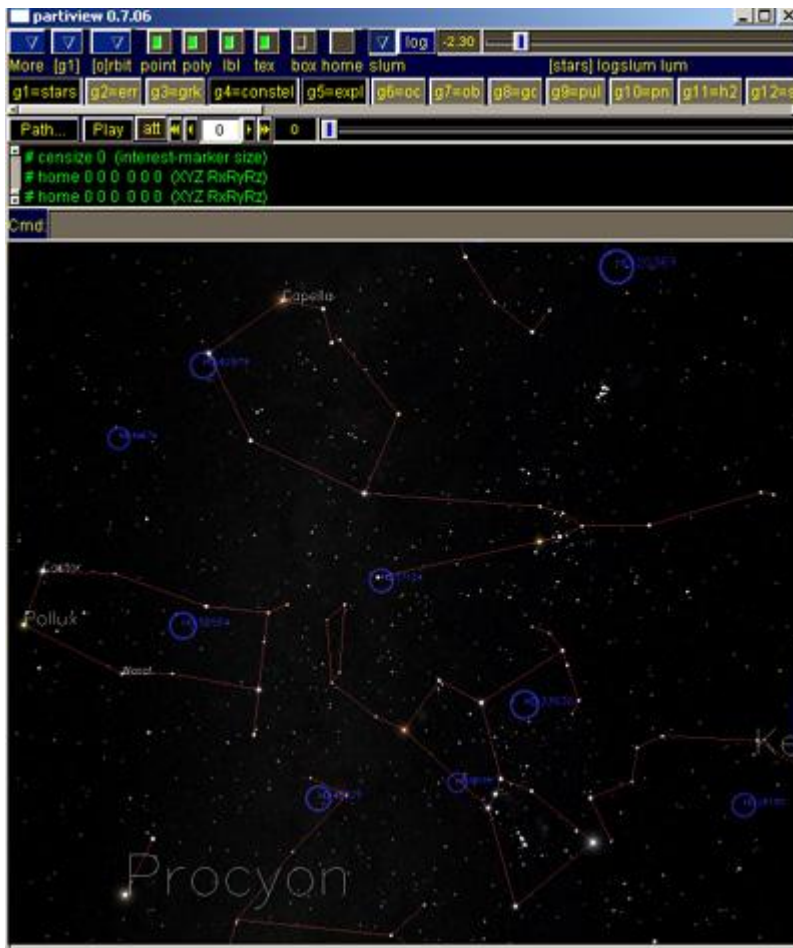

In the late 1990's, the American Museum of Natural History and the [Hayden Planetarium](#) embarked on the Digital Galaxy Project, the goal of which was to build the most accurate Milky Way Galaxy that had ever been built based on astronomical observations. Among the many catalogues included in the Digital Galaxy are the Hipparcos Catalogue and the Tycho 2 Catalogue. After a few years the project expanded to consider objects beyond the Milky Way and it is now known as the Digital Universe.

The Hayden Planetarium has made the Digital Universe available for free to individuals via the internet. By simply downloading the free software [Partiview](#) and the accompanying atlases a trip through three-dimensional space is available to anyone. (Partiview is an interactive visualization software developed by Stuart Levy and the Virtual Director Group at the National Center for Supercomputing Applications. The software is available for Windows, Mac OSX, Linux and IRIX platforms.)

The image above is extracted from Partiview and shows a view from Earth towards Orion. Stars with planetary systems are indicated by a blue circle. Partiview allows users to "fly" through the Galaxy and to view the objects from any perspective.

For more information about the scientific and technological advances that led to the creation of the Digital Universe atlas at the American Museum of Natural History and Hayden Planetarium see the online article on [Virtual Universe](#) from [Natural History Magazine](#).

Image from Partiview.

[Published: 24/05/2004]

Picture of the Week

Spectralib - synthetic spectra database

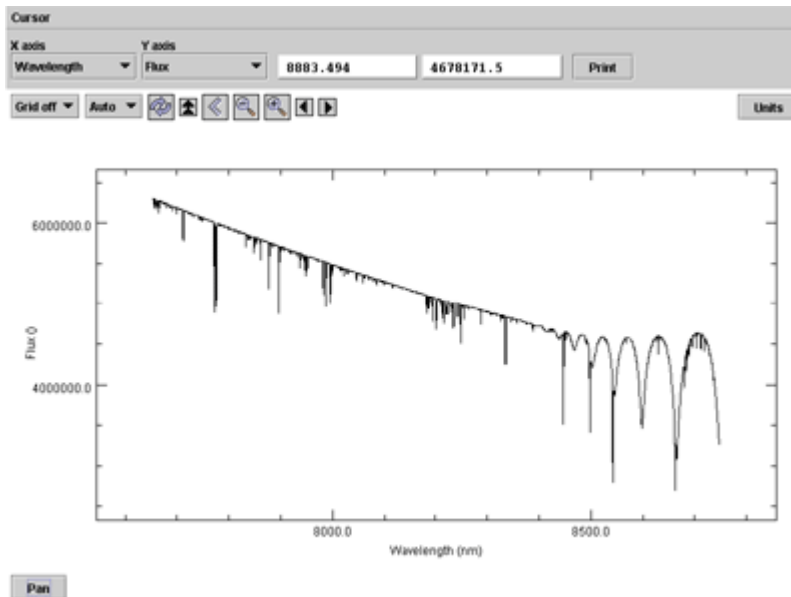

A library of 183588 synthetic spectra, based on Kurucz's ATLAS9 models, is now available online with the [spectralib](#) tool. The library covers the wavelength range and resolution of [RAVE](#) and Gaia. These synthetic spectra may be used as templates for determining radial velocities, and for deriving the primary parameters of stellar atmospheres (temperature, metallicity, gravity and rotational velocity).

Spectralib allows the user to select from a grid of spectra characterised by:

- Effective temperature: 3500K to 47500K
- Gravity ($\log g$): 0.0 to 5.0
- Metallicity: -3.0 to +0.5
- Rotational velocity: 0 to 500 km/s
- Microturbulent velocity: 0 to 4 km/s

The grid is calculated for resolving powers of 8500, 11500 and 20000. Spectra can be downloaded in FITS format, or displayed directly in the user's web browser.

More information about the spectra database can be found in ["An extensive library of synthetic spectra covering the far red, RAVE and Gaia wavelength ranges"](#) by Tomaz Zwitter, Fiorella Castelli and Ulisse Munari (Astronomy and Astrophysics, v.417, p.1055-1062 (2004))

[Published: 31/05/2004]

Picture of the Week

Star tracking in Astro

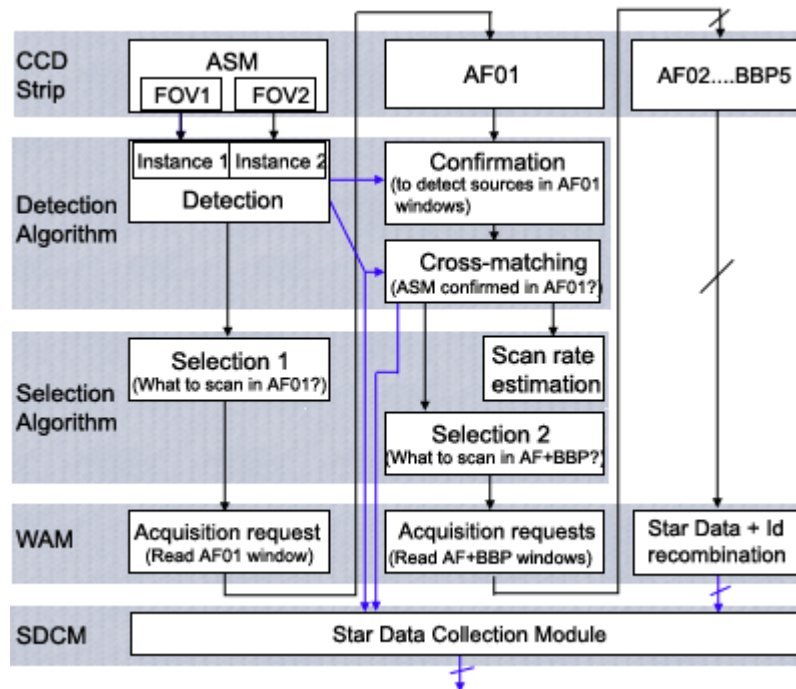

One of the many challenges of the Gaia mission will be to optimise the registration of celestial objects as they cross the field of view of the different instruments. The scientific algorithms employed onboard Gaia will have to cater for a range of conditions: detection, confirmation, selection and tracking of objects, sky background determination, classification of objects, and detection of Solar System objects by cross-matching. In addition, these algorithms play an important role in estimating the resources required onboard for the Payload Data Handling System.

Development of the detection and selection algorithms is one of the main tasks occupying the [On-board Detection Working Group](#) at present. The most recent release of the developed algorithms are packaged in version 2 of Pyxis, the software package developed for data processing onboard Gaia. (More details available in "[Pyxis V2](#)", by F. Arenou, C. Babusiaux, F. Chéreau, S. Mignot, (OBD-CoCo-08), available in Livelink.)

The general sequence of events in on-board detection is illustrated in the schematic diagram above which shows the process of detection, confirmation, selection, and measurement of a star entering the Astro focal plane. The three main tasks in the measurement of a source are displayed as three columns: detection, selection and measurement. Solid black lines indicate the sequence of steps to follow, while the blue lines indicate the data that is retained. (This image, and further details, from "A high-performance Payload Data Handling System for Gaia", by J. Portell, X.

Luri and E. García-Berro (submitted to IEEE.)

See also the information sheet on [On-board data handling](#).

Image courtesy of Jordi Portell i de Mora.

[Published: 07/06/2004]

Picture of the Week

Artist's impression of the Gaia spacecraft

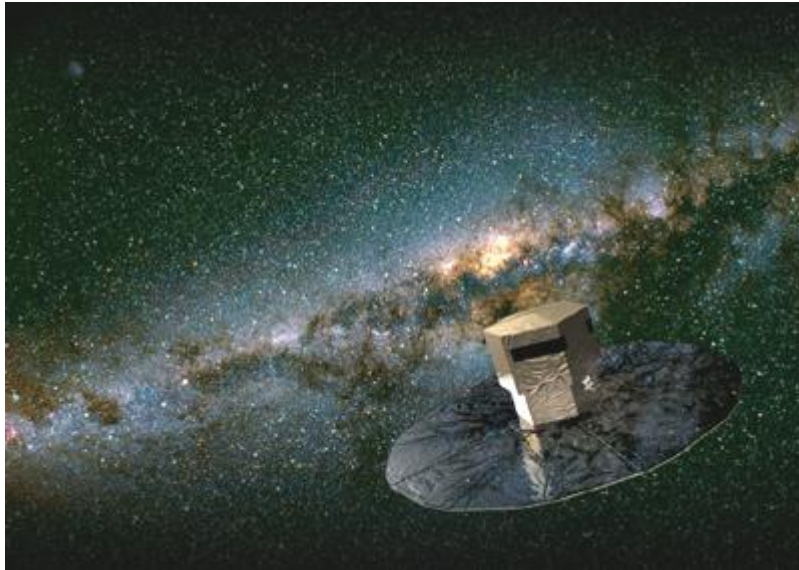

Although the design for the Gaia spacecraft is not yet final, some distinguishing features are already apparent. The spacecraft will require a circular sunshield to protect the instruments from sunlight; the two Astro instruments will have separate viewing directions; the payload and service modules will be on the same side of the sunshield.

This artist's impression illustrates these gross features of the Gaia spacecraft.

[\[High resolution version available: tif \(35Mb\) or jpg \(3.5M\)\]](#)

Image credit: ESA. Illustration by Medialab.

[Published: 14/06/2004]

Picture of the Week

Back-illuminated Gaia CCDs being evaluated

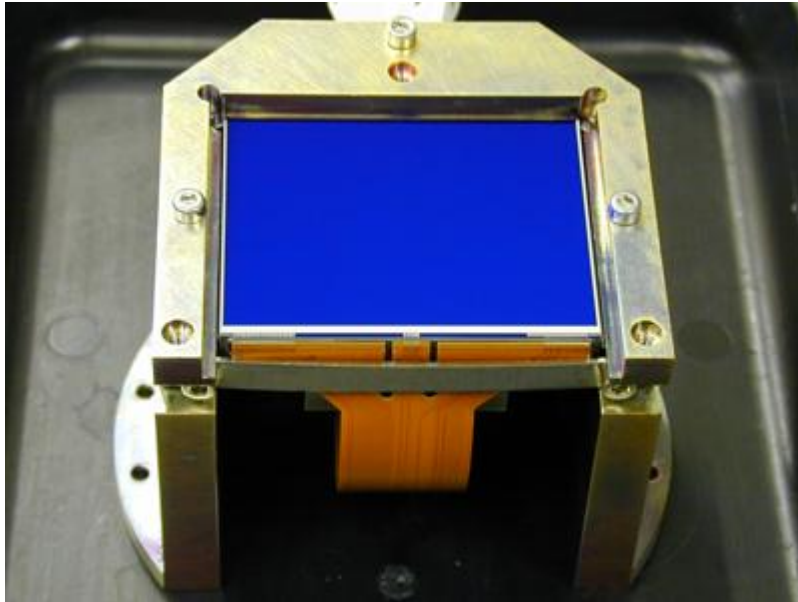

The first full-sized back-illuminated Gaia demonstrator CCDs have been produced by e2v technologies. Tailored to meet the demanding requirements of the mission, the devices incorporate a number of interesting features. They are designed for maximum efficiency when detecting faint stars, but they must also be able to handle very bright objects. For this reason, an anti-blooming drain has been included as well as TDI gates which effectively reduce the integration time if a bright object crosses the CCD. At 4.5cm by 6cm they are among the largest scientific CCDs ever manufactured and they will need to be produced in un-precedented numbers for the flight programme.

This image shows a back-illuminated Gaia AF demonstrator CCD complete with flex circuit in a custom handling jig. These jigs provide mechanical support and have a removable cover and a built-in shorting block for protection. They are vacuum compatible and include an integral temperature sensor so that the CCD can remain in the jig throughout testing at e2v.

The release of the first demonstrator CCDs marks an important milestone in the project. Approximately 32 demonstrator devices will be delivered over the next 8 months and will be used by EADS Astrium and Sira Electro-Optics for performance evaluation and radiation testing respectively. The results of this work will lead to refined performance predictions and an optimized design for the Gaia flight instrument.

Photo courtesy of [e2v technologies](http://www.e2vtechnologies.com).

[\[High resolution image available\]](#)

[Published: 21/06/2004]

Picture of the Week

Picture of the week - the first year

The Gaia Picture of the week feature has been running for 12 months. During that time we have presented a range of images ranging from artist's impressions to real instrumentation, from simulations to analysis of real data. Below is a summary of the first year of Picture of the week in chronological order. [Suggestions for inclusion](#) in the picture of the week are welcome from anyone associated with Gaia.



[Soyuz launchers](#)

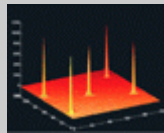

[CCD centroiding](#)



[SiC facilities](#)



[Monte Rosa I](#)



[NEO1994 XM1](#)

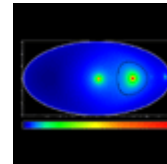

[Light bending](#)



[ESOC](#)



[Hipparcos](#)

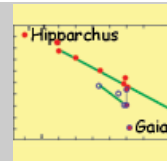

[Catalogues](#)



[HD70642](#)



[EADS-Astrium](#)



[Monte Rosa II](#)

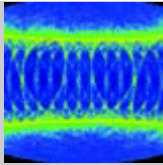

[All-sky transits](#)

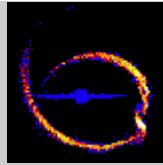

[Cannibal galaxy](#)



[First Gaia CCDs](#)

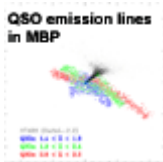

[Quasars](#)

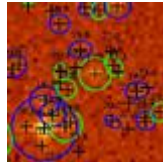

[Baade's window](#)



[ESTEC](#)

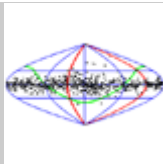

[RVS calibration](#)



[Optics test bench](#)

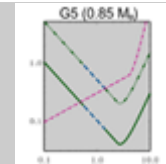

[Planet discovery](#)

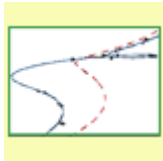

[Microlensing](#)

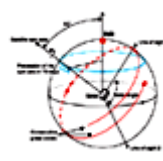

[Scanning law](#)



[Nice meeting](#)

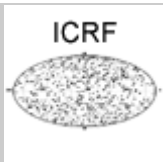

[The ICRF](#)



[Lund Map](#)

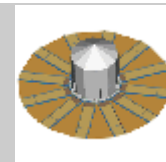

[Sunshield](#)

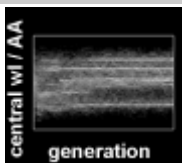

[Filter Design](#)



[Halo accretion](#)

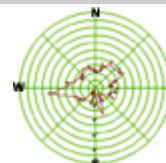

[GS visibility](#)

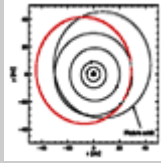

[KBO's](#)

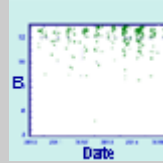

[Giant planets](#)

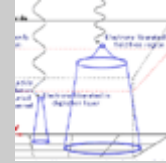

[CCD depletion](#)



[Supercomputer](#)



[RVS optics design](#)



[Parameter database](#)

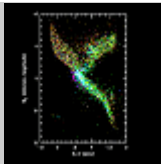

[v t CMD](#)



[Gaia M1 mirror](#)



[Digital Universe](#)

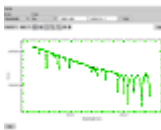

[Spectralib](#)



[Star tracking](#)



[Artistic spacecraft](#)

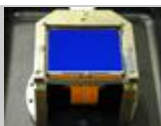

[CCD evaluation](#)

Picture of the Week

Gaia 2004: The Three-Dimensional Universe



The magnificent Observatoire de Paris - Meudon will play host to a Gaia symposium to be held 4-7 October 2004. The Observatoire, located on three sites: Paris, Meudon and Nançay, is the largest astronomy centre in France and one of the most important in the world. It has a long history of association with ESA's space astrometry missions, Hipparcos and Gaia, through its active research departments.

Since mid-2002, when Gaia was confirmed as a flagship of ESA's Science Programme, many in-depth studies have been initiated dealing with a variety of scientific and technical aspects of the project. By end 2004 these studies should provide full confidence in the feasibility of the Gaia project, and detailed understanding and control of all critical technologies required to build and operate the mission, and analyse its data.

The goal of the Gaia symposium is to present the final design of the Gaia mission and its performances, to update the science case, and to organise the next phase of scientific preparation of the mission. Young scientists from ESA Member States who are interested in becoming involved in Gaia are particularly encouraged to register.

For more details visit the [Gaia 2004 web site](#).

Image courtesy of Julia Kostelnyk (from an original painting)

[Published: 23/08/2004]

Picture of the Week

CCD metrology and alignment at Astrium

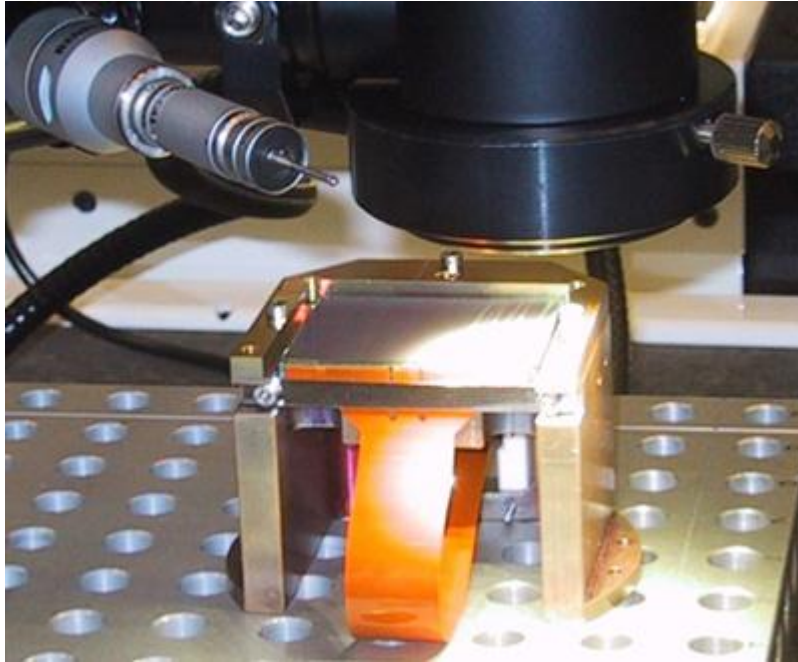

The Gaia CCDs and focal plane assemblies present some of the most challenging technical aspects of the Gaia satellite. The astrometric focal plane will contain 170 CCDs which need to be positioned and aligned with $\pm 20\mu\text{m}$ in-plane precision.

The "*Gaia CCD and Focal Plane demonstrator programme*" led by EADS Astrium (Toulouse) will demonstrate the technical feasibility of CCD and Focal Plane designs as well as techniques for integrating and testing them. Earlier this summer, as part of this programme, EADS Astrium completed commissioning of a purpose built CCD alignment measurement facility.

The image above shows a demonstrator CCD undergoing metrology checks at the pixel level during test facility commissioning under the dedicated 3D optical microscope. This is the first step in the focal plane alignment process. For this purpose, the CCD is still mounted in its custom made handling jig.

Learn more about EADS-Astrium at their [web site](#).

Image courtesy of Anouk Laborie (EADS Astrium).
(Image copyright: EADS Astrium)

[\[High resolution image available\]](#)

[Published: 30/08/2004]

Picture of the Week

Cryogenic testing of L3CCDs

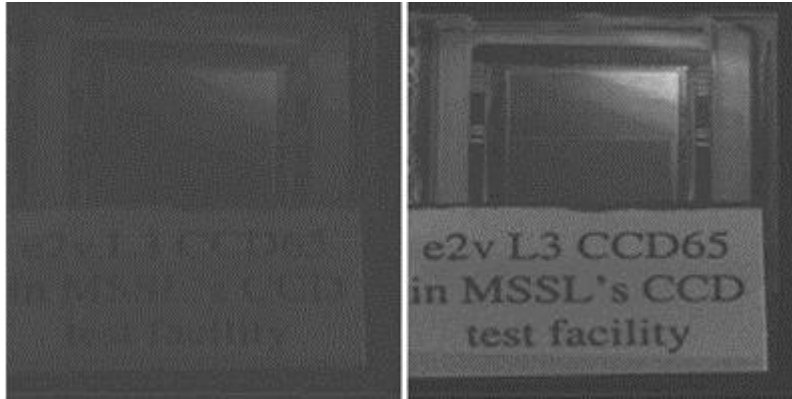

Low-light-level (L3) CCDs have been baselined for the RVS instrument on Gaia in order to reduce to a minimum the readout noise from each of the 10 CCDs in the focal plane in the scan direction. While L3CCDs have been used in many terrestrial applications they have not yet been used in space. A suite of tests will be performed at Brunel and MSSL with a view to characterising the performance of these CCDs under Gaia operating conditions.

These images of an L3CCD65 (left image: gain=1; right image: gain=7 as used in the RVS) were taken using another L3CCD65 during recent tests in which the devices, supplied by e2v technologies, were subjected to a series of experiments to investigate their performance at the proposed Gaia RVS operating temperature of 160K. Tests on their gain as a function of temperature, low-light-level imaging and charge transfer tests were performed using the MSSL CCD test facility. These tests have shown that these L3CCDs operate successfully at the low temperature required for Gaia. Further investigations will be performed in order to optimise their performance.

More information about the RVS Consortium can be found on their [web site](#).

Image courtesy Dave Walton, MSSL.

[Published: 20/09/2004]

Picture of the Week

QSOs for the best reference frame

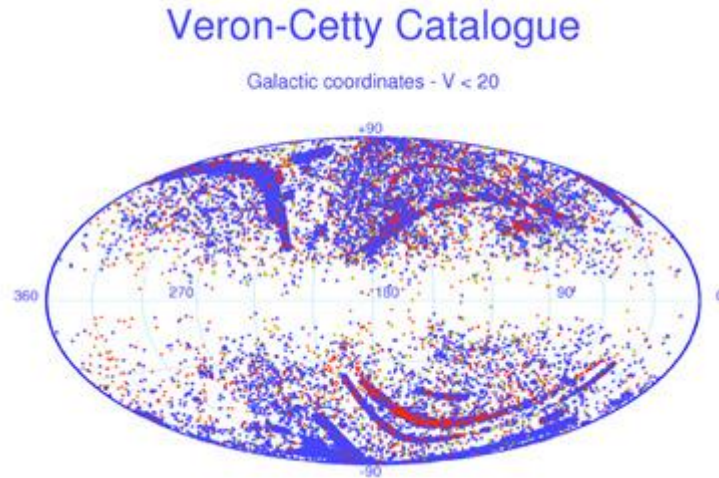

Distribution in galactic coordinates of the ~ 42000 known extragalactic sources brighter than $V = 20$ (from the 11th ed. of the Véron-Cetty and Véron Catalogue). The blue dots represent the quasars, the red stand for the AGN (Active Galactic Nuclei) and the few green ones are for the BL Lac objects. The area around the galactic plane is difficult to survey in the visible due to stellar crowding and interstellar absorption.

Gaia will observe about 10 ten times more objects, with somewhat similar, but less pronounced, filtering in the vicinity of the galactic plane. A subset of these sources will be used to realise the best reference frame ever created. An important and difficult work is on-going at the University of Liège(*) to design an automatic procedure to distinguish the QSOs from the (~ 1000 times more numerous) stars.

(*)This work is led by Alain Smette and Jean-François Claeskens, with contributions from Jean Surdej, Pierre Royer and Luc Vandenbulke.

Image courtesy of F. Mignard.

[\[High resolution version available\]](#)

[Published: 11/10/2004]

Picture of the Week

The scanning law for Gaia

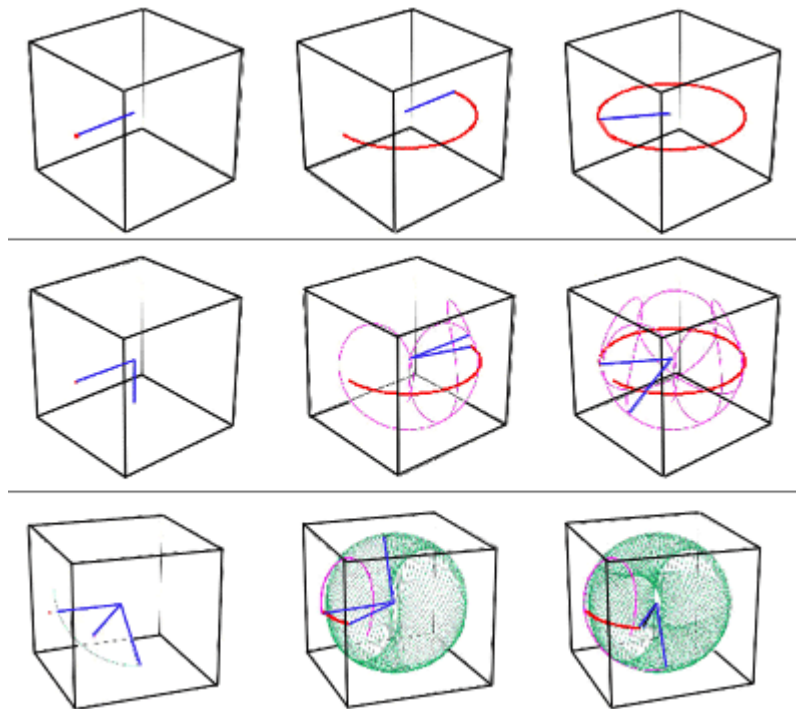

Three animations illustrating the scanning law envisioned for Gaia have been created. Each animation shows the celestial sphere as viewed from the "outside". Gaia is at the centre of the box, which just encloses the celestial sphere. *(The image above shows extracts from the animations - the original animations (in mpg format) can be viewed by following the links below.)*

The first animation ([mpg \(1.3M\)](#)) shows, in red, the path of the Sun in one year. The blue line is the vector from Gaia towards the Sun.

The second animation ([mpg \(2.3M\)](#)) shows the motion of the Sun as before, but also (in purple) the path of the spin axis of Gaia. The spin axis is always 50 degrees away from the Sun and moves in a circle about the Sun. If the Sun had remained fixed on the sky, the spin axis would have traced a cone around the solar direction. But because of the Sun's motion, the resulting path of the spin axis is a series of loops on the sky. Each loop takes about 70 days.

The third animation ([mpg \(5.4M\)](#)) shows, in addition to the Sun and the spin axis, the path of one of the Astro fields (in green). Only the first two months of the scanning is shown, and the spin of the satellite is shown with only one revolution per day (instead of four rev/day, as will be used for Gaia). Already after two months a large fraction of the sky is covered with scans that cross each other in different directions. After six months, the whole sky gets at least a three-fold

coverage. Gaia is designed to scan the sky in this manner for at least five years, after which every point has been thoroughly criss-crossed, which allows to measure the positions, motions and parallaxes of the stars.

Animations courtesy L. Lindegren

[Published: 25/10/2004]

Picture of the Week

Proximity electronics module



The image above shows the first of the proximity electronics modules (PEM) constructed by EADS Astrium for the Gaia CCD & Focal Plane Demonstrator programme. The dimensions of the model are approximately 120mm by 50mm by 30mm.

The PEMs are the focal plane electronics modules: they feature the CCD biases, generate the clocks, and perform CCD video signal digitisation. Fourteen PEM demonstrators of this type have been built during this phase of the programme. They have successfully passed the acceptance tests prior to integration in the focal plane demonstrators. In the foreseen flight

configuration, approximately 170 PEMs (one per CCD) will be needed for the final Gaia payload.

Image courtesy of Anouk Laborie (EADS Astrium).
(Image copyright: EADS Astrium)

[\[High resolution image available\]](#)

[Published: 08/11/2004]

Picture of the Week

Interconnection module

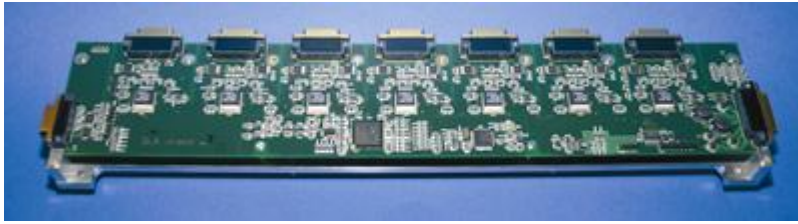

This image shows the Interconnection Module demonstrator (IM DM) board constructed by DLR for EADS Astrium (for the Astro Focal Plane demonstrator which is built by EADS Astrium as part of the Gaia CCD & Focal Plane Demonstrator programme). The dimensions of this module are approximately 400mm by 80mm by 50mm. Two demonstrators of this type have been constructed during this phase of the programme.

In the flight configuration, the Interconnection Modules manage the interfaces between the Proximity Electronics Modules (one for each of the CCDs) and the Video Processing Units which perform the video data processing. The IMs are also responsible for the clocks and power supply distribution. Ten Interconnection Modules (one per row of CCDs) will be needed for the final Gaia payload.

Image courtesy DLR.
(Image copyright: DLR)

[\[High resolution image available\]](#)

[Published: 22/11/2004]

Picture of the Week

Focal Plane Assembly Baseplate

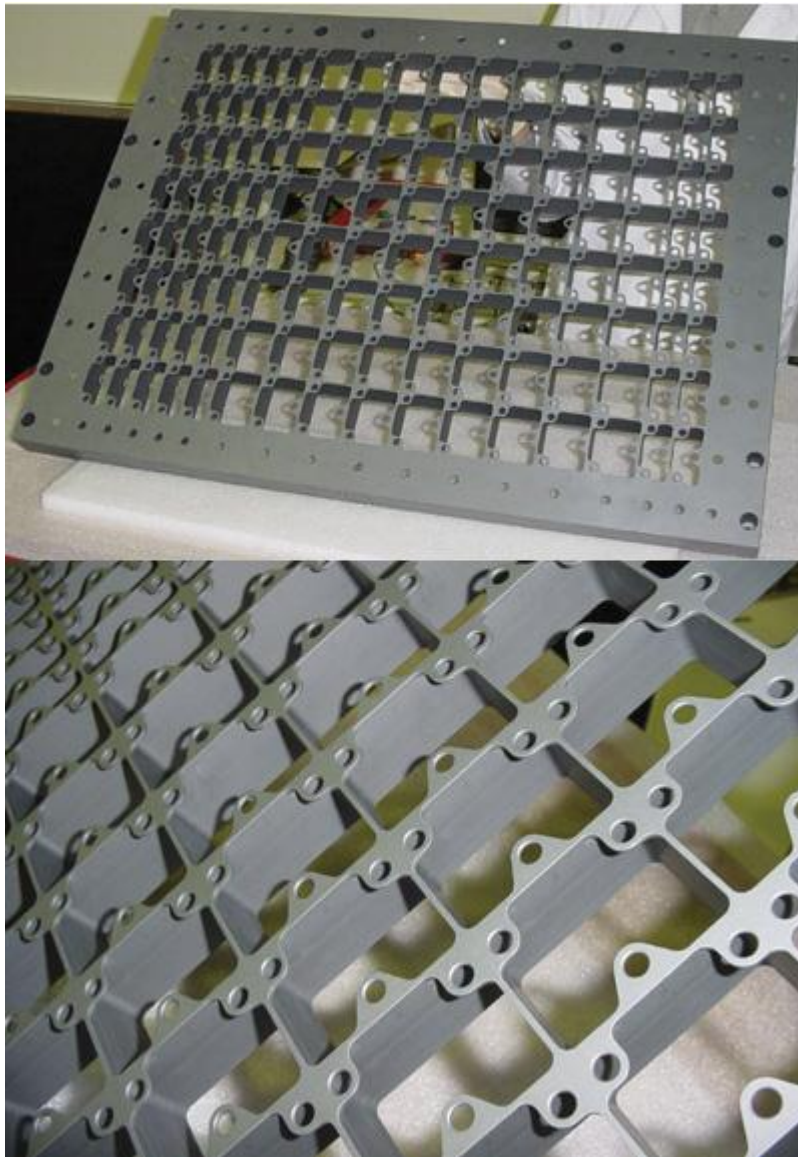

The top image shows the SiC Focal Plane Assembly Baseplate for the Gaia CCD & FPA Demonstrator programme. The dimensions of this model are approximately 770mm by 580mm by 36mm, with a mass of about 8kg. (This is not a full-scale model - it is built for validation purposes.) The 'slots' for the different types of CCDs are clearly visible: (from right to left) 2x8 sky mapper CCDs, 9x8 astrometric field CCDs, 5x8 broad-band photometry CCDs. (The foreseen flight CCD layout will differ from this one.) The bottom image shows the CCD slots in finer detail.

Images courtesy Anouk Laborie (EADS Astrium).
(Images copyright: EADS Astrium & Boostec)

[\[High resolution image available - complete baseplate\]](#)

[\[High resolution image available - detail of baseplate\]](#)

[Published: 06/12/2004]

Picture of the Week

Astro CCD characterisation tests at EADS Astrium

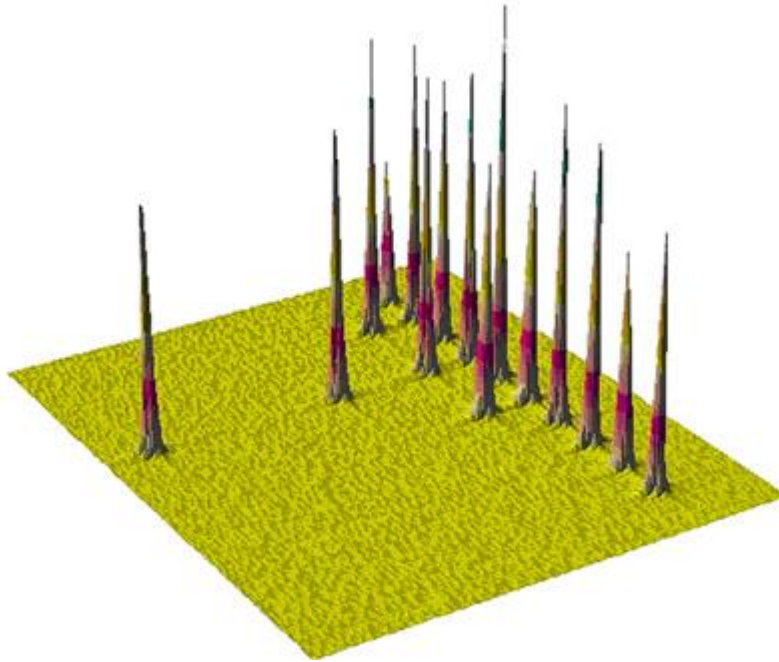

As part of the "Gaia CCD and Focal Plane Technology Demonstrators" programme, EADS Astrium (Toulouse) have developed an in-house test bench dedicated to the "CCD characterisation test campaign". This campaign aims at testing the specific functions of the Gaia AF CCD (4500 TDI stages with 10 μm pitch pixels) and performing centroiding measurements in Gaia-like operating conditions. The Tests Review Board, which concluded the test campaign on the back-illuminated CCD version, was successfully held early October 2004.

The characterisation tests were performed at the Gaia operating temperature (165 K) with the CCD clocked in Gaia TDI mode. The EADS Astrium test facility is equipped with a moving optical source which can be used to simulate stars moving across the CCDs just as they will in Gaia's observing mode. The centroiding test results are very encouraging and close to the theoretical limit (Cramer-Rao bound):

- 0.0026 pixel rms error (corresponding to 26 nm) for a 12.9 equivalent G2V star magnitude
- 0.0062 pixel rms error (corresponding to 62 nm) for a 15 equivalent G2V star magnitude

The image above is of a dense stellar scene acquired by the Gaia AF CCD operated in representative TDI mode. A specific optical mask is used to simulate the star field, resulting in this pattern.

Image courtesy of Anouk Laborie (EADS Astrium).
(Image copyright EADS Astrium.)

[Published: 20/12/2004]

2005

12/19: GAREX
◄ 11/14: Variable stars
◄ 10/24: Ice Age Epoch
◄ 10/03: Asteroid orbits, J2, β
◄ 09/05: Milky Way bar
◄ 08/22: Detecting MBOs & NEOs
◄ 08/08: RGO 1995
◄ 07/25: Galaxy remnants
◄ 06/27: Cebreros
◄ 06/13: EODM testing
◄ 05/30: Bulge visibility
◄ 05/09: First Look: ODIS
◄ 04/25: Radiation testing
◄ 04/04: CCD Packaging
◄ 03/21: Gaia imaging
◄ 03/07: Working Groups
◄ 02/21: Gaia logo
◄ 02/14: MBP devices
◄ 01/31: Proton irradiation
◄ 01/24: Asteroids
◄ 01/17: MBP filters
◄ 01/10: BBP filters

Picture of the Week

Gaia Broad-Band Photometry Filters

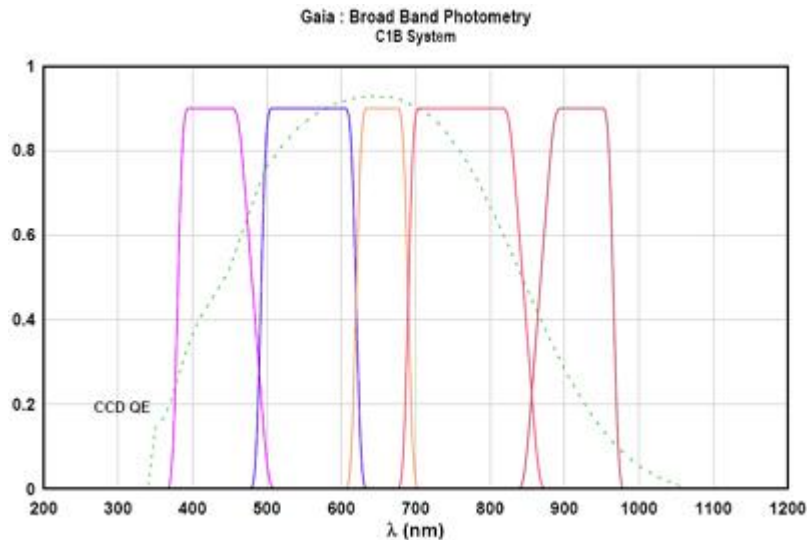

The Photometry Working Group (PWG) has recommended the C1B system as the baseline broad-band photometry system for Gaia. This follows detailed studies of various proposed systems and evaluation of their performance in characterizing the scientific targets.

In optimising the design of the Gaia photometric system (the broad-band filters on the four strips of Astro CCDs assigned to broad-band photometry, and the medium-band filters on 16 Spectro CCDs), the PWG defined a set of scientific targets (single stars belonging to the galactic halo, thin and thick discs, and the bulge) for which the photometric system should be optimum. These targets are selected so as to ensure the scientific goals of the mission, and the photometric system should allow for the determination of the astrophysical parameters of stars from all subsets of the galactic population.

The figure above shows the selected baseline filter system for Gaia's broad-band photometry (C1B renamed from F4B). There are 5 filters; two of these will share a CCD strip. The filters cover the same wavelength range as the astrometric measurement, which is a requirement for the chromaticity correction.

For further information about the different proposals and the selection of the BBP filter system see *BBP photometric systems evaluation*, UB-PWG-028, Jordi et al. 2004 ([in Livelink](#)) and references therein. See also the [Photometry Working Group web site](#) (under PS Optimization).

Image courtesy François Mignard.

[\[High resolution image available\]](#) [Published: 10/01/2005]

Picture of the Week

Gaia Medium-Band Photometry Filters

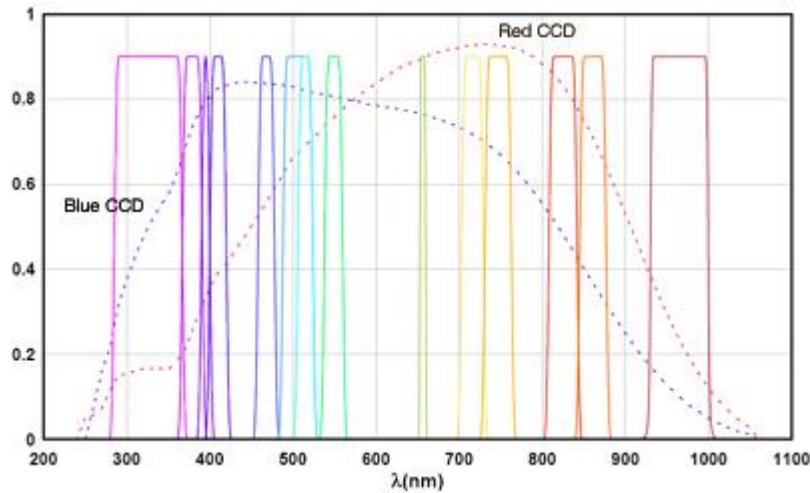

The Photometry Working Group (PWG) has recommended the C1M system as the baseline medium-band photometry system for Gaia. This follows detailed studies of various proposed systems and evaluation of their performance in characterizing the scientific targets (see also [Picture of the Week, 2005-01-10](#)).

In selecting the C1M system (renamed from S5M) the PWG took account of the main astrophysical parameters to characterize the stellar galactic populations (chemical abundances and ages). The MBP data will have a lower angular resolution than the BBP and, for non-crowded regions, will be combined with the C1B BBP data for estimating astrophysical parameters.

The figure above shows the selected baseline filter system for Gaia's medium-band photometry (C1M). The C1M system has 8 blue and 6 red bands; one of the red bands will cover the same spectral region as the Radial Velocity Spectrometer.

Further information about the selection of the MBP filter system, including specific details of this system and other proposals, are available in *MBP photometric systems evaluation*, UB-PWG-029, Jordi et al. 2004 ([in Livelink](#)) and references therein. See also the [Photometry Working Group web site](#) (under PS Optimization).

Image courtesy François Mignard.

[\[High resolution image available\]](#)

[Published: 17/01/2005]

Picture of the Week

Detecting asteroids with Gaia: when is best?

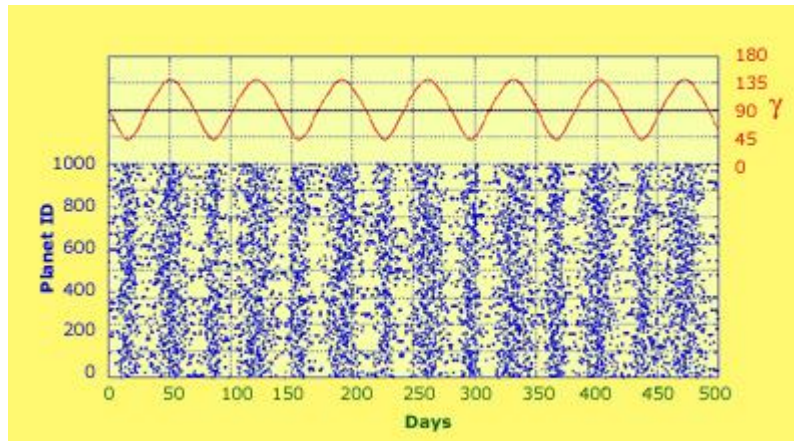

The lower panel of the plot shows the crossing of the astrometric fields by the asteroids as a function of time, in this case for 500 days. Each asteroid is represented in the ordinate by its ID number: Ceres is 1, Pallas 2, and so on. The dots are plotted for each time the planet crosses one of the astrometric fields. For each object one has typically 20 observations over the 500 days. The surprising striped pattern (a uniform coverage was initially expected) results from the way the sky is scanned with Gaia.

Most of the asteroids are observed in the vicinity of the ecliptic, say within ± 30 degrees from the ecliptic plane. During the mission the inclination of the instantaneous scan circle on the ecliptic varies between 40 to 130 degrees as Gaia's spin axis precesses on the Sun-centred cone.

When the inclination is close to 90 degrees, the plane is normal to the ecliptic and over one revolution (6 hours), only a couple of hours of observing time is spent in the ecliptic region, where asteroids can be detected. This fraction increases as the inclination of the scan circle gets smaller, and the number of asteroids observed per unit of time increases. The inclination is plotted in the upper panel showing that the correlation is perfect. The period of the precession motion being 70 days, the high and low detection rates alternate every 35 days.

One can also see that the vertical strips on the lower plot are narrow when $i = 40$ deg and wide when $i = 140$ deg. This feature is also related to the scanning circle and follows from the fact that the precession rate on the Sun-centred cone is not uniform: at large inclination one must slow down the motion to compensate for the solar motion in the same direction, and the scanning law does just the opposite at $i = 40$ deg. Hence the low inclination season is shorter than that at large inclination giving, in this case, more time to detect asteroids.

Image courtesy François Mignard.

[\[High resolution version available - pdf\]](#)

[\[High resolution version available - eps\]](#)

[Published: 24/01/2005]

Picture of the Week

L3CCDs for proton irradiation



Continuing the work carried out to investigate the effects of protons on the operational characteristics of L3CCDs, a batch of 100 CCD97s, plus a few control devices, have been delivered from [e2v technologies](#) to [Brunel University](#). Low-Light-Level (L3) CCDs have been baselined for the RVS instrument on Gaia and proton irradiation of L3 devices allows for the characterisation of the effects of radiation damage.

To date, L3 proton irradiations have been conducted on CCD65 devices, irradiating initially to a 10 MeV equivalent proton fluence of 2.5×10^9 protons cm^{-2} , then subsequently to a 10 MeV equivalent fluence of 2.1×10^{10} protons cm^{-2} , approximately 10 times the RVS 6 year expected mission fluence. In all cases the irradiated devices were operational after irradiation and behaved as expected, with dark current levels and bright pixel generation comparable to those in proton irradiated non-L3 devices.

The irradiation of 100 CCD97s will improve the radiation damage statistics further, defining confidence limits for the survivability of L3 devices in the space radiation environment for Gaia and other missions proposed in the future.

Photo courtesy of David Ryan Smith.

[Published: 31/01/2005]

Picture of the Week

Gaia MBP devices

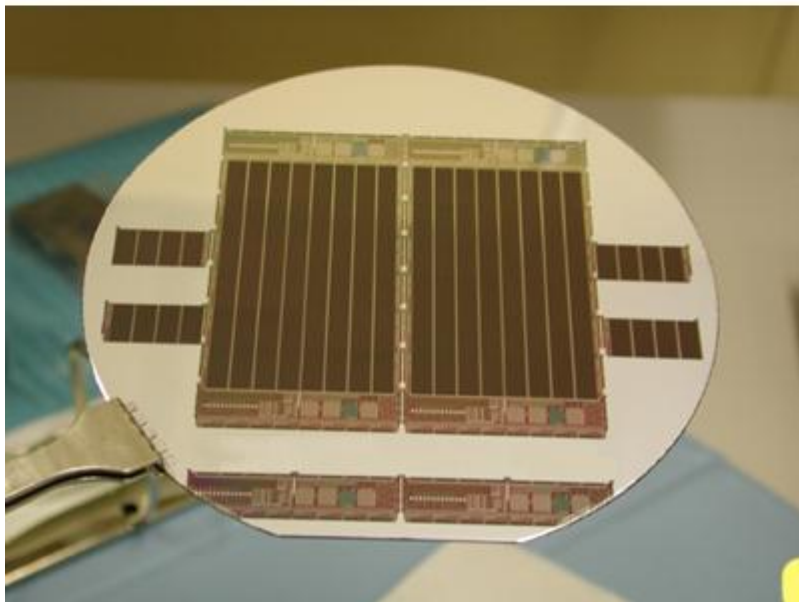
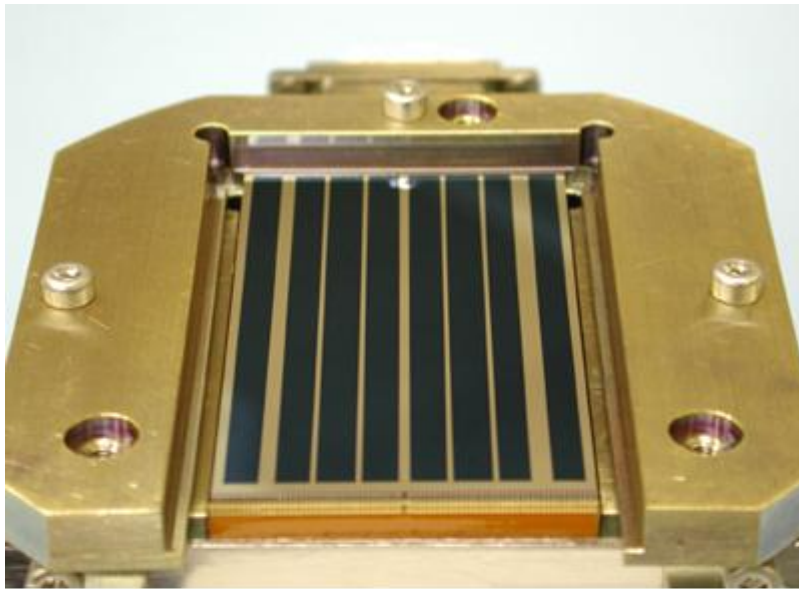

The Medium-Band Photometer (MBP), which along with the Radial Velocity Spectrometer forms Gaia's Spectro instrument, will provide high-quality, multi-band photometry for each of the objects observed by Gaia. This photometric data will yield temperatures, gravity, metallicities and reddening values - essential diagnostics for determining the astrophysical nature of these objects.

The MBP devices have been manufactured by e2v technologies under contract to EADS

ASTRIUM SAS as part of the ESA "Gaia CCD and Focal Plane Technology Demonstrators" programme. The devices have been back thinned and the dies have been mounted on Silicon Carbide packages made by Boostec S.A. Detailed testing of the devices is planned to start in 2005.

The upper image is of an MBP device in a test harness. The CCD strips are of different widths for testing purposes - different widths correspond to different integration lengths. The lower image shows an MBP device (2 modules of 8 CCDs) on a wafer (diameter approximately 12.5 cm).

Images courtesy of [e2v technologies](#).
(Images copyright [e2v technologies](#))

[\[High resolution image available - MBP in test harness\]](#)
[\[High resolution image available - MBP CCDs on wafer\]](#)

[Published: 14/02/2005]

Picture of the Week

ESA's mission logo for Gaia

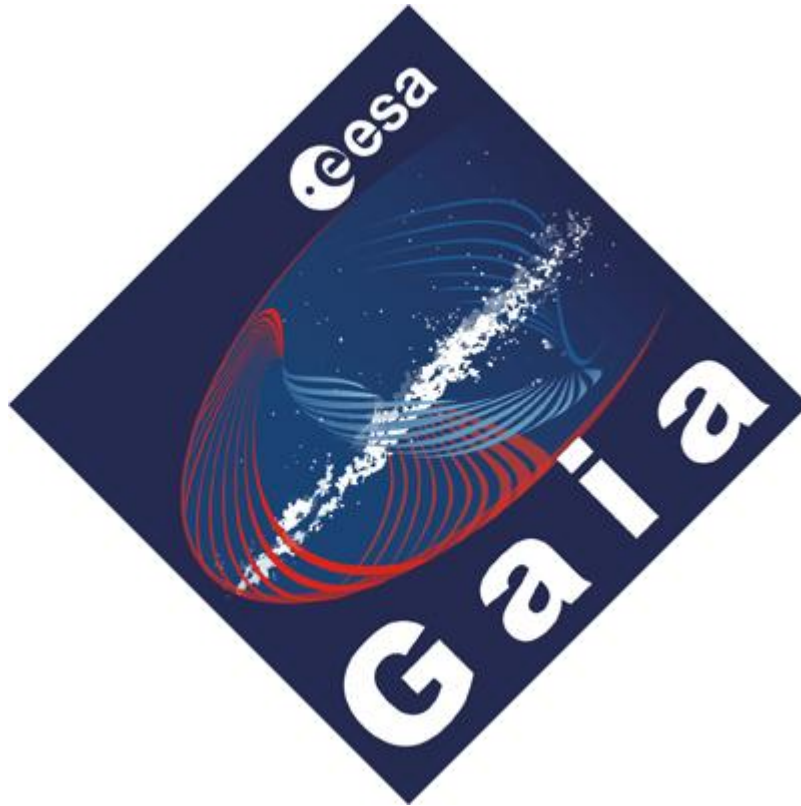

The newly available Gaia mission logo depicts an abstract representation of the Gaia scanning law superimposed on a graphic of the Milky Way. The logo was prepared by the Science Programme Communication Service using artwork commissioned from graphic illustrator Alex Kok.

The Gaia logo is available in several formats (jpg, gif, eps, tiff) and can be downloaded as a compressed tar file, or as a zipped file, from [here](#).

We encourage the use of this logo in Gaia-related work, e.g. technical reports, scientific posters and presentations. For use of the logo in other circumstances e.g. books or commercial products, please contact the [Gaia helpdesk](#).

[Published: 21/02/2005]

Picture of the Week

Gaia Working Groups



The scientific community supporting Gaia is organised into working groups with responsibility for studying the impact of the Gaia mission on particular areas on science. The working groups are composed of core and associate members and are guided by a leader (and co-leader). Most working groups meet a few times times per year to discuss results of on-going or completed studies, assign new studies to individuals or groups, and to provide feedback via the Working Group leader to the Gaia Science Team and to ESA. Reports and technical notes prepared by the Working Groups are available on their web sites and in the [Gaia scientific document archive \(Livelihood\)](#). Individuals who wish to participate in Working Group meetings should contact the Working Group leader. Details of meetings are maintained on the central [Gaia Calendar of Meetings](#).

This photo is of participants at the Solar System Working Group meeting of November 2004 which was held at Lohrmann Observatory, Dresden University of Technology. The meeting was convened by François Mignard and hosted by Sergei Klioner. Presentations from the meeting are available on the [Solar System Working Group web site](#).

Image courtesy of François Mignard
[\[High resolution image available\]](#)

[Published: 07/03/2005]

Picture of the Week

Imaging with Gaia

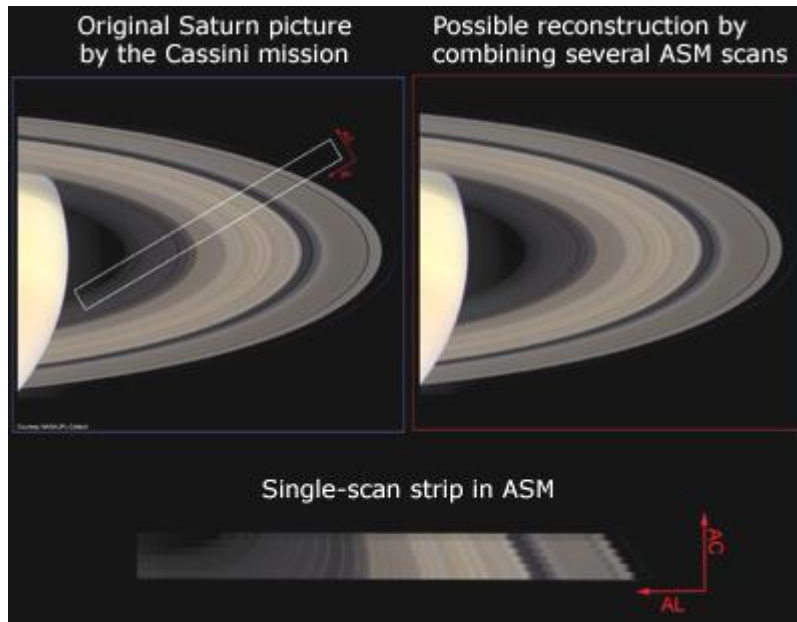

The continuous scanning of the sky by Gaia will sometimes bring some peculiar objects into the field of view of its instruments. Objects characterized by sharp details can be used to understand the theoretical resolving power of the Astrometric Field CCDs.

A [picture of Saturn and its rings](#) recently obtained by Cassini was used by Paolo Tanga to simulate what the Astro Sky Mapper (ASM) would show if the whole pixel data set obtained during a passage on the rings was transmitted to Earth. The rectangular area on the left was thus resampled at the ASM pixel size, obtaining the strip shown below the images of Saturn. Many fine structures are still visible, and such an image would be very useful to study stability of ringlets and other phenomena (such as the appearance of the radial "spokes") after the operations of the Cassini mission are completed.

Also, one should note that several ASM scans can be combined to restore information and resolution in all directions. The impressive image that Gaia could be able to provide in this case would be close to that shown on the right. The principle of this image restoration method has been successfully studied and simulated on small sources by Claire Dollet, Albert Bijaoui and François Mignard (Dollet et al. A&A 426, 729).

Even if Gaia is not designed to support imaging of widely extended objects - such as the rings of Saturn - the picture strikingly illustrates the capabilities of the AF detectors and optics.

Image courtesy of Paolo Tanga

[\[High resolution image available\]](#)

[Published: 21/03/2005]

Picture of the Week

Gaia CCD Evaluation - Novel Packaging

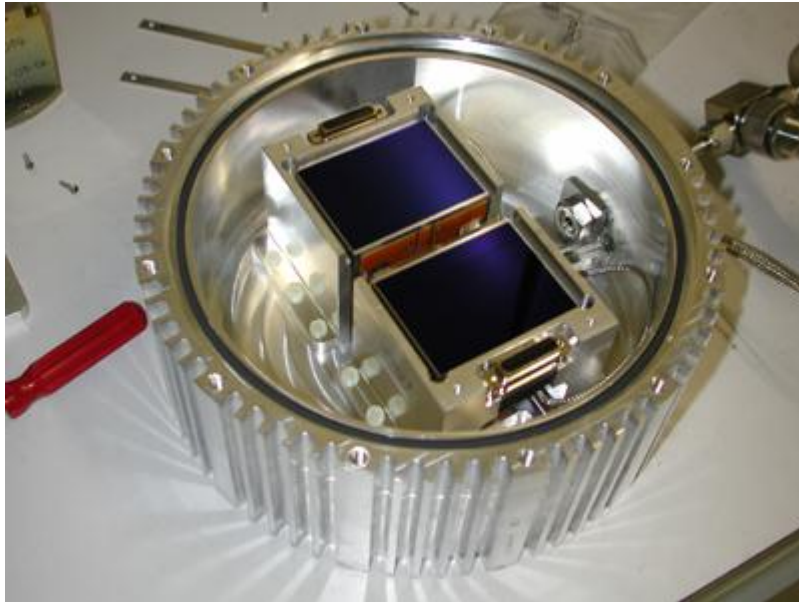

The CCDs for Gaia manufactured by e2v technologies under contract to EADS ASTRIUM SAS as part of the ESA "Gaia CCD and Focal Plane Technology Demonstrators" programme have been packaged with several novel features. The CCD is mounted onto a Silicon Carbide package and is driven through a flexible connector. The arrangement and wire bonding to the flexible connector has been designed to be minimal allowing for the maximum active area of silicon on the final array.

The new approach to packaging is currently going through environmental evaluation at e2v. This picture shows two Gaia AF CCDs mounted in a jig ready for thermal cycling. To avoid condensation on the CCD, the devices are mounted in a custom jig which is evacuated prior to the thermal test.

Image courtesy of [e2v technologies](#).
(Image copyright [e2v technologies](#))

[\[High resolution image available\]](#)

[Published: 04/04/2005]

Picture of the Week

Radiation testing of Gaia CCDs

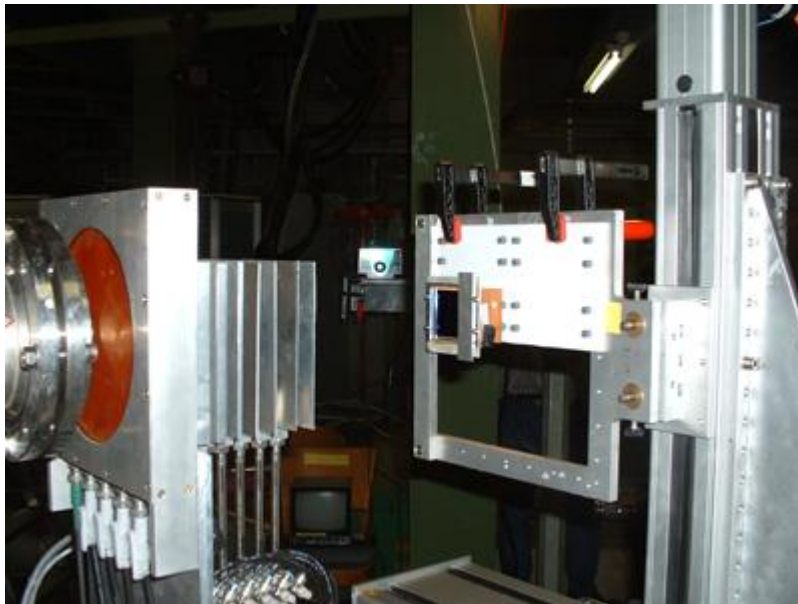

As part of an ongoing programme of radiation damage testing, a number of Gaia CCDs were recently taken to the Paul Scherrer Institut in Switzerland. In one of the institute's cyclotron beam-lines, the devices were exposed to non-ionizing radiation doses from 2×10^9 to 10^{10} protons per cm^2 (10MeV). The Gaia mission end-of-life particle radiation fluence is currently expected to fall between these values and the irradiated CCDs are now being tested to assess the impact of radiation damage on Gaia astrometric performance. The irradiations themselves and most of the pre- and post-irradiation testing are being conducted by Sira (UK) under sub-contract to EADS Astrium (Toulouse). In addition, one CCD will be tested at Astrium to provide a direct comparison with results obtained there last year using an un-irradiated device. As well as providing direct measurements of radiation effects and centroiding performance under test conditions, the test data are essential for validating models used to predict scientific performance of the flight instrument. This is the second round of irradiation and testing conducted as part of the ESA funded Gaia Technology Demonstration Activities. Building upon lessons learned in the first round, it is expected that these activities will provide a definitive set of reference data as Gaia moves into the flight-instrument design phase.

The image above shows a CCD mounted in front of the proton beam-line ready to be irradiated. An Aluminium shield can be seen over the right hand edge of the CCD. This will leave an un-irradiated (reference) area. Proton energy is defined by selecting a number of shutters or attenuators which can be seen left of centre in the image.

Image courtesy Gordon Hopkinson ([Sira UK](#)). [Published: 25/04/2005]

Picture of the Week

ODIS - One Day Iterative Solution in First Look

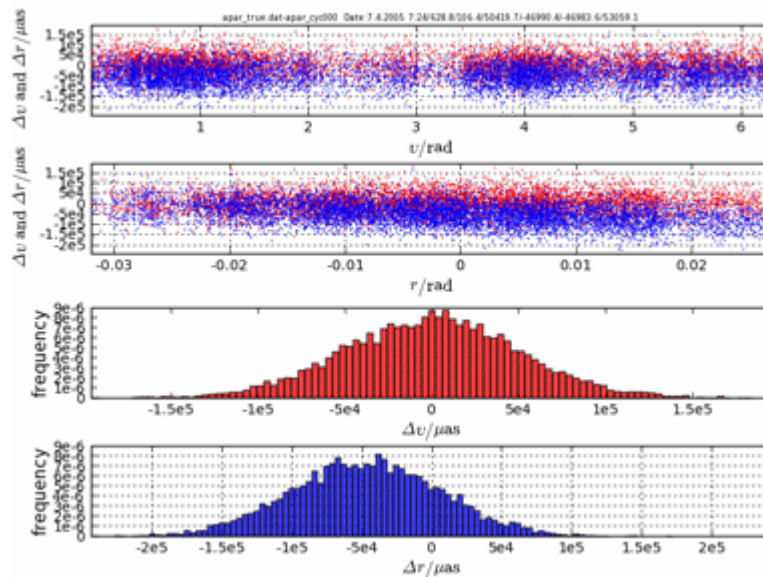

In order to reach the level of precision targetted by Gaia, many months of observational data must be incorporated into a global, complex data reduction process in order to perform a self-calibration of the satellite and subsequently to determine the astrometric and global parameters. Subtle malfunctions in the spacecraft or payload may impact on the measurement precision and instrument stability and hence degrade the final results. The 'First-Look' activity is designed to allow early identification of these types of effects so that they can be corrected.

First Look will perform an in-depth scientific assessment of the quality of the Gaia observations within 24 hours after they are received at the data processing centre. The One Day Iterative Solution (ODIS) is one of two methods presently under investigation which may perform this kind of analysis. The ODIS is an iterative (i.e. repetitive) scheme of complex computations. By calculating successively improved estimates of the relevant astronomical and instrumental parameters it ultimately tells us whether the individual measurements by Gaia "fit together".

The animation above shows how the method works on simulated Gaia observations. The top two panels show the differences between the estimated star positions and the "true" ones (i.e. those used to generate the simulated measurements), in two coordinates on the sky (red and blue). Each dot is one "star". The two lower panels show the histogram (frequency distribution) of those differences in the two coordinates.

The success of the method is demonstrated by the progressive outward motion (expansion) of the scale bars on the left of the top two diagrams, and at the bottom of the lower two diagrams. This motion indicates a very significant narrowing of the clouds of dots and of the histograms, i.e. an

improvement of the estimated parameters. In Gaia's main measuring direction (3rd diagram) the final errors of the star positions are reduced by a factor of 500 compared to the starting conditions.

Note that the differences of the star position do not go to zero (but converge to an almost sinusoidal curve) since the reference frame of the "true" and "noisy" data are rotated relative to each other. A picture of a diagram in the back-rotated reference frame as well as the original animation and further details are available from the [ODIS web pages](#).

Animation courtesy of Stefan Jordan

Published: 09/05/2005

Picture of the Week

Visibility of the Galactic Bulge with Gaia

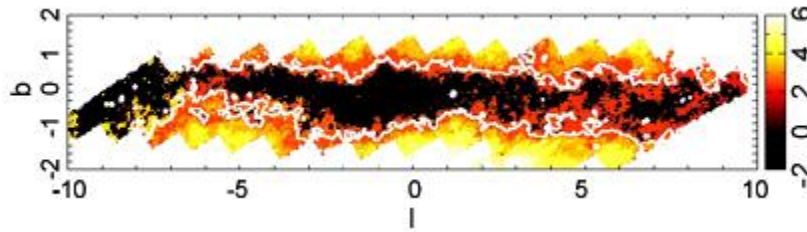

The Galactic Bulge is of particular interest for understanding Galaxy formation and evolution. Obtaining photometric and kinematic measurements present some challenges particularly in view of the high extinction and severe crowding of this region. A [recent paper by Robin et al](#) examines the possibility of reaching and measuring bulge stars with Gaia.

Crowding is not a problem in high extinction regions of the bulge but the bulge stars in these regions will probably be too faint to be observed with Gaia. In low extinction regions, such as Baade's window, the bulge giants are bright enough to be observed but in these regions crowding will be an issue for their observation. Robin and collaborators have examined whether there are regions in which the extinction is large enough to avoid crowding but not too large to hide the bulge stars. Their study shows that Gaia will produce a detailed survey of clump giants in the outer bulge, while a number of extinction windows will also allow access to measurements for a large number of clump giants in the inner disc. The data will place strong constraints on bulge formation models.

The image above shows the absolute magnitude of bulge stars reached at magnitude $G=20$, as a function of latitude and longitude, calculated using the Besancon Galaxy model and the SGS extinction map (see paper for details). An absolute magnitude of -2 means that no bulge stars will be detected (regions of high extinction). For the Gaia broad-band photometer the instrument characteristics are such that crowding will not be an issue in regions where bulge stars are visible. The crowding limit of the medium-band photometer, of 100,000 stars per square degree, is indicated in this figure by the solid white line. Regions accessible to the MBP are between the dark dust lane and this solid line.

The results of this study are published in *The visibility of the Galactic bulge in optical surveys. Application to the Gaia mission*, by A.C. Robin, C. Reyl , S. Picaud and M. Schultheis, in *Astronomy & Astrophysics*, v420, pg.129-135 (2005). The preprint is available from [astro-ph](#).

Image courtesy of A. Robin

Published: 30/05/2005

Picture of the Week

Electro-Optical Demonstrator Model

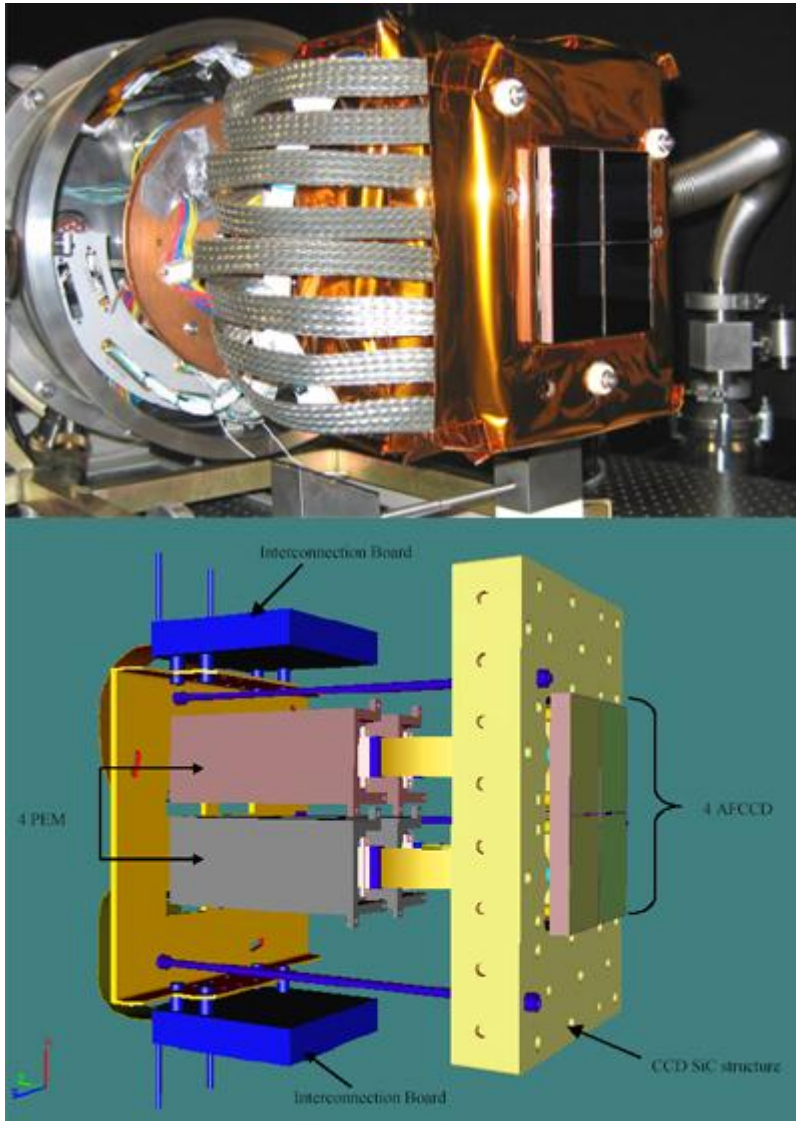

As part of the ESA "Gaia CCD & Focal Plane Demonstrator programme" a series of tests on the Electro-Optical Demonstrator Model (EODM) are underway at EADS Astrium (Toulouse). These tests are designed to demonstrate the feasibility of driving a number of CCDs synchronously in the various Gaia astrometric TDI modes (Astrometric Sky Mapper (ASM) mode, Astrometric Field (AF) normal, AF bright star). The EODM consists of a SiC structure with 4 sockets which are representative of the flight design sockets; 4 back-illuminated Gaia prototype CCDs mounted and aligned on this SiC structure; 4 Proximity Electronic Modules (PEMs) - one operating a CCD in ASM mode and the other 3 in AF mode; 2 interconnection boards which interface between the PEMs and the spacecraft electronics. These elements can be

clearly seen in the schematic diagram shown above. The photograph above shows the Gaia EODM in the EADS Astrium custom test facility. This facility has been developed in order to operate the EODM at 165K (Gaia operating temperature) in a vacuum chamber whilst providing a moving optical source. (See also [Picture of the week 20/12/2004](#)). The schematic diagram indicates the location of several key components.

Photograph courtesy Anouk Laborie (EADS-Astrium);
Schematic diagram courtesy of Cyril Vetel (EADS-Astrium).
Images copyright EADS-Astrium

[Published: 13/06/2005]

Picture of the Week

Cebreros ground station



The new ESA ground station at Cebreros, which has been earmarked for use by Gaia, has reached a major milestone: following successful assembly of the 35-metre deep-space dish antenna structure in November 2004 and the acceptance testing of radio-frequency components, the station is now undergoing final on-site testing (see the ESA article [Cebreros marks major readiness milestone](#).) Cebreros will be operated from the European Space Operations Centre (ESOC) in Darmstadt, Germany, and will be used for sending commands to the Gaia spacecraft and receiving data from the onboard instruments. It is expected to become operational later this year.

Image copyright: European Space Agency, ESA. Published: 27/06/2005

Picture of the Week

Detecting satellite remnants in the Galactic halo with Gaia

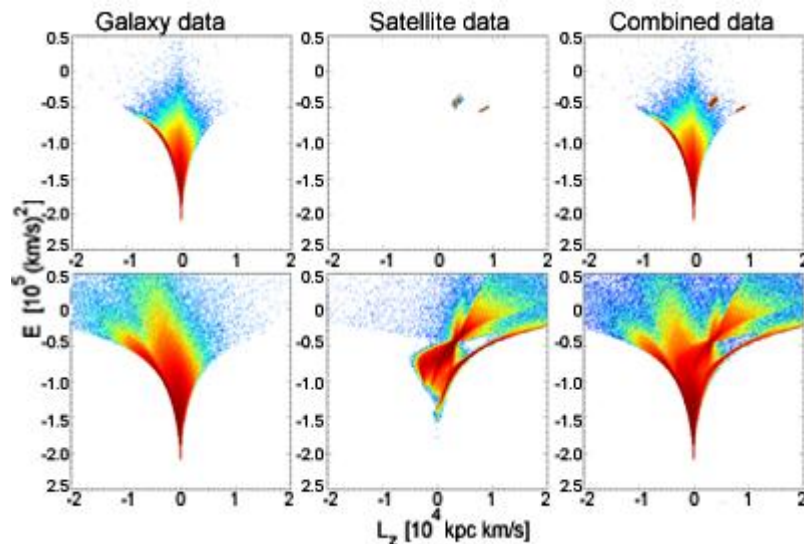

A [recent study](#) by Brown and collaborators has examined the problem of identifying remnants of satellite galaxies in the halo of the Milky Way with Gaia data. This data, providing full phase-space information across the entire volume of the Milky Way, provides a unique opportunity to search for such remnants. The challenge is to extract the remnant signal from a very large data set, of order 1 billion objects, in the presence of observational errors and against a background population of Galactic stars.

A Monte Carlo simulation of the Gaia catalogue was performed using a realistic number of objects and yielding a catalogue of 3.5×10^8 stars (excluding regions close to the Galactic plane and centre). Within this catalogue are the hidden traces (tidal streams) of satellite dwarf galaxies. Brown and collaborators then explored the feasibility of detecting the tidal streams in the halo by examining the energy versus angular momentum plane.

The image above shows the energy-momentum space for two of the disrupted satellites in the synthetic Gaia catalogue. The panels depict from left to right: Galaxy stars only, satellite stars only, Galaxy plus satellite stars. The upper panels show the error-free E - L_z diagrams; the lower panels show the energy and angular momentum as they would appear when derived from the Gaia catalogue. Satellite remnants are easy to identify in error-free data but become more difficult to isolate when observational errors are added. Further investigation by Brown and collaborators has shown that the remnants can be recovered by restricting the search to samples of high-quality data.

For details see [Detection of satellite remnants in the Galactic halo with Gaia - I. The effect of the Galactic background, observational errors and sampling](#), A.G.A. Brown, H.M. Velazquez & L.A.

Aguilar, accepted for MNRAS.

Image courtesy of A. Brown.

Published: 25/07/2005

Picture of the Week

Participants at the joint RGO-ESA workshop on 'Future Possibilities for astrometry in Space', Cambridge, UK, 19-21 June 1995



Ten years ago, in June 1995, the Royal Greenwich Observatory and ESA organised a workshop on 'Future possibilities for Astrometry in Space' in Cambridge, UK. This was partly in response to the recommendation to ESA, by an independent review body - the Horizon 2000+ Survey Committee - to *'initiate a Cornerstone-level programme in interferometry for use as an observatory open to the wide community. The first aim is to perform astrometric observations at the 10 microarcsec level'*.

The aim of the workshop was to provide a forum for discussion for people interested in the scientific and technical aspects of the design of such a future astrometric space mission. At that time the Gaia concept envisaged two or three small interferometers for measuring astrometric parameters of tens of millions of stars throughout the Galaxy, down to 15 mag. No provision for acquiring a number of basic stellar parameters (e.g. radial velocity, metallicity, stellar type,..) was explicitly foreseen. The workshop was one of the first opportunities for members of the scientific community to express their interest in Gaia, and their willingness to participate in its scientific preparation. Papers presented were published in the workshop proceedings ([ESA SP-379, September 1995, M.A.C. Perryman & F. van Leeuwen, eds](#)).

In the intervening ten years comprehensive studies by ESA, industry and the scientific community have provided remarkable progress, demonstrating that these highly ambitious goals are indeed technically feasible. The interferometric approach has been replaced by a simpler monolithic optical design, improvements in CCD technology have been achieved, and the aim of detecting tens of millions of stars to a limit of 15 mag has been extended to cover around one billions objects to a completeness limit of 20 mag, including solar system bodies and extragalactic objects. On-board acquisition of radial velocities, along with broad-band and medium-band photometry, is now an integral and essential part of the present mission. On the downside, the 10 microarcsec target accuracies at 15 mag have been replaced by a slightly less demanding 20 microarcsec. The overall progress is highlighted by a number of significant milestones that have recently been reached: the successful completion of the major system-level studies and associated technological development activities (News item: 2005-06-29, 2005-06-09), the decision by ESA to issue the invitation to tender for Phase B2 and beyond to industry (News item: 2005-07-01), and the initiation of the organisation for the Gaia data processing tasks

under the auspices of the Data Analysis Coordination Committee (News item: 2005-6-27). Remarkably, the schedule since 1995 has also been maintained: a launch date of somewhere between 2010-15 was noted at the meeting, ESA's SPC envisaged a launch before 2012 when the mission was accepted in 2000, and the current Phase B2/C/D implementation schedule has adopted a target launch date of the second half of 2011.

The photograph above shows the attendees at the joint RGO-ESA workshop on 'Future possibilities for Astrometry in Space', Cambridge, UK, 19-21 June 1995. A larger version of the photograph can be viewed [here](#), and a guide to people in this photograph can be found [here](#).

Published: 08/08/2005

Picture of the Week

Windowing & on-board data handling of MBOs & NEOs

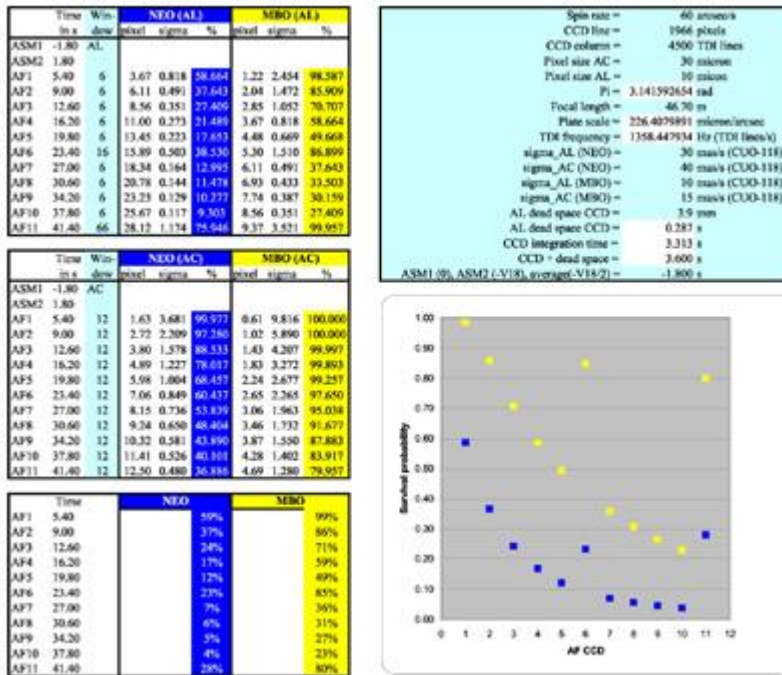

Gaia will observe about 500,000 asteroids. The majority of these orbit the Sun in the main belt (hence the abbreviation MBO: main-belt object), at a typical distance of 3 AU from the Sun. A small fraction of the asteroids observed by Gaia (about 0.2%, or about 1000 objects) have orbits which bring them much closer to Earth. These objects are called near-Earth objects (NEOs). When considering time spans of millions of years, NEOs have finite collision probabilities with Earth, making them high-profile objects. Gaia's repeated astrometric and photometric observations of asteroids throughout the 5-year mission will allow astronomers to characterise their orbits, sizes, shapes, masses, taxonomic classes, spin properties, albedos, etc., with much greater precision than has been possible until now.

Given their proximity, solar-system objects generally move significantly with respect to the "fixed stars". The current baseline strategy for dealing with "moving objects" on-board is simple: ignore their motions, treat them as stars, and assign default windows and propagate these throughout the focal plane, only taking any systematic, overall scan-law induced motions into account. With this recipe, MBOs and NEOs suffer a finite risk of running out of their assigned windows, with negative impacts on scientific performance, at some stage during their focal-plane passage. With typical velocities of several tens of mas/s and a typical focal-plane crossing time of 60 s, differential motions over the focal-plane passage with respect to "fixed windows" would be thousands of mas, corresponding to tens of pixels. For a given moving object, the risk (probability) of running out of a window depends on the velocity of the object and on the applied

window sizes in the various CCD strips.

The figure shows a screenshot of a simple, interactive Microsoft Excel spreadsheet. This tool, available from LiveLink, calculates, for a given NEO and MBO velocity distribution and for a given windowing scheme, the probability (dubbed "survival probability") that a moving object is still contained within its window, both along- and across-scan, as function of CCD strip. The graph shows, for a hypothetical "mixed windowing scheme", namely with 66 read samples in AF11(*) and with 16 read samples in AF6(*), the survival probability for NEOs (blue) and MBOs (yellow). The smooth exponential trends indicate the performance of a uniform windowing across AF1-11 with 6-sample windows. The increased "survival probabilities" for AF6 and AF11 result from the increased window sizes. In reality, however, extended window sizes will only be applied, at most, in one CCD strip. A tradeoff analysis between solar-system object science performance versus windowing-scheme complexity and inhomogeneity has recently been initiated within the [On-Board Detection Working Group](#) and the [Solar System Working Group](#), aimed at making a final recommendation on requirements for any special (extended) sampling for solar-system objects by 1 January 2006.

(*) AF refers to the Astrometric Field in Astro. The numerical number indicates the CCD strip.

For details see "Windowing and on-board data handling of MBOs and NEOs", J.H.J. de Bruijne, 27 July 2005, technical note [Gaia-JdB-024](#) plus MS Excel [spreadsheet](#) (both available from LiveLink).

Image courtesy of Jos de Bruijne.

Published: 22/08/2005

Picture of the Week

New survey of Milky Way central bar

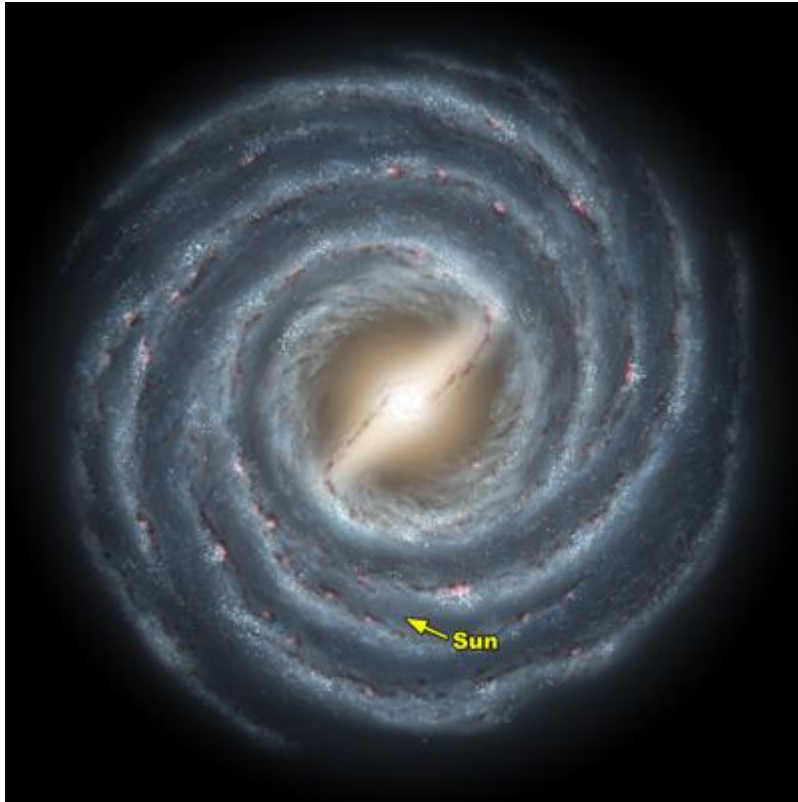

The Milky Way has long been believed to harbour a central bar, and observations during the 1990's have provided strong evidence to support this. However, our vantage point with respect to the Galactic Centre makes it difficult to accurately determine the size & shape of this bar and the surrounding arms. Results from the Spitzer Space Telescope-GLIMPSE survey give the most detailed picture to date of the inner region of the Milky Way. Yet many unanswered questions still remain regarding the formation process, age, metal content, mass distribution and kinematics of the bulge. Gaia will make a significant contribution to addressing these issues by providing precision astrometry, photometry and radial velocity measurements for a significant part of the inner region of the Galaxy.

The GLIMPSE (Galactic Legacy Mid-Plane Survey Extraordinaire) point source catalogue (containing approximately 30 million mid-infrared sources at $10^\circ < |l| < 65^\circ$ and $|b| < 1^\circ$) was used to determine the distribution of stars in l , b and apparent magnitude, m . A strong north/south asymmetry in source counts for $|l| < 30^\circ$ and a distinct hump in the number of star at apparent magnitude $m \sim 12.5$ over the range $l = 10-30^\circ$ suggests the detection of the Galactic bar. The authors note that the data is best interpreted by a linear bar passing through the Galactic Centre with half-length $R_{\text{bar}} = 4.4 \pm 0.5$ kpc, tilted by $\phi = 44 \pm 10^\circ$ to the Sun-Galactic Centre line. This is longer and at a different orientation to previous results which estimated $R_{\text{bar}} = 3.1$ -

3.5 kpc and $\phi = 15\text{-}35^\circ$. While this is the simplest interpretation of the results, the authors caution that other configurations should be explored.

The results of this investigation are published in *First GLIMPSE Results on the Stellar Structure of the Galaxy* by R.A. Benjamin et al., accepted for publication in *Ap. J. Letters* (preprint available as [astro-ph/0508325](#)).

This artist's impression shows a view of the Milky Way and the central bar relative to our Sun's position and viewed from above.

High-resolution image available from the [Spitzer Space Telescope web site](#).

Image copyright: NASA/JPL-Caltech/R. Hurt (SSC)

Published: 05/09/2005

Picture of the Week

Asteroid orbits & global parameter fitting

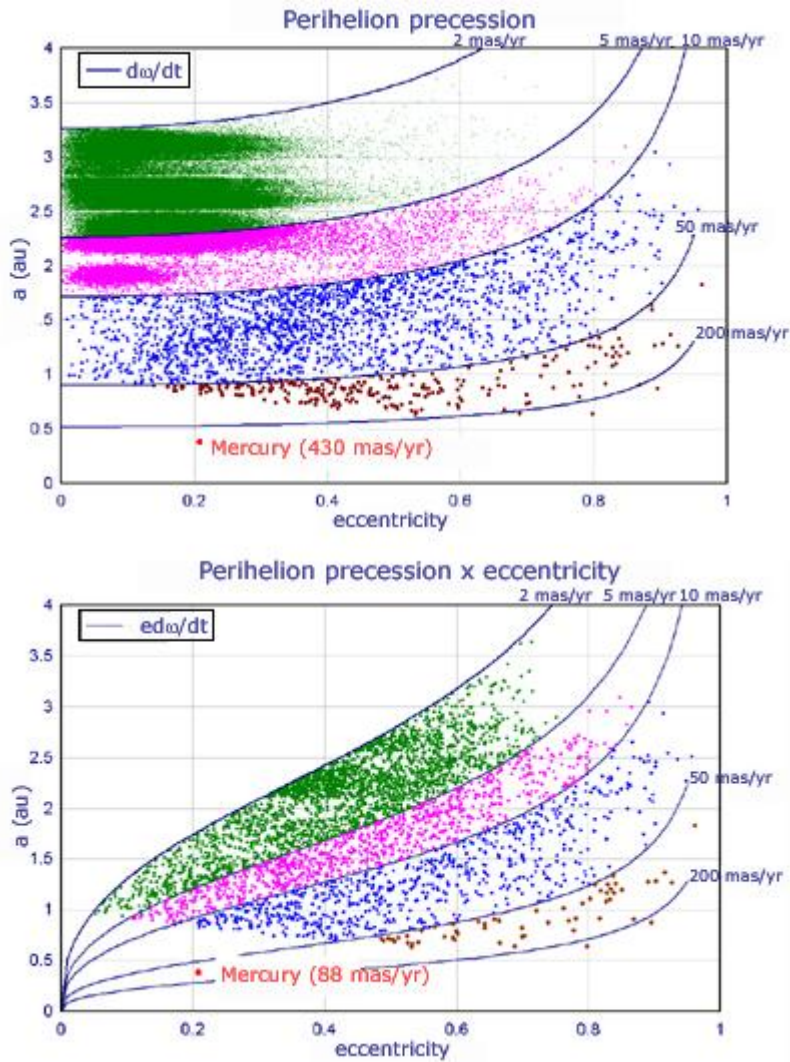

During its 5-year mission Gaia will obtain highly accurate astrometric positions of about 500,000 asteroids, primarily located in the main belt at a distance of about 2.7 AU from the Sun but also belonging to the population of near-Earth asteroids. With about 70 individual observations for each object scattered over the duration of the mission, orbits will be determined with an unprecedented accuracy, to such an extent that many old ground-based observations will be redundant.

General relativity predicts that, as they orbit the Sun, the planets do not exactly retrace the same path each time and that the perihelion advances. The relativistic effect is just a small addition to a perihelion shift arising in Newtonian theory from the planetary perturbations. Fifty years before

Einstein published his theory of gravitation the effect was clearly seen in the orbit of Mercury: the major planet closest to the Sun and with the most eccentric orbit, just the two ingredients needed to carry out a test of relativity. So far the perihelion precession has only been seen convincingly for Mercury, but unfortunately accurate testing is not possible as, with a single planet, the relativistic perihelion cannot be disentangled from the contribution of the solar flattening (solar J2).

The recent near-Earth asteroid discoveries provide better opportunities to decouple General Relativistic and J2 effects by fitting the observations of objects with different orbital parameters. The plots above give, for planets bright enough to be observed by Gaia, the precession rate and its product by the eccentricity which is a better indicator of the measurable effect (a large precession on a circular orbit is not detectable). One sees that there are several dozen planets with a signature higher than Mercury and several hundreds that will contribute significantly to the solution. From recent simulations by D. Hestroffer one knows that Gaia can solve simultaneously for the solar flattening and the relativistic parameter involved in the perihelion precession. Thus Gaia will improve upon ground-based measurements by one order of magnitude.

Images courtesy of François Mignard.

Published: 03/10/2005

Picture of the Week

Ice Age Epoch and the Sun's path through the Galaxy

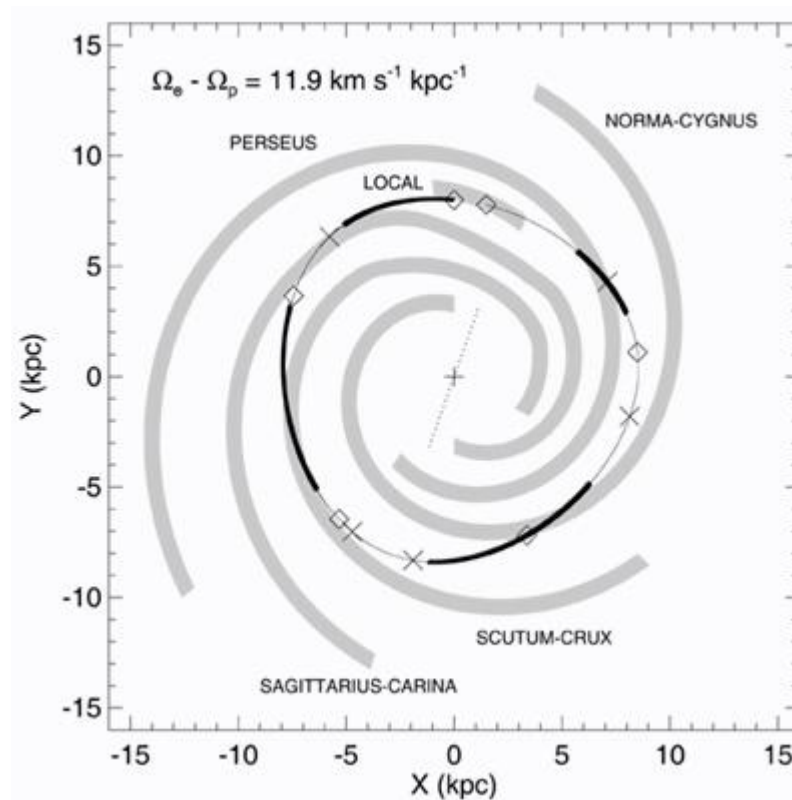

A [recent calculation](#) of the Sun's motion through the Galaxy has shown that, during the past 500 million years, the Sun has traversed four spiral arms at times that appear to be consistent with long-duration cold periods on Earth.

The calculations are based on the Sun's current motion relative to the local standard of rest as determined from parallaxes and proper motions from Hipparcos, and on a realistic model of the Galactic potential. Integrating back in time over 500 million years allows the Sun's passage through the Galaxy to be tracked.

The location of the Sun's trajectory relative to the spiral arms of the Galaxy during this period depends critically on the relative angular speeds of the Sun and the spiral arms. The spiral pattern speeds are currently not well determined and may even differ in the inner and outer regions of the Galaxy. For a spiral arm pattern speed of 14-17 km/s/kpc the authors show that the Sun will have crossed four spiral arms during the past 500 million year at times consistent with periods of extended cold (icehouse periods) determined from geological studies. These speeds also lead to a distribution of mass extinction times that fall close to or within a spiral arm passage, compatible with theories which link these two occurrences.

The authors note that their adopted pattern speed is lower than that adopted for recent dynamical models of the Galaxy and suggest that the resolution of this dilemma may require more advanced dynamical models that can accommodate differences between pattern speeds in the inner and outer parts of the Galaxy. Observational data available to date is inconclusive in determining some details of the dynamical state of the Galaxy. Gaia's precise measurements of 1 billion stars in our Galaxy will provide a detailed observational data set against which to test and fine-tune existing and new dynamical models of our Galaxy.

The image above depicts the Sun's motion relative to the spiral arm pattern as viewed from above the plane. The plus sign marks the centre of the Galaxy and the dotted line through the centre marks the location of the central bar. The four spiral arms, plus the local Orion spur, are indicated by the grey shaded regions. The Sun's path in the reference frame of the spiral arms is indicated with a solid line; diamonds mark periods of 100 Myr back in time from the present (top left diamond). Thick solid lines correspond to icehouse periods and crosses indicate times of large mass extinctions.

Details of the calculations are given in ["Ice Age Epoch and the Sun's path through the Galaxy"](#), D.R. Gies & J.W. Helsel, *Ap.J.* 626:844-848, 2005.

Image courtesy of D.R. Gies & J.W. Helsel

Published: 24/10/2005

Picture of the Week

Detecting periodic variables with Gaia

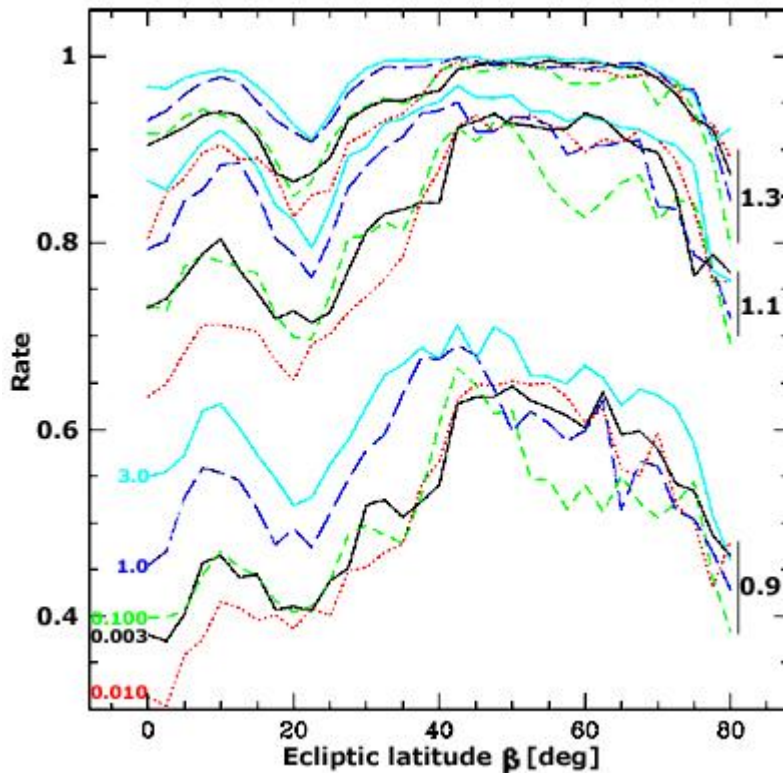

In the course of its five year mission, Gaia will provide multicolour photometry, in about 20 passbands extending over the visible range, of all objects crossing the field of view of the instruments. This large-scale, deep (down to $V=20$ mag) photometric survey will yield, among other things, a virtually unbiased sample of variable stars of nearly every type. Crude estimates put the number of variable stars to be detected and analysed in the range of tens of millions, with about half of these being periodic variables.

Laurent Eyser and Francois Mignard have assessed the performance of Gaia in analysing photometric periodic phenomena ([see paper](#)). The authors simulated a data set of 3 million observations (for a total of 10,000 stars) taken with Gaia over a timescale of 5 years. This data set takes account of the unusual sampling of epochs which results from Gaia's peculiar scanning law. The photometric variability for each star was modelled by a simple sinusoidal signal with one frequency. Periodicity searches were performed on the signal assuming no a-priori information, and sampling a range of periods.

The image above shows the rate of correct detection for normalized signal-to-noise ratios, X (written on the right), and frequencies (in cycles per day; written on the left for $X=0.9$, the same

colour scale and line type are applicable to the higher signal-to-noise ratios).

The results of the study show that with adequate frequency analysis algorithms one can recover the period of regular variable stars even with a signal-to-noise ratio of about unity. The study also revealed that, irrespective of the very irregular time-sampling expected from Gaia, frequencies much higher than the upper frequency estimated from a straightforward evaluation of the Nyquist boundary could be determined. Both of these outcomes are good news for the continuing preparation and subsequent scientific exploitation of the mission.

The authors note that this investigation has highlighted one area of preparation that needs particular attention in the coming years: the development of optimised software. Frequency analysis without any apriori information is a computationally demanding task which must be tackled if the goal of analysing from scratch all Gaia variable stars is to be achieved.

(A Coordination Unit on Variability Processing has been established under the auspices of the Gaia Data Analysis Coordination Committee. This unit is charged with organising all data analysis aspects related to variability. Individuals interested in contributing to this area should contact Laurent Eyer.)

Further details of this study can be found in ["Rate of correct detection of periodic signal with the Gaia satellite", L. Eyer & F. Mignard, MNRAS, 361, 1136-1144 \(2005\).](#)

Image courtesy of L. Eyer & F. Mignard

Published: 14/11/2005

Picture of the Week

Testing General Relativity with Gaia: light bending by Jupiter

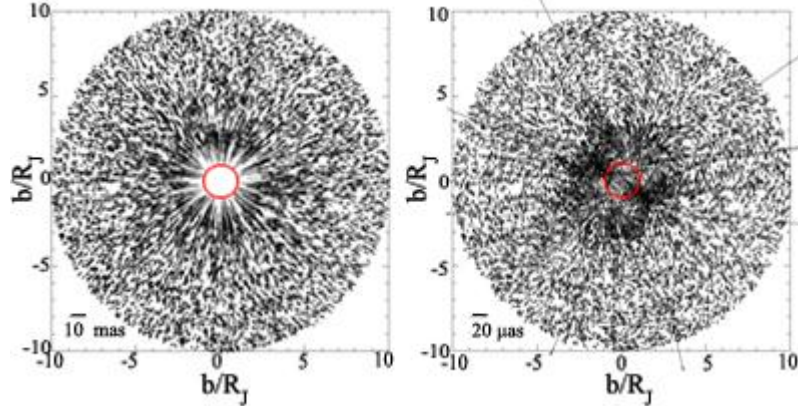

The GAREX study* aims to investigate all possibilities offered by Gaia to test aspects of General Relativity. One such possibility is to carry out small field experiments looking at light propagation by means of differential measurements of stellar positions near the planets. A [recent paper](#) by Crosta & Mignard reports on one such case: the bending of light by Jupiter at the microarcsecond level and its detection by Gaia.

For Jupiter, the monopole deflection for a grazing ray is approximately 16 milliarcsecond with a (superimposed) component from the quadrupole moment of approximately 240 microarcseconds. This secondary deflection has a very specific pattern as a function of the position of the star with respect to the planet and the orientation of its spin axis. Crosta & Mignard have simulated Gaia observations of Jupiter, against a realistic stellar background, for the period 2012-2018. Star patterns in Gaia's two fields of view are compared, and differences in the along-scan positions are fit to the gravity model with the two unknowns: gamma and epsilon (the quadrupole efficiency factor). The study shows that deviations from General Relativity with the monopole deflection can be assessed to 10^{-3} with Jupiter alone, and that with the same observations the quadrupole light deflection will be detectable, for the first time, at a 3-sigma confidence level.

The figures above show the monopole (left) and quadrupole (right) deflection cumulated vector fields around Jupiter with all the observations mapped for the epochs between 2012 and 2018. The radial nature of the monopole deflection is clearly visible, as is the more complex pattern of the quadrupole effect.

Further details of the simulations, and of this GAREX experiment, can be found in "[Micro-arcsecond light bending of Jupiter](#)", M.T. Crosta and F. Mignard, astro-ph/0512359 (submitted to Classical & Quantum Gravity)

*GAREX stands for GAia Relativistic EXperiments.

Image courtesy of M.T. Crosta & F. Mignard

[Published: 19/12/2005]

2006

11/13: AGIS test results
◄ 09/25: Gaia Focal Plane
◄ 08/02: GUMS release
◄ 04/24: RP spectra
◄ 03/27: Gaia telescopes
◄ 02/27: First data from RAVE
◄ 02/06: L3CCD life tests
◄ 01/23: AGIS result

Picture of the Week

The Astrometric Global Iterative Solution (AGIS)

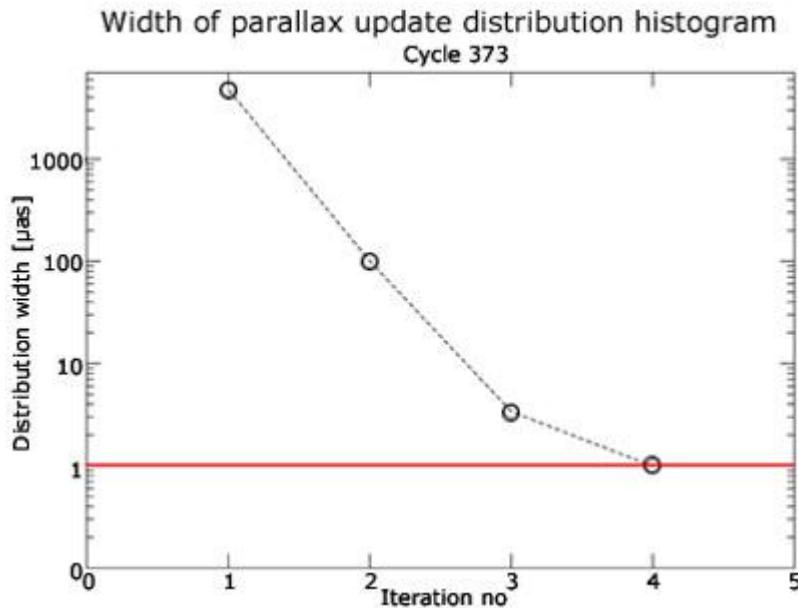

A new implementation of the Astrometric Global Iterative Solution (AGIS) has recently been completed by the Gaia SOC development team at ESAC. AGIS is a core element of the overall Gaia data reduction process. It consists of an iterative, simultaneous adjustment of a large number of astrometric, attitude, instrument calibration, and global physical parameters to obtain the optimum agreement between observation data and an observational model.

In the new ESAC AGIS system the iterative loop is controlled through a stopping criterion that is based on the monitoring of the adjustments to the stellar parallaxes. In each iteration the updates to the parallax values with respect to the previous iteration are histogrammed and the width of the resulting distribution determined. The system is considered converged if this width falls below 1 microarcsec.

The figure shows the evolution of the parallax distribution width with iteration number for a first completed AGIS validation run involving 1.1 million stars simulated over an 18-month observation period. It can be seen that convergence was achieved within 4 iterations.

This satisfactory result demonstrates on the one hand the correctness of the new implementation but also for the first time convincingly validates the fundamental working principles of AGIS on a large scale. Future test runs with more, and increasingly noisier, input data, which are more representative of the real mission, are planned and expected to further corroborate the soundness of the chosen astrometric data reduction approach with AGIS.

For further details see [ESAC implementation of the astrometric global iterative solution \[GAIA-](#)

[C3-TN-ESAC-UL-015-1](#) by U. Lammers, J. Hernandez, J. Hoar, and W. O'Mullane,

[Published: 23/01/2006]

Picture of the Week

Low-Light-Level (L3) CCD testing at Brunel University

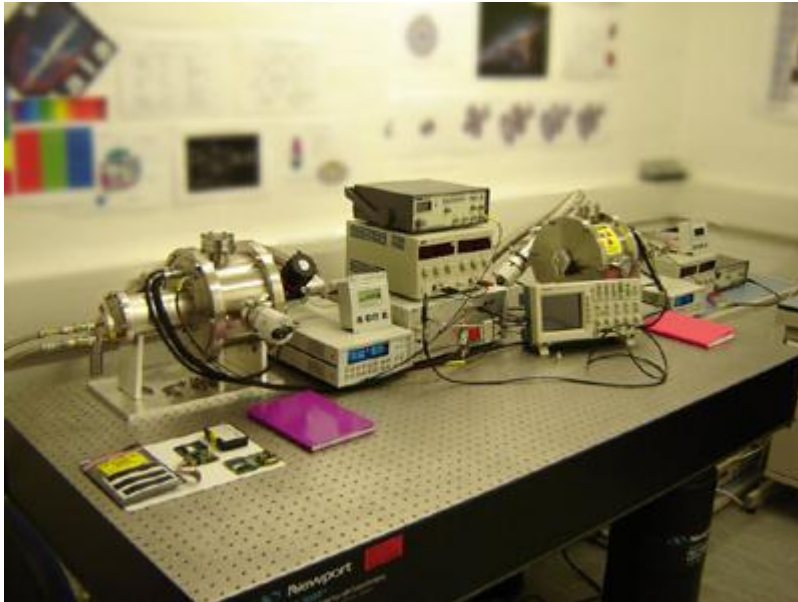

Characterisation of [e2v technologies](#) Low-Light-Level (L3) CCD technology for implementation in the CCDs of Gaia-RVS has continued at [Brunel University](#) throughout 2005, and now into 2006, with two devices undergoing long duration testing.

The two CCD97 high resistivity devices, representative of the devices baselined for use in RVS, have been operating continuously at -100°C since October 2005. Data have been recorded a number of times, during the more than 1500 hours of operation, to characterise any long term changes in the L3 gain of each device. To date, the L3 gain has remained very stable in each device, a change in operating voltage of only ~ 0.2 volts being required to maintain the specified RVS operational gain of x8. Life testing of the two devices will continue into 2006.

The photograph shows the optics laboratory at Brunel where the life testing is taking place. The two vacuum chambers each contain one of the CCD97 devices. The temperature and turbo pump controllers, CCD drive unit and associated electronics are positioned to the right of each chamber.

Photo courtesy of David Ryan Smith.

[Published: 06/02/2006]

Picture of the Week

First RAVE data publicly available

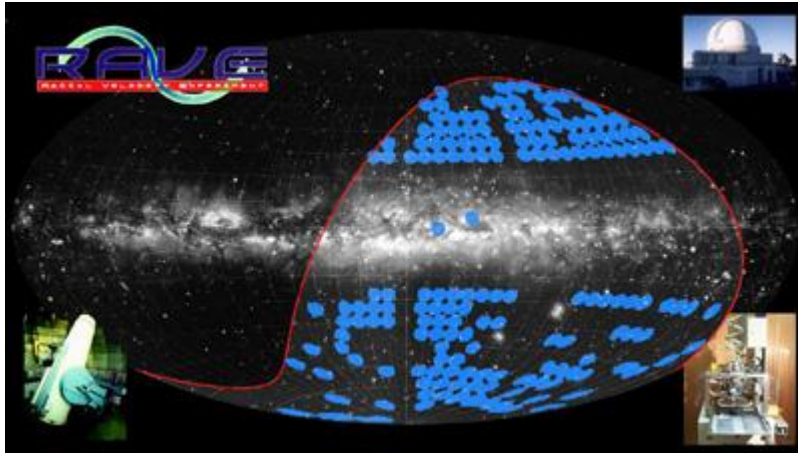

The [Radial Velocity Experiment \(RAVE\)](#) has made data from the first year of operations publicly available. The [data set](#), available to download from the RAVE website, consists of the new line-of-sight motions for some 25,000 stars, plus data on their brightness, colour and motion across the sky.

RAVE is a spectroscopic survey that aims to measure the radial velocities and stellar atmosphere parameters (temperature, metallicity, surface gravity) of up to one million stars near the Sun. The survey uses the 'six degree field' (6dF) multi-object spectrograph on the 1.2-m UK Schmidt Telescope of the Anglo-Australian Observatory (AAO), sited at Siding Spring Observatory in New South Wales, Australia. This instrument is capable of obtaining spectroscopic information for as many as 150 stars at once, over a full six degree diameter - a hundred times larger than most current spectrographs can handle.

In addition to providing a valuable data set for studying many aspects of galactic evolution, this large data base of stellar spectra will provide a useful training set for the development of the processing software and scientific analysis of spectra (for the brightest 100-150 million stars) acquired by the Radial Velocity Spectrometer instrument on Gaia.

The image above shows a map of the Milky Way from Lund Observatory, overlaid with the fields observed for RAVE's first data release. Each blue circle is a patch of sky six degrees across - the field of view of the Anglo-Australian Observatory's UK Schmidt telescope. The red line marks the boundary between the southern and northern equatorial hemispheres.

Image credit: Richard Sword, George Seabroke (Cambridge) and the RAVE collaboration. Milky Way image copyright Lund Observatory.

[Published: 27/02/2006]

Picture of the Week

The Gaia Telescopes

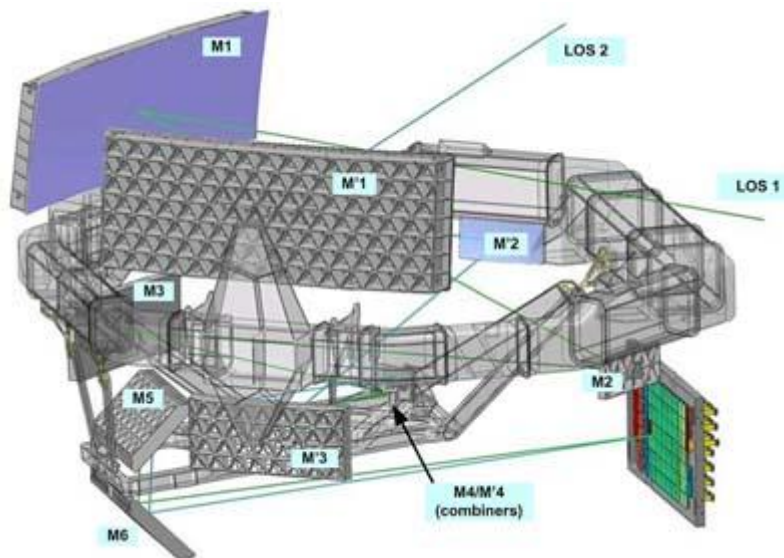

The Gaia optical design features two telescopes, each composed of six reflectors (two of which are common), sharing a common focal plane. The entrance pupil of each telescope is 1.45 m x 0.5 m; the focal length is 35m.

The mirrors, and the optical bench on which they are mounted, are constructed from SiC, and the entire optical system is compact, with an optical bench diameter of about 3m.

The image shows the dual telescope system: light from each line-of-sight (LOS) is reflected by a series of mirrors (M1-M4, M1' - M4'); followed by M5-M6) to the common focal plane.

For further details of the telescopes, the focal plane and other aspects of the spacecraft and payload design, please refer to the [Information Sheets](#).

Image credit: EADS Astrium

[Published: 27/03/2006]

Picture of the Week

Dispersed RP spectra for M6V star with G=15mag

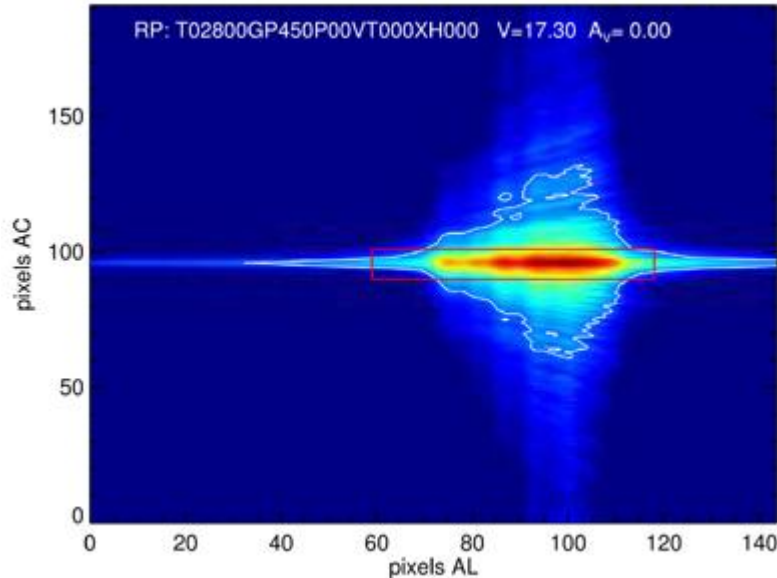

Gaia's photometric instrument is based on a dispersive-prism approach such that starlight is not focused in a PSF-like spot but dispersed along the scan direction in a low-resolution spectrum. Gaia features two low-resolution fused-silica prisms dispersing all the light entering the field of view. One disperser - called BP for Blue Photometer - operates in the wavelength range 330-660 nm; the other - called RP for Red Photometer - covers the wavelength range 650-1000 nm. Both prisms have broad-band filters for blocking unwanted light. The photometric instrument is integrated with the astrometric and spectroscopic instruments and telescopes; the photometric CCDs are located in the Gaia focal plane. Two CCD strips of 7 CCDs each are dedicated to photometry, one for BP and one for RP. Both strips cover the full astrometric field of view in the across-scan direction.

The sampling of the spectra is a function of wavelength as a result of the natural dispersion curve of fused silica; the dispersion is higher at short wavelengths. The BP and RP dispersers have been designed in such a way that BP and RP spectra have similar sizes (on the order of 36 samples along scan). BP and RP spectra will be binned on-chip in the across-scan direction; no along-scan binning is foreseen. For bright stars ($G \sim 13$ mag), single-pixel-resolution windows are used, in combination with TDI gates. Window extensions of 12 samples on either side of the 36-sample source area, meant to measure the sky background, are available.

The image shows a dispersed RP image for an M6V star with magnitude $V = 17.3$ mag, corresponding to $G = 15$ mag. The colour scale shows the photon counts in each pixel. The white contour indicates where the sky-background level starts. The red rectangle is the window around the dispersed image that will be read out and transmitted to ground. The window consists of 12 +

36 + 12 = 60 samples of 1 X 12 pixels (AL X AC) each. Normally, the flux inside the rectangle is summed in the vertical (across-scan) direction to obtain the 1D spectrum.

Further details are available from "Interface document for ad-hoc simulations of prism spectra for the EADS-Astrium Gaia design", by A.G.A. Brown ([GAIA-C8-SP-LEI-AB-006-1](#), available from Livelink).

Image courtesy Anthony Brown

[Published: 24/04/2006]

Picture of the Week

GUMS - the Gaia Universe Model Snapshot

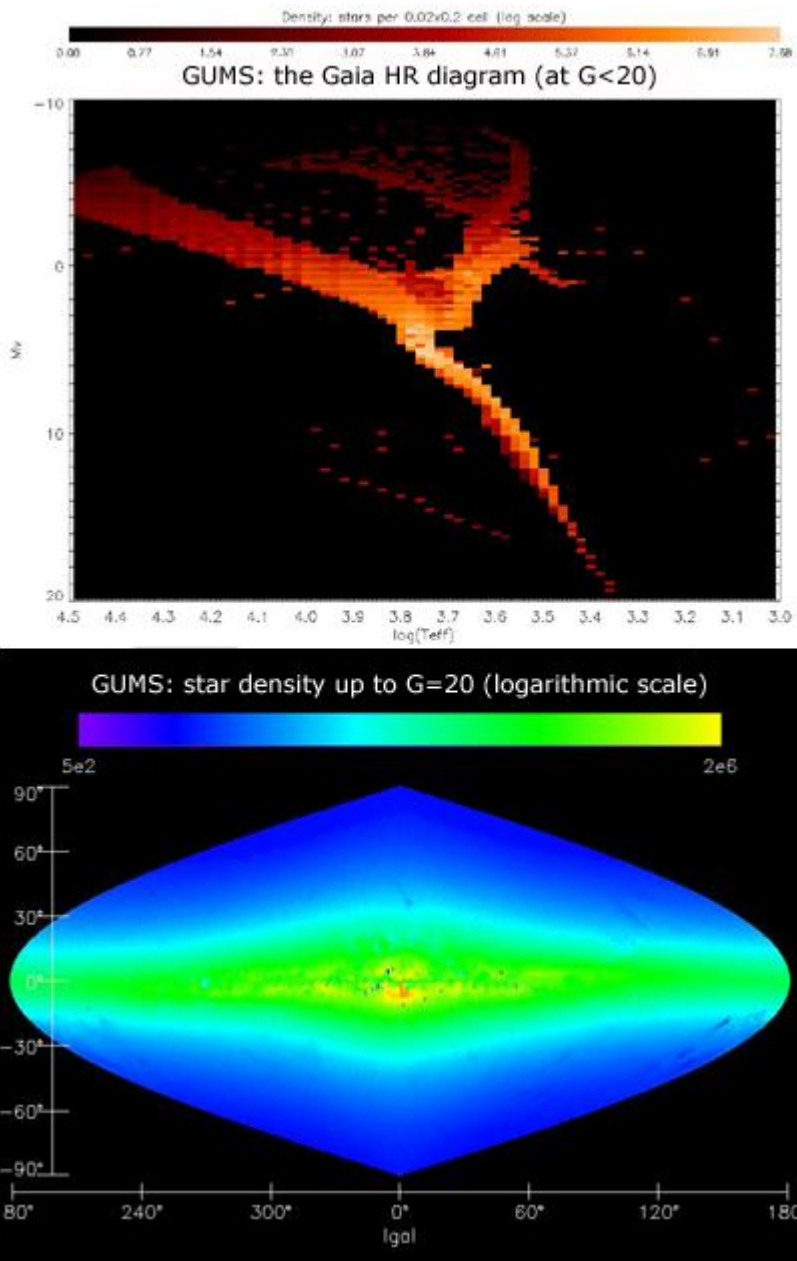

Coordination Unit 2 (Data Simulations) has released a preliminary, experimental version of [GUMS, the Gaia Universe Model Snapshot](#). GUMS is a one-billion object catalogue generated using [GOG](#). The purpose of GUMS is to allow validation of the Universe Model used in the full Gaia mission simulation, and to provide useful statistics for the Gaia observations, for example: statistics on G magnitude, parallax, space velocities (proper motion and radial velocity), some

astrophysical parameters (Teff, log(g), [Fe/H]) and stellar masses.

This first experimental version of GUMS was generated using 40 of the [Mare Nostrum](#) supercomputer processors for about 12 hours. The Universe model used in this version includes only galactic stars, generated using the Besançon Galaxy Model (the generation of binaries and variables was deactivated) in combination with the Drimmel extinction model.

The images above have been generated from GUMS v0. (Above): the Gaia HR diagram (at $G < 20$); (below) the stellar density up to $G = 20$.

Further details, including links to data files, are available on the [GaiaWiki page \(CU2: GUMS\)](#).

Images courtesy of X. Luri & C. Babusiaux

[Published: 02/08/2006]

Picture of the Week

Gaia Focal Plane



The Gaia focal plane, shown above, will be the largest focal plane ever developed for space applications, featuring in total almost 1 billion pixels. The focal plane assembly is common to both Gaia telescopes and is composed of five distinct areas:

- (i) the wave-front sensor, used to measure the optical quality of each telescope, and the basic angle monitor, used to monitor fluctuations in the basic angle;
- (ii) the Sky Mapper: objects entering the fields of view first pass across the sky mappers (ASM1 or ASM2). The sky mappers identify which telescope is viewing the object and are used to communicate details of the star transits to the subsequent CCDs;
- (iii) the main Astrometric Field, devoted to astrometric measurements. The astrometric field of the focal plane will be sampled by 62 CCD detectors, each read out in time-delayed integration mode synchronised to the scanning motion of the satellite;
- (iv) the Blue and Red Photometers, sampled by 14 CCDs serving Gaia's photometric instrument and providing low resolution spectrophotometric measurements for each object over the

wavelength range 330-680 nm (blue) and 650-1050 nm (red);

(v) the Radial Velocity Spectrograph, registering spectra of all objects brighter than about 17th magnitude with 12 CCDs.

The image above is available as a [powerpoint slide](#) which can also be printed as an A0 poster.

Further details are available in the [Information Sheet: The Gaia Focal Plane \(pdf format\)](#)

Image courtesy Alexander Short

[Published: 25/09/2006 | Updated: 20/07/2009]

Picture of the Week

Results from the AGIS system test campaign

Absolute error values - Cycle 513/Runid 950 - non-rotated

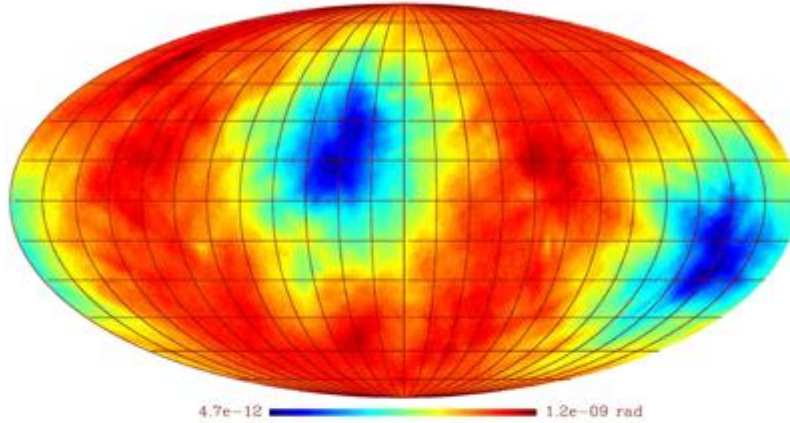

Absolute error values - Cycle 513/Runid 950 - rotated

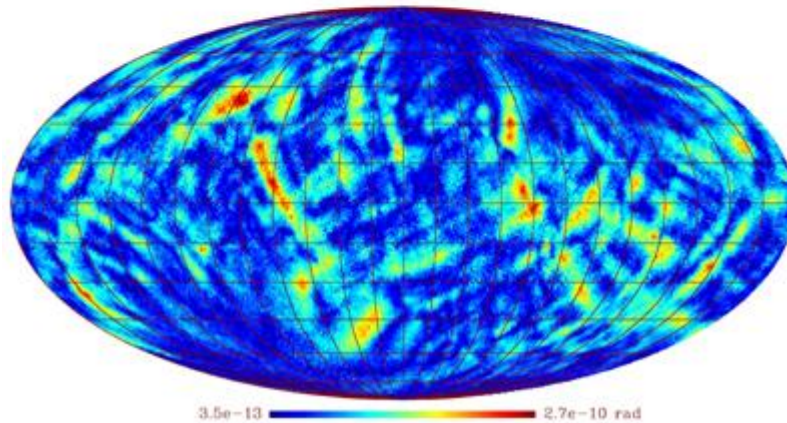

The Astrometric Global Iterative Solution (AGIS) system is being developed at ESAC in the framework of CU3. A first large-scale testing campaign using CU2-provided data covering 5 years of simulated observations of an artificial sky with 1.1 million uniformly distributed stars has recently been completed. Five distinct AGIS solutions were performed, with increasingly noisier initial values for the unknown astrometric source, attitude, and geometric calibration parameters and realistic errors for the elemental observation data.

The end results of the last - most realistic - solution are presented above. Both figures show the size of the average shift of the source positions over 1-square-degree bins on the sky, in the sense "AGIS solution minus true (artificial) sky". The plots are all-sky Mollweide projections in equatorial coordinates. The upper figure shows the positional errors in the original AGIS solution. The plot shows that the solution is rotated about a (purely accidental) axis, indicated by the blue spots, by an angle of about 200 microarcseconds. This is an expected manifestation of

the fact that any AGIS solution is unique only up to a rigid rotation of the AGIS-internal reference frame with respect to the true or simulated sky. The lower figure shows the residual errors after elimination of this irrelevant rotation.

The following conclusions can be drawn:

- The remaining zonal errors in the solution are smaller than the starting errors by more than three powers of ten. Thus, a strong convergence of the AGIS towards the correct solution has been demonstrated.
- This is a highly satisfactory result for the very first attempt under realistic conditions, i.e. starting from a conservative pre-launch knowledge of the sky, and very conservative initial errors in the attitude and calibration parameters.
- The remaining zonal errors of 20-50 microarcseconds are higher than what is ultimately aimed at; this needs to be investigated and improved.
- The errors of the individual star positions are according to expectations.

Further details can be found in [Results from CY01-C1 Testing Campaign of the Astrometric Global Iterative Solution System](#) (GAIA-C3-PR-ESAC-UL-023-1, available from Livelink).

Larger versions of the images are available here: [Upper figure](#), [Lower figure](#)

[Published 13/11/2006]

2007

- [12/17: DPAC cycles](#)
- ◄ [11/12: Thermal Vacuum Facility for FPA](#)
- ◄ [07/02: Gaia Payload](#)
- ◄ [06/11: Launch & Operations](#)
- ◄ [04/05: New e2v test facility](#)
- ◄ [02/26: The Ring Solution verified](#)

Picture of the Week

The Ring Solution verified

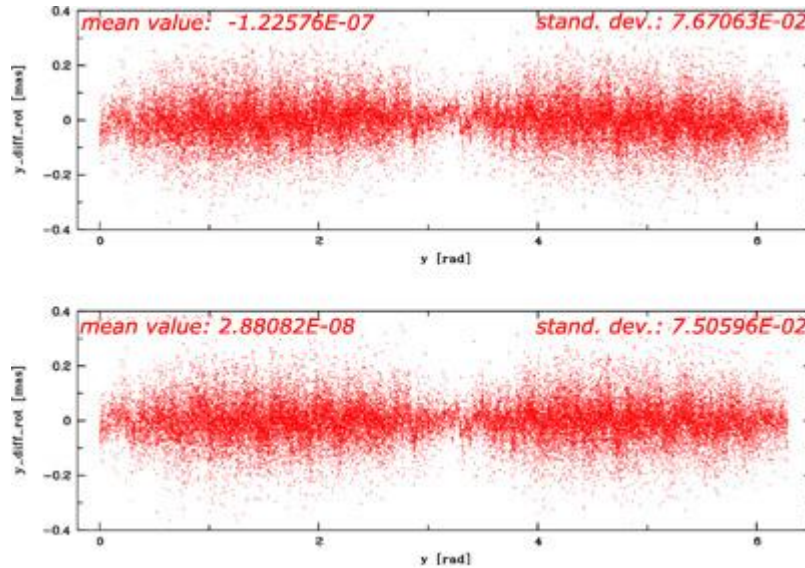

In order to reach the level of precision targetted by Gaia, many months of observational data must be incorporated into a global, complex data reduction process in order to perform a self-calibration of the satellite and subsequently to determine the astrometric and global parameters. Subtle malfunctions in the spacecraft or payload may impact on the measurement precision and instrument stability and hence degrade the final results. The 'First-Look' activity is designed to allow early identification of these types of effects, so that they can be corrected.

One of the major components of the First Look is the ODAS, the One-Day Astrometric Solution. Its goal is very similar to that of the AGIS (see [Picture of the week for 2006-01-23](#)) but limited to the observations of one single day. A first development step towards an ODAS was the 'ODIS' method, the 'One-day Iterative Solution', which like AGIS uses a block-iterative scheme to solve for the astrometric parameters (see [Picture of the week 2005-05-09](#)).

When the ODIS was used on noisy simulated observations and with realistic errors in the initial values for the unknown astrometric source, attitude, and calibration parameters, convergence was reached only after more than ten thousand iterations. For the longitude coordinates along the Reference Great Circle of the day (given in radians) the first diagram shows the final deviations of the source positions from their 'true' (i.e. those assumed in the simulations) values. Units for the differences are milliarcseconds.

The Ring Solution is a direct, non-iterative ODAS method. In contrast to the ODIS, the final solution is reached in one single step involving complex matrix algebra. The second diagram is the result of the Ring Solution. It is practically indistinguishable from the first one!

This means that two completely different numerical methods for the ODAS reached the same result - a very strong verification of both methods.

Besides being a direct method, the Ring Solution also allows a more in-depth investigation of the error budget. Therefore, only the Ring Solution method will be used for the ODAS in the future.

People involved at ARI/ZAH, Heidelberg: Hans Bernstein, Sonja Hirte, Helmut Lenhardt, Ulrich Bastian, Stefan Jordan

[A larger version of each of the two figures is available: [top image](#); [lower image](#)]

[Published 26/02/2007]

Picture of the Week

The new Gaia CCD test facilities at e2v



The new Gaia Test area at [e2v](#) is now fully commissioned. This new facility, built specifically for the testing of CCDs for Gaia, has been furnished with 5 test cameras. Each camera has a pump station for the pumping and cooling of 13 interchangeable cryostats. Each cryostat houses one Gaia CCD (CCD 91) and is installed in the test camera once the device is fully cooled, making maximum use of testing time and increasing the overall throughput of CCDs.

The image above shows four views of the clean room. Larger versions of the images are available here (clockwise from top-left): [image 1](#); [image 2](#); [image 3](#); [image 4](#).

Photographs courtesy of Peter Gillespie and [e2v](#).

[Published 05/04/2007]

Picture of the Week

Gaia Launch and Operations Overview

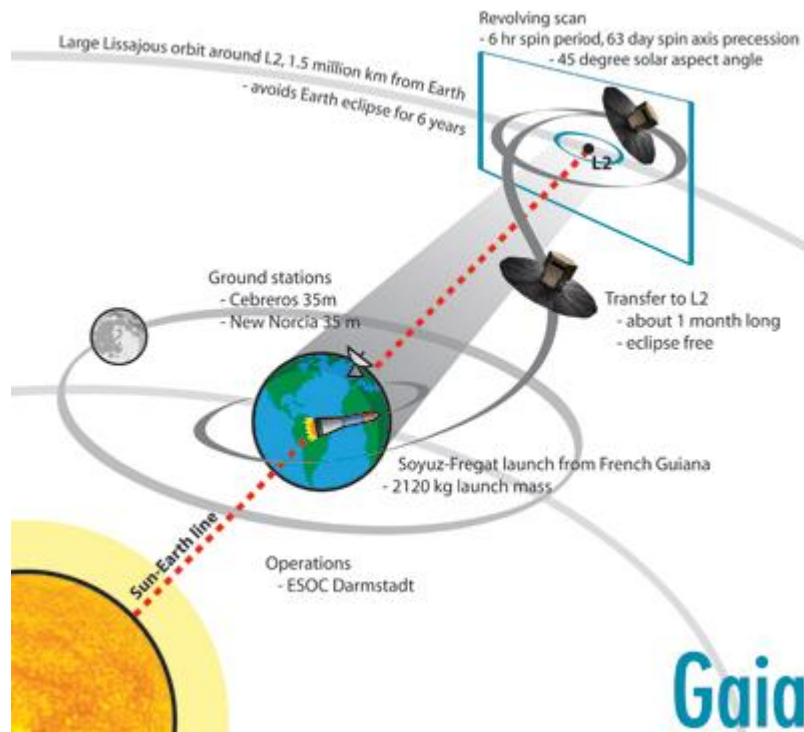

Gaia is scheduled to launch in late 2011 from Europe's spaceport in French Guiana. Following launch by a Soyuz-Fregat rocket, the Gaia satellite will spend a period of around one month in transit before arriving at the second Lagrange point of the Sun-Earth system. It is around this point, L2, which Gaia will be stationed in a large Lissajous orbit. Such positioning provides a very stable thermal environment and a moderate radiation environment, and allows the craft to avoid Earth eclipses for six years: five years of planned operational lifetime with the possibility of a further one year extension.

From its vantage point, Gaia will conduct its full-sky astrometric, photometric and spectroscopic survey. With a solar aspect angle of 45 degrees, Gaia will rotate once every six hours, with the spin axis itself precessing every 63 days. This revolving scanning law will allow Gaia's instruments to sweep the entire sky repeatedly, observing the billion celestial objects of its Galactic survey an average of 70 times each.

Data will be downlinked from the satellite to Gaia's ground stations at Cebreros, Spain and New Norcia, Australia, both of which employ 35-metre deep-space dish antennae. Mission operations will be carried out at the European Space Operations Centre at Darmstadt, Germany.

The graphic above shows the basic elements of Gaia's launch and operations in overview, as well

as giving an impression of where L2 and Gaia's Lissajous orbit are positioned with respect to the Sun and Earth. It is available in [jpg](#) and [tif](#) format in medium and high resolution.

Graphic © ESA; Source: EADS Astrium

[Published 11/06/2007]

Picture of the Week

Gaia Payload Animation

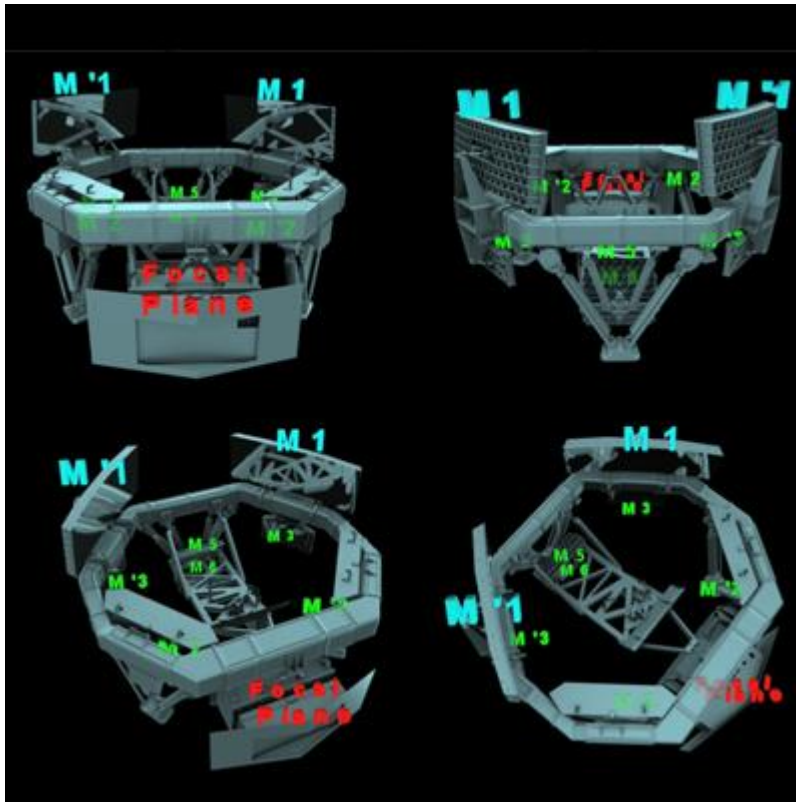

The image above contains extracts from an animation of a model of the Gaia payload. The animation displays the model from different angles, rotating the optical bench to show particularly how the mirrors and focal plane are positioned with respect to each other.

As can be seen in the animation, Gaia's payload concept features two telescopes sharing a common focal plane. With two viewing directions separated by a set angle (the Basic Angle), the telescopes 'look out' through windows in the payload's housing. Incoming light strikes the large primary mirrors M1 and M'1 and is then reflected by a series of further mirrors along a total focal length of 35m, with the two paths meeting at the M4/M'4 beam combiner before finally reaching the shared focal plane, a large mosaic of CCD detectors. Unlabeled in the animation, the beam combiner is found in the centre of the payload arrangement when viewed from above.

The focal plane itself is not directly visible in the animation, though the (CCD and electronics) radiators around it are. Also worthy of note are the basic angle monitoring devices which are atop the optical bench opposite the two primary mirrors.

The animation can be download from [here](#). [Published 02/07/2007]

Picture of the Week

New Thermal Vacuum Test Facility for FPA at EADS Astrium, Toulouse



A new thermal vacuum facility dedicated to testing the Gaia Focal Plane Assembly is being installed at EADS Astrium Toulouse. The main chamber has an internal diameter of 4 m and weighs 9 tonnes. It is evacuated by 2 primary pumps and 3 turbomolecular pumps. Cooling is achieved through 4 thermal shrouds using a mix of gas and liquid nitrogen. The facility is provided by a number of sub-contractors under the leadership of Intespace. This facility shall be used to validate the thermal design and the electro-optical performances of the focal plane through an Engineering Model and Proto-Flight Model. Subsequent thermal vacuum tests will be conducted at Payload Module level. Installation of the FPA thermal vacuum facility formally ends with a Test Readiness Review (TRR) on the 15th of November.

Images courtesy of EADS Astrium

High resolution images: main chamber during installation at EADS Astrium Toulouse ([jpg, 74k](#)); base of chamber ([jpg, 51k](#)); transport of chamber ([jpg, 43k](#)).

[Published 12/11/2007]

Picture of the Week

DPAC cycles - origin of the names

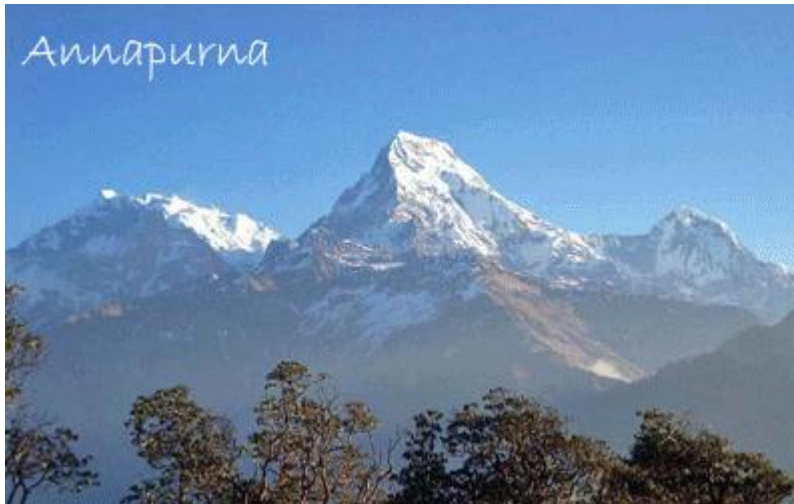

The Gaia [Data Processing and Analysis Consortium](#) (DPAC) has adopted a development approach in which software is incrementally built in cycles of 6 month duration. In order to give each one a unique identity the 10 cycles covering the time span from mid-2006 to the planned launch of Gaia in 2011 have been named after the 10 highest mountains in the world in increasing order of their altitude. After a first year of development in cycles Annapurna (8091m) and Nanga Parbat (8125m), DPAC recently finished its third cycle Manaslu (8163m) and commenced the Dhaulagiri (8167m) cycle which is ongoing until the end of May next year. Apart from prominently marking the foreseen end of all pre-launch development activities in 2011, the name of the last cycle also has another special significance: The Tibetan name of Mount Everest (8850m) is *Chomolungma* which translates to 'Goddess Mother of the Earth' coinciding with the original meaning of the word Gaia from Greek mythology.

Image sources:

Annapurna: [Søren Viit Nielsen](#); Nanga Parbat: [MountainsoftheWorld.info](#); Manaslu: [Richard SG](#); Dhaulagiri: [Jamie O'Shaughnessy](#); Cho Oyu: [Uwe Gille](#); Makalu: [Nelson](#); Lhotse: [Lee Chai](#); Kangchenjunga: [Siegmond Stiehler](#); K2: [John Canivley](#); Everest: [Pavel Novak](#).

[Published 17/12/2007]

2008

12/05: CCD Support Structure
▸ 10/21: RVS Fery Prism Breadboard
▸ 10/07: Discrete Source Classifier
▸ 09/23: Standard stars for RVS
▸ 09/09: MareNostrum
▸ 07/25: Wavefront Sensor
▸ 07/09: Sky-like mask
▸ 06/25: Data Compression Study
▸ 06/11: Video Processing Unit
▸ 05/22: New CCD test bench
▸ 04/25: WMAP and Gaia
▸ 03/10: New AGIS results
▸ 02/18: M5 mirror
▸ 02/04: PLM torus
▸ 01/21: Solar Cycle 24

Picture of the Week

Solar Cycle 24

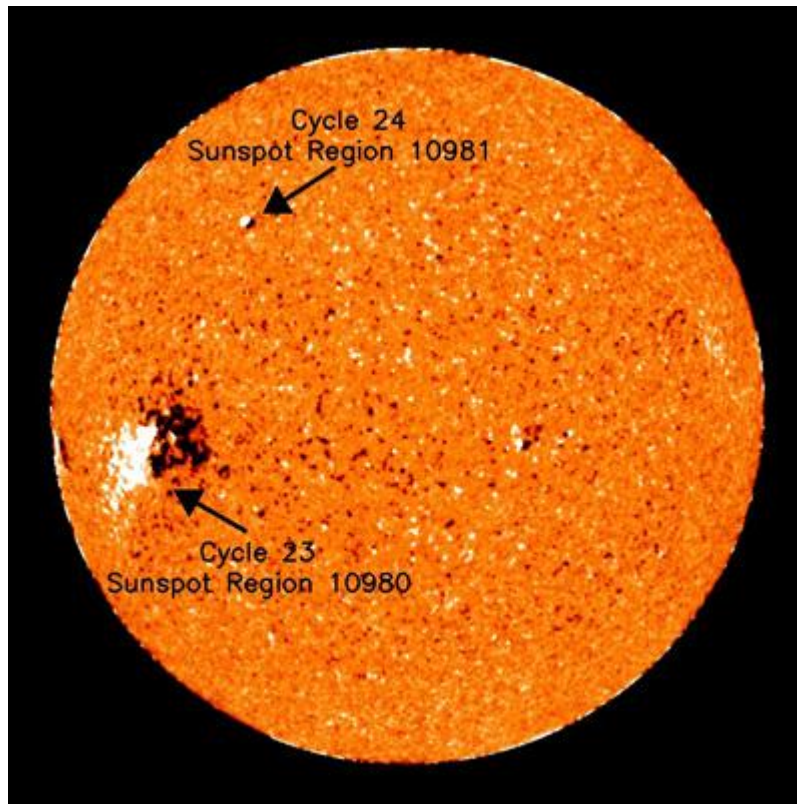

The start of Solar Cycle 24 was heralded by the appearance of sunspot 10981 on January 3, 2008. The high-latitude location of the sunspot and its magnetic polarity (opposite to that of its predecessors) are considered by NOAA experts to be clear-cut signs of a new solar cycle. In April 2007, NOAA, in coordination with an international panel of solar experts, issued a forecast for solar cycle 24 predicting that it would start in March of this year (plus or minus 6 months). The panel members were split on the issues of the strength and timing of cycle 24, with some members favouring a strong cycle peaking in late 2011, and others predicting a weak cycle peaking in mid-2012. Both sides agree that the sooner the new cycle takes over from the previous one, the stronger cycle 24 is likely to be.

The severity and timing of solar cycle 24 are particularly important for Gaia because the potential for the mission to reach its scientific requirements will be adversely affected following each solar outburst event. This is because solar protons cause irreversible damage to the focal plane CCD detectors which results in degradation of the centroiding and charge transfer performance for the remainder of the mission.

Image credit: NOAA [Published: 21/01/2008]

Picture of the Week

PLM torus testing



This image shows the static proof test of a representative scale 1 model of a single PLM torus joint. The PLM torus is the main structural element of the Gaia payload and consists of 17 ceramic tube elements connected by these braze joints. Tube sections and joints were all successfully qualified during a test campaign in November 2007.

Image credit: Matthias Erdmann. Published with permission of EADS Astrium. (High resolution image also available [here](#).)

[Published: 04/02/2008]

Picture of the Week

M5 mirror



The image above shows the second M5 mirror blank during its final inspection. Two of these flat mirror elements are installed in the Gaia telescopes optical system. The blank is constructed from Silicon-Carbide, is 540mmx340mm and weighs only 6 kg.

Image credit: Matthias Erdmann. Published with permission of EADS Astrium. (High resolution image also available [here.](#))

[Published: 18/02/2008]

Picture of the Week

Strong improvement in AGIS results

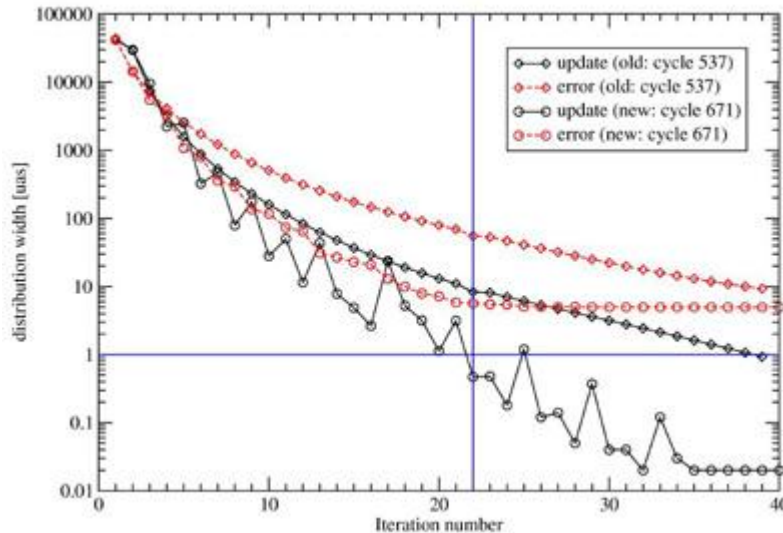

The Astrometric Global Iterative Solution (AGIS) system is being developed in the framework of CU3 at ESAC and Lund Observatory. A previous picture of the week (see [Results from the AGIS system test campaign, 13/11/2006](#)) illustrated some first good results obtained by starting AGIS with very conservative initial errors in the unknown source, attitude and calibration parameters using simulated observation data from an artificial sky with 1 million uniformly distributed stars. With the chosen initial level of noise (50 mas Gaussian plus systematic variation with amplitudes of a few 10 mas) a normal AGIS cycle takes about 40 iterations to reach the provisional convergence criterion: width of parallax update distribution becomes smaller than 1 microarcseconds.

The technical note [GAIA-C3-TN-LU-LL-074](#) proposes a scheme to accelerate the convergence of AGIS by extrapolating the update in every second iteration through a computed factor $\omega > 1$. This has recently been implemented in AGIS and a number of first test cycles were successfully run. The figure depicts the typical size of parallax updates (black solid curves) and remaining errors of the parallaxes (red dashed curves; these can be computed strictly, because we know the "true" values from the simulations) for two complete AGIS cycles (labelled "537" and "671") on the same 1-million-stars data set (named "GASS-LSS-1-F"), as a function of iteration number, in the old (diamond markers) and in the new accelerated case (circle markers). Unit "uas" means microarcseconds.

The following conclusions can be drawn:

- In the accelerated cycle the convergence criterion (blue horizontal line) is fulfilled already after iteration 22 (blue vertical line), compared to iteration 39 in the old cycle.
- The error level reached after 22 iterations in the accelerated case (5.64 microarcseconds)

is almost a factor 10 lower than in the non-accelerated one (55.41 microarcseconds). Even when compared to the last executed iteration 39 of the old scheme (9.31 microarcseconds), the improvement is still almost a factor 2.

- Considering the conservative starting condition the convergence process has reduced the errors by more than three powers of ten. The end result is close to the goal of achieving residual astrometric errors that are fully consistent with the observation noise and demonstrates that even with only one million stars the accelerated AGIS can get at least 100 times better than the Hipparcos solution.
- In addition, spatially resolved error maps show that the systematic spatial patterns of errors seen in all previous AGIS cycles (see [Results from the AGIS system test campaign, 13/11/2006](#)) have largely vanished. They are on the level of one microarcsecond now.

The next step will be a formal comparison of the remaining errors with the theoretically achievable level, taking into account the simulated observation noise. First estimates indicate an almost perfect agreement.

[Published: 10/03/2008]

Picture of the Week

NASA's WMAP "poses" for ESA's Gaia



On April 5, Sebastien Bouquillon ([SYRTE/Obs. de Paris](#)), Ricky Smart ([INAF/OATo](#), Torino) and Alexandre Andrei ([Observatorio Nacional](#), Rio de Janeiro) used the 2.2m telescope of the European Southern Observatory at La Silla, Chile, to take some photographs of NASA's Wilkinson Microwave Anisotropy Probe ([WMAP](#)) satellite in its orbit, which is about 1.5 million kilometers from Earth. Perhaps surprisingly, they did so as part of the preparations for ESA's Gaia mission, which scientifically is totally unrelated to WMAP.

The background is the following: The correct scientific evaluation of Gaia's position measurements makes it necessary that the absolute velocity of the spacecraft with respect to the solar-system barycentre must be known to 2.5 mm/sec, i.e. to one part in 10 million, and the absolute position to 150 meters, i.e. to one part in a billion. This tremendous requirement cannot be satisfied by the usual satellite tracking techniques using their own radio signals, at least not for all times in the five-year science mission. It can be done, however, if sunlight reflected from the spacecraft is used for direct position measurements of the spacecraft on the sky. In orbit, Gaia will appear as a very faint speck of light, moving slowly among the distant background stars. This so-called ground-based optical tracking of Gaia was proposed by U. Bastian ([ARI](#), Heidelberg) a few years ago. Martin Altmann (also at ARI, Heidelberg) will be in charge of organizing and coordinating the ground-based optical tracking of Gaia in the years 2012 to 2017. He will need the support of quite a number of observers and observatories for this purpose.

What has all this to do with NASA's WMAP? Well, the concept must of course be tested. Like WMAP, Gaia will be located at the Earth-Sun Lagrange point L2, about 1.5 million kilometers from Earth. Like Gaia, WMAP has a deployable sunshield, partly covered with insulation

material and partly with solar panels. The Gaia shield is about 11 meters in diameter and inclined by 45 degrees to the sun direction, that of WMAP is about 4.5 meters and inclined by 22.5 degrees. With all these parameters, WMAP is a reasonable (photo-)model for the brightness and observability of Gaia. If the sunshield materials were strictly the same, and the proportion of insulation and solar panel areas similar, WMAP could be expected to be roughly 1.5-2 magnitudes fainter than Gaia. The actual brightness difference is still uncertain to some degree, however.

The above picture shows WMAP flying past the stellar background. Three images taken at time intervals of a few minutes were added up to create this composite frame. Before superposition, the three images (actually black-and-white images) were artificially coloured red, green and blue. For the stars, these three colours added up to neutral white. In contrast, the WMAP satellite shows up as the string of coloured points - since it is the only object having moved between the times the three images were taken. In addition to WMAP and a number of stars, a faint galaxy is visible as a slightly fuzzy blob at top center of the picture.

Thanks from our team go to Dale Fink, Navigator of WMAP Spacecraft Control Team, for his specially supplied orbital ephemeris of WMAP.

Technical info: The exposures were 60 seconds each in the V band. Alexandre Andrei got a preliminary brightness of $V=19.4$ for WMAP, using the IRAF software, calibrating with 5 [UCAC-2](#) stars, and applying a R-to-V magnitude correction. The WMAP ephemeris predicted an apparent magnitude for La Silla, at the time of observation, of $V=18.7$.

[Published: 25/04/2008]

Picture of the Week

New CCD optical test bench

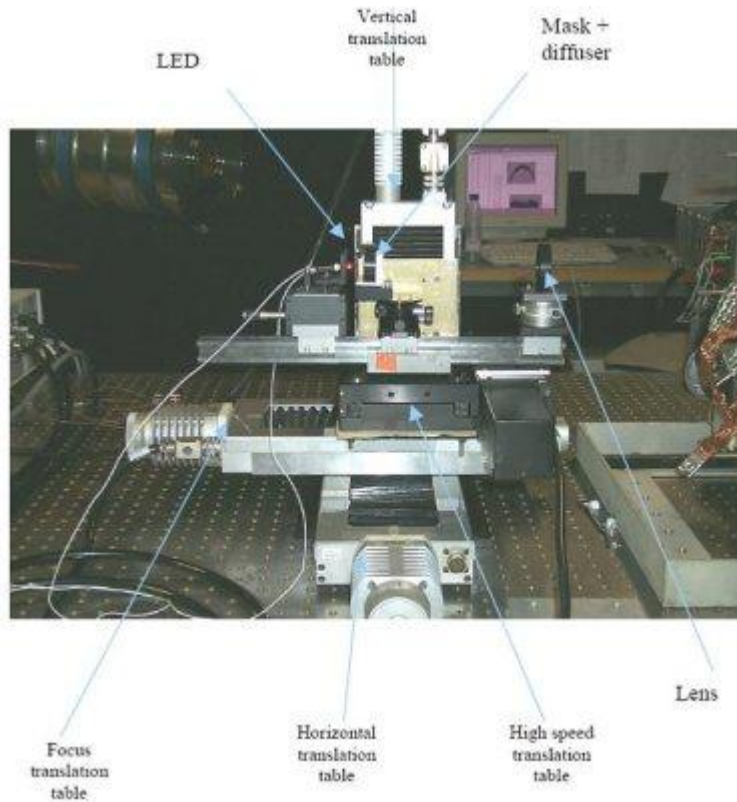

EADS Astrium are currently commissioning a new CCD optical test bench. The facility includes a translation stage which allows optical sources to be driven across the CCD field of view simulating the motion of Gaia sources due to the rotation of the satellite. In this way, the CCDs may be tested on the ground in the same Time Delay & Integration (TDI) modes that will be employed in orbit. This is essential since many aspects of CCD performance depend upon the operating mode. This is the second such TDI facility built by Astrium for Gaia. It will be dedicated to future radiation testing and incorporates several modifications compared with the first facility, including a new optical configuration and liquid nitrogen cooling to reduce vibration. New optical masks are being designed to simulate dispersed Photometer sources and RVS spectra as well as a 1000 star "sky-like" Astrometric pattern. Following facility commissioning, a comprehensive [radiation test campaign](#) has been planned for most of 2008.

Picture courtesy of EADS Astrium. (Higher resolution image also available [here](#)).

[Published: 22/05/2008]

Picture of the Week

Video Processing Unit

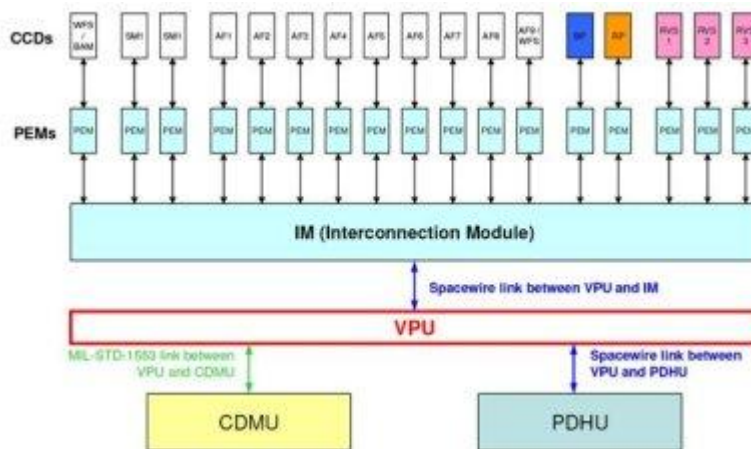

Gaia's Video Processing Units (VPUs) represent the brain of the spacecraft. Gaia will contain 7 VPUs, each connected to a row of CCDs via an Interconnection Module (IM). The CCDs provide raw star data to the VPU, which is analysed and compressed before being passed to the Payload Data Handling Unit (PDHU) for transmission to the ground. Each VPU is responsible for managing its own CCDs and collecting the pixel data from them. Command and monitoring of the VPU is performed by the Control and Data Management Unit (CDMU).

The data from the SM CCDs (the first CCDs in a row) is processed in real time by the VPU to detect objects. This information is used to identify areas of interest (windows) within the following CCDs and hence to derive commands to the other CCDs in the focal plane to output the corresponding data to the VPU. When all information about an object has been obtained, a star packet is built, compressed, and output to the PDHU. Whilst doing this processing, data about the object velocity is passed to the CDMU. This information is used by the AOCS system to refine the attitude control. The VPU uses the on-board-clock information supplied by the Clock Distribution Unit (CDU) to time tag information and remain in synchronisation with other equipment. The CDMU interface allows parameters to be uploaded, the mode of operation to be changed and housekeeping telemetry to be output. One feature of the VPU is that some of the algorithms can be enhanced and modified in flight.

Figure courtesy of EADS Astrium UK. (Higher resolution image also available [here](#)).

[Published: 11/06/2008]

Picture of the Week

Data Compression Study

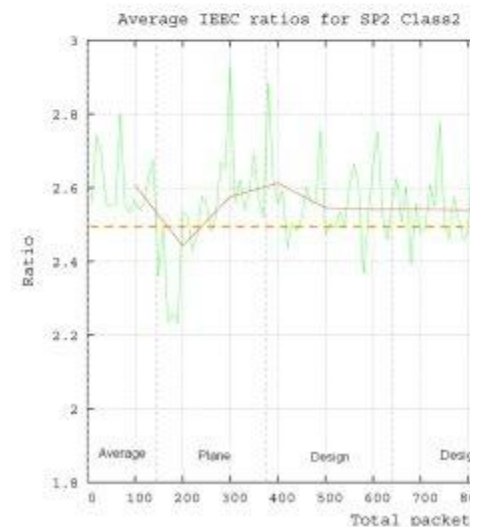
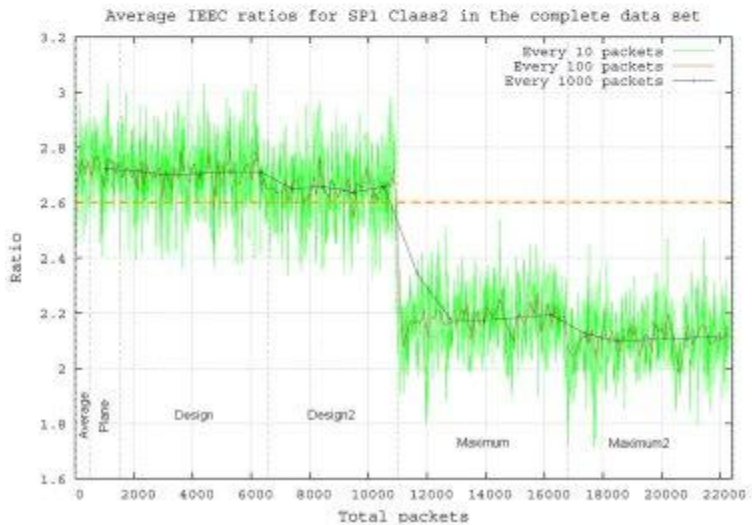
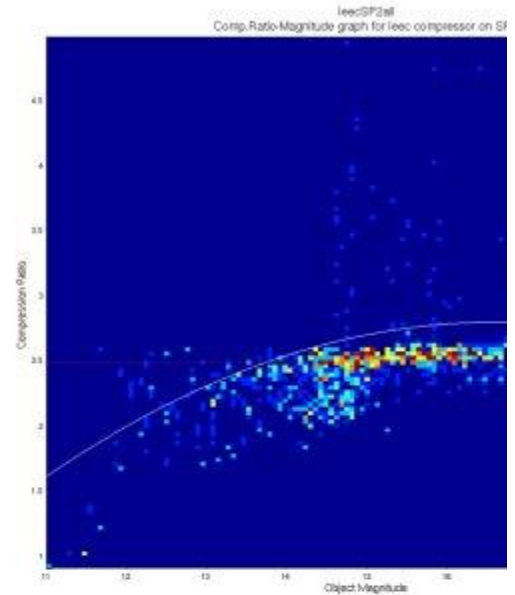
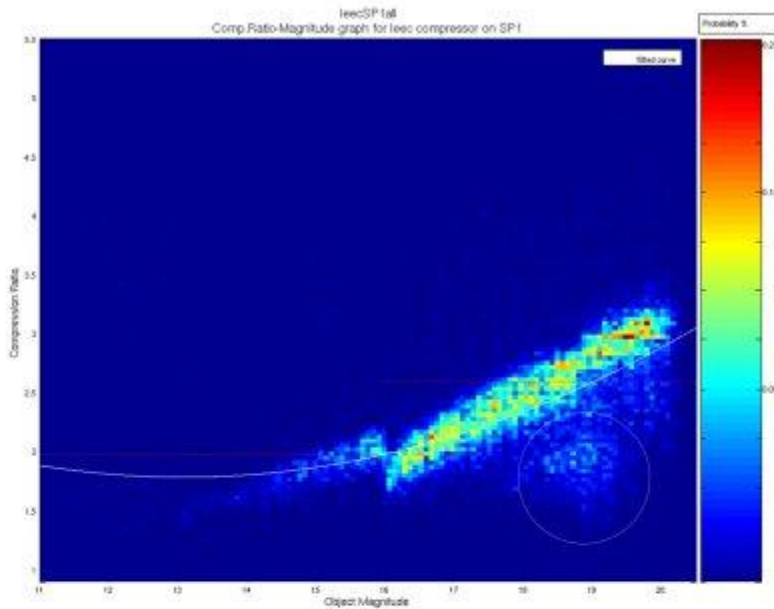

The complex and large data set generated by the Gaia focal plane, consisting of astrometric, photometric and spectroscopic data, must be compressed without losses before being stored to the PDHU for its later transmission down to the Ground Station. This task will be carried out by the [Video Processing Units \(VPU\)](#).

Although [preliminary studies](#) indicated very promising results in this critical aspect of the mission, no detailed and realistic enough analysis was carried out yet for the data compression of

Gaia. The Institute for Space Studies of Catalonia (IEEC), with the Spanish software company GTD as prime contractor, made a deep study of the problem at the request of ESA.

The Gaia Optimum Compression Algorithm (GOCA) TRP Study was successfully finished in January this year. Left panels illustrate the ratios achieved for SP1 packets, containing SM, AF and BP/RP data. The required compression ratio for these packets was 2.6 for faint stars, which is fulfilled in the most typical scenarios. The top figure clearly illustrates the dependence of the ratios on the star magnitude. A small group of "problematic packets" is circled in white, corresponding to truncated packets and to packets without BP/RP, most of which are generated when observing extremely dense areas.

Right panels illustrate the same results for SP2 (RVS) packets, where a required compression ratio of 2.5 is fulfilled as well. The dependence on the star magnitude is not so important in this case. The reason is the high amount of relative noise in the RVS measurements, which fixes a minimum entropy and hence a maximum achievable ratio. A clever pre-processing stage, including an adequate filtering, enables to take advantage of any redundancy in the data.

GOCA was successfully integrated with the rest of video algorithms and tested on a VPU prototype board, at EADS/Astrium premises in Toulouse, where less than 10% of the CPU was used in the worst of the cases (1400 SP1 plus 60 SP2 per second and per VPU). A completely lossless operation was also verified.

Some of the concepts developed during this study have been included in the [final data compression algorithms](#) developed by EADS/Astrium.

Images courtesy of the GOCA-IEEC team (Jordi Portell, Alberto G. Villafranca and Enrique García-Berro).

[A larger version of each of the four figures is available: [top left image](#); [top right image](#); [lower left image](#); [lower right image](#)]

[Published: 25/06/2008]

Picture of the Week

Sky-like mask artist view

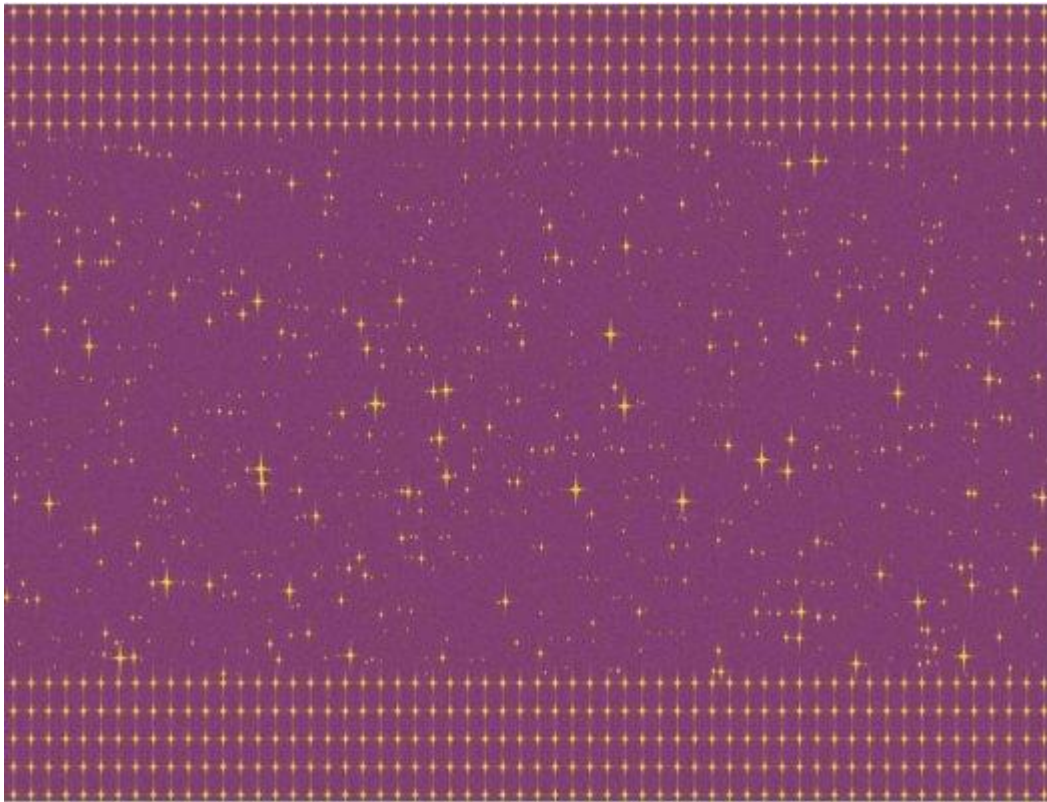

The image shows the Gaia astrometric "sky-like" mask which will be used during "Radiation test campaign #3". The mask is designed to emulate a scene that Gaia could encounter in a dense area of the sky. Approximately 1000, randomly positioned stars are simulated by projecting pin-holes onto the CCD. Source density at the CCD is equivalent to about 650,000 stars/deg². More than 7 magnitudes of source brightness have been covered by varying the size of the pin-holes. Absolute values are adjustable over a wider range by varying the LED brightness.

The effects of radiation induced trapping on CCD data are rather complicated. There can be a large degree of variability or uncertainty related to the occupancy or state of the traps which in turn depends upon recent charge history. Previous radiation testing has been aimed at isolating one or two of these dependencies in a way which is not very representative of Gaia observations. The objectives of these next tests are to:

1. Generate more realistic Gaia-like data combining several dependencies for the first time. Analysis of these data is expected to give a better indication of the potential performance of Gaia.
2. To help establish the optimum means of mitigation against radiation effects. Gaia-like

data will be acquired using several different charge injection strategies and frequencies.

These tests were proposed by the radiation calibration working group in October 2006. The mask has been manufactured by Astrium and the test plan is available on [Livelihood](#).

Image courtesy of EADS/Astrium

[A larger version of this image is available in the following [link](#)]

[Published: 09/07/2008]

Picture of the Week

Qualification Model of the Gaia Wavefront Sensor



The picture above shows the Qualification Model of the Gaia Wavefront Sensor.

The WFS system will be used to monitor the wave front errors of the two Gaia telescopes mounted on the Gaia satellite. Such system must have low optical aberrations itself. Gaia will operate over a broad wavelength and in cryogenic conditions (450 to 900 nm wavelength band and 130 to 200 K operation temperature). For these boundary conditions a temperature independent solution of Invar is selected, with fused silica optics, with the least number of dispersive elements in the design.

The telescope images the stars on the Focal Plane Array (FPA). The WFS picks up a small part of this field and images the telescope pupils on a Micro Lens Array (MLA) from where each micro lens images part of the pupil on the same FPA.

Monitoring the spot positions on the FPA array is the basic measurement of the wave front quality of the telescope of Gaia (for that field of view). The spot positions of a star can be compared to the spot positions of three calibration sources that are included in the WFS. This comparison is according the "Shack Hartmann" principle.

At this moment TNO is working to get the measurement system (OGSE) within specification before starting the qualification campaign of the QM model. The OGSE should have an accuracy even higher then the WFS itself.

Image courtesy of TNO/Leo Ploeg

[A larger version of this image is available in the following [link](#)]

[Published: 25/07/2008]

Picture of the Week

MareNostrum



The MareNostrum supercomputer, hosted at the BSC-CNS in Barcelona, is one of the most powerful supercomputers in Europe and the number 26 in the world, according to the June 2008 [Top500 list](#). It is composed of 10240 CPUs with a peak total capacity of 94.21 Teraflops (94.21 trillions of operations per second), 280TB of disk storage and 26TB RAM. It has been installed in the chapel of "Torre Girona", formerly the residence of a wealthy Barcelona family and now part of the UPC, the Technical University of Catalonia.

The MareNostrum is used by leading scientific teams to carry on diverse complex calculations and, in particular, the Gaia team at the Universitat de Barcelona is one of its regular users. The MareNostrum is being presently used to generate large simulations of the mission data that allow the test and validation of the data processing system being built by DPAC and will be used in the future to run the Iterative Data Update (IDU), one of the most computationally challenging tasks of the Gaia data reduction.

Images credit: Barcelona Supercomputing Center - BSC.

[A larger version of each picture is available: [left image](#); [right image](#)]

[Published: 09/09/2008]

Picture of the Week

Standard stars for the Gaia RVS

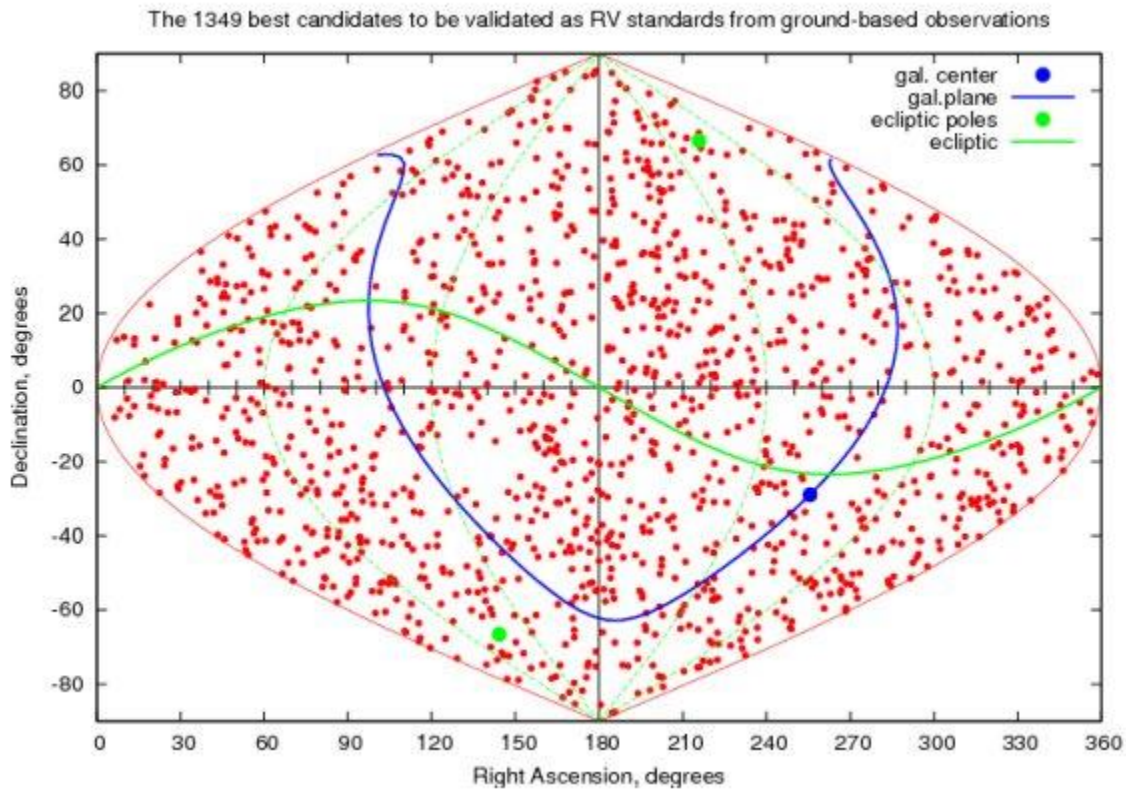

The Gaia Radial Velocity Spectrometer (RVS) is an integral-field spectrometer. Each star produces a small spectrum in the 2D focal plane, almost like within the older objective-prism systems. Due to technical reasons (weight, available space...), NO RV calibration device, such as a lamp or an absorption cell, is included in the spacecraft.

Therefore, even if the iterative reduction process, with all stars related together, makes the RVS a self-calibrating instrument, it still needs an "absolute" reference for the zero point and to initiate the process. This reference is best made with a set of bright, stable, well-known objects, evenly distributed on the sky : stars and asteroids.

Bright asteroids are excellent calibrators because their absolute radial velocity can be calculated with an extremely high accuracy; but they are not numerous enough, and are located in the vicinity of ecliptic; several effects have to be taken into account, such as transformation of "spectroscopic" RV to "kinematic" RV, shape, phase, rotational velocity... They will be completed with a grid of some 1000 stars, stable at the level of 300 m/s during the mission.

The RV reference stars are selected in 3 catalogues of radial velocities (Nidever et al. 2002, Nordström et al. 2004, Famaey et al. 2005) following the constraints given by simulations and

technical limitations ($V_{\text{mag}} \geq 6$, $G_{\text{rvs}} \leq 10$, spectral type later than F5, single, not variable, without neighbours that might produce a disturbing superposed spectrum whatever the scanning direction).

Each candidate is observed at least once before launch to eliminate evident variables. Supplementary observations are made, depending on the observational history of the star, and for follow-up during the mission. Observations of IAU RV standards and asteroids are also made to fix the zero point of the RV scale, and to validate the method of calibration with asteroids. The observing programme is running on the echelle spectrographs SOPHIE at OHP, NARVAL at TBL (Pic du Midi) and CORALIE on the Swiss Euler telescope at La Silla, for a total of about 9 nights per semester. The observations started in 2006 at OHP. The new data are stored in an on-purpose database, presently developed and hosted at AIP-Potsdam.

Left figure shows the sky distribution of the provisional basic stellar list; stars are still missing in some dense areas, mainly along the galactic plane. Right figure shows the Telescope Bernard Lyot (Pic du Midi); its new NARVAL spectrometer is the only one covering the RVS spectral range, and these spectra will therefore also be used for comparing the RVs obtained either over the full spectral range, or only the RVS range.

For questions you may contact: [Francoise Crifo](#), [Gerard Jasniewicz](#), [Caroline Soubiran](#).

More details can be found on the Gaia Livelink, CU6 folder, DU 640:

- SRS cycle 4 ([GAIA-C6-SP-UM2-GJ-001-04](#)), by: G. Jasniewicz, F. Crifo, D. Hestroffer, A. Jean-Antoine-Piccolo, A. Siebert, C. Soubiran;
- SDD cycle 3 ([GAIA-C6-SP-UM2-GJ-002-1](#)), by: G. Jasniewicz, F. Crifo, D. Katz, A. Siebert, C. Soubiran;
- SDD cycle 5, in preparation: G. Jasniewicz, F. Crifo, A. Guerrier, D. Hestroffer, A. Jean-Antoine-Piccolo, D. Katz, H. Ludwig, A. Siebert, C. Soubiran, L. Veltz, S. Udry.

Images courtesy of F. Crifo (map) and C. Soubiran (TBL picture).

[A larger version of each image is available: [left image](#); [right image](#)]

[Published: 23/09/2008]

Picture of the Week

Discrete Source Classifier

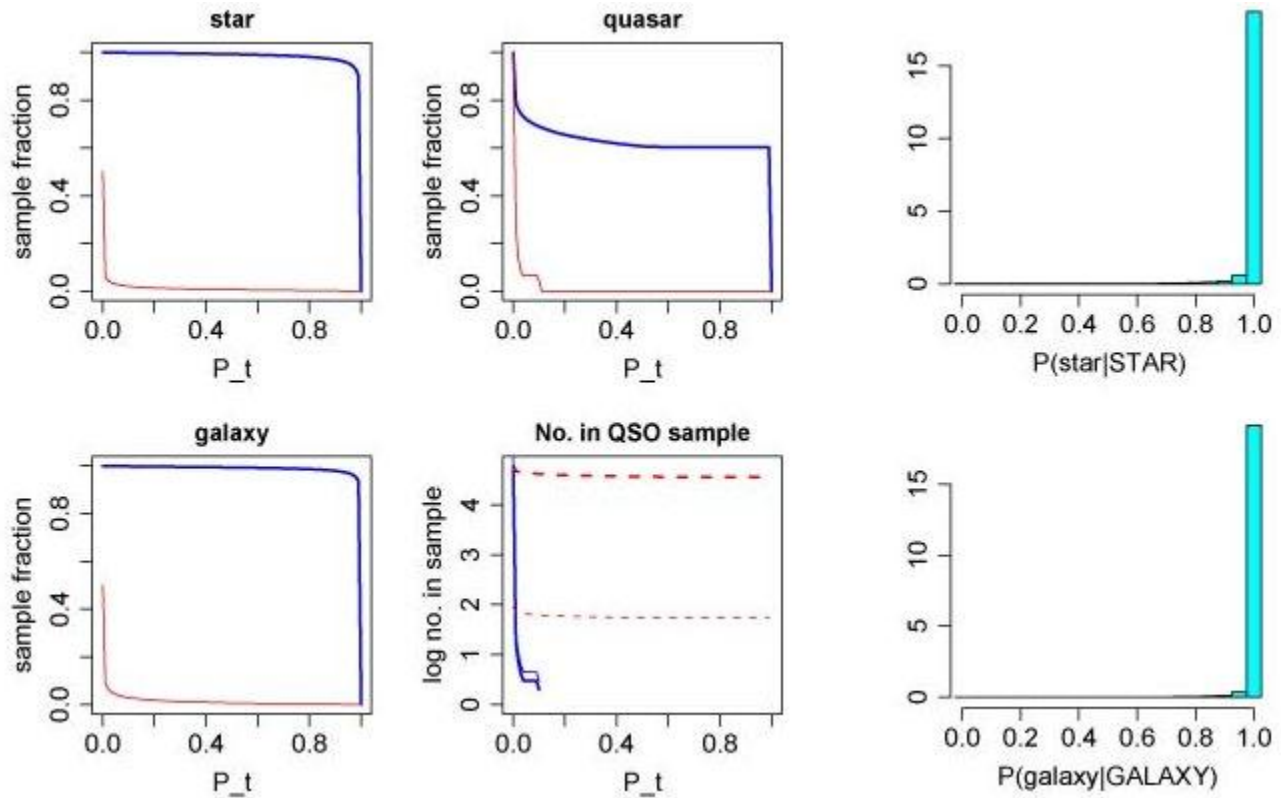

The Discrete Source Classifier (DSC) is the data processing module responsible for classifying all the objects which Gaia detects. As the name suggests, it assigns objects to discrete classes, e.g. star, galaxy, quasar, binary star, in each case it assigning a class probability. Classification is based primarily on the low resolution BP/RP spectra, because (initially at least) there is no morphological information from Gaia. The subsequent stages in the CU8 data processing are concerned with extracting physical parameters for these classes (e.g. stellar temperatures) and classifying the RVS spectra. DSC is based on machine learning methods for pattern recognition, currently a so-called "Support Vector Machine".

One of the challenges of Gaia is to reliably classify rare objects, e.g. the expected half million quasars among one thousand million stars. Standard methods for machine learning will often fail to identify them. To address this, the DSC team has developed a method for modifying the output probabilities to accommodate rarity, and applied this in classification experiments on simulated data. The left-hand figure (plots) shows, for three classes of objects, the completeness (blue line) and contamination (red line) of a sample of objects as a function of adjustable probability thresholds used to build the sample. We see that we can achieve a zero contamination sample of quasars which still has a completeness of 65%, more than sufficient for Gaia. The corresponding probability outputs from the DSC are shown in the right-hand panel (histograms).

With this method we can control the class priors, which allows a single classification model to be applied to any target population without having to tune the training data and retrain the model.

More details of the method and DSC itself can be found in a paper in press at MNRAS and available at [astro-ph web page](#).

[A larger version of each image is available: [plots](#); [histograms](#)]

[Published: 07/10/2008]

Picture of the Week

RVS Fery Prism Breadboard

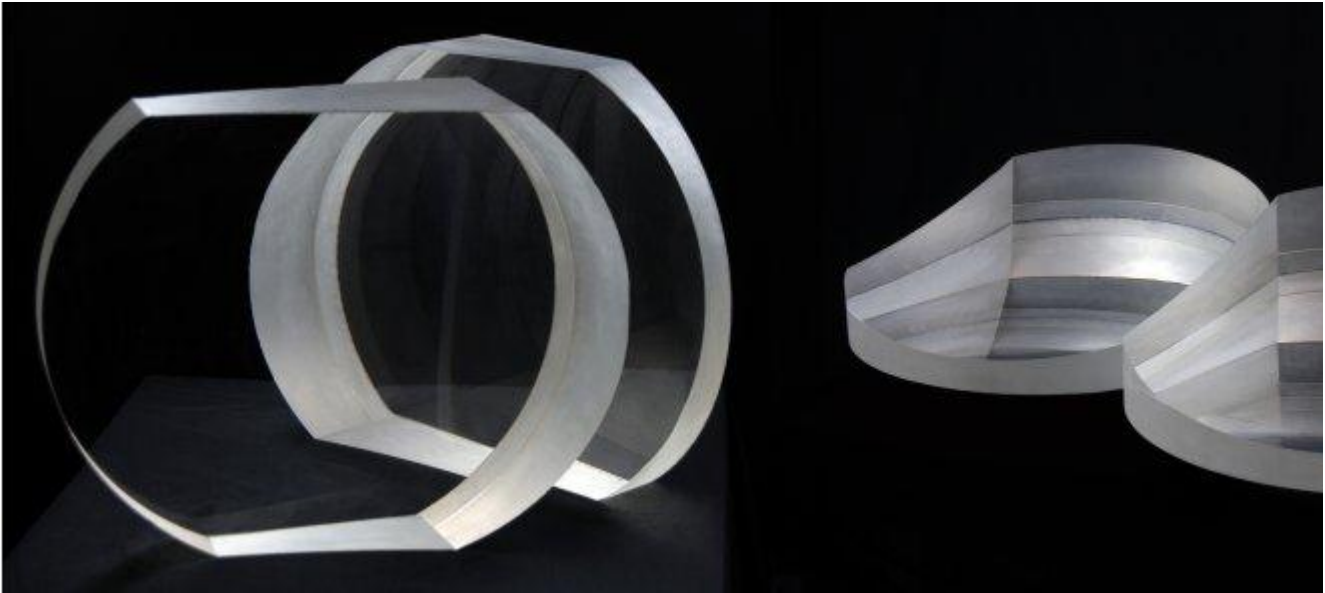

The RVS Instrument is a spectrometer. It will in particular measure the radial velocities of about 250 million stars in the Galaxy. The velocity is measured by the Doppler shift of the spectral lines, mainly relying on the Calcium lines in the faintest stars.

In order to obtain accurate measurements of the star spectra, there are four prisms and a diffraction grating in RVS. Their function is to disperse the spectrum on the Gaia CCD detectors in the focal plane.

The RVS prisms are Fery prisms. These are particular prisms because of their spherical shapes on the wedged faces. These are needed to focus the optical light rays of the large Gaia telescope onto the focal plane.

Bread-board prisms have been manufactured. This bread-board is used to assess the optical quality reachable for such a rarely manufactured component. The technological challenges were:

- the dimension (almost half A4 sheet)
- the accuracy of the sphere on accurately wedged faces of the prism

In the pictures, two full scale Breadboards are shown just before the final cut into the rectangular-shape phase.

Bread-boards have been realised by Selex Galileo, in the plant of Florence, under a contract with the Gaia prime contractor (EADS/Astrium, France).

Images courtesy of Luigi Mazza, Selex Galileo.

[A larger version of each picture is available: [left image](#); [right image](#)]

[Published: 21/10/2008]

Picture of the Week

The Gaia CCD Support Structure flight model

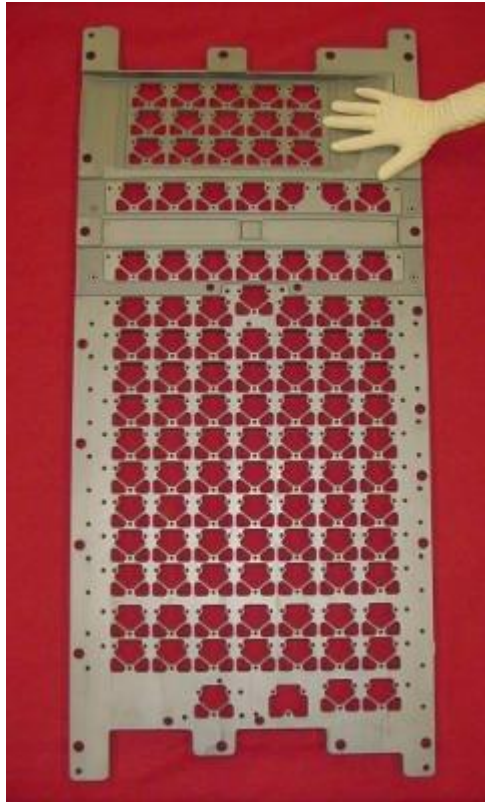

The image above shows the Gaia CCD Support Structure flight model. The structure will accommodate all [106 Gaia CCDs](#) and two [Wave Front Sensor](#) optical assemblies. The structure is made of Silicon-Carbide (SiC) which guarantees an extreme thermal and mechanical stability.

Image courtesy of Boostec/Michel Bougoin. (High resolution image also available [here](#).)

[Published: 05/12/2008]

2009

12/17: Soyuz launch pad
◄ 11/27: M2 mirror
◄ 10/23: BAM OMA mirror
◄ 09/30: SVN reached the 100000 commit
◄ 06/19: Plasma Jet Machining on mirrors
◄ 06/03: Gaia Torus Segments
◄ 05/15: Variability tree
◄ 04/21: Siblings of the Sun
◄ 03/27: CTI Effects Models for Gaia
◄ 03/11: Global astrometric solution
◄ 02/24: Combining Geneva with Hipparcos
◄ 02/10: BAM OMA mirror type A
◄ 01/27: Astrophysical parameter estimation with Ilium
◄ 01/08: Bulge with Gaia

Picture of the Week

The Galactic Bulge with Gaia

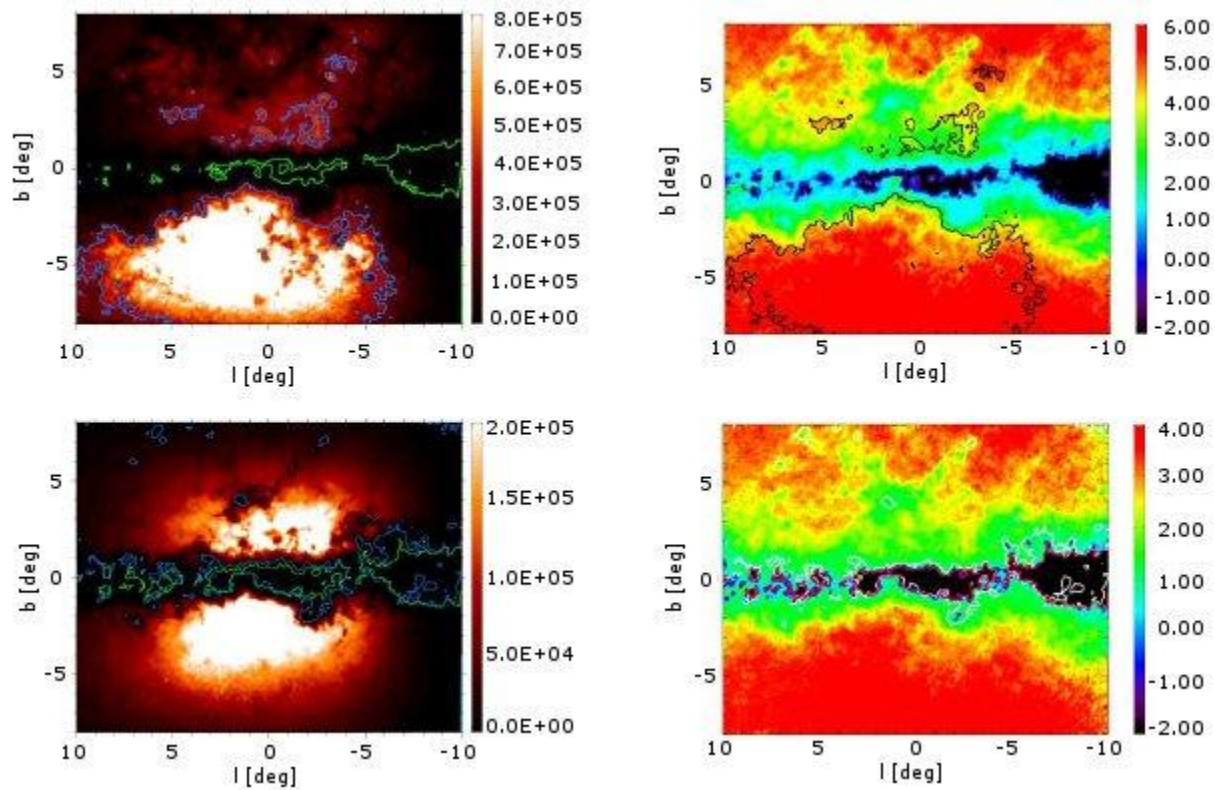

Observations of bulge stars with Gaia will strongly depend on the extinction and on the crowding. If the extinction is too high, the number of stars will be low (no crowding) but conversely the bulge stars would be out of reach, as they would be too faint. If the extinction is low (like in Baade's window), bulge giants on the red clump are bright enough to be reached, but the crowding will limit the number and/or the quality of their measurements. Of course, the number of stars in the bulge also strongly depends on latitudes and longitudes.

The Galaxy model together with the extinction map developed by Marshall et al. (2006) has been used to address the following question: is there a combination of parameters (extinction, latitude) in the galactic bulge where the extinction is large enough to avoid crowding and not too high to allow bulge star measurements with Gaia instruments?

The results of the simulations for the astrometric fields are shown in both top figures. The lower ones correspond to the simulations for the spectrometer. The left panel shows the density of bulge stars at the limiting G magnitude of the instrument ($G=20$), as a function of longitude and latitude. The blue contour depicts the density at which crowding occurs (iso-density of 600000 stars deg^{-2}). The green contour shows a iso-density of 100 bulge stars deg^{-2} , value at which the number of bulge stars is significant. The right panel shows the absolute magnitude M_V of the

intrinsically faintest bulge stars reached at the limiting G magnitude.

In the astrometric fields (top figures), a large part of the bulge will be visible, mainly in the Northern hemisphere, where extinction is higher. That corresponds to a number of 23 million bulge stars over an area of 220 deg^2 . Even still, in the Southern hemisphere bulge stars brighter than the limiting magnitude will be detected. Turn-off stars ($M_V=4$) and even main sequence stars are observable at high latitudes. At lower latitudes, including regions very close to the Galactic plane, the absolute magnitude of the bulge stars is $M_V=1$ to 2, and these stars are mainly clump giants.

In the spectrometer (lower figures) where the crowding is a much more dramatic issue, there are unextended regions where the extinction is high enough to make the crowding low but still not too strong to mask completely bulge stars. About 30000 bulge stars over 9.7 deg^2 are predicted to be observed, in regions around $b=1$ to 2° . They are clump giants.

Putting together observations of the different instruments including RVS, Gaia will produce a detailed survey of bulge giants in terms of photometry as well as kinematics. Detailed analysis of these data sets will put strong constraints on the bulge structure and history.

More details can be found in the paper submitted by Reyle, Marshall, Schultheis & Robin to the Proceedings of the Annual meeting of the French Society of Astronomy and Astrophysics and also available at [astro-ph web page](#).

[A larger version of each of the four figures is available: [top left image](#); [top right image](#); [lower left image](#); [lower right image](#)]

[Published: 08/01/2009]

Picture of the Week

Astrophysical parameter estimation with Ilium

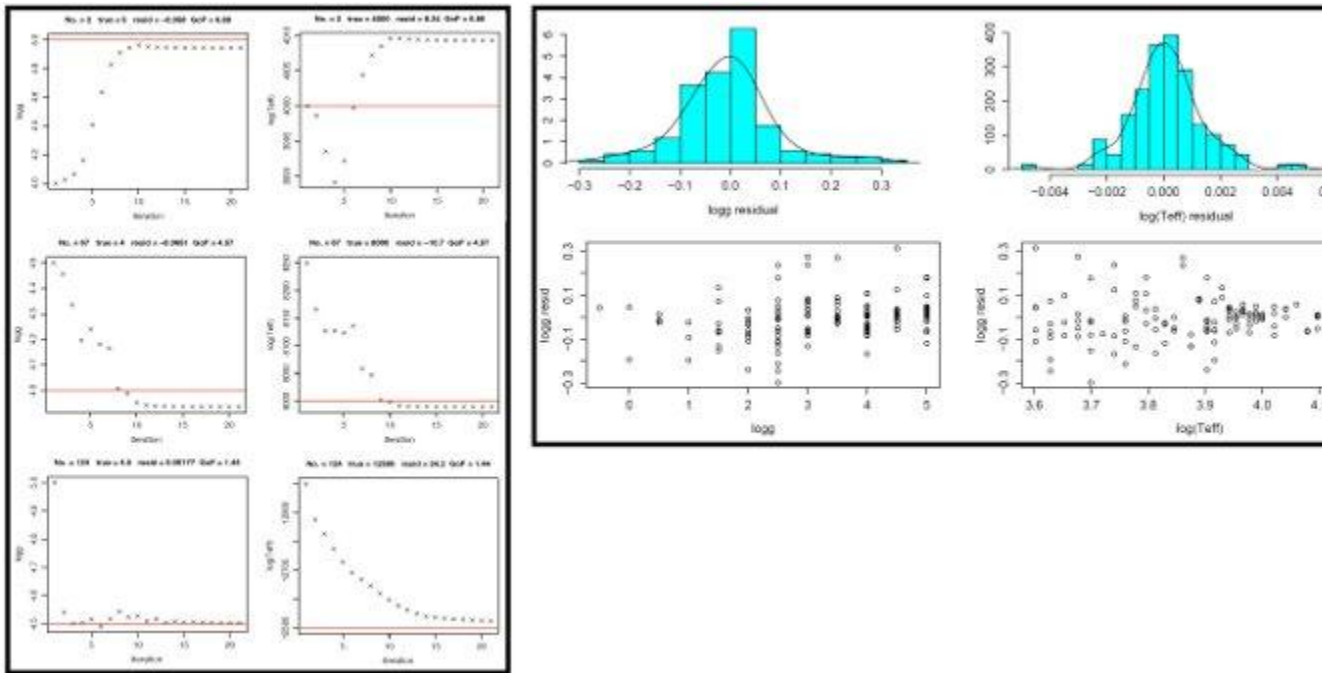

One of the main purposes of the BP/RP prism spectrographs is to estimate stellar astrophysical parameters (APs), in particular the effective temperature (T_{eff}), surface gravity ($\log g$), metallicity ($[\text{Fe}/\text{H}]$) and line-of-sight extinction (A_V). One of the challenges of this is estimating "weak APs", such as $\log g$ and $[\text{Fe}/\text{H}]$, in the presence of much larger variance between spectra caused by the "strong APs", such as T_{eff} and A_V . The different influences can in principle be untangled by machine learning methods, such as support vector machines, which attempt to learn the multidimensional mapping from the data (BP/RP spectrum) to the APs. But in practice these methods often cannot estimate the weak APs as accurately as one would expect, partly because this mapping is an inverse one and hence not always unique.

CU8 has developed a new method which addresses these difficulties. It works by iteratively interpolating over a grid of labelled spectra to derive successively improved estimates of the APs. In this way it overcomes the grid resolution which normally limits the nearest neighbour method. The interpolation uses forward models, which are unique and which fit the strong and the weak APs independently, thus improving its sensitivity. The method automatically weights the wavelengths according to their relevance. It further provides AP error estimates and a goodness-of-fit for new data.

The left figure shows examples of the iteration process for three stars, by plotting the evolution of $\log g$ (left panel) and T_{eff} (right panel). The right figure shows the distribution of the residuals in these APs for the final estimates, also as a function of the true APs. The mean absolute errors

for $\log g$ and T_{eff} at ($G=15$) are 0.07 dex and 0.2% respectively, some five times better than nearest neighbours. A full description of the model, plus additional results, are presented in the [technical note](#) by C.A.L. Bailer-Jones.

A second [technical note](#) describes the application to T_{eff} and $[\text{Fe}/\text{H}]$ estimation.

[A larger version of both figures is available: [left figure](#); [right figure](#)]

[Published: 27/01/2009]

Picture of the Week

BAM OMA mirror type A



The first batch of flight mirrors for the Gaia Basic Angle Monitoring Opto Mechanical Assembly (BAM OMA) has arrived at TNO. The Gaia BAM OMA is a double Michelson interferometer which measures the basic angle between the two telescopes with an accuracy of better than 0.5 microarcseconds. The Gaia BAM OMA consists of two SiC optical benches with fibre collimators, beam splitters and a large number of folding mirrors.

The mirrors have been designed by TNO in close cooperation with Astrium and were manufactured by Boostec. During the coming months, the flat mirrors will be polished by TNO, down to a few nanometers surface error.

More information on www.tno.nl/gaiabam.

Credit: TNO/Fred Kamphues

[Published: 10/02/2009]

Picture of the Week

Combining Geneva photometry with Hipparcos cluster parallaxes

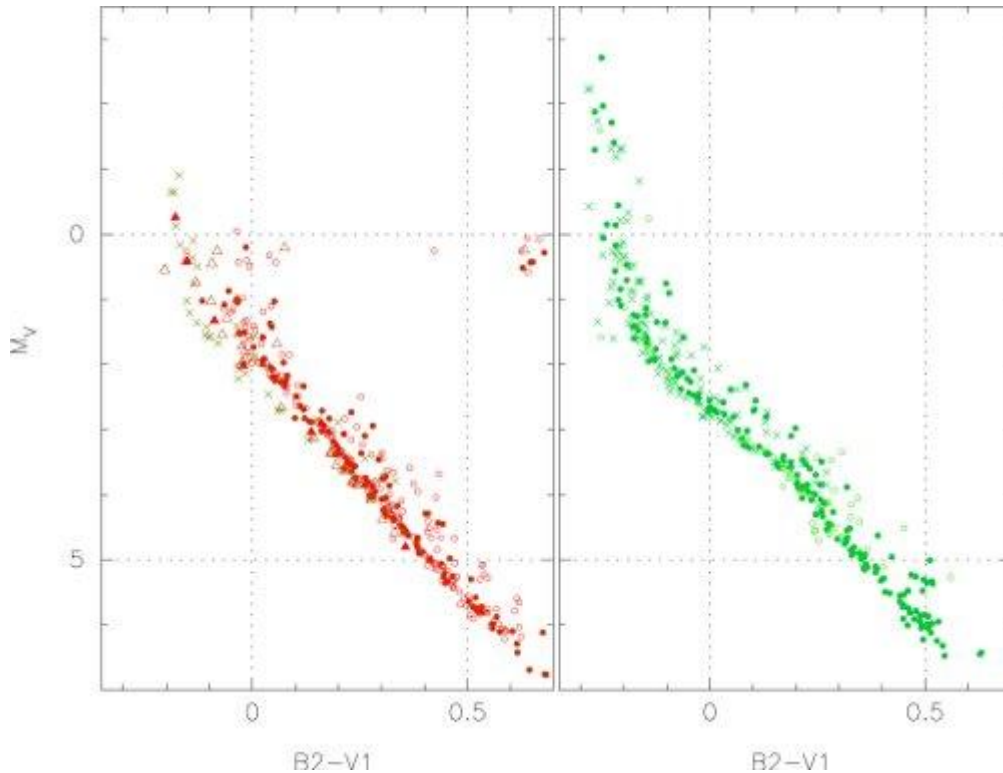

The [new reduction](#) of the Hipparcos data has led to a very significant reduction in the level of the abscissa-error correlations that used to complicate the analysis of these data for star clusters. Accuracies of the astrometric parameters for bright stars in the catalogue have been significantly increased, leading to an overall improvement of a factor of two in the parallaxes for 20 nearby clusters. This was shown in a [new analysis](#) of the Hipparcos data for cluster parallaxes and proper motions by Floor van Leeuwen, which has recently been accepted for publication by A&A. The new results largely confirm earlier conclusions based on the 1997 release of the Hipparcos data, but crucially allow answers to a key unresolved question: what causes the underlying luminosity variations between clusters?

One of the differences is between the luminosities of F stars in the relatively old Hyades (closed circles) and Praesepe (open circles) clusters (Figure on the left), and the much younger Pleiades (closed circles), NGC 2516 (crosses) and Blanco 1 (open circles) clusters, as shown in the figure on the right, here using the Geneva photometry for star clusters to illustrate. Also shown in the figure on the left are three slightly younger clusters, Coma Ber (open triangles), UMa (closed triangles) and NGC 7092 (crosses). Between the Hyades and the Pleiades groups significant and systematic differences are observed for the Strömgren $c1$ index and the B-U index in the Geneva photometry. This has been known for over forty years as the Hyades anomaly. The observed difference in luminosity between the two groups is found to be in good agreement with similar

differences in luminosity we can now observe for nearby field stars as a function of variations in the B-U or c1 colour index. Variations in these indices for F type stars are found to be strongly correlated with spectroscopic determinations of the surface gravity, suggesting that small but systematic surface gravity differences rather than metallicity variations are the main source of the observed luminosity differences between the Hyades and Pleiades cluster groups for these spectral types.

[A larger version of the figures is available [online](#)]

[Published: 24/02/2009]

Picture of the Week

Conjugate-gradients method for the global astrometric solution?

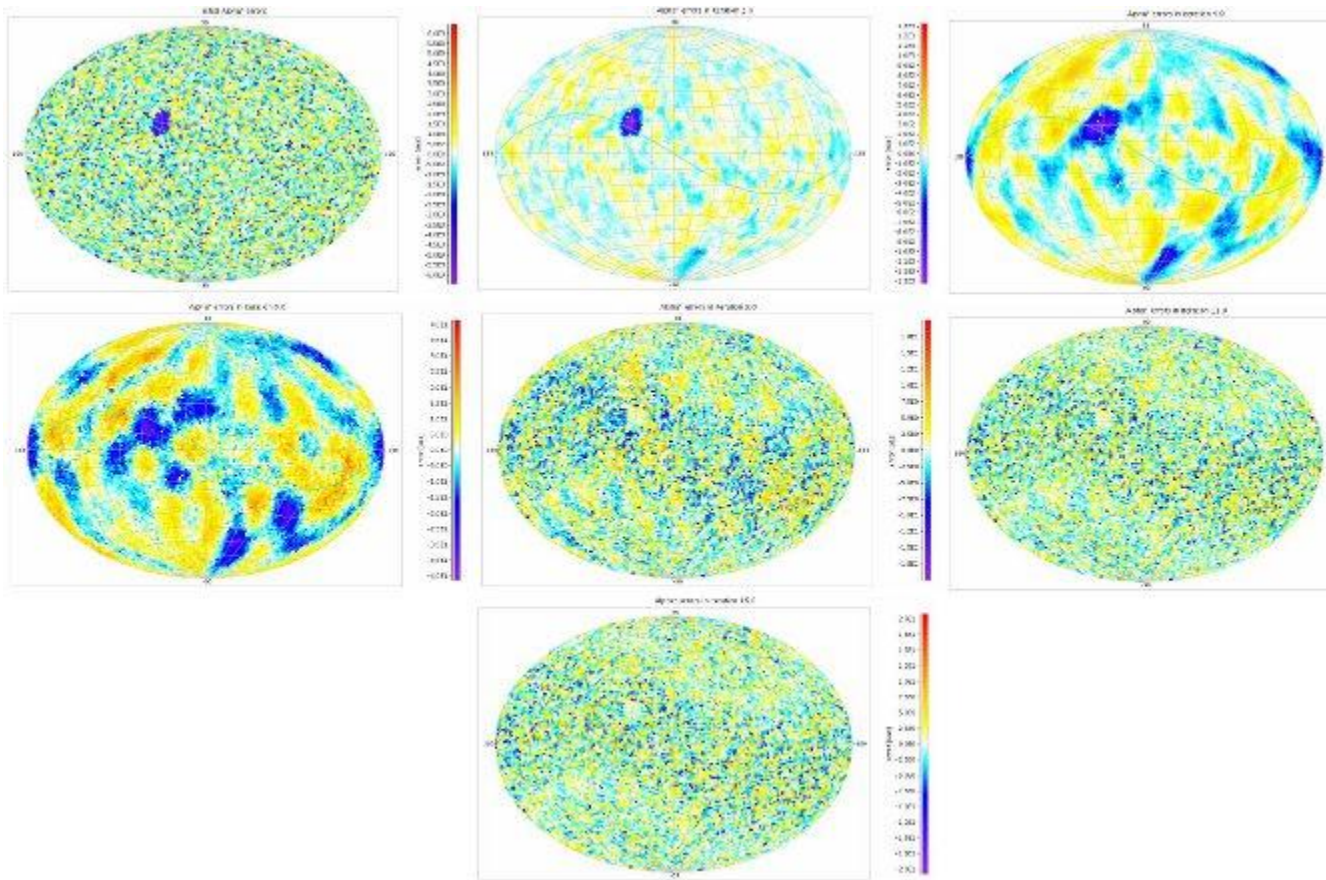

AGIS, the software system to produce the global astrometric solution for Gaia, uses a block-iterative scheme to perform the global astrometric parameter adjustment. In the framework of **ELSA** (the Marie Curie Research and Training Network associated with Gaia) it was investigated whether the usage of the conjugate-gradients method instead of a block iteration might give more pleasant convergence properties.

For this purpose, the conjugate-gradients method was implemented in AGISLab, a simplified simulation environment to mimic the Gaia global adjustment problem. From the experiments done so far Alex Bombrun concludes that the conjugate gradients are an efficient algorithm to compute the global astrometric solution. The convergence rate is higher than that of the (un-accelerated) block iterations.

The pictures above and the [video](#) display - for one particular experiment - the successive error maps during the iterations. The quantity shown are the differences between the computed right ascensions (of the simulated stars) and their true values, averaged over small bins on the sky. The

map itself is a full-sky projection in equatorial coordinates.

The sky used in this simulation is composed of 60000 single stars, isotropically distributed, which have been observed according to the Gaia scanning law. The simulated measurements were of homogeneous precision except in a small sky area, dubbed the **P region**, having the size of one field of view and containing 252 stars.

In that region the precision was simulated to be five times higher, and a large systematic error was added to the initial position and parallax values used to start the iterative process. On the rest of the sky, only a white normal noise has been added to the true values (the **P region** was introduced to investigate whether special adjustment methods are needed for big, bright open star clusters in the sky).

The conjugate gradient scheme is seen to quickly converge to the correct solution, and in just a few iterations it removes the systematic errors. As expected, the solution has a higher precision in the **P region** than in the rest of the sky. Note that we can also observe the effect of the scanning law on the solution: The precision is better near the ecliptic poles (top right and bottom left) than along the ecliptic plane (wavy band through the center).

For more detailed information see [APB-003](#) and [LL-077](#) in Livelink (restricted access - DPAC members).

For AGISLab, go to the [ESAC svn server](#) (restricted access - DPAC members).

For more videos see [ABHeidelberg](#) on Youtube.

A larger version of the figures is available:

- [initial error map](#)
- [error map after 2 iterations](#)
- [error map after 4 iterations](#)
- [error map after 6 iterations](#)
- [error map after 9 iterations](#)
- [error map after 11 iterations](#)
- [error map after 16 iterations](#)

[Published: 11/03/2009]

Picture of the Week

CTI Effects Models for Gaia

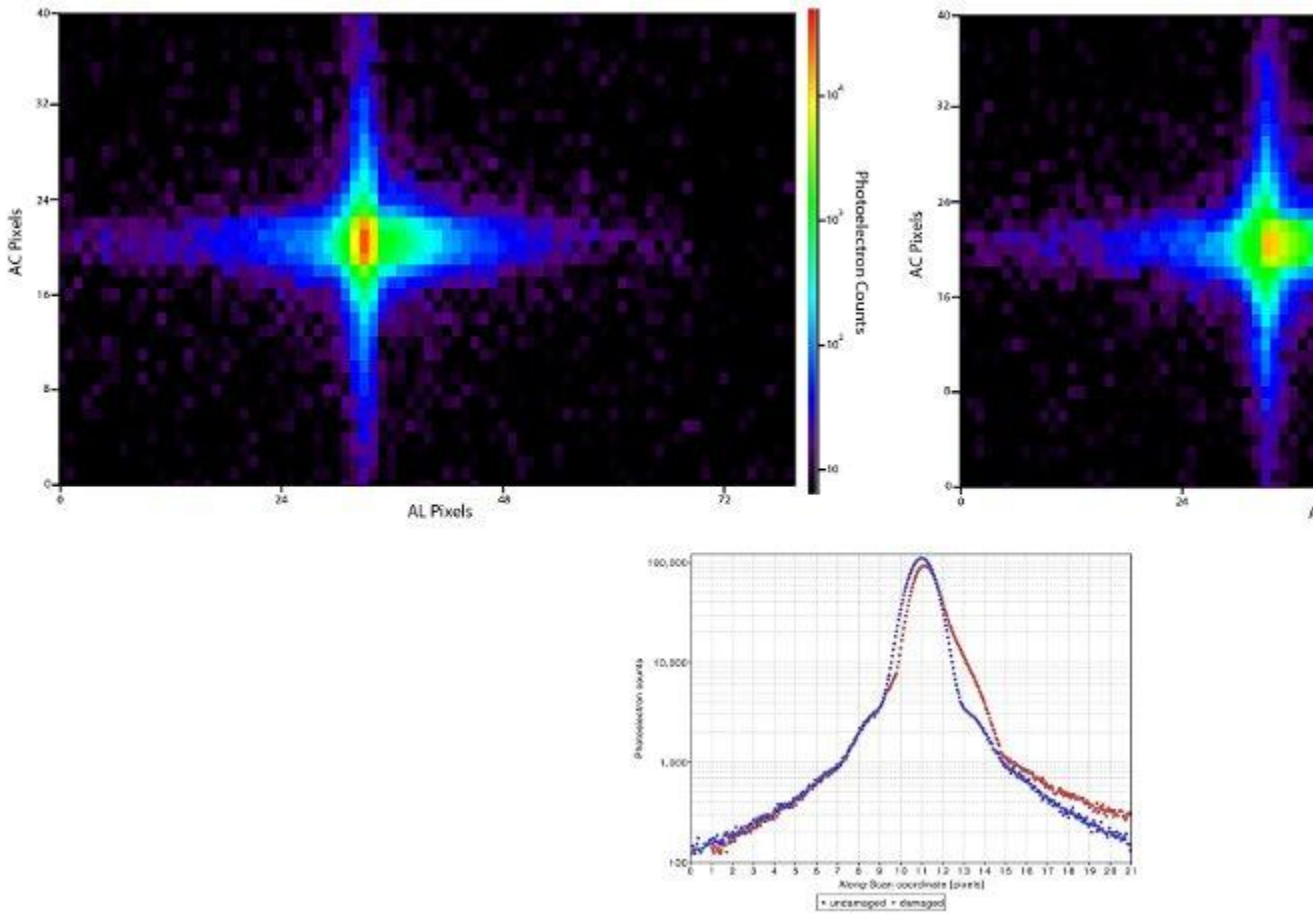

High-accuracy astrometry will allow Gaia to exactly pinpoint the position of a star. The limiting magnitude is about 20 in its own white-light band ($V=20$ for blue stars, $V=22$ for red stars), and all objects brighter than this limit at the epoch of observation will be measured.

Astrometric accuracies			
Magnitude \ Star	B1V	G2V	M6V
$V < 10$	$< 7 \mu\text{as}$	$< 7 \mu\text{as}$	$< 7 \mu\text{as}$
$V = 15$	$< 25 \mu\text{as}$	$< 24 \mu\text{as}$	$< 12 \mu\text{as}$
$V = 20$	$< 300 \mu\text{as}$	$< 300 \mu\text{as}$	$< 100 \mu\text{as}$

The data in the table show that the position on the focal plane of a magnitude 10 (or brighter) star photo-centre has to be determined with an error of $7 \mu\text{as}$. This means that the allowed error in the

position measurement has to be as small as 300 CCD's silicon atoms sitting next to each other. When flare protons (very energetic) collide with one of these atoms, they knock it out of the very well ordered silicon lattice. Displaced atoms let vacancies that can gather with impurities to create a charge trap.

A CCD detects photons thanks to the photoelectric effect: each time a photon collides with the CCD, an electron (photoelectron) is emitted after the absorption of energy from the incoming photon. The radiation-induced traps capture the photoelectrons and release them after a time that may vary. This process increases the charge transfer inefficiency (CTI).

CTI effects lead to more uncertainties in the determination of the star photo-centre position. According to experiments carried on irradiated Gaia CCDs, after five years the photo-centre shift could reach the order of several mas. Unfortunately, the photoelectron capture and release processes are stochastic and the radiation induced centroid bias cannot be systematically corrected. The only way to mitigate the CTI effects is to model them.

In the framework of ELSA and as part of his PhD research, Thibaut Prod'homme is developing CEMGA (CTI Effects Models for Gaia), a platform to host several promising models which provides a detailed description of physical entities such as CCD, pixel or trap, and methods to interact with them. CEMGA is currently highly involved in the validation of the DPAC scheme for CTI mitigation.

Top pictures are the outcomes of a physical pixel level Monte-Carlo model simulating undamaged (left) and damaged (right) transits of a $V = 14$ magnitude star over a Gaia AF CCD. The damaged one has been increased to see a clear photo-centre shift.

The bottom picture is the result of a similar experiment with a realistic amount of 3 traps per pixel. After the binning of this extended Gaia telemetry window (12 x 21 pixels) CTI effects can be clearly seen, the charge profile is distorted: electrons are trapped in the leading edge and released later to form a charge tail. The centroid bias is 8.6 mas and the relative charge loss 11.5 %.

Previous pictures are summarized in the following [video](#).

For using CEMGA, checkout the [svn repository](#) (restricted access - DPAC members) and read [CEMGA's javadoc](#).

More information about the Gaia mission preparations in the Netherlands is available in the following [link](#).

A larger version of the figures is also available:

- [top left picture](#)
- [top right picture](#)

- [bottom picture](#)

[Published: 27/03/2009]

Picture of the Week

The siblings of the Sun

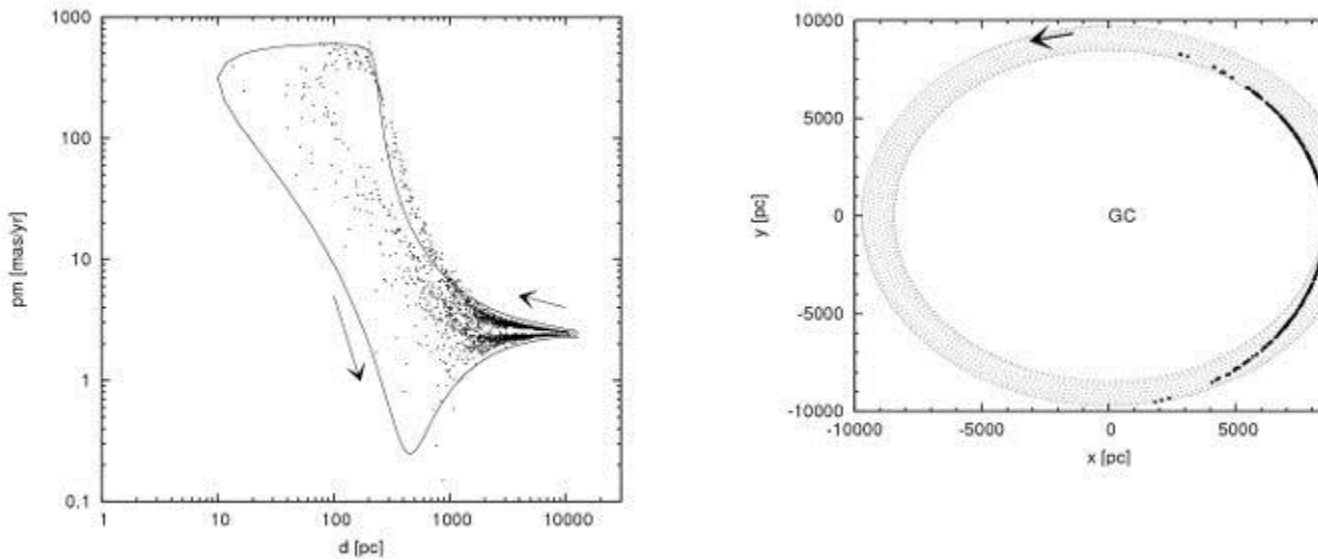

It is commonly accepted that stars like the sun are born in clusters. The cluster in which the sun was born is long gone and the sun's siblings are by now spread over the Galaxy, but they remained on a similar orbit around the Galactic center. Today these stars hide among the field stars, but 10 to 60 of them are still present within a distance of ~ 100 pc. These siblings of the sun can be identified by accurate measurements of their chemical abundances, positions and their velocities. With the Gaia satellite and ground based searches the radial velocity and distance to the majority of the lost siblings will be determined, and the proper motion will be measured. These constrain the orbit of the proto-solar cluster and enable us to accurately determine the evolution of the Galactic potential and the birth place of the sun.

Today, we should still be able to recognize the siblings along the orbital trajectory of the solar system in the Galaxy. If the sun happens to be on a different orbit this will reflect in the orbits of its siblings. The distribution of proper motions and distances of these stars are presented in the figure on the left, where [Simon Portegies Zwart \(Leiden Observatory\)](#) shows the result from a cluster of 2048 stars with a 1 pc virial radius that dissolved 4.6Gyr ago. The proper motions and distances of these stars change in a characteristic way, indicated by the solid curve and in the direction of the two arrows.

The majority of our lost siblings are easily identified by the Gaia astrometric satellite or by ground based searches. We are still surrounded by them, even though they hide among millions of other ordinary looking stars. What enables us to recognize the other siblings are their orbital characteristics, which should be comparable to the sun. In the figure on the right [Simon Portegies Zwart \(Leiden Observatory\)](#) presents the distribution of stars that once belonged to the proto-solar cluster; they are currently observable along the orbit of the sun in the Galaxy. The best place to look for the lost siblings is along the trajectory of the sun in the plane of the Galaxy, in

leading and trailing orbits around the Galactic center. Identifying those stars will provide stringent limits on the sun's orbit around the Galactic center and gives us a unique window to study the conditions of the star cluster in which the sun was born.

For more information, please go to the [original paper](#), published in ApJ in May 09.

A larger version of the figures is also available:

- [left figure](#)
- [right picture](#)

[Published: 21/04/2009]

Picture of the Week

Variability tree

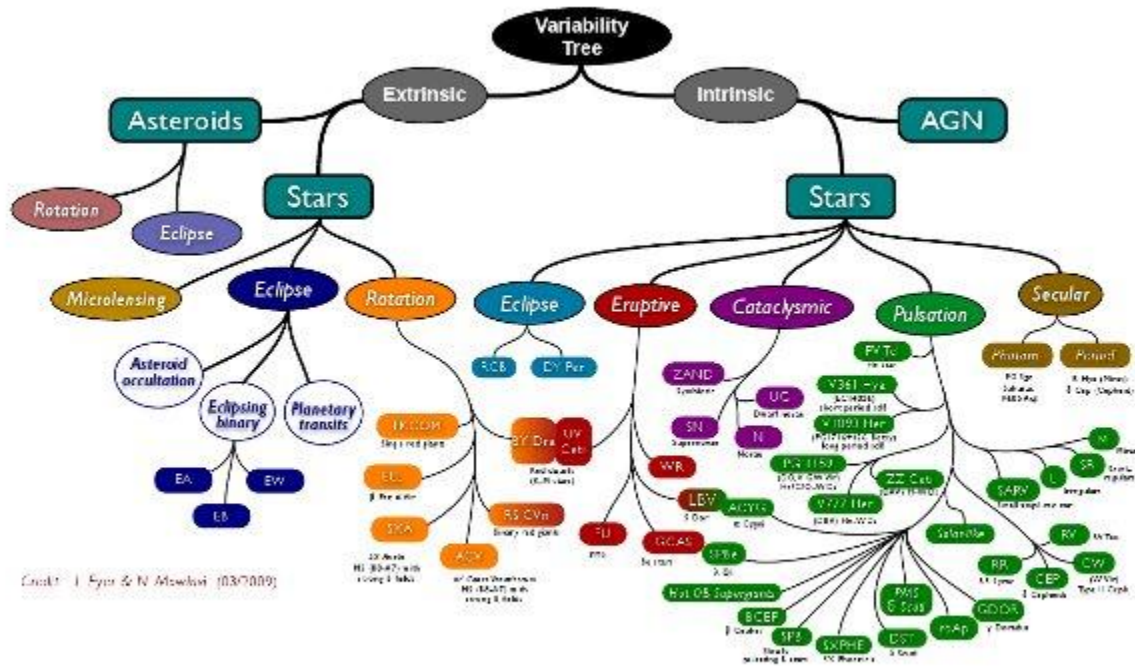

The Aristotelian paradigm of unchanging supra-lunar regions has been shown wrong on two fundamental observable aspects: stars change position, and they may change their brightness. The subject of variable stars is an "old" subject of astronomy which started to develop in the 19th century, and still is a modern cutting-edge science (dark energy has been established thanks to supernovae). Today, there are hundreds of thousands variable stars known. The General Catalogue of Variable Stars (GCVS) lists more than 100 types and subtypes of variable stars. In our figure, we made an attempt to cover the different types of variable sources according to the physical phenomena at the origin of their variability (see Eyer and Mowlavi 2008 for details).

The Gaia satellite will give a very substantial contribution to variability studies. First, it will provide a complete survey of the whole sky down to magnitude 20, probably detecting many tens of millions of variable objects. Second, the measurement of the parallax will allow the determination of their luminosity.

Gaia will have quasi-simultaneous G photometry, BP and RP spectrophotometric, and RVS measurements (in half of the cases for this latter instrument). As the shortest integration time is

4.4 seconds, time scales of seconds to years can be detected. The photometric precision should reach the millimagnitude level at the bright end, and about 20 millimag at a magnitude of 20.

Most of the known variability types shown on the figure will benefit from the Gaia mission, thanks to its multi-epoch observations. Though the Gaia time sampling is not dense, and hence not very suitable for the study of some non-periodic variabilities, it will be efficient in the analysis of strictly periodic signals, for which the predicted period recovery rate is high.

For some events that occur uniquely and on a short time scale, a flux-based alert will be issued by the Coordination Unit 5 (CU5) of the Gaia ground segment. The analysis of all types of variables outside the solar system is done by the Coordination Unit 7 (CU7) based on the calibrated data received from CU5. This includes the characterisation of the light curve variability of all variable sources, their classification into the different types of variabilities, and specific analysis of several variability types. CU7 will also do variability announcements that are less time critical, on specific groups of variable stars such as producing a list of RR Lyrae stars.

A [larger version](#) of the picture is also available.

[Published: 15/05/2009]

Picture of the Week

Gaia Torus Segments



The Gaia Torus is the very stable optical bench supporting the focal plane and the optics. It consists of 17 Silicon-Carbide (SiC) segments brazed together. The picture shows the first 5 segments installed in the brazing facility at Boostec (courtesy of Boostec Industries).

[Published: 3/06/2009]

Picture of the Week

Plasma Jet Machining on strongly curved off axis parabolic SiC mirrors



Credit: TNO/IOM/Fred Kamphues

TNO Science and Industry and the Leibniz Institute of Surface Modification (IOM) are developing processes for finishing strongly curved off axis parabolic SiC mirrors. The mirrors form a crucial part of the cryogenic fibre collimators for the Gaia Basic Angle Monitoring Opto-Mechanical Assembly (BAM OMA).

The Gaia BAM OMA is a double Michelson interferometer which measures the basic angle between the two telescopes with an accuracy of better than 0.5 microarcseconds. The Gaia BAM OMA consists of two SiC optical benches with fibre collimators, beam splitters and a large number of folding mirrors.

The off axis parabolic SiC mirrors are designed by TNO in close cooperation with Astrium and were manufactured by Boostec. TNO and IOM use a combination of 3D robot polishing and Plasma Jet Machining (PJM). Plasma enhanced chemical etching is a non-conventional technology for surface machining. The method is based on a microwave or RF excited plasma jet under normal atmospheric pressure or in rough vacuum yielding a high flux of reactive radicals.

Material removal is obtained by chemical reactions between the radicals and surface atoms.

Different plasma jet sources have been developed to do deterministic surface shaping and surface figure error correction over a wide spatial range with nanometre accuracy. The half-width of the almost nearly Gaussian like shaped removal functions reaches from about 0.1 mm to about 10 mm. Maximum volume removal rates of about 50mm³/min have been achieved for fused silica and ULE™. Surface machining is accomplished using the dwell time algorithm on CNC controlled multi-axes systems. Far developed mathematical de-convolution routines are used for creating the machining files.

During plasma jet treatment no sub-surface damage occurs in contrast to abrasive methods. This advantage makes the plasma jet technology very attractive for the precise manufacturing of especially spherical and free-form optics. On the other hand the chemical removal mechanism leads to an increase of surface roughness depending on the material and the removal depth. But at the same time potential subsurface damage is removed. A low surface roughness is achieved with a post polishing run on the Zeeko polishing robot at TNO.

The parabolic mirror is made of silicon carbide (SiC) and needs to be polished to a surface error of less than 12.5 nm RMS. The main difficulty of this mirror is its small radius of curvature ($R = 50.17$ mm) over an effective aperture of 10 mm. During trial runs by IOM and TNO a surface error of 8 nm RMS was achieved. Production of the flight mirrors has started.

More information on:

- <http://www.tno.nl/gaiabam>
- http://www.iom-leipzig.de/html/eng/nachwuchsforschergruppe_uat.cfm

[Published: 19/06/2009]

Picture of the Week

SVN reached the 100000 commit



After many years of intense development, umpteen cycles, numerous software releases, and with End-to-End testing looming, we find that the number of commits to the Gaia DPAC Subversion repository exceeds a massive sum of 100000.

This value, according to Wikipedia, corresponds in metres to the altitude where spaceflight is regarded to begin. The Irish even include this number in a popular greeting: 'Ceád Mile Fáilte' (a hundred thousand welcomes).

To celebrate this event, a special T-shirt has been printed to commemorate the person who made the 100000th commit: José Hernández!

[Published: 30/09/2009]

Picture of the Week

BAM OMA mirror

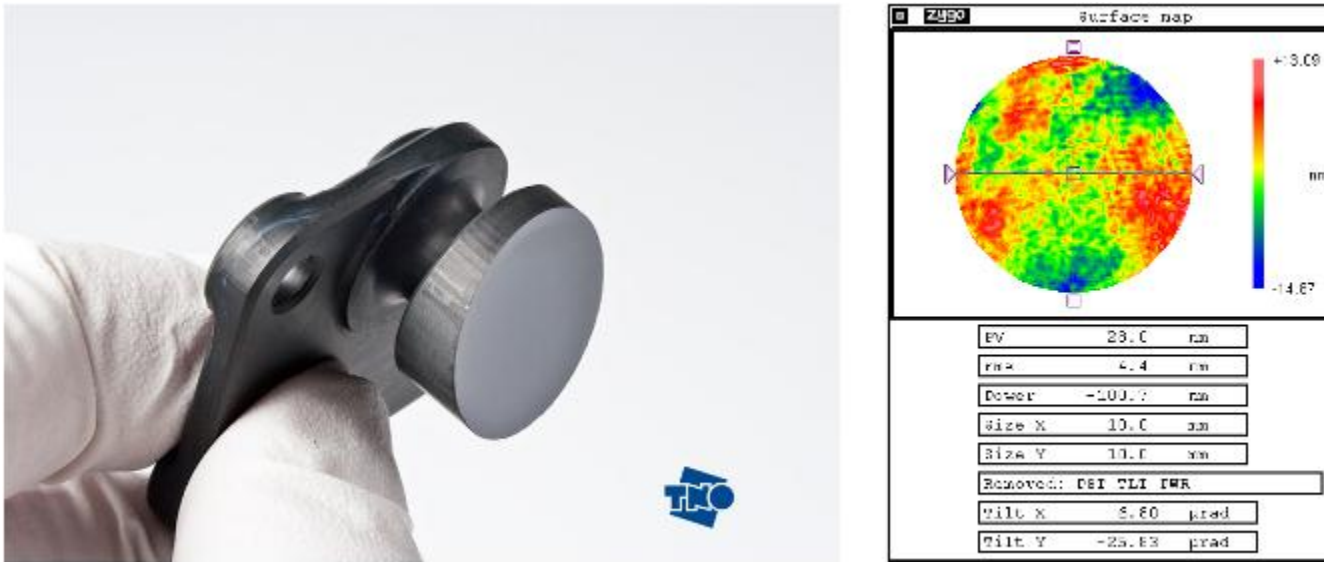

BAM OMA polished off axis parabolic SSiC mirrors meeting specifications. Credit: TNO/IOM/Wim Gielesen

Note: see also [Plasma Jet Machining on mirrors](#) Picture of the Week.

The parabolic mirrors of the Gaia BAM cryogenic fiber collimators are made of sintered silicon carbide (SSiC) without CVD coating and needed to be polished to a surface shape error of less than 12.5 nm rms and a surface roughness Rq 6 nm. The main difficulty of this mirror is its small radius of curvature ($R = 50.17$ mm) over an effective aperture of 10 mm.

The strongly curved off-axis parabolic SSiC mirrors are designed by TNO Science and Industry in close cooperation with Astrium and were manufactured by Boostec. Polishing of these mirrors to demanding surface form and roughness requirements is performed by TNO in close cooperation with the Leibniz Institute of Surface Modification (IOM) applying a combination of 3D robot polishing and numerically controlled Plasma Jet Machining (PJM).

Polishing of the Flight collimator mirrors has been completed successfully in September 2009. The achieved performances of the three mirrors are respectively:

- Surface form: 4.4, 4.4 and 7.2 nm rms (requirement: ≤ 12.5 nm rms)
- Surface roughness (Rq): 3, 6 and 5 nm (requirement: $Rq \leq 6$ nm)

More information on:

- <http://www.tno.nl/gaiabam>
- http://www.iom-leipzig.de/html/eng/nachwuchsforschergruppe_uat.cfm [Published: 23/10/09]

Picture of the Week

Gaia M2 mirror



The Gaia payload is characterised by a dual telescope with a common structure and thanks to the M4 mirrors, they are sharing the same focal plane whereas they are imaging two separate fields of view (see Gaia payload [Picture of the Week](#)). Each telescope is based on a three mirror anastigmatic design with three flat-folding mirrors, the two viewing directions separated by a 106.5 degrees basic angle.

The three mirror anastigmatic telescope is defined by M1, M2 and M3. M2 mirror (see picture above) is a rectangular off-axis convex mirror with dimensions 34.5 cm x 15.0 cm. The M2 mirror lightweighted blank is made of Sintered Silicon Carbide and it is coated with a CVD SiC coating prior polishing. The polished surface then receives a protected Silver reflective coating.

Picture courtesy of AMOS/Astrium.

[Published: 27/11/2009]

Picture of the Week

Soyuz launch pad



Gaia will be launched in 2012 from the CSG (Guiana Space Centre) situated in the northeast of South America in [French Guiana](#). The satellite has been designed to be placed in space by the Soyuz launch vehicle and a Soyuz launch site is being built at the CSG (with the first Soyuz launcher scheduled for lift-off in summer 2010). The launch site is called ELS (Ensemble de Lancement Soyuz) and lies at latitude $5^{\circ}3'$, just over 500 km north of the equator. From there, launchers profit from the 'slingshot' effect, that is, the energy created by the speed of the Earth's rotation. Safety is equally important. French Guiana is scarcely populated and 90% of the country is covered by equatorial forests. In addition, there is no risk of cyclones or earthquakes.

The ELS consists of three main zones:

- the launch platform (see picture above) where the launcher will be erected for lift-off
- the MIK-building (MIK is a russian acronym for Assembly and Testing Complex) for horizontal integration and testing of the launcher
- the launch control centre

For more information, please visit the following [web page](#).

A larger version of the picture is [available](#).

Picture courtesy of W. O'Mullane

[Published: 17/12/2009]

2010

12/21: The 100th member of CU3
◄ 11/17: Nano-JASMINE and AGIS
◄ 10/27: Eclipsing binary light curves fitted with DPAC code
◄ 10/13: Gaia broad band photometry
◄ 09/28: Measuring stellar parameters and interstellar extinction
◄ 09/14: M1 mirror
◄ 08/27: Quest for Sun siblings
◄ 07/23: Surprising finding in the coverage of Gaia
◄ 07/09: Binarity of Cepheids
◄ 06/25: Honorary doctorate for M. Perryman
◄ 06/03: Observing Planck
◄ 04/23: M4 mirror
◄ 03/15: Hyper-Runaway Candidate
◄ 02/26: Auto Collimating Flat Mirror Assembly
◄ 01/29: Complete Gaia Torus

Picture of the Week

Complete Gaia Torus

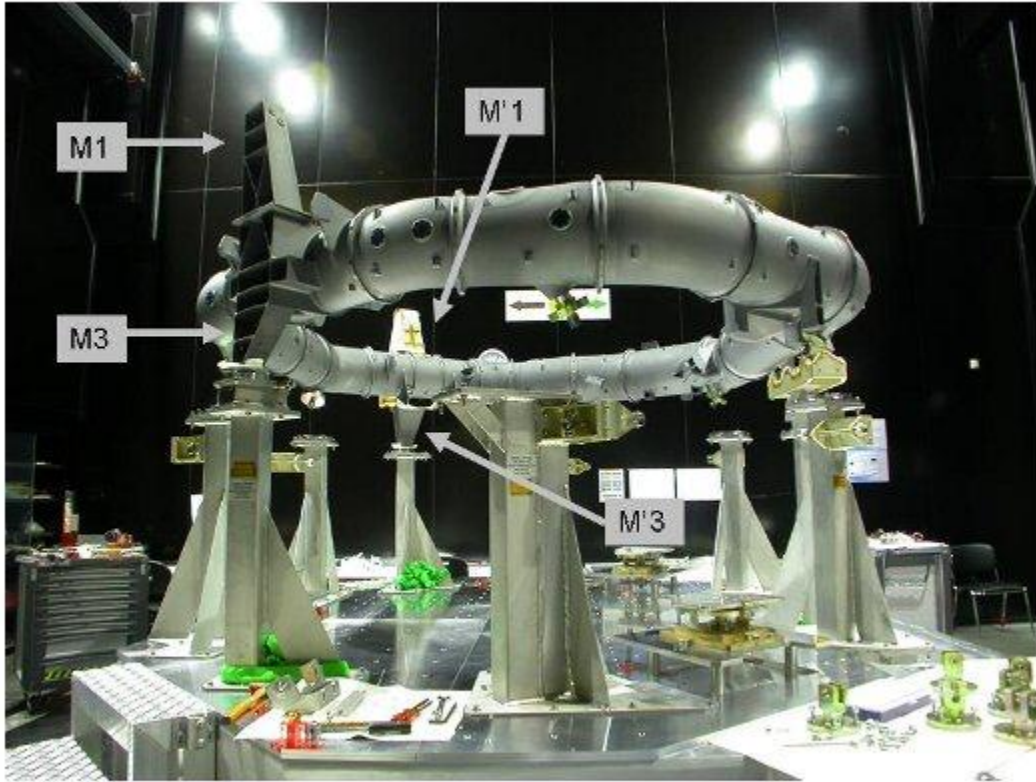

This image shows the Gaia torus, a 3-meter diameter, quasi-octagonal structure, which will support the two Gaia telescopes and the focal plane assembly. It is composed of 17 individual custom-built Silicon Carbide segments which fulfil three basic requirements: light-weight, robust and ultra stable. The arrows show the locations where M1, M'1, M3 and M'3 mirrors will be mounted.

More information about this topic can be found in:

- <http://sci.esa.int/science-e/www/object/index.cfm?fobjectid=45332>
- <http://sci.esa.int/science-e/www/object/index.cfm?fobjectid=45330>
- http://www.rssd.esa.int/index.php?project=GAIA&page=picture_of_the_week&pow=113

Picture courtesy of Boostec Industries.

A larger version of the picture is available [online](#). The same picture without labels can also be

[downloaded.](#)

[Published: 29/1/2010]

Picture of the Week

Gaia Auto Collimating Flat Mirror Assembly (AFMA)



Credit: TNO / Leo Ploeg

In order to perform the Gaia payload tests in thermal vacuum, TNO has developed the Gaia Auto Collimating Flat Mirror Assembly (AFMA). This highly accurate scanning mechanism will rotate a 1.5m x 0.5m large Silicon Carbide mirror of about 90kg around the vertical axis on the mirror surface. The mirror will be used in auto collimation to reflect a point source on the focal plane array. The reflected point source herewith can make a scanning motion over the complete focal plane array.

The SiC mirror performs a scanning motion over a maximum angle of 20mrad around the azimuth axis, the scanning axis can be adjusted around roll and elevation axis over +/- 6mrad with a resolution <math><10\mu\text{rad}</math>. The common point of rotation lies in the mirror centre. The azimuth axis is hinged by a large cross-link flexure and actuated with two voice coils. The roll and elevation has sliding bearings and are actuated with piezo actuators.

The AFMA instrument has an enhanced control system that results in a scanning performance <math><25\text{rad/s RMS}</math> over a period of 4.4 seconds in an ambient environment.

TNO delivered the 1st of two mechanisms to Astrium in mid-February 2010.

More information on <http://www.tno.nl/space>

[Published: 26/2/2010]

Picture of the Week

Hyper-Runaway Candidate HIP 60350

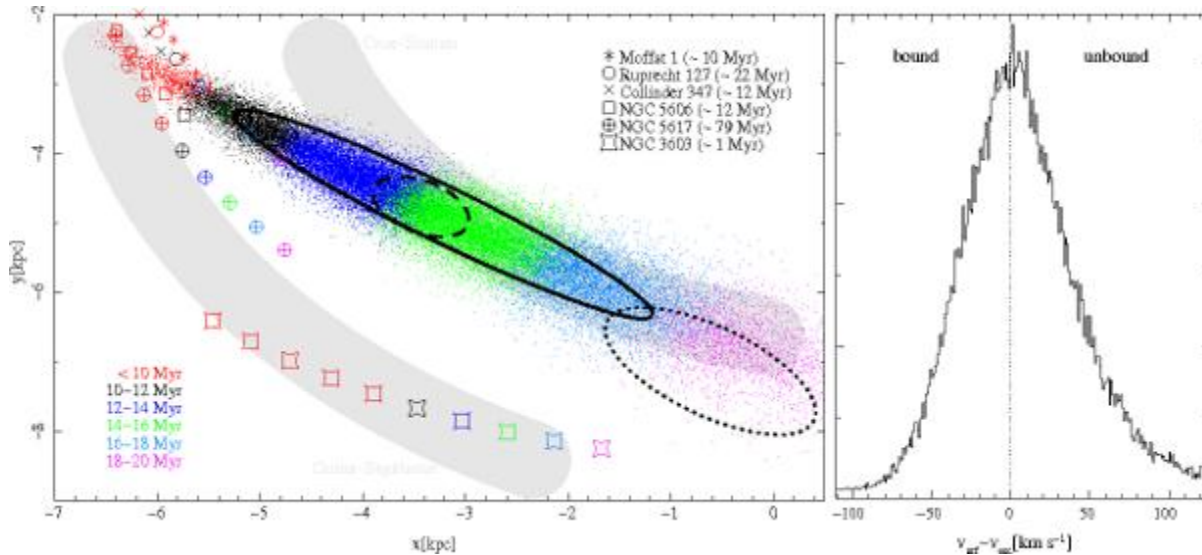

Even 13 years after publication, the Hipparcos Catalogue still generates exciting new science. In a recent investigation - [published in the *Astrophysical Journal*](#), Andreas Irrgang and collaborators have revealed the nature of the hypervelocity-runaway star HIP60350. The authors conclude that the star is more likely than not moving too fast for the Galaxy's gravitational forces to hold on to it, after having been ejected at high speed from its birth place some 15 Myr ago.

Runaway stars are massive, young stars found far from their birthplaces, the spiral arms in the Galaxy. Two explanations are generally put forward to explain such oddities: a supernova explosion disrupting a binary system and sending the surviving star off with a large velocity ([Blaauw 1961](#)) or a close, dynamical interaction between (binary) stars in a young, compact star cluster ([Poveda et al. 1967](#)).

HIP60350 is a known runaway OB star. It is a young, B-type star (≈ 5 solar masses, age ≈ 15 Myr) only 15 degrees away from the Galactic pole at a distance of some 3 kpc. Spectroscopic data, together with proper motions from Floor van Leeuwen's [new release](#) of the Hipparcos Catalogue, allowed the authors to trace the three-dimensional motion of the star through the Galaxy back in time. They repeated this exercise 50,000 times, each time with a slightly different starting condition, to sample the distribution of observational errors. The results indicate that HIP60350 has most likely a three-dimensional velocity above 500 km/s, i.e., exceeding the local Galactic escape velocity. The data are fully consistent with the star originating, some ≈ 15 Myr ago, in the Crux-Scutum spiral arm.

At the moment, the quality of the observational data - in particular the stellar parallax (distance) - is insufficient to pinpoint the precise origin of the star within the spiral arm. At least 5 open clusters are consistent with being the birth place of HIP60350. Gaia will observe this 11-th

magnitude star several dozen times and will determine its parallax to within 10 μ as. As a result, the distance to the star will be known with a precision of around 3%, which will allow to significantly reduce the spread of the 50,000 orbits and to unambiguously determine the birth cluster.

The left panel shows an intersection of the Galactic disc (XY plane) and the distribution of the "end points" of the 50,000 back-traced orbits. Additionally, the trajectories of the best open-cluster candidates in which the star was most likely born are depicted; these are Ruprecht 127, NGC5606, NGC5617, Collinder 347, and Moffat 1. The flight time's colour code is given in the lower left corner. A right-handed, non-rotating frame of reference with the Galactic centre at the origin, Galactic north pole in the positive Z-direction, and the Sun's current position at (-8.0, 0, 0) kpc is used. The ellipses mark the 1-sigma region with (solid) or without (dashed, dotted) accounting for uncertainties in distance, respectively. The gray-shaded regions schematically represent the locus of two spiral arms \approx 15 Myr ago. The right panel shows the histogram of the distribution of (un)bound trajectories. The abscissa is the difference between the current space velocity and the local escape velocity. The majority of orbits are unbound.

A larger version of the figure is available in the following [link](#).

[Published: 15/03/2010]

Picture of the Week

Gaia M4 mirror



One of the two Gaia M4 mirrors undergoing inspection at the premises of Advanced Mechanical and Optical Systems (AMOS) in Liege, Belgium).

The 190 x 69 mm mirror was fabricated from sintered silicon carbide (SiC) by Boostec at Bazet near Tarbes, France.

The mirror surface was coated with a layer of silicon carbide using chemical vapour deposition (CVD). The CVD layer of all Gaia mirrors is applied by Schunk Kohlenstofftechnik in Heuchelheim, Germany.

A larger version of the picture is available in the following [link](#).

[Published: 23/04/2010]

Picture of the Week

Observing the Planck spacecraft with the CAHA 2.2m telescope + CAFOS

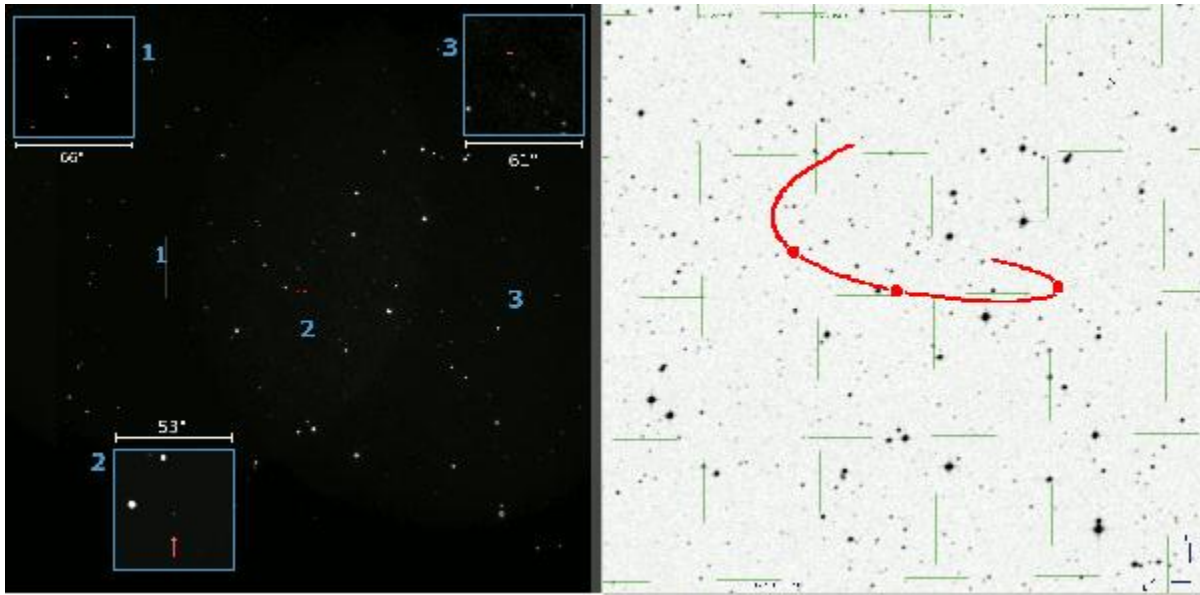

On the night of the 29th of May 2010, astronomers X. Luri and E. Herrero, with a group of students of the University of Barcelona, used the 2.2m telescope at the Calar Alto observatory to obtain images of ESA's Planck spacecraft, orbiting around the Sun-Earth L2 point at 1.5 million kilometers from Earth. This picture has been composed from these images, showing the movement across the sky of Planck during the night. These results will be used to study the feasibility of on-ground astrometry of the ESA's Gaia spacecraft, needed for the data reduction of this mission.

Right: finding chart & Planck's sky path as predicted by its orbital ephemeris.

Left: the background picture is the composition of three images obtained with the CAFOS instrument. The position of Planck at three observation times is framed with a white box. The blue boxes show an enlargement of these areas: each area was observed twice (30 sec exposures) with two minutes of difference, allowing the composition of the blinking images in the blue boxes.

For more information and access to the animated gif, visit the [following web page](#).

[Published: 03/06/2010]

Picture of the Week

Honorary doctorate for M. Perryman



Dr. Michael Perryman, Project Scientist of Hipparcos (1981-1997) and former Project Scientist of Gaia (1996-2006), received an honorary doctorate at the Lund University on the 28th May 2010 in recognition of more than 25 years of outstanding contributions to astronomy.

Picture courtesy of Berry Holl.

[Published: 25/06/2010]

Picture of the Week

Hipparcos suspected binarity of Cepheids

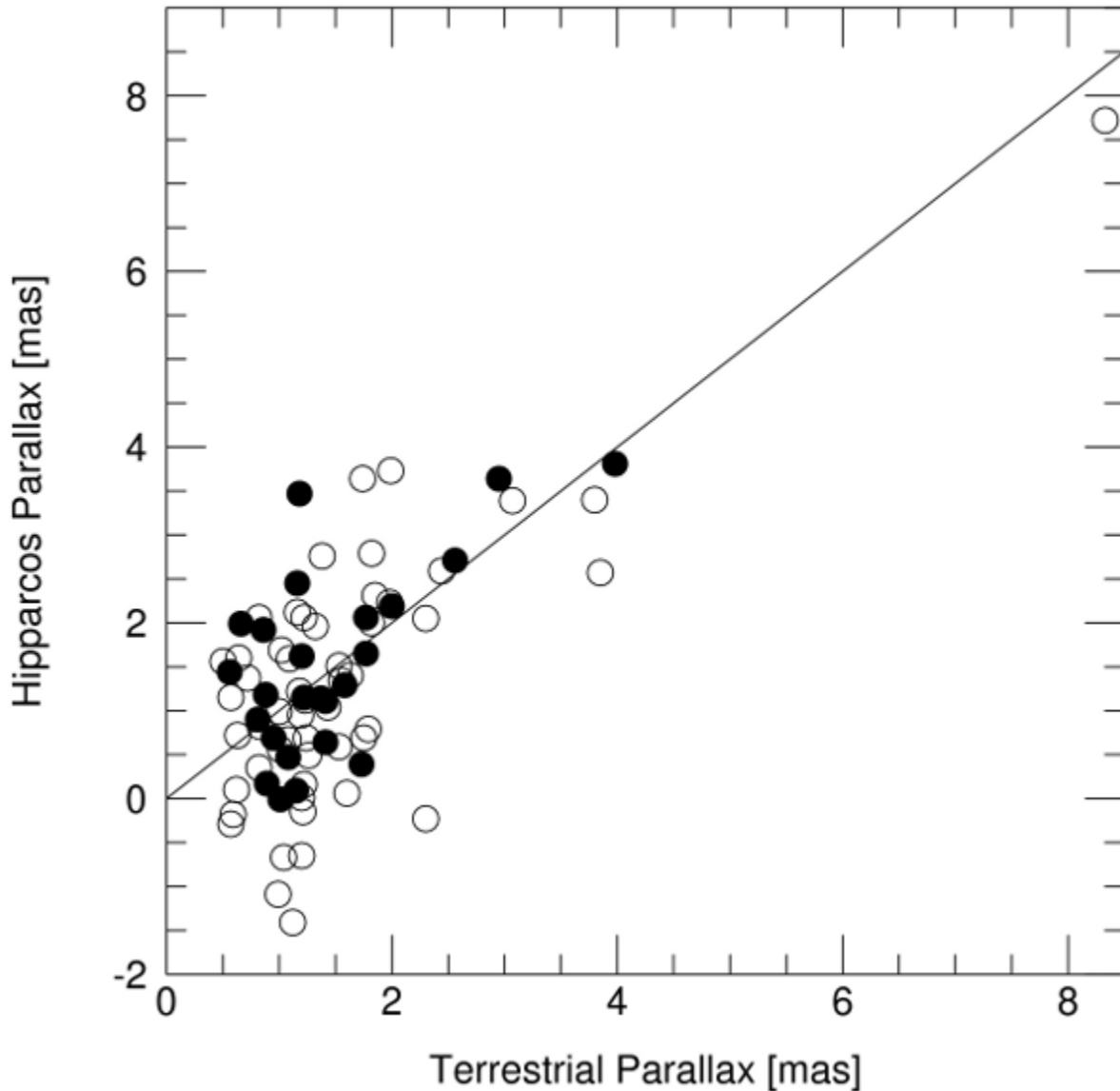

Cepheid variables are primary distance indicators owing to their famous period-luminosity relationship. Because the incidence of binarity among Cepheids exceeds 50 per cent, the effect of the companion stars on the spatial motion and brightness of the Cepheid has to be taken into account on individual basis. Typical orbital periods are between 400 and 2000 days.

This figure is the plot of the Hipparcos vs. 'ground-based' parallax for the nearest Cepheids. Open circles denote Cepheids with known companion(s). Cepheids without (known) companions are marked with black dots. When reducing the Hipparcos data, no allowance was made for

binarity of any Cepheid. The motion along the orbital arc thus could falsify the deduced parallax value. It is remarkable that **all negative parallax values** plotted in the figure **belong to known binaries**.

The sensitivity of Gaia will be sufficiently high to treat these (and even much farther) Cepheids as binary stars - to determine their astrometric orbit, resulting in an independent distance value.

Figure courtesy of Laszlo Szabados

[Published: 09/07/2010]

Picture of the Week

Surprising finding in the one-day sky coverage of Gaia

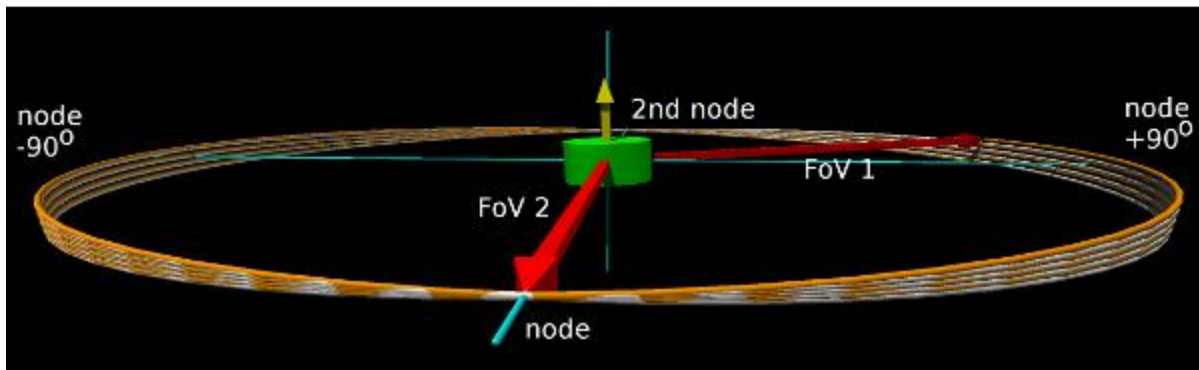
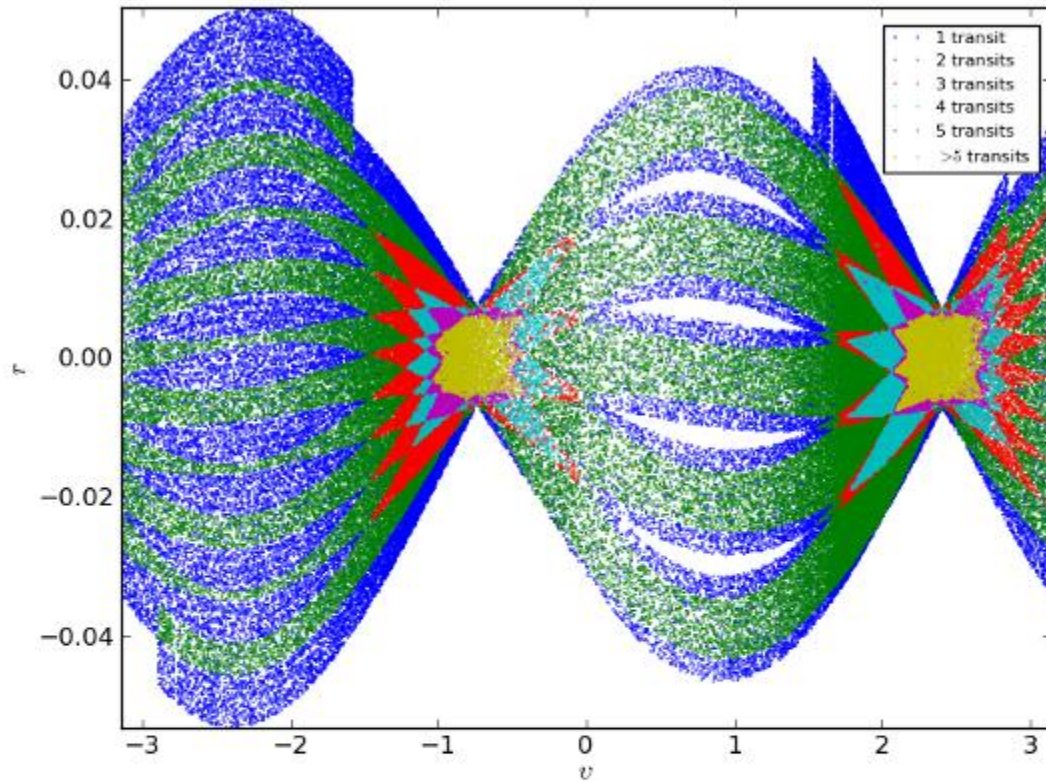

In the course of the scientific validation of simulated test data covering a time period of 1.3 days, the Gaia First Look team discovered a feature in the sky coverage that was first thought to be an error in the simulation: gaps in the sky coverage.

The Figure above shows the coordinates of 200,000 stars which according to the simulations are measured in the direction of Gaia's two fields of view (FoVs) within 31 hours. During such a short period of time Gaia varies its scanning direction by only about 6 degrees (see Figure above). The coordinate "v" (measured from $-\pi$ to $+\pi$ or -180° to $+180^\circ$, respectively) on the abscissa is an angle measured around the mean scanning direction of the day; the perpendicular direction "r" (from -0.05 to 0.05 or -3° to $+3^\circ$, respectively) is strongly stretched for better visibility.

For a given star the colour shows how often a star has been measured by one of the FoVs during the 31 hour period: as expected those stars close to the nodes of the scanning law - where the scans intersect - are measured more than five times (colour coded in yellow) while some stars $\pm 90^\circ$ away in along-scan direction (marked in blue) are scanned only once or twice (green colour).

Surprisingly, not only to the First Look team, the region to the right of the center of the Figure even showed gaps where stars were not measured at all, while on the other half of the scan circle a stronger overlap between consecutive scans was seen. The actual size of the gaps is about 100° along-scan and 0.16° across-scan.

Only a few days ago an explanation for these gaps has been found: it is due to the fact that the projections of the sky from the two different fields of view on a given CCD are offset in the across-scan direction. This effectively leads to a smaller or larger across-scan rotation for the two FoVs.

The goal of the Gaia First Look team is to permanently assess the quality of daily data from the Gaia satellite during the mission; the observed asymmetry in the scanning law for the two FoVs has consequences for the correct interpretation of the measurements. The inhomogeneity in the sky coverage caused by the asymmetry is much smaller than that anticipated from various operational data loss sources.

Figures courtesy of Stefan Jordan (Astronomisches Rechen-Institut, Heidelberg, Germany). Claus Fabricius and Jordi Portell (Universidad de Barcelona, Spain) and Uli Bastian (Astronomisches Rechen-Institut, Heidelberg, Germany) also contributed to the interpretation of the asymmetry.

[Published: 23/07/2010]

Picture of the Week

Surprising finding in the one-day sky coverage of Gaia

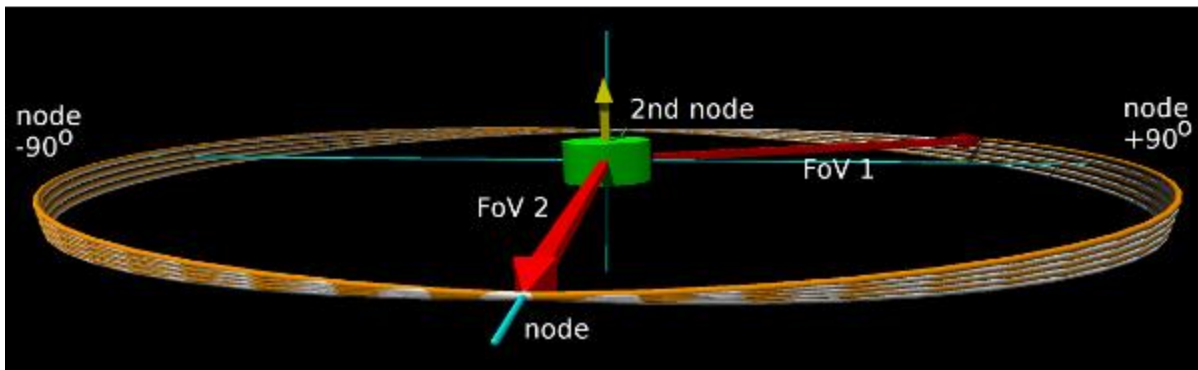
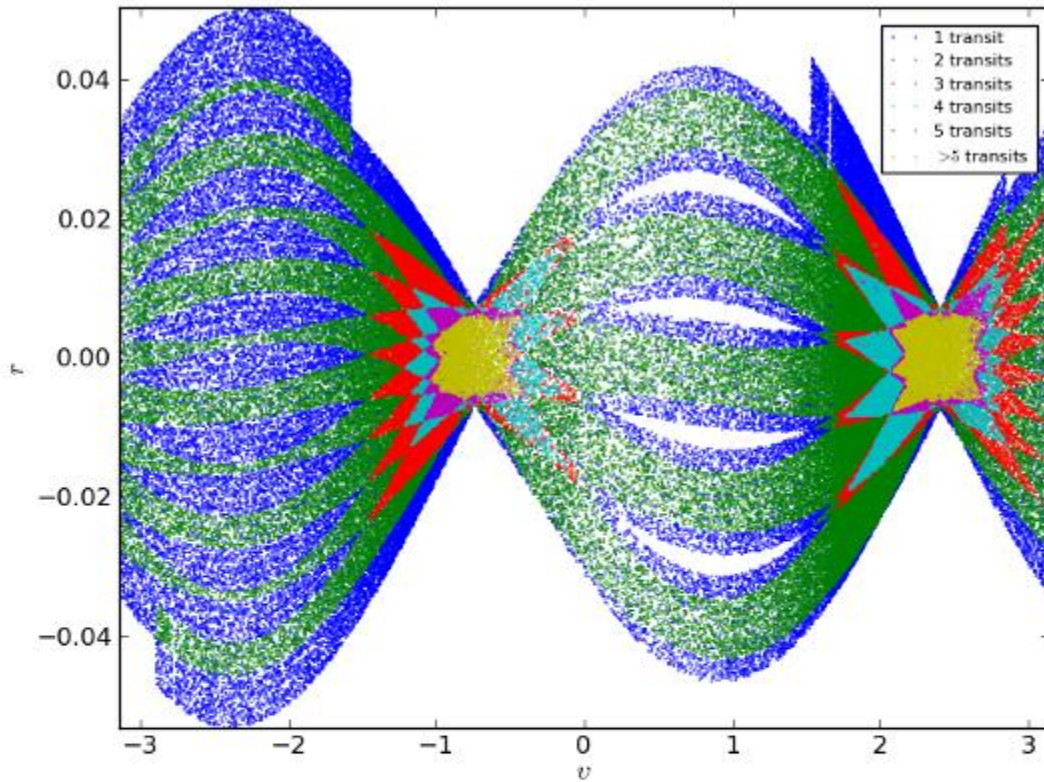

In the course of the scientific validation of simulated test data covering a time period of 1.3 days, the Gaia First Look team discovered a feature in the sky coverage that was first thought to be an error in the simulation: gaps in the sky coverage.

The Figure above shows the coordinates of 200,000 stars which according to the simulations are measured in the direction of Gaia's two fields of view (FoVs) within 31 hours. During such a short period of time Gaia varies its scanning direction by only about 6 degrees (see Figure above). The coordinate "v" (measured from $-\pi$ to $+\pi$ or -180° to $+180^\circ$, respectively) on the abscissa is an angle measured around the mean scanning direction of the day; the perpendicular direction "r" (from -0.05 to 0.05 or -3° to $+3^\circ$, respectively) is strongly stretched for better visibility.

For a given star the colour shows how often a star has been measured by one of the FoVs during the 31 hour period: as expected those stars close to the nodes of the scanning law - where the scans intersect - are measured more than five times (colour coded in yellow) while some stars $\pm 90^\circ$ away in along-scan direction (marked in blue) are scanned only once or twice (green colour).

Surprisingly, not only to the First Look team, the region to the right of the center of the Figure even showed gaps where stars were not measured at all, while on the other half of the scan circle a stronger overlap between consecutive scans was seen. The actual size of the gaps is about 100° along-scan and 0.16° across-scan.

Only a few days ago an explanation for these gaps has been found: it is due to the fact that the projections of the sky from the two different fields of view on a given CCD are offset in the across-scan direction. This effectively leads to a smaller or larger across-scan rotation for the two FoVs.

The goal of the Gaia First Look team is to permanently assess the quality of daily data from the Gaia satellite during the mission; the observed asymmetry in the scanning law for the two FoVs has consequences for the correct interpretation of the measurements. The inhomogeneity in the sky coverage caused by the asymmetry is much smaller than that anticipated from various operational data loss sources.

Figures courtesy of Stefan Jordan (Astronomisches Rechen-Institut, Heidelberg, Germany). Claus Fabricius and Jordi Portell (Universidad de Barcelona, Spain) and Uli Bastian (Astronomisches Rechen-Institut, Heidelberg, Germany) also contributed to the interpretation of the asymmetry.

[Published: 23/07/2010]

Picture of the Week

The quest for the Sun's siblings. An explanatory search in the Hipparcos Catalogue

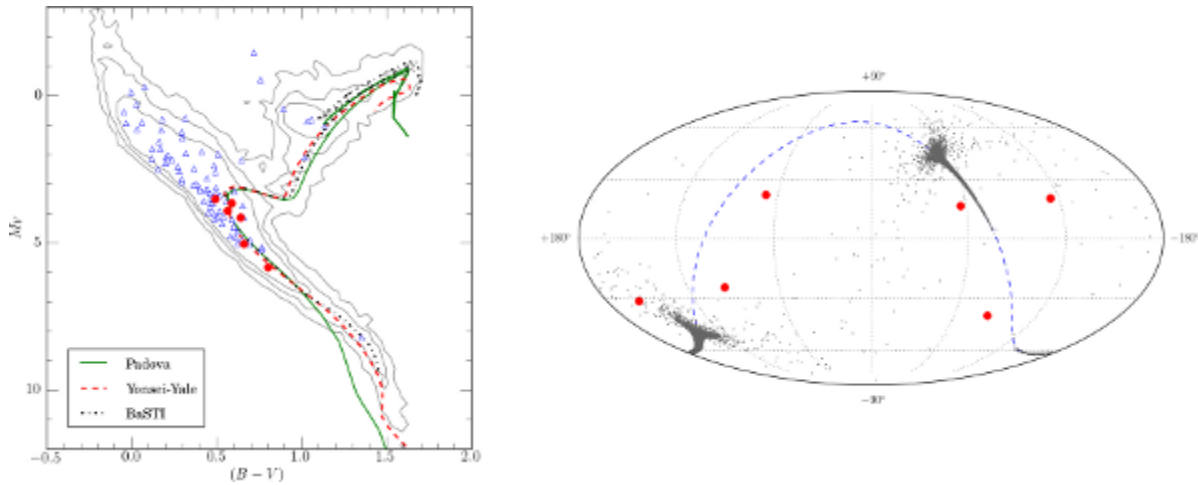

Left figure: Colour magnitude diagram showing the absolute magnitude M_V vs $(B-V)$. The contours show the distribution in this diagram of the stars in the Hipparcos Catalogue with $\sigma_{\varpi}/\varpi \leq 0.1$ and $\sigma_{(B-V)} \leq 0.05$. The contours show the numbers of stars in bins of $0.05 \times 0.2 \text{ mag}^2$, where the contour levels are at 5, 20, 50 and 500 stars/bin. The triangles are the candidate siblings selected to be nearby and have small proper motions, and the large dots are the siblings selected from the Geneva-Copenhagen Survey catalogue with ages consistent with that of the Sun (4.6 Gyr). The solid line shows the isochrone at the age and metallicity of the Sun according to the Padova models, the dashed line shows the same isochrone for the Yonsei-Yale models, and the dot-dashed line for the BaSTI models.

Right figure: Sky distribution in Equatorial coordinates of the six candidate siblings (large dots) of the Sun. The small dots show the distribution of the siblings according to one of the simulations show in figure 1 of the paper. The siblings are concentrated along the Sun's orbit through the smooth Galactic potential. The two large clumps are distant concentrations of stars toward $l=90^\circ$ and $l=270^\circ$. The narrow 'tails' point toward the Galactic centre. The other stars are nearby and thus more spread out over the sky. The dashed line outlines the Galactic plane.

Following the predictions by Portegies Zwart on the possible whereabouts of the lost siblings of the Sun (i.e. stars born in the same cluster as the Sun, see [PoW published on 21/04/2009](#)), a search for potential siblings was conducted in the Hipparcos Catalogue (using the new reduction, see [PoW published on 24/02/2009](#)). This search is based on the predicted phase space

distribution of the Sun's siblings from simple simulations of the orbits of the cluster stars in a smooth Galactic potential. For stars within 100 pc the simulations show that it is interesting to examine those that have small space motions relative to the Sun. From amongst the candidate siblings thus selected there are six stars with ages consistent with that of the Sun. Considering their radial velocities and abundances only one potential candidate, HIP 21158, remains but essentially the result of the search is negative. This is consistent with predictions on the number of siblings near the Sun. The research was carried out by Anthony Brown, Simon Portegies Zwart (both Leiden Observatory) and Jennifer Bean (Missouri State University) and is published in [MNRAS in September 2010](#).

Brown and Portegies Zwart will continue the theoretical work of understanding how star clusters dissolve in a realistic Galactic potential in order to better prepare future searches for the Sun's siblings in the Gaia catalogue.

A larger version of the pictures is also available:

- [left figure](#)
- [right figure](#)

[Published: 27/08/2010]

Picture of the Week

Delivery of Gaia's two large mirrors: M1 and M'1



Picture courtesy of ESA / EADS Astrium / Safran - Sagem

Gaia contains two identical telescopes, pointing in two directions separated by a 106.5° basic angle and merged into a common path at the exit pupil. The optical path of both telescopes is composed of six reflectors (M1-M6), the last two of which are common (M5-M6) (see [more information](#)).

M1 is the primary mirror of each telescope. It is a rectangular off-axis mirror (concave surface) of dimension 1.490m x 0.540m. After final acceptance, M1 has been delivered to the EADS Astrium facilities in Toulouse by Safran-Sagem on the 3rd September 2010. There it will be integrated onto the torus (see [more information](#)).

You can find more information in the [Science and Technology](#) web site.

A larger version of the picture is also [available](#).

[Published: 14/09/2010]

Picture of the Week

Measuring stellar parameters and interstellar extinction with Gaia

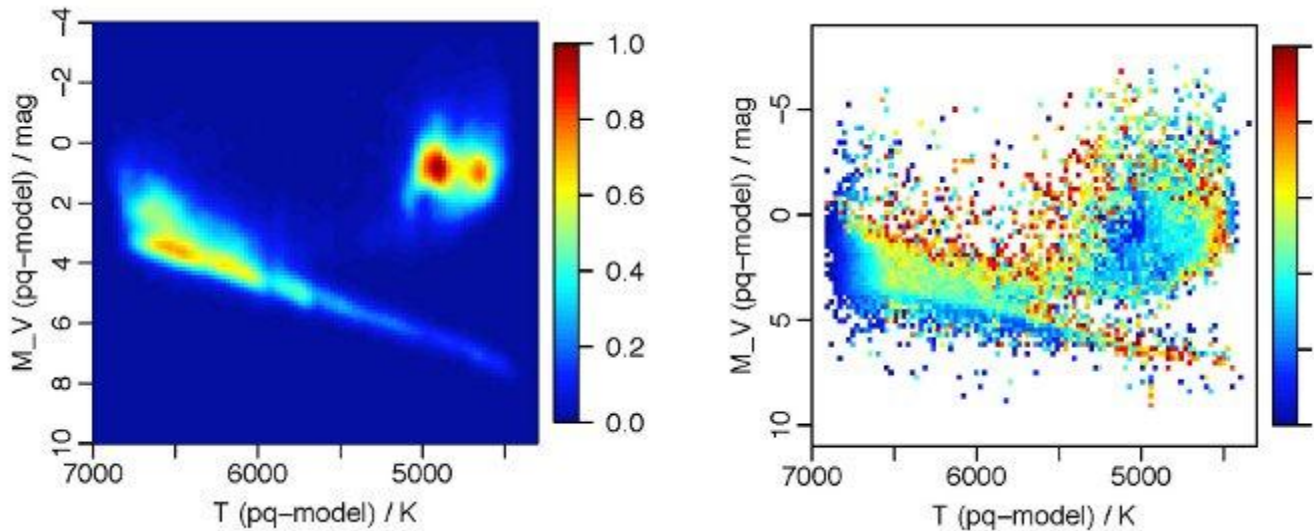

The standard way of deducing the parameters of stars is to compare their observed spectra, or colours, with those spectra predicted by models. This can be done using the BP/RP and/or RVS spectrographs on Gaia (see for example the [Picture of the Week published on 27/1/2009](#)). Yet because Gaia will measure accurate distances to many stars, we can use the distance along with the apparent magnitude in order to estimate the absolute (intrinsic) magnitude, a fundamental property of any star. Still this can only be done if the amount of interstellar absorption can be corrected for. While this absorption can in principle be estimated from the photometry or spectrum, its determination is then often very degenerate with the effective temperature of the star, meaning that neither can be estimated very accurately.

Coryn Bailer-Jones has developed a method for using not only the spectrum, but also the parallax and the laws of stellar evolution, in order to better constrain the stellar parameters. This method provides not just a single parameter estimate for each star, but a probability distribution over the estimated parameters, thereby providing a useful measure of uncertainty on the estimates.

The method has been applied to a set of 85 000 stars with Hipparcos parallaxes and optical/infrared BVJHK photometry. The left picture above shows the inferred parameters of these stars plotted in the Hertzsprung-Russell diagram, using a colour scale to indicate the relative density of the stars. Clearly observable is the stellar main sequence, above and to the right of which lie the giant stars. The right picture shows the same data, but now using the colour scale to illustrate the average interstellar absorption at each point. The method and further results are described in more detail in the [following article](#), which will appear shortly in the journal MNRAS. A catalogue of the parameter estimations is also available from that web site.

This method is under development within Coordination Unit 8 in the DPAC, and is currently being implemented into the Gaia data processing pipeline. It is also being extended further, e.g. to include metallicity and an adaptable mode of the Galactic extinction.

[A larger version of both figures is available: [left figure](#); [right figure](#)]

[Published: 28/09/2010]

Picture of the Week

Gaia broad band photometry

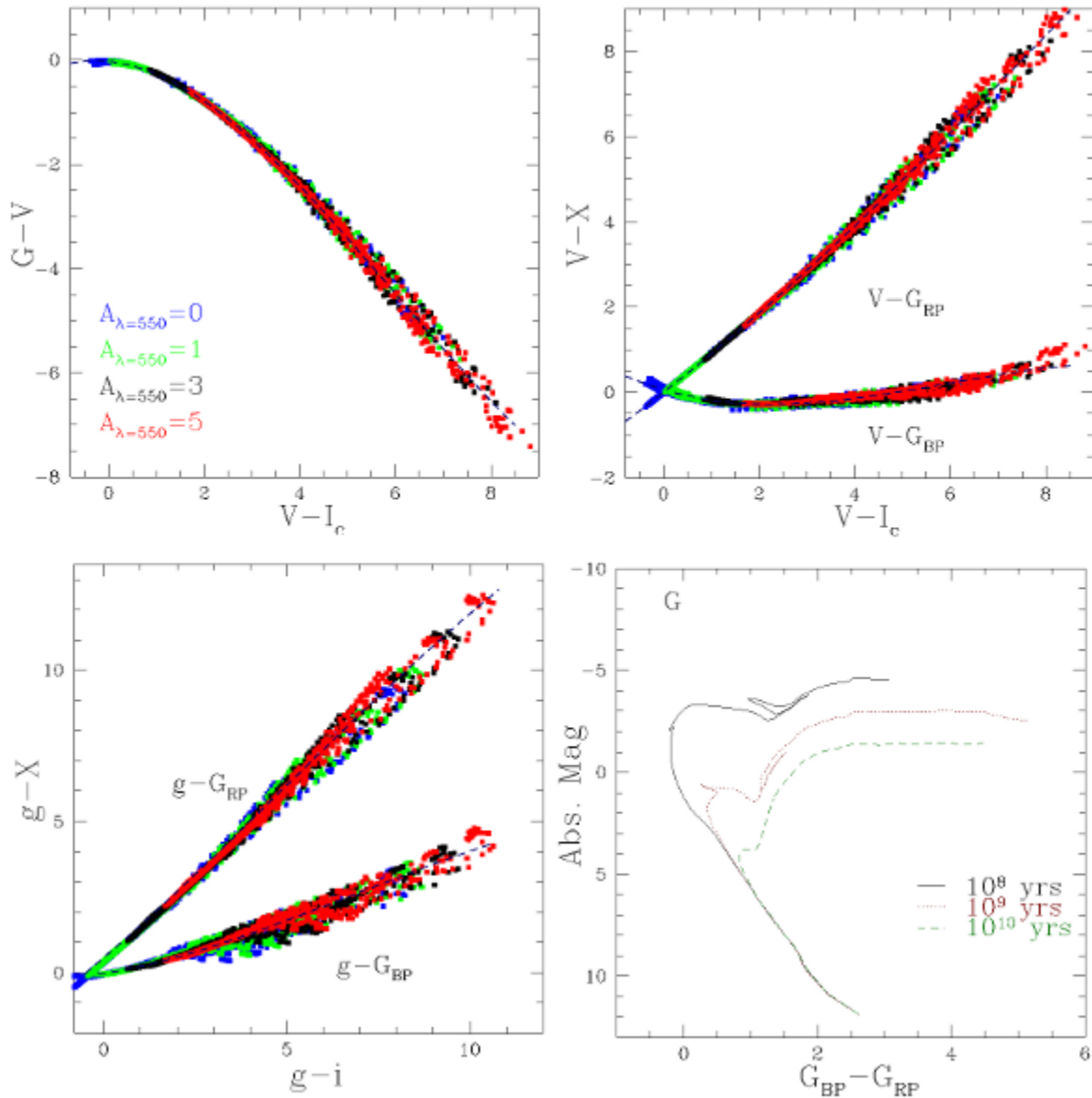

A recently accepted [paper](#) by A&A (Jordi et al., 2010) characterizes the Gaia passbands (G, G_{BP} , G_{RP} , and G_{RVS}) based on the most up-to-date information from the industrial partners. Not all data are yet real measurements of flight hardware, but close enough for the scientific exploitation preparation.

Gaia magnitudes and colours have been computed for all spectral energy distributions in the BaSeL3.1 stellar library and for four reddening values. In addition, colours in the most commonly used photometric systems (Johnson-Cousins, Hipparcos-Tycho, and SDSS) have also

been derived. All the computed colours are provided in an online table. Based on this table, colour-colour transformations have been calculated.

The transformations involving Gaia and Johnson-Cousins (V-Ic) and Sloan DSS (g-z) colours have the lowest residuals. A polynomial expression for the relation between the effective temperature and the colour $G_{BP}-G_{RP}$ is derived for stars with $T_{\text{eff}} > 4500\text{K}$. For stars with $T_{\text{eff}} < 4500\text{K}$, dispersions exist in gravity and metallicity for each absorption value in (g-r) and (r-i). Transformations involving two Johnson or two Sloan DSS colours yield lower residuals than using only one colour. The paper also computes several ratios of total-to-selective absorption including absorption in the G passband (A_G) and colour excess $E(G_{BP}-G_{RP})$ for the sample stars. A relationship involving A_G/A_V and the intrinsic (V-I_c) colour is provided. Bolometric corrections have been computed in Gaia's passbands, which allows the correspondence between absolute Gaia magnitudes and luminosity. In addition, the derived Gaia passbands have been used to compute tracks and isochrones using the Padova and BASTI models, and the passbands have been included in both web sites. Finally, the performances of the predicted Gaia magnitudes are estimated according to the magnitude and the celestial coordinates of the star.

All the ingredients and tools presented in the paper can be used to predict how the Gaia sky will look, in which conditions a known object will be observed, etc. Besides the G, G_{BP} , G_{RP} and G_{RVS} photometry, low-resolution BP and RP spectra will be available. It is necessary to emphasize that these BP and RP spectra are the best suited elements to derive astrophysical parameters of the observed objects because they have been designed for exactly this goal. However, a lot of research can be done with only a colour-magnitude diagram, and the paper can be used for this. Furthermore, for very faint objects or in the early releases of the mission (when few observations are available per object), broad band photometry may be the only available product. The results in the paper can be used also to plan ground-based complementary observations and to build catalogues with auxiliary data for the Gaia data processing and validation.

A larger version of the pictures is also available:

- [left top image](#)
- [right top image](#)
- [left bottom image](#)
- [right bottom image](#)

[Published: 13/10/2010]

Picture of the Week

Eclipsing binary light curves fitted with DPAC code

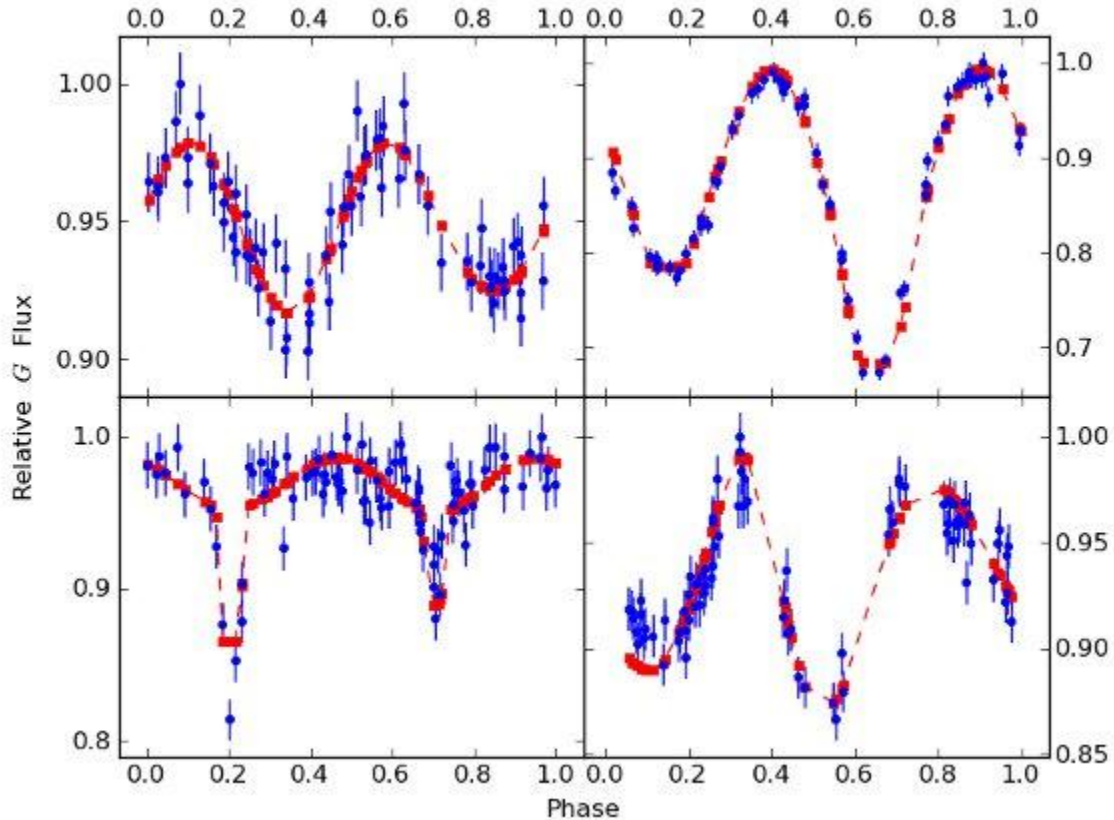

In the course of its mission, Gaia is expected to obtain multicolour epoch photometry ("light curves") for at least several hundred thousand, and possibly up to several million, eclipsing binaries, most of them previously unknown. Spectroscopic data (radial velocity curves) are also expected to be available for a subset of these systems.

The Eclipsing Binaries Development Unit is responsible for processing the light and radial velocity curves of systems identified as eclipsing binaries upstream in the pipeline (mainly by CU7). The aim is to extract as much useful information about the physical parameters of these systems as allowed by the quality of the data, the requirement for an automatic processing, and infrastructure constraints (e.g., the availability of CPU resources). This task is accomplished by comparing the observables (photometry and spectroscopy) with model light curves of known physical parameters, and picking the model that "best" fits the observables in a maximum-likelihood (least squares) sense.

In general, finding the best model is not a trivial task because the least-squares function is not

quadratic in the model parameters. For this reason, a two-step procedure is followed. First, the observations are compared to a database of precalculated models spanning a wide range in parameter space in order to find the model closest to the observations. The parameters of this model are then used as initial estimates for a least-squares optimization that homes in on the nearest minimum. This approach improves the chances of finding the globally best solution, rather than falling into a local minimum "trap".

The four figures shown here, provided by DU436FirstPublicLight (2010), illustrate some early results from this endeavour. The blue circles with associated error bars represent simulated observations of eclipsing binaries in the G band, generated by CU2. The fluxes are scaled so that the brightest datapoint in each curve correspond to a flux of one. The size of the error bars varies depending on the apparent G magnitude of each binary, with smaller error bars implying a brighter system. Phases are calculated from transit times assuming that the period of variability is known (as provided by CU2). Transit times were sampled according to the Gaia scanning law, resulting in between 68 and 89 transits. Finally, the red squares represent the flux predictions of the best-fit model for the same times. The dashed lines are straight-line segments that simply connect the red squares.

The quality of the fits is overall quite good. However, work is under way to improve on several aspects of the procedure. The current priorities are (i) to incorporate multicolour photometry and radial velocity information in the fitting procedure (currently only the G-band photometry is fit); (ii) to make a number of performance improvements, for example in the calculation of models with elliptical orbits which is time-consuming because of the need to recalculate the Roche geometry as the distance between the two stars varies; (iii) to optimize the parameter coverage of the model database; and (iv) to implement an intelligent way of dealing with errors in period determination, and in particular with period aliasing, which will become issues when the period is calculated from the data. Because the period will be an output of CU7 and, sometimes, of the Spectroscopic Binaries Development Unit as well, the Eclipsing Binaries Development Unit is in collaboration with these Units to ensure an efficient handling of the problem.

A larger version of the picture is also [available](#).

[Published: 27/10/2010]

Picture of the Week

European-Japanese collaboration. Nano-JASMINE and AGIS

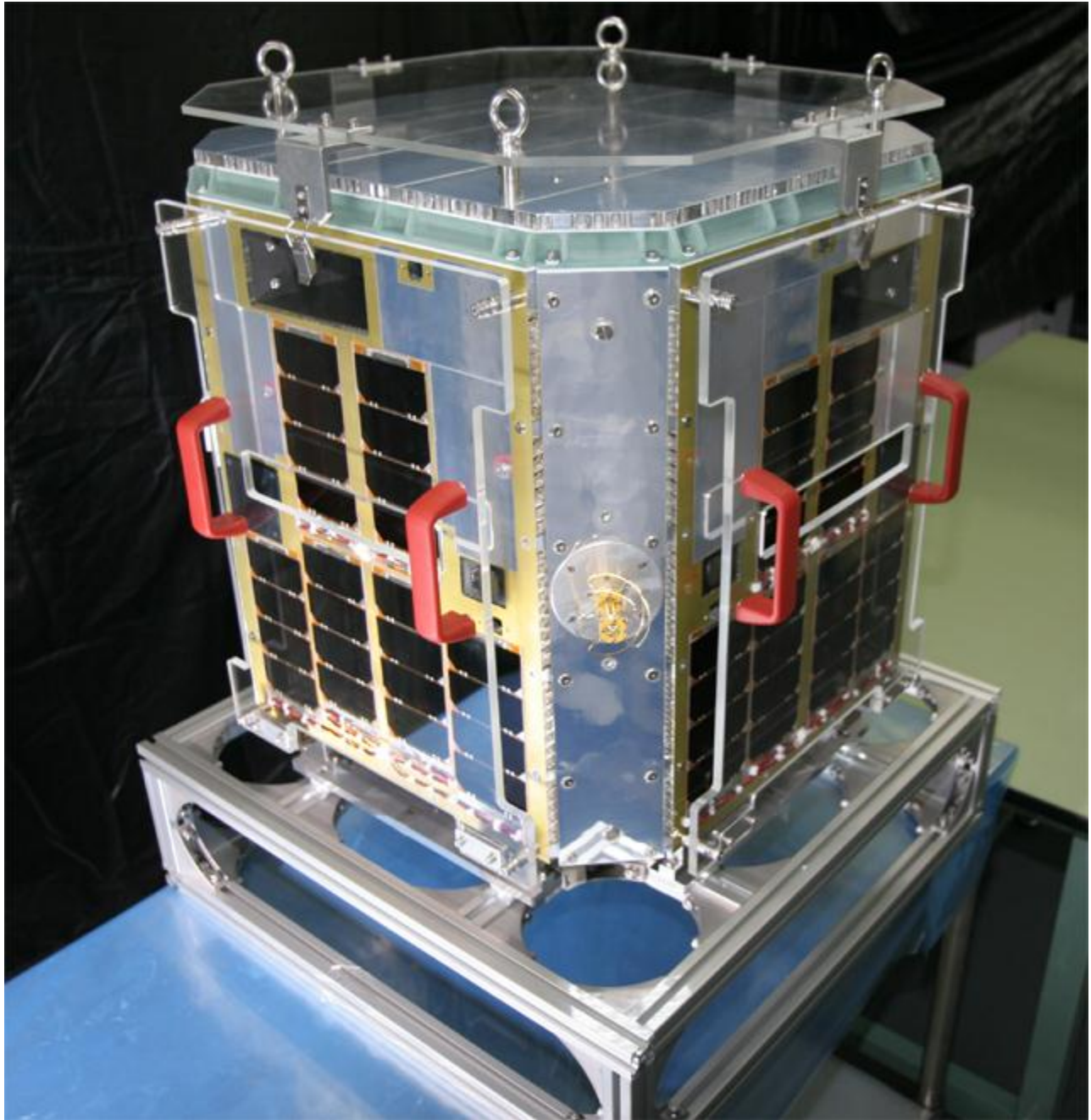

This week's Gaia picture features a small low-cost Japanese satellite called Nano-JASMINE, weighing a mere 35 kg with about the size of a small fridge. Is it the first astrometric mission of Japan and will determine the positions, proper motions and parallaxes of roughly a million stars within its two year mission time, providing a level of accuracy similar to Hipparcos (mas). Its

purpose is the gathering of experience to prepare for the pointed infrared astrometry missions "Small-JASMINE" and "JASMINE" with an expected launch in 2016 and in the 2020s, respectively, which will augment the Gaia catalogue with objects hidden from Gaia's optical eyes through interstellar dust. Nano-JASMINE will be launched on a newly developed Cyclone-4 rocket from the Brazilian Alcantara space port into a sun-synchronous circumpolar low-earth orbit.

The AGIS team of Gaia supports Nano-JASMINE by providing the data processing with AGIS - thus giving the Gaia mission the benefit of a full test run with real observation data well before AGIS will run on any Gaia data. This will lead to a strengthening of AGIS' robustness and quality. Furthermore AGIS will be used to combine the resulting star catalogue with the 20 years old Hipparcos data. This way we aim to offer scientists around the world much improved proper motions leading to a better understanding of galactic dynamics.

We believe that this is a genuine demonstration of the cohesion within the world-wide astronomic community. We are looking forward to this collaboration and would like to express our best wishes for the foreseen launch in August 2011.

For more information, visit:

- [The University of Tokyo & National Astronomical Observatory of Japan web site](#)
- [Nano-JASMINE web site](#)

Picture: Nano-JASMINE flight model (courtesy of JASMINE team)

[Published: 17/11/2010]

Picture of the Week

The 100th member of CU3



On Dec 17, DPAC's "Core Processing" coordination unit (CU3), the biggest and most complex one among the eight existing CUs, has reached the magic number of 100 active members. The record was set by the addition of Chris Skoog, a new master student at Lund Observatory. In January he will start to work on AGIS-related topics for his master thesis - and of course also for the benefit of the final AGIS solution, to be derived in 2021 or so.

The picture shows the 100th member (top left), along with the group photo of the very first CU3 plenary meeting (top right, February 2006 at Heidelberg, with 37 attendees out of about 55 members at the time) and the group photo of the as-yet biggest CU3 meeting (bottom, April 2009 at Torino, with 57 out of about 90 members at the time).

With quite some probability Chris will leave CU3 in about a year, when he has got his master degree. But the number of CU3 members will drop back to below 100 much sooner, actually within a few weeks: At the beginning of each calendar year the CU3 manager checks whether all names on the list are actually still there and active. In this way, in every January a few people

(typically less than a handful) are found who left "unnoticed" during the year: Students who finished their terms, postdocs who moved to other areas, or meritorious older colleagues who retired. The actual number of departures per year is of course higher than that.

[Published: 21/12/2010]