

Forgotten Books

— www.forgottenbooks.com —

Copyright © 2016 FB &c Ltd.

All rights reserved. No part of this publication may be reproduced, distributed, or transmitted in any form or by any means, including photocopying, recording, or other electronic or mechanical methods, without the prior written permission of the publisher, except in the case of brief quotations embodied in critical reviews and certain other noncommercial uses permitted by copyright law.

A HISTORY
OF
GREEK MATHEMATICS

BY

SIR THOMAS HEATH

K.C.B., K.C.V.O., F.R.S.

SC.D. CAMB. ; HON. D.SC. OXFORD

HONORARY FELLOW (FORMERLY FELLOW) OF TRINITY COLLEGE, CAMBRIDGE

‘ . . . An independent world,
Created out of pure intelligence.’

WORDSWORTH.

VOLUME II

FROM ARISTARCHUS TO DIOPHANTUS

O X F O R D

AT THE CLARENDON PRESS

1921

OXFORD UNIVERSITY PRESS

London Edinburgh Glasgow Copenhagen

New York Toronto Melbourne Cape Town

Bombay Calcutta Madras Shanghai

HUMPHREY MILFORD

Publisher to the University

CONTENTS OF VOL. II

XII. ARISTARCHUS OF SAMOS	PAGES 1-15
XIII. ARCHIMEDES :	16-109
Traditions	
(<i>a</i>) Astronomy	17-18
(<i>s</i>) Mechanics	18
Summary of main achievements	19-20
Character of treatises	20-22
List of works still extant	22-23
Traces of lost works	23-25
The text of Archimedes	25-27
Contents of <i>The Method</i>	27-34
<i>On the Sphere and Cylinder</i> , I, II	34-50
Cubic equation arising out of II. 4	43-46
(i) Archimedes's own solution	45-46
(ii) Dionysodorus's solution	46
(iii) Diocles's solution of original problem	47-49
<i>Measurement of a Circle</i>	50-56
<i>On Conoids and Spheroids</i>	56-64
<i>On Spirals</i>	64-75
<i>On Plane Equilibriums</i> , I, II	75-81
<i>The Sand-reckoner (Psammites or Arenarius)</i>	81-85
<i>The Quadrature of the Paraboloid</i>	85-91
<i>On Floating Bodies</i> , I, II	91-97
The problem of the crown	92-94
Other works	
(<i>a</i>) The Cattle-Problem	97-98
(<i>s</i>) On semi-regular polyhedra	98-101
(<i>γ</i>) <i>The Liber Assumptorum</i>	101-103
(<i>δ</i>) Formula for area of triangle	103
Eratosthenes	104-109
Measurement of the Earth	106-108
XIV. CONIC SECTIONS. APOLLONIUS OF PERGA	110-196
A. HISTORY OF CONICS UP TO APOLLONIUS	110-126
Discovery of the conic sections by Menaechmus	110-111
Menaechmus's probable procedure	111-116
Works by Aristaeus and Euclid	116-117
'Solid loci' and 'solid problems'	117-118
Aristaeus's <i>Solid Loci</i>	118-119
Focus-directrix property known to Euclid	119
Proof from Pappus	120-121
Propositions included in Euclid's <i>Conics</i>	121-122
Conic sections in Archimedes	122-126

XIV. CONTINUED.

B. APOLLONIUS OF PERGA	PAGES	126-196
The text of the <i>Conics</i>		126-128
Apollonius's own account of the <i>Conics</i>		128-133
Extent of claim to originality		132-133
Great generality of treatment		133
Analysis of the <i>Conics</i>		133-175
Book I		133-148
Conics obtained in the most general way from oblique cone		134-138
New names, 'parabola', 'ellipse', 'hyperbola'		138-139
Fundamental properties equivalent to Cartesian equations		139-141
Transition to new diameter and tangent at its extremity		141-147
First appearance of principal axes		147-148
Book II		148-150
Book III		150-157
Book IV		157-158
Book V		158-167
Normals as maxima and minima		159-163
Number of normals from a point		163-164
Propositions leading immediately to determination of <i>evolute</i> of conic		164-166
Construction of normals		166-167
Book VI		167-168
Book VII		168-174
Other works by Apollonius		175-194
(α) <i>On the Cutting-off of a Ratio</i> (λόγου ἀποτομή), two Books		175-179
(β) <i>On the Cutting-off of an Area</i> (χωρίου ἀποτομή), two Books		179-180
(γ) <i>On Determinate Section</i> (διωρισμένη τομή), two Books		180-181
(δ) <i>On Contacts or Tangencies</i> (ἐπαφαί), two Books		181-185
(ε) <i>Plane Loci</i> , two Books		185-189
(ζ) <i>Νεύσεις</i> (<i>Vergings</i> or <i>Inclinations</i>), two Books		189-192
(η) <i>Comparison of dodecahedron with icosahedron</i>		192
(θ) <i>General Treatise</i>		192-193
(ι) <i>On the Cochlias</i>		193
(κ) <i>On Unordered Irrationals</i>		193
(λ) <i>On the Burning-mirror</i>		194
(μ) Ὠκυτόκιον		194
Astronomy		195-196

XV. THE SUCCESSORS OF THE GREAT GEOMETERS . 197-234

Nicomedes	199
Diocles	200-203
Perseus	203-206
Isoperimetric figures. Zenodorus	206-213
Hypsicles	213-218
Dionysodorus	218-219
Posidonius	219-222

Geminus	PAGES	222-234
Attempt to prove the Parallel-Postulate		227-230
On <i>Meteorologica</i> of Posidonius		231-232
<i>Introduction to the Phaenomena</i> attributed to Geminus		232-234

XVI. SOME HANDBOOKS 235-244

Cleomedes, <i>De motu circulari</i>	235-238
Nicomachus	238
Theon of Smyrna, <i>Expositio rerum mathematicarum ad legendum Platonem utilium</i>	238-244

XVII. TRIGONOMETRY: HIPPARCHUS, MENELAUS, PTOLEMY 245-297

Theodosius	245-246
Works by Theodosius	246
Contents of the <i>Sphaerica</i>	246-252
No actual trigonometry in Theodosius	250-252
The beginnings of trigonometry	252-253
Hipparchus	253-260
The work of Hipparchus	254-256
First systematic use of trigonometry	257-259
Table of chords	259-260
Menelaus	260-273
The <i>Sphaerica</i> of Menelaus	261-273
(a) 'Menelaus's theorem' for the sphere	266-268
(β) Deductions from Menelaus's theorem	268-269
(γ) Anharmonic property of four great circles through one point	269-270
(δ) Propositions analogous to Eucl. VI. 3	270
Claudius Ptolemy	273-297
The <i>Μαθηματικὴ σύνταξις</i> (Arab. <i>Almagest</i>)	273-286
Commentaries	274
Translations and editions	274-275
Summary of contents	275-276
Trigonometry in Ptolemy	276-286
(a) Lemma for finding $\sin 18^\circ$ and $\sin 36^\circ$	277-278
(β) Equivalent of $\sin^2 \theta + \cos^2 \theta = 1$	278
(γ) 'Ptolemy's theorem', giving the equivalent of $\sin(\theta - \phi) = \sin \theta \cos \phi - \cos \theta \sin \phi$	278-280
(δ) Equivalent of $\sin^2 \frac{1}{2} \theta = \frac{1}{2} (1 - \cos \theta)$	280-281
(ε) Equivalent of $\cos(\theta + \phi) = \cos \theta \cos \phi - \sin \theta \sin \phi$	281
(ζ) Method of interpolation based on formula $\sin a / \sin \beta < a / \beta$ ($\frac{1}{2} \pi > a > \beta$)	281-282
(η) Table of chords	283
(θ) Further use of proportional increase	283-284
(ι) Plane trigonometry in effect used	284
Spherical trigonometry: formulae in solution of spherical triangles	284-286
The <i>Analemma</i>	286-292
The <i>Planisphaerium</i>	292-293
The <i>Optics</i>	293-295
A mechanical work, <i>Περὶ ῥοπαῶν</i>	295
Attempt to prove the Parallel-Postulate	295-297

XVIII. MENSURATION: HERON OF ALEXANDRIA.	PAGES	298-354
Controversies as to Heron's date		298-306
Character of works		307-308
List of treatises		308-310
Geometry		
(a) Commentary on Euclid's <i>Elements</i>		310-314
(β) The <i>Definitions</i>		314-316
Mensuration		316-344
The <i>Metrica, Geometrica, Stereometrica, Geodaesia, Mensurae</i>		316-320
Contents of the <i>Metrica</i>		320-344
Book I. Measurement of areas		320-331
(a) Area of scalene triangle		320-321
Proof of formula $\Delta = \sqrt{\{s(s-a)(s-b)(s-c)\}}$		321-323
(β) Method of approximating to the square root of a non-square number		323-326
(γ) Quadrilaterals		326
(δ) Regular polygons with 3, 4, 5, 6, 7, 8, 9, 10, 11, or 12 sides		326-329
(ε) The circle		329
(ζ) Segment of a circle		330-331
(η) Ellipse, parabolic segment, surface of cylinder, right cone, sphere and segment of sphere		331
Book II. Measurement of volumes		331-335
(a) Cone, cylinder, parallelepiped (prism), pyramid and frustum		332
(β) Wedge-shaped solid (<i>βωμίσκος</i> or <i>σφηνίσκος</i>)		332-334
(γ) Frustum of cone, sphere, and segment thereof		334
(δ) Anchor-ring or tore		334-335
(ε) The two special solids of Archimedes's 'Method'		335
(ζ) The five regular solids		335
Book III. Divisions of figures		336-343
Approximation to the cube root of a non-cube number		341-342
Quadratic equations solved in Heron		344
Indeterminate problems in the <i>Geometrica</i>		344
The <i>Dioptra</i>		345-346
The <i>Mechanics</i>		346-352
Aristotle's Wheel		347-348
The parallelogram of velocities		348-349
Motion on an inclined plane		349-350
On the centre of gravity		350-351
The five mechanical powers		351
Mechanics in daily life: queries and answers		351-352
Problems on the centre of gravity, &c.		352
The <i>Catoptrica</i>		352-354
Heron's proof of equality of angles of incidence and reflection		353-354
XIX. PAPPUS OF ALEXANDRIA		355-439
Date of Pappus		356
Works (commentaries) other than the <i>Collection</i>		356-357

	PAGES
The <i>Synagoge</i> or <i>Collection</i>	357-439
(α) Character of the work; wide range	357-358
(β) List of authors mentioned	358-360
(γ) Translations and editions	360-361
(δ) Summary of contents	361-439
Book III. Section (1). On the problem of the two mean proportionals	361-362
Section (2). The theory of means	363-365
Section (3). The 'Paradoxes' of Erycinus	365-368
Section (4). The inscribing of the five regular solids in a sphere	368-369
Book IV. Section (1). Extension of theorem of Pythagoras	369-371
Section (2). On circles inscribed in the $\alpha\rho\beta\eta\lambda\omicron\varsigma$ ('shoemaker's knife')	371-377
Sections (3), (4). Methods of squaring the circle and trisecting any angle	377-386
(α) The Archimedean spiral	377-379
(β) The conchoid of Nicomedes	379
(γ) The <i>Quadratrix</i>	379-382
(δ) Digression: a spiral on a sphere	382-385
Trisection (or division in any ratio) of any angle	385-386
Section (5). Solution of the $\nu\epsilon\delta\omicron\varsigma\iota\varsigma$ of Archimedes, <i>On Spirals</i> , Prop. 8, by means of conics	386-388
Book V. Preface on the sagacity of Bees	389-390
Section (1). Isoperimetry after Zenodorus	390-393
Section (2). Comparison of volumes of solids having their surfaces equal. Case of sphere	393-394
Section (3). Digression on semi-regular solids of Archimedes	394
Section (4). Propositions on the lines of Archimedes, <i>On the Sphere and Cylinder</i>	394-395
Section (5). Of regular solids with surfaces equal, that is greater which has more faces	395-396
Book VI.	396-399
Problem arising out of Euclid's <i>Optics</i>	397-399
Book VII. On the 'Treasury of Analysis'	399-427
Definition of Analysis and Synthesis	400-401
List of works in the 'Treasury of Analysis'	401
Description of the treatises	401-404
Anticipation of Guldin's Theorem	403
Lemmas to the different treatises	404-426
(α) Lemmas to the <i>Sectio rationis</i> and <i>Sectio</i> <i>spatii</i> of Apollonius	404-405
(β) Lemmas to the <i>Determinate Section</i> of Apollonius	405-412
(γ) Lemmas on the <i>Neúreis</i> of Apollonius	412-416
(δ) Lemmas on the <i>On Contacts</i> of Apollonius	416-417
(ϵ) Lemmas to the <i>Plane Loci</i> of Apollonius	417-419
(ζ) Lemmas to the <i>Porisms</i> of Euclid	419-424
(η) Lemmas to the <i>Conics</i> of Apollonius	424-425
(θ) Lemmas to the <i>Surface Loci</i> of Euclid	425-426
(ι) An unallocated lemma	426-427
Book VIII. Historical preface	427-429
The object of the Book	429-430
On the centre of gravity	430-433

CONTENTS

XIX. CONTINUED.

Book VIII (<i>continued</i>)	
The inclined plane	PAGES 433-434
Construction of a conic through five points	434-437
Given two conjugate diameters of an ellipse, to find the axes	437-438
Problem of seven hexagons in a circle	438-439
Construction of toothed wheels and indented screws	439

XX. ALGEBRA : DIOPHANTUS OF ALEXANDRIA 440-517

Beginnings learnt from Egypt	440
‘Hau’-calculations	440-441
Arithmetical epigrams in the Greek Anthology	441-443
Indeterminate equations of first degree	443
Indeterminate equations of second degree before Dio- phantus	443-444
Indeterminate equations in Heronian collections	444-447
Numerical solution of quadratic equations	448
Works of Diophantus	448-450
The <i>Arithmetica</i>	449-514
The seven lost Books and their place	449-450
Relation of ‘Porisms’ to <i>Arithmetica</i>	451-452
Commentators from Hypatia downwards	453
Translations and editions	453-455
Notation and definitions	455-461
Sign for unknown ($= x$) and its origin	456-457
Signs for powers of unknown &c.	458-459
The sign (Λ) for <i>minus</i> and its meaning	459-460
The methods of Diophantus	462-479
I. Diophantus’s treatment of equations	462-476
(A) Determinate equations	
(1) Pure determinate equations	462-463
(2) Mixed quadratic equations	463-465
(3) Simultaneous equations involving quadratics	465
(4) Cubic equation	465
(B) Indeterminate equations	
(a) Indeterminate equations of the second degree	466-473
(1) Single equation	466-468
(2) Double equation	468-473
1. Double equations of first degree	469-472
2. Double equations of second degree	472-473
(b) Indeterminate equations of degree higher than second	473-476
(1) Single equations	473-475
(2) Double equations	475-476
II. Method of limits	476-477
III. Method of approximation to limits	477-479
Porisms and propositions in the Theory of Numbers	479-484
(a) Theorems on the composition of numbers as the sum of two squares	481-483
(β) On numbers which are the sum of three squares	483
(γ) Composition of numbers as the sum of four squares	483-484
Conspectus of <i>Arithmetica</i> , with typical solutions	484-514
The treatise on Polygonal Numbers	514-517

XXI. COMMENTATORS AND BYZANTINES	PAGES 518-555
Serenus	519-526
(a) <i>On the Section of a Cylinder</i>	519-522
(β) <i>On the Section of a Cone</i>	522-526
Theon of Alexandria	526-528
Commentary on the <i>Syntaxis</i>	526-527
Edition of Euclid's <i>Elements</i>	527-528
Edition of the <i>Optics</i> of Euclid	528
Hypatia	528-529
Porphry. Iamblichus	529
Proclus	529-537
Commentary on Euclid, Book I	530-535
(a) Sources of the Commentary	530-532
(β) Character of the Commentary	532-535
<i>Hypotyposis of Astronomical Hypotheses</i>	535-536
Commentary on the <i>Republic</i>	536-537
Marinus of Neapolis	537-538
Domninus of Larissa	538
Simplicius	538-540
Extracts from Eudemus	539
Eutocius	540-541
Anthemius of Tralles	541-543
<i>On burning-mirrors</i>	541-543
The Papyrus of Akhmīm	543-545
<i>Geodesia</i> of 'Heron the Younger'	545
Michael Psellus	545-546
Georgius Pachymeres	546
Maximus Planudes	546-549
Extraction of the square root	547-549
Two problems	549
Manuel Moschopoulos	549-550
Nicolas Rhabdas	550-554
Rule for approximating to square root of a non-square number	553-554
Ioannes Pediasimus	554
Barlaam	554-555
Isaac Argyrus	555
 APPENDIX. On Archimedes's proof of the subtangent-property of a spiral	 556-561
 INDEX OF GREEK WORDS	 563-569
 ENGLISH INDEX	 570-586

ARISTARCHUS OF SAMOS

HISTORIANS of mathematics have, as a rule, given too little attention to Aristarchus of Samos. The reason is no doubt that he was an astronomer, and therefore it might be supposed that his work would have no sufficient interest for the mathematician. The Greeks knew better; they called him Aristarchus 'the mathematician', to distinguish him from the host of other Aristarchuses; he is also included by Vitruvius among the few great men who possessed an equally profound knowledge of all branches of science, geometry, astronomy, music, &c.

'Men of this type are rare, men such as were, in times past, Aristarchus of Samos, Philolaus and Archytas of Tarentum, Apollonius of Perga, Eratosthenes of Cyrene, Archimedes and Scopinas of Syracuse, who left to posterity many mechanical and gnomonic appliances which they invented and explained on mathematical (lit. 'numerical') principles.'¹

That Aristarchus was a very capable geometer is proved by his extant work *On the sizes and distances of the Sun and Moon* which will be noticed later in this chapter: in the mechanical line he is credited with the discovery of an improved sun-dial, the so-called *σκάφη*, which had, not a plane, but a concave hemispherical surface, with a pointer erected vertically in the middle throwing shadows and so enabling the direction and the height of the sun to be read off by means of lines marked on the surface of the hemisphere. He also wrote on vision, light and colours. His views on the latter subjects were no doubt largely influenced by his master, Strato of Lampsacus; thus Strato held that colours were emanations from bodies, material molecules, as it were, which imparted to the intervening air the same colour as that possessed by the body, while Aristarchus said that colours are 'shapes or forms

¹ Vitruvius, *De architectura*, i. 1. 16.

stamping the air with impressions like themselves, as it were', that 'colours in darkness have no colouring', and that 'light is the colour impinging on a substratum'.

Two facts enable us to fix Aristarchus's date approximately. In 281/280 B.C. he made an observation of the summer solstice; and a book of his, presently to be mentioned, was published before the date of Archimedes's *Psammites* or *Sand-reckoner*, a work written before 216 B.C. Aristarchus, therefore, probably lived *circa* 310–230 B.C., that is, he was older than Archimedes by about 25 years.

To Aristarchus belongs the high honour of having been the first to formulate the Copernican hypothesis, which was then abandoned again until it was revived by Copernicus himself. His claim to the title of 'the ancient Copernicus' is still, in my opinion, quite unshaken, notwithstanding the ingenious and elaborate arguments brought forward by Schiaparelli to prove that it was Heraclides of Pontus who first conceived the heliocentric idea. Heraclides is (along with one Ecphantus, a Pythagorean) credited with having been the first to hold that the earth revolves about its own axis every 24 hours, and he was the first to discover that Mercury and Venus revolve, like satellites, about the sun. But though this proves that Heraclides came near, if he did not actually reach, the hypothesis of Tycho Brahe, according to which the earth was in the centre and the rest of the system, the sun with the planets revolving round it, revolved round the earth, it does not suggest that he moved the earth away from the centre. The contrary is indeed stated by Aëtius, who says that 'Heraclides and Ecphantus make the earth move, *not in the sense of translation*, but by way of turning on an axle, like a wheel, from west to east, about its own centre'.¹ None of the champions of Heraclides have been able to meet this positive statement. But we have conclusive evidence in favour of the claim of Aristarchus; indeed, ancient testimony is unanimous on the point. Not only does Plutarch tell us that Cleanthes held that Aristarchus ought to be indicted for the impiety of 'putting the Hearth of the Universe in motion'²; we have the best possible testimony in the precise statement of a great

¹ Aët. iii. 13. 3, *Vors.* i³, p. 341. 8.

² Plutarch, *De facie in orbe lunae*, c. 6, pp. 922 F–923 A.

contemporary, Archimedes. In the *Sand-reckoner* Archimedes has this passage.

‘ You [King Gelon] are aware that “universe” is the name given by most astronomers to the sphere the centre of which is the centre of the earth, while its radius is equal to the straight line between the centre of the sun and the centre of the earth. This is the common account, as you have heard from astronomers. But Aristarchus brought out *a book consisting of certain hypotheses*, wherein it appears, as a consequence of the assumptions made, that the universe is many times greater than the “universe” just mentioned. His hypotheses are that *the fixed stars and the sun remain unmoved, that the earth revolves about the sun in the circumference of a circle, the sun lying in the middle of the orbit*, and that the sphere of the fixed stars, situated about the same centre as the sun, is so great that the circle in which he supposes the earth to revolve bears such a proportion to the distance of the fixed stars as the centre of the sphere bears to its surface.’

(The last statement is a variation of a traditional phrase, for which there are many parallels (cf. Aristarchus’s Hypothesis 2 ‘that the earth is in the relation of a point and centre to the sphere in which the moon moves’), and is a method of saying that the ‘universe’ is infinitely great in relation not merely to the size of the sun but even to the orbit of the earth in its revolution about it; the assumption was necessary to Aristarchus in order that he might not have to take account of parallax.)

Plutarch, in the passage referred to above, also makes it clear that Aristarchus followed Heraclides in attributing to the earth the daily rotation about its axis. The bold hypothesis of Aristarchus found few adherents. Seleucus, of Seleucia on the Tigris, is the only convinced supporter of it of whom we hear, and it was speedily abandoned altogether, mainly owing to the great authority of Hipparchus. Nor do we find any trace of the heliocentric hypothesis in Aristarchus’s extant work *On the sizes and distances of the Sun and Moon*. This is presumably because that work was written before the hypothesis was formulated in the book referred to by Archimedes. The geometry of the treatise is, however, unaffected by the difference between the hypotheses.

Archimedes also says that it was Aristarchus who discovered that the apparent angular diameter of the sun is about $1/720$ th part of the zodiac circle, that is to say, half a degree. We do not know how he arrived at this pretty accurate figure: but, as he is credited with the invention of the *σκάφη*, he may have used this instrument for the purpose. But here again the discovery must apparently have been later than the treatise *On sizes and distances*, for the value of the subtended angle is there assumed to be 2° (Hypothesis 6). How Aristarchus came to assume a value so excessive is uncertain. As the mathematics of his treatise is not dependent on the actual value taken, 2° may have been assumed merely by way of illustration; or it may have been a guess at the apparent diameter made before he had thought of attempting to measure it. Aristarchus assumed that the angular diameters of the sun and moon at the centre of the earth are equal.

The method of the treatise depends on the just observation, which is Aristarchus's third 'hypothesis', that 'when the moon appears to us halved, the great circle which divides the dark and the bright portions of the moon is in the direction of our eye'; the effect of this (since the moon receives its light from the sun), is that at the time of the dichotomy the centres of the sun, moon and earth form a triangle right-angled at the centre of the moon. Two other assumptions were necessary: first, an estimate of the size of the angle of the latter triangle at the centre of the earth at the moment of dichotomy: this Aristarchus assumed (Hypothesis 4) to be 'less than a quadrant by one-thirtieth of a quadrant', i. e. 87° , again an inaccurate estimate, the true value being $89^\circ 50'$; secondly, an estimate of the breadth of the earth's shadow where the moon traverses it: this he assumed to be 'the breadth of two moons' (Hypothesis 5).

The inaccuracy of the assumptions does not, however, detract from the mathematical interest of the succeeding investigation. Here we find the logical sequence of propositions and the absolute rigour of demonstration characteristic of Greek geometry; the only remaining drawback would be the practical difficulty of determining the exact moment when the moon 'appears to us halved'. The form and style of the book are thoroughly classical, as befits the period between Euclid and Archimedes;

the Greek is even remarkably attractive. The content from the mathematical point of view is no less interesting, for we have here the first specimen extant of pure geometry used with a *trigonometrical* object, in which respect it is a sort of forerunner of Archimedes's *Measurement of a Circle*. Aristarchus does not actually evaluate the trigonometrical ratios on which the ratios of the sizes and distances to be obtained depend; he finds limits between which they lie, and that by means of certain propositions which he assumes without proof, and which therefore must have been generally known to mathematicians of his day. These propositions are the equivalents of the statements that,

(1) if α is what we call the circular measure of an angle and α is less than $\frac{1}{2}\pi$, then the ratio $\sin \alpha/\alpha$ *decreases*, and the ratio $\tan \alpha/\alpha$ *increases*, as α increases from 0 to $\frac{1}{2}\pi$;

(2) if β be the circular measure of another angle less than $\frac{1}{2}\pi$, and $\alpha > \beta$, then

$$\frac{\sin \alpha}{\sin \beta} < \frac{\alpha}{\beta} < \frac{\tan \alpha}{\tan \beta}.$$

Aristarchus of course deals, not with actual circular measures, sines and tangents, but with angles (expressed not in degrees but as fractions of right angles), arcs of circles and their chords. Particular results obtained by Aristarchus are the equivalent of the following:

$$\frac{1}{18} > \sin 3^\circ > \frac{1}{20}, \quad [\text{Prop. 7}]$$

$$\frac{1}{45} > \sin 1^\circ > \frac{1}{60}, \quad [\text{Prop. 11}]$$

$$1 > \cos 1^\circ > \frac{89}{90}, \quad [\text{Prop. 12}]$$

$$1 > \cos^2 1^\circ > \frac{44}{45}. \quad [\text{Prop. 13}]$$

The book consists of eighteen propositions. Beginning with six hypotheses to the effect already indicated, Aristarchus declares that he is now in a position to prove

(1) that the distance of the sun from the earth is greater than eighteen times, but less than twenty times, the distance of the moon from the earth;

(2) that the diameter of the sun has the same ratio as aforesaid to the diameter of the moon;



THIS PAGE IS LOCKED TO FREE MEMBERS

Purchase full membership to immediately unlock this page

DELVE INTO FANTASY, MAGIC, MYTHOLOGY & FOLKLORE

Forgotten Books'
Full Membership gives
access to 797,885 ancient
and modern, fiction and
non-fiction books.

Continue

*Fair usage policy applies

Now $BH:HA$ [= $\sin HAB:\sin HBA$]
 $> \angle HAB:\angle HBA,$

whence $\angle HAB < \frac{1}{44} \angle HBA,$

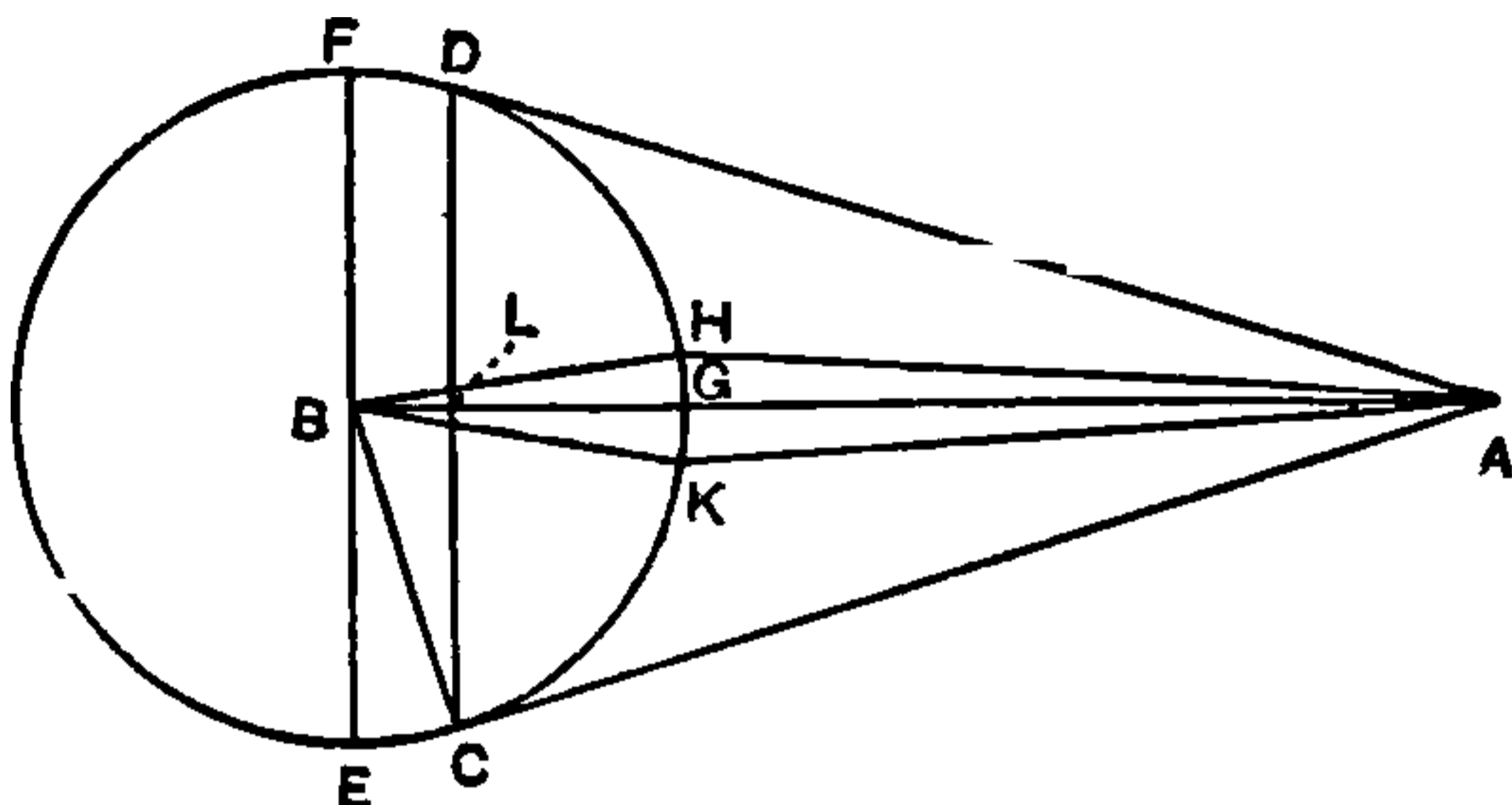

and (taking the doubles) $\angle HAK < \frac{1}{44} \angle HBK.$

But $\angle HBK = \angle EBC = \frac{1}{90} R$ (where R is a right angle);
 therefore $\angle HAK < \frac{1}{3960} R.$

But 'a magnitude (arc HK) seen under such an angle is imperceptible to our eye';
 therefore, *a fortiori*, the arcs CE , DF are severally imperceptible to our eye. Q. E. D.

An easy deduction from the same figure is Prop. 12, which shows that the ratio of CD , the diameter of the 'dividing circle', to EF , the diameter of the moon, is < 1 but $> \frac{89}{90}.$

We have $\angle EBC = \angle BAC = 1^\circ;$

therefore $(\text{arc } EC) = \frac{1}{90} (\text{arc } EG),$

and accordingly $(\text{arc } CG) : (\text{arc } GE) = 89 : 90.$

Doubling the arcs, we have

$$(\text{arc } CGD) : (\text{arc } EGF) = 89 : 90.$$

But $CD:EF > (\text{arc } CGD) : (\text{arc } EGF)$

[equivalent to $\sin \alpha / \sin \beta > \alpha / \beta$, where $\angle CBD = 2\alpha$,
and $2\beta = \pi$];

therefore $CD:EF$ [= $\cos 1^\circ$] $> 89 : 90,$

while obviously $CD:EF < 1.$

Prop. 11 finds limits to the ratio $EF:BA$ (the ratio of the diameter of the moon to the distance of its centre from the centre of the earth); the ratio is $< 2:45$ but $> 1:30.$

The first part follows from the relation found in Prop. 4, namely

$$BC : BA < 1 : 45,$$

for

$$EF = 2 BC.$$

The second part requires the use of the circle drawn with centre A and radius AC . This circle is that on which the ends of the diameter of the 'dividing circle' move as the moon moves in a circle about the earth. If r is the radius AC of this circle, a chord in it equal to r subtends at the centre A an angle of $\frac{2}{3}R$ or 60° ; and the arc CD subtends at A an angle of 2° .

But (arc subtended by CD) : (arc subtended by r)
 $< CD : r,$

or $2 : 60 < CD : r ;$

that is, $CD : CA > 1 : 30.$

And, by similar triangles,

$$CL : CA = CB : BA, \text{ or } CD : CA = 2 CB : BA = FE : BA.$$

Therefore $FE : BA > 1 : 30.$

The proposition which is of the greatest interest on the whole is Prop. 7, to the effect that *the distance of the sun from the earth is greater than 18 times, but less than 20 times, the distance of the moon from the earth.* This result represents a great improvement on all previous attempts to estimate the relative distances. The first speculation on the subject was that of Anaximander (*circa* 611–545 B.C.), who seems to have made the distances of the sun and moon from the earth to be in the ratio 3:2. Eudoxus, according to Archimedes, made the diameter of the sun 9 times that of the moon, and Phidias, Archimedes's father, 12 times; and, assuming that the angular diameters of the two bodies are equal, the ratio of their distances would be the same.

Aristarchus's proof is shortly as follows. A is the centre of the sun, B that of the earth, and C that of the moon at the moment of dichotomy, so that the angle ACB is right. $ABEF$ is a square, and AE is a quadrant of the sun's circular orbit. Join BF , and bisect the angle FBE by BG , so that

$$\angle GBE = \frac{1}{4}R \text{ or } 22\frac{1}{2}^\circ.$$

I. Now, by Hypothesis 4, $\angle ABC = 87^\circ$,

so that

$$\angle HBE = \angle BAC = 3^\circ;$$

therefore

$$\begin{aligned} \angle GBE : \angle HBE &= \frac{1}{4} R : \frac{1}{30} R \\ &= 15 : 2, \end{aligned}$$

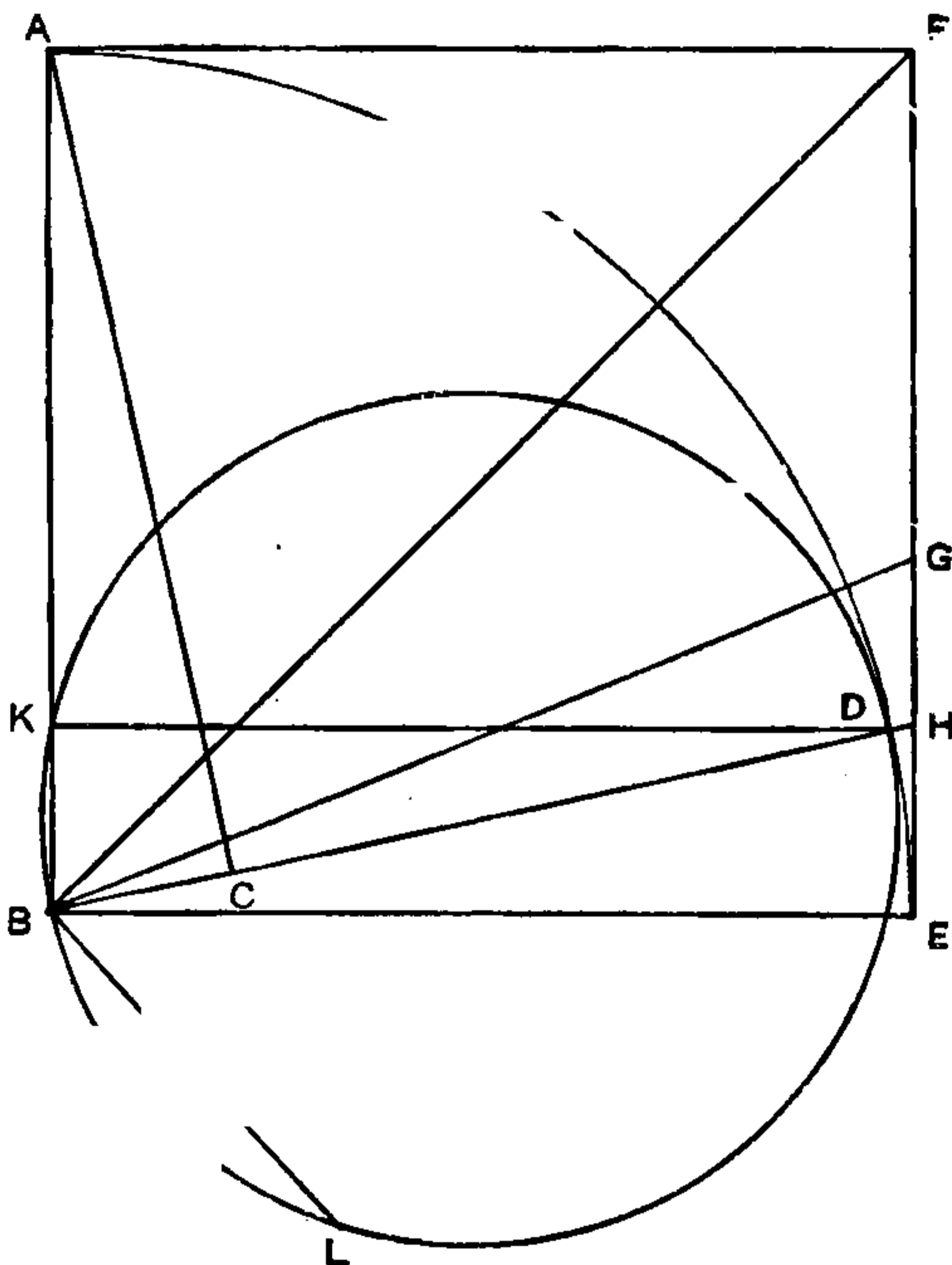

so that $GE : HE [= \tan GBE : \tan HBE] > \angle GBE : \angle HBE$
 $> 15 : 2.$ (1)

The ratio which has to be proved $> 18 : 1$ is $AB : BC$ or $FE : EH$.

Now $FG : GE = FB : BE,$

whence $FG^2 : GE^2 = FB^2 : BE^2 = 2 : 1,$

and $FG : GE = \sqrt{2} : 1$

$$> 7 : 5$$

(this is the approximation to $\sqrt{2}$ mentioned by Plato and known to the Pythagoreans).

Therefore $FE:EG > 12:5$ or $36:15$.

Compounding this with (1) above, we have

$$FE:EH > 36:2 \text{ or } 18:1.$$

II. To prove $BA < 20 BC$.

Let BH meet the circle AE in D , and draw DK parallel to EB . Circumscribe a circle about the triangle BKD , and let the chord BL be equal to the radius (r) of the circle.

Now $\angle BDK = \angle DBE = \frac{1}{30} R$,

so that arc $BK = \frac{1}{60}$ (circumference of circle).

Thus $(\text{arc } BK) : (\text{arc } BL) = \frac{1}{60} : \frac{1}{6},$
 $= 1:10.$

And $(\text{arc } BK) : (\text{arc } BL) < BK : r$

[this is equivalent to $\alpha/\beta < \sin \alpha/\sin \beta$, where $\alpha < \beta < \frac{1}{2}\pi$],

so that $r < 10 BK$,

and $BD < 20 BK$.

But $BD: BK = AB: BC$;

therefore $AB < 20 BC$.

Q. E. D.

The remaining results obtained in the treatise can be visualized by means of the three figures annexed, which have reference to the positions of the sun (centre A), the earth (centre B) and the moon (centre C) during an eclipse. Fig. 1 shows the middle position of the moon relatively to the earth's shadow which is bounded by the cone comprehending the sun and the earth. ON is the arc with centre B along which move the extremities of the diameter of the dividing circle in the moon. Fig. 3 shows the same position of the moon in the middle of the shadow, but on a larger scale. Fig. 2 shows the moon at the moment when it has just entered the shadow; and, as the breadth of the earth's shadow is that of two moons (Hypothesis 5), the moon in the position shown touches BN at N and BL at L , where L is the middle point of the arc ON . It should be added that, in Fig. 1, UV is the diameter of the circle in which the sun is touched by the double cone with B as vertex, which comprehends both the sun and the moon,

while Y , Z are the points in which the perpendicular through A , the centre of the sun, to BA meets the cone enveloping the sun and the earth.

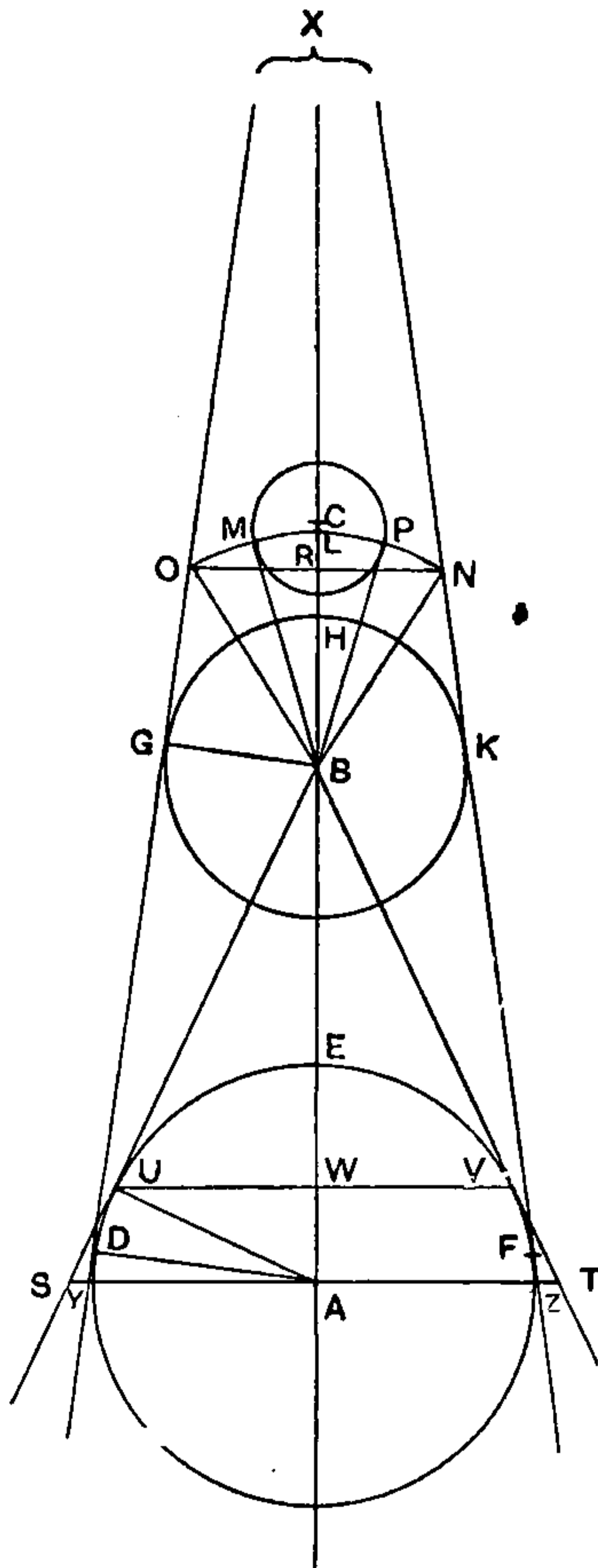

FIG. 1.

This being premised, the main results obtained are as follows:

Prop. 13.

$$(1) \quad ON : (\text{diam. of moon}) < 2 : 1$$

but

$$> 88 : 45.$$

$$(2) \quad ON : (\text{diam. of sun}) < 1 : 9$$

but $\qquad\qquad\qquad > 22 : 225.$

$$(3) \quad ON : YZ > 979 : 10125.$$

Prop. 14 (Fig. 3).

$$BC : CS > 675 : 1.$$

Prop. 15.

$$(\text{Diam. of sun}) : (\text{diam. of earth}) > 19 : 3$$

but $\qquad\qquad\qquad < 43 : 6.$

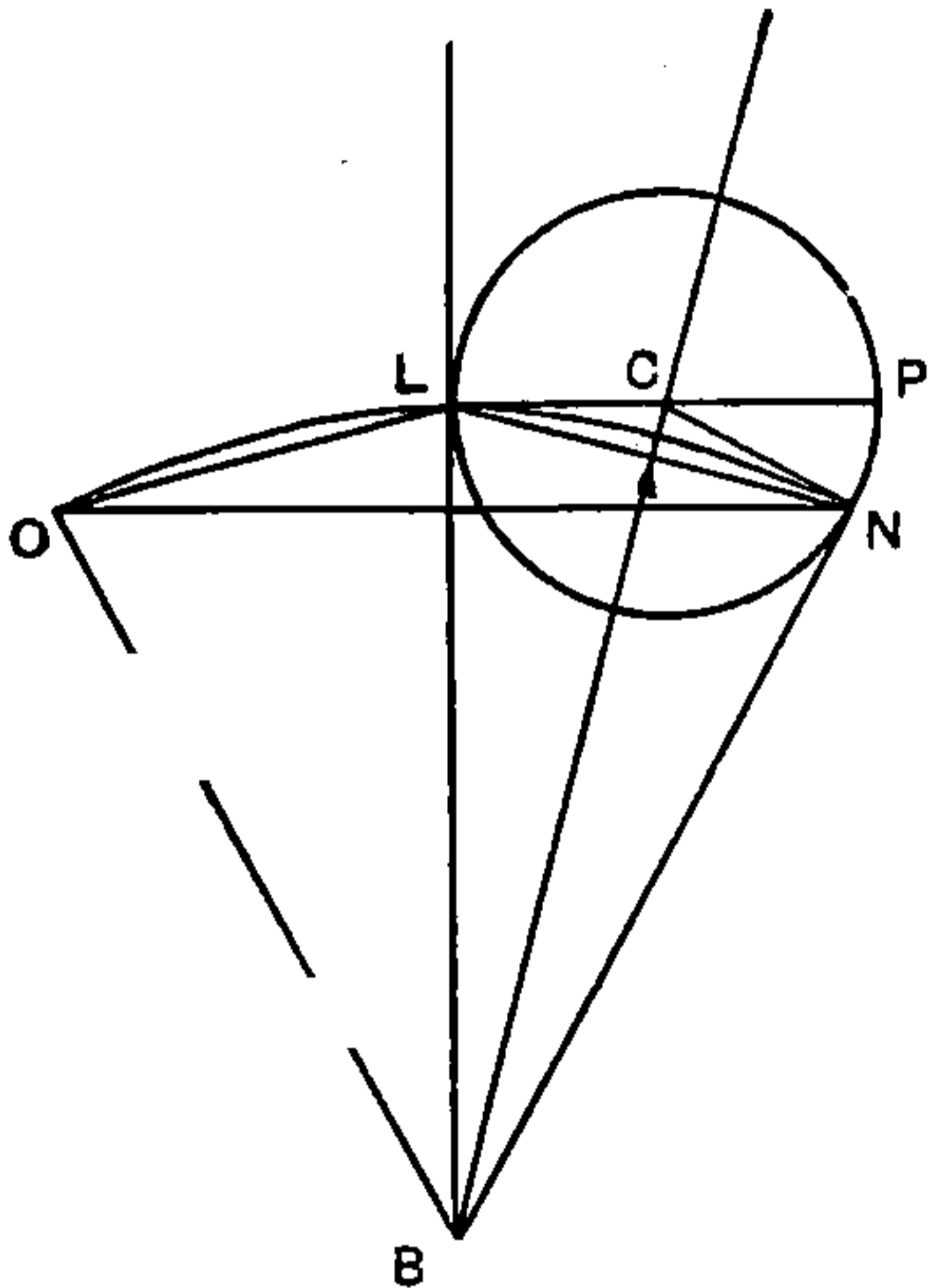

FIG. 2.

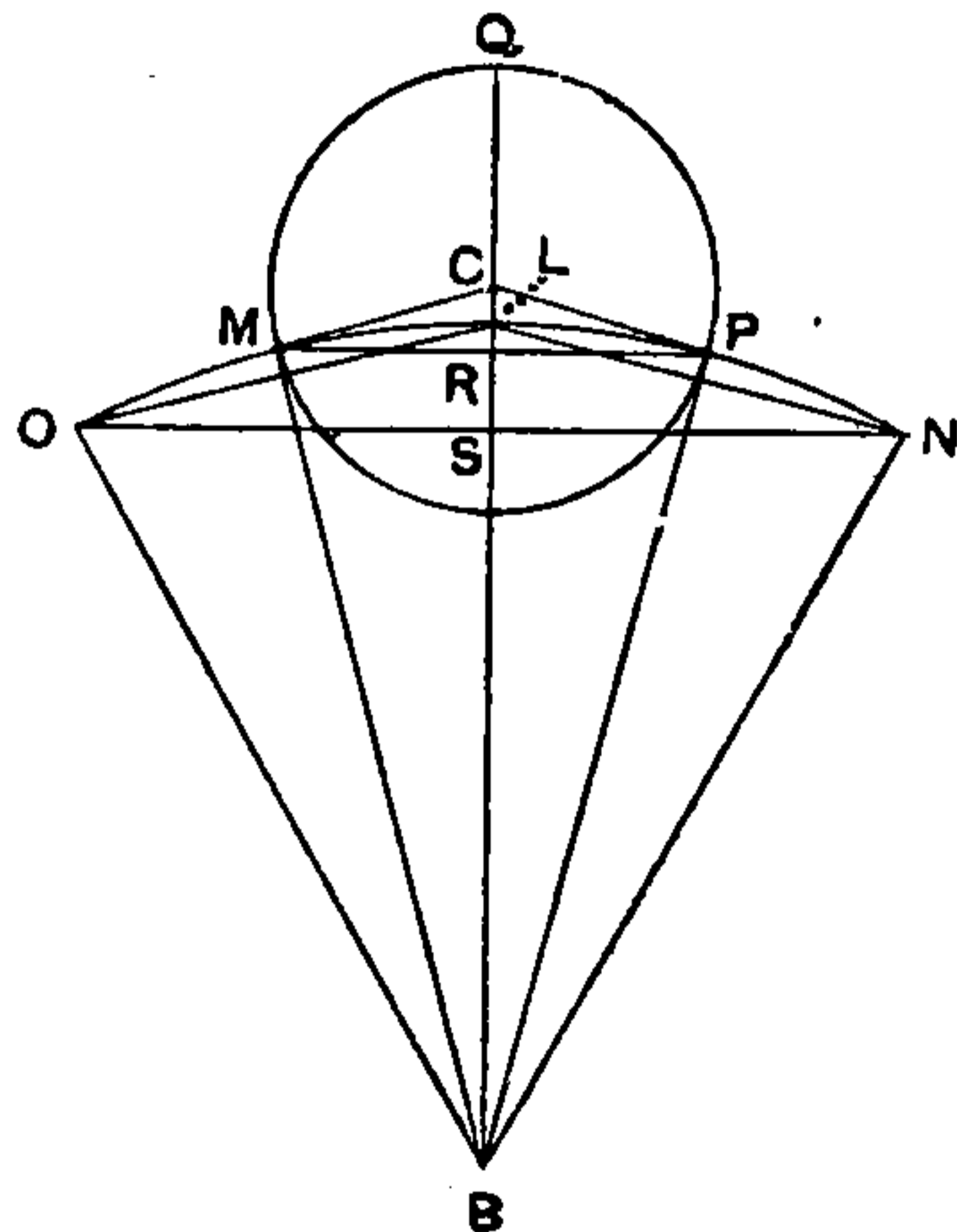

FIG. 3.

Prop. 17.

$$(\text{Diam. of earth}) : (\text{diam. of moon}) > 108 : 43$$

but $\qquad\qquad\qquad < 60 : 19.$

It is worth while to show how these results are proved.

Prop. 13,

(1) In Fig. 2 it is clear that

$$ON < 2LN \text{ and, a fortiori, } < 2LP.$$

The triangles LON , CLN being similar,

$$ON : NL = NL : LC;$$

therefore $ON : NL = NL : \frac{1}{2} LP$

$$> 89 : 45.$$

(by Prop. 12)

Hence $ON : LC = ON^2 : NL^2$
 $> 89^2 : 45^2;$

therefore $ON : LP > 7921 : 4050$
 $> 88 : 45$, says Aristarchus.

[If $\frac{7921}{4050}$ be developed as a continued fraction, we easily obtain $1 + \frac{1}{1 + \frac{1}{2 + \frac{1}{1 + \frac{1}{2}}}}$, which is in fact $\frac{88}{45}$.]

(2) $ON < 2$ (diam. of moon).

But (diam. of moon) $< \frac{1}{18}$ (diam. of sun); (Prop. 7)

therefore $ON < \frac{1}{9}$ (diam. of sun).

Again $ON : (\text{diam. of moon}) > 88 : 45$, from above,

and (diam. of moon) : (diam. of sun) $> 1 : 20$; (Prop. 7)

therefore, *ex aequali*,

$$ON : (\text{diam. of sun}) > 88 : 900$$

$$> 22 : 225.$$

(3) Since the same cone comprehends the sun and the moon, the triangle BUV (Fig. 1) and the triangle BLN (Fig. 2) are similar, and

$$LN : LP = UV : (\text{diam. of sun})$$

$$= WU : UA$$

$$= UA : AS$$

$$< UA : AY.$$

But $LN : LP > 89 : 90$; (Prop. 12)

therefore, *a fortiori*, $UA : AY > 89 : 90$.

And $UA : AY = 2UA : YZ$
 $= (\text{diam. of sun}) : YZ.$

But $ON : (\text{diam. of sun}) > 22 : 225$; (Prop. 13)

therefore, *ex aequali*,

$$ON : YZ > 89 \times 22 : 90 \times 225$$

$$> 979 : 10125.$$



THIS PAGE IS LOCKED TO FREE MEMBERS

Purchase full membership to immediately unlock this page

FORGOTTEN BOOKS

FULL

MEMBERSHIP

797,885 Books!

All you can read

for only

\$8.99/month

Continue

*Fair usage policy applies



But $AB : BC < 20 : 1$;
 therefore, *ex aequali*,

$$AB : BR < 13500 : 674 \\ < 6750 : 337,$$

whence, by inversion and *componendo*,

$$RA : AB > 7087 : 6750. \quad (1)$$

But $AX : XR = YZ : NO$
 $< 10125 : 979$; (Prop. 13)
 therefore, *convertendo*,

$$XA : AR > 10125 : 9146.$$

From this and (1) we have, *ex aequali*,

$$XA : AB > 10125 \times 7087 : 9146 \times 6750 \\ > 71755875 : 61735500 \\ > 43 : 37, \text{ a fortiori.}$$

[It is difficult not to see in $43 : 37$ the expression $1 + \frac{1}{6 + \frac{1}{6}}$, which suggests that $43 : 37$ was obtained by developing the ratio as a continued fraction.]

Therefore, *convertendo*,

$$XA : XB < 43 : 6,$$

whence (diam. of sun) : (diam. of earth) $< 43 : 6$. Q. E. D.

ARCHIMEDES

THE siege and capture of Syracuse by Marcellus during the second Punic war furnished the occasion for the appearance of Archimedes as a personage in history; it is with this historical event that most of the detailed stories of him are connected; and the fact that he was killed in the sack of the city in 212 B.C., when he is supposed to have been 75 years of age, enables us to fix his date at about 287-212 B.C. He was the son of Phidias, the astronomer, and was on intimate terms with, if not related to, King Hieron and his son Gelon. It appears from a passage of Diodorus that he spent some time in Egypt, which visit was the occasion of his discovery of the so-called Archimedean screw as a means of pumping water.¹ It may be inferred that he studied at Alexandria with the successors of Euclid. It was probably at Alexandria that he made the acquaintance of Conon of Samos (for whom he had the highest regard both as a mathematician and a friend) and of Eratosthenes of Cyrene. To the former he was in the habit of communicating his discourses before their publication; while it was to Eratosthenes that he sent *The Method*, with an introductory letter which is of the highest interest, as well as (if we may judge by its heading) the famous Cattle-Problem.

Traditions.

It is natural that history or legend should say more of his mechanical inventions than of his mathematical achievements, which would appeal less to the average mind. His machines were used with great effect against the Romans in the siege of Syracuse. Thus he contrived (so we are told) catapults so ingeniously constructed as to be equally serviceable at long or

¹ Diodorus, v. 37. 3.

short range, machines for discharging showers of missiles through holes made in the walls, and others consisting of long movable poles projecting beyond the walls which either dropped heavy weights on the enemy's ships, or grappled their prows by means of an iron hand or a beak like that of a crane, then lifted them into the air and let them fall again.¹ Marcellus is said to have derided his own engineers with the words, 'Shall we not make an end of fighting against this geometrical Briareus who uses our ships like cups to ladle water from the sea, drives off our *sambuca* ignominiously with cudgel-blows, and by the multitude of missiles that he hurls at us all at once outdoes the hundred-handed giants of mythology?'; but all to no purpose, for the Romans were in such abject terror that, 'if they did but see a piece of rope or wood projecting above the wall, they would cry "there it is", declaring that Archimedes was setting some engine in motion against them, and would turn their backs and run away'.² These things, however, were merely the 'diversions of geometry at play',³ and Archimedes himself attached no importance to them. According to Plutarch,

'though these inventions had obtained for him the renown of more than human sagacity, he yet would not even deign to leave behind him any written work on such subjects, but, regarding as ignoble and sordid the business of mechanics and every sort of art which is directed to use and profit, he placed his whole ambition in those speculations the beauty and subtlety of which is untainted by any admixture of the common needs of life.'⁴

(a) *Astronomy.*

Archimedes did indeed write one mechanical book, *On Sphere-making*, which is lost; this described the construction of a sphere to imitate the motions of the sun, moon and planets.⁵ Cicero saw this contrivance and gives a description of it; he says that it represented the periods of the moon and the apparent motion of the sun with such accuracy that it would even (over a short period) show the eclipses of the sun and moon.⁶ As Pappus speaks of 'those who understand

¹ Polybius, *Hist.* viii. 7, 8; Livy xxiv. 34; Plutarch, *Marcellus*, cc. 15-17.

² *Ib.*, c. 17.

³ *Ib.*, c. 14.

⁴ *Ib.*, c. 17.

⁵ Carpus in Pappus, viii, p. 1026. 9; Proclus on Eucl. I, p. 41. 16.

⁶ Cicero, *De rep.* i. 21, 22, *Tusc.* i. 63, *De nat. deor.* ii. 88.

the making of spheres and produce a model of the heavens by means of the circular motion of water', it is possible that Archimedes's sphere was moved by water. In any case Archimedes was much occupied with astronomy. Livy calls him 'unicus spectator caeli siderumque'.¹ Hipparchus says, 'From these observations it is clear that the differences in the years are altogether small, but, as to the solstices, I almost think that Archimedes and I have both erred to the extent of a quarter of a day both in the observation and in the deduction therefrom'.² Archimedes then had evidently considered the length of the year. Macrobius says he discovered the distances of the planets,³ and he himself describes in his *Sandreckoner* the apparatus by which he measured the apparent angular diameter of the sun.

(β) *Mechanics.*

Archimedes wrote, as we shall see, on theoretical mechanics, and it was by theory that he solved the problem *To move a given weight by a given force*, for it was in reliance 'on the irresistible cogency of his proof' that he declared to Hieron that any given weight could be moved by any given force (however small), and boasted that, 'if he were given a place to stand on, he could move the earth' (πᾱ βῶ, καὶ κινῶ τὰν γᾶν, as he said in his Doric dialect). The story, told by Plutarch, is that, 'when Hieron was struck with amazement and asked Archimedes to reduce the problem to practice and to give an illustration of some great weight moved by a small force, he fixed upon a ship of burden with three masts from the king's arsenal which had only been drawn up with great labour by many men, and loading her with many passengers and a full freight, himself the while sitting far off, with no great effort but only holding the end of a compound pulley (πολύσπαστος) quietly in his hand and pulling at it, he drew the ship along smoothly and safely as if she were moving through the sea.'⁴

The story that Archimedes set the Roman ships on fire by an arrangement of burning-glasses or concave mirrors is not found in any authority earlier than Lucian; but it is quite

¹ Livy xxiv. 34. 2.

² Ptolemy, *Syntaxis*, III. 1, vol. i, p. 194. 23.

³ Macrobius, *In Somn. Scip.* ii. 3; cf. the figures in Hippolytus, *Refut.*, p. 66. 52 sq., ed. Duncker.

⁴ Plutarch, *Marcellus*, c. 14.

likely that he discovered some form of burning-mirror, e.g. a paraboloid of revolution, which would reflect to one point all rays falling on its concave surface in a direction parallel to its axis.

Archimedes's own view of the relative importance of his many discoveries is well shown by his request to his friends and relatives that they should place upon his tomb a representation of a cylinder circumscribing a sphere, with an inscription giving the ratio which the cylinder bears to the sphere; from which we may infer that he regarded the discovery of this ratio as his greatest achievement. Cicero, when quaestor in Sicily, found the tomb in a neglected state and repaired it¹; but it has now disappeared, and no one knows where he was buried.

Archimedes's entire preoccupation by his abstract studies is illustrated by a number of stories. We are told that he would forget all about his food and such necessities of life, and would be drawing geometrical figures in the ashes of the fire or, when anointing himself, in the oil on his body.² Of the same sort is the tale that, when he discovered in a bath the solution of the question referred to him by Hieron, as to whether a certain crown supposed to have been made of gold did not in fact contain a certain proportion of silver, he ran naked through the street to his home shouting *εὕρηκα, εὕρηκα*.³ He was killed in the sack of Syracuse by a Roman soldier. The story is told in various forms; the most picturesque is that found in Tzetzes, which represents him as saying to a Roman soldier who found him intent on some diagrams which he had drawn in the dust and came too close, 'Stand away, fellow, from my diagram', whereat the man was so enraged that he killed him.⁴

Summary of main achievements.

In geometry Archimedes's work consists in the main of original investigations into the quadrature of curvilinear plane figures and the quadrature and cubature of curved surfaces. These investigations, beginning where Euclid's Book XII left off, actually (in the words of Chasles) 'gave

¹ Cicero, *Tusc.* v. 64 sq.

² Plutarch, *Marcellus*, c. 17.

³ Vitruvius, *De architectura*, ix. 1. 9, 10.

⁴ Tzetzes, *Chiliad.* ii. 35. 135.

birth to the calculus of the infinite conceived and brought to perfection successively by Kepler, Cavalieri, Fermat, Leibniz and Newton'. He performed in fact what is equivalent to *integration* in finding the area of a parabolic segment, and of a spiral, the surface and volume of a sphere and a segment of a sphere, and the volumes of any segments of the solids of revolution of the second degree. In arithmetic he calculated approximations to the value of π , in the course of which calculation he shows that he could approximate to the value of square roots of large or small non-square numbers; he further invented a system of arithmetical terminology by which he could express in language any number up to that which we should write down with 1 followed by 80,000 million million ciphers. In mechanics he not only worked out the principles of the subject but advanced so far as to find the centre of gravity of a segment of a parabola, a semicircle, a cone, a hemisphere, a segment of a sphere, a right segment of a paraboloid and a spheroid of revolution. His mechanics, as we shall see, has become more important in relation to his geometry since the discovery of the treatise called *The Method* which was formerly supposed to be lost. Lastly, he invented the whole science of hydrostatics, which again he carried so far as to give a most complete investigation of the positions of rest and stability of a right segment of a paraboloid of revolution floating in a fluid with its base either upwards or downwards, but so that the base is either wholly above or wholly below the surface of the fluid. This represents a sum of mathematical achievement unsurpassed by any one man in the world's history.

Character of treatises.

The treatises are, without exception, monuments of mathematical exposition; the gradual revelation of the plan of attack, the masterly ordering of the propositions, the stern elimination of everything not immediately relevant to the purpose, the finish of the whole, are so impressive in their perfection as to create a feeling akin to awe in the mind of the reader. As Plutarch said, 'It is not possible to find in geometry more difficult and troublesome questions or proofs set out in simpler and clearer propositions'.¹ There is at the

¹ Plutarch, *Marcellus*, c. 17.

same time a certain mystery veiling the way in which he arrived at his results. For it is clear that they were not *discovered* by the steps which lead up to them in the finished treatises. If the geometrical treatises stood alone, Archimedes might seem, as Wallis said, 'as it were of set purpose to have covered up the traces of his investigation, as if he had grudged posterity the secret of his method of inquiry, while he wished to extort from them assent to his results'. And indeed (again in the words of Wallis) 'not only Archimedes but nearly all the ancients so hid from posterity their method of Analysis (though it is clear that they had one) that more modern mathematicians found it easier to invent a new Analysis than to seek out the old'. A partial exception is now furnished by *The Method* of Archimedes, so happily discovered by Heiberg. In this book Archimedes tells us how he discovered certain theorems in quadrature and cubature, namely by the use of mechanics, weighing elements of a figure against elements of another simpler figure the mensuration of which was already known. At the same time he is careful to insist on the difference between (1) the means which may be sufficient to suggest the truth of theorems, although not furnishing scientific proofs of them, and (2) the rigorous demonstrations of them by orthodox geometrical methods which must follow before they can be finally accepted as established:

'certain things', he says, 'first became clear to me by a mechanical method, although they had to be demonstrated by geometry afterwards because their investigation by the said method did not furnish an actual demonstration. But it is of course easier, when we have previously acquired, by the method, some knowledge of the questions, to supply the proof than it is to find it without any previous knowledge.' 'This', he adds, 'is a reason why, in the case of the theorems that the volumes of a cone and a pyramid are one-third of the volumes of the cylinder and prism respectively having the same base and equal height, the proofs of which Eudoxus was the first to discover, no small share of the credit should be given to Democritus who was the first to state the fact, though without proof.'

Finally, he says that the very first theorem which he found out by means of mechanics was that of the separate treatise



THIS PAGE IS LOCKED TO FREE MEMBERS

Purchase full membership to immediately unlock this page

DELVE INTO FANTASY, MAGIC, MYTHOLOGY & FOLKLORE

Forgotten Books'
Full Membership gives
access to 797,885 ancient
and modern, fiction and
non-fiction books.

Continue

*Fair usage policy applies

Qurra the book is attributed to Archimedes, the propositions cannot be his in their present form, since his name is several times mentioned in them; but it is quite likely that some of them are of Archimedean origin, notably those about the geometrical figures called ἄρβηλος ('shoemaker's knife') and σάλινον (probably 'salt-cellar') respectively and Prop. 8 bearing on the trisection of an angle.

There is also the *Cattle-Problem* in epigrammatic form, which purports by its heading to have been communicated by Archimedes to the mathematicians at Alexandria in a letter to Eratosthenes. Whether the epigrammatic form is due to Archimedes himself or not, there is no sufficient reason for doubting the possibility that the substance of it was set as a problem by Archimedes.

Traces of lost works.

Of works which are lost we have the following traces.

1. Investigations relating to *polyhedra* are referred to by Pappus who, after alluding to the five regular polyhedra, describes thirteen others discovered by Archimedes which are semi-regular, being contained by polygons equilateral and equiangular but not all similar.¹

2. There was a book of arithmetical content dedicated to Zeuxippus. We learn from Archimedes himself that it dealt with the *naming of numbers* (κατονόμαξις τῶν ἀριθμῶν)² and expounded the system, which we find in the *Sand-reckoner*, of expressing numbers higher than those which could be written in the ordinary Greek notation, numbers in fact (as we have said) up to the enormous figure represented by 1 followed by 80,000 million million ciphers.

3. One or more works on mechanics are alluded to containing propositions not included in the extant treatise *On Plane Equilibriums*. Pappus mentions a work *On Balances or Levers* (περὶ ζυγῶν) in which it was proved (as it also was in Philon's and Heron's *Mechanics*) that 'greater circles overpower lesser circles when they revolve about the same centre'.³ Heron, too, speaks of writings of Archimedes 'which bear the title of

¹ Pappus, v, pp. 352-8.

² Archimedes, vol. ii, pp. 216. 18, 236. 17-22; cf. p. 220. 4.

³ Pappus, viii, p. 1068.

“works on the lever”’.¹ Simplicius refers to *problems on the centre of gravity*, κεντροβαρικά, such as the many elegant problems solved by Archimedes and others, the object of which is to show how to find the centre of gravity, that is, the point in a body such that if the body is hung up from it, the body will remain at rest in any position.² This recalls the assumption in the *Quadrature of the Parabola* (6) that, if a body hangs at rest from a point, the centre of gravity of the body and the point of suspension are in the same vertical line. Pappus has a similar remark with reference to a point of *support*, adding that the centre of gravity is determined as the intersection of two straight lines in the body, through two points of support, which straight lines are vertical when the body is in equilibrium so supported. Pappus also gives the characteristic of the centre of gravity mentioned by Simplicius, observing that this is the most fundamental principle of the theory of the centre of gravity, the elementary propositions of which are found in Archimedes’s *On Equilibriums* (περὶ ἰσορροπιῶν) and Heron’s *Mechanics*. Archimedes himself cites propositions which must have been proved elsewhere, e.g. that the centre of gravity of a cone divides the axis in the ratio 3 : 1, the longer segment being that adjacent to the vertex³; he also says that ‘it is proved in the *Equilibriums*’ that the centre of gravity of any segment of a right-angled conoid (i. e. paraboloid of revolution) divides the axis in such a way that the portion towards the vertex is double of the remainder.⁴ It is possible that there was originally a larger work by Archimedes *On Equilibriums* of which the surviving books *On Plane Equilibriums* formed only a part; in that case περὶ ζυγῶν and κεντροβαρικά may only be alternative titles. Finally, Heron says that Archimedes laid down a certain procedure in a book bearing the title ‘Book on Supports’.⁵

4. Theon of Alexandria quotes a proposition from a work of Archimedes called *Catoptrica* (properties of mirrors) to the effect that things thrown into water look larger and still larger the farther they sink.⁶ Olympiodorus, too, mentions

¹ Heron, *Mechanics*, i. 32.

² Simpl. on Arist. *De caelo*, ii, p. 508 a 30, Brandis; p. 543. 24, Heib.

³ *Method*, Lemma 10.

⁴ *On Floating Bodies*, ii. 2.

⁵ Heron, *Mechanics*, i. 25.

⁶ Theon on Ptolemy’s *Syntaxis*, i, p. 29, Halma.

that Archimedes proved the phenomenon of refraction 'by means of the ring placed in the vessel (of water)'.¹ A scholiast to the Pseudo-Euclid's *Catoptrica* quotes a proof, which he attributes to Archimedes, of the equality of the angles of incidence and of reflection in a mirror.

The text of Archimedes.

Heron, Pappus and Theon all cite works of Archimedes which no longer survive, a fact which shows that such works were still extant at Alexandria as late as the third and fourth centuries A.D. But it is evident that attention came to be concentrated on two works only, the *Measurement of a Circle* and *On the Sphere and Cylinder*. Eutocius (*fl.* about A.D. 500) only wrote commentaries on these works and on the *Plane Equilibriums*, and he does not seem even to have been acquainted with the *Quadrature of the Parabola* or the work *On Spirals*, although these have survived. Isidorus of Miletus revised the commentaries of Eutocius on the *Measurement of a Circle* and the two Books *On the Sphere and Cylinder*, and it would seem to have been in the school of Isidorus that these treatises were turned from their original Doric into the ordinary language, with alterations designed to make them more intelligible to elementary pupils. But neither in Isidorus's time nor earlier was there any collected edition of Archimedes's works, so that those which were less read tended to disappear.

In the ninth century Leon, who restored the University of Constantinople, collected together all the works that he could find at Constantinople, and had the manuscript written (the archetype, Heiberg's A) which, through its derivatives, was, up to the discovery of the Constantinople manuscript (C) containing *The Method*, the only source for the Greek text. Leon's manuscript came, in the twelfth century, to the Norman Court at Palermo, and thence passed to the House of Hohenstaufen. Then, with all the library of Manfred, it was given to the Pope by Charles of Anjou after the battle of Benevento in 1266. It was in the Papal Library in the years 1269 and 1311, but, some time after 1368, passed into

¹ Olympiodorus on Arist. *Meteorologica*, ii, p. 94, Ideler; p. 211. 18, Busse.

private hands. In 1491 it belonged to Georgius Valla, who translated from it the portions published in his posthumous work *De expetendis et fugiendis rebus* (1501), and intended to publish the whole of Archimedes with Eutocius's commentaries. On Valla's death in 1500 it was bought by Albertus Pius, Prince of Carpi, passing in 1530 to his nephew, Rodolphus Pius, in whose possession it remained till 1544. At some time between 1544 and 1564 it disappeared, leaving no trace.

The greater part of A was translated into Latin in 1269 by William of Moerbeke at the Papal Court at Viterbo. This translation, in William's own hand, exists at Rome (Cod. Ottobon. lat. 1850, Heiberg's B), and is one of our prime sources, for, although the translation was hastily done and the translator sometimes misunderstood the Greek, he followed its wording so closely that his version is, for purposes of collation, as good as a Greek manuscript. William used also for his translation, another manuscript from the same library which contained works not included in A. This manuscript was a collection of works on mechanics and optics; William translated from it the two Books *On Floating Bodies*, and it also contained the *Plane Equilibriums* and the *Quadrature of the Parabola*, for which books William used both manuscripts.

The four most important extant Greek manuscripts (except C, the Constantinople manuscript discovered in 1906) were copied from A. The earliest is E, the Venice manuscript (Marcianus 305), which was written between the years 1449 and 1472. The next is D, the Florence manuscript (Laurent XXVIII. 4), which was copied in 1491 for Angelo Poliziano permission having been obtained with some difficulty in consequence of the jealousy with which Valla guarded his treasure. The other two are G (Paris. 2360) copied from A after it had passed to Albertus Pius, and H (Paris. 2361) copied in 1544 by Christopherus Auverus for Georges d'Armagnac, Bishop of Rodez. These four manuscripts, with the translation of William of Moerbeke (B), enable the readings of A to be inferred.

A Latin translation was made at the instance of Pope Nicholas V about the year 1450 by Jacobus Cremonensis

It was made from A, which was therefore accessible to Pope Nicholas though it does not seem to have belonged to him. Regiomontanus made a copy of this translation about 1468 and revised it with the help of E (the Venice manuscript of the Greek text) and a copy of the same translation belonging to Cardinal Bessarion, as well as another 'old copy' which seems to have been B.

The *editio princeps* was published at Basel (*apud Hervagium*) by Thomas Gechauff Venatorius in 1544. The Greek text was based on a Nürnberg MS. (Norimberg. Cent. V, app. 12) which was copied in the sixteenth century from A but with interpolations derived from B; the Latin translation was Regiomontanus's revision of Jacobus Cremonensis (Norimb. Cent. V, 15).

A translation by F. Commandinus published at Venice in 1558 contained the *Measurement of a Circle, On Spirals, the Quadrature of the Parabola, On Conoids and Spheroids, and the Sand-reckoner*. This translation was based on the Basel edition, but Commandinus also consulted E and other Greek manuscripts.

Torelli's edition (Oxford, 1792) also followed the *editio princeps* in the main, but Torelli also collated E. The book was brought out after Torelli's death by Abram Robertson, who also collated five more manuscripts, including D, G and H. The collation, however, was not well done, and the edition was not properly corrected when in the press.

The second edition of Heiberg's text of all the works of Archimedes with Eutocius's commentaries, Latin translation, apparatus criticus, &c., is now available (1910-15) and, of course, supersedes the first edition (1880-1) and all others. It naturally includes *The Method*, the fragment of the *Stomachion*, and so much of the Greek text of the two Books *On Floating Bodies* as could be restored from the newly discovered Constantinople manuscript.¹

Contents of *The Method*.

Our description of the extant works of Archimedes may suitably begin with *The Method* (the full title is *On*

¹ *The Works of Archimedes*, edited in modern notation by the present writer in 1897, was based on Heiberg's first edition, and the Supplement

Mechanical Theorems, Method (communicated) to *Eratosthenes*) Premising certain propositions in mechanics mostly taken from the *Plane Equilibriums*, and a lemma which forms Prop. 1 of *On Conoids and Spheroids*, Archimedes obtains by his mechanical method the following results. The area of any segment of a section of a right-angled cone (parabola) is $\frac{4}{3}$ of the triangle with the same base and height (Prop. 1). The right cylinder circumscribing a sphere or a spheroid of revolution and with axis equal to the diameter or axis of revolution of the sphere or spheroid is $1\frac{1}{2}$ times the sphere or spheroid respectively (Props. 2, 3). Props. 4, 7, 8, 11 find the volume of any segment cut off, by a plane at right angles to the axis, from any right-angled conoid (paraboloid of revolution), sphere, spheroid, and obtuse-angled conoid (hyperboloid) in terms of the cone which has the same base as the segment and equal height. In Props. 5, 6, 9, 10 Archimedes uses his method to find the centre of gravity of a segment of a paraboloid of revolution, a sphere, and a spheroid respectively. Props. 12–15 and Prop. 16 are concerned with the cubature of two special solid figures. (1) Suppose a prism with a square base to have a cylinder inscribed in it, the circular bases of the cylinder being circles inscribed in the squares which are the bases of the prism, and suppose a plane drawn through one side of one base of the prism and through that diameter of the circle in the opposite base which is parallel to the said side. This plane cuts off a solid bounded by two planes and by part of the curved surface of the cylinder (a solid shaped like a hoof cut off by a plane); and Props. 12–15 prove that its volume is one-sixth of the volume of the prism. (2) Suppose a cylinder inscribed in a cube, so that the circular bases of the cylinder are circles inscribed in two opposite faces of the cube, and suppose another cylinder similarly inscribed with reference to two other opposite faces. The two cylinders enclose a certain solid which is actually made up of eight 'hoofs' like that of Prop. 12. Prop. 16 proves that the volume of this solid is two-thirds of that of the cube. Archimedes observes in his preface that a remarkable fact about

(1912) containing *The Method*, on the original edition of Heiberg (in *Hermes*, xlii, 1907) with the translation by Zeuthen (*Bibliotheca Mathematica*, vii, 1906/7).

these solids respectively is that each of them is equal to a solid enclosed by *planes*, whereas the volume of curvilinear solids (spheres, spheroids, &c.) is generally only expressible in terms of other curvilinear solids (cones and cylinders). In accordance with his dictum that the results obtained by the mechanical method are merely indicated, but not actually proved, unless confirmed by the rigorous methods of pure geometry, Archimedes proved the facts about the two last-named solids by the orthodox method of exhaustion as regularly used by him in his other geometrical treatises; the proofs, partly lost, were given in Props. 15 and 16.

We will first illustrate the method by giving the argument of Prop. 1 about the area of a parabolic segment.

Let ABC be the segment, BD its diameter, CF the tangent at C . Let P be any point on the segment, and let AKF ,

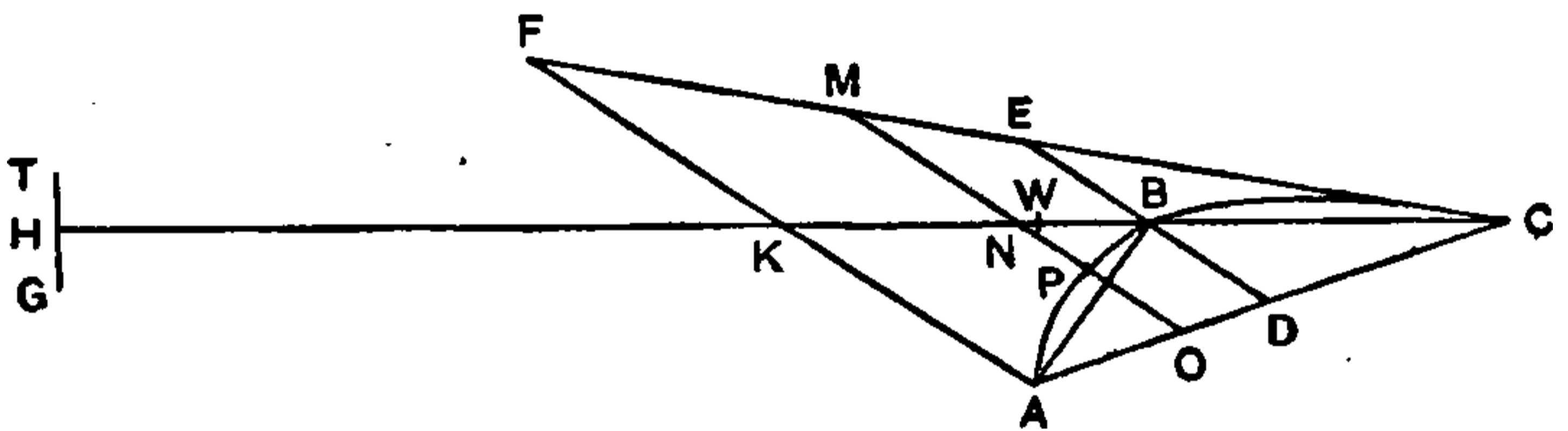

$OPNM$ be drawn parallel to BD . Join CB and produce it to meet MO in N and FA in K , and let KH be made equal to KC .

Now, by a proposition 'proved in a lemma' (cf. *Quadrature of the Parabola*, Prop. 5)

$$\begin{aligned} MO : OP &= CA : AO \\ &= CK : KN \\ &= HK : KN. \end{aligned}$$

Also, by the property of the parabola, $EB = BD$, so that $MN = NO$ and $FK = KA$.

It follows that, if HC be regarded as the bar of a balance, a line TG equal to PO and placed with its middle point at H balances, about K , the straight line MO placed where it is, i.e. with its middle point at N .

Similarly with *all* lines, as MO , PO , in the triangle CFA and the segment CBA respectively.

And there are the same number of these lines. Therefore,



THIS PAGE IS LOCKED TO FREE MEMBERS

Purchase full membership to immediately unlock this page

FORGOTTEN BOOKS

FULL

MEMBERSHIP

797,885 Books!

All you can read

for only

\$8.99/month

Continue

*Fair usage policy applies



Now

$$\begin{aligned} HA : AN &= A'A : AN \\ &= KA : AQ \\ &= MN : NQ \\ &= MN^2 : MN \cdot NQ. \end{aligned}$$

It is now necessary to prove that $MN \cdot NQ = NP^2 + NQ^2$.

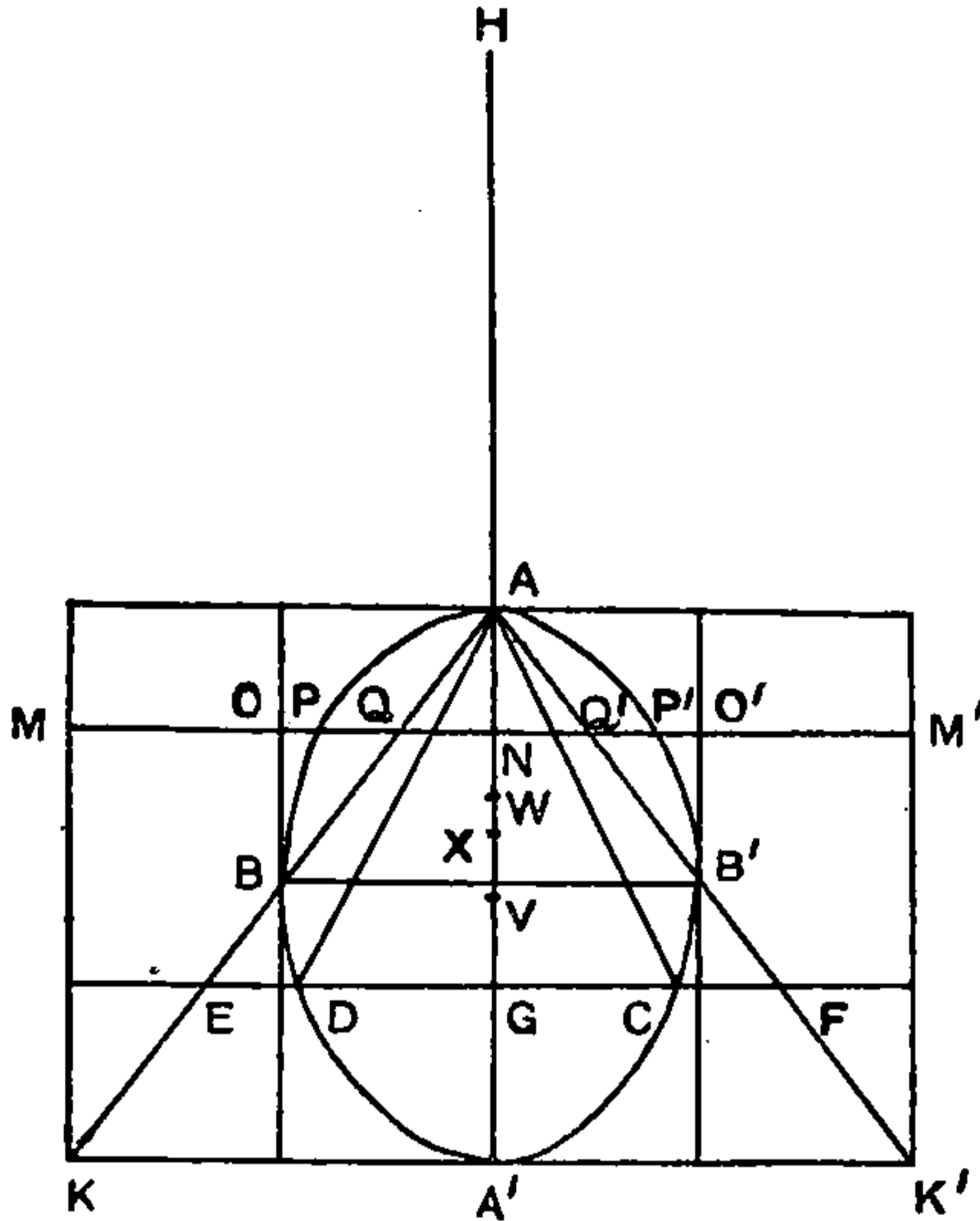

By the property of the ellipse,

$$\begin{aligned} AN \cdot NA' : NP^2 &= (\frac{1}{2} AA')^2 : (\frac{1}{2} BB')^2 \\ &= AN^2 : NQ^2; \end{aligned}$$

therefore

$$\begin{aligned} NQ^2 : NP^2 &= AN^2 : AN \cdot NA' \\ &= NQ^2 : NQ \cdot QM, \end{aligned}$$

whence

$$NP^2 = MQ \cdot QN.$$

Add NQ^2 to each side, and we have

$$NP^2 + NQ^2 = MN \cdot NQ.$$

Therefore, from above,

$$HA : AN = MN^2 : (NP^2 + NQ^2). \quad (1)$$

But MN^2 , NP^2 , NQ^2 are to one another as the areas of the circles with MM' , PP' , QQ' respectively as diameters, and these

circles are sections made by the plane through N at right angles to AA' in the cylinder, the spheroid and the cone AE respectively.

Therefore, if HAA' be a lever, and the sections of the spheroid and cone be both placed with their centres of gravity at H , these sections placed at H balance, about A , the section MM' of the cylinder where it is.

Treating all the corresponding sections of the segment of the spheroid, the cone and the cylinder in the same way we find that the cylinder with axis AG , where it is, balances about A , the cone AEF and the segment ADC together, when both are placed with their centres of gravity at H ; and if W be the centre of gravity of the cylinder, i.e. the middle point of AG ,

$$HA : AW = (\text{cylinder, axis } AG) : (\text{cone } AEF + \text{segment } ADC).$$

If we call V the volume of the cone AEF , and S that of the segment of the spheroid, we have

$$(\text{cylinder}) : (V + S) = 3V \cdot \frac{AA'^2}{AG^2} : (V + S),$$

while $HA : AW = AA' : \frac{1}{2}AG$.

Therefore $AA' : \frac{1}{2}AG = 3V \cdot \frac{AA'^2}{AG^2} : (V + S),$

and $(V + S) = \frac{3}{2}V \cdot \frac{AA'}{AG},$

whence $S = V \left(\frac{3AA'}{2AG} - 1 \right).$

Again, let V' be the volume of the cone ADC .

Then $V : V' = EG^2 : DG^2$
 $= \frac{BB'^2}{AA'^2} \cdot AG^2 : DG^2.$

But $DG^2 : AG \cdot GA' = BB'^2 : AA'^2.$

Therefore $V : V' = AG^2 : AG \cdot GA'$
 $= AG : GA'.$

$$\begin{aligned} \text{It follows that } S &= V' \cdot \frac{AG}{GA'} \left(\frac{3AA'}{2AG} - 1 \right) \\ &= V' \cdot \frac{\frac{3}{2}AA' - AG}{A'G} \\ &= V' \cdot \frac{\frac{1}{2}AA' + A'G}{A'G}, \end{aligned}$$

which is the result stated by Archimedes in Prop. 8.

The result is the same for the segment of a sphere. The proof, of course slightly simpler, is given in Prop. 7.

In the particular case where the segment is half the sphere or spheroid, the relation becomes

$$S = 2V', \quad (\text{Props. 2, 3})$$

and it follows that the volume of the whole sphere or spheroid is $4V'$, where V' is the volume of the cone ABB' ; i.e. the volume of the sphere or spheroid is two-thirds of that of the circumscribing cylinder.

In order now to find the centre of gravity of the segment of a spheroid, we must have the segment acting *where it is*, not at H .

Therefore formula (1) above will not serve. But we found that

$$MN \cdot NQ = (NP^2 + NQ^2),$$

whence $MN^2 : (NP^2 + NQ^2) = (NP^2 + NQ^2) : NQ^2$;

therefore $HA : AN = (NP^2 + NQ^2) : NQ^2$.

(This is separately proved by Archimedes for the sphere in Prop. 9.)

From this we derive, as usual, that the cone AEF and the segment ADC both acting *where they are* balance a volume equal to the cone AEF placed with its centre of gravity at H .

Now the centre of gravity of the cone AEF is on the line AG at a distance $\frac{3}{4}AG$ from A . Let X be the required centre of gravity of the segment. Then, taking moments about A ,

$$\text{we have } V \cdot HA = S \cdot AX + V \cdot \frac{3}{4}AG,$$

$$\text{or } V(AA' - \frac{3}{4}AG) = S \cdot AX$$

$$= V \left(\frac{\frac{3}{2}AA'}{AG} - 1 \right) AX, \text{ from above.}$$

$$\begin{aligned} \text{Therefore } AX : AG &= (AA' - \frac{3}{4}AG) : (\frac{3}{2}AA' - AG) \\ &= (4AA' - 3AG) : (6AA' - 4AG); \end{aligned}$$

$$\begin{aligned} \text{whence } AX : XG &= (4AA' - 3AG) : (2AA' - AG) \\ &= (AG + 4A'G) : (AG + 2A'G); \end{aligned}$$

which is the result obtained by Archimedes in Prop. 9 for the sphere and in Prop. 10 for the spheroid.

In the case of the hemi-spheroid or hemisphere the ratio $AX : XG$ becomes $5 : 3$, a result obtained for the hemisphere in Prop. 6.

The cases of the paraboloid of revolution (Props. 4, 5) and the hyperboloid of revolution (Prop. 11) follow the same course, and it is unnecessary to reproduce them.

For the cases of the two solids dealt with at the end of the treatise the reader must be referred to the propositions themselves. Incidentally, in Prop. 13, Archimedes finds the centre of gravity of the half of a cylinder cut by a plane through the axis, or, in other words, the centre of gravity of a semi-circle.

We will now take the other treatises in the order in which they appear in the editions.

On the Sphere and Cylinder, I, II.

The main results obtained in Book I are shortly stated in a prefatory letter to Dositheus. Archimedes tells us that they are new, and that he is now publishing them for the first time, in order that mathematicians may be able to examine the proofs and judge of their value. The results are (1) that the surface of a sphere is four times that of a great circle of the sphere, (2) that the surface of any segment of a sphere is equal to a circle the radius of which is equal to the straight line drawn from the vertex of the segment to a point on the circumference of the base, (3) that the volume of a cylinder circumscribing a sphere and with height equal to the diameter of the sphere is $\frac{3}{2}$ of the volume of the sphere, (4) that the surface of the circumscribing cylinder including its bases is also $\frac{3}{2}$ of the surface of the sphere. It is worthy of note that, while the first and third of these propositions appear in the book in this order (Props. 33 and 34 respec-

tively), this was not the order of their discovery; for Archimedes tells us in *The Method* that

‘from the theorem that a sphere is four times as great as the cone with a great circle of the sphere as base and with height equal to the radius of the sphere I conceived the notion that the surface of any sphere is four times as great as a great circle in it; for, judging from the fact that any circle is equal to a triangle with base equal to the circumference and height equal to the radius of the circle, I apprehended that, in like manner, any sphere is equal to a cone with base equal to the surface of the sphere and height equal to the radius’.

Book I begins with definitions (of ‘concave in the same direction’ as applied to curves or broken lines and surfaces, of a ‘solid sector’ and a ‘solid rhombus’) followed by five Assumptions, all of importance. *Of all lines which have the same extremities the straight line is the least*, and, if there are two curved or bent lines in a plane having the same extremities and concave in the same direction, but one is wholly included by, or partly included by and partly common with, the other, then that which is included is the lesser of the two. Similarly with plane surfaces and surfaces concave in the same direction. Lastly, Assumption 5 is the famous ‘Axiom of Archimedes’, which however was, according to Archimedes himself, used by earlier geometers (Eudoxus in particular), to the effect that *Of unequal magnitudes the greater exceeds the less by such a magnitude as, when added to itself, can be made to exceed any assigned magnitude of the same kind*; the axiom is of course practically equivalent to Eucl. V, Def. 4, and is closely connected with the theorem of Eucl. X. 1.

As, in applying the method of exhaustion, Archimedes uses both circumscribed and inscribed figures with a view to *compressing* them into coalescence with the curvilinear figure to be measured, he has to begin with propositions showing that, given two unequal magnitudes, then, however near the ratio of the greater to the less is to 1, it is possible to find two straight lines such that the greater is to the less in a still less ratio (> 1), and to circumscribe and inscribe similar polygons to a circle or sector such that the perimeter or the area of the circumscribed polygon is to that of the inner in a ratio less than the given ratio (Props. 2–6): also, just as Euclid proves

that, if we continually double the number of the sides of the regular polygon inscribed in a circle, segments will ultimately be left which are together less than any assigned area, Archimedes has to supplement this (Prop. 6) by proving that, if we increase the number of the sides of a *circumscribed* regular polygon sufficiently, we can make the excess of the area of the polygon over that of the circle less than any given area. Archimedes then addresses himself to the problems of finding the *surface* of any right cone or cylinder, problems finally solved in Props. 13 (the cylinder) and 14 (the cone). Circumscribing and inscribing regular polygons to the bases of the cone and cylinder, he erects pyramids and prisms respectively on the polygons as bases and circumscribed or inscribed to the cone and cylinder respectively. In Props. 7 and 8 he finds the surface of the pyramids inscribed and circumscribed to the cone, and in Props. 9 and 10 he proves that the surfaces of the inscribed and circumscribed pyramids respectively (excluding the base) are less and greater than the surface of the cone (excluding the base). Props. 11 and 12 prove the same thing of the prisms inscribed and circumscribed to the cylinder, and finally Props. 13 and 14 prove, by the method of exhaustion, that the surface of the cone or cylinder (excluding the bases) is equal to the circle the radius of which is a mean proportional between the 'side' (i.e. generator) of the cone or cylinder and the radius or diameter of the base (i.e. is equal to πrs in the case of the cone and $2\pi rs$ in the case of the cylinder, where r is the radius of the base and s a generator). As Archimedes here applies the method of exhaustion for the first time, we will illustrate by the case of the cone (Prop. 14).

Let A be the base of the cone, C a straight line equal to its

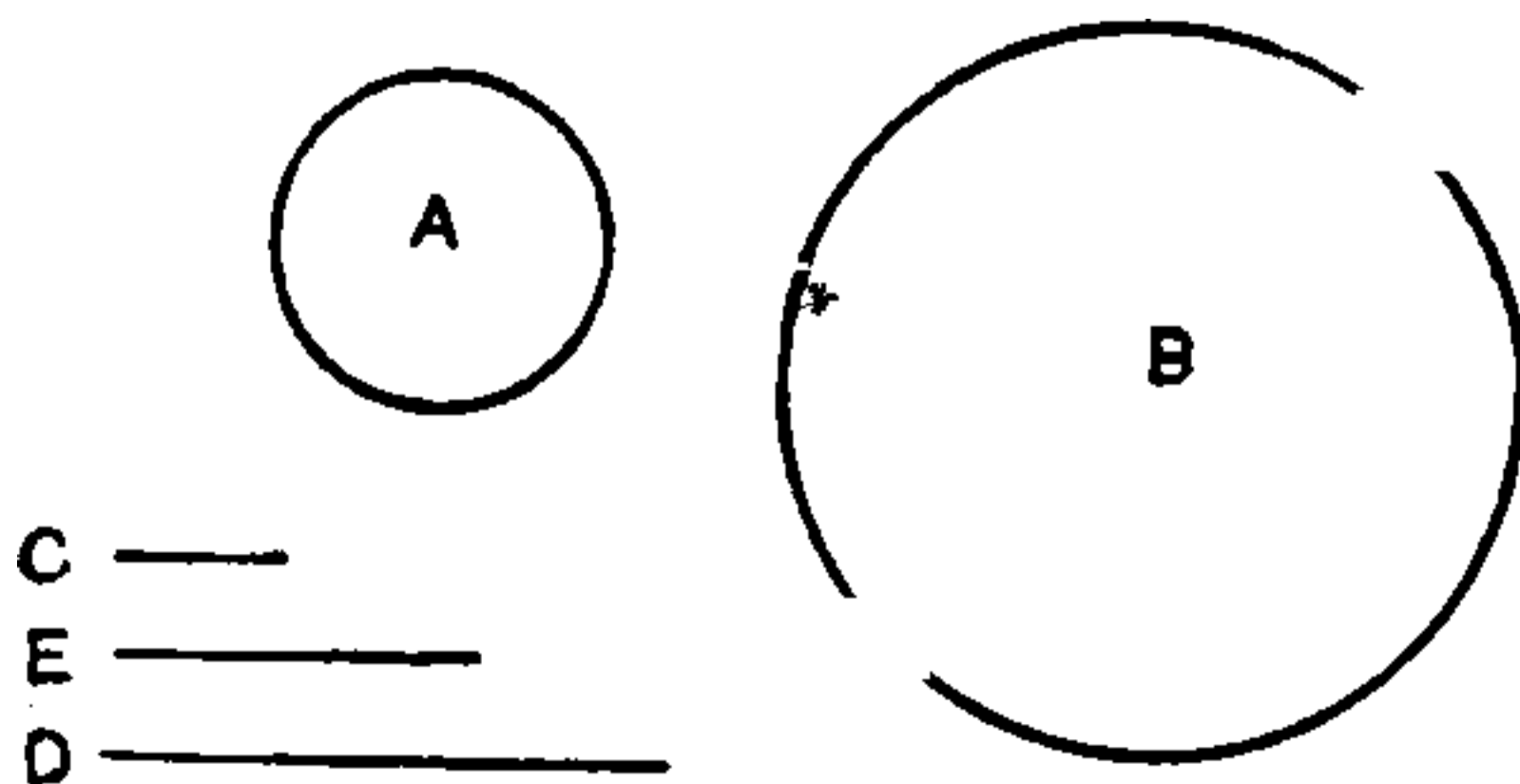

radius, D a line equal to a generator of the cone, E a mean proportional to C , D , and B a circle with radius equal to E .

If S is the surface of the cone, we have to prove that $S = B$. For, if S is not equal to B , it must be either greater or less.

I. Suppose $B < S$.

Circumscribe a regular polygon about B , and inscribe a similar polygon in it, such that the former has to the latter a ratio less than $S : B$ (Prop. 5). Describe about A a similar polygon and set up from it a pyramid circumscribing the cone.

$$\begin{aligned} \text{Then} \quad & (\text{polygon about } A) : (\text{polygon about } B) \\ & = C^2 : E^2 \\ & = C : D \\ & = (\text{polygon about } A) : (\text{surface of pyramid}). \end{aligned}$$

Therefore (surface of pyramid) = (polygon about B).

But (polygon about B) : (polygon in B) $< S : B$;
therefore (surface of pyramid) : (polygon in B) $< S : B$.

But this is impossible, since (surface of pyramid) $> S$, while (polygon in B) $< B$;
therefore B is not less than S .

II. Suppose $B > S$.

Circumscribe and inscribe similar regular polygons to B such that the former has to the latter a ratio $< B : S$. Inscribe in A a similar polygon, and erect on A the inscribed pyramid.

$$\begin{aligned} \text{Then} \quad & (\text{polygon in } A) : (\text{polygon in } B) = C^2 : E^2 \\ & = C : D \\ & > (\text{polygon in } A) : (\text{surface of pyramid}). \end{aligned}$$

(The latter inference is clear, because the ratio of $C : D$ is greater than the ratio of the perpendiculars from the centre of A and from the vertex of the pyramid respectively on any side of the polygon in A ; in other words, if $\beta < \alpha < \frac{1}{2}\pi$, $\sin \alpha > \sin \beta$.)

Therefore (surface of pyramid) $>$ (polygon in B).

But (polygon about B) : (polygon in B) $< B : S$,
whence (*a fortiori*)

$$(\text{polygon about } B) : (\text{surface of pyramid}) < B : S,$$

which is impossible, for (polygon about B) $> B$, while (surface of pyramid) $< S$.



THIS PAGE IS LOCKED TO FREE MEMBERS

Purchase full membership to immediately unlock this page

DELVE INTO FANTASY, MAGIC, MYTHOLOGY & FOLKLORE

Forgotten Books'
Full Membership gives
access to 797,885 ancient
and modern, fiction and
non-fiction books.

Continue

*Fair usage policy applies

whence, adding antecedents and consequents, we have

$$\text{(Fig. 1)} \quad (BB' + CC' + \dots + EE') : AA' = A'B : BA, \quad (\text{Prop. 21})$$

$$\text{(Fig. 2)} \quad (BB' + CC' + \dots + \frac{1}{2}PP') : AM = A'B : BA. \quad (\text{Prop. 22})$$

When we make the polygon revolve about AA' , the surface of the inscribed figure so obtained is made up of the surfaces of cones and frusta of cones; Prop. 14 has proved that the surface of the cone ABB' is what we should write $\pi \cdot AB \cdot BF$, and Prop. 16 has proved that the surface of the frustum $BCC'B'$ is $\pi \cdot BC (BF + CG)$. It follows that, since $AB = BC = \dots$, the surface of the inscribed solid is

$$\pi \cdot AB \left\{ \frac{1}{2}BB' + \frac{1}{2}(BB' + CC') + \dots \right\},$$

$$\text{that is,} \quad \pi \cdot AB (BB' + CC' + \dots + EE') \quad (\text{Fig. 1}), \quad (\text{Prop. 24})$$

$$\text{or} \quad \pi \cdot AB (BB' + CC' + \dots + \frac{1}{2}PP') \quad (\text{Fig. 2}). \quad (\text{Prop. 35})$$

Hence, from above, the surface of the inscribed solid is $\pi \cdot A'B \cdot AA'$ or $\pi \cdot A'B \cdot AM$, and is therefore less than $\pi \cdot AA'^2$ (Prop. 25) or $\pi \cdot A'A \cdot AM$, that is, $\pi \cdot AP^2$ (Prop. 37).

Similar propositions with regard to surfaces formed by the revolution about AA' of regular circumscribed solids prove that their surfaces are greater than $\pi \cdot AA'^2$ and $\pi \cdot AP^2$ respectively (Props. 28–30 and Props. 39–40). The case of the segment is more complicated because the circumscribed polygon with its sides parallel to $AB, BC \dots DP$ circumscribes the sector POP' . Consequently, if the segment is less than a semicircle, as CAC' , the base of the circumscribed polygon (cc') is on the side of CC' towards A , and therefore the circumscribed polygon leaves over a small strip of the inscribed. This complication is dealt with in Props. 39–40. Having then arrived at circumscribed and inscribed figures with surfaces greater and less than $\pi \cdot AA'^2$ and $\pi \cdot AP^2$ respectively, and having proved (Props. 32, 41) that the surfaces of the circumscribed and inscribed figures are to one another in the duplicate ratio of their sides, Archimedes proceeds to prove formally, by the method of exhaustion, that the surfaces of the sphere and segment are equal to these circles respectively (Props. 33 and 42); $\pi \cdot AA'^2$ is of course equal to four times the great circle of the sphere. The segment is, for convenience, taken to be

less than a hemisphere, and Prop. 43 proves that the same formula applies also to a segment greater than a hemisphere.

As regards the volumes different considerations involving 'solid rhombi' come in. For convenience Archimedes takes, in the case of the whole sphere, an inscribed polygon of $4n$ sides (Fig. 1). It is easily seen that the solid figure formed by its revolution is made up of the following: first, the solid rhombus formed by the revolution of the quadrilateral $ABOB'$ (the volume of this is shown to be equal to the cone with base equal to the surface of the cone ABB' and height equal to p , the perpendicular from O on AB , Prop. 18); secondly, the extinguisher-shaped figure formed by the revolution of the triangle BOC about AA' (this figure is equal to the difference between two solid rhombi formed by the revolution of $TBOB'$ and $TCOC'$ respectively about AA' , where T is the point of intersection of CB , $C'B'$ produced with $A'A$ produced, and this difference is proved to be equal to a cone with base equal to the surface of the frustum of a cone described by BC in its revolution and height equal to p the perpendicular from O on BC , Prop. 20); and so on; finally, the figure formed by the revolution of the triangle COD about AA' is the difference between a cone and a solid rhombus, which is proved equal to a cone with base equal to the surface of the frustum of a cone described by CD in its revolution and height p (Prop. 19). Consequently, by addition, the volume of the whole solid of revolution is equal to the cone with base equal to its whole surface and height p (Prop. 26). But the whole of the surface of the solid is less than $4\pi r^2$, and $p < r$; therefore the volume of the inscribed solid is less than four times the cone with base πr^2 and height r (Prop. 27).

It is then proved in a similar way that the revolution of the similar circumscribed polygon of $4n$ sides gives a solid the volume of which is *greater* than four times the same cone (Props. 28–31 Cor.). Lastly, the volumes of the circumscribed and inscribed figures are to one another in the triplicate ratio of their sides (Prop. 32); and Archimedes is now in a position to apply the method of exhaustion to prove that the volume of the sphere is 4 times the cone with base πr^2 and height r (Prop. 34).

Dealing with the segment of a sphere, Archimedes takes, for

convenience, a segment less than a hemisphere and, by the same chain of argument (Props. 38, 40 Corr., 41 and 42), proves (Prop. 44) that the volume of the *sector* of the sphere bounded by the surface of the segment is equal to a cone with base equal to the surface of the segment and height equal to the radius, i. e. the cone with base $\pi \cdot AP^2$ and height r (Fig. 2).

It is noteworthy that the proportions obtained in Props. 21, 22 (see p. 39 above) can be expressed in trigonometrical form. If $4n$ is the number of the sides of the polygon inscribed in the circle, and $2n$ the number of the sides of the polygon inscribed in the segment, and if the angle AOP is denoted by α , the trigonometrical equivalents of the proportions are respectively

$$(1) \quad \sin \frac{\pi}{2n} + \sin \frac{2\pi}{2n} + \dots + \sin (2n-1) \frac{\pi}{2n} = \cot \frac{\pi}{4n};$$

$$(2) \quad 2 \left\{ \sin \frac{\alpha}{n} + \sin \frac{2\alpha}{n} + \dots + \sin (n-1) \frac{\alpha}{n} \right\} + \sin \alpha \\ = (1 - \cos \alpha) \cot \frac{\alpha}{2n}.$$

Thus the two proportions give in effect a summation of the series

$$\sin \theta + \sin 2\theta + \dots + \sin (n-1)\theta,$$

both generally where $n\theta$ is equal to any angle α less than π and in the particular case where n is even and $\theta = \pi/n$. Props. 24 and 35 prove that the areas of the circles equal to the surfaces of the solids of revolution described by the polygons inscribed in the sphere and segment are the above

series multiplied by $4\pi r^2 \sin \frac{\pi}{4n}$ and $\pi r^2 \cdot 2 \sin \frac{\alpha}{2n}$ respectively

and are therefore $4\pi r^2 \cos \frac{\pi}{4n}$ and $\pi r^2 \cdot 2 \cos \frac{\alpha}{2n} (1 - \cos \alpha)$

respectively. Archimedes's results for the surfaces of the sphere and segment, $4\pi r^2$ and $2\pi r^2 (1 - \cos \alpha)$, are the limiting values of these expressions when n is indefinitely

increased and when therefore $\cos \frac{\pi}{4n}$ and $\cos \frac{\alpha}{2n}$ become

unity. And the two series multiplied by $4\pi r^2 \sin \frac{\pi}{4n}$ and

$\pi r^2 \cdot 2 \sin \frac{\alpha}{2n}$ respectively are (when n is indefinitely increased) precisely what we should represent by the integrals

$$4\pi r^2 \cdot \frac{1}{2} \int_0^\pi \sin \theta d\theta, \text{ or } 4\pi r^2,$$

and $\pi r^2 \cdot \int_0^\alpha 2 \sin \theta d\theta, \text{ or } 2\pi r^2(1 - \cos \alpha).$

Book II contains six problems and three theorems. Of the theorems Prop. 2 completes the investigation of the volume of any segment of a sphere, Prop. 44 of Book I having only brought us to the volume of the corresponding sector. If ABB' be a segment of a sphere cut off by a plane at right angles to AA' , we learnt in I. 44 that the volume of the sector

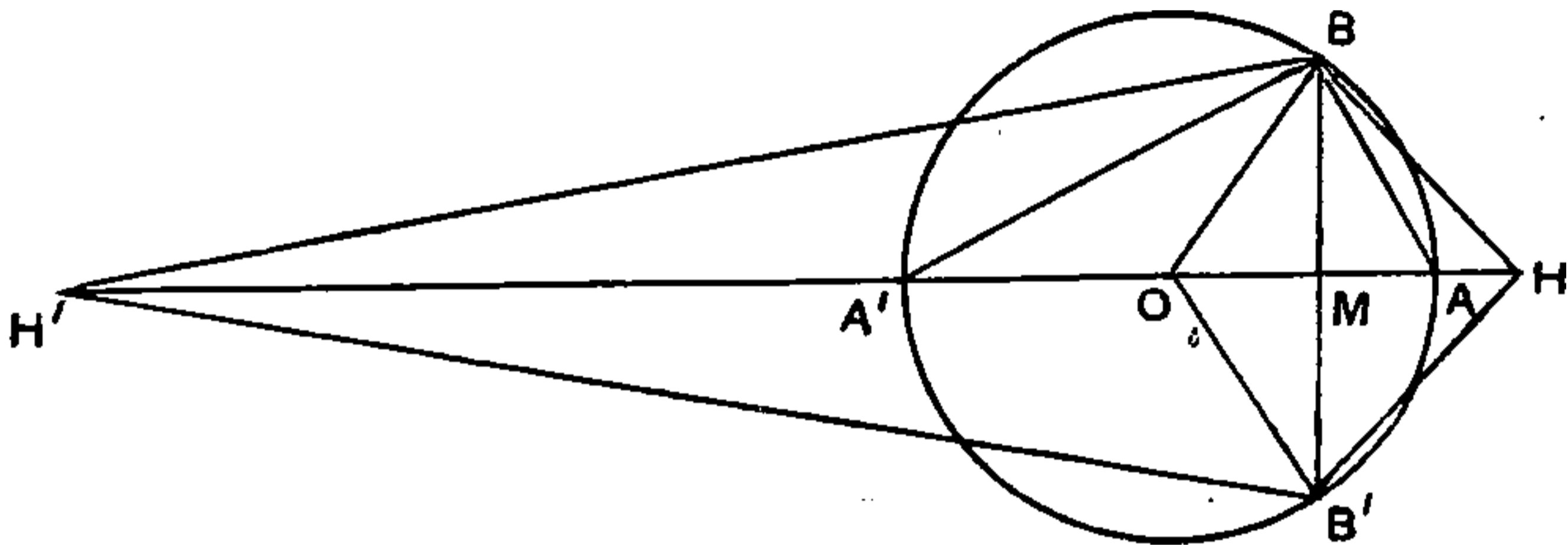

$OBAB'$ is equal to the cone with base equal to the surface of the segment and height equal to the radius, i.e. $\frac{1}{3}\pi \cdot AB^2 \cdot r$, where r is the radius. The volume of the segment is therefore

$$\frac{1}{3}\pi \cdot AB^2 \cdot r - \frac{1}{3}\pi \cdot BM^2 \cdot OM.$$

Archimedes wishes to express this as a cone with base the same as that of the segment. Let AM , the height of the segment, = h .

Now $AB^2 : BM^2 = A'A : A'M = 2r : (2r - h).$

Therefore

$$\begin{aligned} \frac{1}{3}\pi (AB^2 \cdot r - BM^2 \cdot OM) &= \frac{1}{3}\pi \cdot BM^2 \left\{ \frac{2r^2}{2r - h} - (r - h) \right\} \\ &= \frac{1}{3}\pi \cdot BM^2 \cdot h \left(\frac{3r - h}{2r - h} \right). \end{aligned}$$

That is, the segment is equal to the cone with the same base as that of the segment and height $h(3r - h)/(2r - h).$

This is expressed by Archimedes thus. If HM is the height of the required cone,

$$HM : AM = (OA' + A'M) : A'M, \quad (1)$$

and similarly the cone equal to the segment $A'BB'$ has the height $H'M$, where

$$H'M : A'M = (OA + AM) : AM. \quad (2)$$

His proof is, of course, not in the above form but purely geometrical.

This proposition leads to the most important proposition in the Book, Prop. 4, which solves the problem *To cut a given sphere by a plane in such a way that the volumes of the segments are to one another in a given ratio.*

Cubic equation arising out of II. 4.

If $m:n$ be the given ratio of the cones which are equal to the segments and the heights of which are h, h' , we have

$$h \left(\frac{3r-h}{2r-h} \right) = \frac{m}{n} h' \left(\frac{3r-h'}{2r-h'} \right),$$

and, if we eliminate h' by means of the relation $h+h'=2r$, we easily obtain the following cubic equation in h ,

$$h^3 - 3h^2r + \frac{4m}{m+n} r^3 = 0.$$

Archimedes in effect reduces the problem to this equation, which, however, he treats as a particular case of the more general problem corresponding to the equation

$$(r+h) : b = c^2 : (2r-h)^2,$$

where b is a given length and c^2 any given area,

or $x^2(a-x) = bc^2$, where $x = 2r-h$ and $3r = a$.

Archimedes obtains his cubic equation with one unknown by means of a *geometrical* elimination of H, H' from the equation $HM = \frac{m}{n} \cdot H'M$, where $HM, H'M$ have the values determined by the proportions (1) and (2) above, after which the one variable point M remaining corresponds to the one unknown of the cubic equation. His method is, first, to find

values for each of the ratios $A'H' : H'M$ and $H'H : A'H'$ which are alike independent of H, H' and then, secondly, to equate the ratio compounded of these two to the known value of the ratio $HH' : H'M$.

(α) We have, from (2),

$$A'H' : H'M = OA : (OA + AM). \quad (3)$$

(β) From (1) and (2), *separando*,

$$AH : AM = OA' : A'M, \quad (4)$$

$$A'H' : A'M = OA : AM. \quad (5)$$

Equating the values of the ratio $A'M : AM$ given by (4), (5), we have

$$\begin{aligned} OA' : AH &= A'H' : OA \\ &= OH' : OH, \end{aligned}$$

whence $HH' : OH' = OH' : A'H'$, (since $OA = OA'$)

or $HH' \cdot A'H' = OH'^2$,

so that $HH' : A'H' = OH'^2 : A'H'^2$. (6)

But, by (5), $OA' : A'H' = AM : A'M$,

and, *componendo*, $OH' : A'H' = AA' : A'M$.

By substitution in (6),

$$HH' : A'H' = AA'^2 : A'M^2. \quad (7)$$

Compounding with (3), we obtain

$$HH' : H'M = (AA'^2 : A'M^2) \cdot (OA : OA + AM). \quad (8)$$

[The algebraical equivalent of this is

$$\frac{m+n}{n} = \frac{4r^3}{(2r-h)^2(r+h)},$$

which reduces to $\frac{m+n}{m} = \frac{4r^3}{3h^2r-h^3}$,

or $h^3 - 3h^2r + \frac{4m}{m+n}r^3 = 0$, as above.]

Archimedes expresses the result (8) more simply by producing OA to D so that $OA = AD$, and then dividing AD at

E so that $AD:DE = HH':H'M$ or $(m+n):n$. We have then $OA = AD$ and $OA + AM = MD$, so that (8) reduces to

$$AD:DE = (AA'^2 : A'M^2) \cdot (AD:MD),$$

or
$$MD:DE = AA'^2 : A'M^2.$$

Now, says Archimedes, D is given, since $AD = OA$. Also, $AD:DE$ being a given ratio, DE is given. Hence the problem reduces itself to that of dividing $A'D$ into two parts at M such that

$$MD : (\text{a given length}) = (\text{a given area}) : A'M^2.$$

That is, the generalized equation is of the form

$$x^2 (a - x) = bc^2, \text{ as above.}$$

(i) Archimedes's own solution of the cubic.

Archimedes adds that, 'if the problem is propounded in this general form, it requires a *διορισμός* [i.e. it is necessary to investigate the limits of possibility], but if the conditions are added which exist in the present case [i.e. in the actual problem of Prop. 4], it does not require a *διορισμός*' (in other words, a solution is always possible). He then promises to give 'at the end' an analysis and synthesis of both problems [i.e. the *διορισμός* and the problem itself]. The promised solutions do not appear in the treatise as we have it, but Eutocius gives solutions taken from 'an old book' which he managed to discover after laborious search, and which, since it was partly written in Archimedes's favourite Doric, he with fair reason assumed to contain the missing *addendum* by Archimedes.

In the Archimedean fragment preserved by Eutocius the above equation, $x^2(a-x) = bc^2$, is solved by means of the intersection of a parabola and a rectangular hyperbola, the equations of which may be written thus

$$x^2 = \frac{c^2}{a} y, \quad (a-x)y = ab.$$

The *διορισμός* takes the form of investigating the maximum possible value of $x^2(a-x)$, and it is proved that this maximum value for a real solution is that corresponding to the value $x = \frac{2}{3}a$. This is established by showing that, if $bc^2 = \frac{4}{27}a^3$,



THIS PAGE IS LOCKED TO FREE MEMBERS

Purchase full membership to immediately unlock this page

FORGOTTEN BOOKS

FULL

MEMBERSHIP

797,885 Books!

All you can read

for only

\$8.99/month

Continue

*Fair usage policy applies



(iii) Solution of the original problem of II. 4 by Diocles.

Diocles proceeded in a different manner, satisfying, by a geometrical construction, not the derivative cubic equation, but the three simultaneous relations which hold in Archimedes's proposition, namely

$$\left. \begin{aligned} HM : H'M &= m : n \\ HA : h &= r : h' \\ H'A' : h' &= r : h \end{aligned} \right\},$$

with the slight generalization that he substitutes for r in these equations another length a .

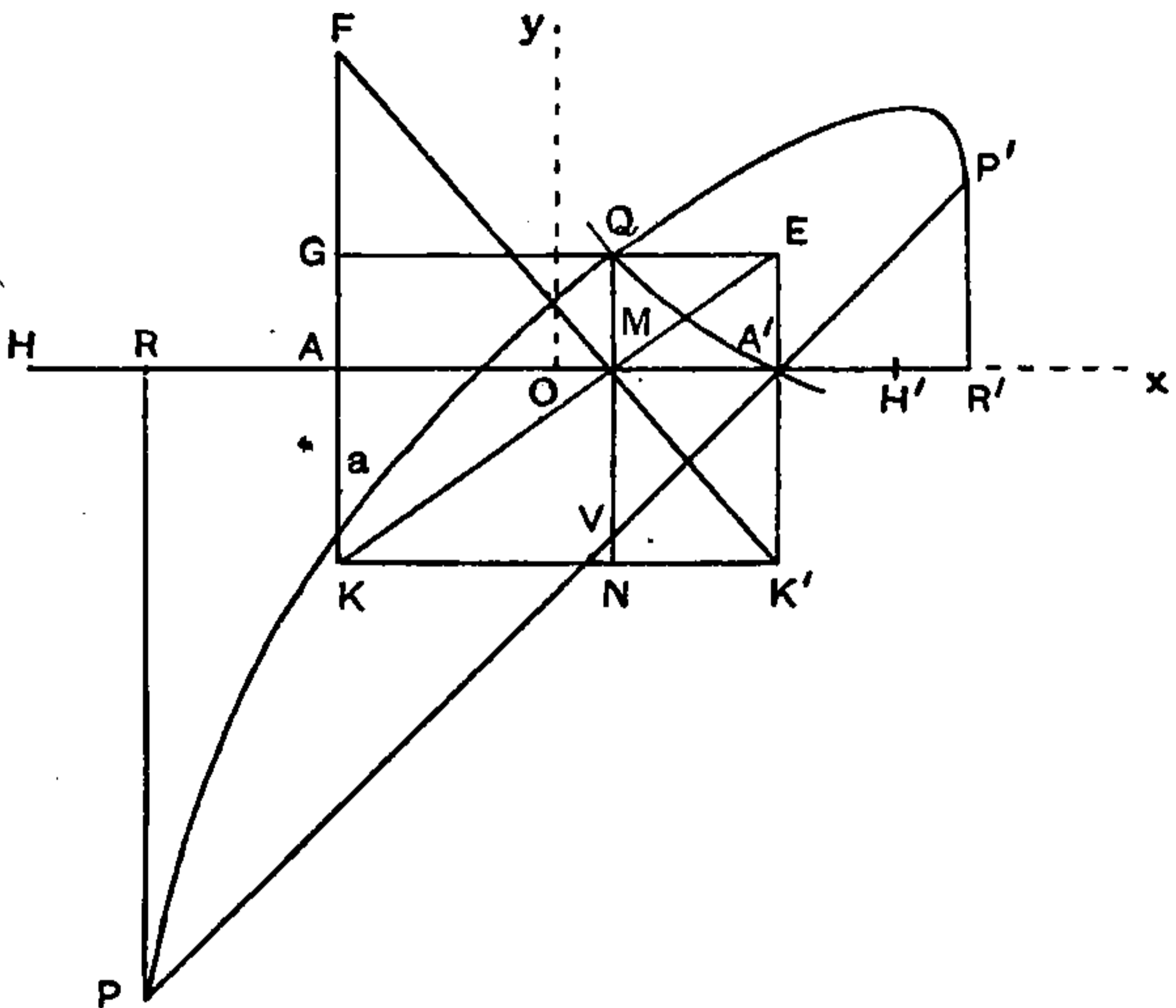

The problem is, given a straight line AA' , a ratio $m:n$, and another straight line $AK (= a)$, to divide AA' at a point M and at the same time to find two points H, H' on AA' produced such that the above relations (with a in place of r) hold.

The analysis leading to the construction is very ingenious. Place $AK (= a)$ at right angles to AA' , and draw $A'K'$ equal and parallel to it.

Suppose the problem solved, and the points M, H, H' all found.

Join KM , produce it, and complete the rectangle $KGEK'$.

Draw QMN through M parallel to AK . Produce $K'M$ to meet KG produced in F .

By similar triangles,

$$FA : AM = K'A' : A'M, \text{ or } FA : h = a : h',$$

whence $FA = AH$ (k , suppose).

Similarly $A'E = A'H'$ (k' , suppose).

Again, by similar triangles,

$$\begin{aligned} (FA + AM) : (A'K' + A'M) &= AM : A'M \\ &= (AK + AM) : (EA' + A'M), \end{aligned}$$

or $(k + h) : (a + h') = (a + h) : (k' + h')$,

$$\text{i. e. } (k + h)(k' + h') = (a + h)(a + h'). \quad (1)$$

Now, by hypothesis,

$$\begin{aligned} m : n &= (k + h) : (k' + h') \\ &= (k + h)(k' + h') : (k' + h')^2 \\ &= (a + h)(a + h') : (k' + h')^2 \text{ [by (1)].} \end{aligned} \quad (2)$$

Measure $AR, A'R'$ on AA' produced both ways equal to a . Draw $RP, R'P'$ at right angles to RR' as shown in the figure. Measure along MN the length MV equal to MA' or h' , and draw PP' through V, A' to meet $RP, R'P'$.

$$\begin{aligned} \text{Then } QV &= k' + h', \quad P'V = \sqrt{2}(a + h'), \\ PV &= \sqrt{2}(a + h), \end{aligned}$$

$$\text{whence } PV \cdot P'V = 2(a + h)(a + h');$$

and, from (2) above,

$$\begin{aligned} 2m : n &= 2(a + h)(a + h') : (k' + h')^2 \\ &= PV \cdot P'V : QV^2. \end{aligned} \quad (3)$$

Therefore Q is on an ellipse in which PP' is a diameter, and QV is an ordinate to it.

Again, $\square GQNK$ is equal to $\square AA'K'K$, whence

$$GQ \cdot QN = AA' \cdot A'K' = (h + h')a = 2ra, \quad (4)$$

and therefore Q is on the rectangular hyperbola with KF, KK' as asymptotes and passing through A' .

How this ingenious analysis was suggested it is not possible to say. It is the equivalent of reducing the four unknowns h, h', k, k' to two, by putting $h = r + x$, $h' = r - x$ and $k' = y$, and then reducing the given relations to two equations in x, y , which are coordinates of a point in relation to Ox, Oy as axes, where O is the middle point of AA' , and Ox lies along OA' , while Oy is perpendicular to it.

Our original relations (p. 47) give

$$y = k' = \frac{ah'}{h} = a \frac{r-x}{r+x}, \quad k = \frac{ah}{h'} = a \frac{r+x}{r-x}, \quad \text{and} \quad \frac{m}{n} = \frac{h+k}{h'+k'}.$$

We have at once, from the first two equations,

$$ky = a \frac{r+x}{r-x} y = a^2,$$

whence $(r+x)y = a(r-x),$

and $(x+r)(y+a) = 2ra,$

which is the rectangular hyperbola (4) above.

Again,
$$\frac{m}{n} = \frac{h+k}{h'+k'} = \frac{(r+x) \left(1 + \frac{a}{r-x}\right)}{(r-x) \left(1 + \frac{a}{r+x}\right)},$$

whence we obtain a cubic equation in x ,

$$(r+x)^2 (r+a-x) = \frac{m}{n} (r-x)^2 (r+a+x),$$

which gives

$$\frac{m}{n} (r-x)^2 \left(\frac{r+a+x}{r+x}\right)^2 = (r+a)^2 - x^2.$$

But $\frac{y}{r-x} = \frac{a}{r+x}$, whence $\frac{y+r-x}{r-x} = \frac{r+a+x}{r+x},$

and the equation becomes

$$\frac{m}{n} (y+r-x)^2 = (r+a)^2 - x^2,$$

which is the ellipse (3) above.

To return to Archimedes. Book II of our treatise contains further problems: To find a sphere equal to a given cone or cylinder (Prop. 1), solved by reduction to the finding of two mean proportionals; to cut a sphere by a plane into two segments having their surfaces in a given ratio (Prop. 3), which is easy (by means of I. 42, 43); given two segments of spheres, to find a third segment of a sphere similar to one of the given segments and having its surface equal to that of the other (Prop. 6); the same problem with volume substituted for surface (Prop. 5), which is again reduced to the finding of two mean proportionals; from a given sphere to cut off a segment having a given ratio to the cone with the same base and equal height (Prop. 7). The Book concludes with two interesting theorems. If a sphere be cut by a plane into two segments, the greater of which has its surface equal to S and its volume equal to V , while S' , V' are the surface and volume of the lesser, then $V:V' < S^2:S'^2$ but $> S^{\frac{3}{2}}:S'^{\frac{3}{2}}$ (Prop. 8): and, of all segments of spheres which have their surfaces equal, the hemisphere is the greatest in volume (Prop. 9).

Measurement of a Circle.

The book on the *Measurement of a Circle* consists of three propositions only, and is not in its original form, having lost (as the treatise *On the Sphere and Cylinder* also has) practically all trace of the Doric dialect in which Archimedes wrote; it may be only a fragment of a larger treatise. The three propositions which survive prove (1) that the area of a circle is equal to that of a right-angled triangle in which the perpendicular is equal to the radius, and the base to the circumference, of the circle, (2) that the area of a circle is to the square on its diameter as 11 to 14 (the text of this proposition is, however, unsatisfactory, and it cannot have been placed by Archimedes before Prop. 3, on which it depends), (3) that the ratio of the circumference of any circle to its diameter (i. e. π) is $< 3\frac{1}{7}$ but $> 3\frac{1}{7}\frac{0}{1}$. Prop. 1 is proved by the method of exhaustion in Archimedes's usual form: he approximates to the area of the circle in both directions (α) by inscribing successive regular polygons with a number of

sides continually doubled, beginning from a square, (*b*) by circumscribing a similar set of regular polygons beginning from a square, it being shown that, if the number of the sides of these polygons be continually doubled, more than half of the portion of the polygon outside the circle will be taken away each time, so that we shall ultimately arrive at a circumscribed polygon greater than the circle by a space less than any assigned area.

Prop. 3, containing the arithmetical approximation to π , is the most interesting. The method amounts to calculating approximately the perimeter of two regular polygons of 96 sides, one of which is circumscribed, and the other inscribed, to the circle; and the calculation starts from a greater and a lesser limit to the value of $\sqrt{3}$, which Archimedes assumes without remark as known, namely

$$\frac{265}{153} < \sqrt{3} < \frac{1351}{780}.$$

How did Archimedes arrive at these particular approximations? No puzzle has exercised more fascination upon writers interested in the history of mathematics. De Lagny, Mollweide, Buzengeiger, Hauber, Zeuthen, P. Tannery, Heilermann, Hultsch, Hunrath, Wertheim, Bobynin: these are the names of some of the authors of different conjectures. The simplest supposition is certainly that of Hunrath and Hultsch, who suggested that the formula used was

$$a \pm \frac{b}{2a} > \sqrt{a^2 \pm b} > a \pm \frac{b}{2a \pm 1},$$

where a^2 is the nearest square number above or below $a^2 \pm b$, as the case may be. The use of the first part of this formula by Heron, who made a number of such approximations, is proved by a passage in his *Metrica*¹, where a rule equivalent to this is applied to $\sqrt{720}$; the second part of the formula is used by the Arabian Alkarkhī (eleventh century) who drew from Greek sources, and one approximation in Heron may be obtained in this way.² Another suggestion (that of Tannery

¹ Heron, *Metrica*, i. 8.

² *Stereom.* ii, p. 184. 19, Hultsch; p. 154. 19, Heib. $\sqrt{54} = 7\frac{1}{3} = 7\frac{5}{15}$ instead of $7\frac{5}{14}$.

and Zeuthen) is that the successive solutions in integers of the equations

$$\left. \begin{aligned} x^2 - 3y^2 &= 1 \\ x^2 - 3y^2 &= -2 \end{aligned} \right\}$$

may have been found in a similar way to those of the equations $x^2 - 2y^2 = \pm 1$ given by Theon of Smyrna after the Pythagoreans. The rest of the suggestions amount for the most part to the use of the method of continued fractions more or less disguised.

Applying the above formula, we easily find

$$2 - \frac{1}{4} > \sqrt{3} > 2 - \frac{1}{3},$$

or
$$\frac{7}{4} > \sqrt{3} > \frac{5}{3}.$$

Next, clearing of fractions, we consider 5 as an approximation to $\sqrt{3 \cdot 3^2}$ or $\sqrt{27}$, and we have

$$5 + \frac{2}{10} > 3\sqrt{3} > 5 + \frac{2}{11},$$

whence
$$\frac{26}{15} > \sqrt{3} > \frac{19}{11}.$$

Clearing of fractions again, and taking 26 as an approximation to $\sqrt{3 \cdot 15^2}$ or $\sqrt{675}$, we have

$$26 - \frac{1}{52} > 15\sqrt{3} > 26 - \frac{1}{51},$$

which reduces to

$$\frac{1351}{780} > \sqrt{3} > \frac{265}{153}.$$

Archimedes first takes the case of the circumscribed polygon. Let CA be the tangent at A to a circular arc with centre O . Make the angle AOC equal to one-third of a right angle. Bisect the angle AOC by OD , the angle AOD by OE , the angle AOE by OF , and the angle FOA by OG . Produce GA to AH , making AH equal to AG . The angle GOH is then equal to the angle FOA which is $\frac{1}{24}$ th of a right angle, so that GH is the side of a circumscribed regular polygon with 96 sides.

Now
$$OA : AC [= \sqrt{3} : 1] > 265 : 153, \quad (1)$$

and
$$OC : CA = 2 : 1 = 306 : 153. \quad (2)$$

And, since OD bisects the angle COA ,

$$CO : OA = CD : DA,$$

so that $(CO + OA) : OA = CA : DA$,

or $(CO + OA) : CA = OA : AD$.

Hence $OA : AD > 571 : 153$, by (1) and (2).

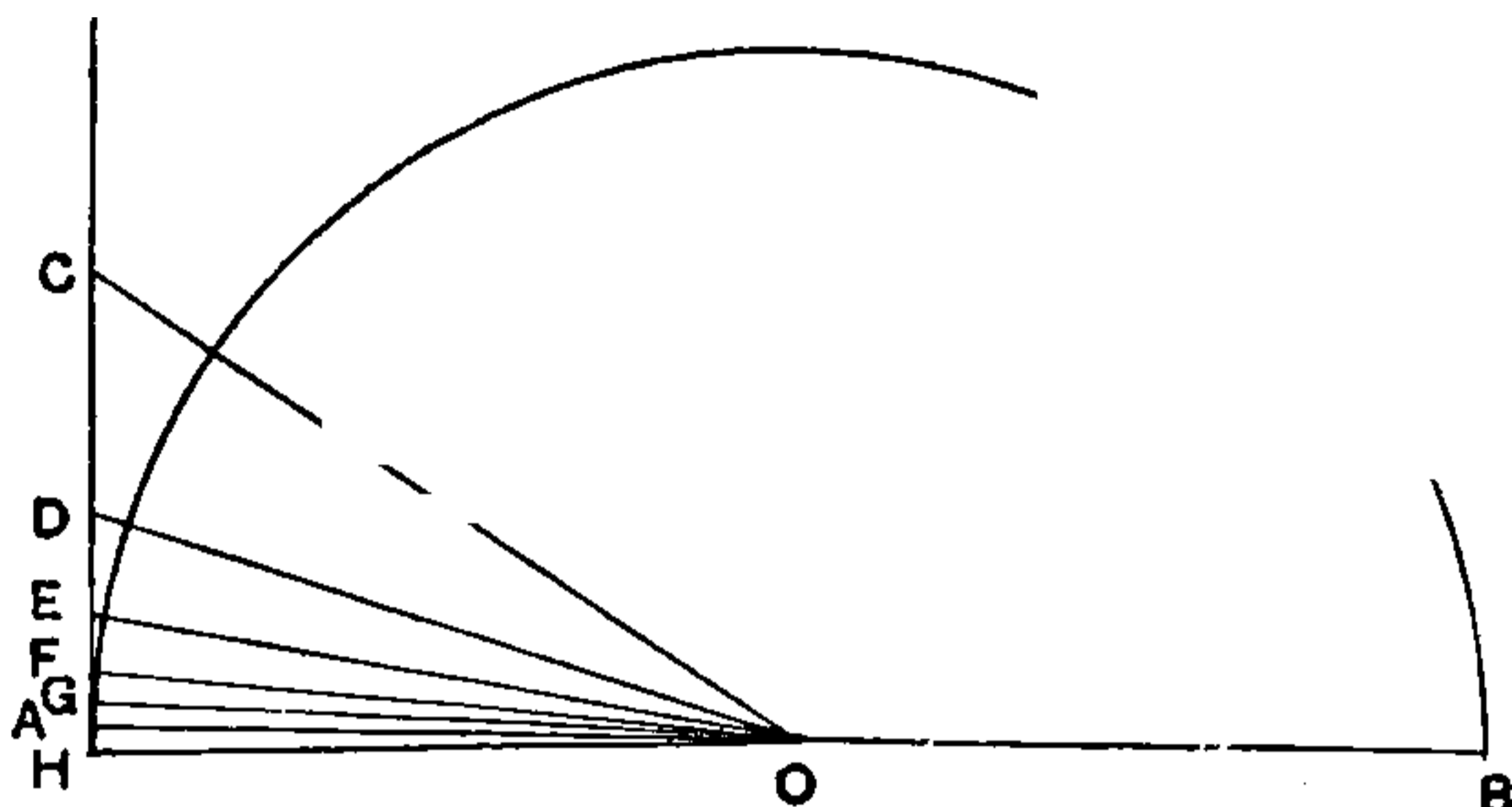

And $OD^2 : AD^2 = (OA^2 + AD^2) : AD^2$
 $> (571^2 + 153^2) : 153^2$
 $> 349450 : 23409$.

Therefore, says Archimedes,

$$OD : DA > 591\frac{1}{8} : 153.$$

Next, just as we have found the limit of $OD : AD$ from $OC : CA$ and the limit of $OA : AC$, we find the limits of $OA : AE$ and $OE : AE$ from the limits of $OD : DA$ and $OA : AD$, and so on. This gives ultimately the limit of $OA : AG$.

Dealing with the inscribed polygon, Archimedes gets a similar series of approximations. ABC being a semicircle, the angle BAC is made equal to one-third of a right angle. Then, if the angle BAC is bisected by AD , the angle BAD by AE , the angle BAE by AF , and the angle BAF by AG , the straight line BG is the side of an inscribed polygon with 96 sides.



THIS PAGE IS LOCKED TO FREE MEMBERS

Purchase full membership to immediately unlock this page

DELVE INTO FANTASY, MAGIC, MYTHOLOGY & FOLKLORE

Forgotten Books'
Full Membership gives
access to 797,885 ancient
and modern, fiction and
non-fiction books.

Continue

*Fair usage policy applies

The series of values found by Archimedes are shown in the following table:

a	b	c	n	a	b	c
65	306	153	0	1351	1560	780
71	$> [\sqrt{(571^2 + 153^2)}]$	153	1	2911	$< \sqrt{(2911^2 + 780^2)}$	780
	$> 591\frac{1}{8}$				$< 3013\frac{1}{2} \frac{1}{4}$	
$62\frac{1}{8}$	$> [\sqrt{\{(1162\frac{1}{8})^2 + 153^2\}}]$	153	2	$5924\frac{1}{2} \frac{1}{4}$...	780
	$> 1172\frac{1}{8}$			1823	$\left\{ \begin{array}{l} < \sqrt{(1823^2 + 240^2)} \\ < 1838\frac{9}{11} \end{array} \right.$	240
$34\frac{1}{4}$	$> [\sqrt{\{(2334\frac{1}{4})^2 + 153^2\}}]$	153	3	$3661\frac{9}{11}$...	240
	$> 2339\frac{1}{4}$			1007	$\left\{ \begin{array}{l} < \sqrt{(1007^2 + 66^2)} \\ < 1009\frac{1}{6} \end{array} \right.$	66
$73\frac{1}{2}$		153	4	$2016\frac{1}{6}$	$\left\{ \begin{array}{l} < \sqrt{\{(2016\frac{1}{6})^2 + 66^2\}} \\ < 2017\frac{1}{4} \end{array} \right.$	66

and, bearing in mind that in the first case the final ratio $a_4 : c$ is the ratio $OA : AG = 2 OA : GH$, and in the second case the final ratio $b_4 : c$ is the ratio $AB : BG$, while GH in the first figure and BG in the second are the sides of regular polygons of 96 sides circumscribed and inscribed respectively, we have finally

$$\frac{96 \times 153}{4673\frac{1}{2}} > \pi > \frac{96 \times 66}{2017\frac{1}{4}}$$

Archimedes simply infers from this that

$$3\frac{1}{7} > \pi > 3\frac{10}{71}$$

As a matter of fact $\frac{96 \times 153}{4673\frac{1}{2}} = 3 \frac{667\frac{1}{2}}{4673\frac{1}{2}}$, and $\frac{667\frac{1}{2}}{4672\frac{1}{2}} = \frac{1}{7}$.

It is also to be observed that $3\frac{10}{71} = 3 + \frac{1}{7 + \frac{1}{10}}$, and it may have been arrived at by a method equivalent to developing the fraction $\frac{6336}{2017\frac{1}{4}}$ in the form of a continued fraction.

It should be noted that, in the text as we have it, the values of b_1, b_2, b_3, b_4 are simply stated in their final form without the intermediate step containing the radical except in the first

* † Here the ratios of a to c are in the first instance reduced to lowest terms.

case of all, where we are told that $OD^2 : AD^2 > 349450 : 23409$ and then that $OD : DA > 591\frac{1}{8} : 153$. At the points marked * and † in the table Archimedes simplifies the ratio $a_2 : c$ and $a_3 : c$ before calculating b_2, b_3 respectively, by multiplying each term in the first case by $\frac{4}{13}$ and in the second case by $\frac{1}{40}$. He gives no explanation of the exact figure taken as the approximation to the square root in each case, or of the method by which he obtained it. We may, however, be sure that the method amounted to the use of the formula $(a \pm b)^2 = a^2 \pm 2ab + b^2$, much as our method of extracting the square root also depends upon it.

We have already seen (vol. i, p. 232) that, according to Heron, Archimedes made a still closer approximation to the value of π .

On Conoids and Spheroids.

The main problems attacked in this treatise are, in Archimedes's manner, stated in his preface addressed to Dositheus, which also sets out the premisses with regard to the solid figures in question. These premisses consist of definitions and obvious inferences from them. The figures are (1) the *right-angled conoid* (paraboloid of revolution), (2) the *obtuse-angled conoid* (hyperboloid of revolution), and (3) the *spheroids* (a) the *oblong*, described by the revolution of an ellipse about its 'greater diameter' (major axis), (b) the *flat*, described by the revolution of an ellipse about its 'lesser diameter' (minor axis). Other definitions are those of the *vertex* and *axis* of the figures or segments thereof, the vertex of a segment being the point of contact of the tangent plane to the solid which is parallel to the base of the segment. The *centre* is only recognized in the case of the spheroid; what corresponds to the centre in the case of the hyperboloid is the 'vertex of the enveloping cone' (described by the revolution of what Archimedes calls the 'nearest lines to the section of the obtuse-angled cone', i.e. the asymptotes of the hyperbola), and the line between this point and the vertex of the hyperboloid or segment is called, not the axis or diameter, but (the line) 'adjacent to the axis'. The axis of the segment is in the case of the paraboloid the line through the vertex of the segment parallel to the axis of the paraboloid, in the case

of the hyperboloid the portion within the solid of the line joining the vertex of the enveloping cone to the vertex of the segment and produced, and in the case of the spheroids the line joining the points of contact of the two tangent planes parallel to the base of the segment. Definitions are added of a 'segment of a cone' (the figure cut off towards the vertex by an elliptical, not circular, section of the cone) and a 'frustum of a cylinder' (cut off by two parallel elliptical sections).

Props. 1 to 18 with a Lemma at the beginning are preliminary to the main subject of the treatise. The Lemma and Props. 1, 2 are general propositions needed afterwards. They include propositions in summation,

$$2 \{a + 2a + 3a + \dots + na\} > n \cdot na > 2 \{a + 2a + \dots + (n-1)a\} \quad (\text{Lemma})$$

(this is clear from $S_n = \frac{1}{2}n(n+1)a$);

$$\begin{aligned} (n+1)(na)^2 + a(a + 2a + 3a + \dots + na) \\ = 3 \{a^2 + (2a)^2 + (3a)^2 + \dots + (na)^2\}; \end{aligned} \quad (\text{Lemma to Prop. 2})$$

whence (Cor.)

$$\begin{aligned} 3 \{a^2 + (2a)^2 + (3a)^2 + \dots + (na)^2\} > n(na)^2 \\ > 3 \{a^2 + (2a)^2 + \dots + (\overline{n-1}a)^2\}; \end{aligned}$$

lastly, Prop. 2 gives limits for the sum of n terms of the series $ax + x^2$, $a \cdot 2x + (2x)^2$, $a \cdot 3x + (3x)^2$, ..., in the form of inequalities of ratios, thus:

$$\begin{aligned} n \{a \cdot nx + (nx)^2\} : \Sigma_1^{n-1} \{a \cdot rx + (rx)^2\} \\ > (a + nx) : (\frac{1}{2}a + \frac{1}{3}nx) \\ > n \{a \cdot nx + (nx)^2\} : \Sigma_1^n \{a \cdot rx + (rx)^2\}. \end{aligned}$$

Prop. 3 proves that, if QQ' be a chord of a parabola bisected at V by the diameter PV , then, if PV be of constant length, the areas of the triangle PQQ' and of the segment PQQ' are also constant, whatever be the direction of QQ' ; to prove it Archimedes assumes a proposition 'proved in the conics' and by no means easy, namely that, if QD be perpendicular to PV , and if p , p_a be the parameters corresponding to the ordinates parallel to QQ' and the principal ordinates respectively, then

$$QV^2 : QD^2 = p : p_a.$$

Props. 4-6 deal with the area of an ellipse, which is, in the

first of the three propositions, proved to be to the area of the auxiliary circle as the minor axis to the major; equilateral polygons of $4n$ sides are inscribed in the circle and compared with corresponding polygons inscribed in the ellipse, which are determined by the intersections with the ellipse of the double ordinates passing through the angular points of the polygons inscribed in the circle, and the method of exhaustion is then applied in the usual way. Props. 7, 8 show how, given an ellipse with centre C and a straight line CO in a plane perpendicular to that of the ellipse and passing through an axis of it, (1) in the case where OC is perpendicular to that axis, (2) in the case where it is not, we can find an (in general oblique) circular cone with vertex O such that the given ellipse is a section of it, or, in other words, how we can find the circular sections of the cone with vertex O which passes through the circumference of the ellipse; similarly Prop. 9 shows how to find the circular sections of a cylinder with CO as axis and with surface passing through the circumference of an ellipse with centre C , where CO is in the plane through an axis of the ellipse and perpendicular to its plane, but is not itself perpendicular to that axis. Props. 11–18 give simple properties of the conoids and spheroids, easily derivable from the properties of the respective conics; they explain the nature and relation of the sections made by planes cutting the solids respectively in different ways (planes through the axis, parallel to the axis, through the centre or the vertex of the enveloping cone, perpendicular to the axis, or cutting it obliquely, respectively), with especial reference to the elliptical sections of each solid, the similarity of parallel elliptical sections, &c. Then with Prop. 19 the real business of the treatise begins, namely the investigation of the volume of segments (right or oblique) of the two conoids and the spheroids respectively.

The method is, in all cases, to circumscribe and inscribe to the segment solid figures made up of cylinders or 'frusta of cylinders', which can be made to differ as little as we please from one another, so that the circumscribed and inscribed figures are, as it were, compressed together and into coincidence with the segment which is intermediate between them.

In each diagram the plane of the paper is a plane through the axis of the conoid or spheroid at right angles to the plane

of the section which is the base of the segment, and which is a circle or an ellipse according as the said base is or is not at right angles to the axis; the plane of the paper cuts the base in a diameter of the circle or an axis of the ellipse as the case may be.

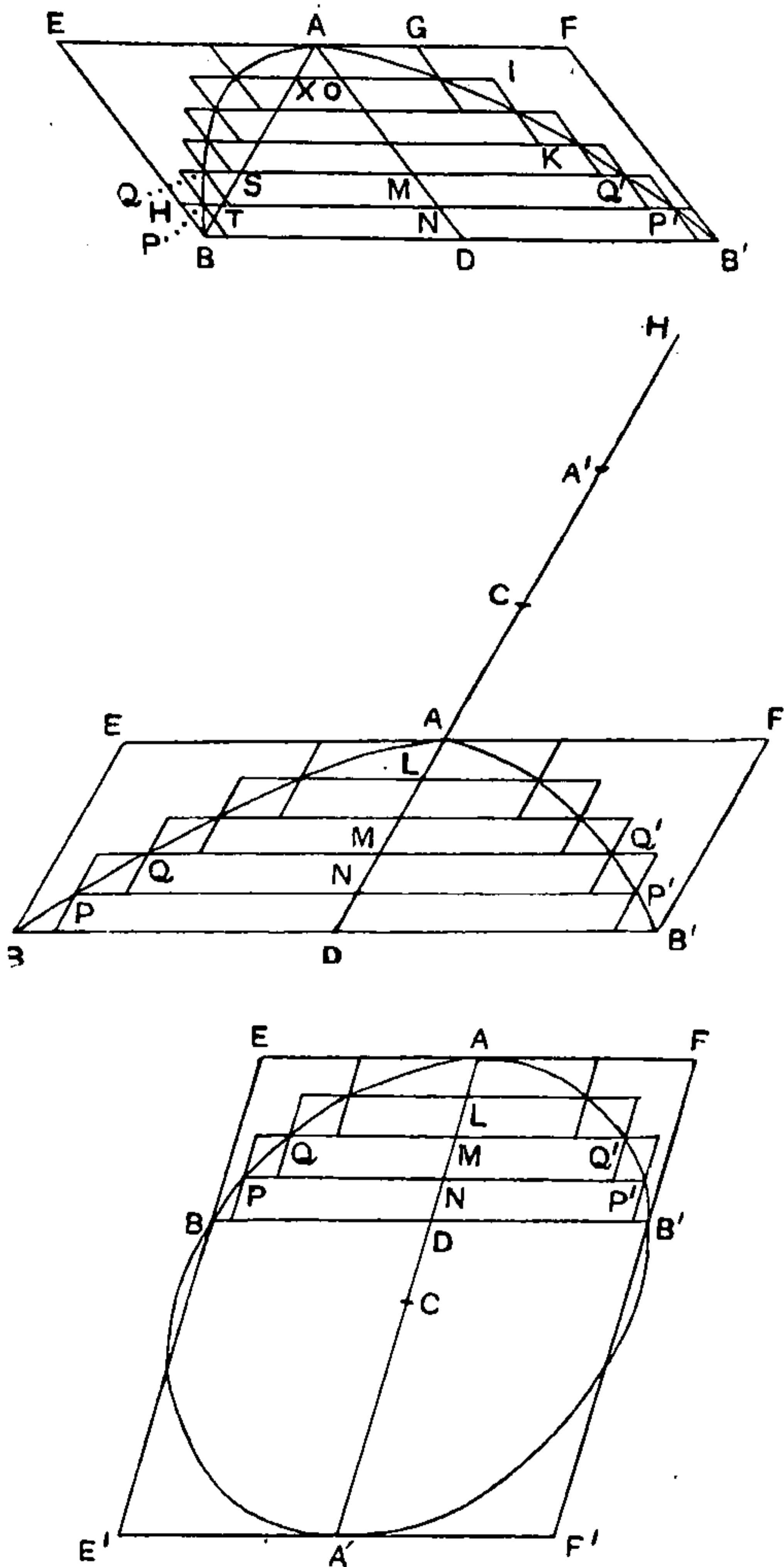

The nature of the inscribed and circumscribed figures will be seen from the above figures showing segments of a paraboloid, a hyperboloid and a spheroid respectively, cut off

by planes obliquely inclined to the axis. The base of the segment is an ellipse in which BB' is an axis, and its plane is at right angles to the plane of the paper, which passes through the axis of the solid and cuts it in a parabola, a hyperbola, or an ellipse respectively. The axis of the segment is cut into a number of equal parts in each case, and planes are drawn through each point of section parallel to the base, cutting the solid in ellipses, similar to the base, in which PP' , QQ' , &c., are axes. Describing frusta of cylinders with axis AD and passing through these elliptical sections respectively, we draw the circumscribed and inscribed solids consisting of these frusta. It is evident that, beginning from A , the first inscribed frustum is equal to the first circumscribed frustum, the second to the second, and so on, but there is one more circumscribed frustum than inscribed, and the difference between the circumscribed and inscribed solids is equal to the *last frustum* of which BB' is the base, and ND is the axis. Since ND can be made as small as we please, the difference between the circumscribed and inscribed solids can be made less than any assigned solid whatever. Hence we have the requirements for applying the method of exhaustion.

Consider now separately the cases of the paraboloid, the hyperboloid and the spheroid.

I. The *paraboloid* (Props. 20–22).

The frustum the base of which is the ellipse in which PP' is an axis is proportional to PP'^2 or PN^2 , i. e. proportional to AN . Suppose that the axis AD ($= c$) is divided into n equal parts. Archimedes compares each frustum in the inscribed and circumscribed figure with the frustum of the whole cylinder BF cut off by the same planes. Thus

$$\begin{aligned} (\text{first frustum in } BF) &: (\text{first frustum in inscribed figure}) \\ &= BD^2 : PN^2 \\ &= AD : AN \\ &= BD : TN. \end{aligned}$$

Similarly

$$\begin{aligned} (\text{second frustum in } BF) &: (\text{second in inscribed figure}) \\ &= HN : SM, \end{aligned}$$

and so on. The last frustum in the cylinder BF has none to

correspond to it in the inscribed figure, and we should write the ratio as $(BD : \text{zero})$.

Archimedes concludes, by means of a lemma in proportions forming Prop. 1, that

$$\begin{aligned} (\text{frustum } BF) &: (\text{inscribed figure}) \\ &= (BD + HN + \dots) : (TN + SM + \dots + XO) \\ &= n^2k : (k + 2k + 3k + \dots + \overline{n-1}k), \end{aligned}$$

where $XO = k$, so that $BD = nk$.

In like manner, he concludes that

$$\begin{aligned} (\text{frustum } BF) &: (\text{circumscribed figure}) \\ &= n^2k : (k + 2k + 3k + \dots + nk). \end{aligned}$$

But, by the Lemma preceding Prop. 1,

$$k + 2k + 3k + \dots + \overline{n-1}k < \frac{1}{2}n^2k < k + 2k + 3k + \dots + nk,$$

whence

$$(\text{frustum } BF) : (\text{inscr. fig.}) > 2 > (\text{frustum } BF) : (\text{circumscr. fig.}).$$

This indicates the desired result, which is then confirmed by the method of exhaustion, namely that

$$(\text{frustum } BF) = 2 (\text{segment of paraboloid}),$$

or, if V be the volume of the 'segment of a cone', with vertex A and base the same as that of the segment,

$$(\text{volume of segment}) = \frac{3}{2}V.$$

Archimedes, it will be seen, proves in effect that, if k be indefinitely diminished, and n indefinitely increased, while nk remains equal to c , then

$$\text{limit of } k \{k + 2k + 3k + \dots + (n-1)k\} = \frac{1}{2}c^2,$$

that is, in our notation,

$$\int_0^c x dx = \frac{1}{2}c^2.$$

Prop. 23 proves that the volume is constant for a given length of axis AD , whether the segment is cut off by a plane perpendicular or not perpendicular to the axis, and Prop. 24 shows that the volumes of two segments are as the squares on their axes.



THIS PAGE IS LOCKED TO FREE MEMBERS

Purchase full membership to immediately unlock this page

FORGOTTEN BOOKS

FULL

MEMBERSHIP

797,885 Books!

All you can read

for only

\$8.99/month

Continue

*Fair usage policy applies



so that

$$hS_n = ah(h + 2h + \dots + nh) + h \{h^2 + (2h)^2 + \dots + (nh)^2\}.$$

The limit of this latter expression is what we should write

$$\int_0^b (ax + x^2) dx = b^2 \left(\frac{1}{2}a + \frac{1}{3}b\right),$$

and Archimedes's procedure is the equivalent of this integration.

III. In the case of the *spheroid* (Props. 29, 30) we take a segment less than half the spheroid.

As in the case of the hyperboloid,

$$\begin{aligned} (\text{frustum in } BF) &: (\text{frustum on base } QQ') \\ &= BD^2 : QM^2 \\ &= AD \cdot A'D : AM \cdot A'M; \end{aligned}$$

but, in order to reduce the summation to the same as that in Prop. 2, Archimedes expresses $AM \cdot A'M$ in a different form equivalent to the following.

Let $AD (= b)$ be divided into n equal parts of length h , and suppose that $AA' = a$, $CD = \frac{1}{2}c$.

$$\text{Then} \quad AD \cdot A'D = \frac{1}{4}a^2 - \frac{1}{4}c^2,$$

$$\begin{aligned} \text{and} \quad AM \cdot A'M &= \frac{1}{4}a^2 - \left(\frac{1}{2}c + rh\right)^2 \quad (DM = rh) \\ &= AD \cdot A'D - \{c \cdot rh + (rh)^2\} \\ &= cb + b^2 - \{c \cdot rh + (rh)^2\}. \end{aligned}$$

Thus in this case we have

(frustum BF) : (inscribed figure)

$$= n(cb + b^2) : [n(cb + b^2) - \Sigma_1^n \{c \cdot rh + (rh)^2\}]$$

and

(frustum BF) : (circumscribed figure)

$$= n(cb + b^2) : [n(cb + b^2) - \Sigma_1^{n-1} \{c \cdot rh + (rh)^2\}].$$

And, since $b = nh$, we have, by means of Prop. 2,

$$n(cb + b^2) : [n(cb + b^2) - \Sigma_1^n \{c \cdot rh + (rh)^2\}]$$

$$> (c + b) : \{c + b - (\frac{1}{2}c + \frac{1}{3}b)\}$$

$$> n(cb + b^2) : [n(cb + b^2) - \Sigma_1^{n-1} \{c \cdot rh + (rh)^2\}].$$

The conclusion, confirmed as usual by the method of exhaustion, is that

$$\begin{aligned} (\text{frustum } BF) : (\text{segment of spheroid}) &= (c + b) : \{c + b - (\frac{1}{2}c + \frac{1}{3}b)\} \\ &= (c + b) : (\frac{1}{2}c + \frac{2}{3}b), \end{aligned}$$

$$\begin{aligned} \text{whence } (\text{volume of segment}) : (\text{volume of cone } ABB') \\ &= (\frac{3}{2}c + 2b) : (c + b) \\ &= (3CA - AD) : (2CA - AD), \text{ since } CA = \frac{1}{2}c + b. \end{aligned}$$

As a particular case (Props. 27, 28), half the spheroid is double of the corresponding cone.

Props. 31, 32, concluding the treatise, deduce the similar formula for the volume of the greater segment, namely, in our figure,

$$\begin{aligned} (\text{greater segmt.}) : (\text{cone or segmt. of cone with same base and axis}) \\ &= (CA + AD) : AD. \end{aligned}$$

On Spirals.

The treatise *On Spirals* begins with a preface addressed to Dositheus in which Archimedes mentions the death of Conon as a grievous loss to mathematics, and then summarizes the main results of the treatises *On the Sphere and Cylinder* and *On Conoids and Spheroids*, observing that the last two propositions of Book II of the former treatise took the place of two which, as originally enunciated to Dositheus, were wrong; lastly, he states the main results of the treatise *On Spirals*, premising the definition of a spiral which is as follows:

‘If a straight line one extremity of which remains fixed be made to revolve at a uniform rate in a plane until it returns to the position from which it started, and if, at the same time as the straight line is revolving, a point move at a uniform rate along the straight line, starting from the fixed extremity, the point will describe a spiral in the plane.’

As usual, we have a series of propositions preliminary to the main subject, first two propositions about uniform motion,

then two simple geometrical propositions, followed by propositions (5-9) which are all of one type. Prop. 5 states that, given a circle with centre O , a tangent to it at A , and c , the

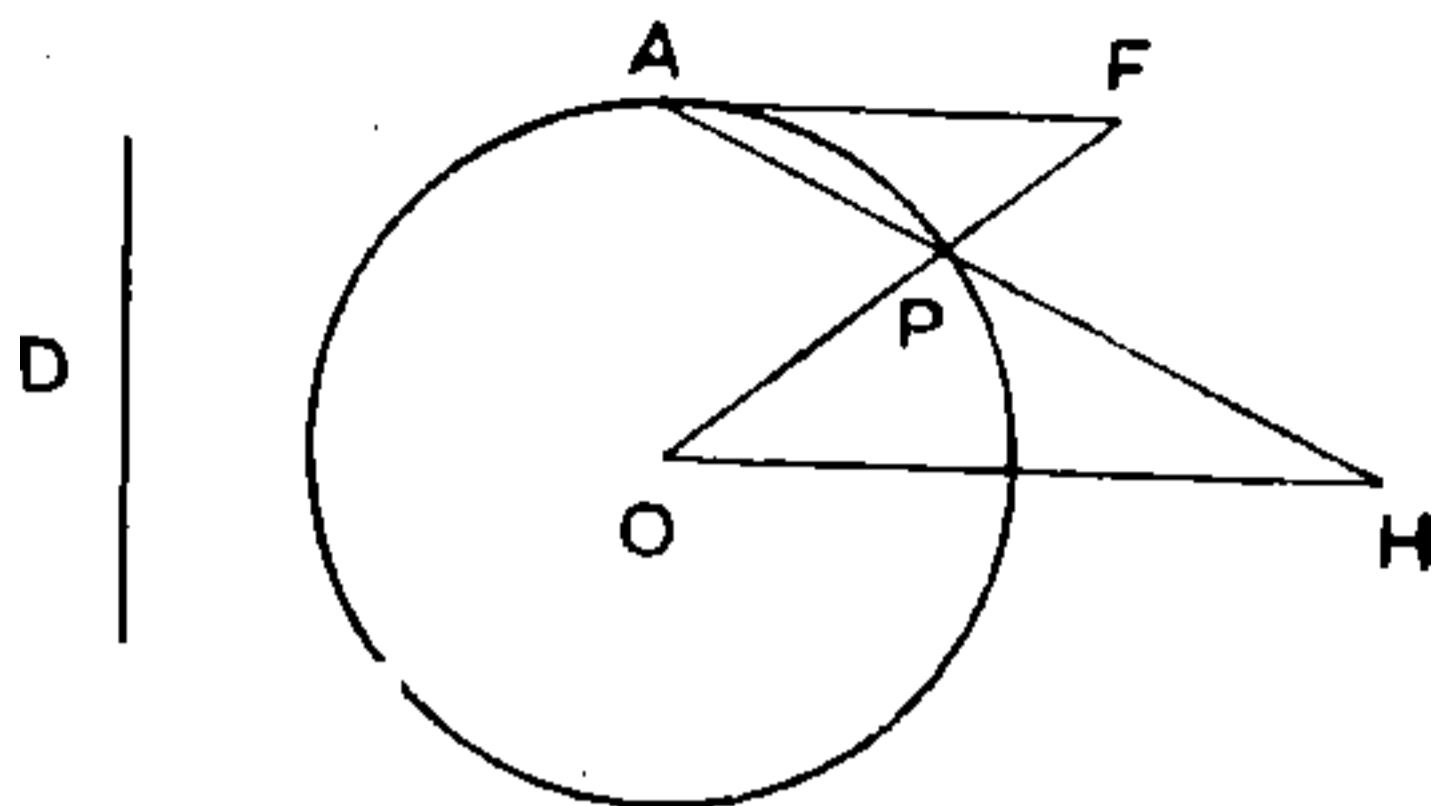

FIG. 1.

circumference of any circle whatever, it is possible to draw a straight line OPF meeting the circle in P and the tangent in F such that

$$FP : OP < (\text{arc } AP) : c.$$

Archimedes takes D a straight line greater than c , draws OH parallel to the tangent at A and then says 'let PH be placed equal to D verging ($\nu\acute{\epsilon}\upsilon\upsilon\sigma\alpha$) towards A '. This is the usual phraseology of the type of problem known as $\nu\acute{\epsilon}\upsilon\sigma\iota\varsigma$ where a straight line of given length has to be placed between two lines or curves in such a position that, if produced, it passes through a given point (this is the meaning of *verging*). Each of the propositions 5-9 depends on a $\nu\acute{\epsilon}\upsilon\sigma\iota\varsigma$ of this kind,

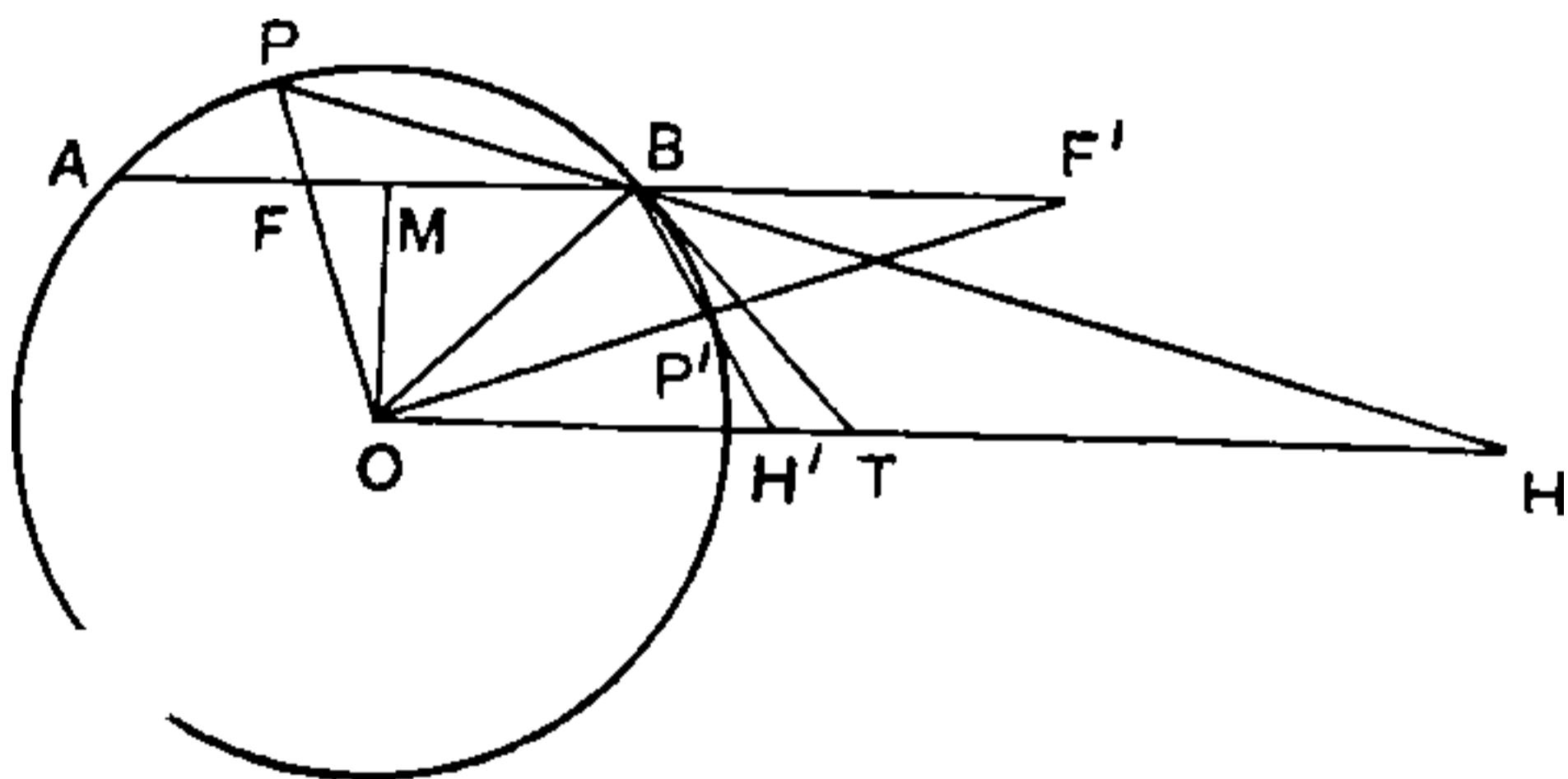

FIG. 2.

which Archimedes assumes as 'possible' without showing how it is effected. Except in the case of Prop. 5, the theoretical solution cannot be effected by means of the straight line and circle; it depends in general on the solution of an equation of the fourth degree, which can be solved by means of the

points of intersection of a certain rectangular hyperbola and a certain parabola. It is quite possible, however, that such problems were in practice often solved by a mechanical method, namely by placing a ruler, by trial, in the position of the required line: for it is only necessary to place the ruler so that it passes through the given point and then turn it round that point as a pivot till the intercept becomes of the given length. In Props. 6–9 we have a circle with centre O , a chord AB less than the diameter in it, OM the perpendicular from O on AB , BT the tangent at B , OT the straight line through O parallel to AB ; $D:E$ is any ratio less or greater, as the case may be, than the ratio $BM:MO$. Props. 6, 7 (Fig. 2) show that it is possible to draw a straight line OP

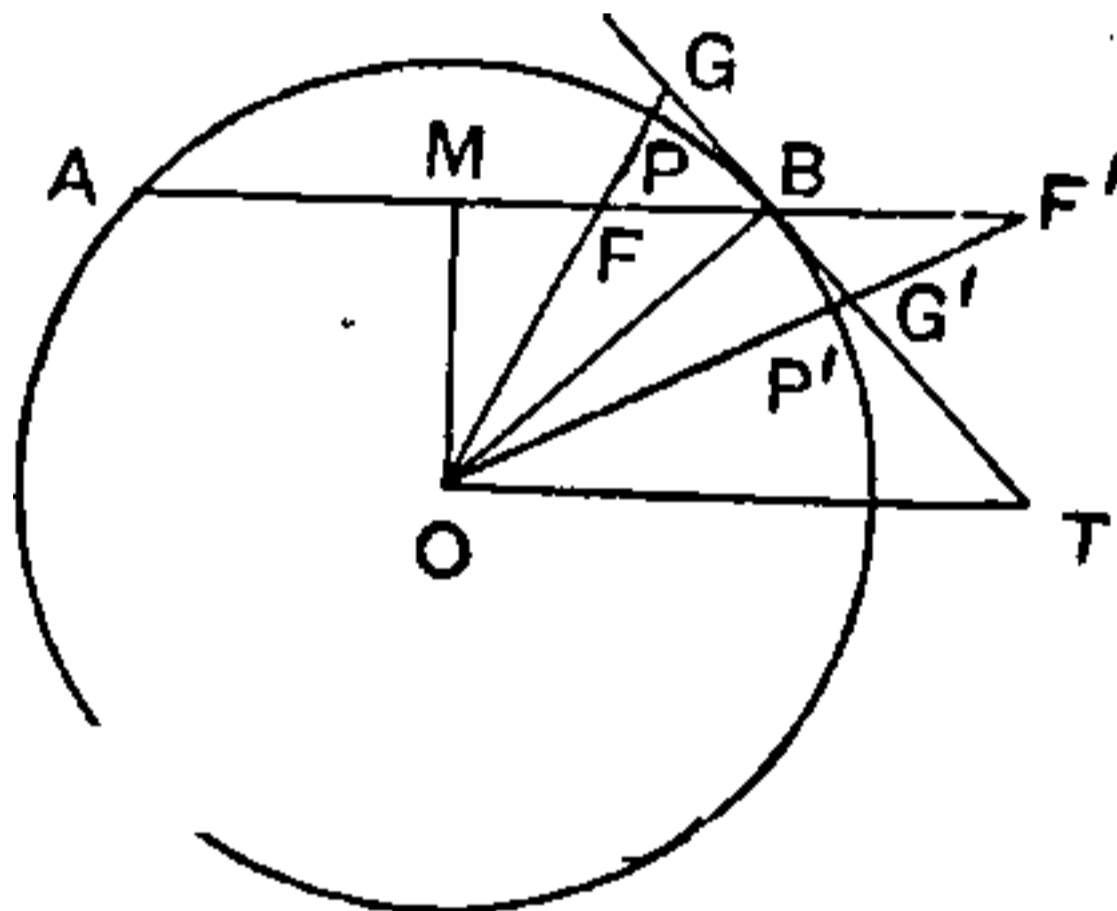

FIG. 3.

meeting AB in F and the circle in P such that $FP:PB = D:E$ (OP meeting AB in the case where $D:E < BM:MO$, and meeting AB produced when $D:E > BM:MO$). In Props. 8, 9 (Fig. 3) it is proved that it is possible to draw a straight line OPG meeting AB in F , the circle in P and the tangent at B in G , such that $FP:BG = D:E$ (OP meeting AB itself in the case where $D:E < BM:MO$, and meeting AB produced in the case where $D:E > BM:MO$).

We will illustrate by the constructions in Props. 7, 8, as it is these propositions which are actually cited later. Prop. 7. If $D:E$ is any ratio $> BM:MO$, it is required (Fig. 2) to draw $OP'F'$ meeting the circle in P' and AB produced in F' so that

$$F'P':P'B = D:E.$$

Draw OT parallel to AB , and let the tangent to the circle at B meet OT in T .

Then $D : E > BM : MO$, by hypothesis,
 $> OB : BT$, by similar triangles.

Take a straight line $P'H'$ (less than BT) such that $D : E = OB : P'H'$, and place $P'H'$ between the circle and OT 'verging towards B ' (construction assumed).

Then $F'P' : P'B = OP' : P'H'$
 $= OB : P'H'$
 $= D : E.$

Prop. 8. If $D : E$ is any given ratio $< BM : MO$, it is required to draw $OFPG$ meeting AB in F , the circle in P , and the tangent at B to the circle in G so that

$$FP : BG = D : E.$$

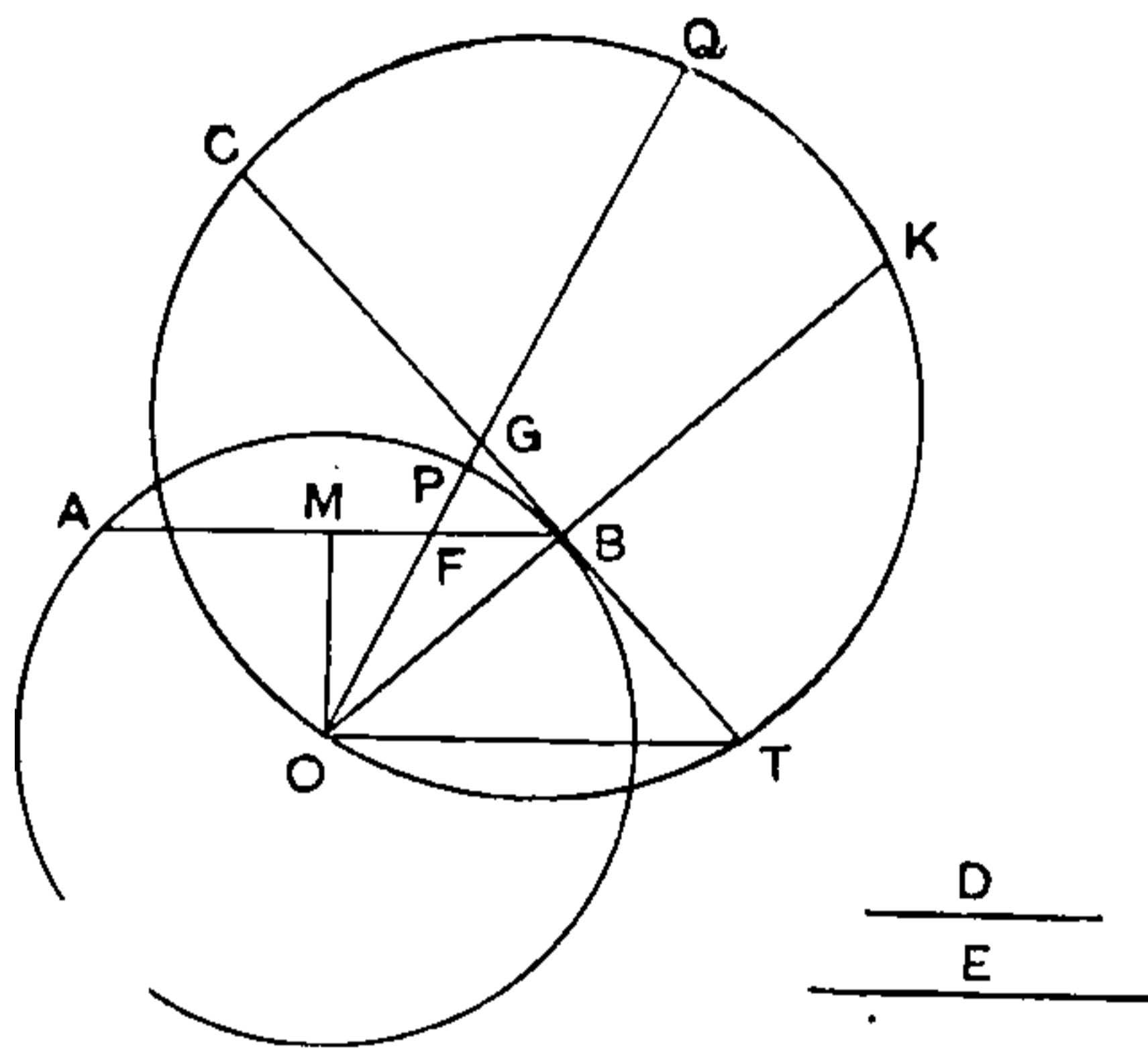

If OT is parallel to AB and meets the tangent at B in T ,
 $BM : MO = OB : BT$, by similar triangles,

whence $D : E < OB : BT$.

Produce TB to C , making BC of such length that

$$D : E = OB : BC,$$

so that $BC > BT$.

Describe a circle through the three points Q, T, C and let OB produced meet this circle in K .

'Then, since $BC > BT$, and OK is perpendicular to CT , it is possible to place QG [between the circle TKC and BC] equal to BK and verging towards O ' (construction assumed).

Let QGO meet the original circle in P and AB in F . Then $OFPG$ is the straight line required.

$$\text{For} \quad CG \cdot GT = OG \cdot GQ = OG \cdot BK.$$

$$\text{But} \quad OF : OG = BT : GT, \text{ by parallels,}$$

$$\text{whence} \quad OF \cdot GT = OG \cdot BT.$$

$$\text{Therefore} \quad CG \cdot GT : OF \cdot GT = OG \cdot BK : OG \cdot BT,$$

$$\begin{aligned} \text{whence} \quad CG : OF &= BK : BT \\ &= BC : OB \\ &= BC : OP. \end{aligned}$$

$$\text{Therefore} \quad OP : OF = BC : CG,$$

$$\text{and hence} \quad PF : OP = BG : BC,$$

$$\text{or} \quad PF : BG = OB : BC = D : E.$$

Pappus objects to Archimedes's use of the $\nu\epsilon\upsilon\sigma\iota\varsigma$ assumed in Prop. 8, 9 in these words:

'it seems to be a grave error into which geometers fall whenever any one discovers the solution of a plane problem by means of conics or linear (higher) curves, or generally solves it by means of a foreign kind, as is the case e.g. (1) with the problem in the fifth Book of the Conics of Apollonius relating to the parabola, and (2) when Archimedes assumes in his work on the spiral a $\nu\epsilon\upsilon\sigma\iota\varsigma$ of a "solid" character with reference to a circle; for it is possible without calling in the aid of anything solid to find the proof of the theorem given by Archimedes, that is, to prove that the circumference of the circle arrived at in the first revolution is equal to the straight line drawn at right angles to the initial line to meet the tangent to the spiral (i.e. the subtangent).'

There is, however, this excuse for Archimedes, that he only assumes that the problem *can* be solved and does not assume the actual solution. Pappus¹ himself gives a solution of the particular $\nu\epsilon\upsilon\sigma\iota\varsigma$ by means of conics. Apollonius wrote two Books of $\nu\epsilon\upsilon\sigma\epsilon\iota\varsigma$, and it is quite possible that by Archimedes's time there may already have been a collection of such problems to which tacit reference was permissible.

Prop. 10 repeats the result of the Lemma to Prop. 2 of *On*

¹ Pappus, iv, pp. 298–302.

Conoids and Spheroids involving the summation of the series $1^2 + 2^2 + 3^2 + \dots + n^2$. Prop 11 proves another proposition in summation, namely that

$$\begin{aligned} (n-1)(na)^2 &: \{a^2 + (2a)^2 + (3a)^2 + \dots + (\overline{n-1})a^2\} \\ &> (na)^2 : \{na \cdot a + \frac{1}{3}(na-a)^2\} \\ &> (n-1)(na)^2 : \{(2a)^2 + (3a)^2 + \dots + (na)^2\}. \end{aligned}$$

The same proposition is also true if the terms of the series are $a^2, (a+b)^2, (a+2b)^2 \dots (a+\overline{n-1}b)^2$, and it is assumed in the more general form in Props. 25, 26.

Archimedes now introduces his Definitions, of the *spiral* itself, the *origin*, the *initial line*, the *first distance* (= the radius vector at the end of one revolution), the *second distance* (= the equal length added to the radius vector during the second complete revolution), and so on; the *first area* (the area bounded by the spiral described in the first revolution and the 'first distance'), the *second area* (that bounded by the spiral described in the second revolution and the 'second distance'), and so on; the *first circle* (the circle with the 'first distance' as radius), the *second circle* (the circle with radius equal to the sum of the 'first' and 'second distances', or twice the first distance), and so on.

Props. 12, 14, 15 give the fundamental property of the spiral connecting the length of the radius vector with the angle through which the initial line has revolved from its original position, and corresponding to the equation in polar coordinates $r = a\theta$. As Archimedes does not speak of angles greater than π , or 2π , he has, in the case of points on any turn after the first, to use multiples of the circumference of a circle as well as arcs of it. He uses the 'first circle' for this purpose. Thus, if P, Q are two points on the first turn,

$$OP : OQ = (\text{arc } AKP') : (\text{arc } AKQ');$$

if P, Q are points on the n th turn of the spiral, and c is the circumference of the first circle,

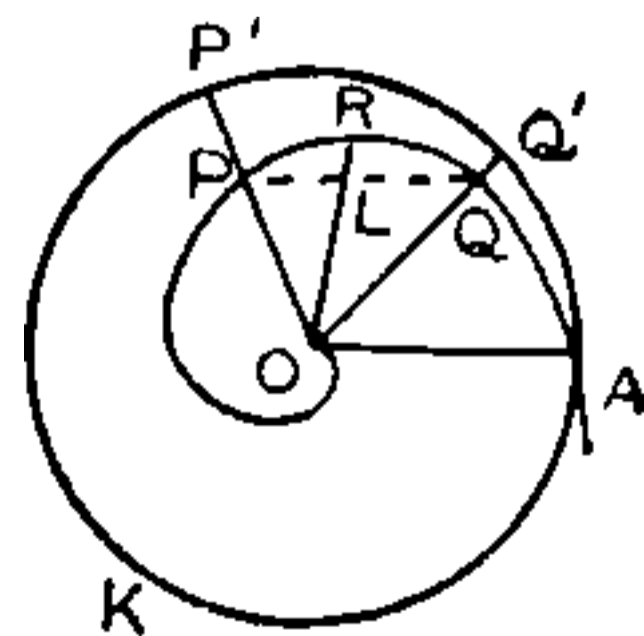

$$OP : OQ = \{(n-1)c + \text{arc } AKP'\} : \{(n-1)c + \text{arc } AKQ'\}.$$

Prop. 13 proves that, if a straight line touches the spiral, it



THIS PAGE IS LOCKED TO FREE MEMBERS

Purchase full membership to immediately unlock this page

DELVE INTO FANTASY, MAGIC, MYTHOLOGY & FOLKLORE

Forgotten Books'
Full Membership gives
access to 797,885 ancient
and modern, fiction and
non-fiction books.

Continue

*Fair usage policy applies

Let OF meet the spiral in Q' .

Then we have, *alternando*, since $PO = QO$,

$$FQ : QO = PQ : OU$$

$< (\text{arc } PQ) : (\text{arc } ASP)$, by hypothesis and *a fortiori*.

Componendo, $FO : QO < (\text{arc } ASQ) : (\text{arc } ASP)$

$$< OQ' : OP.$$

But $QO = OP$; therefore $FO < OQ'$; which is impossible.

Therefore OT is not greater than the arc ASP .

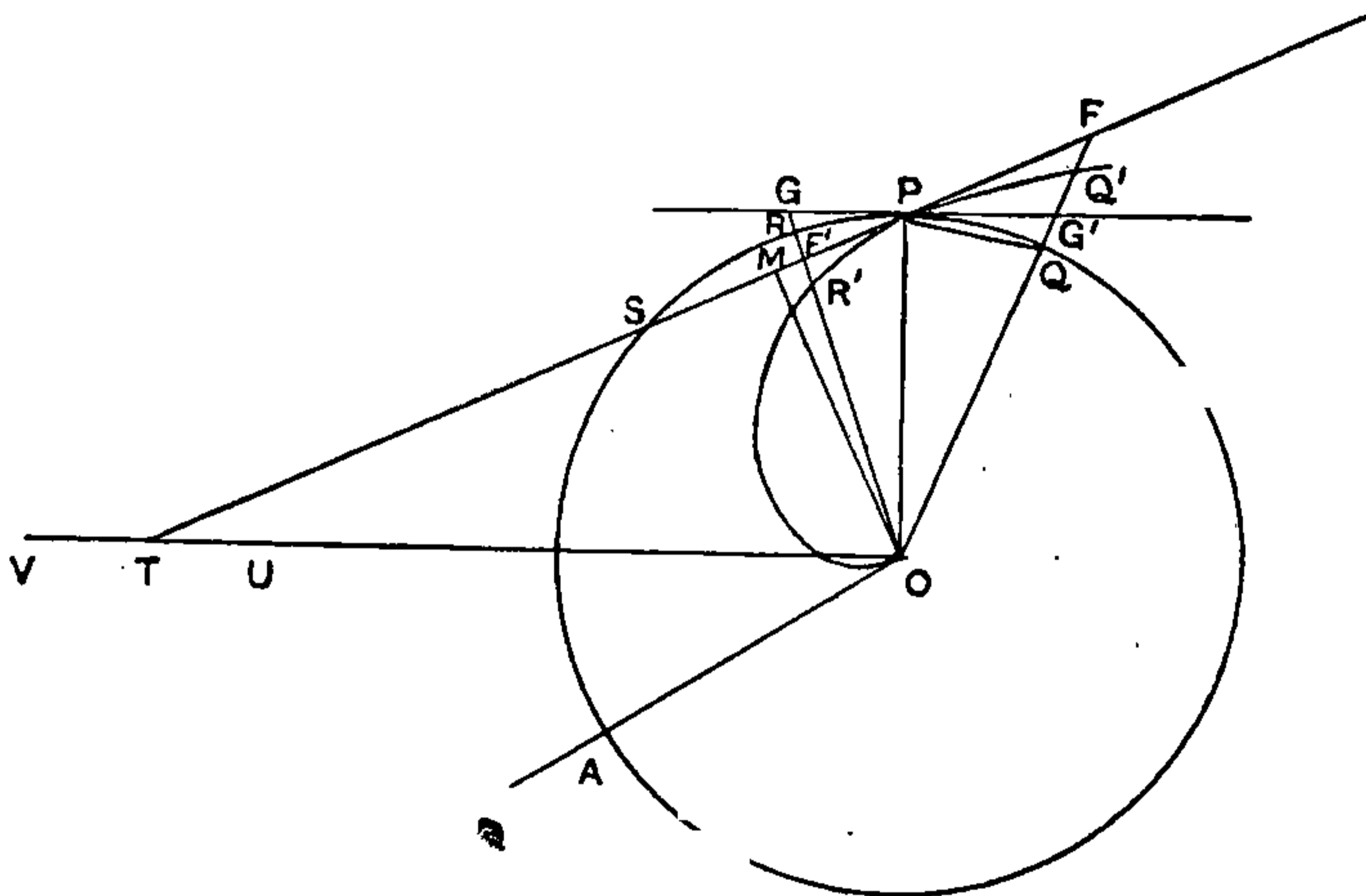

·II. Next suppose, if possible, that $OT < \text{arc } ASP$.

Measure OV along OT such that OV is greater than OT but less than the arc ASP .

Then the ratio $PO : OV$ is less than the ratio $PO : OT$, i.e. than the ratio of $\frac{1}{2}PS$ to the perpendicular from O on PS ; therefore it is possible (Prop. 8) to draw a straight line $OF'R'G$ meeting PS , the circle PSA , and the tangent to the circle at P in F' , R , G respectively, and such that

$$F'R : GP = PO : OV.$$

Let $OF'G$ meet the spiral in R' .

Then, since $PO = RO$, we have, *alternando*,

$$F'R : RO = GP : OV$$

$$> (\text{arc } PR) : (\text{arc } ASP), \text{ a fortiori,}$$

whence
$$F'O : RO < (\text{arc } ASR) : (\text{arc } ASP)$$

$$< OR' : OP,$$

so that $F'O < OR'$; which is impossible.

Therefore OT is not less than the arc ASP . And it was proved not greater than the same arc. Therefore

$$OT = (\text{arc } ASP).$$

As particular cases (separately proved by Archimedes), if P be the extremity of the first turn and c_1 the circumference of the first circle, the subtangent $= c_1$; if P be the extremity of the second turn and c_2 the circumference of the 'second circle', the subtangent $= 2c_2$; and generally, if c_n be the circumference of the n th circle (the circle with the radius vector to the extremity of the n th turn as radius), the subtangent to the tangent at the extremity of the n th turn $= nc_n$.

If P is a point on the n th turn, not the extremity, and the circle with O as centre and OP as radius cuts the initial line in K , while p is the circumference of the circle, the subtangent to the tangent at $P = (n-1)p + \text{arc } KP$ (measured 'forward').¹

The remainder of the book (Props. 21-8) is devoted to finding the areas of portions of the spiral and its several turns cut off by the initial line or any two radii vectores. We will illustrate by the general case (Prop. 26). Take OB, OC , two bounding radii vectores, including an arc BC of the spiral. With centre O and radius OC describe a circle. Divide the angle BOC into any number of equal parts by radii of this circle. The spiral meets these radii in points $P, Q \dots Y, Z$ such that the radii vectores $OB, OP, OQ \dots OZ, OC$

¹ On the whole course of Archimedes's proof of the property of the subtangent, see note in the Appendix.

are in arithmetical progression. Draw arcs of circles with radii $OB, OP, OQ \dots$ as shown; this produces a figure circumscribed to the spiral and consisting of the sum of small sectors of circles, and an inscribed figure of the same kind. As the first sector in the circumscribed figure is equal to the second sector in the inscribed, it is easily seen that the areas of the circumscribed and inscribed figures differ by the difference between the sectors OzC and OBp' ; therefore, by increasing the number of divisions of the angle BOC , we can make the

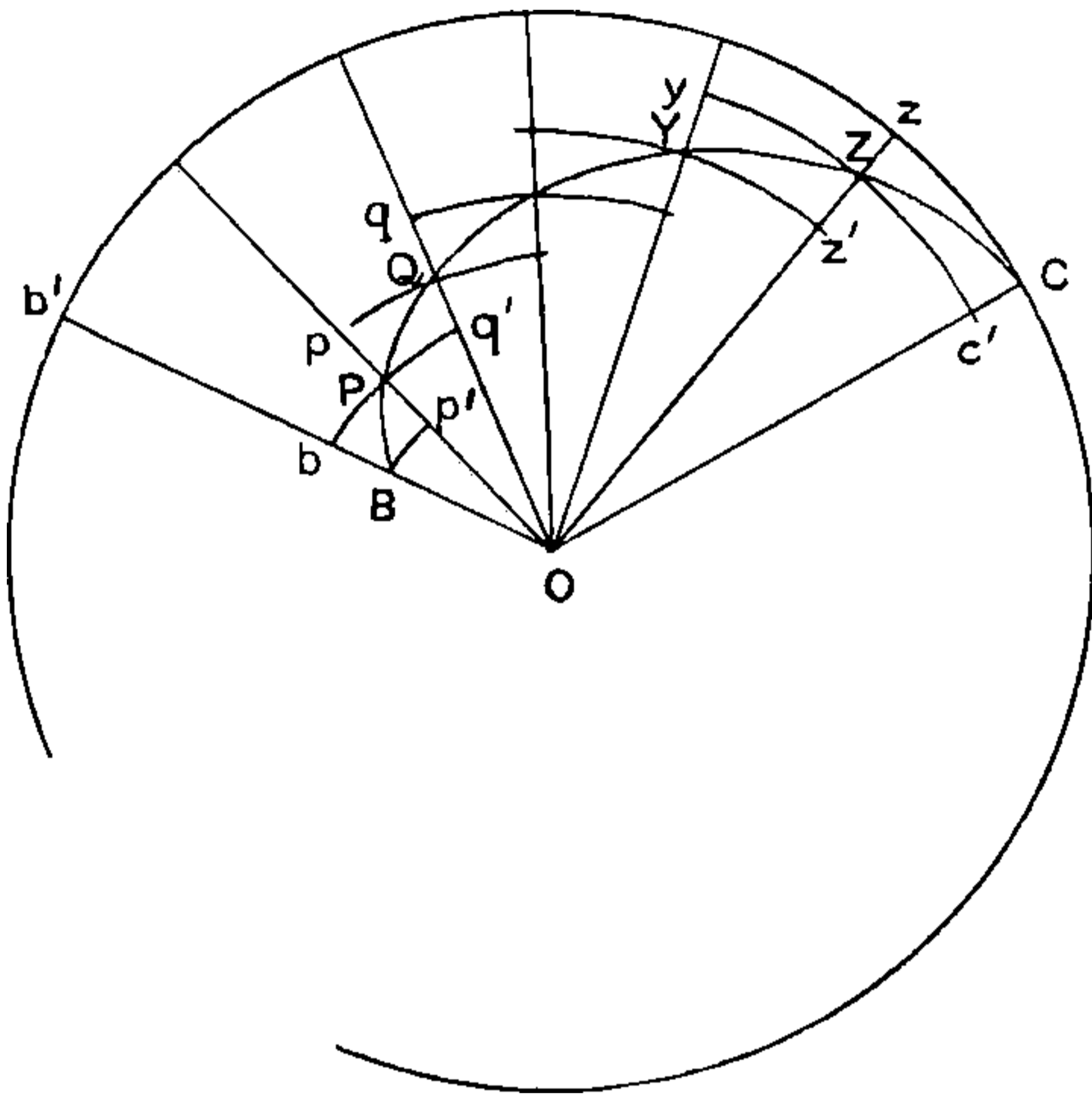

difference between the areas of the circumscribed and inscribed figures as small as we please; we have, therefore, the elements necessary for the application of the method of exhaustion.

If there are n radii $OB, OP \dots OC$, there are $(n-1)$ parts of the angle BQC . Since the angles of all the small sectors are equal, the sectors are as the square on their radii.

Thus (whole sector $Ob'C'$) : (circumscribed figure)

$$= (n-1)OC^2 : (OP^2 + OQ^2 + \dots + OC^2),$$

and (whole sector $Ob'C'$) : (inscribed figure)

$$= (n-1)OC^2 : (OB^2 + OP^2 + OQ^2 + \dots + OZ^2).$$

And $OB, OP, OQ, \dots OZ, OC$ is an arithmetical progression of n terms; therefore (cf. Prop. 11 and Cor.),

$$\begin{aligned} (n-1)OC^2 &: (OP^2 + OQ^2 + \dots + OC^2) \\ &< OC^2 : \{OC \cdot OB + \frac{1}{3}(OC - OB)^2\} \\ &< (n-1)OC^2 : (OB^2 + OP^2 + \dots + OZ^2). \end{aligned}$$

Compressing the circumscribed and inscribed figures together in the usual way, Archimedes proves by exhaustion that

$$\begin{aligned} (\text{sector } Ob'C) &: (\text{area of spiral } OBC) \\ &= OC^2 : \{OC \cdot OB + \frac{1}{3}(OC - OB)^2\}. \end{aligned}$$

If $OB = b$, $OC = c$, and $(c - b) = (n - 1)h$, Archimedes's result is the equivalent of saying that, when h diminishes and n increases indefinitely, while $c - b$ remains constant,

$$\begin{aligned} \text{limit of } h \{b^2 + (b + h)^2 + (b + 2h)^2 + \dots + (b + \overline{n-2}h)^2\} \\ &= (c - b) \{cb + \frac{1}{3}(c - b)^2\} \\ &= \frac{1}{3}(c^3 - b^3); \end{aligned}$$

that is, with our notation,

$$\int_b^c x^2 dx = \frac{1}{3}(c^3 - b^3).$$

In particular, the area included by the first turn and the initial line is bounded by the radii vectores 0 and $2\pi a$; the area, therefore, is to the circle with radius $2\pi a$ as $\frac{1}{3}(2\pi a)^2$ to $(2\pi a)^2$, that is to say, it is $\frac{1}{3}$ of the circle or $\frac{1}{3}\pi(2\pi a)^2$. This is separately proved in Prop. 24 by means of Prop. 10 and Corr. 1, 2.

The area of the ring added while the radius vector describes the second turn is the area bounded by the radii vectores $2\pi a$ and $4\pi a$, and is to the circle with radius $4\pi a$ in the ratio of $\{r_2 r_1 + \frac{1}{3}(r_2 - r_1)^2\}$ to r_2^2 , where $r_1 = 2\pi a$ and $r_2 = 4\pi a$; the ratio is 7 : 12 (Prop. 25).

If R_1 be the area of the first turn of the spiral bounded by the initial line, R_2 the area of the ring added by the second complete turn, R_3 that of the ring added by the third turn, and so on, then (Prop. 27)

$$R_3 = 2R_2, \quad R_4 = 3R_2, \quad R_5 = 4R_2, \quad \dots \quad R_n = (n-1)R_2.$$

Also $R_6 = 6R_1$.

Lastly, if E be the portion of the sector $b'OC$ bounded by $b'B$, the arc $b'zC$ of the circle and the arc BC of the spiral, and F the portion cut off between the arc BC of the spiral, the radius OC and the arc intercepted between OB and OC of the circle with centre O and radius OB , it is proved that

$$E : F = \{OB + \frac{2}{3}(OC - OB)\} : \{OB + \frac{1}{3}(OC - OB)\} \quad (\text{Prop. 28}).$$

On Plane Equilibriums, I, II.

In this treatise we have the fundamental principles of mechanics established by the methods of geometry in its strictest sense. There were doubtless earlier treatises on mechanics, but it may be assumed that none of them had been worked out with such geometrical rigour. Archimedes begins with seven Postulates including the following principles. Equal weights at equal distances balance; if unequal weights operate at equal distances, the larger weighs down the smaller. If when equal weights are in equilibrium something be added to, or subtracted from, one of them, equilibrium is not maintained but the weight which is increased or is not diminished prevails. When equal and similar plane figures coincide if applied to one another, their centres of gravity similarly coincide; and in figures which are unequal but similar the centres of gravity will be 'similarly situated'. In any figure the contour of which is concave in one and the same direction the centre of gravity must be within the figure. Simple propositions (1–5) follow, deduced by *reductio ad absurdum*; these lead to the fundamental theorem, proved first for commensurable and then by *reductio ad absurdum* for incommensurable magnitudes, that *Two magnitudes, whether commensurable or incommensurable, balance at distances reciprocally proportional to the magnitudes* (Props. 6, 7). Prop. 8 shows how to find the centre of gravity of a part of a magnitude when the centres of gravity of the other part and of the whole magnitude are given. Archimedes then addresses himself to the main problems of Book I, namely to find the centres of gravity of (1) a parallelogram (Props. 9, 10), (2) a triangle (Props. 13, 14), and (3) a parallel-trapezium (Prop. 15), and here we have an illustration of the extraordinary rigour which he requires in his geometrical

proofs. We do not find him here assuming, as in *The Method*, that, if all the lines that can be drawn in a figure parallel to (and including) one side have their middle points in a straight line, the centre of gravity must lie somewhere on that straight line; he is not content to regard the figure as *made up* of an infinity of such parallel lines; pure geometry realizes that the parallelogram is made up of elementary parallelograms, indefinitely narrow if you please, but still parallelograms, and the triangle of elementary *trapezia*, not straight lines, so that to assume directly that the centre of gravity lies on the straight line bisecting the parallelograms would really be a *petitio principii*. Accordingly the result, no doubt discovered in the informal way, is clinched by a proof by *reductio ad absurdum* in each case. In the case of the parallelogram $ABCD$ (Prop. 9), if the centre of gravity is not on the straight line EF bisecting two opposite sides, let it be at H . Draw HK parallel to AD . Then it is possible by bisecting AE , ED , then bisecting the halves, and so on, ultimately to reach a length less than KH . Let this be done, and through the

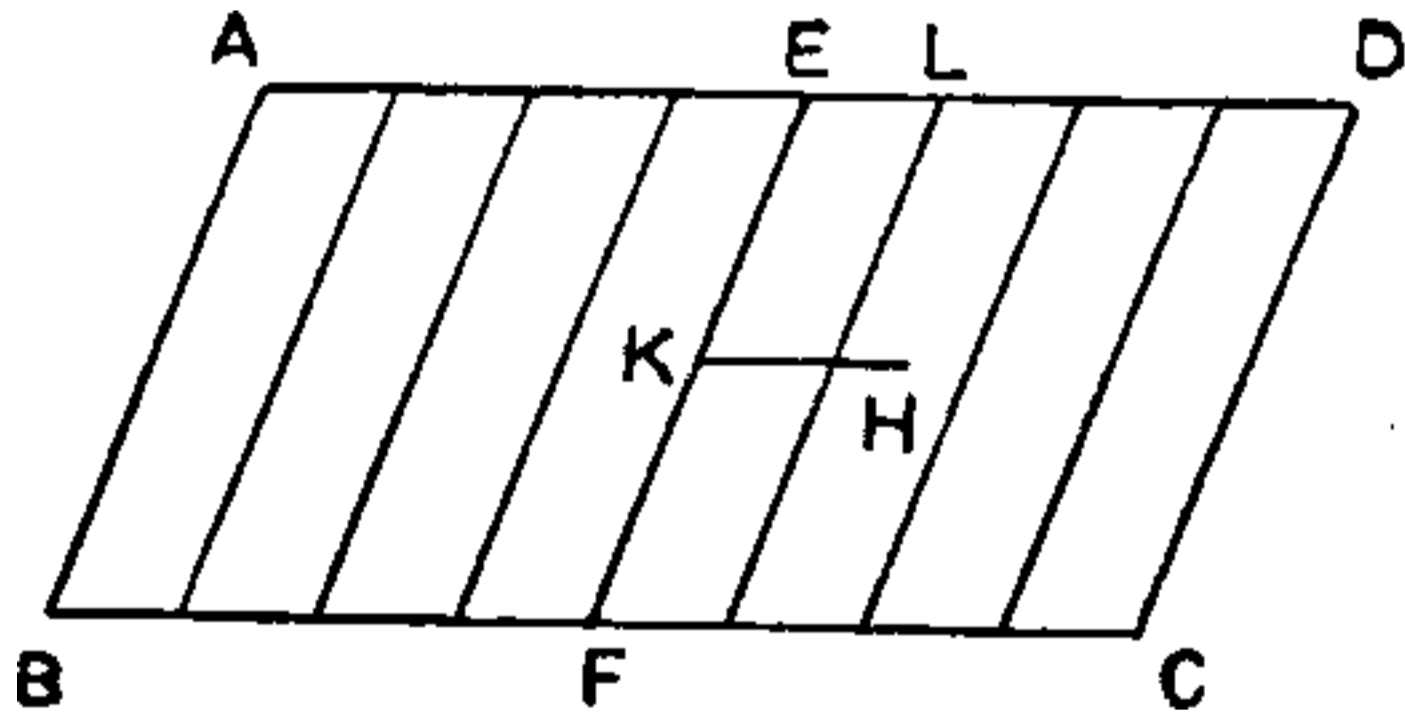

points of division of AD draw parallels to AB or DC making a number of equal and similar parallelograms as in the figure. The centre of gravity of each of these parallelograms is similarly situated with regard to it. Hence we have a number of equal magnitudes with their centres of gravity at equal distances along a straight line. Therefore the centre of gravity of the whole is on the line joining the centres of gravity of the two middle parallelograms (Prop. 5, Cor. 2). But this is impossible, because H is outside those parallelograms. Therefore the centre of gravity cannot but lie on EF .

Similarly the centre of gravity lies on the straight line bisecting the other opposite sides AB , CD ; therefore it lies at the intersection of this line with EF , i.e. at the point of intersection of the diagonals.

The proof in the case of the triangle is similar (Prop. 13). Let AD be the median through A . The centre of gravity must lie on AD .

For, if not, let it be at H , and draw HI parallel to BC . Then, if we bisect DC , then bisect the halves, and so on, we shall arrive at a length DE less than IH . Divide BC into lengths equal to DE , draw parallels to DA through the points of division, and complete the small parallelograms as shown in the figure.

The centres of gravity of the whole parallelograms SN , TP , FQ lie on AD (Prop. 9); therefore the centre of gravity of the

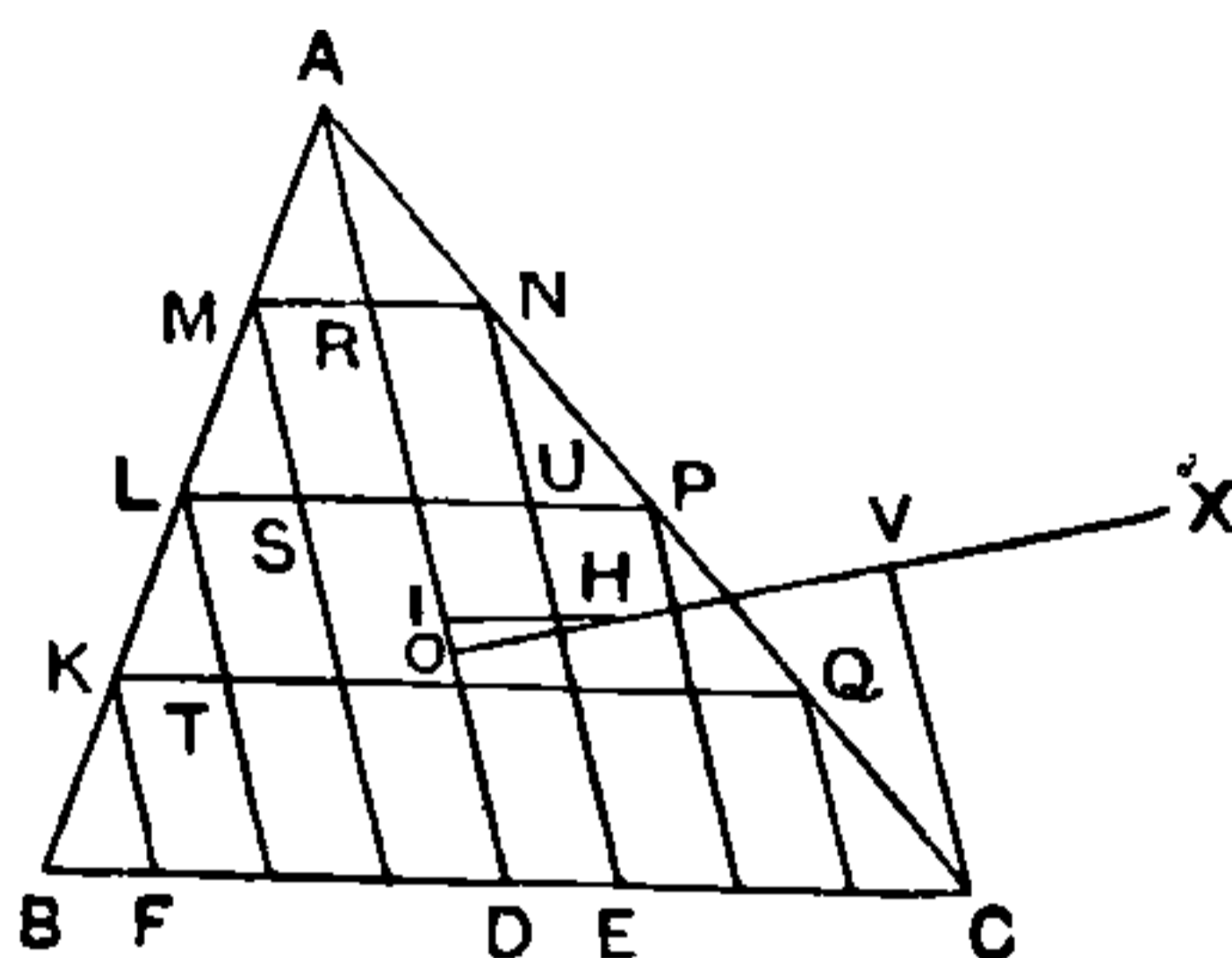

figure formed by them all lies on AD ; let it be O . Join OH , and produce it to meet in V the parallel through C to AD .

Now it is easy to see that, if n be the number of parts into which DC , AC are divided respectively,

$$\begin{aligned} (\text{sum of small } \Delta\text{s } AMR, MLS \dots ARN, NUP \dots) : (\Delta ABC) \\ &= n \cdot AN^2 : AC^2 \\ &= 1 : n ; \end{aligned}$$

whence

$$(\text{sum of small } \Delta\text{s}) : (\text{sum of parallelograms}) = 1 : (n - 1).$$

Therefore the centre of gravity of the figure made up of all the small triangles is at a point X on OH produced such that

$$XH = (n - 1)OH.$$

But $VH : HO < CE : ED$ or $(n - 1) : 1$; therefore $XH > VH$.

It follows that the centre of gravity of all the small triangles taken together lies at X notwithstanding that all the triangles lie on one side of the parallel to AD drawn through X : which is impossible.



THIS PAGE IS LOCKED TO FREE MEMBERS

Purchase full membership to immediately unlock this page

FORGOTTEN BOOKS

FULL

MEMBERSHIP

797,885 Books!

All you can read

for only

\$8.99/month

Continue

*Fair usage policy applies



This is merely preliminary. Then begins the real argument, the course of which is characteristic and deserves to be set out. Archimedes uses a series of figures inscribed to the segment, as he says, 'in the recognized manner' (*γνωρίμως*). The rule is as follows. Inscribe in the segment the triangle ABB' with the same base and height; the vertex A is then the point of contact of the tangent parallel to BB' . Do the same with the remaining segments cut off by AB , AB' , then with the segments remaining, and so on. If $BRQPAP'Q'R'B'$ is such a figure, the diameters through Q , Q' , P , P' , R , R' bisect the straight lines AB , AB' , AQ , AQ' , QB , $Q'B'$ respectively, and BB' is divided by the diameters into parts which are all equal. It is easy to prove also that PP' , QQ' , RR' are all parallel to BB' , and that $AL:LM:MN:NO = 1:3:5:7$, the same relation holding if the number of sides of the polygon is increased; i.e. the segments of AO are always in the ratio of the successive odd numbers (Lemmas to Prop. 2). The centre of gravity of the inscribed figure lies on AO (Prop. 2). If there be two parabolic segments, and two figures inscribed in them 'in the recognized manner' with an equal number of sides, the centres of gravity divide the respective axes in the same proportion, for the ratio depends on the same ratio of odd numbers $1:3:5:7 \dots$ (Prop. 3). The centre of gravity of the parabolic segment itself lies on the diameter AO (this is proved in Prop. 4 by *reductio ad absurdum* in exactly the same way as for the triangle in I. 13). It is next proved (Prop. 5) that the centre of gravity of the segment is nearer to the vertex A than the centre of gravity of the inscribed figure is; but that it is possible to inscribe in the segment in the recognized manner a figure such that the distance between the centres of gravity of the segment and of the inscribed figure is less than any assigned length, for we have only to increase the number of sides sufficiently (Prop. 6). Incidentally, it is observed in Prop. 4 that, if in any segment the triangle with the same base and equal height is inscribed, the triangle is greater than half the segment, whence it follows that, each time we increase the number of sides in the inscribed figure, we take away more than half of the segments remaining over; and in Prop. 5 that corresponding segments on opposite sides of the axis, e.g. QRB , $Q'R'B'$ have their axes equal and therefore are equal in

area. Lastly (Prop. 7), if there be two parabolic segments, their centres of gravity divide their diameters in the same ratio (Archimedes enunciates this of similar segments only, but it is true of any two segments and is required of any two segments in Prop. 8). Prop. 8 now finds the centre of gravity of any segment by using the last proposition. It is the geometrical equivalent of the solution of a simple equation in the ratio (m , say) of AG to AO , where G is the centre of gravity of the segment.

Since the segment $= \frac{4}{3} (\Delta ABB')$, the sum of the two segments $AQB, AQ'B' = \frac{1}{3} (\Delta ABB')$.

Further, if $QD, Q'D'$ are the diameters of these segments, $QD, Q'D'$ are equal, and, since the centres of gravity H, H' of the segments divide $QD, Q'D'$ proportionally, HH' is parallel to QQ' , and the centre of gravity of the two segments together is at K , the point where HH' meets AO .

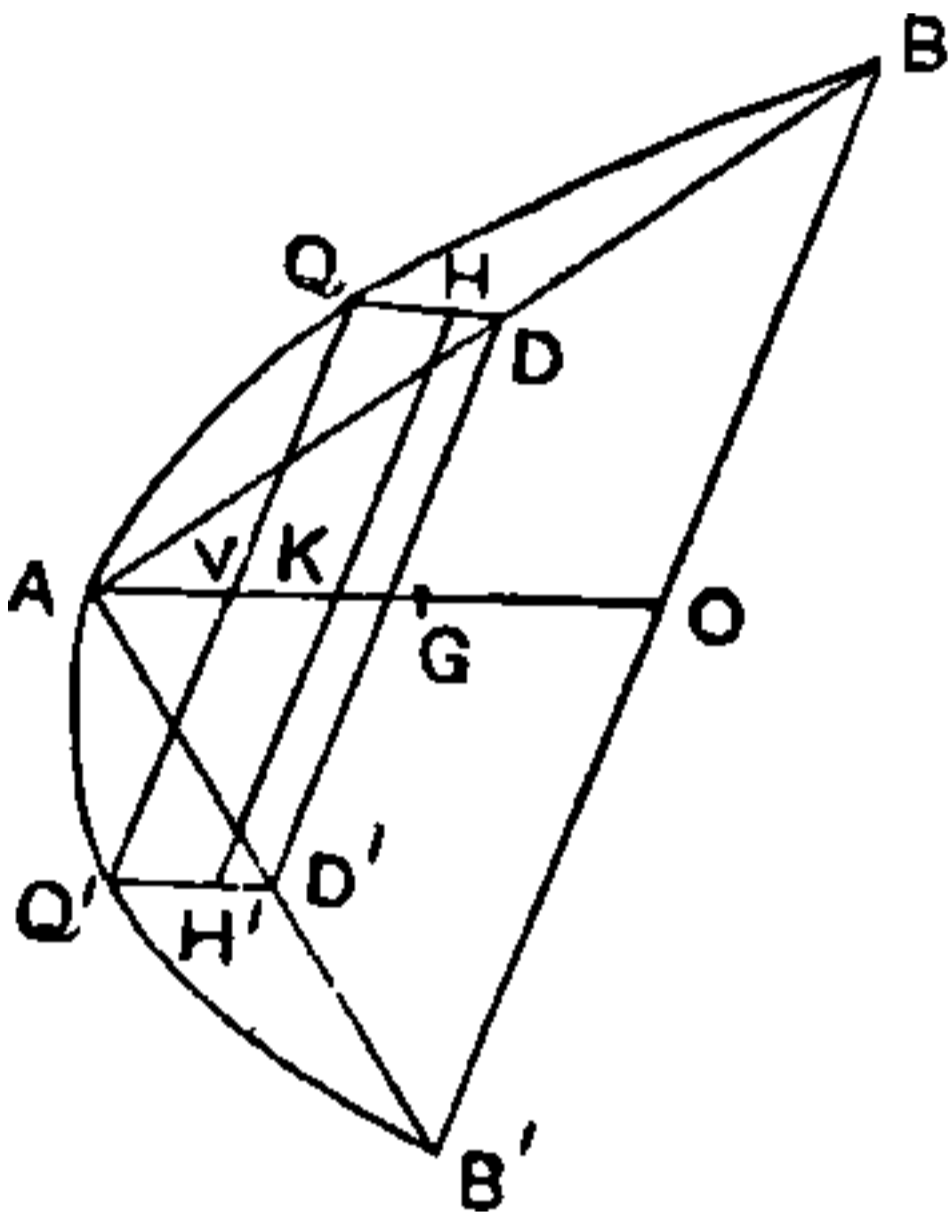

Now $AO = 4AV$ (Lemma 3 to Prop. 2), and $QD = \frac{1}{2}AO - AV = AV$. But H divides QD in the same ratio as G divides AO (Prop. 7); therefore

$$VK = QH = m \cdot QD = m \cdot AV.$$

Taking moments about A of the segment, the triangle ABB' and the sum of the small segments, we have (dividing out by AV and $\Delta ABB'$)

$$\frac{1}{3}(1 + m) + \frac{2}{3} \cdot 4 = \frac{4}{3} \cdot 4m,$$

or

$$15m = 9,$$

and $m = \frac{3}{5}$.

That is, $AG = \frac{3}{5}AO$, or $AG:GO = 3:2$.

The final proposition (10) finds the centre of gravity of the portion of a parabola cut off between two parallel chords PP', BB' . If PP' is the shorter of the chords and the diameter bisecting PP', BB' meets them in N, O respectively, Archimedes proves that, if NO be divided into five equal parts of which LM is the middle one (L being nearer to N than M is),

the centre of gravity G of the portion of the parabola between PP' and BB' divides LM in such a way that

$$LG : GM = BO^2 \cdot (2PN + BO) : PN^2 \cdot (2BO + PN).$$

The geometrical proof is somewhat difficult, and uses a very remarkable Lemma which forms Prop. 9. If a, b, c, d, x, y are straight lines satisfying the conditions

$$\left. \begin{aligned} \frac{a}{b} = \frac{b}{c} = \frac{c}{d} \quad (a > b > c > d), \\ \frac{d}{a-d} = \frac{x}{\frac{3}{5}(a-c)}, \\ \text{and} \quad \frac{2a + 4b + 6c + 3d}{5a + 10b + 10c + 5d} = \frac{y}{a-c}, \end{aligned} \right\}$$

then must

$$x + y = \frac{2}{5}a.$$

The proof is entirely geometrical, but amounts of course to the elimination of three quantities b, c, d from the above four equations.

The Sand-reckoner (*Psammites* or *Arenarius*).

I have already described in a previous chapter the remarkable system, explained in this treatise and in a lost work, *Ἀρχαί, Principles*, addressed to Zeuxippus, for expressing very large numbers which were beyond the range of the ordinary Greek arithmetical notation. Archimedes showed that his system would enable any number to be expressed up to that which in our notation would require 80,000 million million ciphers and then proceeded to prove that this system more than sufficed to express the number of grains of sand which it would take to fill the universe, on a reasonable view (as it seemed to him) of the size to be attributed to the universe. Interesting as the book is for the course of the argument by which Archimedes establishes this, it is, in addition, a document of the first importance historically. It is here that we learn that Aristarchus put forward the Copernican theory of the universe, with the sun in the centre and the planets including the earth revolving round it, and that Aristarchus further discovered the angular diameter of the sun to be $\frac{1}{720}$ th of the circle of the zodiac or half a degree. Since Archimedes, in order to calculate a safe figure (not too small) for the size

of the universe, has to make certain assumptions as to the sizes and distances of the sun and moon and their relation to the size of the universe, he takes the opportunity of quoting earlier views. Some have tried, he says, to prove that the perimeter of the earth is about 300,000 stades; in order to be quite safe he will take it to be about ten times this, or 3,000,000 stades, and not greater. The diameter of the earth, like most earlier astronomers, he takes to be greater than that of the moon but less than that of the sun. Eudoxus, he says, declared the diameter of the sun to be nine times that of the moon, Phidias, his own father, twelve times, while Aristarchus tried to prove that it is greater than 18 but less than 20 times the diameter of the moon; he will again be on the safe side and take it to be 30 times, but not more. The position is rather more difficult as regards the ratio of the distance of the sun to the size of the universe. Here he seizes upon a dictum of Aristarchus that the sphere of the fixed stars is so great that the circle in which he supposes the earth to revolve (round the sun) 'bears such a proportion to the distance of the fixed stars as the centre of the sphere bears to its surface'. If this is taken in a strictly mathematical sense, it means that the sphere of the fixed stars is infinite in size, which would not suit Archimedes's purpose; to get another meaning out of it he presses the point that Aristarchus's words cannot be taken quite literally because the centre, being without magnitude, cannot be in any ratio to any other magnitude; hence he suggests that a reasonable interpretation of the statement would be to suppose that, if we conceive a sphere with radius equal to the distance between the centre of the sun and the centre of the earth, then

$$(\text{diam. of earth}) : (\text{diam. of said sphere})$$

$$= (\text{diam. of said sphere}) : (\text{diam. of sphere of fixed stars}).$$

This is, of course, an arbitrary interpretation; Aristarchus presumably meant no such thing, but merely that the size of the earth is negligible in comparison with that of the sphere of the fixed stars. However, the solution of Archimedes's problem demands some assumption of the kind, and, in making this assumption, he was no doubt aware that he was taking a liberty with Aristarchus for the sake of giving his hypo-

Archimedes has, lastly, to compare the diameter of the sun with the circumference of the circle described by its centre. Aristarchus had made the apparent diameter of the sun $\frac{1}{720}$ th of the said circumference; Archimedes will prove that the said circumference cannot contain as many as 1,000 sun's diameters, or that the diameter of the sun is greater than the side of a regular chiliagon inscribed in the circle. First he made an experiment of his own to determine the apparent diameter of the sun. With a small cylinder or disc in a plane at right angles to a long straight stick and moveable along it, he observed the sun at the moment when it cleared the horizon in rising, moving the disc till it just covered and just failed to cover the sun as he looked along the straight stick. He thus found the angular diameter to lie between $\frac{1}{164}R$ and $\frac{1}{200}R$, where R is a right angle. But as, under his assumptions, the size of the earth is not negligible in comparison with the sun's circle, he had to allow for parallax and find limits for the angle subtended by the sun at the centre of the earth. This he does by a geometrical argument very much in the manner of Aristarchus.

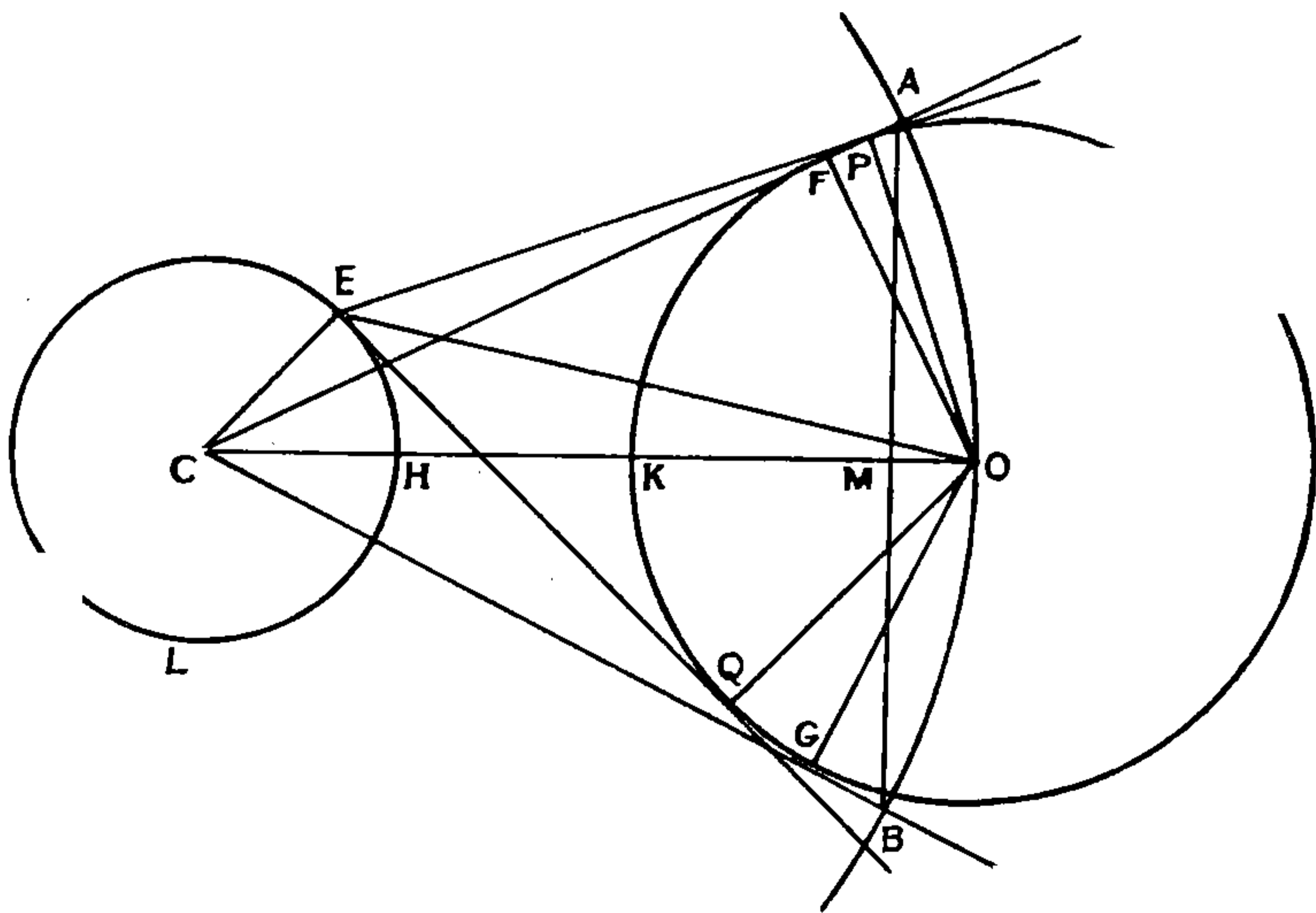

Let the circles with centres O , C represent sections of the sun and earth respectively, E the position of the observer observing

the sun when it has just cleared the horizon. Draw from E two tangents EP , EQ to the circle with centre O , and from C let CF , CG be drawn touching the same circle. With centre C and radius CO describe a circle: this will represent the path of the centre of the sun round the earth. Let this circle meet the tangents from C in A , B , and join AB meeting CO in M .

Archimedes's observation has shown that

$$\frac{1}{164}R > \angle PEQ > \frac{1}{200}R;$$

and he proceeds to prove that AB is less than the side of a regular polygon of 656 sides inscribed in the circle AOB , but greater than the side of an inscribed regular polygon of 1,000 sides, in other words, that

$$\frac{1}{164}R > \angle FCG > \frac{1}{250}R.$$

The first relation is obvious, for, since $CO > EO$,

$$\angle PEQ > \angle FCG.$$

Next, the perimeter of any polygon inscribed in the circle AOB is less than $\frac{44}{7}CO$ (i.e. $\frac{2^2}{7}$ times the diameter);

Therefore $AB < \frac{1}{656} \cdot \frac{44}{7}CO$ or $\frac{1}{1148}CO$,

and, *a fortiori*, $AB < \frac{1}{100}CO$.

Now, the triangles CAM , COF being equal in all respects, $AM = OF$, so that $AB = 2OF = (\text{diameter of sun}) > CH + OK$, since the diameter of the sun is greater than that of the earth; therefore $CH + OK < \frac{1}{100}CO$, and $HK > \frac{99}{100}CO$.

And $CO > CF$, while $HK < EQ$, so that $EQ > \frac{99}{100}CF$.

We can now compare the angles OCF , OEQ ;

$$\begin{aligned} \text{for } \frac{\angle OCF}{\angle OEQ} & \left[\begin{array}{l} > \frac{\tan OCF}{\tan OEQ} \\ > \frac{EQ}{CF} \\ > \frac{99}{100}, \text{ a fortiori.} \end{array} \right. \end{aligned}$$

Doubling the angles, we have

$$\begin{aligned} \angle FCG & > \frac{99}{100} \cdot \angle PEQ \\ & > \frac{99}{20000}R, \text{ since } \angle PEQ > \frac{1}{200}R, \\ & > \frac{1}{200}R. \end{aligned}$$

Hence AB is greater than the side of a regular polygon of 812 sides, and *a fortiori* greater than the side of a regular polygon of 1,000 sides, inscribed in the circle AOB .

The perimeter of the chiliagon, as of any regular polygon with more sides than six, inscribed in the circle AOB is greater than 3 times the diameter of the sun's orbit, but is less than 1,000 times the diameter of the sun, and *a fortiori* less than 30,000 times the diameter of the earth;

therefore (diameter of sun's orbit) $< 10,000$ (diam. of earth)
 $< 10,000,000,000$ stades.

But (diam. of earth) : (diam. of sun's orbit)
 $=$ (diam. of sun's orbit) : (diam. of universe);

therefore the universe, or the sphere of the fixed stars, is less than $10,000^3$ times the sphere in which the sun's orbit is a great circle.

Archimedes takes a quantity of sand not greater than a poppy-seed and assumes that it contains not more than 10,000 grains; the diameter of a poppy-seed he takes to be not less than $\frac{1}{40}$ th of a finger-breadth; thus a sphere of diameter 1 finger-breadth is not greater than 64,000 poppy-seeds and therefore contains not more than 640,000,000 grains of sand ('6 units of *second order* + 40,000,000 units of *first order*') and *a fortiori* not more than 1,000,000,000 ('10 units of *second order* of numbers'). Gradually increasing the diameter of the sphere by multiplying it each time by 100 (making the sphere 1,000,000 times larger each time) and substituting for 10,000 finger-breadths a stadium ($< 10,000$ finger-breadths), he finds the number of grains of sand in a sphere of diameter 10,000,000,000 stadia to be less than '1,000 units of *seventh order* of numbers' or 10^{51} , and the number in a sphere $10,000^3$ times this size to be less than '10,000,000 units of the *eighth order* of numbers' or 10^{63} .

The Quadrature of the Parabola.

In the preface, addressed to Dositheus after the death of Conon, Archimedes claims originality for the solution of the problem of finding the area of a segment of a parabola cut off by any chord, which he says he first discovered by means of mechanics and then confirmed by means of geometry, using the lemma that, if there are two unequal areas (or magnitudes



THIS PAGE IS LOCKED TO FREE MEMBERS

Purchase full membership to immediately unlock this page

DELVE INTO FANTASY, MAGIC, MYTHOLOGY & FOLKLORE

Forgotten Books'
Full Membership gives
access to 797,885 ancient
and modern, fiction and
non-fiction books.

Continue

*Fair usage policy applies

curve in R_1, R_2, \dots . Join QR_1 , and produce it to meet OE in F , QR_2 meeting O_1E_1 in F_1 , and so on.

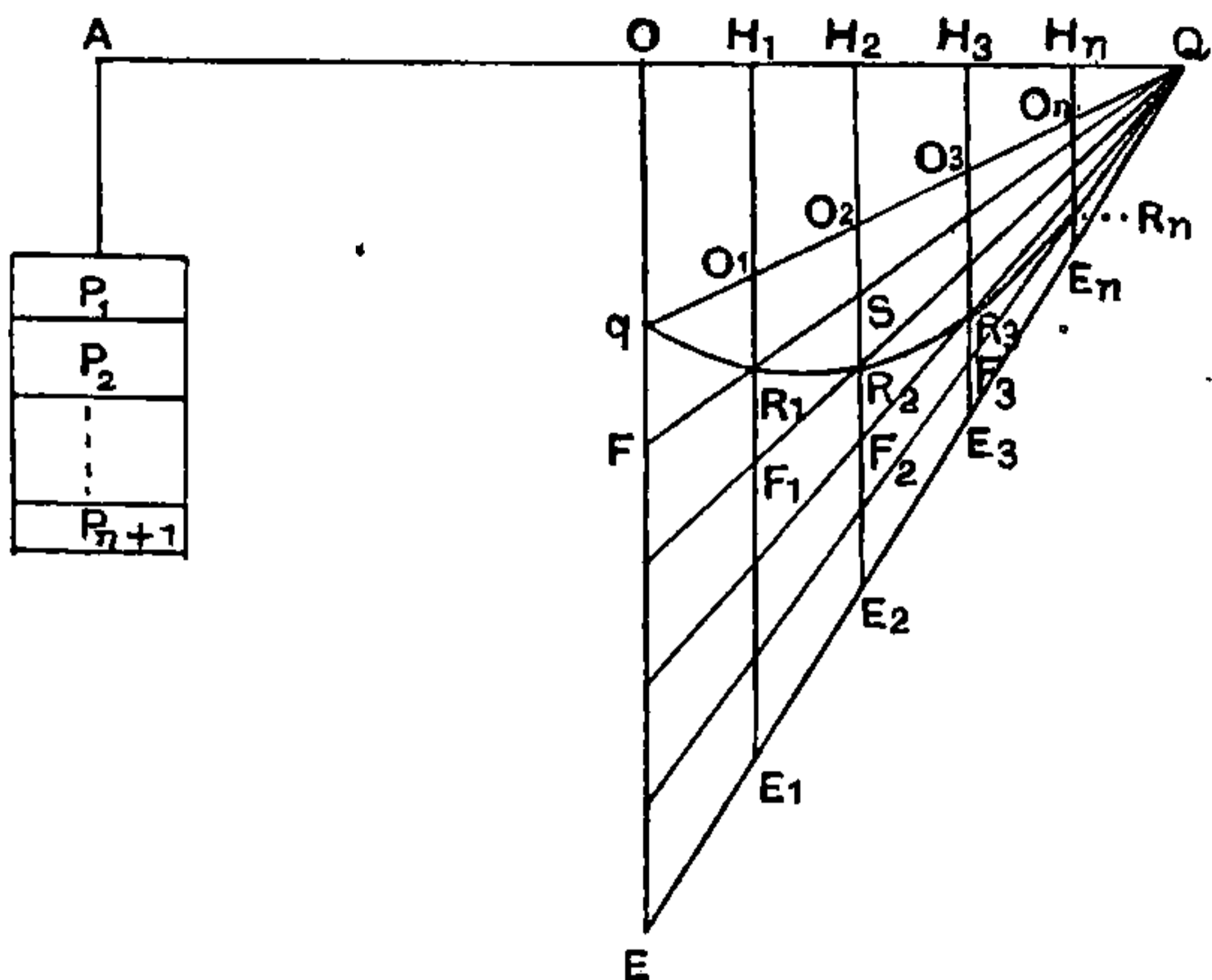

Now Archimedes has proved in a series of propositions (6-13) that, if a trapezium such as $O_1E_1E_2O_2$ is suspended from H_1H_2 , and an area P suspended at A balances $O_1E_1E_2O_2$ so suspended, it will take a greater area than P suspended at A to balance the same trapezium suspended from H_2 and a less area than P to balance the same trapezium suspended from H_1 . A similar proposition holds with regard to a triangle such as E_nH_nQ suspended where it is and suspended at Q and H_n respectively.

Suppose (Props. 14, 15) the triangle QqE suspended where it is from OQ , and suppose that the trapezium EO_1 , suspended where it is, is balanced by an area P_1 suspended at A , the trapezium E_1O_2 , suspended where it is, is balanced by P_2 suspended at A , and so on, and finally the triangle E_nO_nQ , suspended where it is, is balanced by P_{n+1} suspended at A ; then $P_1 + P_2 + \dots + P_{n+1}$ at A balances the whole triangle, so that

$$P_1 + P_2 + \dots + P_{n+1} = \frac{1}{3} \Delta Eqq,$$

since the whole triangle may be regarded as suspended from the point on OQ vertically above its centre of gravity.

$$\begin{aligned} \text{Now } AO : OH_1 &= QO : OH_1 \\ &= Qq : qO_1 \\ &= E_1O_1 : O_1R_1, \text{ by Prop. 5,} \\ &= (\text{trapezium } EO_1) : (\text{trapezium } FO_1), \end{aligned}$$

that is, it takes the trapezium FO_1 suspended at A to balance the trapezium EO_1 suspended at H_1 . And P_1 balances EO_1 where it is.

Therefore $(FO_1) > P_1$.

Similarly $(F_1O_2) > P_2$, and so on.

Again $AO : OH_1 = E_1O_1 : O_1R_1$
 $= (\text{trapezium } E_1O_2) : (\text{trapezium } R_1O_2),$

that is, (R_1O_2) at A will balance (E_1O_2) suspended at H_1 , while P_2 at A balances (E_1O_2) suspended where it is,

whence $P_2 > R_1O_2$.

Therefore $(F_1O_2) > P_2 > (R_1O_2),$

$(F_2O_3) > P_3 > R_2O_3$, and so on;

and finally, $\Delta E_nO_nQ > P_{n+1} > \Delta R_nO_nQ$.

By addition,

$(R_1O_2) + (R_2O_3) + \dots + (\Delta R_nO_nQ) < P_2 + P_3 + \dots + P_{n+1};$

therefore, *a fortiori*,

$$(R_1O_2) + (R_2O_3) + \dots + \Delta R_nO_nQ < P_1 + P_2 + \dots + P_{n+1}$$

$$< (FO_1) + (F_1O_2) + \dots + \Delta E_nO_nQ.$$

That is to say, we have an inscribed figure consisting of trapezia and a triangle which is less, and a circumscribed figure composed in the same way which is greater, than

$$P_1 + P_2 + \dots + P_{n+1}, \text{ i.e. } \frac{1}{3} \Delta EqQ.$$

It is therefore inferred, and proved by the method of exhaustion, that the segment itself is *equal* to $\frac{1}{3} \Delta EqQ$ (Prop. 16).

In order to enable the method to be applied, it has only to be proved that, by increasing the number of parts in Qq sufficiently, the difference between the circumscribed and inscribed figures can be made as small as we please. This can be seen thus. We have first to show that all the parts, as qF , into which qE is divided are equal.

We have $E_1O_1 : O_1R_1 = QO : OH_1 = (n+1) : 1,$

or $O_1R_1 = \frac{1}{n+1} \cdot E_1O_1$, whence also $O_2S = \frac{1}{n+1} \cdot O_2E_2$.

And $E_2O_2 : O_2R_2 = QO : OH_2 = (n + 1) : 2$,

or
$$O_2R_2 = \frac{2}{n + 1} \cdot O_2E_2.$$

It follows that $O_2S = SR_2$, and so on.

Consequently $O_1R_1, O_2R_2, O_3R_3 \dots$ are divided into 1, 2, 3 ... equal parts respectively by the lines from Q meeting qE .

It follows that the difference between the circumscribed and inscribed figures is equal to the triangle FqQ , which can be made as small as we please by increasing the number of divisions in Qq , i.e. in qE .

Since the area of the segment is equal to $\frac{1}{3} \Delta EqQ$, and it is easily proved (Prop. 17) that $\Delta EqQ = 4$ (triangle with same base and equal height with segment), it follows that the area of the segment = $\frac{4}{3}$ times the latter triangle.

It is easy to see that this solution is essentially the same as that given in *The Method* (see pp. 29–30, above), only in a more orthodox form (geometrically speaking). For there Archimedes took the sum of all the *straight lines*, as $O_1R_1, O_2R_2 \dots$, as making up the segment notwithstanding that there are an infinite number of them and straight lines have no breadth. Here he takes inscribed and circumscribed trapezia proportional to the straight lines and having finite breadth, and then compresses the figures together into the segment itself by increasing indefinitely the number of trapezia in each figure, i.e. diminishing their breadth indefinitely.

The procedure is equivalent to an integration, thus:

If X denote the area of the triangle FqQ , we have, if n be the number of parts in Qq ,

(circumscribed figure)

$$\begin{aligned} &= \text{sum of } \Delta\text{s } QqF, QR_1F_1, QR_2F_2, \dots \\ &= \text{sum of } \Delta\text{s } QqF, QO_1R_1, QO_2S, \dots \\ &= X \left\{ 1 + \frac{(n-1)^2}{n^2} + \frac{(n-2)^2}{n^2} + \dots + \frac{1}{n^2} \right\} \\ &= \frac{1}{n^2 X^2} \cdot X (X^2 + 2^2 X^2 + 3^2 X^2 + \dots + n^2 X^2). \end{aligned}$$

Similarly, we find that

(inscribed figure) = $\frac{1}{n^2 X^2} \cdot X \{ X^2 + 2^2 X^2 + \dots + (n-1)^2 X^2 \}.$



THIS PAGE IS LOCKED TO FREE MEMBERS

Purchase full membership to immediately unlock this page

FORGOTTEN BOOKS

FULL

MEMBERSHIP

797,885 Books!

All you can read

for only

\$8.99/month

Continue

*Fair usage policy applies



the triangle PQq is half of the parallelogram and therefore more than half the segment. And so on (Prop. 20).

We now have to sum n terms of the above geometrical series. Archimedes enunciates the problem in the form, Given a series of areas $A, B, C, D \dots Z$, of which A is the greatest, and each is equal to four times the next in order, then (Prop. 23)

$$A + B + C + \dots + Z + \frac{1}{3}Z = \frac{4}{3}A.$$

The algebraical equivalent of this is of course

$$1 + \frac{1}{4} + \left(\frac{1}{4}\right)^2 + \dots + \left(\frac{1}{4}\right)^{n-1} = \frac{4}{3} - \frac{1}{3} \left(\frac{1}{4}\right)^{n-1} = \frac{1 - \left(\frac{1}{4}\right)^n}{1 - \frac{1}{4}}.$$

To find the area of the segment, Archimedes, instead of taking the limit, as we should, uses the method of *reductio ad absurdum*.

Suppose $K = \frac{4}{3} \cdot \Delta PQq$.

(1) If possible, let the area of the segment be greater than K .

We then inscribe a figure 'in the recognized manner' such that the segment exceeds it by an area less than the excess of the segment over K . Therefore the inscribed figure must be greater than K , which is impossible since

$$A + B + C + \dots + Z < \frac{4}{3}A,$$

where $A = \Delta PQq$ (Prop. 23).

(2) If possible, let the area of the segment be less than K .

If then $\Delta PQq = A$, $B = \frac{1}{4}A$, $C = \frac{1}{4}B$, and so on, until we arrive at an area X less than the excess of K over the area of the segment, we have

$$A + B + C + \dots + X + \frac{1}{3}X = \frac{4}{3}A = K.$$

Thus K exceeds $A + B + C + \dots + X$ by an area less than X , and exceeds the segment by an area greater than X .

It follows that $A + B + C + \dots + X > (\text{the segment})$; which is impossible (Prop. 22).

Therefore the area of the segment, being neither greater nor less than K , is equal to K or $\frac{4}{3}\Delta PQq$.

On Floating Bodies, I, II.

In Book I of this treatise Archimedes lays down the fundamental principles of the science of hydrostatics. These are

deduced from Postulates which are only two in number. The first which begins Book I is this:

‘let it be assumed that a fluid is of such a nature that, of the parts of it which lie evenly and are continuous, that which is pressed the less is driven along by that which is pressed the more; and each of its parts is pressed by the fluid which is perpendicularly above it except when the fluid is shut up in anything and pressed by something else’;

the second, placed after Prop. 7, says

‘let it be assumed that, of bodies which are borne upwards in a fluid, each is borne upwards along the perpendicular drawn through its centre of gravity’.

Prop. 1 is a preliminary proposition about a sphere, and then Archimedes plunges *in medias res* with the theorem (Prop. 2) that ‘*the surface of any fluid at rest is a sphere the centre of which is the same as that of the earth*’, and in the whole of Book I the surface of the fluid is always shown in the diagrams as spherical. The method of proof is similar to what we should expect in a modern elementary textbook, the main propositions established being the following. A solid which, size for size, is of equal weight with a fluid will, if let down into the fluid, sink till it is just covered but not lower (Prop. 3); a solid lighter than a fluid will, if let down into it, be only partly immersed, in fact just so far that the weight of the solid is equal to the weight of the fluid displaced (Props. 4, 5), and, if it is forcibly immersed, it will be driven upwards by a force equal to the difference between its weight and the weight of the fluid displaced (Prop. 6).

The important proposition follows (Prop. 7) that a solid heavier than a fluid will, if placed in it, sink to the bottom of the fluid, and the solid will, when weighed in the fluid, be lighter than its true weight by the weight of the fluid displaced.

The problem of the Crown.

This proposition gives a method of solving the famous problem the discovery of which in his bath sent Archimedes home naked crying *εὕρηκα, εὕρηκα*, namely the problem of

determining the proportions of gold and silver in a certain crown.

Let W be the weight of the crown, w_1 and w_2 the weights of the gold and silver in it respectively, so that $W = w_1 + w_2$.

(1) Take a weight W of pure gold and weigh it in the fluid. The apparent loss of weight is then equal to the weight of the fluid displaced; this is ascertained by weighing. Let it be F_1 .

It follows that the weight of the fluid displaced by a weight w_1 of gold is $\frac{w_1}{W} \cdot F_1$.

(2) Take a weight W of silver, and perform the same operation. Let the weight of the fluid displaced be F_2 . Then the weight of the fluid displaced by a weight w_2 of silver is $\frac{w_2}{W} \cdot F_2$.

(3) Lastly weigh the crown itself in the fluid, and let F be loss of weight or the weight of the fluid displaced.

We have then
$$\frac{w_1}{W} \cdot F_1 + \frac{w_2}{W} \cdot F_2 = F,$$

that is,
$$w_1 F_1 + w_2 F_2 = (w_1 + w_2) F,$$

whence
$$\frac{w_1}{w_2} = \frac{F_2 - F}{F - F_1}.$$

According to the author of the poem *de ponderibus et mensuris* (written probably about A.D. 500) Archimedes actually used a method of this kind. We first take, says our authority, two equal weights of gold and silver respectively and weigh them against each other when both are immersed in water; this gives the relation between their weights in water, and therefore between their losses of weight in water. Next we take the mixture of gold and silver and an equal weight of silver, and weigh them against each other in water in the same way.

Nevertheless I do not think it probable that this was the way in which the solution of the problem was *discovered*. As we are told that Archimedes discovered it in his bath, and that he noticed that, if the bath was full when he entered it, so much water overflowed as was displaced by his body, he is more likely to have discovered the solution by the alternative



THIS PAGE IS LOCKED TO FREE MEMBERS

Purchase full membership to immediately unlock this page

DELVE INTO FANTASY, MAGIC, MYTHOLOGY & FOLKLORE

Forgotten Books'
Full Membership gives
access to 797,885 ancient
and modern, fiction and
non-fiction books.

Continue

*Fair usage policy applies

principal parameter of the generating parabola, is a veritable *tour de force* which must be read in full to be appreciated. Prop. 1 is preliminary, to the effect that, if a solid lighter than a fluid be at rest in it, the weight of the solid will be to that of the same volume of the fluid as the immersed portion of the solid is to the whole. The results of the propositions about the segment of a paraboloid may be thus summarized. Let h be the axis or height of the segment, p the principal parameter of the generating parabola, s the ratio of the specific gravity of the solid to that of the fluid (s always < 1). The segment is supposed to be always placed so that its base is either entirely above, or entirely below, the surface of the fluid, and what Archimedes proves in each case is that, if the segment is so placed with its axis inclined to the vertical at any angle, it will not rest there but will return to the position of stability.

I. If h is not greater than $\frac{3}{4}p$, the position of stability is with the axis vertical, whether the curved surface is downwards or upwards (Props. 2, 3).

II. If h is greater than $\frac{3}{4}p$, then, in order that the position of stability may be with the axis vertical, s must be not less than $(h - \frac{3}{4}p)^2/h^2$ if the curved surface is downwards, and not greater than $\{h^2 - (h - \frac{3}{4}p)^2\}/h^2$ if the curved surface is upwards (Props. 4, 5).

III. If $h > \frac{3}{4}p$, but $h/\frac{1}{2}p < 15/4$, the segment, if placed with one point of the base touching the surface, will never remain there whether the curved surface be downwards or upwards (Props. 6, 7). (The segment will move in the direction of bringing the axis nearer to the vertical position.)

IV. If $h > \frac{3}{4}p$, but $h/\frac{1}{2}p < 15/4$, and if s is less than $(h - \frac{3}{4}p)^2/h^2$ in the case where the curved surface is downwards, but greater than $\{h^2 - (h - \frac{3}{4}p)^2\}/h^2$ in the case where the curved surface is upwards, then the position of stability is one in which the axis is not vertical but inclined to the surface of the fluid at a certain angle (Props. 8, 9). (The angle is drawn in an auxiliary figure. The construction for it in Prop. 8 is equivalent to the solution of the following equation in θ ,

$$\frac{1}{4}p \cot^2 \theta = \frac{2}{3}(h - k) - \frac{1}{2}p,$$

where k is the axis of the segment of the paraboloid cut off by the surface of the fluid.)

V. Prop. 10 investigates the positions of stability in the cases where $h/\frac{1}{2}p > 15/4$, the base is entirely above the surface, and s has values lying between five pairs of ratios respectively. Only in the case where s is not less than $(h - \frac{3}{4}p)^2/h^2$ is the position of stability that in which the axis is vertical.

BAB_1 is a section of the paraboloid through the axis AM . C is a point on AM such that $AC = 2CM$, K is a point on CA such that $AM:CK = 15:4$. CO is measured along CA such that $CO = \frac{1}{2}p$, and R is a point on AM such that $MR = \frac{3}{2}CO$. A_2 is the point in which the perpendicular to AM from K meets AB , and A_3 is the middle point of AB . BA_2B_2 , BA_3M are parabolic segments on A_2M_2 , A_3M_3 (parallel to AM) as axes

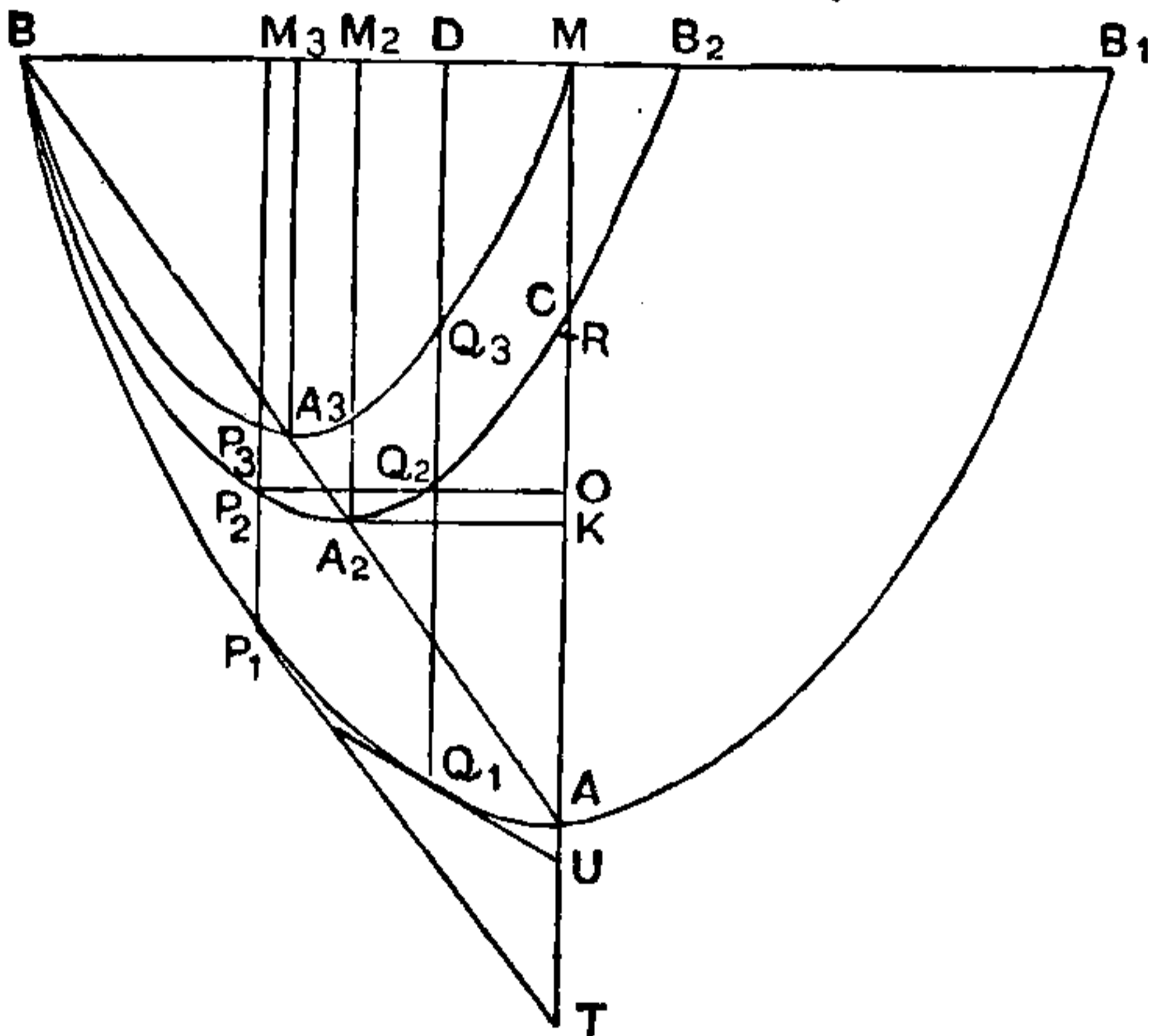

and similar to the original segment. (The parabola BA_2B_2 is proved to pass through C by using the above relation $AM:CK = 15:4$ and applying Prop. 4 of the *Quadrature of the Parabola*.) The perpendicular to AM from O meets the parabola BA_2B_2 in two points P_2 , Q_2 , and straight lines through these points parallel to AM meet the other parabolas in P_1 , Q_1 and P_3 , Q_3 respectively. P_1T and Q_1U are tangents to the original parabola meeting the axis MA produced in T , U . Then

(i) if s is not less than $AR^2:AM^2$ or $(h - \frac{3}{4}p)^2:h^2$, there is stable equilibrium when AM is vertical;

(ii) if $s < AR^2 : AM^2$ but $> Q_1 Q_3^2 : AM^2$, the solid will not rest with its base touching the surface of the fluid in one point only, but in a position with the base entirely out of the fluid and the axis making with the surface an angle greater than U ;

(iiia) if $s = Q_1 Q_3^2 : AM^2$, there is stable equilibrium with one point of the base touching the surface and AM inclined to it at an angle equal to U ;

(iiib) if $s = P_1 P_3^2 : AM^2$, there is stable equilibrium with one point of the base touching the surface and with AM inclined to it at an angle equal to T ;

(iv) if $s > P_1 P_3^2 : AM^2$ but $< Q_1 Q_3^2 : AM^2$, there will be stable equilibrium in a position in which the base is more submerged ;

(v) if $s < P_1 P_3^2 : AM^2$, there will be stable equilibrium with the base entirely out of the fluid and with the axis AM inclined to the surface at an angle less than T .

It remains to mention the traditions regarding other investigations by Archimedes which have reached us in Greek or through the Arabic.

(a) *The Cattle-Problem.*

This is a difficult problem in indeterminate analysis. It is required to find the number of bulls and cows of each of four colours, or to find 8 unknown quantities. The first part of the problem connects the unknowns by seven simple equations ; and the second part adds two more conditions to which the unknowns must be subject. If W, w be the numbers of white bulls and cows respectively and $(X, x), (Y, y), (Z, z)$ represent the numbers of the other three colours, we have first the following equations :

$$(I) \quad W = \left(\frac{1}{2} + \frac{1}{3}\right) X + Y, \quad (\alpha)$$

$$X = \left(\frac{1}{4} + \frac{1}{5}\right) Z + Y, \quad (\beta)$$

$$Z = \left(\frac{1}{6} + \frac{1}{7}\right) W + Y, \quad (\gamma)$$

$$(II) \quad w = \left(\frac{1}{3} + \frac{1}{4}\right) (X + x), \quad (\delta)$$

$$x = \left(\frac{1}{4} + \frac{1}{5}\right) (Z + z), \quad (\epsilon)$$

$$z = \left(\frac{1}{5} + \frac{1}{6}\right) (Y + y), \quad (\zeta)$$

$$y = \left(\frac{1}{6} + \frac{1}{7}\right) (W + w). \quad (\eta)$$



THIS PAGE IS LOCKED TO FREE MEMBERS

Purchase full membership to immediately unlock this page

FORGOTTEN BOOKS

FULL

MEMBERSHIP

797,885 Books!

All you can read

for only

\$8.99/month

Continue

*Fair usage policy applies



angular, but not similar, polygons; those discovered by Archimedes were 13 in number. If we for convenience designate a polyhedron contained by m regular polygons of α sides, n regular polygons of β sides, &c., by $(m_\alpha, n_\beta \dots)$, the thirteen Archimedean polyhedra, which we will denote by $P_1, P_2 \dots P_{13}$, are as follows:

Figure with 8 faces: $P_1 \equiv (4_3, 4_6)$.

Figures with 14 faces: $P_2 \equiv (8_3, 6_4), P_3 \equiv (6_4, 8_6),$

$P_4 \equiv (8_3, 6_8).$

Figures with 26 faces: $P_5 \equiv (8_3, 18_4), P_6 \equiv (12_4, 8_6, 6_8).$

Figures with 32 faces: $P_7 \equiv (20_3, 12_5), P_8 \equiv (12_5, 20_6),$

$P_9 \equiv (20_3, 12_{10}).$

Figure with 38 faces: $P_{10} \equiv (32_3, 6_4).$

Figures with 62 faces: $P_{11} \equiv (20_3, 30_4, 12_5),$

$P_{12} \equiv (30_4, 20_6, 12_{10}).$

Figure with 92 faces: $P_{13} \equiv (80_3, 12_5).$

Kepler¹ showed how these figures can be obtained. A method of obtaining some of them is indicated in a fragment of a scholium to the Vatican MS. of Pappus. If a solid angle of one of the regular solids be cut off symmetrically by a plane, i.e. in such a way that the plane cuts off the same length from each of the edges meeting at the angle, the section is a regular polygon which is a triangle, square or pentagon according as the solid angle is formed of three, four, or five plane angles. If certain equal portions be so cut off from all the solid angles respectively, they will leave regular polygons inscribed in the faces of the solid; this happens (A) when the cutting planes bisect the sides of the faces and so leave in each face a polygon of the same kind, and (B) when the cutting planes cut off a smaller portion from each angle in such a way that a regular polygon is left in each face which has double the number of sides (as when we make, say, an octagon out of a square by cutting off the necessary portions,

¹ Kepler, *Harmonice mundi* in *Opera* (1864), v, pp. 123-6.

symmetrically, from the corners). We have seen that, according to Heron, two of the semi-regular solids had already been discovered by Plato, and this would doubtless be his method. The methods (A) and (B) applied to the five regular solids give the following out of the 13 semi-regular solids. We obtain (1) from the tetrahedron, P_1 by cutting off angles so as to leave hexagons in the faces; (2) from the cube, P_2 by leaving squares, and P_4 by leaving octagons, in the faces; (3) from the octahedron, P_2 by leaving triangles, and P_3 by leaving hexagons, in the faces; (4) from the icosahedron, P_7 by leaving triangles, and P_8 by leaving hexagons, in the faces; (5) from the dodecahedron, P_7 by leaving pentagons, and P_9 by leaving decagons in the faces.

Of the remaining six, four are obtained by cutting off all the edges symmetrically and equally by planes parallel to the edges, and then cutting off angles. Take first the cube. (1) Cut off from each four parallel edges portions which leave an octagon as the section of the figure perpendicular to the edges; then cut off equilateral triangles from the corners (see Fig. 1); this gives P_5 containing 8 equilateral triangles and 18 squares. (P_5 is also obtained by bisecting all the edges of P_2 and cutting off corners.) (2) Cut off from the edges of the cube a smaller portion so as to leave in each face a square such that the octagon described in it has its side equal to the breadth of the section in which each edge is cut; then cut off hexagons from each angle (see Fig. 2); this

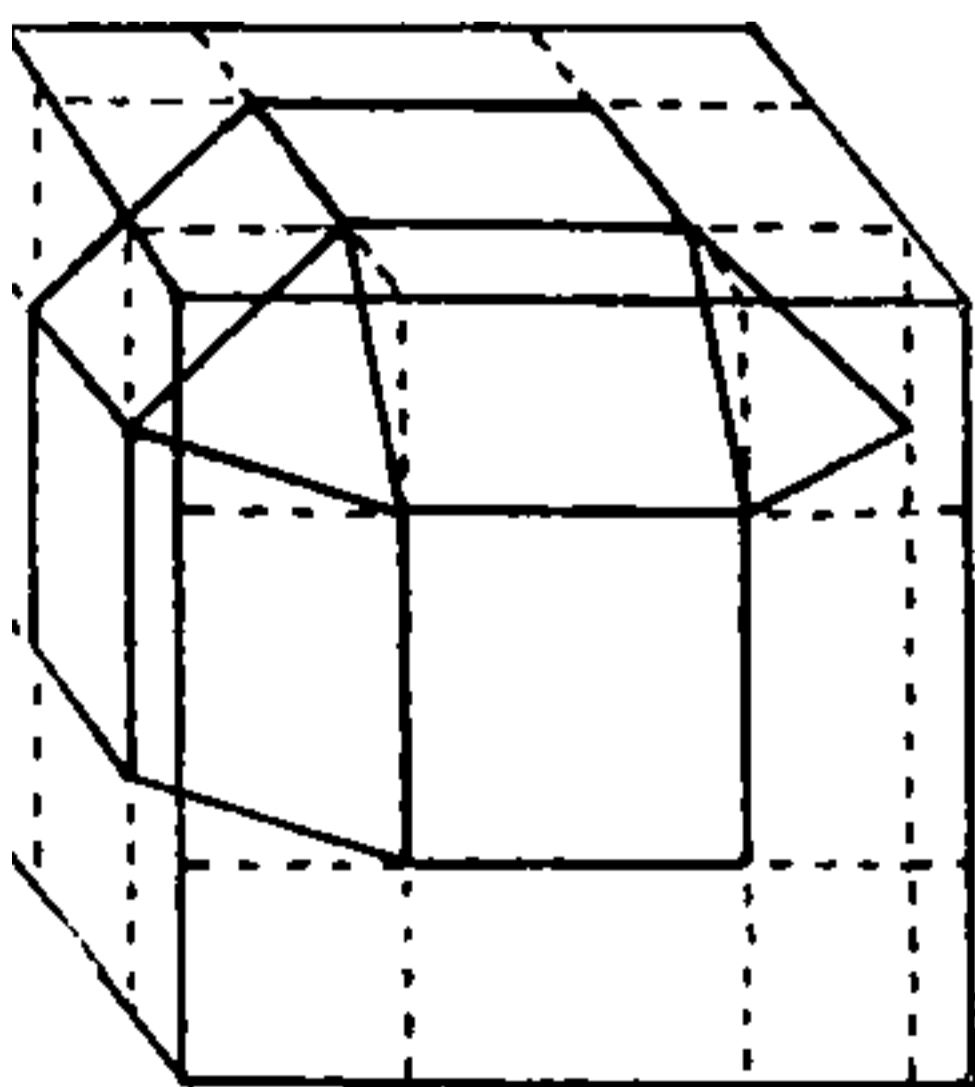

FIG. 1.

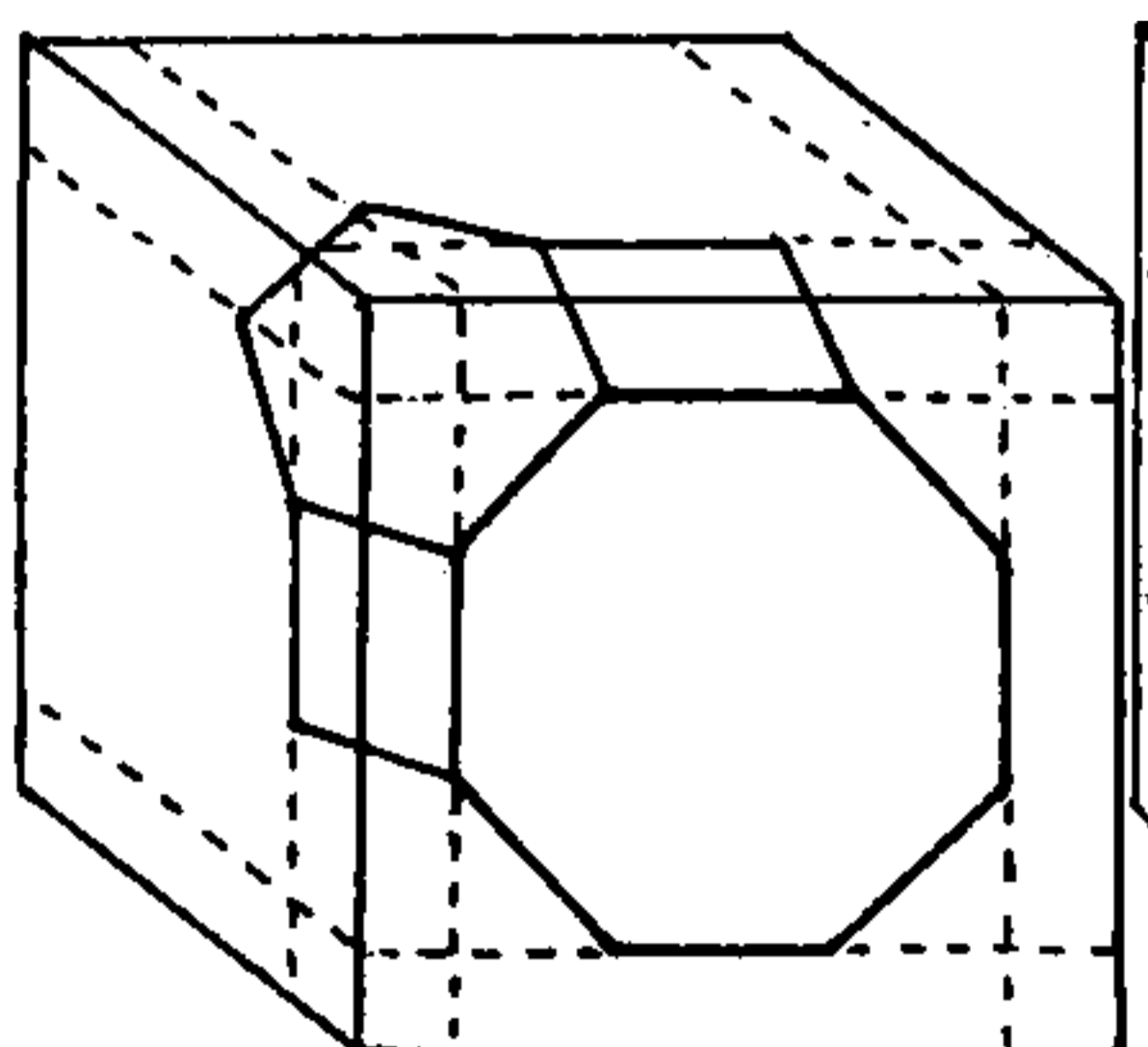

FIG. 2.

gives 6 octagons in the faces, 12 squares under the edges and 8 hexagons at the corners; that is, we have P_6 . An exactly

similar procedure with the icosahedron and dodecahedron produces P_{11} and P_{12} (see Figs. 3, 4 for the case of the icosahedron).

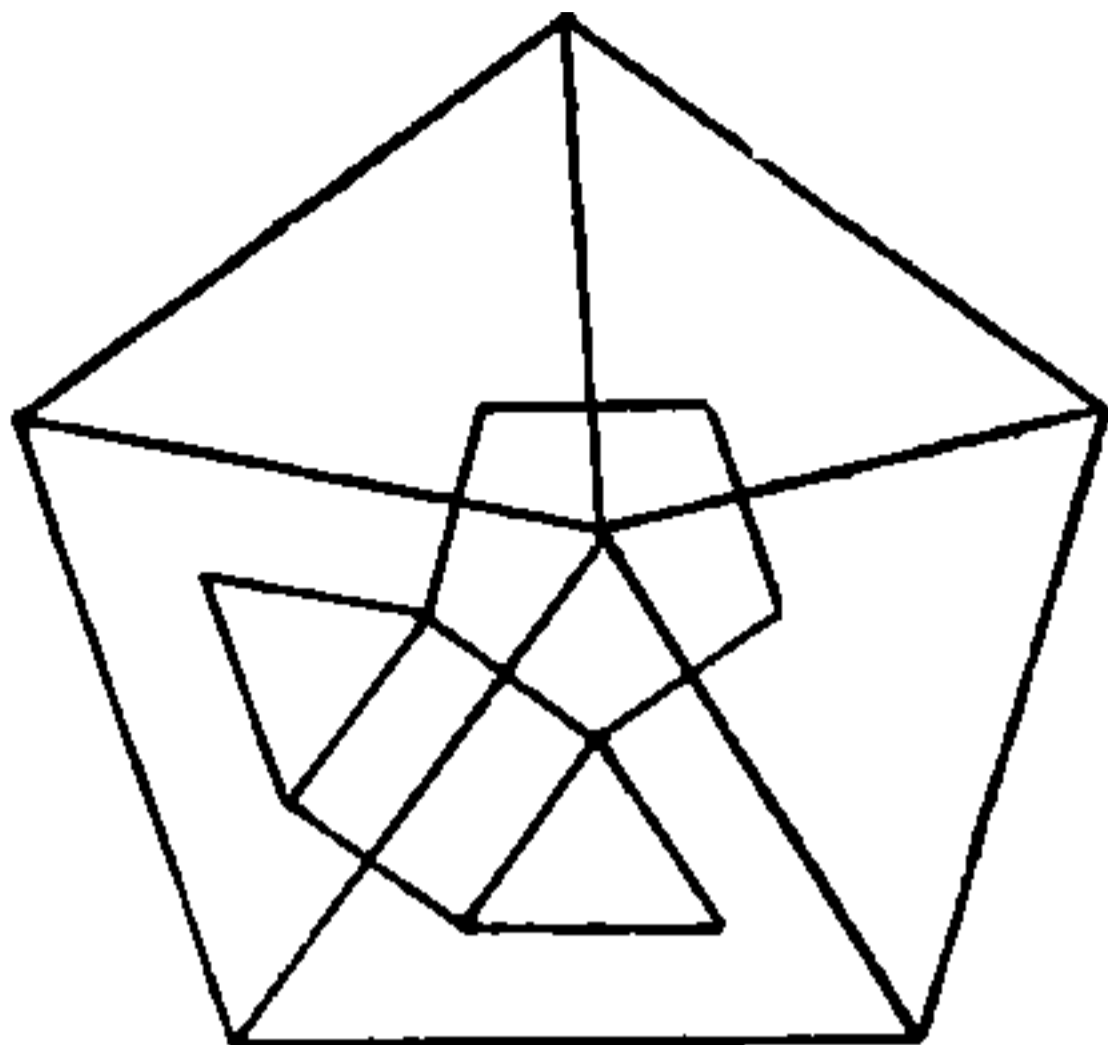

FIG. 3.

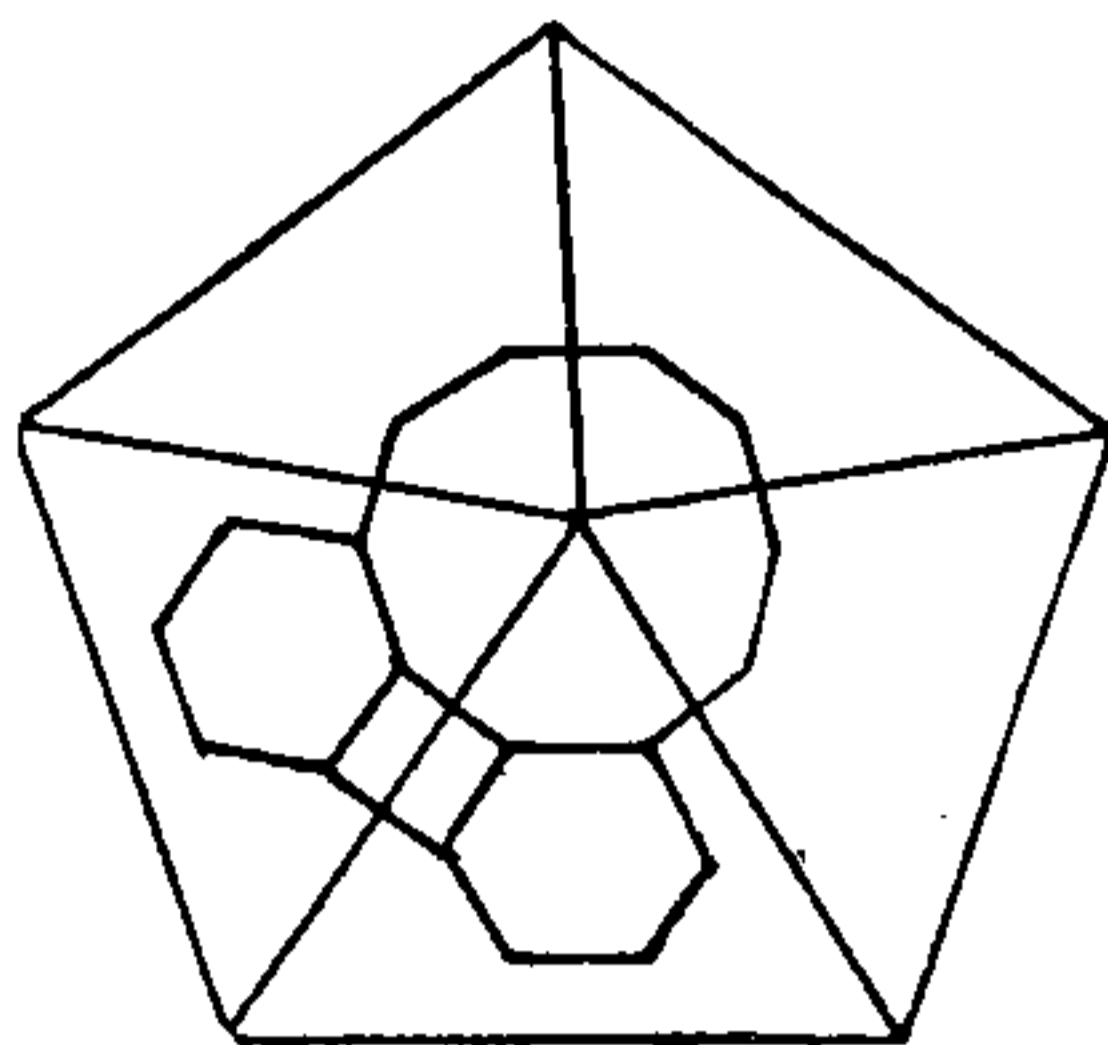

FIG. 4.

The two remaining solids P_{10} , P_{13} cannot be so simply produced. They are represented in Figs. 5, 6, which I have

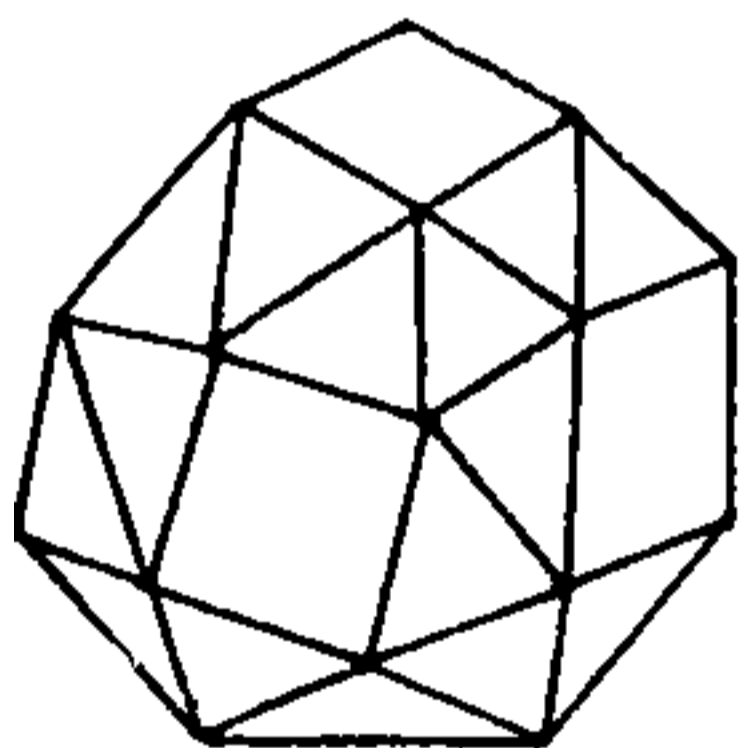

FIG. 5.

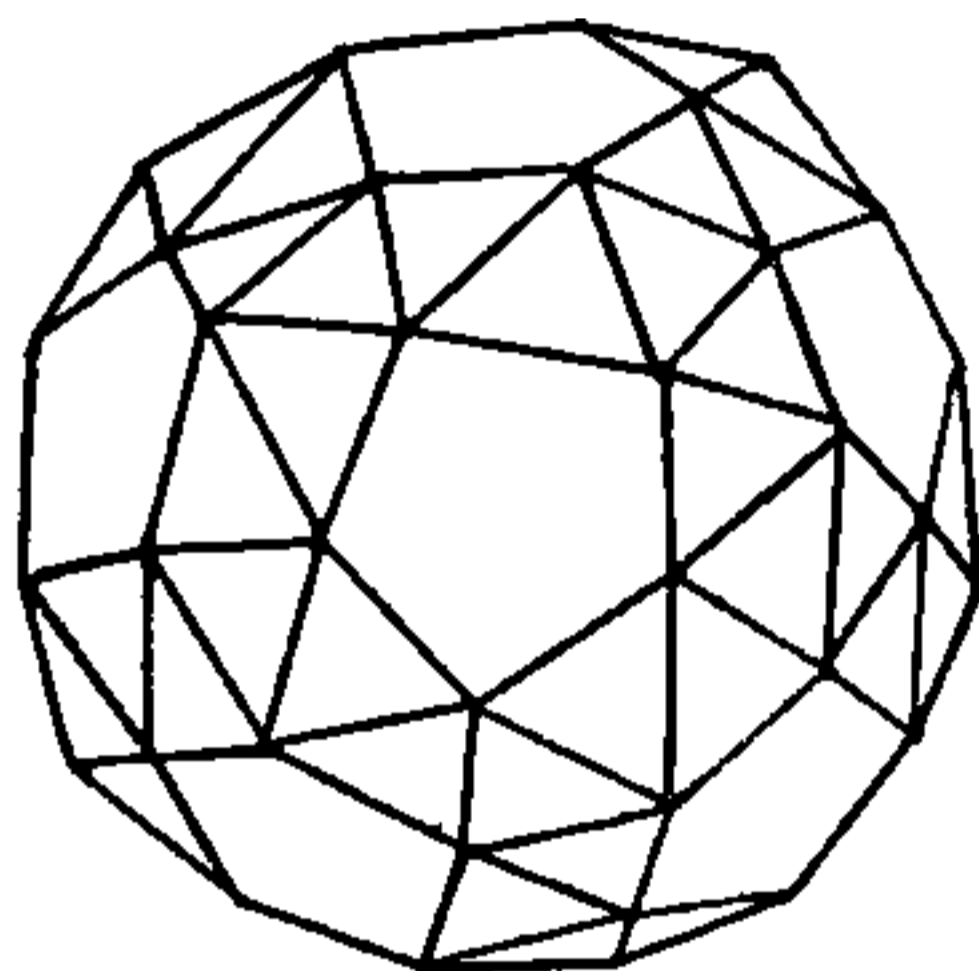

FIG. 6.

taken from Kepler. P_{10} is the *snub cube* in which each solid angle is formed by the angles of four equilateral triangles and one square; P_{13} is the *snub dodecahedron*, each solid angle of which is formed by the angles of four equilateral triangles and *one regular pentagon*.

We are indebted to Arabian tradition for

(γ) *The Liber Assumptorum.*

Of the theorems contained in this collection many are so elegant as to afford a presumption that they may really be due to Archimedes. In three of them the figure appears which was called $\acute{\alpha}\rho\beta\eta\lambda\omicron\varsigma$, a shoemaker's knife, consisting of three semicircles with a common diameter as shown in the annexed figure. If N be the point at which the diameters



THIS PAGE IS LOCKED TO FREE MEMBERS

Purchase full membership to immediately unlock this page

DELVE INTO FANTASY, MAGIC, MYTHOLOGY & FOLKLORE

Forgotten Books'
Full Membership gives
access to 797,885 ancient
and modern, fiction and
non-fiction books.

Continue

*Fair usage policy applies

Lastly, we may mention the elegant theorem about the area of the *Salinon* (presumably 'salt-cellar') in Prop. 14. ACB is a semicircle on AB as diameter, AD , EB are equal lengths measured from A and B on AB . Semicircles are drawn with AD , EB as diameters on the side towards C , and

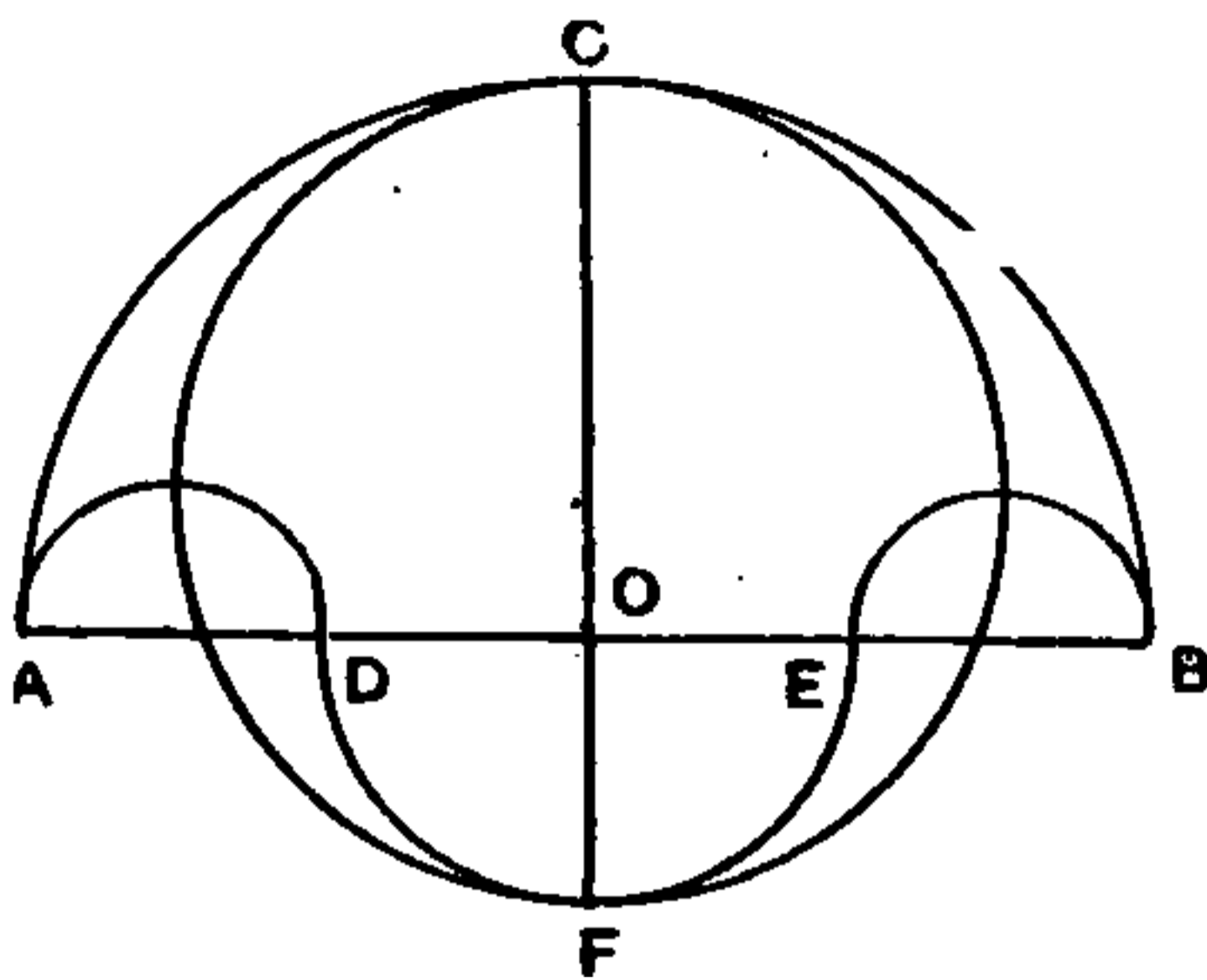

a semicircle with DE as diameter is drawn on the other side of AB . CF is the perpendicular to AB through O , the centre of the semicircles ACB , DFE . Then is the area bounded by all the semicircles (the *Salinon*) equal to the circle on CF as diameter.

The Arabians, through whom the Book of Lemmas has reached us, attributed to Archimedes other works (1) on the Circle, (2) on the Heptagon in a Circle, (3) on Circles touching one another, (4) on Parallel Lines, (5) on Triangles, (6) on the properties of right-angled triangles, (7) a book of *Data*, (8) *De clepsydris*: statements which we are not in a position to check. But the author of a book on the finding of chords in a circle,¹ Abū'l-Raiḥān Muḥ. al-Bīrūnī, quotes some alternative proofs as coming from the first of these works.

(8) *Formula for area of triangle.*

More important, however, is the mention in this same work of Archimedes as the discoverer of two propositions hitherto attributed to Heron, the first being the problem of finding the perpendiculars of a triangle when the sides are given, and the second the famous formula for the area of a triangle in terms of the sides,

$$\sqrt{\{s(s-a)(s-b)(s-c)\}}.$$

¹ See *Bibliotheca mathematica*, xi, pp. 11-78.

Long as the present chapter is, it is nevertheless the most appropriate place for ERATOSTHENES of Cyrene. It was to him that Archimedes dedicated *The Method*, and the *Cattle-Problem* purports, by its heading, to have been sent through him to the mathematicians of Alexandria. It is evident from the preface to *The Method* that Archimedes thought highly of his mathematical ability. He was, indeed, recognized by his contemporaries as a man of great distinction in all branches of knowledge, though in each subject he just fell short of the highest place. On the latter ground he was called Beta, and another nickname applied to him, *Pentathlos*, has the same implication, representing as it does an all-round athlete who was not the first runner or wrestler but took the second prize in these contests as well as in others. He was very little younger than Archimedes; the date of his birth was probably 284 B.C. or thereabouts. He was a pupil of the philosopher Ariston of Chios, the grammarian Lysanias of Cyrene, and the poet Callimachus; he is said also to have been a pupil of Zeno the Stoic, and he may have come under the influence of Arcesilaus at Athens, where he spent a considerable time. Invited, when about 40 years of age, by Ptolemy Euergetes to be tutor to his son (Philopator), he became librarian at Alexandria; his obligation to Ptolemy he recognized by the column which he erected with a graceful epigram inscribed on it. This is the epigram, with which we are already acquainted (vol. i, p. 260), relating to the solutions, discovered up to date, of the problem of the duplication of the cube, and commending his own method by means of an appliance called *μεσόλαβον*, itself represented in bronze on the column.

Eratosthenes wrote a book with the title *Πλατωνικός*, and, whether it was a sort of commentary on the *Timaeus* of Plato, or a dialogue in which the principal part was played by Plato, it evidently dealt with the fundamental notions of mathematics in connexion with Plato's philosophy. It was naturally one of the important sources of Theon of Smyrna's work on the mathematical matters which it was necessary for the student of Plato to know; and Theon cites the work twice by name. It seems to have begun with the famous problem of Delos, telling the story quoted by Theon how the god required, as a means of stopping a plague, that the altar

there, which was cubical in form, should be doubled in size. The book evidently contained a disquisition on *proportion* (*ἀναλογία*); a quotation by Theon on this subject shows that Eratosthenes incidentally dealt with the fundamental definitions of geometry and arithmetic. The principles of music were discussed in the same work.

We have already described Eratosthenes's solution of the problem of Delos, and his contribution to the theory of arithmetic by means of his *sieve* (*κόσκινον*) for finding successive prime numbers.

He wrote also an independent work *On means*. This was in two Books, and was important enough to be mentioned by Pappus along with works by Euclid, Aristaeus and Apollonius as forming part of the *Treasury of Analysis*¹; this proves that it was a systematic geometrical treatise. Another passage of Pappus speaks of certain loci which Eratosthenes called 'loci with reference to means' (*τόποι πρὸς μεσότητα*)²; these were presumably discussed in the treatise in question. What kind of loci these were is quite uncertain; Pappus (if it is not an interpolator who speaks) merely says that these loci 'belong to the aforesaid classes of loci', but as the classes are numerous (including 'plane', 'solid', 'linear', 'loci on surfaces', &c.), we are none the wiser. Tannery conjectured that they were loci of points such that their distances from three fixed straight lines furnished a 'médieté', i.e. loci (straight lines and conics) which we should represent in trilinear coordinates by such equations as $2y = x + z$, $y^2 = xz$, $y(x + z) = 2xz$, $x(x - y) = z(y - z)$, $x(x - y) = y(y - z)$, the first three equations representing the arithmetic, geometric and harmonic means, while the last two represent the 'subcontraries' to the harmonic and geometric means respectively. Zeuthen has a different conjecture.³ He points out that, if QQ' be the polar of a given point C with reference to a conic, and $CPOP'$ be drawn through C meeting QQ' in O and the conic in P, P' , then CO is the harmonic mean to CP, CP' ; the locus of O for all transversals CPP' is then the straight line QQ' . If A, G are points on PP' such that CA is the arithmetic, and CG the

¹ Pappus, vii, p. 636. 24.

² *Ib.*, p. 662. 15 sq.

³ Zeuthen, *Die Lehre von den Kegelschnitten im Altertum*, 1886, pp. 320, 321.



THIS PAGE IS LOCKED TO FREE MEMBERS

Purchase full membership to immediately unlock this page

FORGOTTEN BOOKS

FULL

MEMBERSHIP

797,885 Books!

All you can read

for only

\$8.99/month

Continue

*Fair usage policy applies



α , or $1/50$ th of four right angles. Now the distance from S to A was known by measurement to be 5,000 stades; it followed that the circumference of the earth was 250,000 stades. This is the figure given by Cleomedes, but Theon of Smyrna and Strabo both give it as 252,000 stades. The reason of the discrepancy is not known; it is possible that Eratosthenes corrected 250,000 to 252,000 for some reason, perhaps in order to get a figure divisible by 60 and, incidentally, a round number (700) of stades for one degree. If Pliny is right in saying that Eratosthenes made 40 stades equal to the Egyptian $\sigma\chi\omicron\iota\nu\omicron\varsigma$, then, taking the $\sigma\chi\omicron\iota\nu\omicron\varsigma$ at 12,000 Royal cubits of 0.525 metres, we get 300 such cubits, or 157.5 metres, i.e. 516.73 feet, as the length of the stade. On this basis 252,000 stades works out to 24,662 miles, and the diameter of the earth to about 7,850 miles, only 50 miles shorter than the true polar diameter, a surprisingly close approximation, however much it owes to happy accidents in the calculation.

We learn from Heron's *Dioptra* that the measurement of the earth by Eratosthenes was given in a separate work *On the Measurement of the Earth*. According to Galen¹ this work dealt generally with astronomical or mathematical geography, treating of 'the size of the equator, the distance of the tropic and polar circles, the extent of the polar zone, the size and distance of the sun and moon, total and partial eclipses of these heavenly bodies, changes in the length of the day according to the different latitudes and seasons'. Several details are preserved elsewhere of results obtained by Eratosthenes, which were doubtless contained in this work. He is supposed to have estimated the distance between the tropic circles or twice the obliquity of the ecliptic at $11/83$ rd of a complete circle or $47^\circ 42' 39''$; but from Ptolemy's language on this subject it is not clear that this estimate was not Ptolemy's own. What Ptolemy says is that he himself found the distance between the tropic circles to lie always between $47^\circ 40'$ and $47^\circ 45'$, 'from which we obtain *about* ($\sigma\chi\epsilon\delta\acute{\omicron}\nu$) the same ratio as that of Eratosthenes, which Hipparchus also used. For the distance between the tropics becomes (or is found to be, $\gamma\acute{\iota}\nu\epsilon\tau\alpha\iota$) very nearly 11 parts

Galen, *Instit. Logica*, 12 (p. 26 Kalbfleisch).

out of 83 contained in the whole meridian circle'.¹ The mean of Ptolemy's estimates, $47^{\circ} 42' 30''$, is of course nearly $11/83$ rds of 360° . It is consistent with Ptolemy's language to suppose that Eratosthenes adhered to the value of the obliquity of the ecliptic discovered before Euclid's time, namely 24° , and Hipparchus does, in his extant *Commentary on the Phaenomena of Aratus and Eudoxus*, say that the summer tropic is 'very nearly 24° north of the equator'.

The *Doxographi* state that Eratosthenes estimated the distance of the moon from the earth at 780,000 stades and the distance of the sun from the earth at 804,000,000 stades (the versions of Stobaeus and Joannes Lydus admit 4,080,000 as an alternative for the latter figure, but this obviously cannot be right). Macrobius² says that Eratosthenes made the 'measure' of the sun to be 27 times that of the earth. It is not certain whether measure means 'solid content' or 'diameter' in this case; the other figures on record make the former more probable, in which case the diameter of the sun would be three times that of the earth. Macrobius also tells us that Eratosthenes's estimates of the distances of the sun and moon were obtained by means of lunar eclipses.

Another observation by Eratosthenes, namely that at Syene (which is under the summer tropic) and throughout a circle round it with a radius of 300 stades the upright gnomon throws no shadow at noon, was afterwards made use of by Posidonius in his calculation of the size of the sun. Assuming that the circle in which the sun apparently moves round the earth is 10,000 times the size of a circular section of the earth through its centre, and combining with this hypothesis the datum just mentioned, Posidonius arrived at 3,000,000 stades as the diameter of the sun.

Eratosthenes wrote a poem called *Hermes* containing a good deal of descriptive astronomy; only fragments of this have survived. The work *Catasterismi* (literally 'placings among the stars') which is extant can hardly be genuine in the form in which it has reached us; it goes back, however, to a genuine work by Eratosthenes which apparently bore the same name; alternatively it is alluded to as *Kατάλογοι* or by the general

¹ Ptolemy, *Syntaxis*, i. 12, pp. 67. 22-68. 6.

² Macrobius, *In Somn. Scip.* i. 20. 9.

word *Ἀστρονομία* (Suidas), which latter word is perhaps a mistake for *Ἀστροθεσία* corresponding to the title *Ἀστροθεσίαι ζώδιων* found in the manuscripts. The work as we have it contains the story, mythological and descriptive, of the constellations, &c., under forty-four heads; there is little or nothing belonging to astronomy proper.

Eratosthenes is also famous as the first to attempt a scientific chronology beginning from the siege of Troy; this was the subject of his *Χρονογραφίαι*, with which must be connected the separate *Ὀλυμπιονίκαι* in several books. Clement of Alexandria gives a short *résumé* of the main results of the former work, and both works were largely used by Apollodorus. Another lost work was on the Octaëteris (or eight-years' period), which is twice mentioned, by Geminus and Achilles; from the latter we learn that Eratosthenes regarded the work on the same subject attributed to Eudoxus as not genuine. His *Geographica* in three books is mainly known to us through Suidas's criticism of it. It began with a history of geography down to his own time; Eratosthenes then proceeded to mathematical geography, the spherical form of the earth, the negligibility in comparison with this of the unevennesses caused by mountains and valleys, the changes of features due to floods, earthquakes and the like. It would appear from Theon of Smyrna's allusions that Eratosthenes estimated the height of the highest mountain to be 10 stades or about 1/8000th part of the diameter of the earth.



THIS PAGE IS LOCKED TO FREE MEMBERS

Purchase full membership to immediately unlock this page

DELVE INTO FANTASY, MAGIC, MYTHOLOGY & FOLKLORE

Forgotten Books'
Full Membership gives
access to 797,885 ancient
and modern, fiction and
non-fiction books.

Continue

*Fair usage policy applies

observation that an ellipse can be obtained from a cylinder as well as a cone is actually made by Euclid in his *Phaenomena*: 'if', says Euclid, 'a cone or a cylinder be cut by a plane not parallel to the base, the resulting section is a section of an acute-angled cone which is similar to a *θυρεός* (shield).' After this would doubtless follow the question what sort of curves they are which are produced if we cut a cone by a plane which does not cut through the cone completely, but is either parallel or not parallel to a generator of the cone, whether these curves have the same property with the ellipse and with one another, and, if not, what exactly are their fundamental properties respectively.

As it is, however, we are only told how the first writers on conics obtained them in actual practice. We learn on the authority of Geminus¹ that the ancients defined a cone as the surface described by the revolution of a right-angled triangle about one of the sides containing the right angle, and that they knew no cones other than right cones. Of these they distinguished three kinds; according as the vertical angle of the cone was less than, equal to, or greater than a right angle, they called the cone acute-angled, right-angled, or obtuse-angled, and from each of these kinds of cone they produced one and only one of the three sections, the section being always made perpendicular to one of the generating lines of the cone; the curves were, on this basis, called 'section of an acute-angled cone' (= an ellipse), 'section of a right-angled cone' (= a parabola), and 'section of an obtuse-angled cone' (= a hyperbola) respectively. These names were still used by Euclid and Archimedes.

Menaechmus's probable procedure.

Menaechmus's constructions for his curves would presumably be the simplest and the most direct that would show the desired properties, and for the parabola nothing could be simpler than a section of a right-angled cone by a plane at right angles to one of its generators. Let *OBC* (Fig. 1) represent

¹ Eutocius, *Comm. on Conics* of Apollonius.

a section through the axis OL of a right-angled cone, and conceive a section through AG (perpendicular to OA) and at right angles to the plane of the paper.

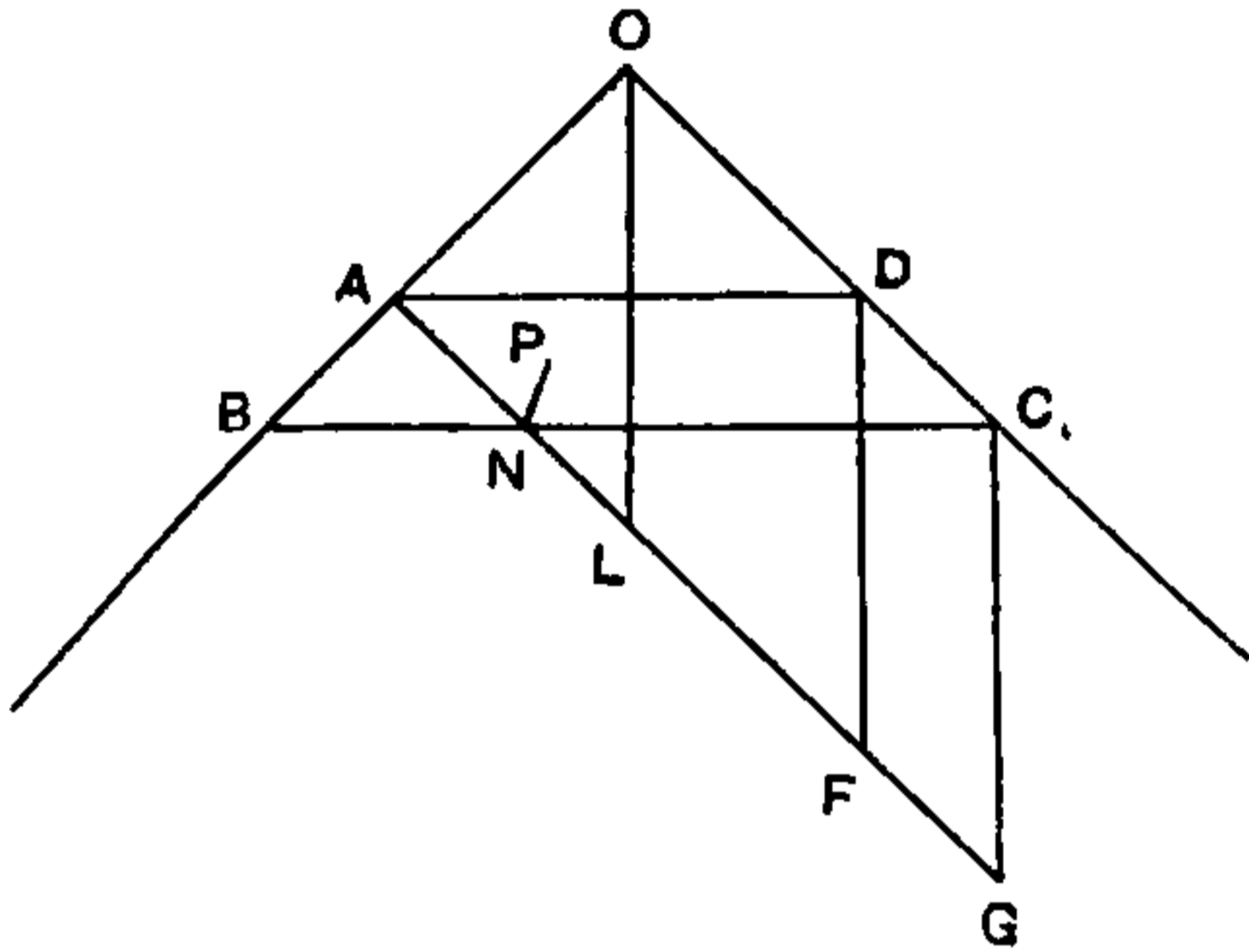

FIG. 1.

If P is any point on the curve, and PN perpendicular to AG , let BC be drawn through N perpendicular to the axis of the cone. Then P is on the circular section of the cone about BC as diameter.

Draw AD parallel to BC , and DF, CG parallel to OL meeting AL produced in F, G . Then AD, AF are both bisected by OL .

$$\text{If now} \quad PN = y, \quad AN = x,$$

$$y^2 = PN^2 = BN \cdot NC.$$

But B, A, C, G are concyclic, so that

$$\begin{aligned} BN \cdot NC &= AN \cdot NG \\ &= AN \cdot AF \\ &= AN \cdot 2AL. \end{aligned}$$

$$\begin{aligned} \text{Therefore} \quad y^2 &= AN \cdot 2AL \\ &= 2AL \cdot x, \end{aligned}$$

and $2AL$ is the 'parameter' of the principal ordinates y .

In the case of the hyperbola Menaechmus had to obtain the

particular hyperbola which we call rectangular or equilateral, and also to obtain its property with reference to its asymptotes, a considerable advance on what was necessary in the case of the parabola. Two methods of obtaining the particular hyperbola were possible, namely (1) to obtain the hyperbola arising from the section of any obtuse-angled cone by a plane at right angles to a generator, and then to show how a rectangular hyperbola can be obtained as a particular case by finding the vertical angle which the cone must have to give a rectangular hyperbola when cut in the particular way, or (2) to obtain the rectangular hyperbola direct by cutting another kind of cone by a section not necessarily perpendicular to a generator.

(1) Taking the first method, we draw (Fig. 2) a cone with its vertical angle BOC obtuse. Imagine a section perpendicular to the plane of the paper and passing through AG which is perpendicular to OB . Let GA produced meet CO produced in A' , and complete the same construction as in the case of the parabola.

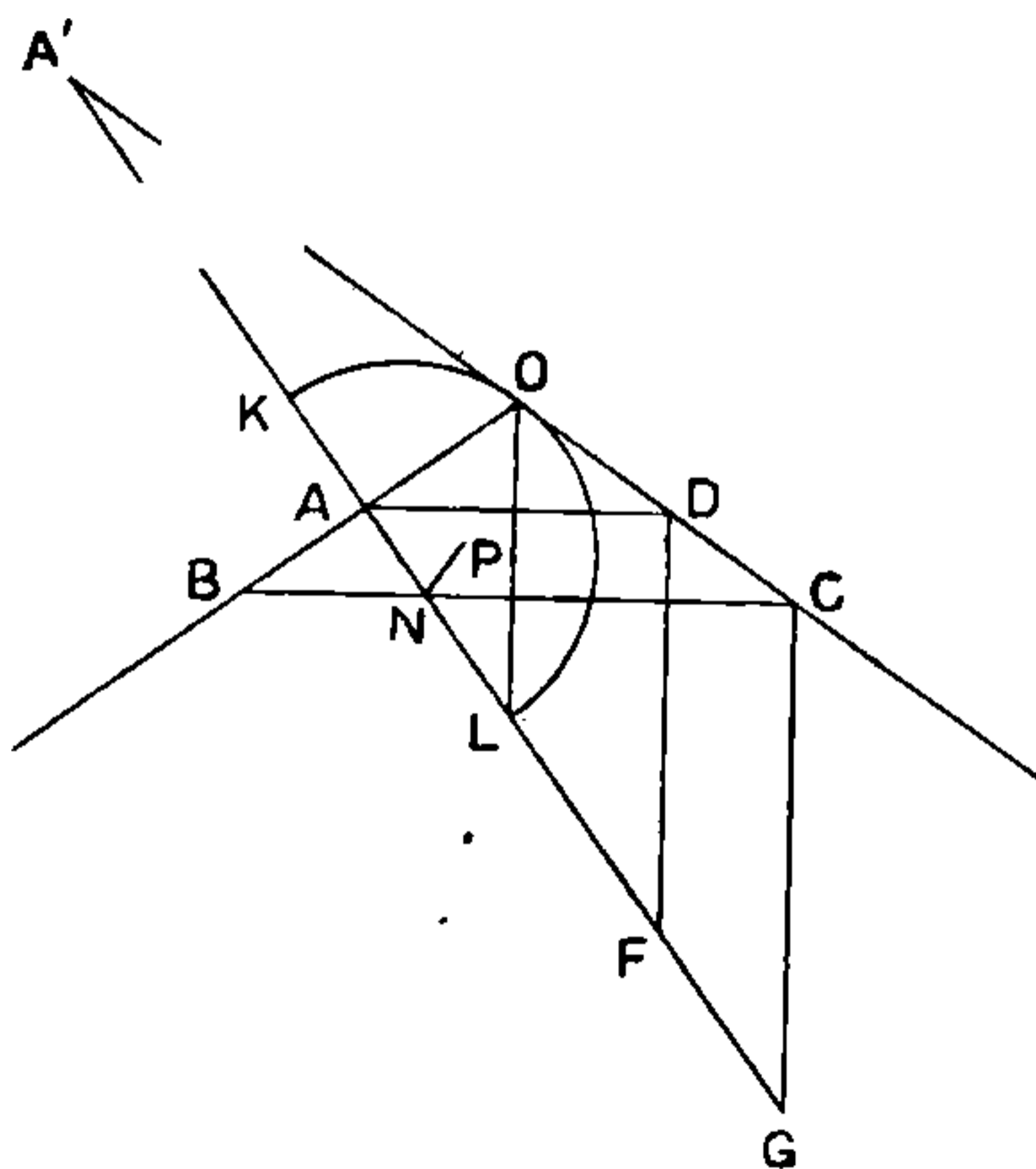

FIG. 2.

In this case we have

$$PN^2 = BN \cdot NC = AN \cdot NG.$$



THIS PAGE IS LOCKED TO FREE MEMBERS

Purchase full membership to immediately unlock this page

FORGOTTEN BOOKS

FULL

MEMBERSHIP

797,885 Books!

All you can read

for only

\$8.99/month

Continue

*Fair usage policy applies



For, let the right-angled cone HOK (Fig. 3) be cut by a plane through $A'AN$ parallel to the axis OM and cutting the sides of the axial triangle HOK in A', A, N respectively. Let P be the point on the curve for which PN is the principal ordinate. Draw OC parallel to HK . We have at once

$$PN^2 = HN \cdot NK$$

$$= MK^2 - MN^2$$

$$= CN^2 - CA^2, \text{ since } MK = OM, \text{ and } MN = OC = CA.$$

This is the property of the rectangular hyperbola having $A'A$ as axis. To obtain a particular rectangular hyperbola with axis of given length we have only to choose the cutting plane so that the intercept $A'A$ may have the given length.

But Menaechmus had to prove the asymptote-property of his rectangular hyperbola. As he can hardly be supposed to have got as far as Apollonius in investigating the relations of the hyperbola to its asymptotes, it is probably safe to assume that he obtained the particular property in the simplest way, i. e. directly from the property of the curve in relation to its axes.

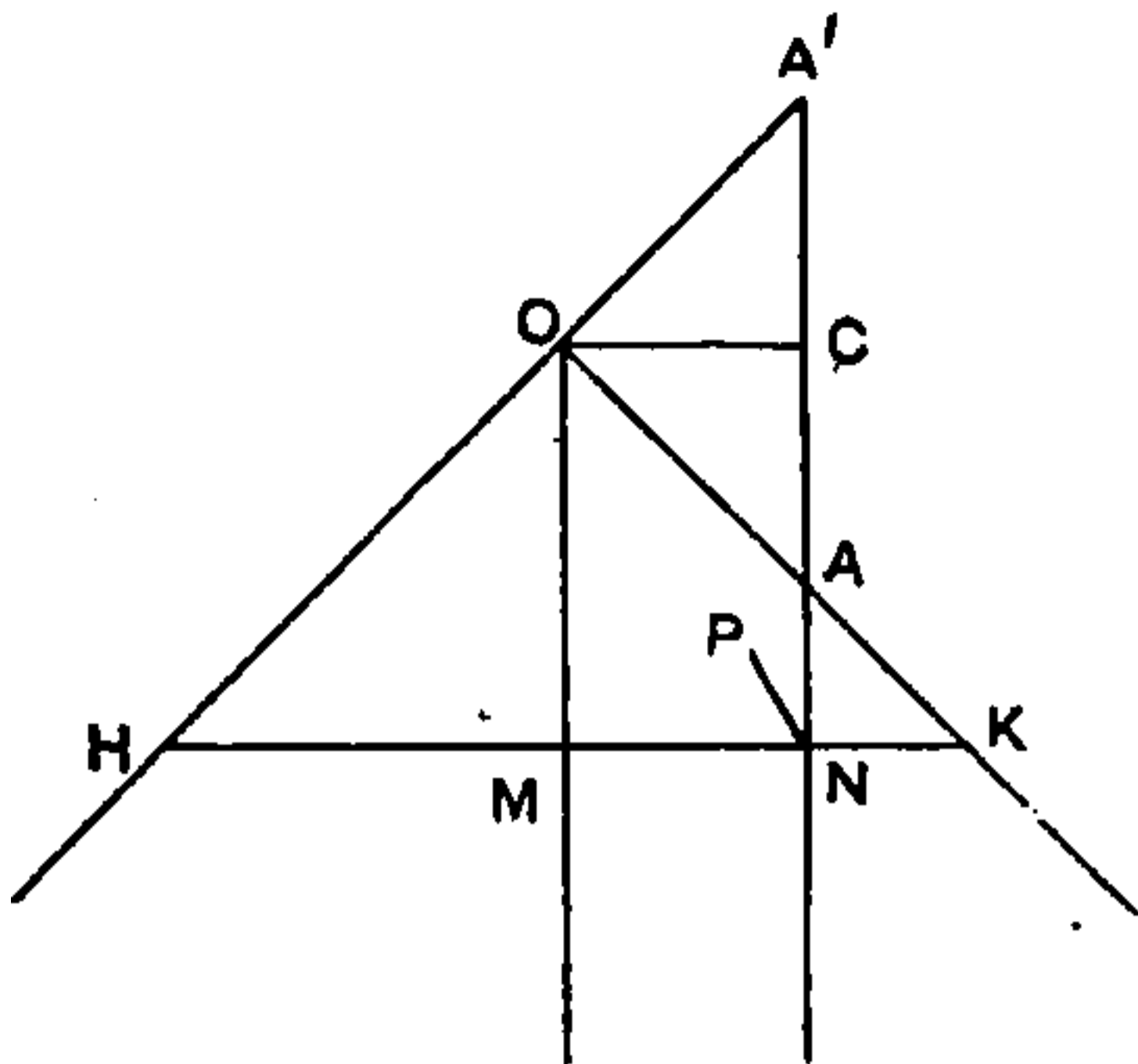

FIG. 3.

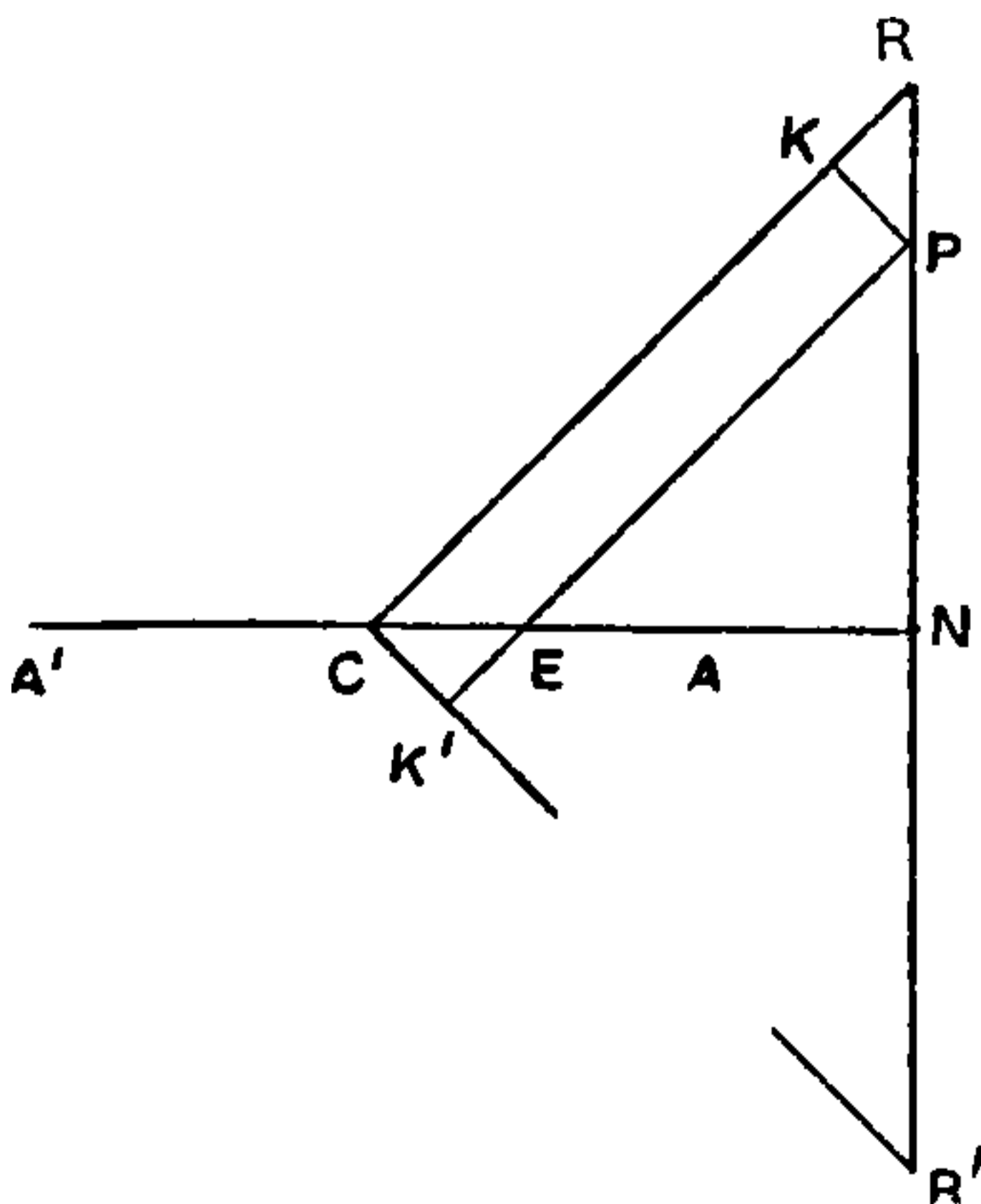

FIG. 4.

If (Fig. 4) CR, CR' be the asymptotes (which are therefore

at right angles) and $A'A$ the axis of a rectangular hyperbola, P any point on the curve, PN the principal ordinate, draw PK, PK' perpendicular to the asymptotes respectively. Let PN produced meet the asymptotes in R, R' .

Now, by the axial property,

$$\begin{aligned} CA^2 &= CN^2 - PN^2 \\ &= RN^2 - PN^2 \\ &= RP \cdot PR' \\ &= 2PK \cdot PK', \text{ since } \angle PRK \text{ is half a right angle;} \end{aligned}$$

therefore $PK \cdot PK' = \frac{1}{2}CA^2$.

Works by Aristaeus and Euclid.

If Menaechmus was really the discoverer of the three conic sections at a date which we must put at about 360 or 350 B.C., the subject must have been developed very rapidly, for by the end of the century there were two considerable works on conics in existence, works which, as we learn from Pappus, were considered worthy of a place, alongside the *Conics* of Apollonius, in the *Treasury of Analysis*. Euclid flourished about 300 B.C., or perhaps 10 or 20 years earlier; but his *Conics* in four books was preceded by a work of Aristaeus which was still extant in the time of Pappus, who describes it as 'five books of *Solid Loci* connected (or continuous, $\sigma\upsilon\nu\epsilon\chi\eta$) with the conics'. Speaking of the relation of Euclid's *Conics* in four books to this work, Pappus says (if the passage is genuine) that Euclid gave credit to Aristaeus for his discoveries in conics and did not attempt to anticipate him or wish to construct anew the same system. In particular, Euclid, when dealing with what Apollonius calls the three- and four-line locus, 'wrote so much about the locus as was possible by means of the conics of Aristaeus, without claiming completeness for his demonstrations'.¹ We gather from these remarks that Euclid's *Conics* was a compilation and rearrangement of the geometry of the conics so far as known in his

¹ Pappus, vii, p. 678. 4.

time, whereas the work of Aristaeus was more specialized and more original.

‘*Solid loci*’ and ‘*solid problems*’.

‘Solid loci’ are of course simply conics, but the use of the title ‘Solid loci’ instead of ‘conics’ seems to indicate that the work was in the main devoted to conics regarded as loci. As we have seen, ‘solid loci’ which are conics are distinguished from ‘plane loci’, on the one hand, which are straight lines and circles, and from ‘linear loci’ on the other, which are curves higher than conics. There is some doubt as to the real reason why the term ‘solid loci’ was applied to the conic sections. We are told that ‘plane’ loci are so called because they are generated in a plane (but so are some of the higher curves, such as the *quadratrix* and the spiral of Archimedes), and that ‘solid loci’ derived their name from the fact that they arise as sections of solid figures (but so do some higher curves, e.g. the spiric curves which are sections of the $\sigma\pi\epsilon\acute{\iota}\rho\alpha$ or *tore*). But some light is thrown on the subject by the corresponding distinction which Pappus draws between ‘plane’, ‘solid’ and ‘linear’ *problems*.

‘Those problems’, he says, ‘which can be solved by means of a straight line and a circumference of a circle may properly be called *plane*; for the lines by means of which such problems are solved have their origin in a plane. Those, however, which are solved by using for their discovery one or more of the sections of the cone have been called *solid*; for their construction requires the use of surfaces of solid figures, namely those of cones. There remains a third kind of problem, that which is called *linear*; for other lines (curves) besides those mentioned are assumed for the construction, the origin of which is more complicated and less natural, as they are generated from more irregular surfaces and intricate movements.’¹

The true significance of the word ‘plane’ as applied to problems is evidently, not that straight lines and circles have their origin in a plane, but that the problems in question can be solved by the ordinary plane methods of transformation of

¹ Pappus, iv, p. 270. 5–17.



THIS PAGE IS LOCKED TO FREE MEMBERS

Purchase full membership to immediately unlock this page

DELVE INTO FANTASY, MAGIC, MYTHOLOGY & FOLKLORE

Forgotten Books'
Full Membership gives
access to 797,885 ancient
and modern, fiction and
non-fiction books.

Continue

*Fair usage policy applies

the same way the point will lie on a conic section given in position.'¹

The reason why Apollonius referred in this connexion to Euclid and not to Aristaeus was probably that it was Euclid's work that was on the same lines as his own.

A very large proportion of the standard properties of conics admit of being stated in the form of locus-theorems; if a certain property holds with regard to a certain point, then that point lies on a conic section. But it may be assumed that Aristaeus's work was not merely a collection of the ordinary propositions transformed in this way; it would deal with new locus-theorems not implied in the fundamental definitions and properties of the conics, such as those just mentioned, the theorems of the three- and four-line locus. But one (to us) ordinary property, the focus-directrix property, was, as it seems to me, in all probability included.

Focus-directrix property known to Euclid.

It is remarkable that the directrix does not appear at all in Apollonius's great treatise on conics. The focal properties of the central conics are given by Apollonius, but the foci are obtained in a different way, without any reference to the directrix; the focus of the parabola does not appear at all. We may perhaps conclude that neither did Euclid's *Conics* contain the focus-directrix property; for, according to Pappus, Apollonius based his first four books on Euclid's four books, while filling them out and adding to them. Yet Pappus gives the proposition as a lemma to Euclid's *Surface-Loci*, from which we cannot but infer that it was assumed in that treatise without proof. If, then, Euclid did not take it from his own *Conics*, what more likely than that it was contained in Aristaeus's *Solid Loci*?

Pappus's enunciation of the theorem is to the effect that the locus of a point such that its distance from a given point is in a given ratio to its distance from a fixed straight line is a conic section, and is an ellipse, a parabola, or a hyperbola according as the given ratio is less than, equal to, or greater than unity.

¹ Pappus, vii, p. 678. 15-24.

Proof from Pappus.

The proof in the case where the given ratio is different from unity is shortly as follows.

Let S be the fixed point, SX the perpendicular from S on the fixed line. Let P be any point on the locus and PN

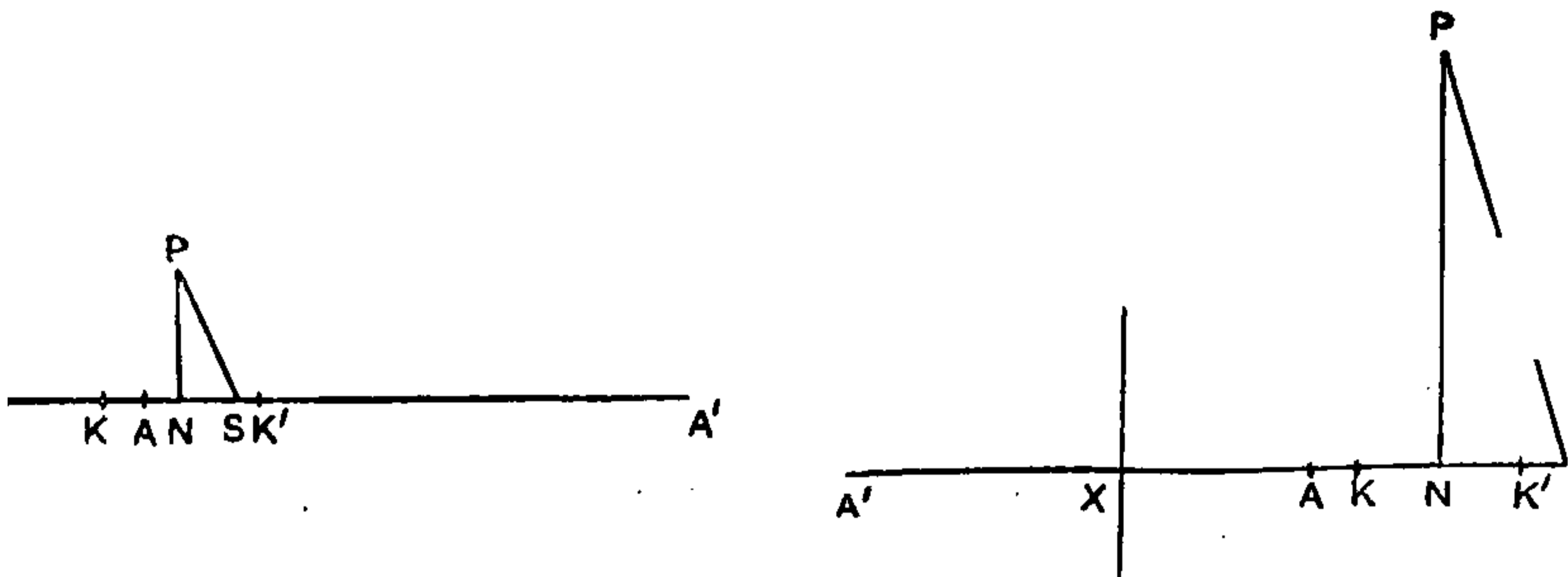

perpendicular to SX , so that SP is to NX in the given ratio (e);

thus
$$e^2 = (PN^2 + SN^2) : NX^2.$$

Take K on SX such that

$$e^2 = SN^2 : NK^2;$$

then, if K' be another point on SN , produced if necessary, such that $NK = NK'$,

$$\begin{aligned} e^2 : 1 &= (PN^2 + SN^2) : NX^2 = SN^2 : NK^2 \\ &= PN^2 : (NX^2 - NK^2) \\ &= PN^2 : XK \cdot XK'. \end{aligned}$$

The positions of N , K , K' change with the position of P . If A , A' be the points on which N falls when K , K' coincide with X respectively, we have

$$SA : AX = SN : NK = e : 1 = SN : NK' = SA' : A'X.$$

Therefore $SX : SA = SK : SN = (1 + e) : e$,

whence
$$\begin{aligned} (1 + e) : e &= (SX - SK) : (SA - SN) \\ &= XK : AN. \end{aligned}$$

Similarly it can be shown that

$$(1 \sim e) : e = XK' : A'N.$$

By multiplication, $XK \cdot XK' : AN \cdot A'N = (1 \sim e^2) : e^2$;

and it follows from above, *ex aequali*, that

$$PN^2 : AN \cdot A'N = (1 \sim e^2) : 1,$$

which is the property of a central conic.

When $e < 1$, A and A' lie on the same side of X , while N lies on AA' , and the conic is an ellipse; when $e > 1$, A and A' lie on opposite sides of X , while N lies on $A'A$ produced, and the conic is a hyperbola.

The case where $e = 1$ and the curve is a parabola is easy and need not be reproduced here.

The treatise would doubtless contain other loci of types similar to that which, as Pappus says, was used for the trisection of an angle: I refer to the proposition already quoted (vol. i, p. 243) that, if A, B are the base angles of a triangle with vertex P , and $\angle B = 2\angle A$, the locus of P is a hyperbola with eccentricity 2.

Propositions included in Euclid's *Conics*.

That Euclid's *Conics* covered much of the same ground as the first three Books of Apollonius is clear from the language of Apollonius himself. Confirmation is forthcoming in the quotations by Archimedes of propositions (1) 'proved in the elements of conics', or (2) assumed without remark as already known. The former class include the fundamental ordinate properties of the conics in the following forms:

(1) for the ellipse,

$$PN^2 : AN \cdot A'N = P'N'^2 : AN' \cdot A'N' = BC^2 : AC^2;$$

(2) for the hyperbola,

$$PN^2 : AN \cdot A'N = P'N'^2 : AN' \cdot A'N';$$

(3) for the parabola, $PN^2 = p_a \cdot AN$;

the principal tangent properties of the parabola;

the property that, if there are two tangents drawn from one point to any conic section whatever, and two intersecting



THIS PAGE IS LOCKED TO FREE MEMBERS

Purchase full membership to immediately unlock this page

FORGOTTEN BOOKS

FULL

MEMBERSHIP

797,885 Books!

All you can read

for only

\$8.99/month

Continue

*Fair usage policy applies



In the case of the hyperbola Archimedes does not give any expression for the constant ratios $PN^2:AN.A'N$ and $QV^2:PV.P'V$ respectively, whence we conclude that he had no conception of diameters or radii of a hyperbola not meeting the curve.

2. The straight line drawn from the centre of an ellipse, or the point of intersection of the asymptotes of a hyperbola, through the point of contact of any tangent, bisects all chords parallel to the tangent.

3. In the ellipse the tangents at the extremities of either of two conjugate diameters are both parallel to the other diameter.

4. If in a hyperbola the tangent at P meets the transverse axis in T , and PN is the principal ordinate, $AN > AT$. (It is not easy to see how this could be proved except by means of the general property that, if PP' be any diameter of a hyperbola, QV the ordinate to it from Q , and QT the tangent at Q meeting $P'P$ in T , then $TP:TP' = PV:P'V$.)

5. If a cone, right or oblique, be cut by a plane meeting all the generators, the section is either a circle or an ellipse.

6. If a line between the asymptotes meets a hyperbola and is bisected at the point of concurrence, it will touch the hyperbola.

7. If x, y are straight lines drawn, in fixed directions respectively, from a point on a hyperbola to meet the asymptotes, the rectangle xy is constant.

8. If PN be the principal ordinate of P , a point on an ellipse, and if NP be produced to meet the auxiliary circle in p , the ratio $pN:PN$ is constant.

9. The criteria of similarity of conics and segments of conics are assumed in practically the same form as Apollonius gives them.

The Parabola.

1. The fundamental properties appear in the alternative forms

$$PN^2: P'N'^2 = AN: AN', \text{ or } PN^2 = p_a \cdot AN,$$

$$QV^2: Q'V'^2 = PV: P'V', \text{ or } QV^2 = p \cdot PV.$$

Archimedes applies the term *parameter* ($\acute{\alpha}$ παρ' ἂν δύνανται αἰ ἀπὸ τᾶς τομᾶς) to the parameter of the principal ordinates

only: p is simply the line to which the rectangle equal to QV^2 and of width equal to PV is applied.

2. Parallel chords are bisected by one straight line parallel to the axis, which passes through the point of contact of the tangent parallel to the chords.

3. If the tangent at Q meet the diameter PV in T , and QV be the ordinate to the diameter, $PV = PT$.

By the aid of this proposition a tangent to the parabola can be drawn (a) at a point on it, (b) parallel to a given chord.

4. Another proposition assumed is equivalent to the property of the subnormal, $NG = \frac{1}{2} p_a$.

5. If QQ' be a chord of a parabola perpendicular to the axis and meeting the axis in M , while QVq another chord parallel to the tangent at P meets the diameter through P in V , and RHK is the principal ordinate of any point R on the curve meeting PV in H and the axis in K , then $PV:PH >$ or $= MK:KA$; 'for this is proved' (*On Floating Bodies*, II. 6).

Where it was proved we do not know; the proof is not altogether easy.¹

6. All parabolas are similar.

As we have seen, Archimedes had to specialize in the parabola for the purpose of his treatises on the *Quadrature of the Parabola*, *Conoids and Spheroids*, *Floating Bodies*, Book II, and *Plane Equilibriums*, Book II; consequently he had to prove for himself a number of special propositions, which have already been given in their proper places. A few others are assumed without proof, doubtless as being easy deductions from the propositions which he does prove. They refer mainly to similar parabolic segments so placed that their bases are in one straight line and have one common extremity.

1. If any three similar and similarly situated parabolic segments BQ , BQ_2 , BQ_3 lying along the same straight line as bases ($BQ_1 < BQ_2 < BQ_3$), and if E be any point on the tangent at B to one of the segments, and EO a straight line through E parallel to the axis of one of the segments and meeting the segments in R_3 , R_2 , R_1 respectively and BQ_3 in O , then

$$R_3 R_2 : R_2 R_1 = (Q_2 Q_3 : BQ_3) \cdot (BQ_1 : Q_1 Q_2).$$

¹ See *Apollonius of Perga*, ed. Heath, p. liv.

2. If two similar parabolic segments with bases BQ_1, BQ_2 be placed as in the last proposition, and if BR_1R_2 be any straight line through B meeting the segments in R_1, R_2 respectively,

$$BQ_1 : BQ_2 = BR_1 : BR_2.$$

These propositions are easily deduced from the theorem proved in the *Quadrature of the Parabola*, that, if through E , a point on the tangent at B , a straight line ERO be drawn parallel to the axis and meeting the curve in R and any chord BQ through B in O , then

$$ER : RO = BO : OQ.$$

3. On the strength of these propositions Archimedes assumes the solution of the problem of placing, between two parabolic segments similar to one another and placed as in the above propositions, a straight line of a given length and in a direction parallel to the diameters of either parabola.

Euclid and Archimedes no doubt adhered to the old method of regarding the three conics as arising from sections of three kinds of right circular cones (right-angled, obtuse-angled and acute-angled) by planes drawn in each case at right angles to a generator of the cone. Yet neither Euclid nor Archimedes was unaware that the 'section of an acute-angled cone', or ellipse, could be otherwise produced. Euclid actually says in his *Phaenomena* that 'if a cone or cylinder (presumably right) be cut by a plane not parallel to the base, the resulting section is a section of an acute-angled cone which is similar to a *θυρεός* (shield)'. Archimedes knew that the non-circular sections even of an oblique circular cone made by planes cutting all the generators are ellipses; for he shows us how, given an ellipse, to draw a cone (in general oblique) of which it is a section and which has its vertex outside the plane of the ellipse on any straight line through the centre of the ellipse in a plane at right angles to the ellipse and passing through one of its axes, whether the straight line is itself perpendicular or not perpendicular to the plane of the ellipse; drawing a cone in this case of course means finding the circular sections of the surface generated by a straight line always passing through the given vertex and all the several points of the given ellipse. The method of proof would equally serve



THIS PAGE IS LOCKED TO FREE MEMBERS

Purchase full membership to immediately unlock this page

DELVE INTO FANTASY, MAGIC, MYTHOLOGY & FOLKLORE

Forgotten Books'
Full Membership gives
access to 797,885 ancient
and modern, fiction and
non-fiction books.

Continue

*Fair usage policy applies

The edition of Eutocius suffered interpolations which were probably made in the ninth century when, under the auspices of Leon, mathematical studies were revived at Constantinople; for it was at that date that the uncial manuscripts were written, from which our best manuscripts, V (= Cod. Vat. gr. 206 of the twelfth to thirteenth century) for the *Conics*, and W (= Cod. Vat. gr. 204 of the tenth century) for Eutocius, were copied.

Only the first four Books survive in Greek; the eighth Book is altogether lost, but the three Books V–VII exist in Arabic. It was Aḥmad and al-Ḥasaṇ, two sons of Muḥ. b. Mūsā b. Shākīr, who first contemplated translating the *Conics* into Arabic. They were at first deterred by the bad state of their manuscripts; but afterwards Aḥmad obtained in Syria a copy of Eutocius's edition of Books I–IV and had them translated by Hilāl b. Abī Hilāl al-Ḥimṣī (died 883/4). Books V–VII were translated, also for Aḥmad, by Thābit b. Qurra (826–901) from another manuscript. Naṣīraddīn's recension of this translation of the seven Books, made in 1248, is represented by two copies in the Bodleian, one of the year 1301 (No. 943) and the other of 1626 containing Books V–VII only (No. 885).

A Latin translation of Books I–IV was published by Johannes Baptista Memus at Venice in 1537; but the first important edition was the translation by Commandinus (Bologna, 1566), which included the lemmas of Pappus and the commentary of Eutocius, and was the first attempt to make the book intelligible by means of explanatory notes. For the Greek text Commandinus used Cod. Marcianus 518 and perhaps also Vat. gr. 205, both of which were copies of V, but not V itself.

The first published version of Books V–VII was a Latin translation by Abraham Echellensis and Giacomo Alfonso Borelli (Florence, 1661) of a reproduction of the Books written in 983 by Abū 'l Fath al-Iṣfahānī.

The *editio princeps* of the Greek text is the monumental work of Halley (Oxford, 1710). The original intention was that Gregory should edit the four Books extant in Greek, with Eutocius's commentary and a Latin translation, and that Halley should translate Books V–VII from the Arabic into

Latin. Gregory, however, died while the work was proceeding, and Halley then undertook responsibility for the whole. The Greek manuscripts used were two, one belonging to Savile and the other lent by D. Baynard; their whereabouts cannot apparently now be traced, but they were both copies of Paris. gr. 2356, which was copied in the sixteenth century from Paris. gr. 2357 of the sixteenth century, itself a copy of V. For the three Books in Arabic Halley used the Bodleian MS. 885, but also consulted (a) a compendium of the three Books by 'Abdelmelik al-Shīrāzī (twelfth century), also in the Bodleian (913), (b) Borelli's edition, and (c) Bodl. 943 above mentioned, by means of which he revised and corrected his translation when completed. Halley's edition is still, so far as I know, the only available source for Books V–VII, except for the beginning of Book V (up to Prop. 7) which was edited by L. Nix (Leipzig, 1889).

The Greek text of Books I–IV is now available, with the commentaries of Eutocius, the fragments of Apollonius, &c., in the definitive edition of Heiberg (Teubner, 1891–3).

Apollonius's own account of the *Conics*.

A general account of the contents of the great work which, according to Geminus, earned for him the title of the 'great geometer' cannot be better given than in the words of the writer himself. The prefaces to the several Books contain interesting historical details, and, like the prefaces of Archimedes, state quite plainly and simply in what way the treatise differs from those of his predecessors, and how much in it is claimed as original. The strictures of Pappus (or more probably his interpolator), who accuses him of being a braggart and unfair towards his predecessors, are evidently unfounded. The prefaces are quoted by v. Wilamowitz-Moellendorff as specimens of admirable Greek, showing how perfect the style of the great mathematicians could be when they were free from the trammels of mathematical terminology.

Book I. General Preface.

Apollonius to Eudemus, greeting.

If you are in good health and things are in other respects as you wish, it is well; with me too things are moderately

well. During the time I spent with you at Pergamum I observed your eagerness to become acquainted with my work in conics; I am therefore sending you the first book, which I have corrected, and I will forward the remaining books when I have finished them to my satisfaction. I dare say you have not forgotten my telling you that I undertook the investigation of this subject at the request of Naucrates the geometer, at the time when he came to Alexandria and stayed with me, and, when I had worked it out in eight books, I gave them to him at once, too hurriedly, because he was on the point of sailing; they had therefore not been thoroughly revised, indeed I had put down everything just as it occurred to me, postponing revision till the end. Accordingly I now publish, as opportunities serve from time to time, instalments of the work as they are corrected. In the meantime it has happened that some other persons also, among those whom I have met, have got the first and second books before they were corrected; do not be surprised therefore if you come across them in a different shape.

Now of the eight books the first four form an elementary introduction. The first contains the modes of producing the three sections and the opposite branches (of the hyperbola), and the fundamental properties subsisting in them, worked out more fully and generally than in the writings of others. The second book contains the properties of the diameters and the axes of the sections as well as the asymptotes, with other things generally and necessarily used for determining limits of possibility (*διορισμοί*); and what I mean by diameters and axes respectively you will learn from this book. The third book contains many remarkable theorems useful for the syntheses of solid loci and for *diorismi*; the most and prettiest of these theorems are new, and it was their discovery which made me aware that Euclid did not work out the synthesis of the locus with respect to three and four lines, but only a chance portion of it, and that not successfully; for it was not possible for the said synthesis to be completed without the aid of the additional theorems discovered by me. The fourth book shows in how many ways the sections of cones can meet one another and the circumference of a circle; it contains other things in addition, none of which have been discussed by earlier writers, namely the questions in how many points a section of a cone or a circumference of a circle can meet [a double-branch hyperbola, or two double-branch hyperbolas can meet one another].

The rest of the books are more by way of surplusage (*περιουσιαστικώτερα*): one of them deals somewhat fully with



THIS PAGE IS LOCKED TO FREE MEMBERS

Purchase full membership to immediately unlock this page

FORGOTTEN BOOKS

FULL

MEMBERSHIP

797,885 Books!

All you can read

for only

\$8.99/month

Continue

*Fair usage policy applies



diorismi. Nicoteles indeed, on account of his controversy with Conon, will not have it that any use can be made of the discoveries of Conon for the purpose of *diorismi*; he is, however, mistaken in this opinion, for, even if it is possible, without using them at all, to arrive at results in regard to limits of possibility, yet they at all events afford a readier means of observing some things, e.g. that several or so many solutions are possible, or again that no solution is possible; and such foreknowledge secures a satisfactory basis for investigations, while the theorems in question are again useful for the analyses of *diorismi*. And, even apart from such usefulness, they will be found worthy of acceptance for the sake of the demonstrations themselves, just as we accept many other things in mathematics for this reason and for no other.

The prefaces to Books V–VII now to be given are reproduced for Book V from the translation of L. Nix and for Books VI, VII from that of Halley.

Preface to Book V.

Apollonius to Attalus, greeting.

In this fifth book I have laid down propositions relating to *maximum* and *minimum* straight lines. You must know that my predecessors and contemporaries have only superficially touched upon the investigation of the shortest lines, and have only proved what straight lines touch the sections and, conversely, what properties they have in virtue of which they are tangents. For my part, I have proved these properties in the first book (without however making any use, in the proofs, of the doctrine of the shortest lines), inasmuch as I wished to place them in close connexion with that part of the subject in which I treat of the production of the three conic sections, in order to show at the same time that in each of the three sections countless properties and necessary results appear, as they do with reference to the original (transverse) diameter. The propositions in which I discuss the shortest lines I have separated into classes, and I have dealt with each individual case by careful demonstration; I have also connected the investigation of them with the investigation of the greatest lines above mentioned, because I considered that those who cultivate this science need them for obtaining a knowledge of the analysis, and determination of limits of possibility, of problems as well as for their synthesis: in addition to which, the subject is one of those which seem worthy of study for their own sake. Farewell.

Preface to Book VI.

Apollonius to Attalus, greeting.

I send you the sixth book of the conics, which embraces propositions about conic sections and segments of conics equal and unequal, similar and dissimilar, besides some other matters left out by those who have preceded me. In particular, you will find in this book how, in a given right cone, a section can be cut which is equal to a given section, and how a right cone can be described similar to a given cone but such as to contain a given conic section. And these matters in truth I have treated somewhat more fully and clearly than those who wrote before my time on these subjects. Farewell.

Preface to Book VII.

Apollonius to Attalus, greeting.

I send to you with this letter the seventh book on conic sections. In it are contained a large number of new propositions concerning diameters of sections and the figures described upon them; and all these propositions have their uses in many kinds of problems, especially in the determination of the limits of their possibility. Several examples of these occur in the determinate conic problems solved and demonstrated by me in the eighth book, which is by way of an appendix, and which I will make a point of sending to you as soon as possible. Farewell.

Extent of claim to originality.

We gather from these prefaces a very good idea of the plan followed by Apollonius in the arrangement of the subject and of the extent to which he claims originality. The first four Books form, as he says, an elementary introduction, by which he means an exposition of the elements of conics, that is, the definitions and the fundamental propositions which are of the most general use and application; the term 'elements' is in fact used with reference to conics in exactly the same sense as Euclid uses it to describe his great work. The remaining Books beginning with Book V are devoted to more specialized investigation of particular parts of the subject. It is only for a very small portion of the *content* of the treatise that Apollonius claims originality; in the first three Books the claim is confined to certain propositions bearing on the 'locus with respect to three or four lines'; and in the fourth Book (on the number of points at which two conics

may intersect, touch, or both) the part which is claimed as new is the extension to the intersections of the parabola, ellipse, and circle with the double-branch hyperbola, and of two double-branch hyperbolas with one another, of the investigations which had theretofore only taken account of the single-branch hyperbola. Even in Book V, the most remarkable of all, Apollonius does not say that normals as 'the shortest lines' had not been considered before, but only that they had been superficially touched upon, doubtless in connexion with propositions dealing with the tangent properties. He explains that he found it convenient to treat of the tangent properties, without any reference to normals, in the first Book in order to connect them with the chord properties. It is clear, therefore, that in treating normals as *maxima* and *minima*, and by themselves, without any reference to tangents, as he does in Book V, he was making an innovation; and, in view of the extent to which the theory of normals as *maxima* and *minima* is developed by him (in 77 propositions), there is no wonder that he should devote a whole Book to the subject. Apart from the developments in Books III, IV, V, just mentioned, and the numerous new propositions in Book VII with the problems thereon which formed the lost Book VIII, Apollonius only claims to have treated the whole subject more fully and generally than his predecessors.

Great generality of treatment from the beginning.

So far from being a braggart and taking undue credit to himself for the improvements which he made upon his predecessors, Apollonius is, if anything, too modest in his description of his personal contributions to the theory of conic sections. For the 'more fully and generally' of his first preface scarcely conveys an idea of the extreme generality with which the whole subject is worked out. This characteristic generality appears at the very outset.

Analysis of the *Conics*.

Book I.

Apollonius begins by describing a double oblique circular cone in the most general way. Given a circle and any point outside the plane of the circle and in general not lying on the



THIS PAGE IS LOCKED TO FREE MEMBERS

Purchase full membership to immediately unlock this page

DELVE INTO FANTASY, MAGIC, MYTHOLOGY & FOLKLORE

Forgotten Books'
Full Membership gives
access to 797,885 ancient
and modern, fiction and
non-fiction books.

Continue

*Fair usage policy applies

the centre of the circular base. After proving that all sections parallel to the base are also circles, and that there is another set of circular sections subcontrary to these, he proceeds to consider sections of the cone drawn in any manner. Taking any triangle through the axis (the base of the triangle being consequently a diameter of the circle which is the base of the cone), he is careful to make his section cut the base in a straight line perpendicular to the particular diameter which is the base of the axial triangle. (There is no loss of generality in this, for, if any section is taken, without reference to any axial triangle, we have only to select the particular axial triangle the base of which is that diameter of the circular base which is at right angles to the straight line in which the section of the cone cuts the base.) Let ABC be any axial triangle, and let any section whatever cut the base in a straight line DE at right angles to BC ; if then PM be the intersection of the cutting plane and the axial triangle, and if QQ' be any chord in the section parallel to DE , Apollonius proves that QQ' is bisected by PM . In other words, PM is a *diameter* of the section. Apollonius is careful to explain that,

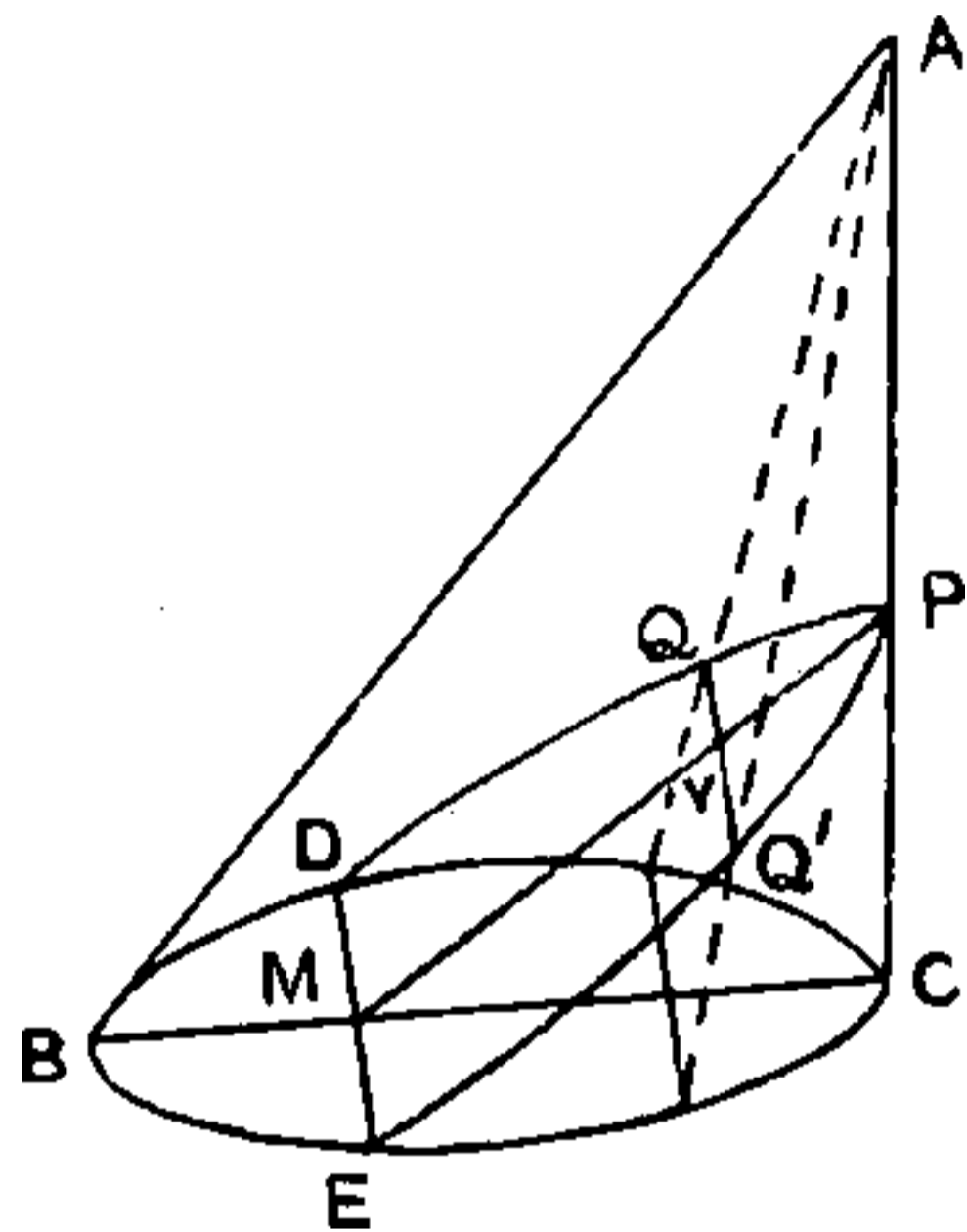

‘if the cone is a right cone, the straight line in the base (DE) will be at right angles to the common section (PM) of the cutting plane and the triangle through the axis, but, if the cone is scalene, it will not in general be at right angles to PM , but will be at right angles to it only when the plane through the axis (i.e. the axial triangle) is at right angles to the base of the cone’ (I. 7).

That is to say, Apollonius works out the properties of the conics in the most general way with reference to a diameter which is not one of the principal diameters or axes, but in general has its ordinates obliquely inclined to it. The axes do not appear in his exposition till much later, after it has been shown that each conic has the same property with reference to any diameter as it has with reference to the original diameter arising out of the construction; the axes then appear

as particular cases of the new diameter of reference. The three sections, the parabola, hyperbola, and ellipse are made in the manner shown in the figures. In each case they pass

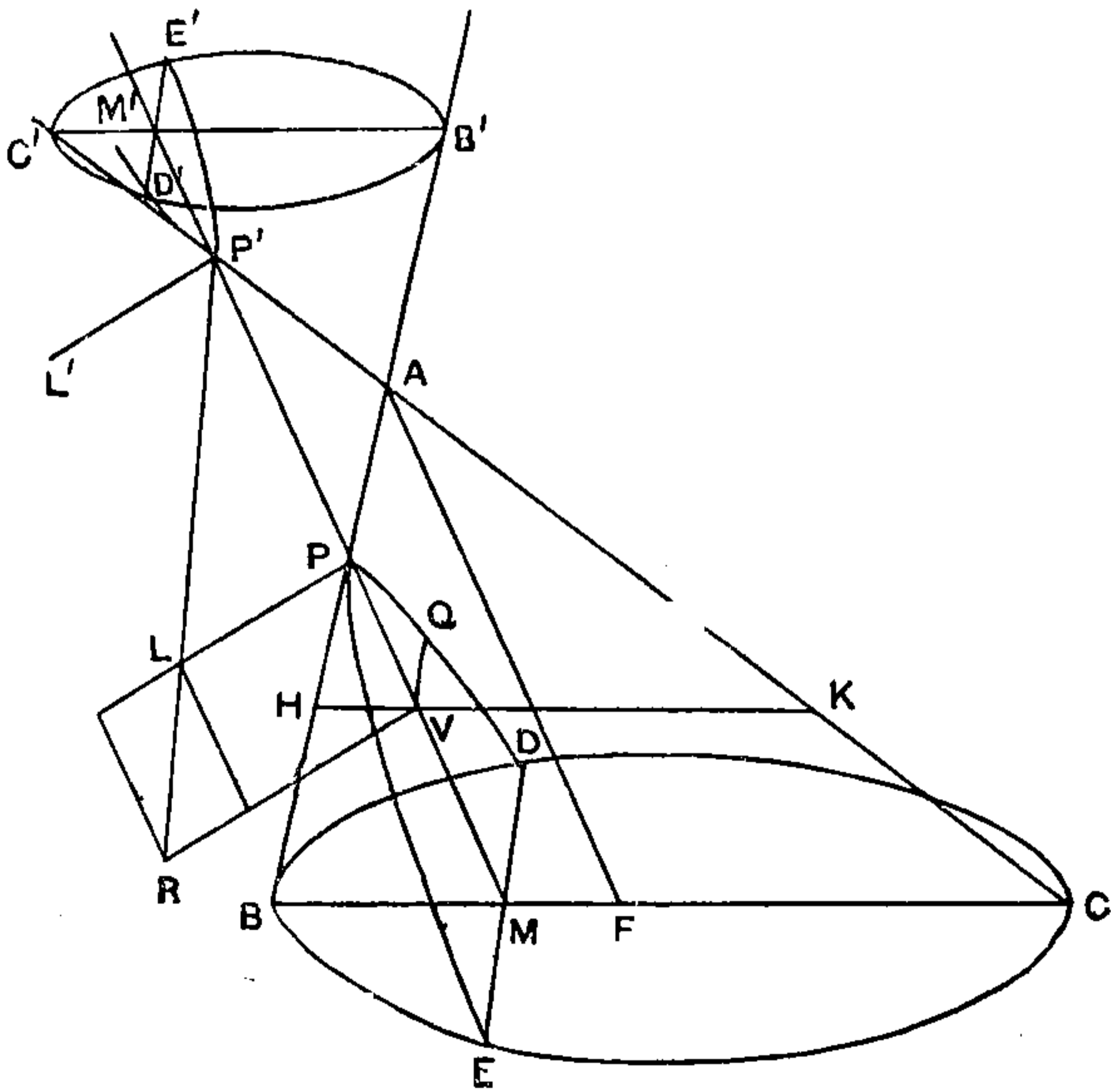
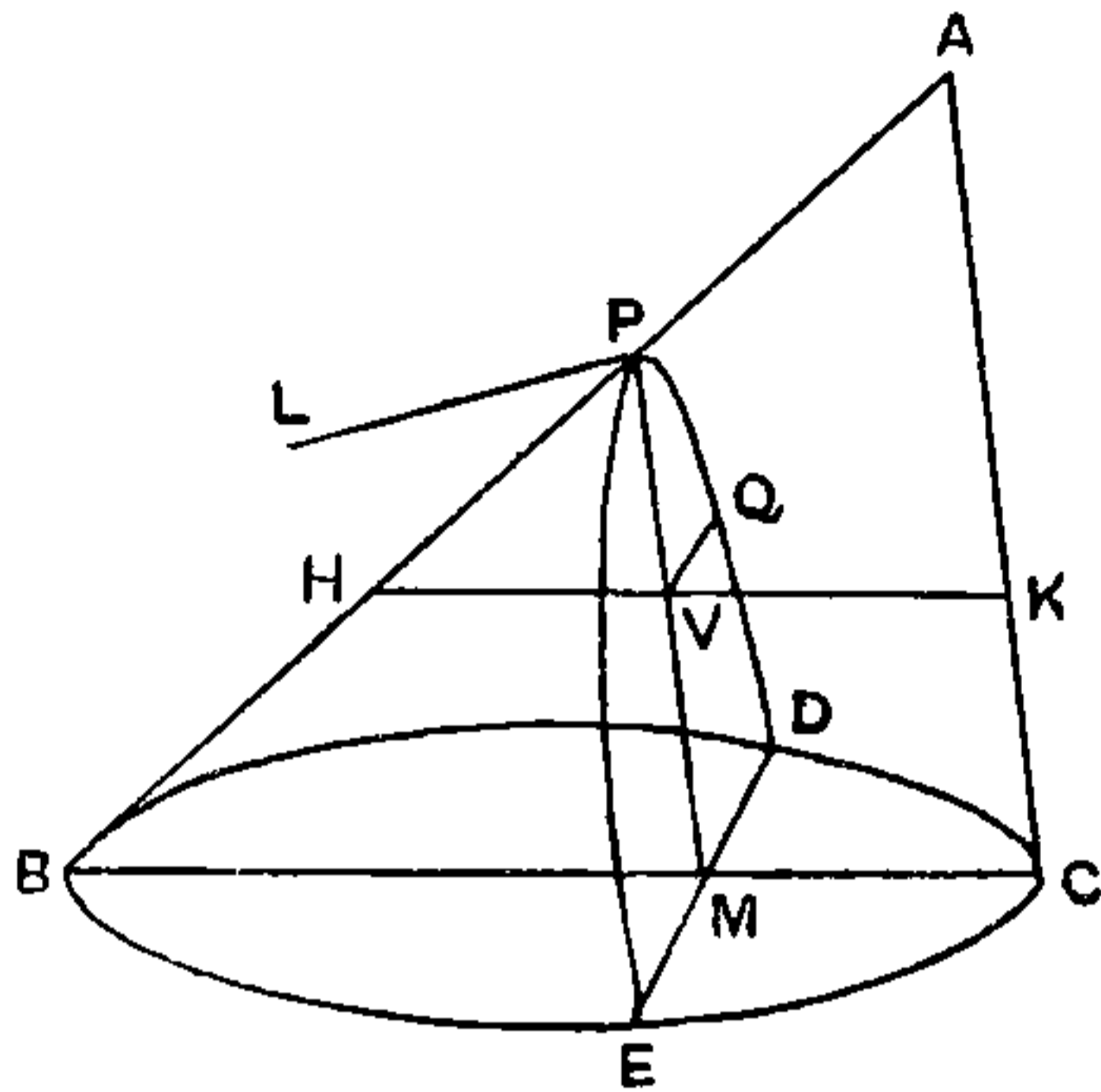

through a straight line DE in the plane of the base which is at right angles to BC , the base of the axial triangle, or to BC produced. The diameter PM is in the case of the

parabola parallel to AC ; in the case of the hyperbola it meets the other half of the double cone in P' ; and in the case of the ellipse it meets the cone itself again in P' . We draw, in

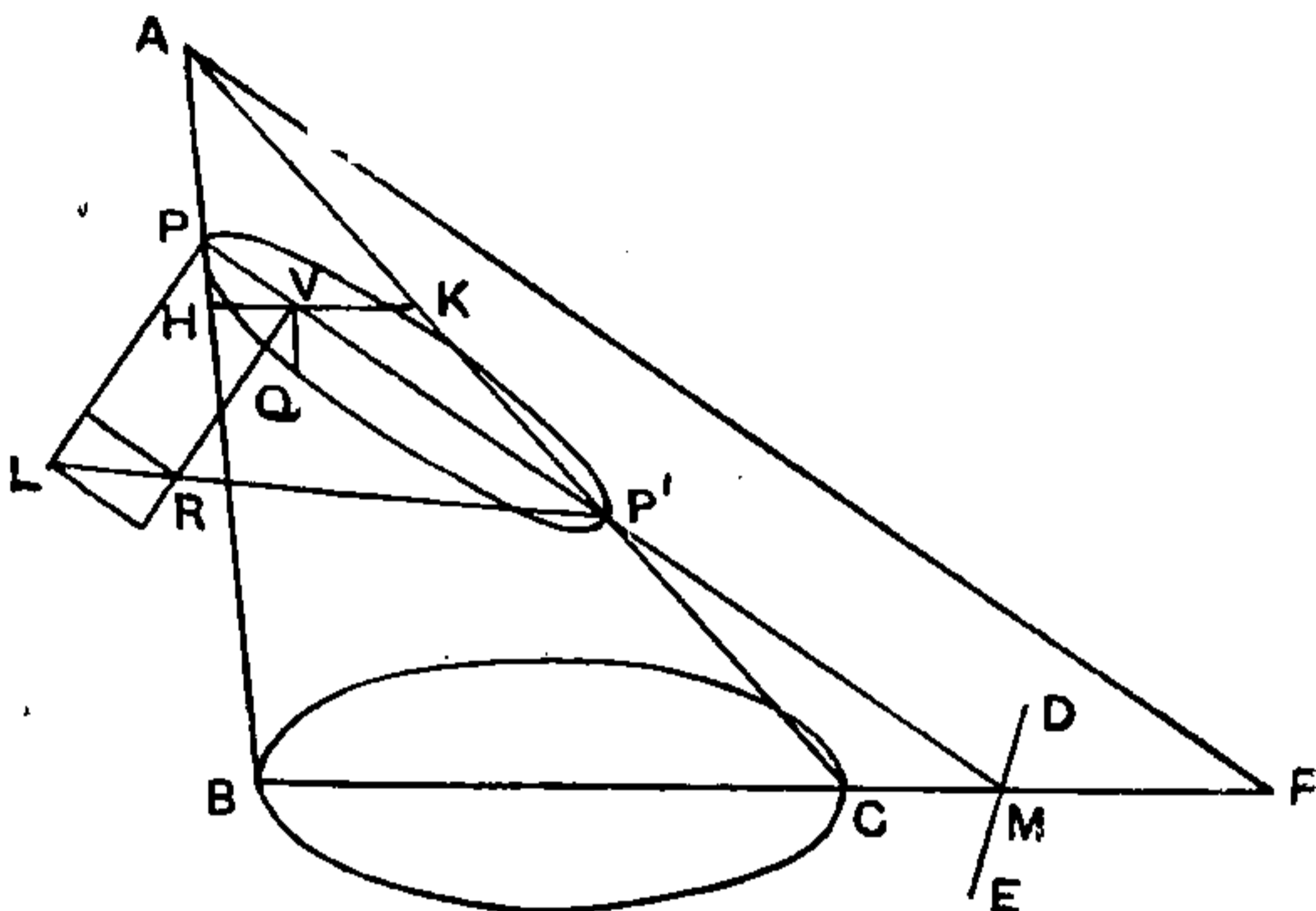

the cases of the hyperbola and ellipse, AF parallel to PM to meet BC or BC produced in F .

Apollonius expresses the properties of the three curves by means of a certain straight line PL drawn at right angles to PM in the plane of the section.

In the case of the parabola, PL is taken such that

$$PL : PA = BC^2 : BA \cdot AC;$$

and in the case of the hyperbola and ellipse such that

$$PL : PP' = BF \cdot FC : AF^2.$$

In the latter two cases we join $P'L$, and then draw VR parallel to PL to meet $P'L$, produced if necessary, in R .

If HK be drawn through V parallel to BC and meeting AB, AC in H, K respectively, HK is the diameter of the circular section of the cone made by a plane parallel to the base.

Therefore
$$QV^2 = HV \cdot VK.$$

Then (1) for the parabola we have, by parallels and similar triangles,

$$HV : PV = BC : CA,$$

and

$$VK : PA = BC : BA.$$



THIS PAGE IS LOCKED TO FREE MEMBERS

Purchase full membership to immediately unlock this page

FORGOTTEN BOOKS

FULL

MEMBERSHIP

797,885 Books!

All you can read

for only

\$8.99/month

Continue

*Fair usage policy applies



PL is called the *latus rectum* (ὀρθία) or the *parameter of the ordinates* (παρ' ἣν δύνανται αἱ καταγόμεναι τεταγμένως) in each case. In the case of the central conics, the diameter PP' is the *transverse* (ἡ πλαγία) or *transverse diameter*; while, even more commonly, Apollonius speaks of the diameter and the corresponding parameter together, calling the latter the *latus rectum* or *erect side* (ὀρθία πλευρά) and the former the *transverse side* of the figure (εἶδος) on, or applied to, the diameter.

Fundamental properties equivalent to Cartesian equations.

If p is the parameter, and d the corresponding diameter, the properties of the curves are the equivalent of the Cartesian equations, referred to the diameter and the tangent at its extremity as axes (in general oblique),

$$y^2 = px \text{ (the parabola),}$$

$$y^2 = px \pm \frac{p}{d} x^2 \text{ (the hyperbola and ellipse respectively).}$$

Thus Apollonius expresses the fundamental property of the central conics, like that of the parabola, as an equation between areas, whereas in Archimedes it appears as a proportion

$$y^2 : (a^2 \pm x^2) = b^2 : a^2,$$

which, however, is equivalent to the Cartesian equation referred to axes with the centre as origin. The latter property with reference to the original diameter is separately proved in I. 21, to the effect that QV^2 varies as $PV \cdot P'V$, as is really evident from the fact that $QV^2 : PV \cdot P'V = PL : PP'$, seeing that $PL : PP'$ is constant for any fixed diameter PP' .

Apollonius has a separate proposition (I. 14) to prove that the opposite branches of a hyperbola have the same diameter and equal *latera recta* corresponding thereto. As he was the first to treat the double-branch hyperbola fully, he generally discusses the *hyperbola* (i.e. the single branch) along with the ellipse, and *the opposites*, as he calls the double-branch hyperbola, separately. The properties of the single-branch hyperbola are, where possible, included in one enunciation with those of the ellipse and circle, the enunciation beginning,

‘ If in a hyperbola, an ellipse, or the circumference of a circle ’ ; sometimes, however, the double-branch hyperbola and the ellipse come in one proposition, e.g. in I. 30: ‘ If in an ellipse or the opposites (i. e. the double hyperbola) a straight line be drawn through the centre meeting the curve on both sides of the centre, it will be bisected at the centre.’ The property of conjugate diameters in an ellipse is proved in relation to the original diameter of reference and its conjugate in I. 15, where it is shown that, if DD' is the diameter conjugate to PP' (i.e. the diameter drawn ordinate-wise to PP'), just as PP' bisects all chords parallel to DD' , so DD' bisects all chords parallel to PP' ; also, if DL' be drawn at right angles to DD' and such that $DL' \cdot DD' = PP'^2$ (or DL' is a third proportional to DD' , PP'), then the ellipse has the same property in relation to DD' as diameter and DL' as parameter that it has in relation to PP' as diameter and PL as the corresponding parameter. Incidentally it appears that $PL \cdot PP' = DD'^2$, or PL is a third proportional to PP' , DD' , as indeed is obvious from the property of the curve $QV^2 : PV \cdot PV' = PL : PP' = DD'^2 : PP'^2$. The next proposition, I. 16, introduces the *secondary diameter* of the double-branch hyperbola (i.e. the diameter conjugate to the transversè diameter of reference), which does not meet the curve; this diameter is defined as that straight line drawn through the centre parallel to the ordinates of the transverse diameter which is bisected at the centre and is of length equal to the mean proportional between the ‘ sides of the figure ’, i.e. the transverse diameter PP' and the corresponding parameter PL . The *centre* is defined as the middle point of the diameter of reference, and it is proved that all other diameters are bisected at it (I. 30).

Props. 17–19, 22–9, 31–40 are propositions leading up to and containing the tangent properties. On lines exactly like those of Eucl. III. 16 for the circle, Apollonius proves that, if a straight line is drawn through the vertex (i.e. the extremity of the diameter of reference) parallel to the ordinates to the diameter, it will fall outside the conic, and no other straight line can fall between the said straight line and the conic; therefore the said straight line touches the conic (I. 17, 32). Props. I. 33, 35 contain the property of the tangent at any point on the parabola, and Props. I. 34, 36 the property of

the tangent at any point of a central conic, in relation to the original diameter of reference; if Q is the point of contact, QV the ordinate to the diameter through P , and if QT , the tangent at Q , meets the diameter produced in T , then (1) for the parabola $PV = PT$, and (2) for the central conic $TP:TP' = PV:VP'$. The method of proof is to take a point T on the diameter produced satisfying the respective relations, and to prove that, if TQ be joined and produced, any point on TQ on either side of Q is outside the curve: the form of proof is by *reductio ad absurdum*, and in each case it is again proved that no other straight line can fall between TQ and the curve. The fundamental property $TP:TP' = PV:VP'$ for the central conic is then used to prove that $CV \cdot CT = CP^2$ and $QV^2:CV \cdot VT = p:PP'$ (or $CD^2:CP^2$) and the corresponding properties with reference to the diameter DD' conjugate to PP' and v, t , the points where DD' is met by the ordinate to it from Q and by the tangent at Q respectively (Props. I. 37–40).

Transition to new diameter and tangent at its extremity.

An important section of the Book follows (I. 41–50), consisting of propositions leading up to what amounts to a transformation of coordinates from the original diameter and the tangent at its extremity to *any* diameter and the tangent at its extremity; what Apollonius proves is of course that, if *any* other diameter be taken, the ordinate-property of the conic with reference to that diameter is of the same form as it is with reference to the original diameter. It is evident that this is vital to the exposition. The propositions leading up to the result in I. 50 are not usually given in our text-books of geometrical conics, but are useful and interesting.

Suppose that the tangent at any point Q meets the diameter of reference PV in T , and that the tangent at P meets the diameter through Q in E . Let R be any third point on the curve; let the ordinate RW to PV meet the diameter through Q in F , and let RU parallel to the tangent at Q meet PV in U . Then

(1) in the parabola, the triangle $R UW =$ the parallelogram EW , and



THIS PAGE IS LOCKED TO FREE MEMBERS

Purchase full membership to immediately unlock this page

DELVE INTO FANTASY, MAGIC, MYTHOLOGY & FOLKLORE

Forgotten Books'
Full Membership gives
access to 797,885 ancient
and modern, fiction and
non-fiction books.

Continue

*Fair usage policy applies

(2) in the hyperbola or ellipse, $\Delta RUW =$ the difference between the triangles CFW and CPE .

$$\begin{aligned} (1) \text{ In the parabola } \Delta RUW : \Delta QTV &= RW^2 : QV^2 \\ &= PW : PV \\ &= \square EW : \square EV. \end{aligned}$$

But, since $TV = 2PV$, $\Delta QTV = \square EV$;

therefore $\Delta RUW = \square EW$.

(2) The proof of the proposition with reference to the central conic depends on a Lemma, proved in I. 41, to the effect that, if PX , VY be similar parallelograms on CP , CV as bases, and if VZ be an equiangular parallelogram on QV as base and such that, if the ratio of CP to the other side of PX is m , the ratio of QV to the other side of VZ is $m \cdot p / PP'$, then VZ is equal to the difference between VY and PX . The proof of the Lemma by Apollonius is difficult, but the truth of it can be easily seen thus.

By the property of the curve, $QV^2 : CV^2 \sim CP^2 = p : PP'$;

$$\text{therefore } CV^2 \sim CP^2 = \frac{PP'}{p} \cdot QV^2.$$

Now $\square PX = \mu \cdot CP^2 / m$, where μ is a constant depending on the angle of the parallelogram.

Similarly

$$\square VY = \mu \cdot CV^2 / m, \text{ and } \square VZ = \mu \cdot \frac{PP'}{p} QV^2 / m.$$

It follows that $\square VY \sim \square PX = \square VZ$.

Taking now the triangles CFW , CPE and RUW in the ellipse or hyperbola, we see that CFW , CPE are similar, and RUW has one angle (at W) equal or supplementary to the angles at P and V in the other two triangles, while we have

$$QV^2 : CV \cdot VT = p : PP',$$

whence $QV : VT = (p : PP') \cdot (CV : QV)$,

and, by parallels,

$$RW : WU = (p : PP') \cdot (CP : PE).$$

Therefore RUW , CPE , CFW are the halves of parallelograms related as in the lemma;

therefore $\Delta RUW = \Delta CFW \sim \Delta CPE$.

The same property with reference to the diameter *secondary* to CPV is proved in I. 45.

It is interesting to note the exact significance of the property thus proved for the central conic. The proposition, which is the foundation of Apollonius's method of transformation of coordinates, amounts to this. If CP , CQ are fixed semi-diameters and R a variable point, the area of the quadrilateral $CFRU$ is constant for all positions of R on the conic. Suppose now that CP , CQ are taken as axes of x and y respectively. If we draw RX parallel to CQ to meet CP and RY parallel to CP to meet CQ , the proposition asserts that (subject to the proper convention as to sign)

$$\Delta RYF + \square CXRY + \Delta RXU = (\text{const.}).$$

But since RX , RY , RF , RU are in fixed directions,

ΔRYF varies as RY^2 or x^2 , $\square CXRY$ as $RX \cdot RY$ or xy , and ΔRXU as RX^2 or y^2 .

Hence, if x , y are the coordinates of R ,

$$\alpha x^2 + \beta xy + \gamma y^2 = A,$$

which is the Cartesian equation of the conic referred to the centre as origin and any two diameters as axes.

The properties so obtained are next used to prove that, if UR meets the curve again in R' and the diameter through Q in M , then RR' is bisected at M . (I. 46–8).

Taking (1) the case of the parabola, we have,

$$\Delta RUW = \square EW,$$

and $\Delta R'UW' = \square EW'$.

By subtraction, $(RWW'R') = \square F'W$,

whence $\Delta RFM = \Delta R'F'M$,

and, since the triangles are similar, $RM = R'M$.

The same result is easily obtained for the central conic.

It follows that EQ produced in the case of the parabola,

or CQ in the case of the central conic, bisects all chords as RR' parallel to the tangent at Q . Consequently EQ and CQ are *diameters* of the respective conics.

In order to refer the conic to the new diameter and the corresponding ordinates, we have only to determine the *parameter* of these ordinates and to show that the property of the conic with reference to the new parameter and diameter is in the same form as that originally found.

The propositions I. 49, 50 do this, and show that the new parameter is in all the cases p' , where (if O is the point of intersection of the tangents at P and Q)

$$OQ : QE = p' : 2QT.$$

(1) In the case of the parabola, we have $TP = PV = EQ$,

whence
$$\triangle EOQ = \triangle POT.$$

Add to each the figure $POQF'W'$;

therefore
$$QTW'F' = \square EW' = \triangle R'UW',$$

whence, subtracting $MUW'F'$ from both, we have

$$\triangle R'MF' = \square QU.$$

Therefore
$$R'M \cdot MF' = 2QT \cdot QM.$$

But $R'M : MF' = OQ : QE = p' : 2QT$, by hypothesis;

therefore
$$R'M^2 : R'M \cdot MF' = p' \cdot QM : 2QT \cdot QM.$$

And $R'M \cdot MF' = 2QT \cdot QM$, from above;

therefore
$$R'M^2 = p' \cdot QM,$$

which is the desired property.¹

¹ The proposition that, in the case of the parabola, if p be the parameter of the ordinates to the diameter through Q , then (see the first figure on p. 142)

$$OQ : QE = p : 2QT$$

has an interesting application; for it enables us to prove the proposition, assumed without proof by Archimedes (but not easy to prove otherwise), that, if in a parabola the diameter through P bisects the chord QQ' in V , and QD is drawn perpendicular to PV , then

$$QV^2 : QD^2 = p : p_a,$$



THIS PAGE IS LOCKED TO FREE MEMBERS

Purchase full membership to immediately unlock this page

FORGOTTEN BOOKS

FULL

MEMBERSHIP

797,885 Books!

All you can read

for only

\$8.99/month

Continue

*Fair usage policy applies



It follows that

$$QM(QH + MN) : QM(QT + MU) = R'M^2 : R'M \cdot MF' ;$$

but, from above, $QM(QT + MU) = R'M \cdot MF' ;$

$$\begin{aligned} \text{therefore} \quad R'M^2 &= QM(QH + MN) \\ &= QM \cdot MK, \end{aligned}$$

which is the desired property.

In the case of the hyperbola, the same property is true for the opposite branch.

These important propositions show that the ordinate property of the three conics is of the same form whatever diameter is taken as the diameter of reference. It is therefore a matter of indifference to which particular diameter and ordinates the conic is referred. This is stated by Apollonius in a summary which follows I. 50.

First appearance of principal axes.

The *axes* appear for the first time in the propositions next following (I. 52–8), where Apollonius shows how to construct each of the conics, given in each case (1) a diameter, (2) the length of the corresponding parameter, and (3) the inclination of the ordinates to the diameter. In each case Apollonius first assumes the angle between the ordinates and the diameter to be a right angle; then he reduces the case where the angle is oblique to the case where it is right by his method of transformation of coordinates; i.e. from the given diameter and parameter he *finds* the *axis* of the conic and the length of the corresponding parameter, and he then constructs the conic as in the first case where the ordinates are at right angles to the diameter. Here then we have a case of the proof of *existence* by means of *construction*. The conic is in each case constructed by finding the cone of which the given conic is a section. The problem of finding the axis of a parabola and the centre and the axes of a central conic when the conic (and not merely the elements, as here) is given comes later (in II. 44–7), where it is also proved (II. 48) that no central conic can have more than two axes.

It has been my object, by means of the above detailed account of Book I, to show not merely what results are obtained by Apollonius, but the way in which he went to work; and it will have been realized how entirely scientific and general the method is. When the foundation is thus laid, and the fundamental properties established, Apollonius is able to develop the rest of the subject on lines more similar to those followed in our text-books. My description of the rest of the work can therefore for the most part be confined to a summary of the contents.

Book II begins with a section devoted to the properties of the asymptotes. They are constructed in II. 1 in this way. Beginning, as usual, with *any* diameter of reference and the corresponding parameter and inclination of ordinates, Apollonius draws at P the vertex (the extremity of the diameter) a tangent to the hyperbola and sets off along it lengths PL, PL' on either side of P such that $PL^2 = PL'^2 = \frac{1}{4} p \cdot PP'$ [$= CD^2$], where p is the parameter. He then proves that CL, CL' produced will not meet the curve in any finite point and are therefore *asymptotes*. II. 2 proves further that no straight line through C within the angle between the asymptotes can itself be an asymptote. II. 3 proves that the intercept made by the asymptotes on the tangent at any point P is bisected at P , and that the square on each half of the intercept is equal to one-fourth of the 'figure' corresponding to the diameter through P (i.e. one-fourth of the rectangle contained by the 'erect' side, the *latus rectum* or parameter corresponding to the diameter, and the diameter itself); this property is used as a means of drawing a hyperbola when the asymptotes and one point on the curve are given (II. 4). II. 5–7 are propositions about a tangent at the extremity of a diameter being parallel to the chords bisected by it. Apollonius returns to the asymptotes in II. 8, and II. 8–14 give the other ordinary properties with reference to the asymptotes (II. 9 is a converse of II. 3), the equality of the intercepts between the asymptotes and the curve of any chord (II. 8), the equality of the rectangle contained by the distances between either point in which the chord meets the curve and the points of intersection with the asymptotes to the square on the parallel semi-diameter (II. 10), the latter property with reference to

the portions of the asymptotes which include between them a branch of the conjugate hyperbola (II. 11), the constancy of the rectangle contained by the straight lines drawn from any point of the curve in fixed directions to meet the asymptotes (equivalent to the Cartesian equation with reference to the asymptotes, $xy = \text{const.}$) (II. 12), and the fact that the curve and the asymptotes proceed to infinity and approach continually nearer to one another, so that the distance separating them can be made smaller than any given length (II. 14). II. 15 proves that the two opposite branches of a hyperbola have the same asymptotes and II. 16 proves for the chord connecting points on two branches the property of II. 8. II. 17 shows that 'conjugate opposites' (two conjugate double-branch hyperbolas) have the same asymptotes. Propositions follow about conjugate hyperbolas; any tangent to the conjugate hyperbola will meet both branches of the original hyperbola and will be bisected at the point of contact (II. 19); if Q be any point on a hyperbola, and CE parallel to the tangent at Q meets the conjugate hyperbola in E , the tangent at E will be parallel to CQ and CQ, CE will be conjugate diameters (II. 20), while the tangents at Q, E will meet on one of the asymptotes (II. 21); if a chord Qq in one branch of a hyperbola meet the asymptotes in R, r and the conjugate hyperbola in Q', q' , then $Q'Q \cdot Qq' = 2CD^2$ (II. 23). Of the rest of the propositions in this part of the Book the following may be mentioned: if TQ, TQ' are two tangents to a conic and V is the middle point of QQ' , TV is a diameter (II. 29, 30, 38); if tQ, tQ' be tangents to opposite branches of a hyperbola, RR' the chord through t parallel to QQ' , v the middle point of QQ' , then vR, vR' are tangents to the hyperbola (II. 40); in a conic, or a circle, or in conjugate hyperbolas, if two chords not passing through the centre intersect, they do not bisect each other (II. 26, 41, 42). II. 44–7 show how to find a diameter of a conic and the centre of a central conic, the axis of a parabola and the axes of a central conic. The Book concludes with problems of drawing tangents to conics in certain ways, through any point on or outside the curve (II. 49), making with the axis an angle equal to a given acute angle (II. 50), making a given angle with the diameter through the point of contact (II. 51, 53); II. 52 contains a *διορισμός* for



THIS PAGE IS LOCKED TO FREE MEMBERS

Purchase full membership to immediately unlock this page

DELVE INTO FANTASY, MAGIC, MYTHOLOGY & FOLKLORE

Forgotten Books'
Full Membership gives
access to 797,885 ancient
and modern, fiction and
non-fiction books.

Continue

*Fair usage policy applies

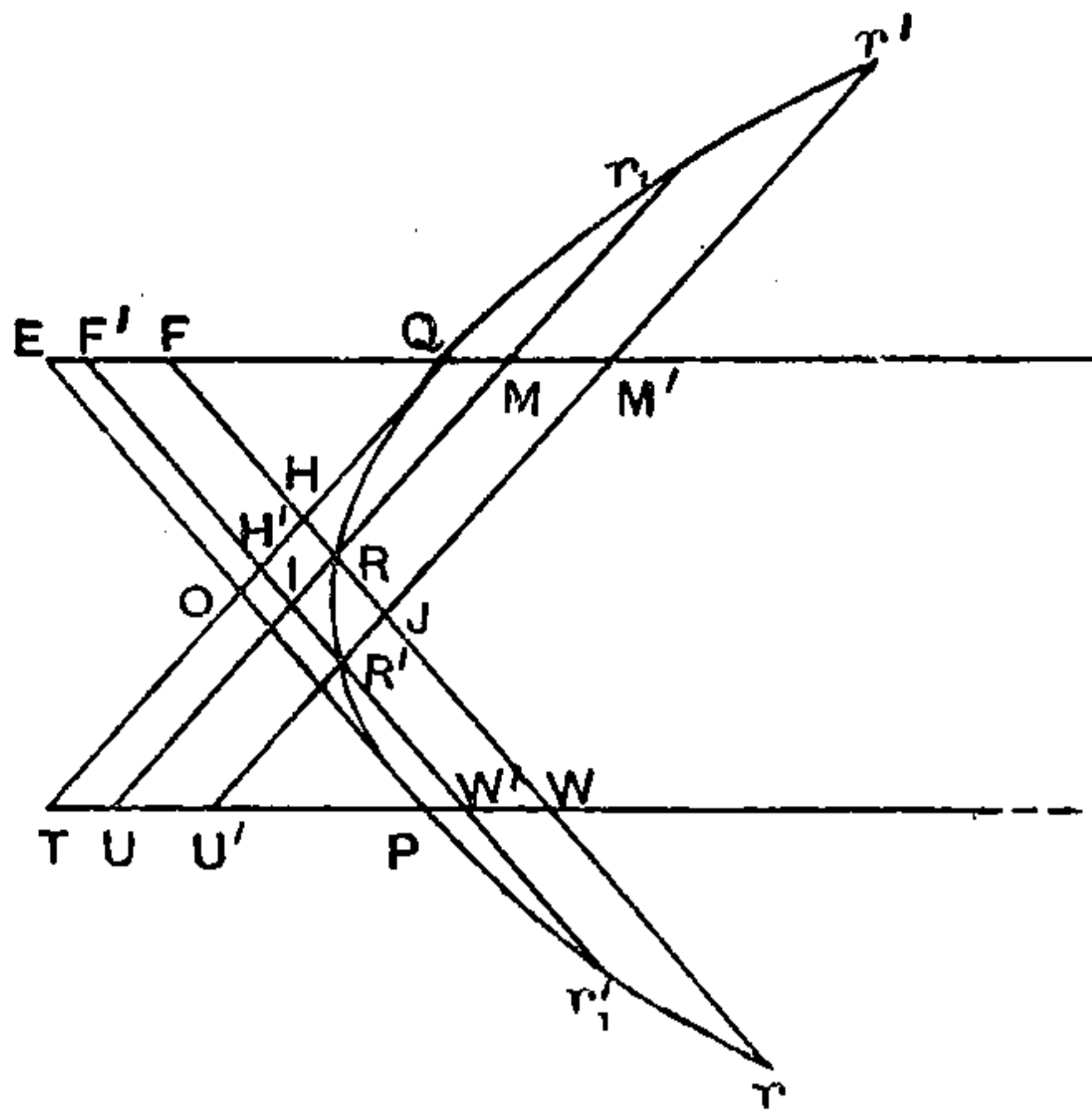

FIG. 1.

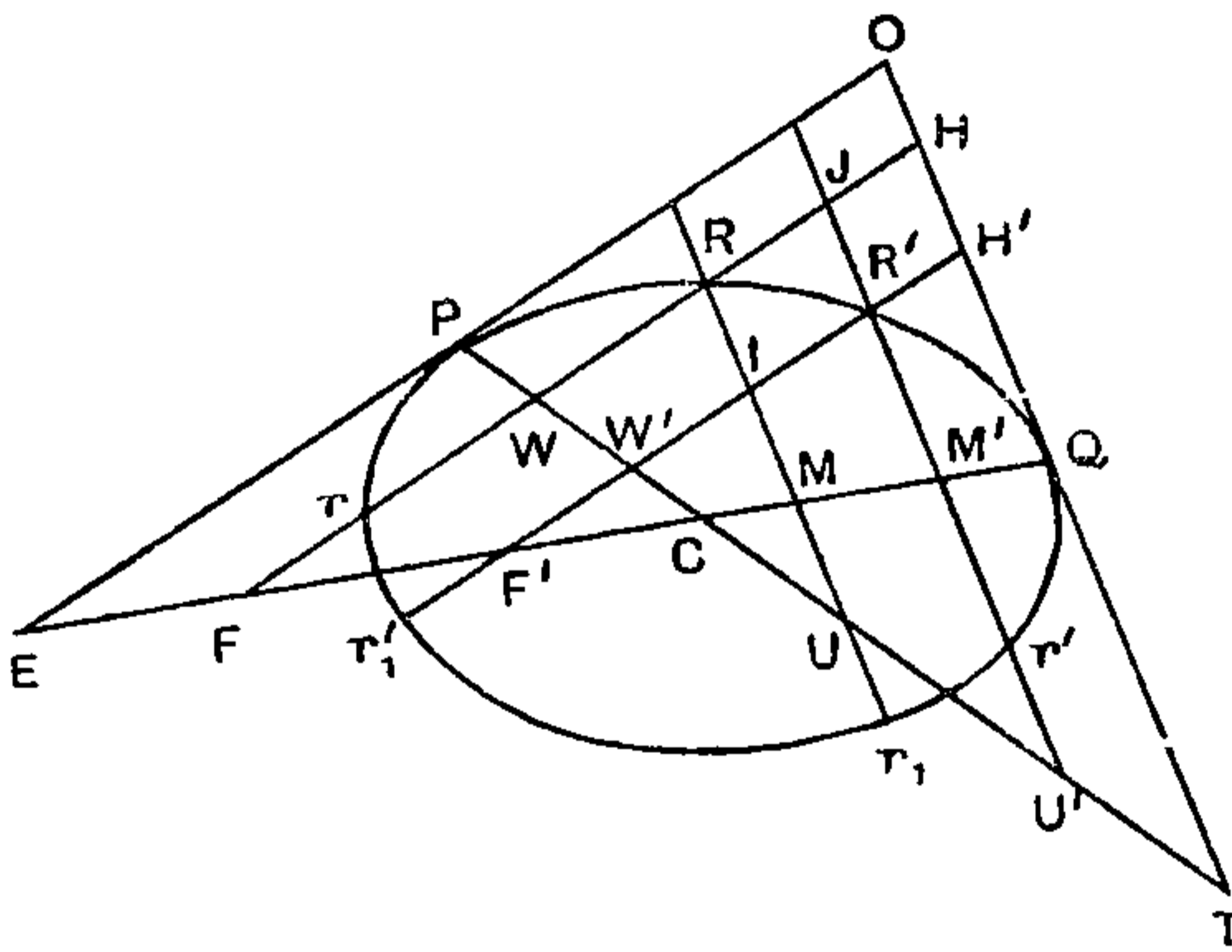

FIG. 2.

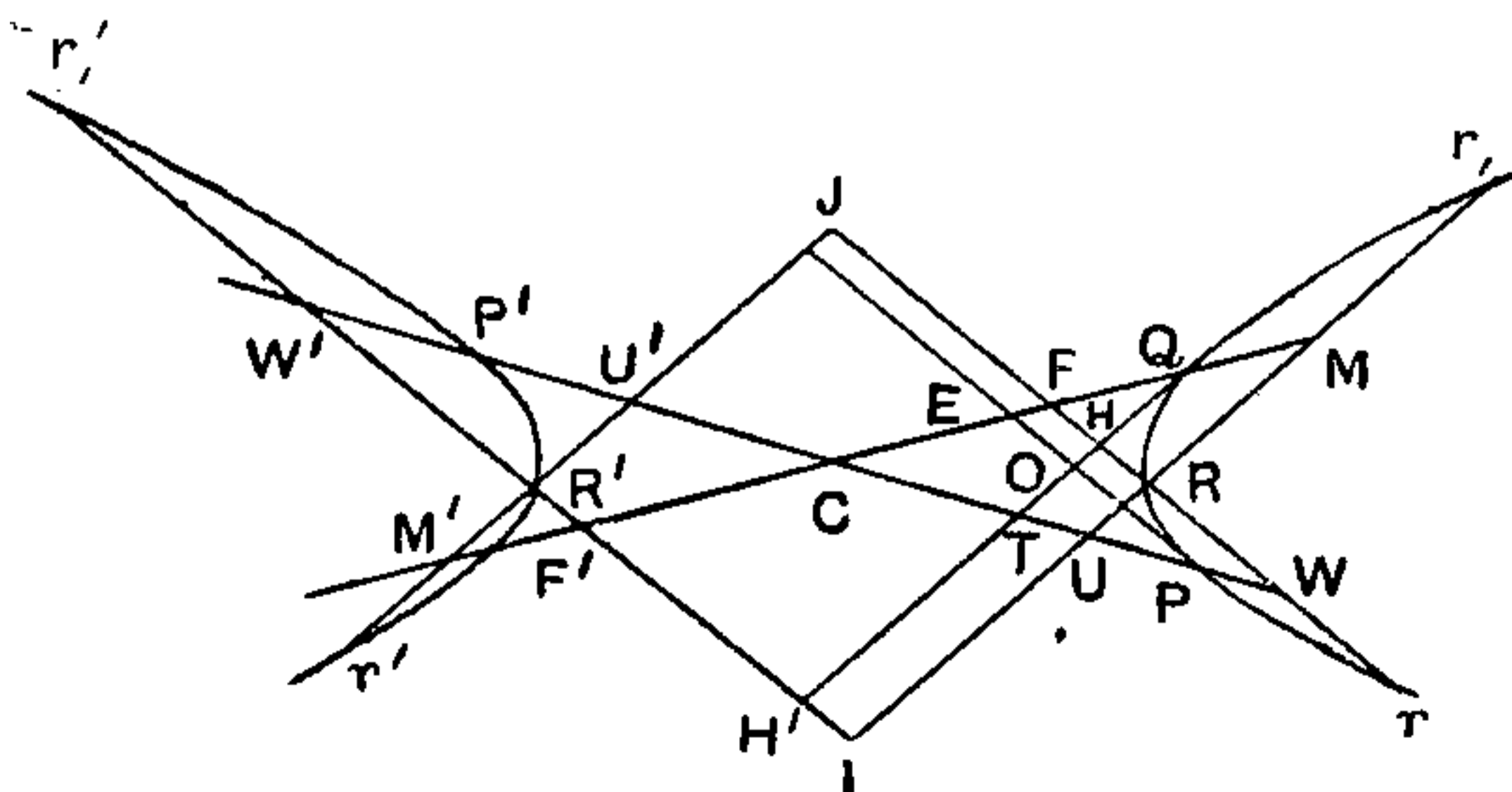

FIG. 3.

Adding the quadrilateral $CF'H'T$, we have

$$\Delta H'F'Q = H'TU'R',$$

and similarly $\Delta HFQ = HTUR$.

By subtraction, $F'H'HF = H'TU'R' - HTUR$.

Adding $H'IRH$ to each side, we have

$$F'IRF = IUU'R'.$$

If each of these quadrilaterals is subtracted from IJ ,

$$FJR'F' = JU'UR.$$

The corresponding results are proved in III. 5, 11, 12, 14 for the case where the ordinates through RR' are drawn to a *secondary* diameter, and in III. 15 for the case where P, Q are on the original hyperbola and R, R' on the conjugate hyperbola.

The importance of these propositions lies in the fact that they are immediately used to prove the well-known theorems about the rectangles contained by the segments of intersecting chords and the harmonic properties of the pole and polar. The former question is dealt with in III. 16–23, which give a great variety of particular cases. We will give the proof of one case, to the effect that, if OP, OQ be two tangents to any conic and $Rr, R'r'$ be any two chords parallel to them respectively and intersecting in J , an internal or external point,

then $RJ \cdot Jr : R'J \cdot Jr' = OP^2 : OQ^2 = (\text{const.})$.

We have

$$RJ \cdot Jr = RW^2 \sim JW^2, \text{ and } RW^2 : JW^2 = \Delta RUW : \Delta JU'W;$$

therefore

$$RJ \cdot Jr : RW^2 = (RW^2 \sim JW^2) : RW^2 = JU'UR : \Delta RUW.$$

$$\text{But } RW^2 : OP^2 = \Delta RUW : \Delta OPT;$$

therefore, *ex aequali*, $RJ \cdot Jr : OP^2 = JU'UR : \Delta OPT$.

Similarly $R'M'^2 : JM'^2 = \Delta R'F'M' : \Delta JFM'$,

whence $R'J \cdot Jr' : R'M'^2 = FJR'F' : \Delta R'F'M'$.

But $R'M'^2 : OQ^2 = \Delta R'F'M' : \Delta OQE$;

therefore, *ex aequali*, $R'J \cdot Jr' : OQ^2 = FJR'F' : \Delta OQE$.

It follows, since $FJR'F' = JU'UR$, and $\Delta OPT = \Delta OQE$,
that $RJ \cdot Jr : OP^2 = R'J \cdot Jr' : OQ^2$,

or $RJ \cdot Jr : R'J \cdot Jr' = OP^2 : OQ^2$.

If we had taken chords $Rr_1, R'r'_1$ parallel respectively to OQ, OP and intersecting in I , an internal or external point, we should have in like manner

$$RI \cdot Ir_1 : R'I \cdot Ir'_1 = OQ^2 : OP^2.$$

As a particular case, if PP' be a diameter, and $Rr, R'r'$ be chords parallel respectively to the tangent at P and the diameter PP' and intersecting in I , then (as is separately proved)

$$RI \cdot Ir : R'I \cdot Ir' = p : PP'.$$

The corresponding results are proved in the cases where certain of the points lie on the conjugate hyperbola.

The six following propositions about the segments of intersecting chords (III. 24–9) refer to two chords in conjugate hyperbolas or in an ellipse drawn parallel respectively to two conjugate diameters PP', DD' , and the results in modern form are perhaps worth quoting. If $Rr, R'r'$ be two chords so drawn and intersecting in O , then

(a) in the conjugate hyperbolas

$$\frac{RO \cdot Or}{CP^2} \pm \frac{R'O \cdot Or'}{CD^2} = 2,$$

and $(RO^2 + Or^2) : (R'O^2 + Or'^2) = CP^2 : CD^2$;

(b) in the ellipse

$$\frac{RO^2 + Or^2}{CP^2} + \frac{R'O^2 + Or'^2}{CD^2} = 4.$$



THIS PAGE IS LOCKED TO FREE MEMBERS

Purchase full membership to immediately unlock this page

FORGOTTEN BOOKS

FULL

MEMBERSHIP

797,885 Books!

All you can read

for only

\$8.99/month

Continue

*Fair usage policy applies



To prove (1) we have

$$R'I^2 : IR^2 = H'Q^2 : QH^2 = \Delta H'F'Q : \Delta HFQ = H'TU'R' : HTUR \quad (\text{III. 2, 3, \&c.}).$$

Also $R'T^2 : TR^2 = R'U'^2 : UR^2 = \Delta R'U'W' : \Delta RUW$,
 and $R'T^2 : TR^2 = TW'^2 : TW^2 = \Delta TH'W' : \Delta THW$,
 so that $R'T^2 : TR^2 = \Delta TH'W' \sim \Delta R'U'W' : \Delta THW \sim \Delta RUW$
 $= H'TU'R' : HTUR$
 $= R'I^2 : IR^2$, from above.

To prove (2) we have

$$RV^2 : VR'^2 = RU^2 : R'U'^2 = \Delta RUW : \Delta R'U'W',$$

and also

$$= HQ^2 : QH'^2 = \Delta HFQ : \Delta H'F'Q = HTUR^* : H'TU'R',$$

so that

$$RV^2 : VR'^2 = HTUR \pm \Delta RUW : H'TU'R' \pm \Delta R'U'W'$$

$$= \Delta THW : \Delta TH'W'$$

$$= TW^2 : TW'^2$$

$$= RO^2 : OR'^2.$$

Props. III. 30–6 deal separately with the particular cases in which (a) the transversal is parallel to an asymptote of the hyperbola or (b) the chord of contact is parallel to an asymptote, i.e. where one of the tangents is an asymptote, which is the tangent at infinity.

Next we have propositions about intercepts made by two tangents on a third: If the tangents at three points of a parabola form a triangle, all three tangents will be cut by the points of contact in the same proportion (III. 41); if the tangents at the extremities of a diameter PP' of a central conic are cut in r, r' by any other tangent, $Pr \cdot P'r' = CD^2$ (III. 42); if the tangents at P, Q to a hyperbola meet the asymptotes in

* Where a quadrilateral, as $HTUR$ in the figure, is a cross-quadrilateral, the area is of course the difference between the two triangles which it forms, as $HTW \sim RUW$.

L, L' and M, M' respectively, then $L'M, LM'$ are both parallel to PQ (III. 44).

The first of these propositions asserts that, if the tangents at three points P, Q, R of a parabola form a triangle pqr , then

$$Pr : rq = rQ : Qp = qp : pR.$$

From this property it is easy to deduce the Cartesian equation of a parabola referred to two fixed tangents as coordinate axes. Taking qR, qP as fixed coordinate axes, we find the locus of Q thus. Let x, y be the coordinates of Q . Then, if $qp = x_1, qr = y_1, qR = h, qP = k$, we have

$$\frac{x}{x_1 - x} = \frac{rQ}{Qp} = \frac{y_1 - y}{y} = \frac{k - y_1}{y_1} = \frac{x_1}{h - x_1}.$$

From these equations we derive

$$x_1^2 = hx, \quad y_1^2 = ky;$$

also, since $\frac{x_1}{x} = \frac{y_1}{y_1 - y}$, we have $\frac{x}{x_1} + \frac{y}{y_1} = 1$.

By substituting for x_1, y_1 the values \sqrt{hx}, \sqrt{ky} we obtain

$$\left(\frac{x}{h}\right)^{\frac{1}{2}} + \left(\frac{y}{k}\right)^{\frac{1}{2}} = 1.$$

The focal properties of central conics are proved in III. 45–52 without any reference to the directrix; there is no mention of the focus of a parabola. The foci are called ‘the points arising out of the application’ (*τὰ ἐκ τῆς παραβολῆς γινόμενα σημεία*), the meaning being that S, S' are taken on the axis AA' such that $AS \cdot SA' = AS' \cdot S'A' = \frac{1}{4}p_a \cdot AA'$ or CB^2 , that is, in the phraseology of application of areas, a rectangle is applied to AA' as base equal to one-fourth part of the ‘figure’, and in the case of the hyperbola exceeding, but in the case of the ellipse falling short, by a square figure. The foci being thus found, it is proved that, if the tangents $Ar, A'r'$ at the extremities of the axis are met by the tangent at any point P in r, r' respectively, rr' subtends a right angle at S, S' , and the angles $rr'S, A'r'S'$ are equal, as also are the angles $r'rS', ArS$ (III. 45, 46). It is next shown that, if O be the intersection of $rS', r'S$, then OP is perpendicular to the tangent at P (III. 47). These propositions are

used to prove that the focal distances of P make equal angles with the tangent at P (III. 48). In III. 49–52 follow the other ordinary properties, that, if SY be perpendicular to the tangent at P , the locus of Y is the circle on AA' as diameter, that the lines from C drawn parallel to the focal distances to meet the tangent at P are equal to CA , and that the sum or difference of the focal distances of any point is equal to AA' .

The last propositions of Book III are of use with reference to the locus with respect to three or four lines. They are as follows.

1. If PP' be a diameter of a central conic, and if $PQ, P'Q$ drawn to any other point Q of the conic meet the tangents at P', P in R', R respectively, then $PR \cdot P'R' = 4CD^2$ (III. 53).

2. If TQ, TQ' be two tangents to a conic, V the middle point of QQ' , P the point of contact of the tangent parallel to QQ' , and R any other point on the conic, let Qr parallel to TQ' meet $Q'R$ in r , and $Q'r'$ parallel to TQ meet QR in r' ; then

$$Qr \cdot Q'r' : QQ'^2 = (PV^2 : PT^2) \cdot (TQ \cdot TQ' : QV^2). \quad (\text{III. 54, 56.})$$

3. If the tangents are tangents to opposite branches of a hyperbola and meet in t , and if R, r, r' are taken as before, while tq is half the chord through t parallel to QQ' , then

$$Qr \cdot Q'r' : QQ'^2 = tQ \cdot tQ' : tq^2. \quad (\text{III. 55.})$$

The second of these propositions leads at once to the three-line locus, and from this we easily obtain the Cartesian equation to a conic with reference to two fixed tangents as axes, where the lengths of the tangents are h, k , viz.

$$\left(\frac{x}{h} + \frac{y}{k} - 1\right)^2 = 2\lambda \left(\frac{xy}{hk}\right)^{\frac{1}{2}}.$$

Book IV is on the whole dull, and need not be noticed at length. Props. 1–23 prove the converse of the propositions in Book III about the harmonic properties of the pole and polar for a large number of particular cases. One of the propositions (IV. 9) gives a method of drawing two tangents to a conic from an external point T . Draw any two straight lines through T cutting the conic in Q, Q' and in R, R' respec-



THIS PAGE IS LOCKED TO FREE MEMBERS

Purchase full membership to immediately unlock this page

DELVE INTO FANTASY, MAGIC, MYTHOLOGY & FOLKLORE

Forgotten Books'
Full Membership gives
access to 797,885 ancient
and modern, fiction and
non-fiction books.

Continue

*Fair usage policy applies

most remarkable of the extant Books. It deals with normals to conics regarded as *maximum* and *minimum* straight lines drawn from particular points to the curve. Included in it are a series of propositions which, though worked out by the purest geometrical methods, actually lead immediately to the determination of the evolute of each of the three conics; that is to say, the Cartesian equations to the evolutes can be easily deduced from the results obtained by Apollonius. There can be no doubt that the Book is almost wholly original, and it is a veritable geometrical *tour de force*.

Apollonius in this Book considers various points and classes of points with reference to the maximum or minimum straight lines which it is possible to draw from them to the conics, i. e. as the feet of normals to the curve. He begins naturally with points on the axis, and he takes first the point E where AE measured along the axis from the vertex A is $\frac{1}{2}p$, p being the principal parameter. The first three propositions prove generally and for certain particular cases that, if in an ellipse or a hyperbola AM be drawn at right angles to AA' and equal to $\frac{1}{2}p$, and if CM meet the ordinate PN of any point P of the curve in H , then $PN^2 = 2$ (quadrilateral $MANH$); this is a lemma used in the proofs of later propositions, V. 5, 6, &c. Next, in V. 4, 5, 6, he proves that, if $AE = \frac{1}{2}p$, then AE is the *minimum* straight line from E to the curve, and if P be any other point on it, PE increases as P moves farther away from A on either side; he proves in fact that, if PN be the ordinate from P ,

$$(1) \text{ in the case of the parabola } PE^2 = AE^2 + AN^2,$$

(2) in the case of the hyperbola or ellipse

$$PE^2 = AE^2 + AN^2 \cdot \frac{AA' \pm p}{AA'},$$

where of course $p = BB'^2/AA'$, and therefore $(AA' \pm p)/AA'$ is equivalent to what we call e^2 , the square of the eccentricity. It is also proved that EA' is the *maximum* straight line from E to the curve. It is next proved that, if O be any point on the axis between A and E , OA is the minimum straight line from O to the curve and, if P is any other point on the curve, OP increases as P moves farther from A (V. 7).

Next Apollonius takes points G on the axis at a distance from A greater than $\frac{1}{2}p$, and he proves that the *minimum* straight line from G to the curve (i.e. the normal) is GP , where P is such a point that

(1) in the case of the parabola $NG = \frac{1}{2}p$;

(2) in the case of the central conic $NG:CN = p:AA'$;

and, if P' is any other point on the conic, $P'G$ increases as P' moves away from P on either side; this is proved by showing that

(1) for the parabola $P'G^2 = PG^2 + NN'^2$;

(2) for the central conic $P'G^2 = PG^2 + NN'^2 \cdot \frac{AA' \pm p}{AA'}$.

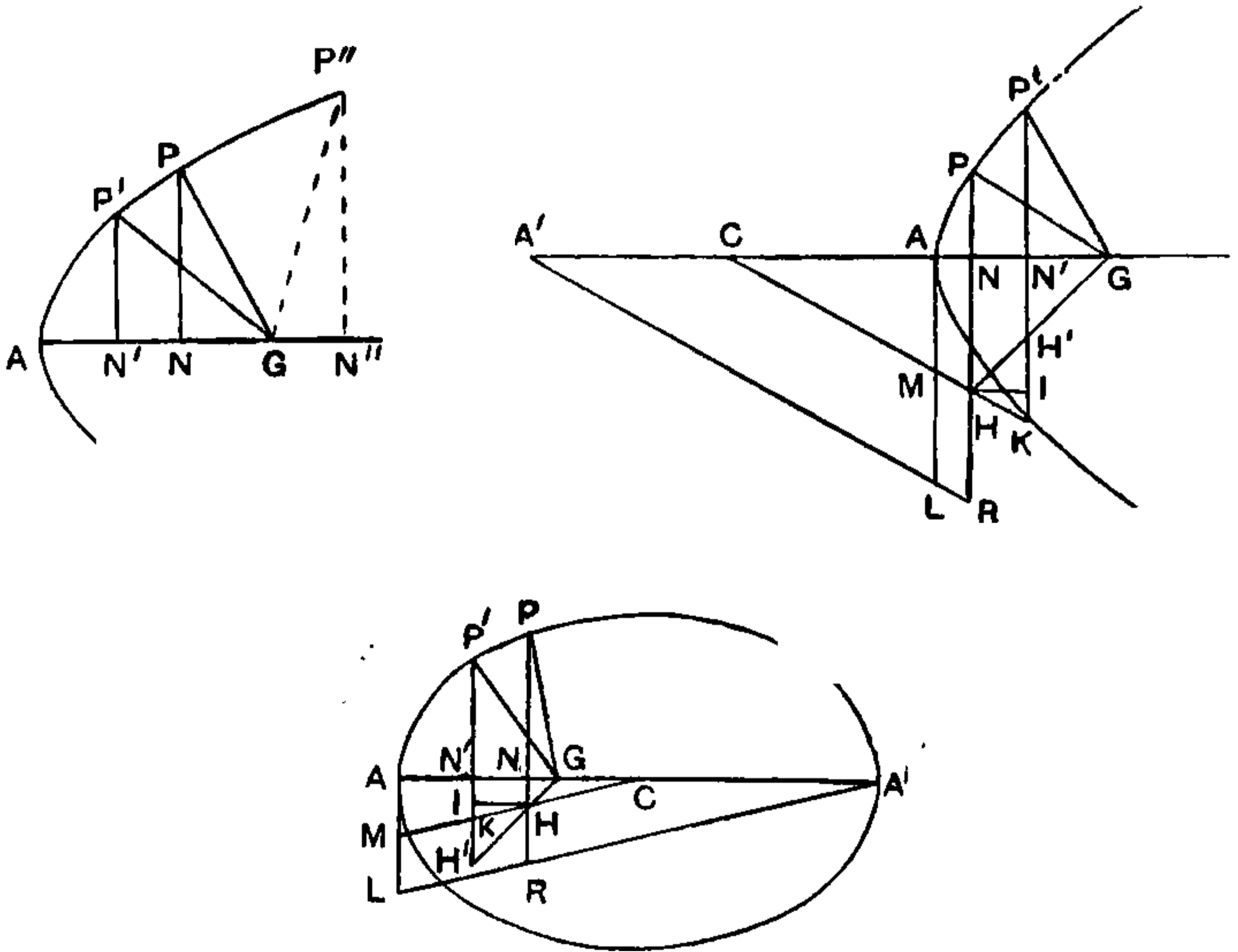

As these propositions contain the fundamental properties of the subnormals, it is worth while to reproduce Apollonius's proofs.

(1) In the parabola, if G be any point on the axis such that $AG > \frac{1}{2}p$, measure GN towards A equal to $\frac{1}{2}p$. Let PN be the ordinate through N , P' any other point on the curve. Then shall PG be the minimum line from G to the curve, &c.

We have $P'N'^2 = p \cdot AN' = 2NG \cdot AN'$;
 and $N'G^2 = NN'^2 + NG^2 \pm 2NG \cdot NN'$,
 according to the position of N' .

$$\begin{aligned} \text{Therefore } P'G^2 &= 2NG \cdot AN + NG^2 + NN'^2 \\ &= PN^2 + NG^2 + NN'^2 \\ &= PG^2 + NN'^2; \end{aligned}$$

and the proposition is proved.

(2) In the case of the central conic, take G on the axis such that $AG > \frac{1}{2}p$, and measure GN towards A such that

$$NG : CN = p : AA'.$$

Draw the ordinate PN through N , and also the ordinate $P'N'$ from any other point P' .

We have first to prove the lemma (V. 1, 2, 3) that, if AM be drawn perpendicular to AA' and equal to $\frac{1}{2}p$, and if CM , produced if necessary, meet PN in H , then

$$PN^2 = 2(\text{quadrilateral } MANH).$$

This is easy, for, if $AL (= 2AM)$ be the parameter, and $A'L$ meet PN in R , then, by the property of the curve,

$$\begin{aligned} PN^2 &= AN \cdot NR \\ &= AN(NH + AM) \\ &= 2(\text{quadrilateral } MANH). \end{aligned}$$

Let GH , produced if necessary, meet $P'N'$ in H' . From H draw HI perpendicular to $P'H'$.

$$\begin{aligned} \text{Now, since, by hypothesis, } NG : CN &= p : AA' \\ &= AM : AC \\ &= HN : NC, \end{aligned}$$

$NH = NG$, whence also $H'N' = N'G$.

$$\text{Therefore } NG^2 = 2\Delta HNG, \quad N'G^2 = 2\Delta H'N'G.$$

$$\text{And } PN^2 = 2(MANH);$$

$$\text{therefore } PG^2 = NG^2 + PN^2 = 2(\Delta MHG).$$



THIS PAGE IS LOCKED TO FREE MEMBERS

Purchase full membership to immediately unlock this page

FORGOTTEN BOOKS

FULL

MEMBERSHIP

797,885 Books!

All you can read

for only

\$8.99/month

Continue

*Fair usage policy applies



if P' be any other point on it, $P'g$ diminishes as P' moves farther from P on either side to B or B' , and

$$Pg^2 - P'g^2 = nn'^2 \cdot \frac{p' - BB'}{BB'} \quad \text{or} \quad nn'^2 \cdot \frac{CA^2 - CB^2}{CB^2}.$$

If O be any point on Pg produced beyond the minor axis, PO is the *maximum* straight line from O to the same part of the ellipse for which Pg is a maximum, i.e. the semi-ellipse BPB' , &c. (V. 20-2).

In V. 23 it is proved that, if g is on the minor axis, and gP a maximum straight line to the curve, and if Pg meets AA' in G , then GP is the *minimum* straight line from G to the curve; this is proved by similar triangles. Only one normal can be drawn from any one point on a conic (V. 24-6). The normal at any point P of a conic, whether regarded as a minimum straight line from G on the major axis or (in the case of the ellipse) as a *maximum* straight line from g on the minor axis, is perpendicular to the tangent at P (V. 27-30); in general (1) if O be any point within a conic, and OP be a maximum or a minimum straight line from O to the conic, the straight line through P perpendicular to PO touches the conic, and (2) if O' be any point on OP produced outside the conic, $O'P$ is the minimum straight line from O' to the conic, &c. (V. 31-4).

Number of normals from a point.

We now come to propositions about two or more normals meeting at a point. If the normal at P meet the axis of a parabola or the axis AA' of a hyperbola or ellipse in G , the angle PGA increases as P or G moves farther away from A , but in the case of the hyperbola the angle will always be less than the complement of half the angle between the asymptotes. Two normals at points on the same side of AA' will meet on the opposite side of that axis; and two normals at points on the same quadrant of an ellipse as AB will meet at a point within the angle ACB' (V. 35-40). In a parabola or an ellipse any normal PG will meet the curve again; in the hyperbola, (1) if AA' be not greater than p , no normal can meet the curve at a second point on the same branch, but

(2) if $AA' > p$, some normals will meet the same branch again and others not (V. 41–3).

If P_1G_1, P_2G_2 be normals at points on one side of the axis of a conic meeting in O , and if O be joined to any other point P on the conic (it being further supposed in the case of the ellipse that all three lines OP_1, OP_2, OP cut the same half of the axis), then

(1) OP cannot be a normal to the curve;

(2) if OP meet the axis in K , and PG be the normal at P , AG is less or greater than AK according as P does or does not lie between P_1 and P_2 .

From this proposition it is proved that (1) three normals at points on one quadrant of an ellipse cannot meet at one point, and (2) four normals at points on one semi-ellipse bounded by the major axis cannot meet at one point (V. 44–8).

In any conic, if M be any point on the axis such that AM is not greater than $\frac{1}{2}p$, and if O be any point on the double ordinate through M , then no straight line drawn to any point on the curve on the other side of the axis from O and meeting the axis between A and M can be a normal (V. 49, 50).

Propositions leading immediately to the determination of the evolute of a conic.

These great propositions are V. 51, 52, to the following effect :

If AM measured along the axis be greater than $\frac{1}{2}p$ (but in the case of the ellipse less than AC), and if MO be drawn perpendicular to the axis, then a certain length (y , say) can be assigned such that

(a) if $OM > y$, no normal can be drawn through O which cuts the axis; but, if OP be any straight line drawn to the curve cutting the axis in K , $NK < NG$, where PN is the ordinate and PG the normal at P ;

(b) if $OM = y$, only one normal can be so drawn through O , and, if OP be any other straight line drawn to the curve and cutting the axis in K , $NK < NG$, as before;

(c) if $OM < y$, two normals can be so drawn through O , and, if OP be any other straight line drawn to the curve, NK is

greater or less than NG according as OP is or is not intermediate between the two normals (V. 51, 52).

The proofs are of course long and complicated. The length y is determined in this way:

(1) In the case of the parabola, measure MH towards the vertex equal to $\frac{1}{2}p$, and divide AH at N_1 so that $HN_1 = 2N_1A$. The length y is then taken such that

$$y : P_1N_1 = N_1H : HM,$$

where P_1N_1 is the ordinate passing through N_1 ;

(2) In the case of the hyperbola and ellipse, we have $AM > \frac{1}{2}p$, so that $CA : AM < AA' : p$; therefore, if H be taken on AM such that $CH : HM = AA' : p$, H will fall between A and M .

Take two mean proportionals CN_1, CI between CA and CH , and let P_1N_1 be the ordinate through N_1 .

The length y is then taken such that

$$y : P_1N_1 = (CM : MH) \cdot (HN_1 : N_1C).$$

In the case (b), where $OM = y$, O is the point of intersection of consecutive normals, i. e. O is the centre of curvature at the point P ; and, by considering the coordinates of O with reference to two coordinate axes, we can derive the Cartesian equations of the evolutes. E. g. (1) in the case of the parabola let the coordinate axes be the axis and the tangent at the vertex. Then $AM = x$, $OM = y$. Let $p = 4a$; then

$$HM = 2a, \quad N_1H = \frac{2}{3}(x - 2a), \quad \text{and} \quad AN_1 = \frac{1}{3}(x - 2a).$$

But $y^2 : P_1N_1^2 = N_1H^2 : HM^2$, by hypothesis,

$$\text{or} \quad y^2 : 4a \cdot AN_1 = N_1H^2 : 4a^2;$$

$$\begin{aligned} \text{therefore} \quad ay^2 &= AN_1 \cdot N_1H^2, \\ &= \frac{4}{27}(x - 2a)^3, \end{aligned}$$

$$\text{or} \quad 27ay^2 = 4(x - 2a)^3.$$

(2) In the case of the hyperbola or ellipse we naturally take CA, CB as axes of x and y . The work is here rather more complicated, but there is no difficulty in obtaining, as the locus of O , the curve

$$(ax)^{\frac{2}{3}} \mp (by)^{\frac{2}{3}} = (a^2 \pm b^2)^{\frac{2}{3}}.$$



THIS PAGE IS LOCKED TO FREE MEMBERS

Purchase full membership to immediately unlock this page

DELVE INTO FANTASY, MAGIC, MYTHOLOGY & FOLKLORE

Forgotten Books'
Full Membership gives
access to 797,885 ancient
and modern, fiction and
non-fiction books.

Continue

*Fair usage policy applies

tively with the conics give the points at which the normals passing through O are normals.

Pappus criticizes the use of the rectangular hyperbola in the case of the parabola as an unnecessary resort to a 'solid locus'; the meaning evidently is that the same points of intersection can be got by means of a certain circle taking the place of the rectangular hyperbola. We can, in fact, from the equation (1) above combined with $y^2 = px$, obtain the circle

$$(x^2 + y^2) - (x_1 + \frac{1}{2}p)x - \frac{1}{2}y_1y = 0.$$

The Book concludes with other propositions about maxima and minima. In particular V. 68-71 compare the lengths of tangents TQ , TQ' , where Q is nearer to the axis than Q' . V. 72, 74 compare the lengths of two normals from a point O from which only two can be drawn and the lengths of other straight lines from O to the curve; V. 75-7 compare the lengths of three normals to an ellipse drawn from a point O below the major axis, in relation to the lengths of other straight lines from O to the curve.

Book VI is of much less interest. The first part (VI. 1-27) relates to equal (i.e. congruent) or similar conics and segments of conics; it is naturally preceded by some definitions including those of 'equal' and 'similar' as applied to conics and segments of conics. Conics are said to be similar if, the same number of ordinates being drawn to the axis at proportional distances from the vertices, all the ordinates are respectively proportional to the corresponding abscissae. The definition of similar segments is the same with diameter substituted for axis, and with the additional condition that the angles between the base and diameter in each are equal. Two parabolas are equal if the ordinates to a diameter in each are inclined to the respective diameters at equal angles and the corresponding parameters are equal; two ellipses or hyperbolas are equal if the ordinates to a diameter in each are equally inclined to the respective diameters and the diameters as well as the corresponding parameters are equal (VI. 1. 2). Hyperbolas or ellipses are similar when the 'figure' on a diameter of one is similar (instead of equal) to the 'figure' on a diameter of the other, and the ordinates to the diameters in

each make equal angles with them; all parabolas are similar (VI. 11, 12, 13). No conic of one of the three kinds (parabolas, hyperbolas or ellipses) can be equal or similar to a conic of either of the other two kinds (VI. 3, 14, 15). Let QPQ' , qqq' be two segments of similar conics in which QQ' , qq' are the bases and PV , pv are the diameters bisecting them; then, if PT , pt be the tangents at P , p and meet the axes at T , t at equal angles, and if $PV:PT = pv:pt$, the segments are similar and similarly situated, and conversely (VI. 17, 18). If two ordinates be drawn to the axes of two parabolas, or the major or conjugate axes of two similar central conics, as PN , $P'N'$ and pn , $p'n'$ respectively, such that the ratios $AN:an$ and $AN':an'$ are each equal to the ratio of the respective *latera recta*, the segments PP' , pp' will be similar; also PP' will not be similar to any segment in the other conic cut off by two ordinates other than pn , $p'n'$, and conversely (VI. 21, 22). If any cone be cut by two parallel planes making hyperbolic or elliptic sections, the sections will be similar but not equal (VI. 26, 27).

The remainder of the Book consists of problems of construction; we are shown how in a given right cone to find a parabolic, hyperbolic or elliptic section equal to a given parabola, hyperbola or ellipse, subject in the case of the hyperbola to a certain *διορισμός* or condition of possibility (VI. 28–30); also how to find a right cone similar to a given cone and containing a given parabola, hyperbola or ellipse as a section of it, subject again in the case of the hyperbola to a certain *διορισμός* (VI. 31–3). These problems recall the somewhat similar problems in I. 51–9.

Book VII begins with three propositions giving expressions for $AP^2 (= AN^2 + PN^2)$ in the same form as those for PN^2 in the statement of the ordinary property. In the parabola AH is measured along the axis produced (i.e. in the opposite direction to AN) and of length equal to the *latus rectum*, and it is proved that, for any point P , $AP^2 = AN \cdot NH$ (VII. 1). In the case of the central conics AA' is divided at H , internally for the hyperbola and externally for the ellipse (AH being the segment adjacent to A) so that $AH:A'H = p:AA'$, where p is the parameter corresponding to AA' , or $p = BB'^2/AA'$, and it is proved that

$$AP^2 : AN \cdot NH = AA' : A'H.$$

The same is true if AA' is the minor axis of an ellipse and p the corresponding parameter (VII. 2, 3).

If AA' be divided at H' as well as H (internally for the hyperbola and externally for the ellipse) so that H is adjacent to A and H' to A' , and if $A'H : AH = AH' : A'H' = AA' : p$, the lines $AH, A'H'$ (corresponding to p in the proportion) are called by Apollonius *homologues*, and he makes considerable

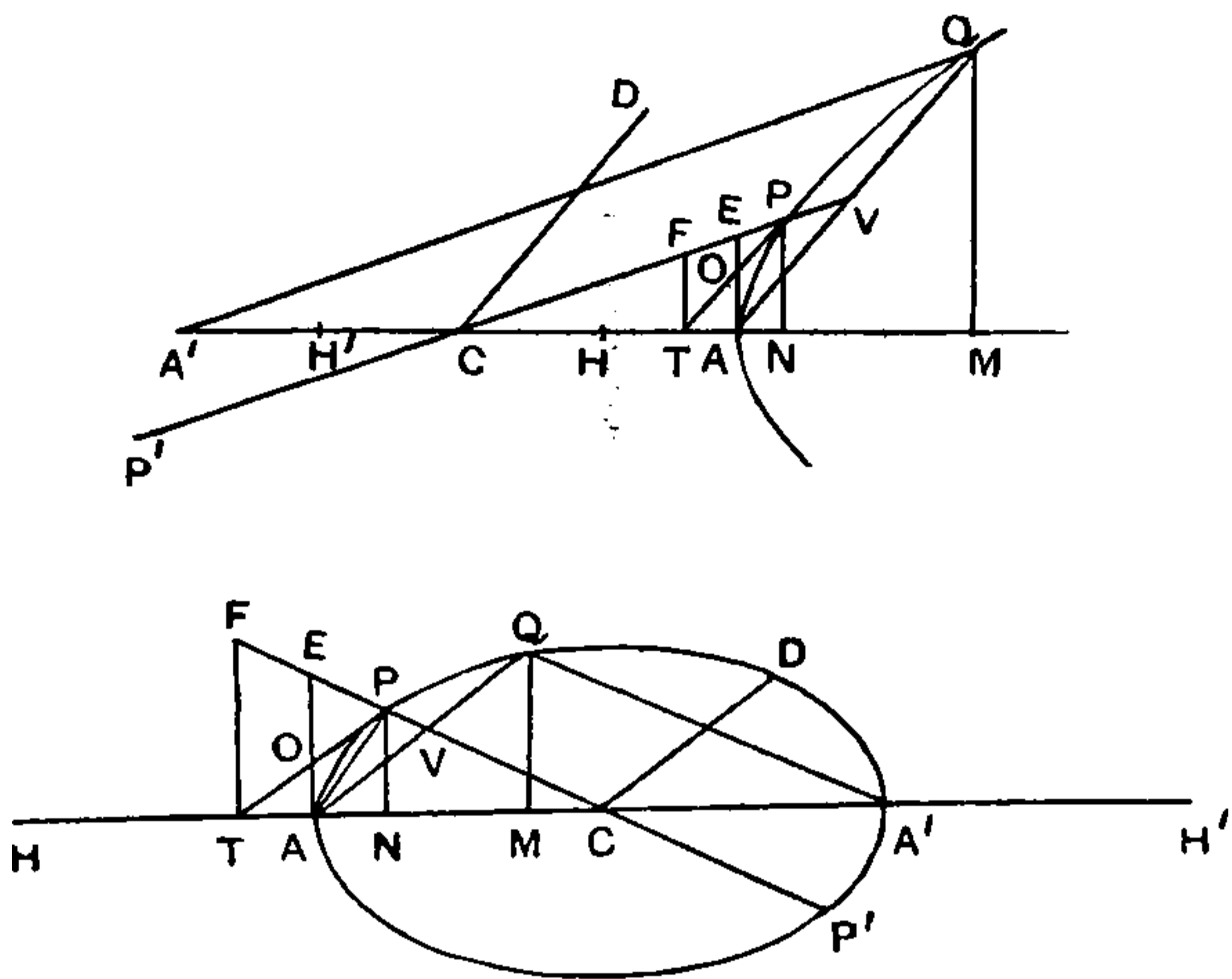

use of the auxiliary points H, H' in later propositions from VII. 6 onwards. Meantime he proves two more propositions, which, like VII. 1–3, are by way of lemmas. First, if CD be the semi-diameter parallel to the tangent at P to a central conic, and if the tangent meet the axis AA' in T , then

$$PT^2 : CD^2 = NT : CN. \quad (\text{VII. 4.})$$

Draw AE, TF at right angles to CA to meet CP , and let AE meet PT in O . Then, if p' be the parameter of the ordinates to CP , we have

$$\frac{1}{2} p' : PT = OP : PE \quad (\text{I. 49, 50.})$$

$$= PT : PF,$$

or

$$\frac{1}{2} p' \cdot PF = PT^2.$$

Therefore

$$PT^2 : CD^2 = \frac{1}{2} p' \cdot PF : \frac{1}{2} p' \cdot CP$$

$$= PF : CP$$

$$= NT : CN.$$



THIS PAGE IS LOCKED TO FREE MEMBERS

Purchase full membership to immediately unlock this page

FORGOTTEN BOOKS

FULL

MEMBERSHIP

797,885 Books!

All you can read

for only

\$8.99/month

Continue

*Fair usage policy applies



But $A'Q^2 : A'M \cdot MH' = AA' : AH'$ (VII. 2, 3)

$$= AA' : A'H$$

$$= A'M \cdot AA' : A'M \cdot A'H,$$

so that, alternately,

$$A'M \cdot AA' : A'Q^2 = A'M \cdot A'H : A'M \cdot MH'$$

$$= A'H : MH'.)$$

Next, $PP'^2 : DD'^2 = MH' : MH$, as above, (β)

$$= MH'^2 : MH \cdot MH',$$

whence $PP' : DD' = MH' : \sqrt{MH \cdot MH'}$, (γ)

and $PP'^2 : (PP' \pm DD')^2 = MH'^2 : \{MH' \pm \sqrt{MH \cdot MH'}\}^2$;

(1) above follows from this relation and (α) *ex aequali*;

(2) follows from (α) and (γ) *ex aequali*, and (3) from (α) and (β).

We now obtain immediately the important proposition that $PP'^2 \pm DD'^2$ is constant, whatever be the position of P on an ellipse or hyperbola (the upper sign referring to the ellipse), and is equal to $AA'^2 \pm BB'^2$ (VII. 12, 13, 29, 30).

For $AA'^2 : BB'^2 = AA' : p = A'H : AH = A'H : A'H'$,

by construction ;

therefore $AA'^2 : AA'^2 \pm BB'^2 = A'H : HH'$;

also, from (α) above,

$$AA'^2 : PP'^2 = A'H : MH' ;$$

and, by means of (β),

$$PP'^2 : (PP'^2 \pm DD'^2) = MH' : MH' \pm MH$$

$$= MH' : HH'.$$

Ex aequali, from the last two relations, we have

$$AA'^2 : (PP'^2 \pm DD'^2) = A'H : HH'$$

$$= AA'^2 : AA'^2 \pm BB'^2, \text{ from above,}$$

whence $PP'^2 \pm DD'^2 = AA'^2 \pm BB'^2$.

A number of other ratios are expressed in terms of the straight lines terminating at A, A', H, H', M, M' as follows (VII. 14–20).

In the ellipse $AA'^2 : PP'^2 \sim DD'^2 = A'H : 2CM,$

and in the hyperbola or ellipse (if p be the parameter of the ordinates to PP')

$$AA'^2 : p^2 = A'H \cdot MH' : MH^2,$$

$$AA'^2 : (PP' \pm p)^2 = A'H \cdot MH' : (MH \pm MH')^2,$$

$$AA'^2 : PP' \cdot p = A'H : MH,$$

and $AA'^2 : (PP'^2 \pm p^2) = A'H \cdot MH' : (MH'^2 \pm MH^2).$

Apollonius is now in a position, by means of all these relations, resting on the use of the auxiliary points $H, H', M,$ to compare different functions of any conjugate diameters with the same functions of the axes, and to show how the former vary (by way of increase or diminution) as P moves away from A . The following is a list of the functions compared, where for brevity I shall use a, b to represent AA', BB' ; a', b' to represent PP', DD' ; and p, p' to represent the parameters of the ordinates to AA', PP' respectively.

In a hyperbola, according as $a >$ or $< b, a' >$ or $< b'$, and the ratio $a' : b'$ decreases or increases as P moves from A on either side; also, if $a = b, a' = b'$ (VII. 21–3); in an ellipse $a : b > a' : b'$, and the latter ratio diminishes as P moves from A to B (VII. 24).

In a hyperbola or ellipse $a + b < a' + b'$, and $a' + b'$ in the hyperbola increases continually as P moves farther from A , but in the ellipse increases till a', b' take the position of the equal conjugate diameters when it is a *maximum* (VII. 25, 26).

In a hyperbola in which a, b are unequal, or in an ellipse, $a \sim b > a' \sim b'$, and $a' \sim b'$ diminishes as P moves away from A , in the hyperbola continually, and in the ellipse till a', b' are the equal conjugate diameters (VII. 27).

$ab < a'b'$, and $a'b'$ increases as P moves away from A , in the hyperbola continually, and in the ellipse till a', b' coincide with the equal conjugate diameters (VII. 28).

VII. 31 is the important proposition that, if PP', DD' are

conjugate diameters in an ellipse or conjugate hyperbolas, and if the tangents at their extremities form the parallelogram $LL'MM'$, then

the parallelogram $LL'MM' = \text{rect. } AA'.BB'$.

The proof is interesting. Let the tangents at P, D respectively meet the major or transverse axis in T, T' .

Now (by VII. 4) $PT^2:CD^2 = NT:CN$;

therefore $2\Delta CPT:2\Delta T'DC = NT:CN$.

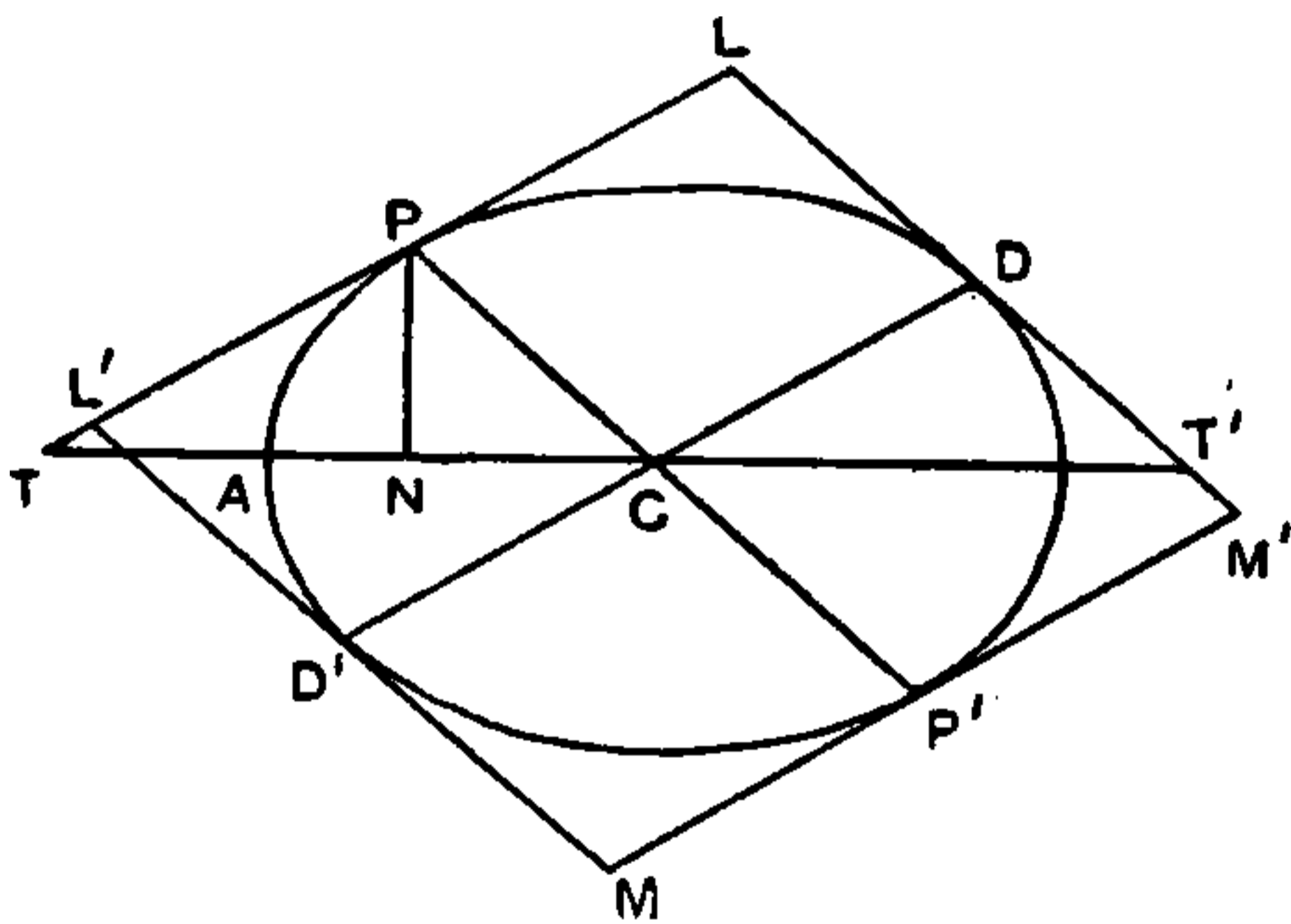
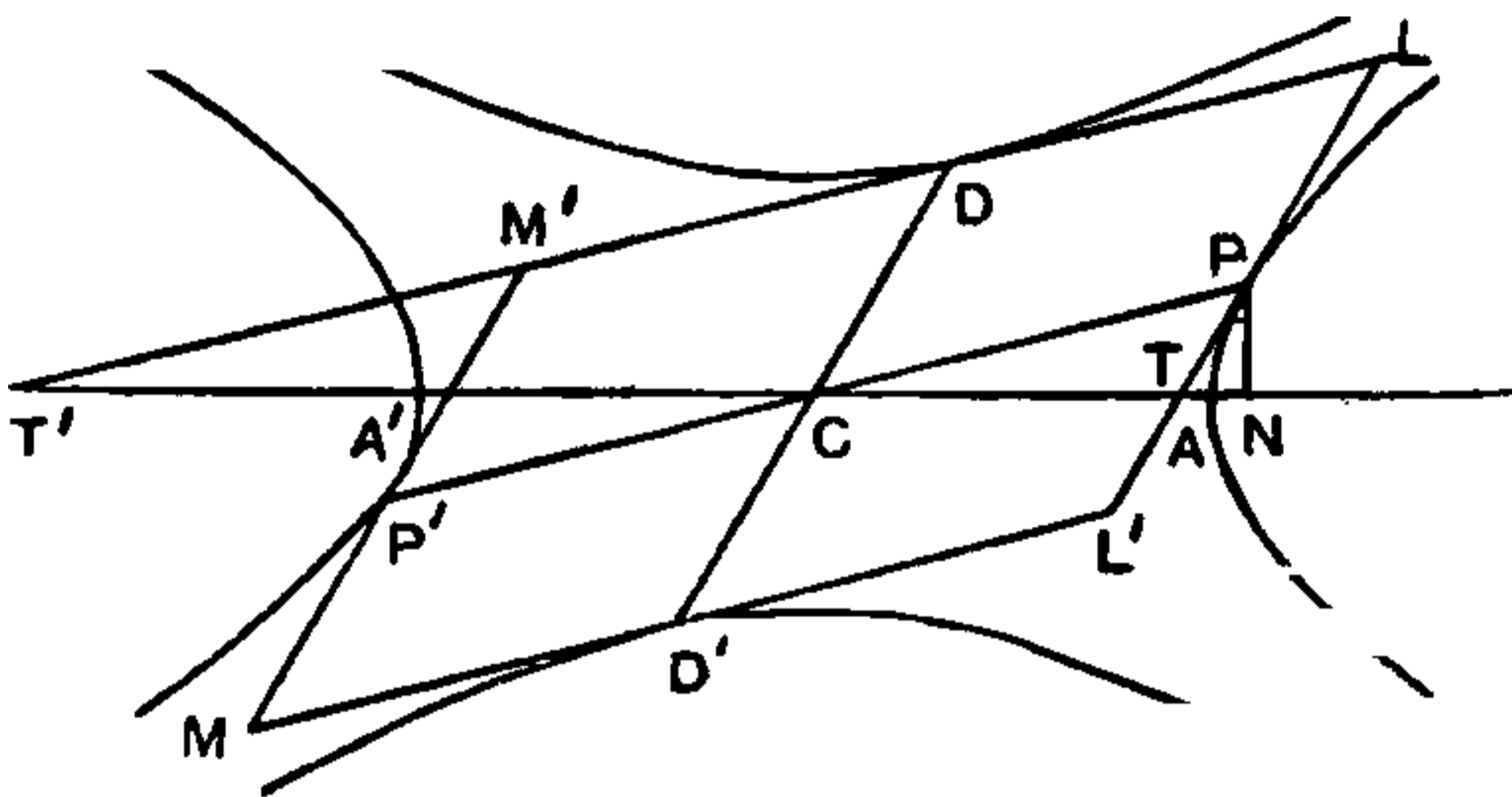

But $2\Delta CPT:(CL) = PT:CD,$
 $= CP:DT',$ by similar triangles,
 $= (CL):2\Delta T'DC.$

That is, (CL) is a mean proportional between $2\Delta CPT$ and $2\Delta T'DC$.

Therefore, since $\sqrt{(NT \cdot CN)}$ is a mean proportional between NT and CN ,



THIS PAGE IS LOCKED TO FREE MEMBERS

Purchase full membership to immediately unlock this page

DELVE INTO FANTASY, MAGIC, MYTHOLOGY & FOLKLORE

Forgotten Books'
Full Membership gives
access to 797,885 ancient
and modern, fiction and
non-fiction books.

Continue

*Fair usage policy applies

As we have said, Book VIII is lost. The nature of its contents can only be conjectured from Apollonius's own remark that it contained determinate conic problems for which Book VII was useful, particularly in determining limits of possibility. Unfortunately, the lemmas of Pappus do not enable us to form any clearer idea. But it is probable enough that the Book contained a number of problems having for their object the finding of conjugate diameters in a given conic such that certain functions of their lengths have given values. It was on this assumption that Halley attempted a restoration of the Book.

If it be thought that the above account of the *Conics* is disproportionately long for a work of this kind, it must be remembered that the treatise is a great classic which deserves to be more known than it is. What militates against its being read in its original form is the great extent of the exposition (it contains 387 separate propositions), due partly to the Greek habit of proving particular cases of a general proposition separately from the proposition itself, but more to the cumbrousness of the enunciations of complicated propositions in general terms (without the help of letters to denote particular points) and to the elaborateness of the Euclidean form, to which Apollonius adheres throughout.

Other works by Apollonius.

Pappus mentions and gives a short indication of the contents of six other works of Apollonius which formed part of the *Treasury of Analysis*.¹ Three of these should be mentioned in close connexion with the *Conics*.

(a) *On the Cutting-off of a Ratio* (λόγου ἀποτομή),
two Books.

This work alone of the six mentioned has survived, and that only in the Arabic; it was published in a Latin translation by Edmund Halley in 1706. It deals with the general problem, 'Given two straight lines, parallel to one another or intersecting, and a fixed point on each line, to draw through

¹ Pappus, vii, pp. 640-8, 660-72.

a given point a straight line which shall cut off segments from each line (measured from the fixed points) bearing a given ratio to one another.' Thus, let A, B be fixed points on the two given straight lines AC, BK , and let O be the given point. It is required to draw through O a straight line cutting the given straight lines in points M, N respectively

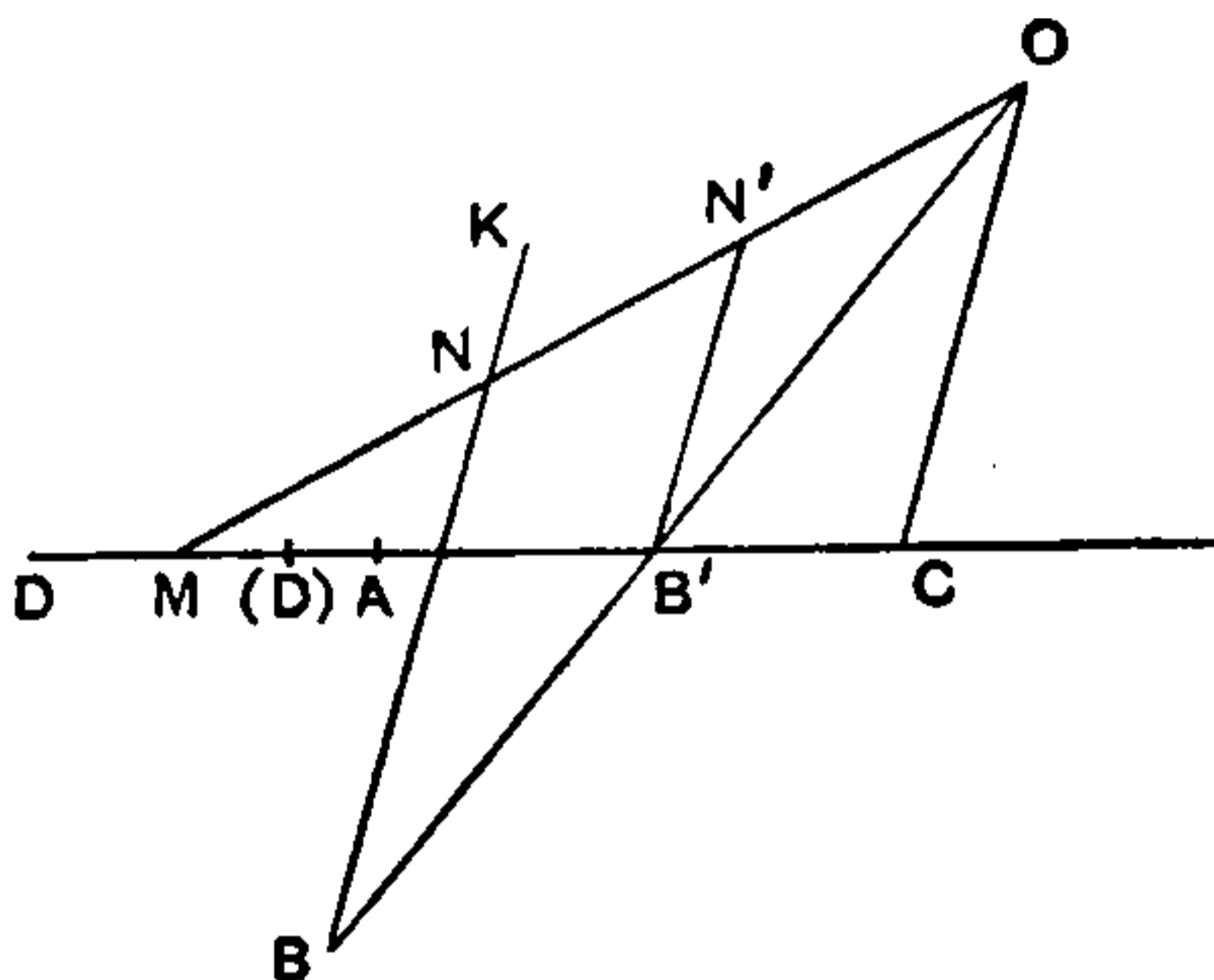

such that AM is to BN in a given ratio. The two Books of the treatise discussed the various possible cases of this problem which arise according to the relative positions of the given straight lines and points, and also the necessary conditions and limits of possibility in cases where a solution is not always possible. The first Book begins by supposing the given lines to be parallel, and discusses the different cases which arise; Apollonius then passes to the cases in which the straight lines intersect, but one of the given points, A or B , is at the intersection of the two lines. Book II proceeds to the general case shown in the above figure, and first proves that the general case can be reduced to the case in Book I where one of the given points, A or B , is at the intersection of the two lines. The reduction is easy. For join OB meeting AC in B' , and draw $B'N'$ parallel to BN to meet OM in N' . Then the ratio $B'N' : BN$, being equal to the ratio $OB' : OB$, is constant. Since, therefore, $BN : AM$ is a given ratio, the ratio $B'N' : AM$ is also given.

Apollonius proceeds in all cases by the orthodox method of analysis and synthesis. Suppose the problem solved and OMN drawn through O in such a way that $B'N' : AM$ is a given ratio $= \lambda$, say.

Draw OC parallel to BN or $B'N'$ to meet AM in C . Take D on AM such that $OC : AD = \lambda = B'N' : AM$.

Then
$$AM : AD = B'N' : OC$$

$$= B'M : CM;$$

therefore $MD : AD = B'C : CM,$

or $CM \cdot MD = AD \cdot B'C,$ a given rectangle.

Hence the problem is reduced to one of *applying to CD a rectangle ($CM \cdot MD$) equal to a given rectangle ($AD \cdot B'C$) but falling short by a square figure.* In the case as drawn, whatever be the value of λ , the solution is always possible because the given rectangle $AD \cdot CB'$ is always less than $CA \cdot AD$, and therefore always less than $\frac{1}{4}CD^2$; one of the positions of M falls between A and D because $CM \cdot MD < CA \cdot AD$.

The proposition III. 41 of the *Conics* about the intercepts made on two tangents to a parabola by a third tangent (pp. 155–6 above) suggests an obvious application of our problem. We had, with the notation of that proposition,

$$Pr : rq = rQ : Qp = qp : pR.$$

Suppose that the two tangents qP, qR are given as fixed tangents with their points of contact P, R . Then we can draw another tangent if we can draw a straight line intersecting qP, qR in such a way that $Pr : rq = qp : pR$ or $Pq : qr = qR : pR$, i.e. $qr : pR = Pq : qR$ (a constant ratio); i.e. we have to draw a straight line such that the intercept by it on qP measured from q has a given ratio to the intercept by it on qR measured from R . This is a particular case of our problem to which, as a matter of fact, Apollonius devotes special attention. In the annexed figure the letters have the

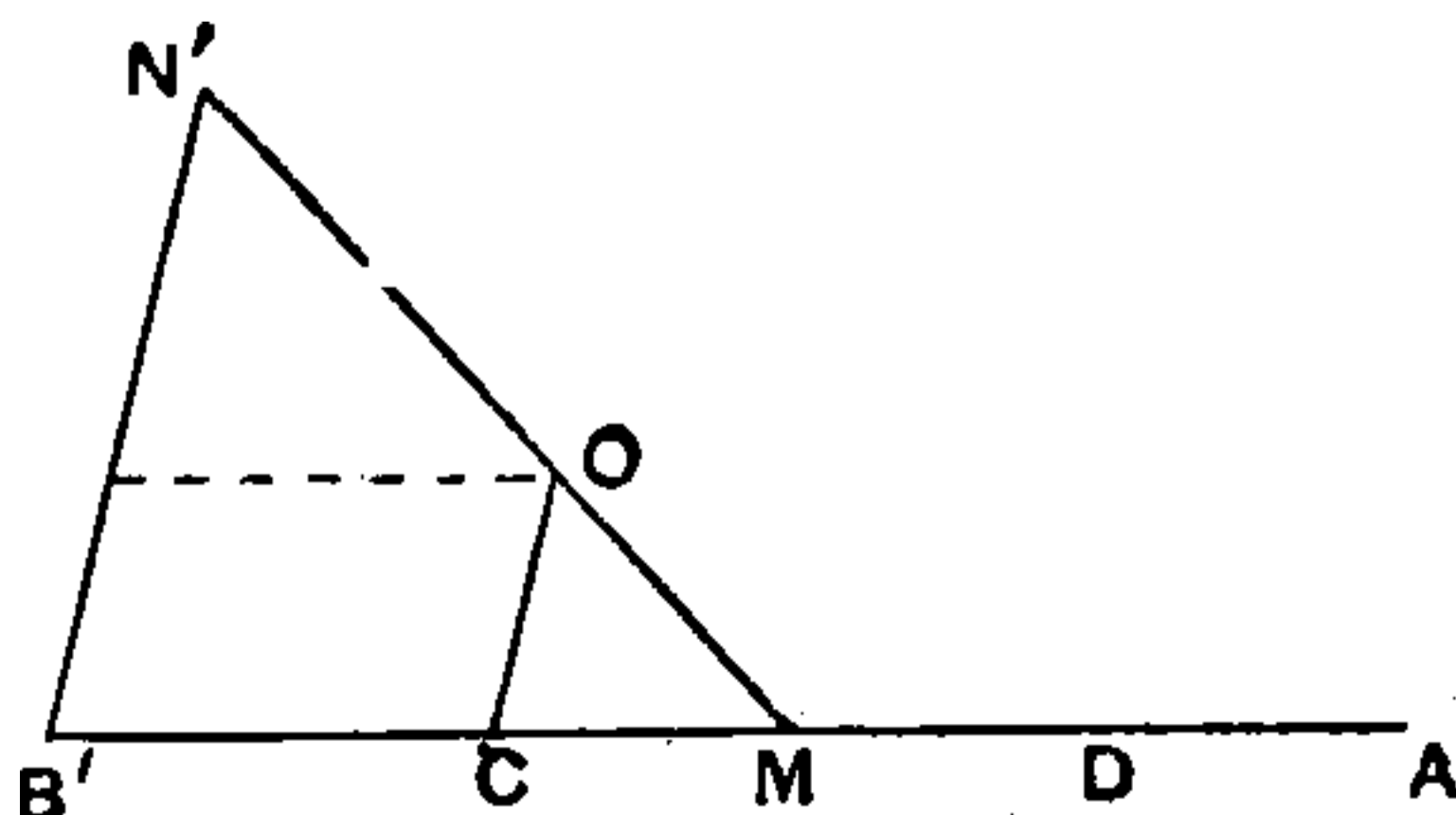

same meaning as before, and $N'M$ has to be drawn through O such that $B'N' : AM = \lambda$. In this case there are limits to



THIS PAGE IS LOCKED TO FREE MEMBERS

Purchase full membership to immediately unlock this page

FORGOTTEN BOOKS

FULL

MEMBERSHIP

797,885 Books!

All you can read

for only

\$8.99/month

Continue

*Fair usage policy applies



Further, if, we put for λ the ratio between the lengths of the two fixed tangents, then if h, k be those lengths,

$$\frac{k}{h} = \frac{y}{h + x - 2\sqrt{hx}},$$

which can easily be reduced to

$$\left(\frac{x}{h}\right)^{\frac{1}{2}} + \left(\frac{y}{k}\right)^{\frac{1}{2}} = 1,$$

the equation of the parabola referred to the two fixed tangents as axes.

(β) *On the cutting-off of an area* (*χωρίου ἀποτομή*),
two Books.

This work, also in two Books, dealt with a similar problem, with the difference that the intercepts on the given straight lines measured from the given points are required, not to have a given ratio, but to contain a given rectangle. Halley included an attempted restoration of this work in his edition of the *De sectione rationis*.

The general case can here again be reduced to the more special one in which one of the fixed points is at the intersection of the two given straight lines. Using the same figure as before, but with D taking the position shown by (D) in the figure, we take that point such that

$$OC : AD = \text{the given rectangle.}$$

We have then to draw $ON'M$ through O such that

$$B'N' \cdot AM = OC \cdot AD,$$

or
$$B'N' : OC = AD : AM.$$

But, by parallels, $B'N' : OC = B'M : CM;$

therefore
$$\begin{aligned} AM : CM &= AD : B'M \\ &= MD : B'C, \end{aligned}$$

so that
$$B'M \cdot MD = AD \cdot B'C.$$

Hence, as before, the problem is reduced to an application of a rectangle in the well-known manner. The complete

treatment of this problem in all its particular cases with their *διορισμοί* could present no difficulty to Apollonius.

If the two straight lines are parallel, the solution of the problem gives a means of drawing any number of tangents to an ellipse when two parallel tangents, their points of contact, and the length of the parallel semi-diameter are given (see *Conics*, III. 42). In the case of the hyperbola (III. 43) the intercepts made by any tangent on the asymptotes contain a constant rectangle. Accordingly the drawing of tangents depends upon the particular case of our problem in which both fixed points are the intersection of the two fixed lines.

(γ) *On determinate section* (*διορισμένη τομή*), two Books.

The general problem here is, Given four points A, B, C, D on a straight line, to determine another point P on the same straight line such that the ratio $AP \cdot CP : BP \cdot DP$ has a given value. It is clear from Pappus's account¹ of the contents of this work, and from his extensive collection of lemmas to the different propositions in it, that the question was very exhaustively discussed. To determine P by means of the equation

$$AP \cdot CP = \lambda \cdot BP \cdot DP,$$

where A, B, C, D, λ are given, is in itself an easy matter since the problem can at once be put into the form of a quadratic equation, and the Greeks would have no difficulty in reducing it to the usual *application of areas*. If, however (as we may fairly suppose), it was intended for application in further investigations, the complete discussion of it would naturally include not only the finding of a solution, but also the determination of the limits of possibility and the number of possible solutions for different positions of the point-pairs A, C and B, D , for the cases in which the points in either pair coincide, or in which one of the points is infinitely distant, and so on. This agrees with what we find in Pappus, who makes it clear that, though we do not meet with any express mention of *series* of point-pairs determined by the equation for different values of λ , yet the treatise contained what amounts to a com-

¹ Pappus, vii, pp. 642-4.

plete *Theory of Involution*. Pappus says that the separate cases were dealt with in which the given ratio was that of either (1) the square of one abscissa measured from the required point or (2) the rectangle contained by two such abscissae to any one of the following: (1) the square of one abscissa, (2) the rectangle contained by one abscissa and another separate line of given length independent of the position of the required point, (3) the rectangle contained by two abscissae. We learn also that maxima and minima were investigated. From the lemmas, too, we may draw other conclusions, e. g.

(1) that, in the case where $\lambda = 1$, or $AP \cdot CP = BP \cdot DP$, Apollonius used the relation $BP : DP = AB \cdot BC : AD \cdot DC$,

(2) that Apollonius probably obtained a double point E of the involution determined by the point-pairs A, C and B, D by means of the relation

$$AB \cdot BC : AD \cdot DC = BE^2 : DE^2.$$

A possible application of the problem was the determination of the points of intersection of the given straight line with a conic determined as a four-line locus, since A, B, C, D are in fact the points of intersection of the given straight line with the four lines to which the locus has reference.

(δ) *On Contacts or Tangencies* ($\acute{\epsilon}\pi\alpha\phi\alpha\acute{\iota}$), two Books.

Pappus again comprehends in one enunciation the varieties of problems dealt with in the treatise, which we may reproduce as follows: *Given three things, each of which may be either a point, a straight line or a circle, to draw a circle which shall pass through each of the given points (so far as it is points that are given) and touch the straight lines or circles.*¹ The possibilities as regards the different data are ten. We may have any one of the following: (1) three points, (2) three straight lines, (3) two points and a straight line, (4) two straight lines and a point, (5) two points and a circle, (6) two circles and a point, (7) two straight lines and

¹ Pappus, vii, p. 644, 25-8.



THIS PAGE IS LOCKED TO FREE MEMBERS

Purchase full membership to immediately unlock this page

DELVE INTO FANTASY, MAGIC, MYTHOLOGY & FOLKLORE

Forgotten Books'
Full Membership gives
access to 797,885 ancient
and modern, fiction and
non-fiction books.

Continue

*Fair usage policy applies

solved, i.e. suppose DA, EA drawn to the circle cutting it in points B, C such that BC produced passes through F .

Draw BG parallel to DF ; join GC and produce it to meet DE in H .

Then

$$\begin{aligned} \angle BAC &= \angle BGC \\ &= \angle CHF \\ &= \text{supplement of } \angle CHD; \end{aligned}$$

therefore A, D, H, C lie on a circle, and

$$DE \cdot EH = AE \cdot EC.$$

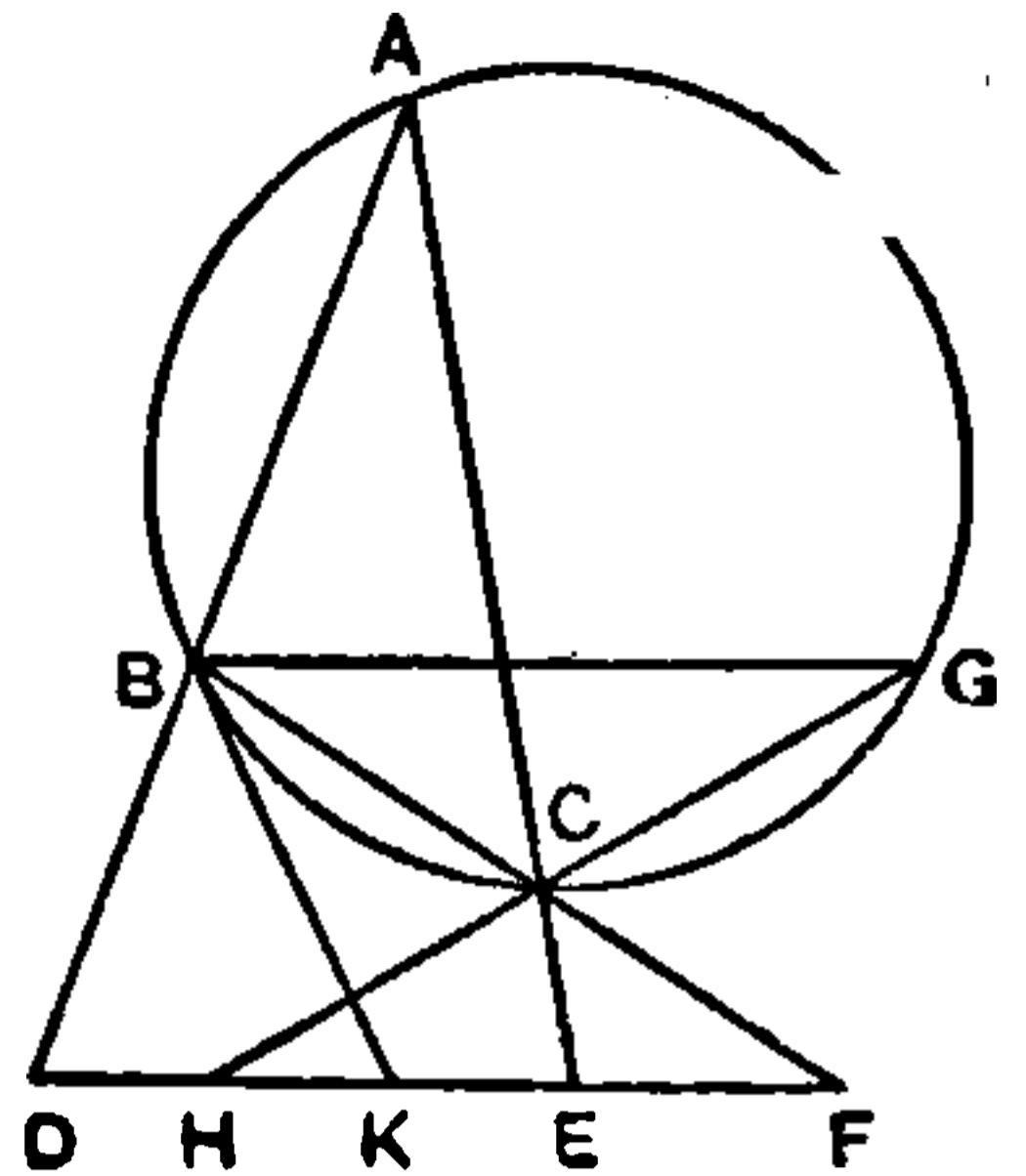

Now $AE \cdot EC$ is given, being equal to the square on the tangent from E to the circle; and DE is given; therefore HE is given, and therefore the point H .

But F is also given; therefore the problem is reduced to drawing HC, FC to meet the circle in such a way that, if HC, FC produced meet the circle again in G, B , the straight line BG is parallel to HF : a problem which Pappus has previously solved.¹

Suppose this done, and draw BK the tangent at B meeting HF in K . Then

$$\begin{aligned} \angle KBC &= \angle BGC, \text{ in the alternate segment,} \\ &= \angle CHF. \end{aligned}$$

Also the angle CFK is common to the two triangles KBF, CHF ; therefore the triangles are similar, and

$$CF : FH = KF : FB,$$

or

$$HF \cdot FK = BF \cdot FC.$$

Now $BF \cdot FC$ is given, and so is HF ; therefore FK is given, and therefore K is given.

The synthesis is as follows. Take a point H on DE such that $DE \cdot EH$ is equal to the square on the tangent from E to the circle.

Next take K on HF such that $HF \cdot FK =$ the square on the tangent from F to the circle.

Draw the tangent to the circle from K , and let B be the point of contact. Join BF meeting the circle in C , and join

¹ Pappus, vii, pp. 830-2.

HC meeting the circle again in G . It is then easy to prove that BG is parallel to DF .

Now join EC , and produce it to meet the circle again at A ; join AB .

We have only to prove that AB, BD are in one straight line. Since $DE \cdot EH = AE \cdot EC$, the points A, D, H, C are concyclic.

Now the angle CHF , which is the supplement of the angle

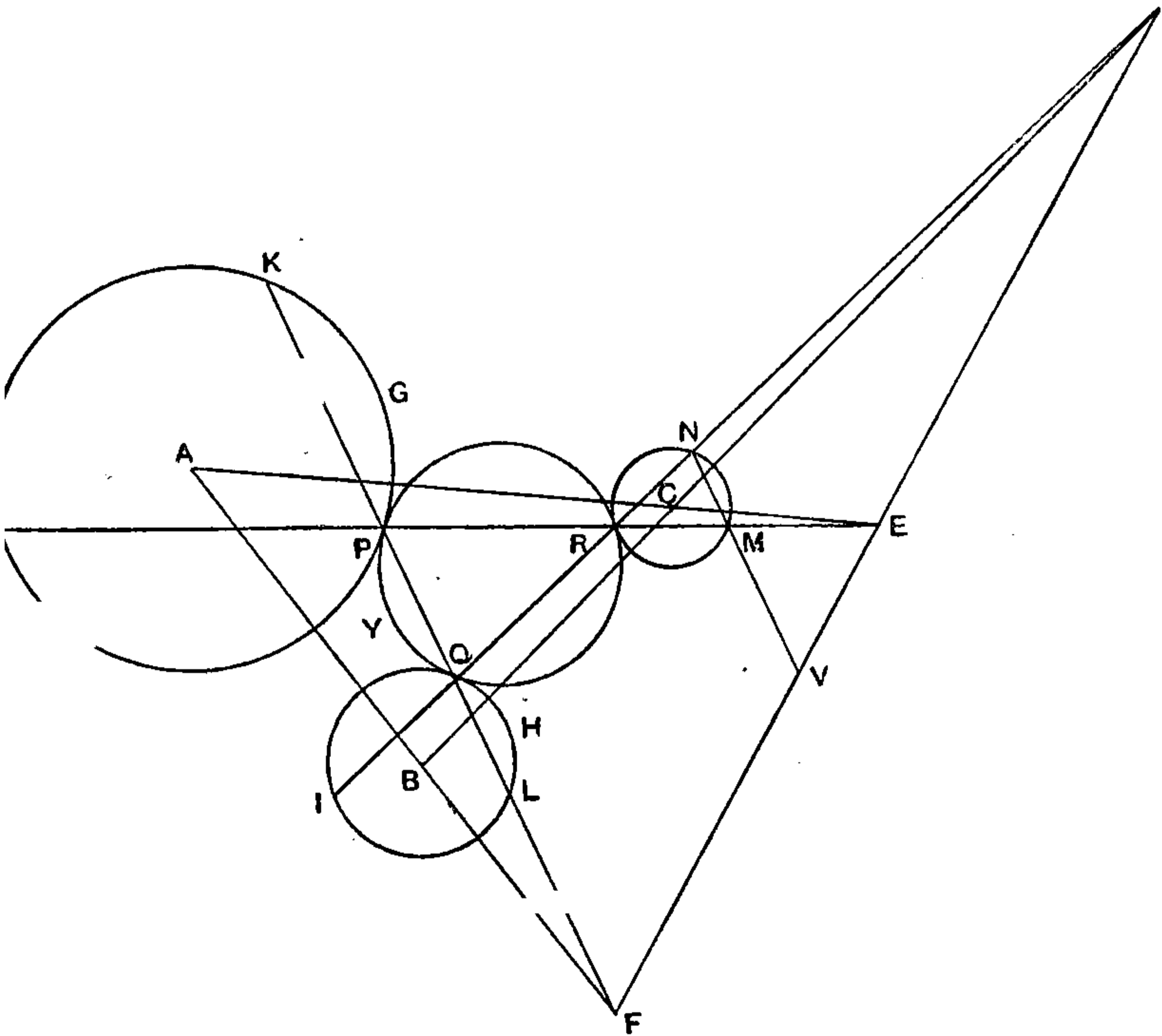

CHD , is equal to the angle BGC , and therefore to the angle BAC .

Therefore the angle BAC is equal to the supplement of angle DHC , so that the angle BAC is equal to the angle DAC ; and AB, BD are in a straight line.

The problem of Apollonius is now easy. We will take the case in which the required circle touches all the three given circles externally as shown in the figure. Let the radii of the

given circles be a, b, c and their centres A, B, C . Let D, E, F be the external centres of similitude so that $BD:DC=b:c$, &c.

Suppose the problem solved, and let P, Q, R be the points of contact. Let PQ produced meet the circles with centres A, B again in K, L . Then, by the proposition (1) above, the segments KGP, QHL are both similar to the segment PYQ ; therefore they are similar to one another. It follows that PQ produced beyond L passes through F . Similarly QR, PR produced pass respectively through D, E .

Let PE, QD meet the circle with centre C again in M, N . Then, the segments PQR, RNM being similar, the angles PQR, RNM are equal, and therefore MN is parallel to PQ . Produce NM to meet EF in V .

Then $EV:EF = EM:EP = EC:EA = c:a$;
therefore the point V is given.

Accordingly the problem reduces itself to this: Given three points V, E, D in a straight line, it is required to draw DR, ER to a point R on the circle with centre C so that, if DR, ER meet the circle again in N, M, NM produced shall pass through V . This is the problem of Pappus just solved.

Thus R is found, and DR, ER produced meet the circles with centres B and A in the other required points Q, P respectively.

(ϵ) *Plane loci*, two Books.

Pappus gives a pretty full account of the contents of this work, which has sufficed to enable restorations of it to be made by three distinguished geometers, Fermat, van Schooten, and (most completely) by Robert Simson. Pappus prefaces his account by a classification of loci on two different plans. Under the first classification loci are of three kinds: (1) *ἑφεκτικοί*, *holding-in* or *fixed*; in this case the locus of a point is a point, of a line a line, and of a solid a solid, where presumably the line or solid can only move on itself so that it does not change its position: (2) *διεξοδικοί*, *passing-along*: this is the ordinary sense of a locus, where the locus of a point is a line, and of a line a solid: (3) *ἀναστροφικοί*, *moving backwards and forwards*, as it were, in which sense a plane may be the locus of a point and a solid



THIS PAGE IS LOCKED TO FREE MEMBERS

Purchase full membership to immediately unlock this page

FORGOTTEN BOOKS

FULL

MEMBERSHIP

797,885 Books!

All you can read

for only

\$8.99/month

Continue

*Fair usage policy applies



other extremity will also lie on a straight line given in position.'

(That is, $x = a$ or $y = b$ in Cartesian coordinates represents a straight line.)

6. 'If from any point straight lines be drawn to meet at given angles two straight lines either parallel or intersecting, and if the straight lines so drawn have a given ratio to one another or if the sum of one of them and a line to which the other has a given ratio be given (in length), then the point will lie on a straight line given in position.'

(This includes the equivalent of saying that, if $x; y$ be the coordinates of the point, each of the equations $x = my$, $x + my = c$ represents a straight line.)

7. 'If any number of straight lines be given in position, and straight lines be drawn from a point to meet them at given angles, and if the straight lines so drawn be such that the rectangle contained by one of them and a given straight line added to the rectangle contained by another of them and (another) given straight line is equal to the rectangle contained by a third and a (third) given straight line, and similarly with the others, the point will lie on a straight line given in position.'

(Here we have trilinear or multilinear coordinates proportional to the distances of the variable point from each of the three or more fixed lines. When there are three fixed lines, the statement is that $ax + by = cz$ represents a straight line. The precise meaning of the words 'and similarly with the the others' or 'of the others'—*καὶ τῶν λοιπῶν ὁμοίως*—is uncertain; the words seem to imply that, when there were more than three rectangles $ax, by, cz \dots$, two of them were taken to be equal to the sum of all the others; but it is quite possible that Pappus meant that any linear equation between these rectangles represented a straight line. Precisely how far Apollonius went in generality we are not in a position to judge.)

The last enunciation (8) of Pappus referring to Book I states that,

'If from any point (two) straight lines be drawn to meet (two) parallel straight lines given in position at given angles, and

cut off from the parallels straight lines measured from given points on them such that (a) they have a given ratio or (b) they contain a given rectangle or (c) the sum or difference of figures of given species described on them respectively is equal to a given area, the point will lie on a straight line given in position.’¹

The contents of Book II are equally interesting. Some of the enunciations shall for brevity be given by means of letters instead of in general terms. If from two given points A, B two straight lines be ‘inflected’ ($\kappa\lambda\alpha\sigma\theta\hat{\omega}\sigma\nu$) to a point P , then (1), if $AP^2 \sim BP^2$ is given, the locus of P is a straight line; (2) if AP, BP are in a given ratio, the locus is a straight line or a circle [this is the proposition quoted by Eutocius in his commentary on the *Conics*, but already known to Aristotle]; (4) if AP^2 is ‘greater by a given area than in a given ratio’ to BP^2 , i.e. if $AP^2 = a^2 + m \cdot BP^2$, the locus is a circle given in position. An interesting proposition is (5) that, ‘If from any number of given points whatever straight lines be inflected to one point, and the figures (given in species) described on all of them be together equal to a given area, the point will lie on a circumference (circle) given in position’; that is to say, if $\alpha \cdot AP^2 + \beta \cdot BP^2 + \gamma \cdot CP^2 + \dots =$ a given area (where $\alpha, \beta, \gamma \dots$ are constants), the locus of P is a circle. (3) states that, if AN be a fixed straight line and A a fixed point on it, and if AP be any straight line drawn to a point P such that, if PN is perpendicular to AN , $AP^2 = a \cdot AN$ or $a \cdot BN$, where a is a given length and B is another fixed point on AN , then the locus of P is a circle given in position; this is equivalent to the fact that, if A be the origin, AN the axis of x , and $x = AN, y = PN$ be the coordinates of P , the locus $x^2 + y^2 = ax$ or $x^2 + y^2 = a(x - b)$ is a circle. (6) is somewhat obscurely enunciated: ‘If from two given points straight lines be inflected (to a point), and from the point (of concurrence) a straight line be drawn parallel to a straight line given in position and cutting off from another straight line given in position an intercept measured from a given point on it, and if the sum of figures (given in species) described on the two inflected lines be equal to the rectangle contained by a given straight line and the intercept, the point at which the straight lines are

¹ Pappus, vii, p. 666. 7–13.

inflected lies on a circle given in position.' The meaning seems to be this: Given two fixed points A, B , a length α , a straight line OX with a point O fixed upon it, and a direction represented, say, by any straight line OZ through O , then, if AP, BP be drawn to P , and PM parallel to OZ meets OX in M , the locus of P will be a circle given in position if

$$\alpha \cdot AP^2 + \beta \cdot BP^2 = \alpha \cdot OM,$$

where α, β are constants. The last two loci are again obscurely expressed, but the sense is this: (7) If PQ be any chord of a circle passing through a fixed internal point O , and R be an external point on PQ produced such that either (a) $OR^2 = PR \cdot RQ$ or (b) $OR^2 + PO \cdot OQ = PR \cdot RQ$, the locus of R is a straight line given in position. (8) is the reciprocal of this: Given the fixed point O , the straight line which is the locus of R , and also the relation (a) or (b), the locus of P, Q is a circle.

(ζ) - *Νεύσεις* (*Vergings* or *Inclinations*), two Books.

As we have seen, the problem in a *νεῦσις* is to place between two straight lines, a straight line and a curve, or two curves, a straight line of given length in such a way that it *verges* towards a fixed point, i.e. it will, if produced, pass through a fixed point. Pappus observes that, when we come to particular cases, the problem will be 'plane', 'solid' or 'linear', according to the nature of the particular hypotheses; but a selection had been made from the class which could be solved by plane methods, i.e. by means of the straight line and circle, the object being to give those which were more generally useful in geometry. The following were the cases thus selected and proved.¹

I. Given (a) a semicircle and a straight line at right angles to the base, or (b) two semicircles with their bases in a straight line, to insert a straight line of given length verging to an angle of the semicircle [or of one of the semicircles].

II. Given a rhombus with one side produced, to insert a straight line of given length in the external angle so that it verges to the opposite angle.

¹ Pappus, vii, pp. 670-2.



THIS PAGE IS LOCKED TO FREE MEMBERS

Purchase full membership to immediately unlock this page

DELVE INTO FANTASY, MAGIC, MYTHOLOGY & FOLKLORE

Forgotten Books'
Full Membership gives
access to 797,885 ancient
and modern, fiction and
non-fiction books.

Continue

*Fair usage policy applies

Therefore the triangles BEK , KEC , which have the angle BEK common, are similar, and

$$\angle CBK = \angle CKE = \angle CHE \text{ (from above).}$$

But $\angle HCE = \angle ACB = \angle BCK$.

Therefore in the triangles CBK , CHE two angles are respectively equal, so that $\angle CEH = \angle CKB$ also.

But since $\angle CKE = \angle CHE$ (from above), K , C , E , H are concyclic.

Hence $\angle CEH + \angle CKH =$ (two right angles);

therefore, since $\angle CEH = \angle CKB$,

$$\angle CKB + \angle CKH = \text{(two right angles),}$$

and BKH is a straight line.

It is certain, from the nature of this lemma, that Apollonius made his construction by drawing the circle shown in the figure.

He would no doubt arrive at it by analysis somewhat as follows.

Suppose the problem solved, and HK inserted as required ($= k$).

Bisect HK in N , and draw NE at right angles to KH meeting BC produced in E . Draw KM perpendicular to BC , and produce it to meet AC in L . Then, by the property of the rhombus, $LM = MK$, and, since $KN = NH$ also, MN is parallel to LH .

Now, since the angles at M , N are right, M , K , N , E are concyclic.

Therefore $\angle CEK = \angle MNK = \angle CHK$, so that C , K , H , E are concyclic.

Therefore $\angle BCD =$ supplement of $KCE = \angle EHK = \angle EKH$, and the triangles EKH , DCB are similar.

Lastly,

$$\angle EBK = \angle EKH - \angle CEK = \angle EHK - \angle CHK = \angle EHC = \angle EKC;$$

therefore the triangles EBK , EKC are similar, and

$$BE : EK = EK : EC,$$

or

$$BE \cdot EC = EK^2.$$

But, by similar triangles EKH , DCB ,

$$EK : KH = DC : CB,$$

and, since the ratio $DC : CB$, as well as KH ; is given, EK is given.

The construction then is as follows.

If k be the given length, take a straight line p such that

$$p : k = AB : BC ;$$

apply to BC a rectangle $BE \cdot EC$ equal to p^2 and exceeding by a square; then with E as centre and radius equal to p describe a circle cutting AC produced in H and CD in K . HK is then equal to k and, by Pappus's lemma, verges towards B .

Pappus adds an interesting solution of the same problem with reference to a square instead of a rhombus; the solution is by one Heraclitus and depends on a lemma which Pappus also gives.¹

We hear of yet other lost works by Apollonius.

(η) *A Comparison of the dodecahedron with the icosahedron.* This is mentioned by Hypsicles in the preface to the so-called Book XIV of Euclid. Like the *Conics*, it appeared in two editions, the second of which contained the proposition that, if there be a dodecahedron and an icosahedron inscribed in one and the same sphere, the surfaces of the solids are in the same ratio as their volumes; this was established by showing that the perpendiculars from the centre of the sphere to a pentagonal face of the dodecahedron and to a triangular face of the icosahedron are equal.

(θ) Marinus on Euclid's *Data* speaks of a *General Treatise* ($\kappa\alpha\theta\acute{o}\lambda\omicron\upsilon\ \pi\rho\alpha\gamma\mu\alpha\tau\epsilon\acute{\iota}\alpha$) in which Apollonius used the word *assigned* ($\tau\epsilon\tau\alpha\gamma\mu\acute{\epsilon}\nu\omicron\nu$) as a comprehensive term to describe the *datum* in general. It would appear that this work must have dealt with the fundamental principles of mathematics, definitions, axioms, &c., and that to it must be referred the various remarks on such subjects attributed to Apollonius by Proclus, the elucidation of the notion of a line, the definition

¹ Pappus, vii, pp. 780-4.

of plane and solid angles, and his attempts to prove the axioms ; it must also have included the three definitions (13–15) in Euclid's *Data* which, according to a scholium, were due to Apollonius and must therefore have been interpolated (they are definitions of *κατηγμένη*, *ἀνηγμένη*, and the elliptical phrase *παρὰ θέσει*, which means 'parallel to a straight line given in position'). Probably the same work also contained Apollonius's alternative constructions for the problems of Eucl. I. 10, 11 and 23 given by Proclus. Pappus speaks of a mention by Apollonius 'before his own elements' of the class of locus called *ἐφεκτικός*, and it may be that the treatise now in question is referred to rather than the *Plane Loci* itself.

(ι) The work *On the Cochlias* was on the cylindrical helix. It included the theoretical generation of the curve on the surface of the cylinder, and the proof that the curve is *homoeomeric* or uniform, i.e. such that any part will fit upon or coincide with any other.

(κ) A work on *Unordered Irrationals* is mentioned by Proclus, and a scholium on Eucl. X. 1 extracted from Pappus's commentary remarks that 'Euclid did not deal with all rationals and irrationals, but only with the simplest kinds by the combination of which an infinite number of irrationals are formed, of which latter Apollonius also gave some'. To a like effect is a passage of the fragment of Pappus's commentary on Eucl. X discovered in an Arabic translation by Woepcke: 'it was Apollonius who, besides the *ordered* irrational magnitudes, showed the existence of the *unordered*, and by accurate methods set forth a great number of them'. The hints given by the author of the commentary seem to imply that Apollonius's extensions of the theory of irrationals took two directions, (1) generalizing the *medial* straight line of Euclid, on the basis that, between two lines commensurable in square (only), we may take not only one sole medial line but three or four, and so on *ad infinitum*, since we can take, between any two given straight lines, as many lines as we please in continued proportion, (2) forming compound irrationals by the addition and subtraction of more than two terms of the sort composing the *binomials*, *apotomes*, &c.



THIS PAGE IS LOCKED TO FREE MEMBERS

Purchase full membership to immediately unlock this page

FORGOTTEN BOOKS

FULL

MEMBERSHIP

797,885 Books!

All you can read

for only

\$8.99/month

Continue

*Fair usage policy applies



Astronomy.

We are told by Ptolemaeus Chennus¹ that Apollonius was famed for his astronomy, and was called ϵ (Epsilon) because the form of that letter is associated with that of the moon, to which his accurate researches principally related. Hippolytus says he made the distance of the moon's circle from the surface of the earth to be 500 myriads of stades.² This figure can hardly be right, for, the diameter of the earth being, according to Eratosthenes's evaluation, about eight myriads of stades, this would make the distance of the moon from the earth about 125 times the earth's radius. This is an unlikely figure, seeing that Aristarchus had given limits for the ratios between the distance of the moon and its diameter, and between the diameters of the moon and the earth, which lead to about 19 as the ratio of the moon's distance to the earth's radius. Tannery suggests that perhaps Hippolytus made a mistake in copying from his source and took the figure of 5,000,000 stades to be the length of the radius instead of the *diameter* of the moon's orbit.

But we have better evidence of the achievements of Apollonius in astronomy. In Ptolemy's *Syntaxis*³ he appears as an authority upon the hypotheses of epicycles and eccentrics designed to account for the apparent motions of the planets. The propositions of Apollonius quoted by Ptolemy contain exact statements of the alternative hypotheses, and from this fact it was at one time concluded that Apollonius invented the two hypotheses. This, however, is not the case. The hypothesis of epicycles was already involved, though with restricted application, in the theory of Heraclides of Pontus that the two inferior planets, Mercury and Venus, revolve in circles like satellites round the sun, while the sun itself revolves in a circle round the earth; that is, the two planets describe epicycles about the material sun as moving centre. In order to explain the motions of the superior planets by means of epicycles it was necessary to conceive of an epicycle about a point as moving centre which is not a material but a mathematical point. It was some time before this extension of the theory of epicycles took place, and in the meantime

¹ *apud Photium*, Cod. cxc, p. 151 b 18, ed. Bekker.

² *Hippol. Refut.* iv. 8, p. 66, ed. Duncker. ³ Ptolemy, *Syntaxis*, xii. 1.

another hypothesis, that of eccentrics, was invented to account for the movements of the superior planets only. We are at this stage when we come to Apollonius. His enunciations show that he understood the theory of epicycles in all its generality, but he states specifically that the theory of eccentrics can only be applied to the three planets which can be at any distance from the sun. The reason why he says that the eccentric hypothesis will not serve for the inferior planets is that, in order to make it serve, we should have to suppose the circle described by the centre of the eccentric circle to be greater than the eccentric circle itself. (Even this generalization was made later, at or before the time of Hipparchus.) Apollonius further says in his enunciation about the eccentric that 'the centre of the eccentric circle moves about the centre of the zodiac in the direct order of the signs and *at a speed equal to that of the sun*, while the star moves on the eccentric about its centre in the inverse order of the signs and at a speed equal to the anomaly'. It is clear from this that the theory of eccentrics was invented for the specific purpose of explaining the movements of Mars, Jupiter, and Saturn about the sun and for that purpose alone. This explanation, combined with the use of epicycles about the sun as centre to account for the motions of Venus and Mercury, amounted to the system of Tycho Brahe; that system was therefore anticipated by some one intermediate in date between Heraclides and Apollonius and probably nearer to the latter, or it may have been Apollonius himself who took this important step. If it was, then Apollonius, coming after Aristarchus of Samos, would be exactly the Tycho Brahe of the Copernicus of antiquity. The actual propositions quoted by Ptolemy as proved by Apollonius among others show mathematically at what points, under each of the two hypotheses, the apparent forward motion changes into apparent retrogradation and vice versa, or the planet appears to be *stationary*.

THE SUCCESSORS OF THE GREAT GEOMETERS

WITH Archimedes and Apollonius Greek geometry reached its culminating point. There remained details to be filled in, and no doubt in a work such as, for instance, the *Conics* geometers of the requisite calibre could have found propositions containing the germ of theories which were capable of independent development. But, speaking generally, the further progress of geometry on general lines was practically barred by the restrictions of method and form which were inseparable from the classical Greek geometry. True, it was open to geometers to discover and investigate curves of a higher order than conics, such as spirals, conchoids, and the like. But the Greeks could not get very far even on these lines in the absence of some system of coordinates and without freer means of manipulation such as are afforded by modern algebra, in contrast to the geometrical algebra, which could only deal with equations connecting lines, areas, and volumes, but involving no higher dimensions than three, except in so far as the use of proportions allowed a very partial exemption from this limitation. The theoretical methods available enabled quadratic, cubic and bi-quadratic equations or their equivalents to be solved. But all the solutions were *geometrical*; in other words, quantities could only be represented by lines, areas and volumes, or ratios between them. There was nothing corresponding to operations with general algebraical quantities irrespective of what they represented. There were no *symbols* for such quantities. In particular, the irrational was discovered in the form of incommensurable *lines*; hence irrationals came to be represented by straight lines as they are in Euclid, Book X, and the Greeks had no other way of representing them. It followed that a product of two irrationals could only be represented by a *rectangle*, and so on. Even when Diophantus came to use a symbol for an unknown



THIS PAGE IS LOCKED TO FREE MEMBERS

Purchase full membership to immediately unlock this page

DELVE INTO FANTASY, MAGIC, MYTHOLOGY & FOLKLORE

Forgotten Books'
Full Membership gives
access to 797,885 ancient
and modern, fiction and
non-fiction books.

Continue

*Fair usage policy applies

tators, and especially by Pappus and Eutocius. Some of these are very interesting, and it is evident from the extracts from the works of such writers as Diocles and Dionysodorus that, for some time after Archimedes and Apollonius, mathematicians had a thorough grasp of the contents of the works of the great geometers, and were able to use the principles and methods laid down therein with ease and skill.

Two geometers properly belonging to this chapter have already been dealt with. The first is NICOMEDES, the inventor of the conchoid, who was about intermediate in date between Eratosthenes and Apollonius. The conchoid has already been described above (vol. i, pp. 238–40). It gave a general method of solving any $\nu\epsilon\upsilon\sigma\iota\varsigma$ where one of the lines which cut off an intercept of given length on the line verging to a given point is a straight line; and it was used both for the finding of two mean proportionals and for the trisection of any angle, these problems being alike reducible to a $\nu\epsilon\theta\sigma\iota\varsigma$ of this kind. How far Nicomedes discussed the properties of the curve in itself is uncertain; we only know from Pappus that he proved two properties, (1) that the so-called ‘ruler’ in the instrument for constructing the curve is an asymptote, (2) that any straight line drawn in the space between the ‘ruler’ or asymptote and the conchoid must, if produced, be cut by the conchoid.¹ The equation of the curve referred to polar coordinates is, as we have seen, $r = a + b \sec \theta$. According to Eutocius, Nicomedes prided himself inordinately on his discovery of this curve, contrasting it with Eratosthenes’s mechanism for finding any number of mean proportionals, to which he objected formally and at length on the ground that it was impracticable and entirely outside the spirit of geometry.²

Nicomedes is associated by Pappus with Dinostratus, the brother of Menaechmus, and others as having applied to the squaring of the circle the curve invented by Hippias and known as the *quadratrix*,³ which was originally intended for the purpose of trisecting any angle. These facts are all that we know of Nicomedes’s achievements.

¹ Pappus, iv, p. 244. 21–8.

² Eutoc. on Archimedes, *On the Sphere and Cylinder*, Archimedes, vol. iii, p. 98.

³ Pappus, iv, pp. 250. 33–252. 4. Cf. vol. i, p. 225 sq.

The second name is that of DIOCLES. We have already (vol. i, pp. 264–6) seen him as the discoverer of the curve known as the *cissoïd*, which he used to solve the problem of the two mean proportionals, and also (pp. 47–9 above) as the author of a method of solving the equivalent of a certain cubic equation by means of the intersection of an ellipse and a hyperbola. We are indebted for our information on both these subjects to Eutocius,¹ who tells us that the fragments which he quotes came from Diocles's work *περὶ πυρρείων*, *On burning-mirrors*. The connexion of the two things with the subject of this treatise is not obvious, and we may perhaps infer that it was a work of considerable scope. What exactly were the forms of the burning-mirrors discussed in the treatise it is not possible to say, but it is probably safe to assume that among them were concave mirrors in the forms (1) of a sphere, (2) of a paraboloid, and (3) of the surface described by the revolution of an ellipse about its major axis. The author of the *Fragmentum mathematicum Bobiense* says that Apollonius in his book *On the burning-mirror* discussed the case of the concave spherical mirror, showing about what point ignition would take place; and it is certain that Apollonius was aware that an ellipse has the property of reflecting all rays through one focus to the other focus. Nor is it likely that the corresponding property of a parabola with reference to rays parallel to the axis was unknown to Apollonius. Diocles therefore, writing a century or more later than Apollonius, could hardly have failed to deal with all three cases. True, Anthemius (died about A.D. 534) in his fragment on burning-mirrors says that the ancients, while mentioning the usual burning-mirrors and saying that such figures are conic sections, omitted to specify which conic sections, and how produced, and gave no geometrical proofs of their properties. But if the properties were commonly known and quoted, it is obvious that they must have been proved by the ancients, and the explanation of Anthemius's remark is presumably that the original works in which they were proved (e.g. those of Apollonius and Diocles) were already lost when he wrote. There appears to be no trace of Diocles's work left either in Greek or Arabic,

¹ Eutocius, *loc. cit.*, p. 66. 8 sq., p. 160. 3 sq.

unless we have a fragment from it in the *Fragmentum mathematicum Bobiense*. But Moslem writers regarded Diocles as the discoverer of the parabolic burning-mirror; 'the ancients', says al Singārī (Sachāwī, Anṣārī), 'made mirrors of plane surfaces. Some made them concave (i.e. spherical) until Diocles (Diūklis) showed and proved that, if the surface of these mirrors has its curvature in the form of a parabola, they then have the greatest power and burn most strongly. There is a work on this subject composed by Ibn al-Haitham.' This work survives in Arabic and in Latin translations, and is reproduced by Heiberg and Wiedemann¹; it does not, however, mention the name of Diocles, but only those of Archimedes and Anthemius. Ibn al-Haitham says that famous men like Archimedes and Anthemius had used mirrors made up of a number of spherical rings; afterwards, he adds, they considered the form of curves which would reflect rays to one point, and found that the concave surface of a paraboloid of revolution has this property. It is curious to find Ibn al-Haitham saying that the ancients had not set out the proofs sufficiently, nor the method by which they discovered them, words which almost exactly recall those of Anthemius himself. Nevertheless the whole course of Ibn al-Haitham's proofs is on the Greek model, Apollonius being actually quoted by name in the proof of the main property of the parabola required, namely that the tangent at any point of the curve makes equal angles with the focal distance of the point and the straight line drawn through it parallel to the axis. A proof of the property actually survives in the Greek *Fragmentum mathematicum Bobiense*, which evidently came from some treatise on the parabolic burning-mirror; but Ibn al-Haitham does not seem to have had even this fragment at his disposal, since his proof takes a different course, distinguishing three different cases, reducing the property by analysis to the known property $AN = AT$, and then working out the synthesis. The proof in the *Fragmentum* is worth giving. It is substantially as follows, beginning with the preliminary lemma that, if PT , the tangent at any point P , meets the axis at T , and if AS be measured along the axis from the vertex A equal to $\frac{1}{4}AL$, where AL is the parameter, then $SP = ST$.

¹ *Bibliotheca mathematica*, x₃, 1910, pp. 201-37.



THIS PAGE IS LOCKED TO FREE MEMBERS

Purchase full membership to immediately unlock this page

FORGOTTEN BOOKS

FULL

MEMBERSHIP

797,885 Books!

All you can read

for only

\$8.99/month

Continue

*Fair usage policy applies



above shown, be proved to bring about ignition at the point indicated.'

Heiberg held that the style of this fragment is Byzantine and that it is probably by Anthemius. Cantor conjectured that here we might, after all, have an extract from Diocles's work. Heiberg's supposition seems to me untenable because of the author's use (1) of the ancient terms 'section of a right-angled cone' for parabola and 'diameter' for axis (to say nothing of the use of the parameter, of which there is no word in the genuine fragment of Anthemius), and (2) of the mixed 'angles of contact'. Nor does it seem likely that even Diocles, living a century after Apollonius, would have spoken of the 'section of a right-angled cone' instead of a parabola, or used the 'mixed' angle of which there is only the merest survival in Euclid. The assumption of the equality of the two angles made by the curve with the tangent on both sides of the point of contact reminds us of Aristotle's assumption of the equality of the angles 'of a segment' of a circle as prior to the truth proved in Eucl. I. 5. I am inclined, therefore, to date the fragment much earlier even than Diocles. Zeuthen suggested that the property of the paraboloidal mirror may have been discovered by Archimedes, who, according to a Greek tradition, wrote *Catoptrica*. This, however, does not receive any confirmation in Ibn al-Haitham or in Anthemius, and we can only say that the fragment at least goes back to an original which was probably not later than Apollonius.

PERSEUS is only known, from allusions to him in Proclus,¹ as the discoverer and investigator of the *spiric sections*. They are classed by Proclus among curves obtained by cutting solids, and in this respect they are associated with the conic sections. We may safely infer that they were discovered after the conic sections, and only after the theory of conics had been considerably developed. This was already the case in Euclid's time, and it is probable, therefore, that Perseus was not earlier than Euclid. On the other hand, by that time the investigation of conics had brought the exponents of the subject such fame that it would be natural for mathematicians to see whether there was not an opportunity for winning a

¹ Proclus on Eucl. I, pp. 111, 23-112, 8, 356, 12. Cf. vol. i, p. 226.

like renown as discoverers of other curves to be obtained by cutting well-known solid figures other than the cone and cylinder. A particular case of one such solid figure, the *σπεῖρα*, had already been employed by Archytas, and the more general form of it would not unnaturally be thought of as likely to give sections worthy of investigation. Since Geminus is Proclus's authority, Perseus may have lived at any date from Euclid's time to (say) 75 B.C., but the most probable supposition seems to be that he came before Apollonius and near to Euclid in date.

The *spire* in one of its forms is what we call a *tore*, or an anchor-ring. It is generated by the revolution of a circle about a straight line in its plane in such a way that the plane of the circle always passes through the axis of revolution. It takes three forms according as the axis of revolution is (a) altogether outside the circle, when the spire is *open* (*διεχής*), (b) a tangent to the circle, when the surface is *continuous* (*συνεχής*), or (c) a chord of the circle, when it is *interlaced* (*ἐμπεπλεγμένη*), or *crossing-itself* (*ἐπαλλάττουσα*); an alternative name for the surface was *κρίκος*, a *ring*. Perseus celebrated his discovery in an epigram to the effect that 'Perseus on his discovery of three lines (curves) upon five sections gave thanks to the gods therefor'.¹ There is some doubt about the meaning of 'three lines upon five sections' (*τρεις γραμμὰς ἐπὶ πέντε τομαῖς*). We gather from Proclus's account of three sections distinguished by Perseus that the plane of section was always parallel to the axis of revolution or perpendicular to the plane which cuts the tore symmetrically like the division in a split-ring. It is difficult to interpret the phrase if it means three curves made by five different sections. Proclus indeed implies that the three curves were sections of the three kinds of tore respectively (the open, the closed, and the interlaced), but this is evidently a slip. Tannery interprets the phrase as meaning 'three curves *in addition to* five sections'.² Of these the five sections belong to the open tore, in which the distance (*c*) of the centre of the generating circle from the axis of revolution is greater than the radius (*a*) of the generating circle. If *d* be the perpen-

¹ Proclus on Eucl. I, p. 112. 2.

² See Tannery, *Mémoires scientifiques*, II, pp. 24-8.

dicular distance of the plane of section from the axis of rotation, we can distinguish the following cases :

(1) $c + a > d > c$. Here the curve is an oval.

(2) $d = c$: transition from case (1) to the next case.

(3) $c > d > c - a$. The curve is now a closed curve narrowest in the middle.

(4) $d = c - a$. In this case the curve is the *hippopede* (horse-fetter), a curve in the shape of the figure of 8. The lemniscate of Bernoulli is a particular case of this curve, that namely in which $c = 2a$.

(5) $c - a > d > 0$. In this case the section consists of two ovals symmetrical with one another.

The three curves specified by Proclus are those corresponding to (1), (3) and (4).

When the tore is 'continuous' or closed, $c = a$, and we have sections corresponding to (1), (2) and (3) only; (4) reduces to two circles touching one another.

But Tannery finds in the third, the interlaced, form of tore three new sections corresponding to (1) (2) (3), each with an oval in the middle. This would make three curves in addition to the five sections, or eight curves in all. We cannot be certain that this is the true explanation of the phrase in the epigram; but it seems to be the best suggestion that has been made.

According to Proclus, Perseus worked out the property of his curves, as Nicomedes did that of the conchoid, Hippias that of the *quadratrix*, and Apollonius those of the three conic sections. That is, Perseus must have given, in some form, the equivalent of the Cartesian equation by which we can represent the different curves in question. If we refer the tore to three axes of coordinates at right angles to one another with the centre of the tore as origin, the axis of y being taken to be the axis of revolution, and those of z , x being perpendicular to it in the plane bisecting the tore (making it a split-ring), the equation of the tore is

$$(x^2 + y^2 + z^2 + c^2 - a^2)^2 = 4c^2(z^2 + x^2),$$



THIS PAGE IS LOCKED TO FREE MEMBERS

Purchase full membership to immediately unlock this page

DELVE INTO FANTASY, MAGIC, MYTHOLOGY & FOLKLORE

Forgotten Books'
Full Membership gives
access to 797,885 ancient
and modern, fiction and
non-fiction books.

Continue

*Fair usage policy applies

themselves, so that, while they got a reputation for greater honesty, they in fact took more than their share of the produce.¹ Several remarks by ancient authors show the prevalence of the same misconception. Thucydides estimates the size of Sicily according to the time required for circumnavigating it.² About 130 B.C. Polybius observed that there were people who could not understand that camps of the same periphery might have different capacities.³ Quintilian has a similar remark, and Cantor thinks he may have had in his mind the calculations of Pliny, who compares the size of different parts of the earth by adding their lengths to their breadths.⁴

ZENODORUS wrote, at some date between (say) 200 B.C. and A.D. 90, a treatise *περὶ ἰσομέτρων σχημάτων*, *On isometric figures*. A number of propositions from it are preserved in the commentary of Theon of Alexandria on Book I of Ptolemy's *Syntaxis*; and they are reproduced in Latin in the third volume of Hultsch's edition of Pappus, for the purpose of comparison with Pappus's own exposition of the same propositions at the beginning of his Book V, where he appears to have followed Zenodorus pretty closely while making some changes in detail.⁵ From the closeness with which the style of Zenodorus follows that of Euclid and Archimedes we may judge that his date was not much later than that of Archimedes, whom he mentions as the author of the proposition (*Measurement of a Circle*, Prop. 1) that the area of a circle is half that of the rectangle contained by the perimeter of the circle and its radius. The important propositions proved by Zenodorus and Pappus include the following: (1) *Of all regular polygons of equal perimeter, that is the greatest in area which has the most angles.* (2) *A circle is greater than any regular polygon of equal contour.* (3) *Of all polygons of the same number of sides and equal perimeter the equilateral and equiangular polygon is the greatest in area.* Pappus added the further proposition that *Of all segments of a circle having the same circumference the semicircle is the greatest in*

¹ Proclus on Eucl. I, p. 403. 5 sq.

² Thuc. vi: 1.

³ Polybius, ix. 21.

⁴ Pliny, *Hist. nat.* vi. 208.

⁵ Pappus, v, p. 308 sq.

area. Zenodorus's treatise was not confined to propositions about plane figures, but gave also the theorem that *Of all solid figures the surfaces of which are equal, the sphere is the greatest in solid content.*

We will briefly indicate Zenodorus's method of proof. To begin with (1); let ABC , DEF be equilateral and equiangular polygons of the same perimeter, DEF having more angles than ABC . Let G , H be the centres of the circumscribing circles, GK , HL the perpendiculars from G , H to the sides AB , DE , so that K , L bisect those sides.

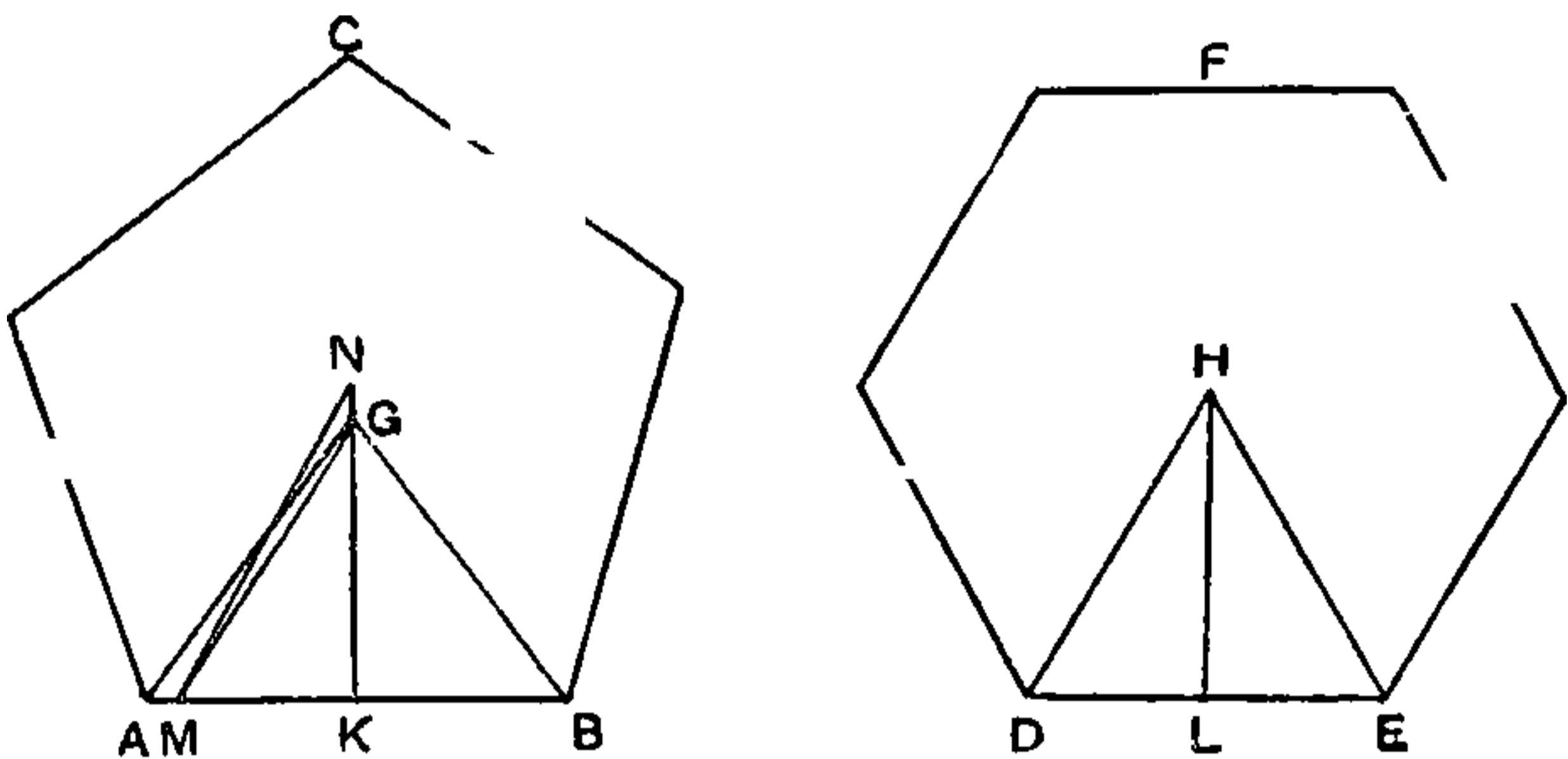

Since the perimeters are equal, $AB > DE$, and $AK > DL$. Make KM equal to DL and join GM .

Since AB is the same fraction of the perimeter that the angle AGB is of four right angles, and DE is the same fraction of the same perimeter that the angle DHE is of four right angles, it follows that

$$AB : DE = \angle AGB : \angle DHE,$$

that is, $AK : MK = \angle AGK : \angle DHL.$

But $AK : MK > \angle AGK : \angle MGK$

(this is easily proved in a lemma following by the usual method of drawing an arc of a circle with G as centre and GM as radius cutting GA and GK produced. The proposition is of course equivalent to $\tan \alpha / \tan \beta > \alpha / \beta$, where $\frac{1}{2}\pi > \alpha > \beta$).

Therefore $\angle MGK > \angle DHL,$

and consequently $\angle GMK < \angle HDL.$

Make the angle NMK equal to the angle HDL , so that MN meets GK produced in N .

The triangles NMK , HDL are now equal in all respects, and NK is equal to HL , so that $GK < HL$.

But the area of the polygon ABC is half the rectangle contained by GK and the perimeter, while the area of the polygon DEF is half the rectangle contained by HL and the same perimeter. Therefore the area of the polygon DEF is the greater.

(2) The proof that a circle is greater than any regular polygon with the same perimeter is deduced immediately from Archimedes's proposition that the area of a circle is equal to the right-angled triangle with perpendicular side equal to the radius and base equal to the perimeter of the circle; Zenodorus inserts a proof *in extenso* of Archimedes's proposition, with preliminary lemma. The perpendicular from the centre of the circle circumscribing the polygon is easily proved to be less than the radius of the given circle with perimeter equal to that of the polygon; whence the proposition follows.

(3) The proof of this proposition depends on some preliminary lemmas. The first proves that, if there be two triangles on the same base and with the same perimeter, one being isosceles and the other scalene, the isosceles triangle has the greater area. (Given the scalene triangle BDC on the base BC , it is easy to draw on BC as base the isosceles triangle having the same perimeter. We have only to take BH equal to $\frac{1}{2}(BD + DC)$, bisect BC at E , and erect at E the perpendicular AE such that $AE^2 = BH^2 - BE^2$.)

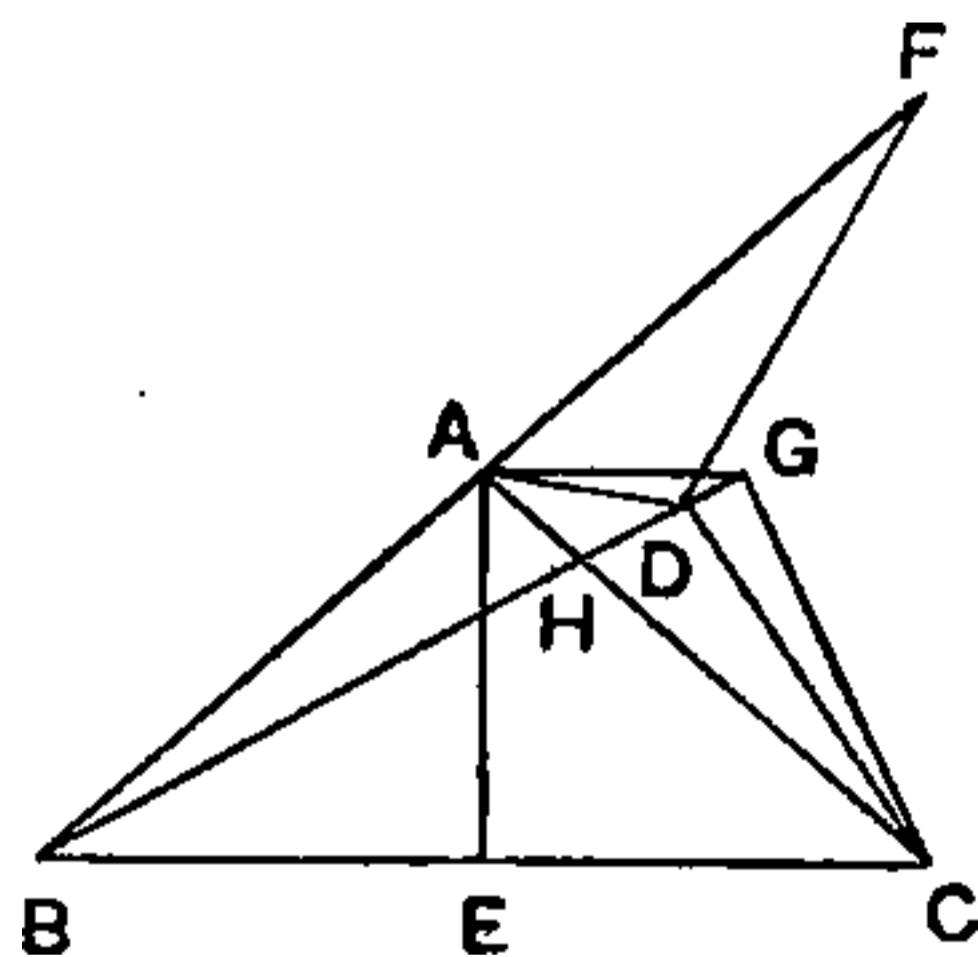

Produce BA to F so that $BA = AF$, and join AD , DF .

Then $BD + DF > BF$, i.e. $BA + AC$, i.e. $BD + DC$, by hypothesis; therefore $DF > DC$, whence in the triangles FAD , CAD the angle $FAD >$ the angle CAD .

Therefore
$$\angle FAD > \frac{1}{2} \angle FAC$$

$$> \angle BCA.$$

Make the angle FAG equal to the angle BCA or ABC , so that AG is parallel to BC ; let BD produced meet AG in G , and join GC .



THIS PAGE IS LOCKED TO FREE MEMBERS

Purchase full membership to immediately unlock this page

FORGOTTEN BOOKS

FULL

MEMBERSHIP

797,885 Books!

All you can read

for only

\$8.99/month

Continue

*Fair usage policy applies



Now, by hypothesis, $DB + BA = GB + BF$;
therefore $DB + BA = HB + BF > HF$.

By an easy lemma, since the triangles DEB , ABC are similar,

$$\begin{aligned} (DB + BA)^2 &= (DL + AK)^2 + (BL + BK)^2 \\ &= (DL + AK)^2 + LK^2. \end{aligned}$$

Therefore $(DL + AK)^2 + LK^2 > HF^2$
 $> (GL + FK)^2 + LK^2$,

whence $DL + AK > GL + FK$,

and it follows that $AF > GD$.

But $BK > BL$; therefore $AF \cdot BK > GD \cdot BL$.

Hence the 'hollow-angled (figure)' (*κοιλογώνιον*) $ABFC$ is greater than the hollow-angled (figure) $GEDB$.

Adding $\triangle DEB + \triangle BFC$ to each, we have

$$\triangle DEB + \triangle ABC > \triangle GEB + \triangle FBC.$$

The above is the only case taken by Zenodorus. The proof still holds if $EB = BC$, so that $BK = BL$. But it fails in the case in which $EB > BC$ and the vertex G of the triangle EB belonging to the non-similar pair is still above D and not below it (as F is below A in the preceding case). This was no doubt the reason why Pappus gave a proof intended to apply to all the cases without distinction. This proof is the same as the above proof by Zenodorus up to the point where it is proved that

$$DL + AK > GL + FK,$$

but there diverges. Unfortunately the text is bad, and gives no sufficient indication of the course of the proof; but it would seem that Pappus used the relations:

$$DL : GL = \triangle DEB : \triangle GEB,$$

$$AK : FK = \triangle ABC : \triangle FBC,$$

and $AK^2 : DL^2 = \triangle ABC : \triangle DEB$,

combined of course with the fact that $GB + BF = DB + BA$, in order to prove the proposition that,

according as $DL + AK >$ or $< GL + FK$,

$$\triangle DEB + \triangle ABC > \text{ or } < \triangle GEB + \triangle FBC.$$

The proof of his proposition, whatever it was, Pappus indicates that he will give later; but in the text as we have it the promise is not fulfilled.

Then follows the proof that the maximum polygon of given perimeter is both equilateral and equiangular.

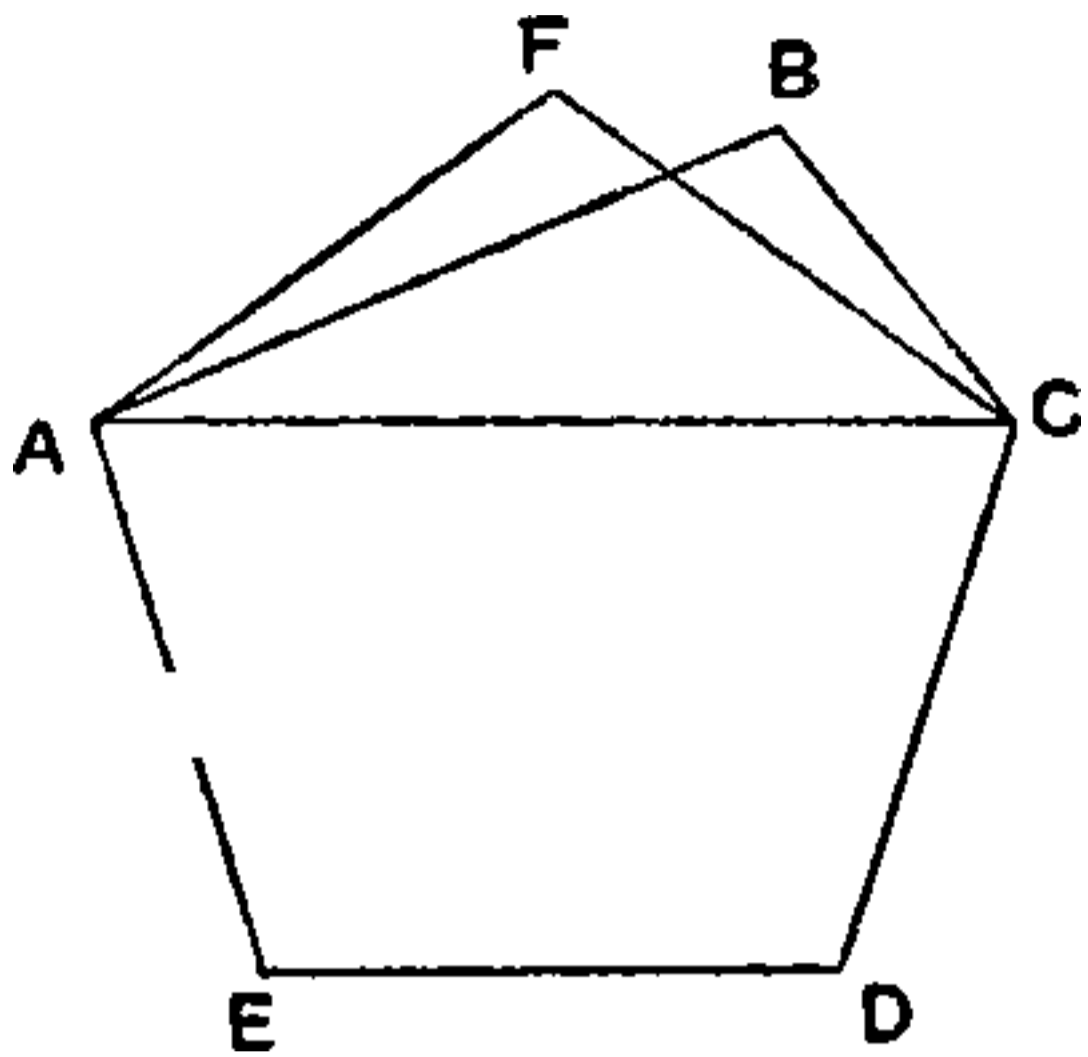

(1) It is equilateral.

For, if not, let two sides of the maximum polygon, as AB , BC , be unequal. Join AC , and on AC as base draw the isosceles triangle AFC such that $AF + FC = AB + BC$. The area of the triangle AFC is then greater than the area of the triangle ABC , and the area of the whole polygon has been increased by the construction: which is impossible, as by hypothesis the area is a maximum.

Similarly it can be proved that no other side is unequal to any other.

(2) It is also equiangular.

For, if possible, let the maximum polygon $ABCDE$ (which we have proved to be equilateral) have the angle at B greater than the angle at D . Then BAC , DEC are non-similar isosceles triangles. On AC , CE as bases describe the two isosceles triangles FAC , GEC similar to one another which have the sum of their perimeters equal to the sum of the perimeters of BAC , DEC . Then the sum of the areas of the two similar isosceles triangles is greater than the sum of the areas of the triangles BAC , DEC ; the area of the polygon is therefore increased, which is contrary to the hypothesis.

Hence no two angles of the polygon can be unequal.

The maximum polygon of given perimeter is therefore both equilateral and equiangular.

Dealing with the sphere in relation to other solids having

their surfaces equal to that of the sphere, Zenodorus confined himself to proving (1) that the sphere is greater if the other solid with surface equal to that of the sphere is a solid formed by the revolution of a regular polygon about a diameter bisecting it as in Archimedes, *On the Sphere and Cylinder*, Book I, and (2) that the sphere is greater than any of the regular solids having its surface equal to that of the sphere.

Pappus's treatment of the subject is more complete in that he proves that the sphere is greater than the cone or cylinder the surface of which is equal to that of the sphere, and further that of the five regular solids which have the same surface that which has more faces is the greater.¹

HYPsicLES (second half of second century B.C.) has already been mentioned (vol. i, pp. 419–20) as the author of the continuation of the *Elements* known as Book XIV. He is quoted by Diophantus as having given a definition of a polygonal number as follows:

‘If there are as many numbers as we please beginning from 1 and increasing by the same common difference, then, when the common difference is 1, the sum of all the numbers is a triangular number; when 2, a square; when 3, a pentagonal number [and so on]. And the number of angles is called after the number which exceeds the common difference by 2, and the side after the number of terms including 1.’

This definition amounts to saying that the n th a -gonal number (1 counting as the first) is $\frac{1}{2}n \{2 + (n-1)(a-2)\}$. If, as is probable, Hypsicles wrote a treatise on polygonal numbers, it has not survived. On the other hand, the *Ἀναφορικός* (*Ascensiones*) known by his name has survived in Greek as well as in Arabic, and has been edited with translation.² True, the treatise (if it really be by Hypsicles, and not a clumsy effort by a beginner working from an original by Hypsicles) does no credit to its author; but it is in some respects interesting, and in particular because it is the first Greek

¹ Pappus, v, Props. 19, 38–56.

² Manitius, *Des Hypsikles Schrift Anaphorikos*, Dresden, Lehmannsche Buchdruckerei, 1888.



THIS PAGE IS LOCKED TO FREE MEMBERS

Purchase full membership to immediately unlock this page

DELVE INTO FANTASY, MAGIC, MYTHOLOGY & FOLKLORE

Forgotten Books'
Full Membership gives
access to 797,885 ancient
and modern, fiction and
non-fiction books.

Continue

*Fair usage policy applies

natural to divide each of the sixth parts into either 10 or 60 parts; the former division would account for the attested division of the day into 60 hours, while the latter division on the sexagesimal system would give the 360 time-degrees (each of 4 minutes) making up the day of 24 hours. The purely arithmetical explanation is defective in that the series of numbers for which the Babylonians had special names is not 60, 360, 3600 but 60 (Soss), 600 (Ner), and 3600 or 60^2 (Sar). On the whole, after all that has been said, I know of no better suggestion than that of Tannery.¹ It is certain that both the division of the ecliptic into 360 degrees and that of the *νυχθήμερον* into 360 time-degrees were adopted by the Greeks from Babylon. Now the earliest division of the ecliptic was into 12 parts, the signs, and the question is, how were the signs subdivided? Tannery observes that, according to the cuneiform inscriptions, as well as the testimony of Greek authors, the sign was divided into parts one of which (*dargatu*) was double of the other (*murrān*), the former being $1/30$ th, the other (called *stadium* by Manilius) $1/60$ th, of the sign; the former division would give 360 parts, the latter 720 parts for the whole circle. The latter division was more natural, in view of the long-established system of sexagesimal fractions; it also had the advantage of corresponding tolerably closely to the apparent diameter of the sun in comparison with the circumference of the sun's apparent circle. But, on the other hand, the double fraction, the $1/30$ th, was contained in the circle of the zodiac approximately the same number of times as there are days in the year, and consequently corresponded nearly to the distance described by the sun along the zodiac in one day. It would seem that this advantage was sufficient to turn the scale in favour of dividing each sign of the zodiac into 30 parts, giving 360 parts for the whole circle. While the Chaldaeans thus divided the ecliptic into 360 parts, it does not appear that they applied the same division to the equator or any other circle. They measured angles in general by *ells*, an ell representing 2° , so that the complete circle contained 180, not 360, parts, which they called *ells*. The explanation may perhaps be that the Chaldaeans divided

¹ Tannery, 'La coudée astronomique et les anciennes divisions du cercle' (*Mémoires scientifiques*, ii, pp. 256-68).

the *diameter* of the circle into 60 ells in accordance with their usual sexagesimal division, and then came to divide the circumference into 180 such ells on the ground that the circumference is roughly three times the diameter. The measurement in *ells* and *dactyli* (of which there were 24 to the ell) survives in Hipparchus (*On the Phaenomena of Eudoxus and Aratus*), and some measurements in terms of the same units are given by Ptolemy. It was Hipparchus who first divided the circle in general into 360 parts or degrees, and the introduction of this division coincides with his invention of trigonometry.

The contents of Hypsicles's tract need not detain us long. The problem is: If we know the ratio which the length of the longest day bears to the length of the shortest day at any given place, to find how many time-degrees it takes any given sign to rise; and, after this has been found, the author finds what length of time it takes any given degree in any sign to rise, i.e. the interval between the rising of one degree-point on the ecliptic and that of the next following. It is explained that the longest day is the time during which one half of the zodiac (Cancer, Leo, Virgo, Libra, Scorpio, Sagittarius) rises, and the shortest day the time during which the other half (Capricornus, Aquarius, Pisces, Aries, Taurus, Gemini) rises. Now at Alexandria the longest day is to the shortest as 7 to 5; the longest therefore contains 210 'time-degrees', the shortest 150. The two quadrants Cancer-Virgo and Libra-Sagittarius take the same time to rise, namely 105 time-degrees, and the two quadrants Capricornus-Pisces and Aries-Gemini each take the same time, namely 75 time-degrees. It is further assumed that the times taken by Virgo, Leo, Cancer, Gemini, Taurus, Aries are in descending arithmetical progression, while the times taken by Libra, Scorpio, Sagittarius, Capricornus, Aquarius, Pisces continue the same descending arithmetical series. The following lemmas are used and proved:

I. If $a_1, a_2 \dots a_n, a_{n+1}, a_{n+2} \dots a_{2n}$ is a descending arithmetical progression of $2n$ terms with δ ($= a_1 - a_2 = a_2 - a_3 = \dots$) as common difference,

$$a_1 + a_2 + \dots + a_n - (a_{n+1} + a_{n+2} + \dots + a_{2n}) = n^2 \delta.$$

II. If $a_1, a_2 \dots a_n \dots a_{2n-1}$ is a descending arithmetical progression of $2n-1$ terms with δ as common difference and a_n is the middle term, then

$$a_1 + a_2 + \dots + a_{2n-1} = (2n-1)a_n.$$

III. If $a_1, a_2 \dots a_n, a_{n+1} \dots a_{2n}$ is a descending arithmetical progression of $2n$ terms, then

$$\begin{aligned} a_1 + a_2 + \dots + a_{2n} &= n(a_1 + a_{2n}) = n(a_2 + a_{2n-1}) = \dots \\ &= n(a_n + a_{n+1}). \end{aligned}$$

Now let A, B, C be the descending series the sum of which is 105, and D, E, F the next three terms in the same series the sum of which is 75, the common difference being δ ; we then have, by (I),

$$A + B + C - (D + E + F) = 9\delta, \text{ or } 30 = 9\delta,$$

and $\delta = 3\frac{1}{3}$.

Next, by (II), $A + B + C = 3B$, or $3B = 105$, and $B = 35$; therefore A, B, C, D, E, F are equal to $38\frac{1}{3}, 35, 31\frac{2}{3}, 28\frac{1}{3}, 25, 21\frac{2}{3}$ time-degrees respectively, which the author of the tract expresses in time-degrees and minutes as $38^t 20', 35^t, 31^t 40', 28^t 20', 25^t, 21^t 40'$. We have now to carry through the same procedure for each degree in each sign. If the difference between the times taken to rise by one sign and the next is $3^t 20'$, what is the difference for each of the 30 degrees in the sign? We have here 30 terms followed by 30 other terms of the same descending arithmetical progression, and the formula (I) gives $3^t \cdot 20' = (30)^2 d$, where d is the common difference; therefore $d = \frac{1}{900} \times 3^t \cdot 20' = 0^t 0' 13'' 20'''$. Lastly, take the sign corresponding to $21^t 40'$. This is the sum of a descending arithmetical progression of 30 terms $a_1, a_2 \dots a_{30}$ with common difference $0^t 0' 13'' 20'''$. Therefore, by (III), $21^t 40' = 15(a_1 + a_{30})$, whence $a_1 + a_{30} = 1^t 26' 40''$. Now, since there are 30 terms $a_1, a_2 \dots a_{30}$, we have

$$a_1 - a_{30} = 29d = 0^t 6' 26'' 40'''.$$

It follows that $a_{30} = 0^t 40' 6'' 40'''$ and $a_1 = 0^t 46' 33'' 20'''$,



THIS PAGE IS LOCKED TO FREE MEMBERS

Purchase full membership to immediately unlock this page

FORGOTTEN BOOKS

FULL

MEMBERSHIP

797,885 Books!

All you can read

for only

\$8.99/month

Continue

*Fair usage policy applies



generates the tore, and c the distance of its centre from the axis of revolution,

$$(\text{volume of tore}) : \pi c^2 \cdot d = \frac{1}{4} \pi d^2 : \frac{1}{2} cd,$$

that is, $(\text{volume of tore}) = \frac{1}{2} \pi^2 \cdot cd^2,$

which is of course the product of the area of the generating circle and the length of the path of its centre of gravity. The form in which the result is stated, namely that the tore is to the cylinder with height d and radius c as the generating circle of the tore is to half the parallelogram cd , indicates quite clearly that Dionysodorus proved his result by the same procedure as that employed by Archimedes in the *Method* and in the book *On Conoids and Spheroids*; and indeed the proof on Archimedean lines is not difficult.

Before passing to the mathematicians who are identified with the discovery and development of trigonometry, it will be convenient, I think, to dispose of two more mathematicians belonging to the last century B.C., although this involves a slight departure from chronological order; I mean Posidonius and Geminus.

POSIDONIUS, a Stoic, the teacher of Cicero, is known as Posidonius of Apamea (where he was born) or of Rhodes (where he taught); his date may be taken as approximately 135–51 B.C. In pure mathematics he is mainly quoted as the author of certain definitions, or for views on technical terms, e.g. ‘theorem’ and ‘problem’, and subjects belonging to elementary geometry. More important were his contributions to mathematical geography and astronomy. He gave his great work on geography the title *On the Ocean*, using the word which had always had such a fascination for the Greeks; its contents are known to us through the copious quotations from it in Strabo; it dealt with physical as well as mathematical geography, the zones, the tides and their connexion with the moon, ethnography and all sorts of observations made during extensive travels. His astronomical book bore the title *Meteorologica* or *περὶ μετεώρων*, and, while Geminus wrote a commentary on or exposition of this work, we may assign to it a number of views quoted from Posidonius in

Cleomedes's work *De motu circulari corporum caelestium*. Posidonius also wrote a separate tract on the size of the sun.

The two things which are sufficiently important to deserve mention here are (1) Posidonius's measurement of the circumference of the earth, (2) his hypothesis as to the distance and size of the sun.

(1) He estimated the circumference of the earth in this way. He assumed (according to Cleomedes¹) that, whereas the star Canopus, invisible in Greece, was just seen to graze the horizon at Rhodes, rising and setting again immediately, the meridian altitude of the same star at Alexandria was 'a fourth part of a sign, that is, one forty-eighth part of the zodiac circle' ($= 7\frac{1}{2}^\circ$); and he observed that the distance between the two places (supposed to lie on the same meridian) 'was considered to be 5,000 stades'. The circumference of the earth was thus made out to be 240,000 stades. Unfortunately the estimate of the difference of latitude, $7\frac{1}{2}^\circ$; was very far from correct, the true difference being $5\frac{1}{4}^\circ$ only; moreover the estimate of 5,000 stades for the distance was incorrect, being only the maximum estimate put upon it by mariners, while some put it at 4,000 and Eratosthenes, by observations of the shadows of gnomons, found it to be 3,750 stades only. Strabo, on the other hand, says that Posidonius favoured 'the latest of the measurements which gave the smallest dimensions to the earth, namely about 180,000 stades'.² This is evidently 48 times 3,750, so that Posidonius combined Eratosthenes's figure of 3,750 stades with the incorrect estimate of $7\frac{1}{2}^\circ$ for the difference of latitude, although Eratosthenes presumably obtained the figure of 3,750 stades from his own estimate (250,000 or 252,000) of the circumference of the earth combined with an estimate of the difference of latitude which was about $5\frac{2}{5}^\circ$ and therefore near the truth.

(2) Cleomedes³ tells us that Posidonius supposed the circle in which the sun apparently moves round the earth to be 10,000 times the size of a circular section of the earth through its centre, and that with this assumption he combined the

¹ Cleomedes, *De motu circulari*, i. 10, pp. 92-4.

² Strabo, ii. c. 95.

³ Cleomedes, *op. cit.* ii. 1, pp. 144-6, p. 98. 1-5.

statement of Eratosthenes (based apparently upon hearsay) that at Syene, which is under the summer tropic, and throughout a circle round it of 300 stades in diameter, the upright gnomon throws no shadow at noon. It follows from this that the diameter of the sun occupies a portion of the sun's circle 3,000,000 stades in length; in other words, the diameter of the sun is 3,000,000 stades. The assumption that the sun's circle is 10,000 times as large as a great circle of the earth was presumably taken from Archimedes, who had proved in the *Sand-reckoner* that the diameter of the sun's orbit is less than 10,000 times that of the earth; Posidonius in fact took the maximum value to be the true value; but his estimate of the sun's size is far nearer the truth than the estimates of Aristarchus, Hipparchus, and Ptolemy. Expressed in terms of the mean diameter of the earth, the estimates of these astronomers give for the diameter of the sun the figures $6\frac{3}{4}$, $12\frac{1}{3}$, and $5\frac{1}{2}$ respectively; Posidonius's estimate gives $39\frac{1}{4}$, the true figure being 108.9.

In elementary geometry Posidonius is credited by Proclus with certain definitions. He defined 'figure' as 'confining limit' (*πέρας σύγκλειον*)¹ and 'parallels' as 'those lines which, being in one plane, neither converge nor diverge, but have all the perpendiculars equal which are drawn from the points of one line to the other'.² (Both these definitions are included in the *Definitions* of Heron.) He also distinguished seven species of quadrilaterals, and had views on the distinction between *theorem* and *problem*. Another indication of his interest in the fundamentals of elementary geometry is the fact³ that he wrote a separate work in refutation of the Epicurean Zeno of Sidon, who had objected to the very beginnings of the *Elements* on the ground that they contained unproved assumptions. Thus, said Zeno, even Eucl. I. 1 requires it to be admitted that 'two straight lines cannot have a common segment'; and, as regards the 'proof' of this fact deduced from the bisection of a circle by its diameter, he would object that it has to be assumed that two arcs of circles cannot have a common part. Zeno argued generally that, even if we admit the fundamental principles of geometry, the deductions

¹ Proclus on Eucl. I, p. 143. 8.

² *Ib.*, p. 176. 6-10.

³ *Ib.*, pp. 199. 14-200. 3.



THIS PAGE IS LOCKED TO FREE MEMBERS

Purchase full membership to immediately unlock this page

DELVE INTO FANTASY, MAGIC, MYTHOLOGY & FOLKLORE

Forgotten Books'
Full Membership gives
access to 797,885 ancient
and modern, fiction and
non-fiction books.

Continue

*Fair usage policy applies

An upper limit for his date is furnished by the fact that he wrote a commentary on or exposition of Posidonius's work *περὶ μετεώρων*; on the other hand, Alexander Aphrodisiensis (about A.D. 210) quotes an important passage from an 'epitome' of this *ἐξήγησις* by Geminus. The view most generally accepted is that he was a Stoic philosopher, born probably in the island of Rhodes, and a pupil of Posidonius, and that he wrote about 73-67 B.C.

Of Geminus's works that which has most interest for us is a comprehensive work on mathematics. Proclus, though he makes great use of it, does not mention its title, unless indeed, in the passage where, after quoting from Geminus a classification of lines which never meet, he says 'these remarks I have selected from the *φιλοκαλία* of Geminus',¹ the word *φιλοκαλία* is a title or an alternative title. Pappus, however, quotes a work of Geminus 'on the classification of the mathematics' (*ἐν τῷ περὶ τῆς τῶν μαθημάτων τάξεως*), while Eutocius quotes from 'the sixth book of the doctrine of the mathematics' (*ἐν τῷ ἕκτῳ τῆς τῶν μαθημάτων θεωρίας*). The former title corresponds well enough to the long extract on the division of the mathematical sciences into arithmetic, geometry, mechanics, astronomy, optics, geodesy, canonic (musical harmony) and logistic which Proclus gives in his first prologue, and also to the fragments contained in the *Anonymi variae collectiones* published by Hultsch in his edition of Heron; but it does not suit most of the other passages borrowed by Proclus. The correct title was most probably that given by Eutocius, *The Doctrine*, or *Theory*, *of the Mathematics*; and Pappus probably refers to one particular section of the work, say the first Book. If the sixth Book treated of conics, as we may conclude from Eutocius's reference, there must have been more Books to follow; for Proclus has preserved us details about higher curves, which must have come later. If again Geminus finished his work and wrote with the same fullness about the other branches of mathematics as he did about geometry, there must have been a considerable number of Books altogether. It seems to have been designed to give a complete view of the whole science of mathematics, and in fact

¹ Proclus on Eucl. I, p. 177. 24.

to have been a sort of encyclopaedia of the subject. The quotations of Proclus from Geminus's work do not stand alone; we have other collections of extracts, some more and some less extensive, and showing varieties of tradition according to the channel through which they came down. The scholia to Euclid's *Elements*, Book I, contain a considerable part of the commentary on the Definitions of Book I, and are valuable in that they give Geminus pure and simple, whereas Proclus includes extracts from other authors. Extracts from Geminus of considerable length are included in the Arabic commentary by an-Nairīzī (about A.D. 900) who got them through the medium of Greek commentaries on Euclid, especially that of Simplicius. It does not appear to be doubted any longer that 'Aganis' in an-Nairīzī is really Geminus; this is inferred from the close agreement between an-Nairīzī's quotations from 'Aganis' and the corresponding passages in Proclus; the difficulty caused by the fact that Simplicius calls Aganis 'socius noster' is met by the suggestion that the particular word *socius* is either the result of the double translation from the Greek or means nothing more, in the mouth of Simplicius, than 'colleague' in the sense of a worker in the same field, or 'authority'. A few extracts again are included in the *Anonymi variae collectiones* in Hultsch's *Heron*. Nos. 5-14 give definitions of geometry, logistic, geodesy and their subject-matter, remarks on bodies as continuous magnitudes, the three dimensions as 'principles' of geometry, the purpose of geometry, and lastly on optics, with its subdivisions, optics proper, *Catoptrica* and *σκηνογραφική*, scene-painting (a sort of perspective), with some fundamental principles of optics, e.g. that all light travels along straight lines (which are broken in the cases of reflection and refraction), and the division between optics and natural philosophy (the theory of light), it being the province of the latter to investigate (what is a matter of indifference to optics) whether (1) visual rays issue from the eye, (2) images proceed from the object and impinge on the eye, or (3) the intervening air is aligned or compacted with the beam-like breath or emanation from the eye.

Nos. 80-6 again in the same collection give the Peripatetic explanation of the name mathematics, adding that the term

was applied by the early Pythagoreans more particularly to geometry and arithmetic, sciences which deal with the pure, the eternal and the unchangeable, but was extended by later writers to cover what we call 'mixed' or applied mathematics, which, though theoretical, has to do with sensible objects, e.g. astronomy and optics. Other extracts from Geminus are found in extant manuscripts in connexion with Damianus's treatise on optics (published by R. Schöne, Berlin, 1897). The definitions of logistic and geometry also appear, but with decided differences, in the scholia to Plato's *Charmides* 165 E. Lastly, isolated extracts appear in Eutocius, (1) a remark reproduced in the commentary on Archimedes's *Plane Equilibriums* to the effect that Archimedes in that work gave the name of postulates to what are really axioms, (2) the statement that before Apollonius's time the conics were produced by cutting different cones (right-angled, acute-angled, and obtuse-angled) by sections perpendicular in each case to a generator.¹

The object of Geminus's work was evidently the examination of the first principles, the logical building up of mathematics on the basis of those admitted principles, and the defence of the whole structure against the criticisms of the enemies of the science, the Epicureans and Sceptics, some of whom questioned the unproved principles, and others the logical validity of the deductions from them. Thus in geometry Geminus dealt first with the principles or hypotheses (*ἀρχαί, ὑποθέσεις*) and then with the logical deductions, the theorems and problems (*τὰ μετὰ τὰς ἀρχάς*). The distinction is between the things which must be taken for granted but are incapable of proof and the things which must not be assumed but are matter for demonstration. The principles consisting of definitions, postulates, and axioms, Geminus subjected them severally to a critical examination from this point of view, distinguishing carefully between postulates and axioms, and discussing the legitimacy or otherwise of those formulated by Euclid in each class. In his notes on the definitions Geminus treated them historically, giving the various alternative definitions which had been suggested for each fundamental concept such as 'line', 'surface', 'figure', 'body', 'angle', &c., and frequently adding instructive classifications

¹ Eutocius, *Comm. on Apollonius's Conics, ad init.*



THIS PAGE IS LOCKED TO FREE MEMBERS

Purchase full membership to immediately unlock this page

FORGOTTEN BOOKS

FULL

MEMBERSHIP

797,885 Books!

All you can read

for only

\$8.99/month

Continue

*Fair usage policy applies



Attempt to prove the Parallel-Postulate.

Geminus devoted much attention to the distinction between postulates and axioms, giving the views of earlier philosophers and mathematicians (Aristotle, Archimedes, Euclid, Apollonius, the Stoics) on the subject as well as his own. It was important in view of the attacks of the Epicureans and Sceptics on mathematics, for (as Geminus says) it is as futile to attempt to prove the indemonstrable (as Apollonius did when he tried to prove the axioms) as it is incorrect to assume what really requires proof, 'as Euclid did in the fourth postulate [that all right angles are equal] and in the fifth postulate [the parallel-postulate]'.¹

The fifth postulate was the special stumbling-block. Geminus observed that the converse is actually proved by Euclid in I. 17; also that it is conclusively proved that an angle equal to a right angle is not necessarily itself a right angle (e.g. the 'angle' between the circumferences of two semi-circles on two equal straight lines with a common extremity and at right angles to one another); we cannot therefore admit that the converses are incapable of demonstration.² And

'we have learned from the very pioneers of this science not to have regard to mere plausible imaginings when it is a question of the reasonings to be included in our geometrical doctrine. As Aristotle says, it is as justifiable to ask scientific proofs from a rhetorician as to accept mere plausibilities from a geometer. . . . So in this case (that of the parallel-postulate) the fact that, when the right angles are lessened, the straight lines converge is true and necessary; but the statement that, since they converge more and more as they are produced, they will sometime meet is plausible but not necessary, in the absence of some argument showing that this is true in the case of straight lines. For the fact that some lines exist which approach indefinitely but yet remain non-secant (*ἀσύμπτωτοι*), although it seems improbable and paradoxical, is nevertheless true and fully ascertained with reference to other species of lines [the hyperbola and its asymptote and the conchoid and its asymptote, as Geminus says elsewhere]. May not then the same thing be possible in the case of

¹ Proclus on Eucl. I, pp. 178-82. 4; 183. 14-184. 10.

² *Ib.*, pp. 183. 26-184. 5.

straight lines which happens in the case of the lines referred to? Indeed, until the statement in the postulate is clinched by proof, the facts shown in the case of the other lines may direct our imagination the opposite way. And, though the controversial arguments against the meeting of the straight lines should contain much that is surprising, is there not all the more reason why we should expel from our body of doctrine this merely plausible and unreasoned (hypothesis)? It is clear from this that we must seek a proof of the present theorem, and that it is alien to the special character of postulates.'¹

Much of this might have been written by a modern geometer. Geminus's attempted remedy was to substitute a definition of parallels like that of Posidonius, based on the notion of *equidistance*. An-Nairīzī gives the definition as follows: 'Parallel straight lines are straight lines situated in the same plane and such that the distance between them, if they are produced without limit in both directions at the same time, is everywhere the same', to which Geminus adds the statement that the said distance is the shortest straight line that can be drawn between them. Starting from this, Geminus proved to his own satisfaction the propositions of Euclid regarding parallels and finally the parallel-postulate. He first gave the propositions (1) that the 'distance' between the two lines as defined is perpendicular to both, and (2) that, if a straight line is perpendicular to each of two straight lines and meets both, the two straight lines are parallel, and the 'distance' is the intercept on the perpendicular (proved by *reductio ad absurdum*). Next come (3) Euclid's propositions I. 27, 28 that, if two lines are parallel, the alternate angles made by any transversal are equal, &c. (easily proved by drawing the two equal 'distances' through the points of intersection with the transversal), and (4) Eucl. I. 29, the converse of I. 28, which is proved by *reductio ad absurdum*, by means of (2) and (3). Geminus still needs Eucl. I. 30, 31 (about parallels) and I. 33, 34 (the first two propositions relating to parallelograms) for his final proof of the postulate, which is to the following effect.

Let AB , CD be two straight lines met by the straight line

¹ Proclus on Eucl. I, pp. 192. 5-193. 3.

EF , and let the interior angles BEF , EFD be together less than two right angles.

Take any point H on FD and draw HK parallel to AB meeting EF in K . Then, if we bisect EF at L , LF at M , MF at N , and so on, we shall at last have a length, as FN , less

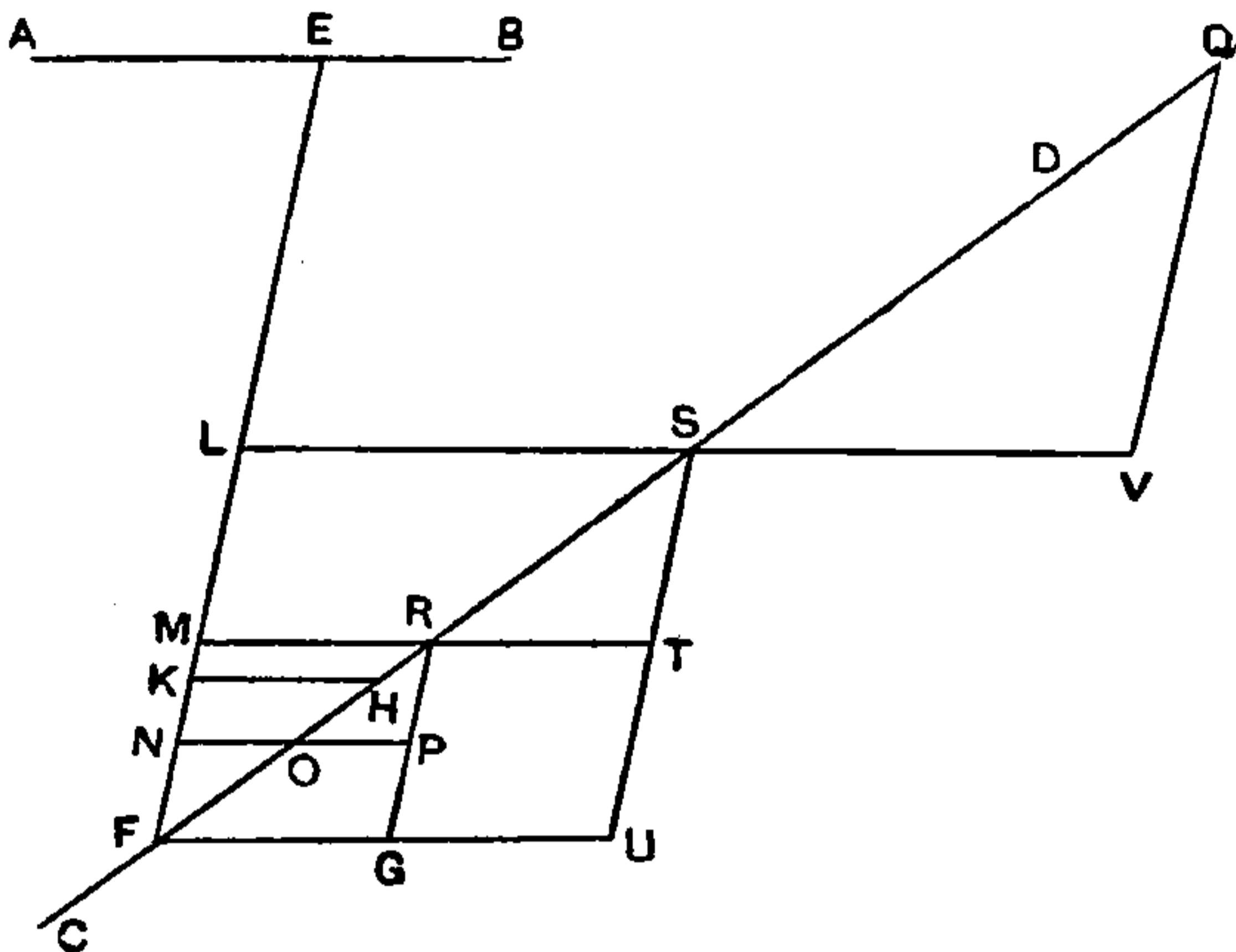

than FK . Draw FG , NOP parallel to AB . Produce FO to Q , and let FQ be the same multiple of FO that FE is of FN ; then shall AB , CD meet in Q .

Let S be the middle point of FQ and R the middle point of FS . Draw through R , S , Q respectively the straight lines RPG , STU , QV parallel to EF . Join MR , LS and produce them to T , V . Produce FG to U .

Then, in the triangles FON , ROP , two angles are equal respectively, the vertically opposite angles FON , ROP and the alternate angles NFO , PRO ; and $FO = OR$; therefore $RP = FN$.

And FN , PG in the parallelogram $FNPG$ are equal; therefore $RG = 2FN = FM$ (whence MR is parallel to FG or AB).

Similarly we prove that $SU = 2FM = FL$, and LS is parallel to FG or AB .

Lastly, by the triangles FLS , QVS , in which the sides FS , SQ are equal and two angles are respectively equal, $QV = FL$.

Therefore $QV = LE$.

Since then EL , QV are equal and parallel, so are EQ , LV , and (says Geminus) it follows that AB passes through Q .



THIS PAGE IS LOCKED TO FREE MEMBERS

Purchase full membership to immediately unlock this page

DELVE INTO FANTASY, MAGIC, MYTHOLOGY & FOLKLORE

Forgotten Books'
Full Membership gives
access to 797,885 ancient
and modern, fiction and
non-fiction books.

Continue

*Fair usage policy applies

and make equal angles with it, the straight lines are equal.¹ As Apollonius wrote on the cylindrical helix and proved the fact of its uniformity, we may fairly assume that Geminus was here drawing upon Apollonius.

Enough has been said to show how invaluable a source of information Geminus's work furnished to Proclus and all writers on the history of mathematics who had access to it.

In astronomy we know that Geminus wrote an *ἐξήγησις* of Posidonius's work, the *Meteorologica* or *περὶ μετεώρων*. This is the source of the famous extract made from Geminus by Alexander Aphrodisiensis, and reproduced by Simplicius in his commentary on the *Physics* of Aristotle,² on which Schiaparelli relied in his attempt to show that it was Heraclides of Pontus, not Aristarchus of Samos, who first put forward the heliocentric hypothesis. The extract is on the distinction between physical and astronomical inquiry as applied to the heavens. It is the business of the physicist to consider the substance of the heaven and stars, their force and quality, their coming into being and decay, and he is in a position to prove the facts about their size, shape, and arrangement; astronomy, on the other hand, ignores the physical side, proving the arrangement of the heavenly bodies by considerations based on the view that the heaven is a real *κόσμος*, and, when it tells us of the shapes, sizes and distances of the earth, sun and moon, of eclipses and conjunctions, and of the quality and extent of the movements of the heavenly bodies, it is connected with the mathematical investigation of quantity, size, form, or shape, and uses arithmetic and geometry to prove its conclusions. Astronomy deals, not with causes, but with facts; hence it often proceeds by hypotheses, stating certain expedients by which the phenomena may be saved. For example, why do the sun, the moon and the planets appear to move irregularly? To explain the observed facts we may assume, for instance, that the orbits are eccentric circles or that the stars describe epicycles on a carrying circle; and then we have to go farther and examine other ways in which it is possible for the phenomena to be brought about. 'Hence we actually find a certain person [Heraclides

¹ Proclus on Eucl. I, pp. 112. 22-113. 3, p. 251. 3-11.

² Simpl. in *Phys.*, pp. 291-2, ed. Diels.

of Pontus] coming forward and saying that, even on the assumption that the earth moves in a certain way, while the sun is in a certain way at rest, the apparent irregularity with reference to the sun may be saved.' Philological considerations as well as the other notices which we possess about Heraclides make it practically certain that 'Heraclides of Pontus' is an interpolation and that Geminus said *τις* simply, 'a certain person', without any name, though he doubtless meant Aristarchus of Samos.¹

Simplicius says that Alexander quoted this extract from the *epitome* of the *ἐξήγησις* by Geminus. As the original work was apparently made the subject of an abridgement, we gather that it must have been of considerable scope. It is a question whether *ἐξήγησις* means 'commentary' or 'exposition'; I am inclined to think that the latter interpretation is the correct one, and that Geminus reproduced Posidonius's work in its entirety with elucidations and comments; this seems to me to be suggested by the words added by Simplicius immediately after the extract 'this is the account given by Geminus, or *Posidonius in Geminus*, of the difference between physics and astronomy', which seems to imply that Geminus in our passage reproduced Posidonius textually.

'Introduction to the Phaenomena' attributed to Geminus.

There remains the treatise, purporting to be by Geminus, which has come down to us under the title *Γεμίνου εἰσαγωγὴ εἰς τὰ Φαινόμενα*.² What, if any, is the relation of this work to the exposition of Posidonius's *Meteorologica* or the epitome of it just mentioned? One view is that the original *Isagoge* of Geminus and the *ἐξήγησις* of Posidonius were one and the same work, though the *Isagoge* as we have it is not by Geminus, but by an unknown compiler. The objections to this are, first, that it does not contain the extract given by Simplicius, which would have come in usefully at the beginning of an Introduction to Astronomy, nor the other extract given by Alexander from Geminus and relating to the rainbow which seems likewise to have come from the *ἐξήγησις*³;

¹ Cf. *Aristarchus of Samos*, pp. 275-83.

² Edited by Manitius (Teubner, 1898).

³ Alex. Aphr. on Aristotle's *Meteorologica*, iii. 4, 9 (Ideler, ii, p. 128; p. 152. 10, Hayduck).

secondly, that it does not anywhere mention the name of Posidonius (not, perhaps, an insuperable objection); and, thirdly, that there are views expressed in it which are not those held by Posidonius but contrary to them. Again, the writer knows how to give a sound judgement as between divergent views, writes in good style on the whole, and can hardly have been the mere compiler of extracts from Posidonius which the view in question assumes him to be. It seems in any case safer to assume that the *Isagoge* and the *ἐξήγησις* were separate works. At the same time, the *Isagoge*, as we have it, contains errors which we cannot attribute to Geminus. The choice, therefore, seems to lie between two alternatives: either the book is by Geminus in the main, but has in the course of centuries suffered deterioration by interpolations, mistakes of copyists, and so on, or it is a compilation of extracts from an original *Isagoge* by Geminus with foreign and inferior elements introduced either by the compiler himself or by other prentice hands. The result is a tolerable elementary treatise suitable for teaching purposes and containing the most important doctrines of Greek astronomy represented from the standpoint of Hipparchus. Chapter 1 treats of the zodiac, the solar year, the irregularity of the sun's motion, which is explained by the eccentric position of the sun's orbit relatively to the zodiac, the order and the periods of revolution of the planets and the moon. In § 23 we are told that all the fixed stars do not lie on one spherical surface, but some are farther away than others—a doctrine due to the Stoics. Chapter 2, again, treats of the twelve signs of the zodiac, chapter 3 of the constellations, chapter 4 of the axis of the universe and the poles, chapter 5 of the circles on the sphere (the equator and the parallel circles, arctic, summer-tropical, winter-tropical, antarctic, the colure-circles, the zodiac or ecliptic, the horizon, the meridian, and the Milky Way), chapter 6 of Day and Night, their relative lengths in different latitudes, their lengthening and shortening, chapter 7 of the times which the twelve signs take to rise. Chapter 8 is a clear, interesting and valuable chapter on the calendar, the length of months and years and the various cycles, the octaëteris, the 16-years and 160-years cycles, the 19-years cycle of Euctemon (and Meton), and the cycle of Callippus



THIS PAGE IS LOCKED TO FREE MEMBERS

Purchase full membership to immediately unlock this page

FORGOTTEN BOOKS

FULL

MEMBERSHIP

797,885 Books!

All you can read

for only

\$8.99/month

Continue

*Fair usage policy applies



SOME HANDBOOKS

THE description of the handbook on the elements of astronomy entitled the *Introduction to the Phaenomena* and attributed to Geminus might properly have been reserved for this chapter. It was, however, convenient to deal with Geminus in close connexion with Posidonius; for Geminus wrote an exposition of Posidonius's *Meteorologica* related to the original work in such a way that Simplicius, in quoting a long passage from an epitome of this work, could attribute the passage to either Geminus or 'Posidonius in Geminus'; and it is evident that, in other subjects too, Geminus drew from, and was influenced by, Posidonius.

The small work *De motu circulari corporum caelestium* by CLEOMEDES (*Κλεομήδους κυκλική θεωρία*) in two Books is the production of a much less competent person, but is much more largely based on Posidonius. This is proved by several references to Posidonius by name, but it is specially true of the very long first chapter of Book II (nearly half of the Book) which seems for the most part to be copied bodily from Posidonius, in accordance with the author's remark at the end of Book I that, in giving the refutation of the Epicurean assertion that the sun is just as large as it looks, namely one foot in diameter, he will give so much as suffices for such an introduction of the particular arguments used by 'certain authors who have written whole treatises on this one topic (i. e. the size of the sun), among whom is Posidonius'. The interest of the book then lies mainly in what is quoted from Posidonius; its mathematical interest is almost *nil*.

The date of Cleomedes is not certainly ascertained, but, as he mentions no author later than Posidonius, it is permissible to suppose, with Hultsch, that he wrote about the middle of

the first century B.C. As he seems to know nothing of the works of Ptolemy, he can hardly, in any case, have lived later than the beginning of the second century A.D.

Book I begins with a chapter the object of which is to prove that the universe, which has the shape of a sphere, is limited and surrounded by void extending without limit in all directions, and to refute objections to this view. Then follow chapters on the five parallel circles in the heaven and the zones, habitable and uninhabitable (chap. 2); on the motion of the fixed stars and the independent (*προαιρετικά*) movements of the planets including the sun and moon (chap. 3); on the zodiac and the effect of the sun's motion in it (chap. 4); on the inclination of the axis of the universe and its effects on the lengths of days and nights at different places (chap. 5); on the inequality in the rate of increase in the lengths of the days and nights according to the time of year, the different lengths of the seasons due to the motion of the sun in an eccentric circle, the difference between a day-and-night and an exact revolution of the universe owing to the separate motion of the sun (chap. 6); on the habitable regions of the globe including Britain and the 'island of Thule', said to have been visited by Pytheas, where, when the sun is in Cancer and visible, the day is a month long; and so on (chap. 7). Chap. 8 purports to prove that the universe is a sphere by proving first that the earth is a sphere, and then that the air about it, and the ether about that, must necessarily make up larger spheres. The earth is proved to be a sphere by the method of exclusion; it is assumed that the only possibilities are that it is (a) flat and plane, or (b) hollow and deep, or (c) square, or (d) pyramidal, or (e) spherical, and, the first four hypotheses being successively disposed of, only the fifth remains. Chap. 9 maintains that the earth is in the centre of the universe; chap. 10, on the size of the earth, contains the interesting reproduction of the details of the measurements of the earth by Posidonius and Eratosthenes respectively which have been given above in their proper places (p. 220, pp. 106-7); chap. 11 argues that the earth is in the relation of a point to, i. e. is negligible in size in comparison with, the universe or even the sun's circle, but not the moon's circle (cf. p. 3 above).

Book II, chap. 1, is evidently the *pièce de résistance*, con-

sisting of an elaborate refutation of Epicurus and his followers, who held that the sun is just as large as it *looks*, and further asserted (according to Cleomedes) that the stars are lit up as they rise and extinguished as they set. The chapter seems to be almost wholly taken from Posidonius; it ends with some pages of merely vulgar abuse, comparing Epicurus with Thersites, with more of the same sort. The value of the chapter lies in certain historical traditions mentioned in it, and in the account of Posidonius's speculation as to the size and distance of the sun, which does, as a matter of fact, give results much nearer the truth than those obtained by Aristarchus, Hipparchus, and Ptolemy. Cleomedes observes (1) that by means of water-clocks it is found that the apparent diameter of the sun is $1/750$ th of the sun's circle, and that this method of measuring it is said to have been first invented by the Egyptians; (2) that Hipparchus is said to have found that the sun is 1,050 times the size of the earth, though, as regards this, we have the better authority of Adrastus (in Theon of Smyrna) and of Chalcidius, according to whom Hipparchus made the sun nearly 1,880 times the size of the earth (both figures refer of course to the solid content). We have already described Posidonius's method of arriving at the size and distance of the sun (pp. 220-1). After he has given this, Cleomedes, apparently deserting his guide, adds a calculation of his own relating to the sizes and distances of the moon and the sun which shows how little he was capable of any scientific inquiry.¹ Chap. 2 purports to prove that the sun is

¹ He says (pp. 146. 17-148. 27) that in an eclipse the breadth of the earth's shadow is stated to be two moon-breadths; hence, he says, it seems credible (*πιθανόν*) that the earth is twice the size of the moon (this practically assumes that the breadth of the earth's shadow is equal to the diameter of the earth, or that the cone of the earth's shadow is a cylinder!). Since then the circumference of the earth, according to Eratosthenes, is 250,000 stades, and its diameter therefore 'more than 80,000' (he evidently takes $\pi = 3$), the diameter of the moon will be 40,000 stades. Now, the moon's circle being 750 times the moon's diameter, the radius of the moon's circle, i.e. the distance of the moon from the earth, will be $\frac{1}{6}$ th of this (i.e. $\pi = 3$) or 125 moon-diameters; therefore the moon's distance is 5,000,000 stades (which is much too great). Again, since the moon traverses its orbit 13 times to the sun's once, he assumes that the sun's orbit is 13 times as large as the moon's, and consequently that the diameter of the sun is 13 times that of the moon, or 520,000 stades and its distance 13 times 5,000,000 or 65,000,000 stades!



THIS PAGE IS LOCKED TO FREE MEMBERS

Purchase full membership to immediately unlock this page

DELVE INTO FANTASY, MAGIC, MYTHOLOGY & FOLKLORE

Forgotten Books'
Full Membership gives
access to 797,885 ancient
and modern, fiction and
non-fiction books.

Continue

*Fair usage policy applies

edited by E. Hiller (Teubner, 1878) and finally, with a French translation, by J. Dupuis (Paris, 1892).

Theon's date is approximately fixed by two considerations. He is clearly the person whom Theon of Alexandria called 'the old Theon', τὸν παλαιὸν Θέωνα,¹ and there is no reason to doubt that he is the 'Theon the mathematician' (ὁ μαθηματικός) who is credited by Ptolemy with four observations of the planets Mercury and Venus made in A.D. 127, 129, 130 and 132.² The latest writers whom Theon himself mentions are Thrasyllus, who lived in the reign of Tiberius, and Adrastus the Peripatetic, who belongs to the middle of the second century A.D. Theon's work itself is a curious medley, valuable, not intrinsically, but for the numerous historical notices which it contains. The title, which claims that the book contains things useful for the study of Plato, must not be taken too seriously. It was no doubt an elementary *introduction* or vade-mecum for students of philosophy, but there is little in it which has special reference to the mathematical questions raised in Plato. The connexion consists mostly in the long proem quoting the views of Plato on the paramount importance of mathematics in the training of the philosopher, and the mutual relation of the five different branches, arithmetic, geometry, stereometry, astronomy and music. The want of care shown by Theon in the quotations from particular dialogues of Plato prepares us for the patch-work character of the whole book.

In the first chapter he promises to give the mathematical theorems most necessary for the student of Plato to know, in arithmetic, music, and geometry, with its application to stereometry and astronomy.³ But the promise is by no means kept as regards geometry and stereometry: indeed, in a later passage Theon seems to excuse himself from including theoretical geometry in his plan, on the ground that all those who are likely to read his work or the writings of Plato may be assumed to have gone through an elementary course of theoretical geometry.⁴ But he writes at length on figured

¹ Theon of Alexandria, *Comm. on Ptolemy's Syntaxis*, Basel edition, pp. 390, 395, 396.

² Ptolemy, *Syntaxis*, ix. 9, x. 1, 2.

³ Theon of Smyrna, ed. Hiller, p. 1. 10-17.

⁴ *Ib.*, p. 16. 17-20.

numbers, plane and solid, which are of course analogous to the corresponding geometrical figures, and he may have considered that he was in this way sufficiently fulfilling his promise with regard to geometry and stereometry. Certain geometrical definitions, of point, line, straight line, the three dimensions, rectilinear plane and solid figures, especially parallelograms and parallelepipedal figures including cubes, *plinthides* (square bricks) and *δοκίδες* (beams), and *scalene* figures with sides unequal every way (= *βωμίσκοι* in the classification of solid numbers), are dragged in later (chaps. 53–5 of the section on music)¹ in the middle of the discussion of proportions and means; if this passage is not an interpolation, it confirms the supposition that Theon included in his work only this limited amount of geometry and stereometry.

Section I is on Arithmetic in the same sense as Nicomachus's *Introduction*. At the beginning Theon observes that arithmetic will be followed by music. Of music in its three aspects, music in instruments (*ἐν ὄργανοις*), music in numbers, i.e. musical intervals expressed in numbers or pure theoretical music, and the music or harmony in the universe, the first kind (instrumental music) is not exactly essential, but the other two must be discussed immediately after arithmetic.² The contents of the arithmetical section have been sufficiently indicated in the chapter on Pythagorean arithmetic (vol. i, pp. 112–13); it deals with the classification of numbers, odd, even, and their subdivisions, prime numbers, composite numbers with equal or unequal factors, plane numbers subdivided into square, oblong, triangular and polygonal numbers, with their respective 'gnomons' and their properties as the sum of successive terms of arithmetical progressions beginning with 1 as the first term, circular and spherical numbers, solid numbers with three factors, pyramidal numbers and truncated pyramidal numbers, perfect numbers with their correlatives, the over-perfect and the deficient; this is practically what we find in Nicomachus. But the special value of Theon's exposition lies in the fact that it contains an account of the famous 'side-' and 'diameter-' numbers of the Pythagoreans.³

¹ Theon of Smyrna, ed. Hiller, pp. 111–13. ² *Ib.*, pp. 16. 24–17. 11.

³ *Ib.*, pp. 42. 10–45. 9. Cf. vol. i, pp. 91–3.

In the Section on Music Theon says he will first speak of the two kinds of music, the audible or instrumental, and the intelligible or theoretical subsisting in numbers, after which he promises to deal lastly with ratio as predicable of mathematical entities in general and the ratio constituting the harmony in the universe, 'not scrupling to set out once again the things discovered by our predecessors, just as we have given the things handed down in former times by the Pythagoreans, with a view to making them better known, without ourselves claiming to have discovered any of them'.¹ Then follows a discussion of audible music, the intervals which give harmonies, &c., including substantial quotations from Thrasyllus and Adrastus, and references to views of Aristoxenus, Hippasus, Archytas, Eudoxus and Plato. With chap. 17 (p. 72) begins the account of the 'harmony in numbers', which turns into a general discussion of ratios, proportions and means, with more quotations from Plato, Eratosthenes and Thrasyllus, followed by Thrasyllus's *divisio canonis*, chaps. 35, 36 (pp. 87-93). After a promise to apply the latter division to the sphere of the universe, Theon purports to return to the subject of proportion and means. This, however, does not occur till chap. 50 (p. 106), the intervening chapters being taken up with a discussion of the *δεκάς* and *τετρακτύς* (with eleven applications of the latter) and the mystic or curious properties of the numbers from 2 to 10; here we have a part of the *theologumena* of arithmetic. The discussion of proportions and the different kinds of means after Eratosthenes and Adrastus is again interrupted by the insertion of the geometrical definitions already referred to (chaps. 53-5, pp. 111-13), after which Theon resumes the question of means for 'more precise' treatment.

The Section on Astronomy begins on p. 120 of Hiller's edition. Here again Theon is mainly dependent upon Adrastus, from whom he makes long quotations. Thus, on the sphericity of the earth, he says that for the necessary conspectus of the arguments it will be sufficient to refer to the grounds stated summarily by Adrastus. In explaining (p. 124) that the unevennesses in the surface of

¹ Theon of Smyrna, ed. Hiller, pp. 46. 20-47. 14.



THIS PAGE IS LOCKED TO FREE MEMBERS

Purchase full membership to immediately unlock this page

FORGOTTEN BOOKS

FULL

MEMBERSHIP

797,885 Books!

All you can read

for only

\$8.99/month

Continue

*Fair usage policy applies



to the seven heavenly bodies and the sphere of the fixed stars. The whole of this passage (chaps. 15 to 16, pp. 138-47) is no doubt intended as the promised account of the 'harmony in the universe', although at the very end of the work Theon implies that this has still to be explained on the basis of Thrasyllus's exposition combined with what he has already given himself.

The next chapters deal with the forward movements, the stationary points, and the retrogradations, as they respectively appear to us, of the five planets, and the 'saving of the phenomena' by the alternative hypotheses of eccentric circles and epicycles (chaps. 17-30, pp. 147-78). These hypotheses are explained, and the identity of the motion produced by the two is shown by Adrastus in the case of the sun (chaps. 26, 27, pp. 166-72). The proof is introduced with the interesting remark that 'Hipparchus says it is worthy of investigation by mathematicians why, on two hypotheses so different from one another, that of eccentric circles and that of concentric circles with epicycles, the same results appear to follow'. It is not to be supposed that the proof of the identity could be other than easy to a mathematician like Hipparchus; the remark perhaps merely suggests that the two hypotheses were discovered quite independently, and it was not till later that the effect was discovered to be the same, when of course the fact would seem to be curious and a mathematical proof would immediately be sought. Another passage (p. 188) says that Hipparchus preferred the hypothesis of the epicycle, as being his own. If this means that Hipparchus claimed to have discovered the epicycle-hypothesis, it must be a misapprehension; for Apollonius already understood the theory of epicycles in all its generality. According to Theon, the epicycle-hypothesis is more 'according to nature'; but it was presumably preferred because it was applicable to all the planets, whereas the eccentric-hypothesis, when originally suggested, applied only to the three superior planets; in order to make it apply to the inferior planets it is necessary to suppose the circle described by the centre of the eccentric to be greater than the eccentric circle itself, which extension of the hypothesis, though known to Hipparchus, does not seem to have occurred to Apollonius.

We next have (chap. 31, p. 178) an allusion to the systems of Eudoxus, Callippus and Aristotle, and a description (p. 180 sq.) of a system in which the 'carrying' spheres (called 'hollow') have between them 'solid spheres which by their own motion will roll (*ἀνελίξουσιν*) the carrying spheres in the opposite direction, being in contact with them'. These 'solid' spheres (which carry the planet fixed at a point on their surface) act in practically the same way as epicycles. In connexion with this description Theon (i.e. Adrastus) speaks (chap. 33, pp. 186-7) of two alternative hypotheses in which, by comparison with Chalcidius,¹ we recognize (after eliminating epicycles erroneously imported into both systems) the hypotheses of Plato and Heraclides respectively. It is this passage which enables us to conclude for certain that Heraclides made Venus and Mercury revolve in circles about the sun, like satellites, while the sun in its turn revolves in a circle about the earth as centre. Theon (p. 187) gives the maximum arcs separating Mercury and Venus respectively from the sun as 20° and 50° , these figures being the same as those given by Cleomedes.

The last chapters (chaps. 37-40), quoted from Adrastus, deal with conjunctions, transits, occultations and eclipses. The book concludes with a considerable extract from Dercyllides, a Platonist with Pythagorean leanings, who wrote (before the time of Tiberius and perhaps even before Varro) a book on Plato's philosophy. It is here (p. 198. 14) that we have the passage so often quoted from Eudemus:

'Eudemus relates in his Astronomy that it was Oenopides who first discovered the girdling of the zodiac and the revolution (or cycle) of the Great Year, that Thales was the first to discover the eclipse of the sun and the fact that the sun's period with respect to the solstices is not always the same, that Anaximander discovered that the earth is (suspended) on high and lies (substituting *κεῖται* for the reading of the manuscripts, *κινεῖται*, moves) about the centre of the universe, and that Anaximenes said that the moon has its light from the sun and (explained) how its eclipses come about' (Anaximenes is here apparently a mistake for Anaxagoras).

¹ Chalcidius, *Comm. on Timaeus*, c. 110. Cf. *Aristarchus of Samos*, pp. 256-8.

TRIGONOMETRY: HIPPARCHUS, MENELAUS,
PTOLEMY

WE have seen that *Sphaeric*, the geometry of the sphere, was very early studied, because it was required so soon as astronomy became mathematical; with the Pythagoreans the word *Sphaeric*, applied to one of the subjects of the quadrivium, actually meant astronomy. The subject was so far advanced before Euclid's time that there was in existence a regular textbook containing the principal propositions about great and small circles on the sphere, from which both Autolycus and Euclid quoted the propositions as generally known. These propositions, with others of purely astronomical interest, were collected afterwards in a work entitled *Sphaerica*, in three Books, by THEODOSIUS.

Suidas has a notice, *s. v.* Θεοδοσίος, which evidently confuses the author of the *Sphaerica* with another Theodosius, a Sceptic philosopher, since it calls him 'Theodosius, a philosopher', and attributes to him, besides the mathematical works, 'Sceptic chapters' and a commentary on the chapters of Theudas. Now the commentator on Theudas must have belonged, at the earliest, to the second half of the second century A.D., whereas our Theodosius was earlier than Menelaus (*fl.* about A.D. 100), who quotes him by name. The next notice by Suidas is of yet another Theodosius, a poet, who came from Tripolis. Hence it was at one time supposed that our Theodosius was of Tripolis. But Vitruvius¹ mentions a Theodosius who invented a sundial 'for any climate'; and Strabo, in speaking of certain Bithynians distinguished in their particular sciences, refers to 'Hipparchus, Theodosius and his sons, mathematicians'². We conclude that our Theo-

¹ *De architectura* ix. 9.

² Strabo, xii. 4, 9, p. 566.



THIS PAGE IS LOCKED TO FREE MEMBERS

Purchase full membership to immediately unlock this page

DELVE INTO FANTASY, MAGIC, MYTHOLOGY & FOLKLORE

Forgotten Books'
Full Membership gives
access to 797,885 ancient
and modern, fiction and
non-fiction books.

Continue

*Fair usage policy applies

(Books XII and XIII) Euclid included no general properties of the sphere except the theorem proved in XII. 16–18, that the volumes of two spheres are in the triplicate ratio of their diameters; apart from this, the sphere is only introduced in the propositions about the regular solids, where it is proved that they are severally inscribable in a sphere, and it was doubtless with a view to his proofs of this property in each case that he gave a new definition of a sphere as the figure described by the revolution of a semicircle about its diameter, instead of the more usual definition (after the manner of the definition of a circle) as the locus of all points (in space instead of in a plane) which are equidistant from a fixed point (the centre). No doubt the exclusion of the geometry of the sphere from the *Elements* was due to the fact that it was regarded as belonging to astronomy rather than pure geometry.

Theodosius defines the sphere as ‘a solid figure contained by one surface such that all the straight lines falling upon it from one point among those lying within the figure are equal to one another’, which is exactly Euclid’s definition of a circle with ‘solid’ inserted before ‘figure’ and ‘surface’ substituted for ‘line’. The early part of the work is then generally developed on the lines of Euclid’s Book III on the circle. Any plane section of a sphere is a circle (Prop. 1). The straight line from the centre of the sphere to the centre of a circular section is perpendicular to the plane of that section (1, Por. 2; cf. 7, 23); thus a plane section serves for finding the centre of the sphere just as a chord does for finding that of a circle (Prop. 2). The propositions about tangent planes (3–5) and the relation between the sizes of circular sections and their distances from the centre (5, 6) correspond to Euclid III. 16–19 and 15; as the small circle corresponds to any chord, the great circle (‘greatest circle’ in Greek) corresponds to the diameter. The poles of a circular section correspond to the extremities of the diameter bisecting a chord of a circle at right angles (Props. 8–10). Great circles bisecting one another (Props. 11–12) correspond to chords which bisect one another (diameters), and great circles bisecting small circles at right angles and passing through their poles (Props. 13–15) correspond to diameters bisecting chords at right angles. The distance of any point of a great

circle from its pole is equal to the side of a square inscribed in the great circle and conversely (Props. 16, 17). Next come certain problems: To find a straight line equal to the diameter of any circular section or of the sphere itself (Props. 18, 19); to draw the great circle through any two given points on the surface (Prop. 20); to find the pole of any given circular section (Prop. 21). Prop. 22 applies Eucl. III. 3 to the sphere.

Book II begins with a definition of circles on a sphere which touch one another; this happens 'when the common section of the planes (of the circles) touches both circles'. Another series of propositions follows, corresponding again to propositions in Eucl., Book III, for the circle. Parallel circular sections have the same poles, and conversely (Props. 1, 2). Props. 3-5 relate to circles on the sphere touching one another and therefore having their poles on a great circle which also passes through the point of contact (cf. Eucl. III. 11, [12] about circles touching one another). If a great circle touches a small circle, it also touches another small circle equal and parallel to it (Props. 6, 7), and if a great circle be obliquely inclined to another circular section, it touches each of two equal circles parallel to that section (Prop. 8). If two circles on a sphere cut one another, the great circle drawn through their poles bisects the intercepted segments of the circles (Prop. 9). If there are any number of parallel circles on a sphere, and any number of great circles drawn through their poles, the arcs of the parallel circles intercepted between any two of the great circles are similar, and the arcs of the great circles intercepted between any two of the parallel circles are equal (Prop. 10).

The last proposition forms a sort of transition to the portion of the treatise (II. 11-23 and Book III) which contains propositions of purely astronomical interest, though expressed as propositions in pure geometry without any specific reference to the various circles in the heavenly sphere. The propositions are long and complicated, and it would neither be easy nor worth while to attempt an enumeration. They deal with circles or parts of circles (arcs intercepted on one circle by series of other circles and the like). We have no difficulty in recognizing particular circles which come into many proposi-

tions. A particular small circle is the circle which is the limit of the stars which do not set, as seen by an observer at a particular place on the earth's surface; the pole of this circle is the pole in the heaven. A great circle which touches this circle and is obliquely inclined to the 'parallel circles' is the circle of the horizon; the parallel circles of course represent the apparent motion of the fixed stars in the diurnal rotation, and have the pole of the heaven as pole. A second great circle obliquely inclined to the parallel circles is of course the circle of the zodiac or ecliptic. The greatest of the 'parallel circles' is naturally the equator. All that need be said of the various propositions (except two which will be mentioned separately) is that the sort of result proved is like that of Props. 12 and 13 of Euclid's *Phaenomena* to the effect that in the half of the zodiac-circle beginning with Cancer (or Capricornus) equal arcs set (or rise) in unequal times; those which are nearer the tropic circle take a longer time, those further from it a shorter; those which take the shortest time are those adjacent to the equinoctial points; those which are equidistant from the equator rise and set in equal times. In like manner Theodosius (III. 8) in effect takes equal and contiguous arcs of the ecliptic all on one side of the equator, draws through their extremities great circles touching the circumpolar 'parallel' circle, and proves that the corresponding arcs of the equator intercepted between the latter great circles are unequal and that, of the said arcs, that corresponding to the arc of the ecliptic which is nearer the tropic circle is the greater. The successive great circles touching the circumpolar circle are of course successive positions of the horizon as the earth revolves about its axis, that is to say, the same length of arc on the ecliptic takes a longer or shorter time to rise according as it is nearer to or farther from the tropic, in other words, farther from or nearer to the equinoctial points.

It is, however, obvious that investigations of this kind, which only prove that certain arcs are greater than others, and do not give the actual numerical ratios between them, are useless for any practical purpose such as that of telling the hour of the night by the stars, which was one of the fundamental problems in Greek astronomy; and in order to find



THIS PAGE IS LOCKED TO FREE MEMBERS

Purchase full membership to immediately unlock this page

FORGOTTEN BOOKS

FULL

MEMBERSHIP

797,885 Books!

All you can read

for only

\$8.99/month

Continue

*Fair usage policy applies



Now, the triangle NLO being right-angled at L , $NO > NL$.

Measure NT along NO equal to NL , and join TB' .

Then in the triangles $B'NT$, $B'NL$ two sides $B'N$, NT are equal to two sides $B'N$, NL , and the included angles (both being right) are equal; therefore the triangles are equal in all respects, and $\angle NLB' = \angle NTB'$.

$$\begin{aligned}
 \text{Now} \quad 2R : 2\rho &= OC' : C'K \\
 &= ON : NL \\
 &= ON : NT \\
 &[= \tan NTB' : \tan NOB'] \\
 &> \angle NTB' : \angle NOB' \\
 &> \angle NLB' : \angle NOB' \\
 &> \angle COB : \angle NOB' \\
 &> (\text{arc } BC) : (\text{arc } B'C').
 \end{aligned}$$

If a' , b' , c' are the sides of the spherical triangle $AB'C'$, this result is equivalent (since the angle COB subtended by the arc CB is equal to A) to

$$\begin{aligned}
 1 : \sin b' &= \tan A : \tan a' \\
 &> a : a',
 \end{aligned}$$

where $a = BC$, the side opposite A in the triangle ABC .

The proof is based on the fact (proved in Euclid's *Optics* and assumed as known by Aristarchus of Samos and Archimedes) that, if α , β are angles such that $\frac{1}{2}\pi > \alpha > \beta$, $\tan \alpha / \tan \beta > \alpha / \beta$.

While, therefore, Theodosius proves the equivalent of the formula, applicable in the solution of a spherical triangle right-angled at C , that $\tan a = \sin b \tan A$, he is unable, for want of trigonometry, to find the actual value of a/a' , and can only find a limit for it. He is exactly in the same position as Aristarchus, who can only approximate to the values of the trigonometrical ratios which he needs, e.g. $\sin 1^\circ$, $\cos 1^\circ$, $\sin 3^\circ$, by bringing them within upper and lower limits with the aid of the inequalities

$$\frac{\tan \alpha}{\tan \beta} > \frac{\alpha}{\beta} > \frac{\sin \alpha}{\sin \beta}$$

where $\frac{1}{2}\pi > \alpha > \beta$.

We may contrast with this proposition of Theodosius the corresponding proposition in Menelaus's *Sphaerica* (III. 15) dealing with the more general case in which C' , instead of being the tropical point on the ecliptic, is, like B' , any point between the tropical point and D . If R, ρ have the same meaning as above and r_1, r_2 are the radii of the parallel circles through B' and the new C' , Menelaus proves that

$$\frac{\sin \alpha}{\sin \alpha'} = \frac{R \rho}{r_1 r_2},$$

which, of course, with the aid of Tables, gives the means of finding the actual values of α or α' when the other elements are given.

The proposition III. 12 of Theodosius proves a result similar to that of III. 11 for the case where the great circles $AB'B$, $AC'C$, instead of being great circles through the poles, are great circles touching 'the circle of the always-visible stars', i.e. different positions of the horizon, and the points C' , B' are any points on the arc of the oblique circle between the tropical and the equinoctial points; in this case, with the same notation, $4R : 2\rho > (\text{arc } BC) : (\text{arc } B'C')$.

It is evident that Theodosius was simply a laborious compiler, and that there was practically nothing original in his work. It has been proved, by means of propositions quoted *verbatim* or assumed as known by Autolycus in his *Moving Sphere* and by Euclid in his *Phaenomena*, that the following propositions in Theodosius are pre-Euclidean, I. 1, 6 a, 7, 8, 11, 12, 13, 15, 20; II. 1, 2, 3, 5, 8, 9, 10 a, 13, 15, 17, 18, 19, 20, 22; III. 1 b, 2, 3, 7, 8, those shown in thick type being quoted word for word.

The beginnings of trigonometry.

But this is not all. In Menelaus's *Sphaerica*, III. 15, there is a reference to the proposition (III. 11) of Theodosius proved above, and in Gherard of Cremona's translation from the Arabic, as well as in Halley's translation from the Hebrew of Jacob b. Machir, there is an addition to the effect that this proposition was used by Apollonius in a book the title of which is given in the two translations in the alternative

forms 'liber aggregativus' and 'liber de principiis universalibus'. Each of these expressions may well mean the work of Apollonius which Marinus refers to as the 'General Treatise' (ἡ καθόλου πραγματεία). There is no apparent reason to doubt that the remark in question was really contained in Menelaus's original work; and, even if it is an Arabian interpolation, it is not likely to have been made without some definite authority. If then Apollonius was the discoverer of the proposition, the fact affords some ground for thinking that the beginnings of trigonometry go as far back, at least, as Apollonius. Tannery¹ indeed suggested that not only Apollonius but Archimedes before him may have compiled a 'table of chords', or at least shown the way to such a compilation, Archimedes in the work of which we possess only a fragment in the *Measurement of a Circle*, and Apollonius in the *ὠκυτόκιον*, where he gave an approximation to the value of π closer than that obtained by Archimedes; Tannery compares the Indian Table of Sines in the *Sūrya-Siddhānta*, where the angles go by 24ths of a right angle ($1/24\text{th} = 3^\circ 45'$, $2/24\text{ths} = 7^\circ 30'$, &c.), as possibly showing Greek influence. This is, however, in the region of conjecture; the first person to make systematic use of trigonometry is, so far as we know, Hipparchus.

HIPPARCHUS, the greatest astronomer of antiquity, was born at Nicaea in Bithynia. The period of his activity is indicated by references in Ptolemy to observations made by him the limits of which are from 161 B.C. to 126 B.C. Ptolemy further says that from Hipparchus's time to the beginning of the reign of Antoninus Pius (A.D. 138) was 265 years.² The best and most important observations made by Hipparchus were made at Rhodes, though an observation of the vernal equinox at Alexandria on March 24, 146 B.C., recorded by him may have been his own. His main contributions to theoretical and practical astronomy can here only be indicated in the briefest manner.

¹ Tannery, *Recherches sur l'hist. de l'astronomie ancienne*, p. 64.

² Ptolemy, *Syntaxis*, vii. 2 (vol. ii, p. 15).



THIS PAGE IS LOCKED TO FREE MEMBERS

Purchase full membership to immediately unlock this page

DELVE INTO FANTASY, MAGIC, MYTHOLOGY & FOLKLORE

Forgotten Books'
Full Membership gives
access to 797,885 ancient
and modern, fiction and
non-fiction books.

Continue

*Fair usage policy applies

that the lengths of the mean synodic, the sidereal, the anomalistic and the draconitic month obtained by Hipparchus agree exactly with Babylonian cuneiform tables of date not later than Hipparchus, and it is clear that Hipparchus was in full possession of all the results established by Babylonian astronomy.

Improved estimates of sizes and distances of sun and moon.

4. Hipparchus improved on Aristarchus's calculations of the sizes and distances of the sun and moon, determining the apparent diameters more exactly and noting the changes in them; he made the mean distance of the sun $1,245 D$, the mean distance of the moon $33\frac{2}{3} D$, the diameters of the sun and moon $12\frac{1}{3} D$ and $\frac{1}{3} D$ respectively, where D is the mean diameter of the earth.

Epicycles and eccentrics.

5. Hipparchus, in investigating the motions of the sun, moon and planets, proceeded on the alternative hypotheses of epicycles and eccentrics; he did not invent these hypotheses, which were already fully understood and discussed by Apollonius. While the motions of the sun and moon could with difficulty be accounted for by the simple epicycle and eccentric hypotheses, Hipparchus found that for the planets it was necessary to combine the two, i.e. to superadd epicycles to motion in eccentric circles.

Catalogue of stars.

6. He compiled a catalogue of fixed stars including 850 or more such stars; apparently he was the first to state their positions in terms of coordinates in relation to the ecliptic (latitude and longitude), and his table distinguished the apparent sizes of the stars. His work was continued by Ptolemy, who produced a catalogue of 1,022 stars which, owing to an error in his solar tables affecting all his longitudes, has by many erroneously been supposed to be a mere reproduction of Hipparchus's catalogue. That Ptolemy took many observations himself seems certain.¹

¹ See two papers by Dr. J. L. E. Dreyer in the *Monthly Notices of the Royal Astronomical Society*, 1917, pp. 528-39, and 1918, pp. 343-9.

Improved Instruments.

7. He made great improvements in the instruments used for observations. Among those which he used were an improved dioptra, a 'meridian-instrument' designed for observations in the meridian only, and a universal instrument (*ἀστρολάβον ὄργανον*) for more general use. He also made a globe on which he showed the positions of the fixed stars as determined by him; it appears that he showed a larger number of stars on his globe than in his catalogue.

Geography.

In geography Hipparchus wrote a criticism of Eratosthenes, in great part unfair. He checked Eratosthenes's data by means of a sort of triangulation; he insisted on the necessity of applying astronomy to geography, of fixing the position of places by latitude and longitude, and of determining longitudes by observations of lunar eclipses.

Outside the domain of astronomy and geography, Hipparchus wrote a book *On things borne down by their weight* from which Simplicius (on Aristotle's *De caelo*, p. 264 sq.) quotes two propositions. It is possible, however, that even in this work Hipparchus may have applied his doctrine to the case of the heavenly bodies.

In pure mathematics he is said to have considered a problem in permutations and combinations, the problem of finding the number of different possible combinations of 10 axioms or assumptions, which he made to be 103,049 (*v.l.* 101,049) or 310,952 according as the axioms were affirmed or denied¹: it seems impossible to make anything of these figures. When the *Fihrist* attributes to him works 'On the art of algebra, known by the title of the Rules' and 'On the division of numbers', we have no confirmation: Suter suspects some confusion, in view of the fact that the article immediately following in the *Fihrist* is on Diophantus, who also 'wrote on the art of algebra'.

¹ P a , *Quaest. Conviv.* viii. 9. 3, 732 F, *De Stoicorum repugn.* 29. 1047 but rch

First systematic use of Trigonometry.

We come now to what is the most important from the point of view of this work, Hipparchus's share in the development of trigonometry. Even if he did not invent it, Hipparchus is the first person of whose systematic use of trigonometry we have documentary evidence. (1) Theon of Alexandria says on the *Syntaxis* of Ptolemy, à propos of Ptolemy's Table of Chords in a circle (equivalent to sines), that Hipparchus, too, wrote a treatise in twelve books on straight lines (i.e. chords) in a circle, while another in six books was written by Menelaus.¹ In the *Syntaxis* I. 10 Ptolemy gives the necessary explanations as to the notation used in his Table. The circumference of the circle is divided into 360 parts or degrees; the diameter is also divided into 120 parts, and one of such parts is the unit of length in terms of which the length of each chord is expressed; each part, whether of the circumference or diameter, is divided into 60 parts, each of these again into 60, and so on, according to the system of sexagesimal fractions. Ptolemy then sets out the minimum number of propositions in plane geometry upon which the calculation of the chords in the Table is based (*διὰ τῆς ἐκ τῶν γραμμῶν μεθοδικῆς αὐτῶν συστάσεως*). The propositions are famous, and it cannot be doubted that Hipparchus used a set of propositions of the same kind, though his exposition probably ran to much greater length. As Ptolemy definitely set himself to give the necessary propositions in the shortest form possible, it will be better to give them under Ptolemy rather than here. (2) Pappus, in speaking of Euclid's propositions about the inequality of the times which equal arcs of the zodiac take to rise, observes that 'Hipparchus in his book *On the rising of the twelve signs of the zodiac* shows by means of numerical calculations (*δι' ἀριθμῶν*) that equal arcs of the semicircle beginning with Cancer which set in times having a certain relation to one another do not everywhere show the same relation between the times in which they rise',² and so on. We have seen that Euclid, Autolycus, and even Theodosius could only prove that the said times are greater or less

¹ Theon, *Comm. on Syntaxis*, p. 110, ed. Halma.

² Pappus, vi, p. 600. 9-13.



THIS PAGE IS LOCKED TO FREE MEMBERS

Purchase full membership to immediately unlock this page

FORGOTTEN BOOKS

FULL

MEMBERSHIP

797,885 Books!

All you can read

for only

\$8.99/month

Continue

*Fair usage policy applies



in his *Commentary*, he used the formulae of spherical trigonometry to get his results. In the particular case where it is required to find the time in which a star of $27\frac{1}{3}^\circ$ northern declination describes, in the latitude of Rhodes, the portion of its arc above the horizon, Hipparchus must have used the equivalent of the formula in the solution of a right-angled spherical triangle, $\tan b = \cos A \tan c$, where C is the right angle. Whether, like Ptolemy, Hipparchus obtained the formulae, such as this one, which he used from different applications of the one general theorem (Menelaus's theorem) it is not possible to say. There was of course no difficulty in calculating the tangent or other trigonometrical function of an angle if only a table of sines was given; for Hipparchus and Ptolemy were both aware of the fact expressed by $\sin^2 \alpha + \cos^2 \alpha = 1$ or, as they would have written it,

$$(\text{crd. } 2\alpha)^2 + \{\text{crd. } (180^\circ - 2\alpha)\}^2 = 4r^2,$$

where $(\text{crd. } 2\alpha)$ means the chord subtending an arc 2α , and r is the radius, of the circle of reference.

Table of Chords.

We have no details of Hipparchus's Table of Chords sufficient to enable us to compare it with Ptolemy's, which goes by half-degrees, beginning with angles of $\frac{1}{2}^\circ$, 1° , $1\frac{1}{2}^\circ$, and so on. But Heron¹ in his *Metrica* says that 'it is proved in the books about chords in a circle' that, if a_9 and a_{11} are the sides of a regular enneagon (9-sided figure) and hendécagon (11-sided figure) inscribed in a circle of diameter d , then (1) $a_9 = \frac{1}{3}d$, (2) $a_{11} = \frac{7}{25}d$ very nearly, which means that $\sin 20^\circ$ was taken as equal to $0.3333 \dots$ (Ptolemy's table makes it $\frac{1}{60} \left(20 + \frac{31}{60} + \frac{16\frac{1}{2}}{60^2} \right)$, so that the first approximation is $\frac{1}{3}$), and $\sin \frac{1}{11} \cdot 180^\circ$ or $\sin 16^\circ 21' 49''$ was made equal to 0.28 (this corresponds to the chord subtending an angle of $32^\circ 43' 38''$, nearly half-way between $32\frac{1}{2}^\circ$ and 33° , and the mean between the two chords subtending the latter angles gives $\frac{1}{60} \left(16 + \frac{54}{60} + \frac{55}{60^2} \right)$ as the required sine, while $\frac{1}{60} \left(16\frac{9}{10} \right) = \frac{169}{600}$, which only differs

¹ Heron, *Metrica*, i. 22, 24, pp. 58. 19 and 62. 17.

by $\frac{1}{600}$ from $\frac{168}{600}$ or $\frac{7}{25}$, Heron's figure). There is little doubt that it is to Hipparchus's work that Heron refers, though the author is not mentioned.

While for our knowledge of Hipparchus's trigonometry we have to rely for the most part upon what we can infer from Ptolemy, we fortunately possess an original source of information about Greek trigonometry in its highest development in the *Sphaerica* of Menelaus.

The date of MENELAUS of Alexandria is roughly indicated by the fact that Ptolemy quotes an observation of his made in the first year of Trajan's reign (A.D. 98). He was therefore a contemporary of Plutarch, who in fact represents him as being present at the dialogue *De facie in orbe lunae*, where (chap. 17) Lucius apologizes to Menelaus 'the mathematician' for questioning the fundamental proposition in optics that the angles of incidence and reflection are equal.

He wrote a variety of treatises other than the *Sphaerica*. We have seen that Theon mentions his work on *Chords in a Circle* in six Books. Pappus says that he wrote a treatise (*πραγματεία*) on the setting (or perhaps only rising) of different arcs of the zodiac.¹ Proclus quotes an alternative proof by him of Eucl. I. 25, which is direct instead of by *reductio ad absurdum*,² and he would seem to have avoided the latter kind of proof throughout. Again, Pappus, speaking of the many complicated curves 'discovered by Demetrius of Alexandria (in his "Linear considerations") and by Philon of Tyana as the result of interweaving plectoids and other surfaces of all kinds', says that one curve in particular was investigated by Menelaus and called by him 'paradoxical' (*παράδοξος*)³; the nature of this curve can only be conjectured (see below).

But Arabian tradition refers to other works by Menelaus, (1) *Elements of Geometry*, edited by Thābit b. Qurra, in three Books, (2) a Book on triangles, and (3) a work the title of which is translated by Wenrich *de cognitione quantitatis discretæ corporum permixtorum*. Light is thrown on this last title by one al-Chāzinī who (about A.D. 1121) wrote a

¹ Pappus, vi, pp. 600-2.

² Proclus on Eucl. I, pp. 345. 14-346. 11.

³ Pappus, iv, p. 270. 25.

treatise about the hydrostatic balance, i.e. about the determination of the specific gravity of homogeneous or mixed bodies, in the course of which he mentions Archimedes and Menelaus (among others) as authorities on the subject; hence the treatise (3) must have been a book on hydrostatics discussing such problems as that of the crown solved by Archimedes. The alternative proof of Eucl. I. 25 quoted by Proclus might have come either from the *Elements of Geometry* or the Book on triangles. With regard to the geometry, the 'liber trium fratrum' (written by three sons of Mūsā b. Shākir in the ninth century) says that it contained a solution of the duplication of the cube, which is none other than that of Archytas. The solution of Archytas having employed the intersection of a tore and a cylinder (with a cone as well), there would, on the assumption that Menelaus reproduced the solution, be a certain appropriateness in the suggestion of Tannery¹ that the curve which Menelaus called the *παράδοξος γραμμή* was in reality the curve of double curvature, known by the name of Viviani, which is the intersection of a sphere with a cylinder touching it internally and having for its diameter the radius of the sphere. This curve is a particular case of Eudoxus's *hippopede*, and it has the property that the portion left outside the curve of the surface of the hemisphere on which it lies is equal to the square on the diameter of the sphere; the fact of the said area being squareable would justify the application of the word *παράδοξος* to the curve, and the quadrature itself would not probably be beyond the powers of the Greek mathematicians, as witness Pappus's determination of the area cut off between a complete turn of a certain spiral on a sphere and the great circle touching it at the origin.²

The *Sphaerica* of Menelaus.

This treatise in three Books is fortunately preserved in the Arabic, and although the extant versions differ considerably in form, the substance is beyond doubt genuine; the original translator was apparently Ishāq b. Ḥunain (died A. D. 910). There have been two editions, (1) a Latin

¹ Tannery, *Mémoires scientifiques*, ii, p. 17.

² Pappus, iv, pp. 264-8.



THIS PAGE IS LOCKED TO FREE MEMBERS

Purchase full membership to immediately unlock this page

DELVE INTO FANTASY, MAGIC, MYTHOLOGY & FOLKLORE

Forgotten Books'
Full Membership gives
access to 797,885 ancient
and modern, fiction and
non-fiction books.

Continue

*Fair usage policy applies

already appropriated for the plane triangle. We should gather from this, as well as from the restriction of the definitions to the spherical triangle and its parts, that the discussion of the spherical triangle as such was probably new; and if the preface in the Arabic version addressed to a prince and beginning with the words, 'O prince! I have discovered an excellent method of proof...' is genuine, we have confirmatory evidence in the writer's own claim.

Menelaus's object, so far as Book I is concerned, seems to have been to give the main propositions about spherical triangles corresponding to Euclid's propositions about plane triangles. At the same time he does not restrict himself to Euclid's methods of proof even where they could be adapted to the case of the sphere; he avoids the form of proof by *reductio ad absurdum*, but, subject to this, he prefers the easiest proofs. In some respects his treatment is more complete than Euclid's treatment of the analogous plane cases. In the congruence-theorems, for example, we have I. 4a corresponding to Eucl. I. 4, I. 4b to Eucl. I. 8, I. 14, 16 to Eucl. I. 26 a, b; but Menelaus includes (I. 13) what we know as the 'ambiguous case', which is enunciated on the lines of Eucl. VI. 7. I. 12 is a particular case of I. 16. Menelaus includes also the further case which has no analogue in plane triangles, that in which the three angles of one triangle are severally equal to the three angles of the other (I. 17). He makes, moreover, no distinction between the congruent and the symmetrical, regarding both as covered by congruent. I. 1 is a problem, to construct a spherical angle equal to a given spherical angle, introduced only as a lemma because required in later propositions. I. 2, 3 are the propositions about isosceles triangles corresponding to Eucl. I. 5, 6; Eucl. I. 18, 19 (greater side opposite greater angle and vice versa) have their analogues in I. 7, 9, and Eucl. I. 24, 25 (two sides respectively equal and included angle, or third side, in one triangle greater than included angle, or third side, in the other) in I. 8. I. 5 (two sides of a triangle together greater than the third) corresponds to Eucl. I. 20. There is yet a further group of propositions comparing parts of spherical triangles, I. 6, 18, 19, where I. 6 (corresponding to Eucl. I. 21) is deduced from I. 5, just as the first part of Eucl. I. 21 is deduced from Eucl. I. 20.

Eucl. I. 16, 32 are not true of spherical triangles, and Menelaus has therefore the corresponding but different propositions. I. 10 proves that, with the usual notation a, b, c, A, B, C , for the sides and opposite angles of a spherical triangle, the exterior angle at C , or $180^\circ - C$, $< =$ or $> A$ according as $c + a > =$ or $< 180^\circ$, and vice versa. The proof of this and the next proposition shall be given as specimens.

In the triangle ABC suppose that $c + a > =$ or $< 180^\circ$; let D be the pole opposite to A .

Then, according as $c + a > =$ or $< 180^\circ$, $BC > =$ or $< BD$ (since $AD = 180^\circ$),

and therefore $\angle D > =$ or $< \angle BCD (= 180^\circ - C)$, [I. 9]

i.e. (since $\angle D = \angle A$) $180^\circ - C < =$ or $> A$.

Menelaus takes the converse for granted.

As a consequence of this, I. 11 proves that $A + B + C > 180^\circ$.

Take the same triangle ABC , with the pole D opposite

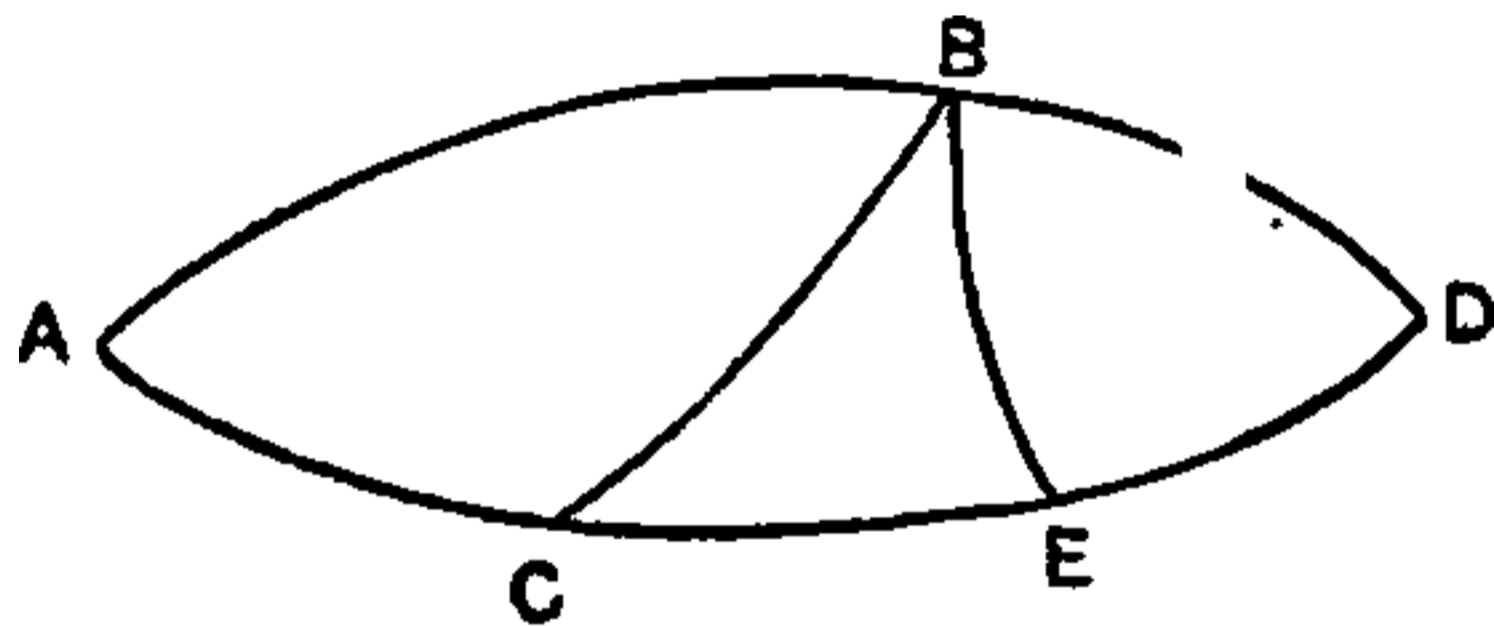

to A , and from B draw the great circle BE such that $\angle DBE = \angle BDE$.

Then $CE + EB = CD < 180^\circ$, so that, by the preceding proposition, the exterior angle ACB to the triangle BCE is greater than $\angle CBE$,

i.e. $C > \angle CBE$.

Add A or $D (= \angle EBD)$ to the unequals;

therefore $C + A > \angle CBD$,

whence $A + B + C > \angle CBD + B$ or 180° .

After two lemmas I. 21, 22 we have some propositions introducing M, N, P the middle points of a, b, c respectively. I. 23 proves, e.g., that the arc MN of a great circle $> \frac{1}{2}c$, and I. 20 that $AM < =$ or $> \frac{1}{2}a$ according as $A > =$ or $< (B + C)$. The last group of propositions, 26–35, relate to the figure formed

by the triangle ABC with great circles drawn through B to meet AC (between A and C) in D, E respectively, and the case where D and E coincide, and they prove different results arising from different relations between a and c ($a > c$), combined with the equality of AD and EC (or DC), of the angles ABD and EBC (or DBC), or of $a + c$ and $BD + BE$ (or $2BD$) respectively, according as $a + c < =$ or $> 180^\circ$.

Book II has practically no interest for us. The object of it is to establish certain propositions, of astronomical interest only, which are nothing more than generalizations or extensions of propositions in Theodosius's *Sphaerica*, Book III. Thus Theodosius III. 5, 6, 9 are included in Menelaus II. 10, Theodosius III. 7–8 in Menelaus II. 12, while Menelaus II. 11 is an extension of Theodosius III. 13. The proofs are quite different from those of Theodosius, which are generally very long-winded.

Book III. Trigonometry.

It will have been noticed that, while Book I of Menelaus gives the geometry of the spherical triangle, neither Book I nor Book II contains any trigonometry. This is reserved for Book III. As I shall throughout express the various results obtained in terms of the trigonometrical ratios, sine, cosine, tangent, it is necessary to explain once for all that the Greeks did not use this terminology, but, instead of sines, they used the chords subtended by arcs of a circle.

In the accompanying figure let the arc AD of a circle subtend an angle α at the centre O . Draw AM perpendicular to OD , and produce it to meet the circle again in A' . Then $\sin \alpha = AM/AO$, and AM is $\frac{1}{2}AA'$ or half the chord subtended by an angle 2α at the centre, which may shortly be denoted by $\frac{1}{2}(\text{crd. } 2\alpha)$.

Since Ptolemy expresses the chords as so many 120th parts of the diameter of the circle, while $AM/AO = AA'/2AO$, it follows that $\sin \alpha$ and $\frac{1}{2}(\text{crd. } 2\alpha)$ are equivalent. $\cos \alpha$ is of course $\sin (90^\circ - \alpha)$ and is therefore equivalent to $\frac{1}{2} \text{crd. } (180^\circ - 2\alpha)$.

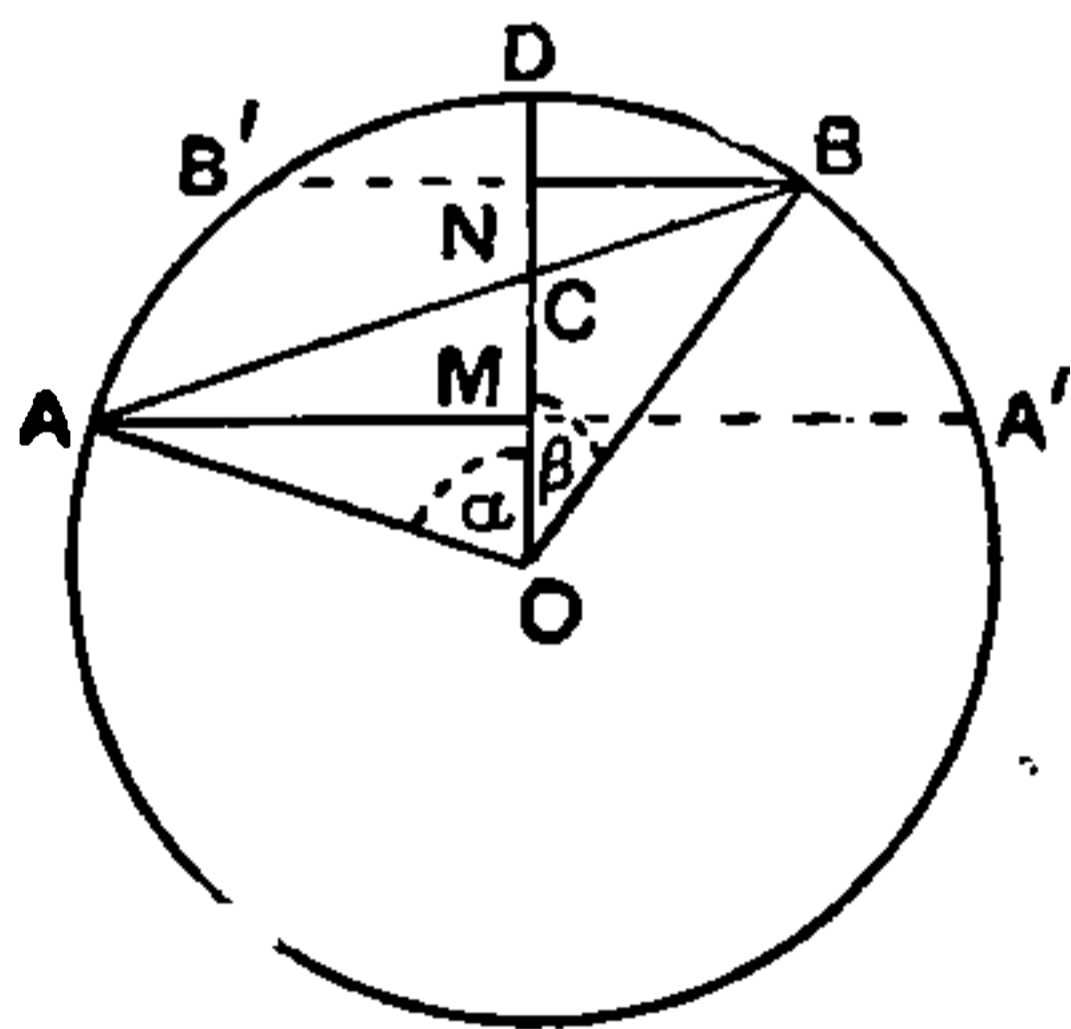



THIS PAGE IS LOCKED TO FREE MEMBERS

Purchase full membership to immediately unlock this page

FORGOTTEN BOOKS

FULL

MEMBERSHIP

797,885 Books!

All you can read

for only

\$8.99/month

Continue

*Fair usage policy applies



For, if AM , BN are perpendicular to OC , we have, as before,

$$\begin{aligned} AT:TB &= AM:BN \\ &= \frac{1}{2} (\text{crd. } 2 AC) : \frac{1}{2} (\text{crd. } 2 BC) \\ &= \sin AC : \sin BC. \end{aligned}$$

Now let the arcs of great circles ADB , AEC be cut by the arcs of great circles DFC , BFE which themselves meet in F .

Let G be the centre of the sphere and join GB , GF , GE , AD .

Then the straight lines AD , GB , being in one plane, are either parallel or not parallel. If they are not parallel, they will meet either in the direction of D , B or of A , G .

Let AD , GB meet in T .

Draw the straight lines AKC , DLC meeting GE , GF in K , L respectively.

Then K , L , T must lie on a straight line, namely the straight line which is the section of the planes determined by the arc EFB and by the triangle ACD .¹

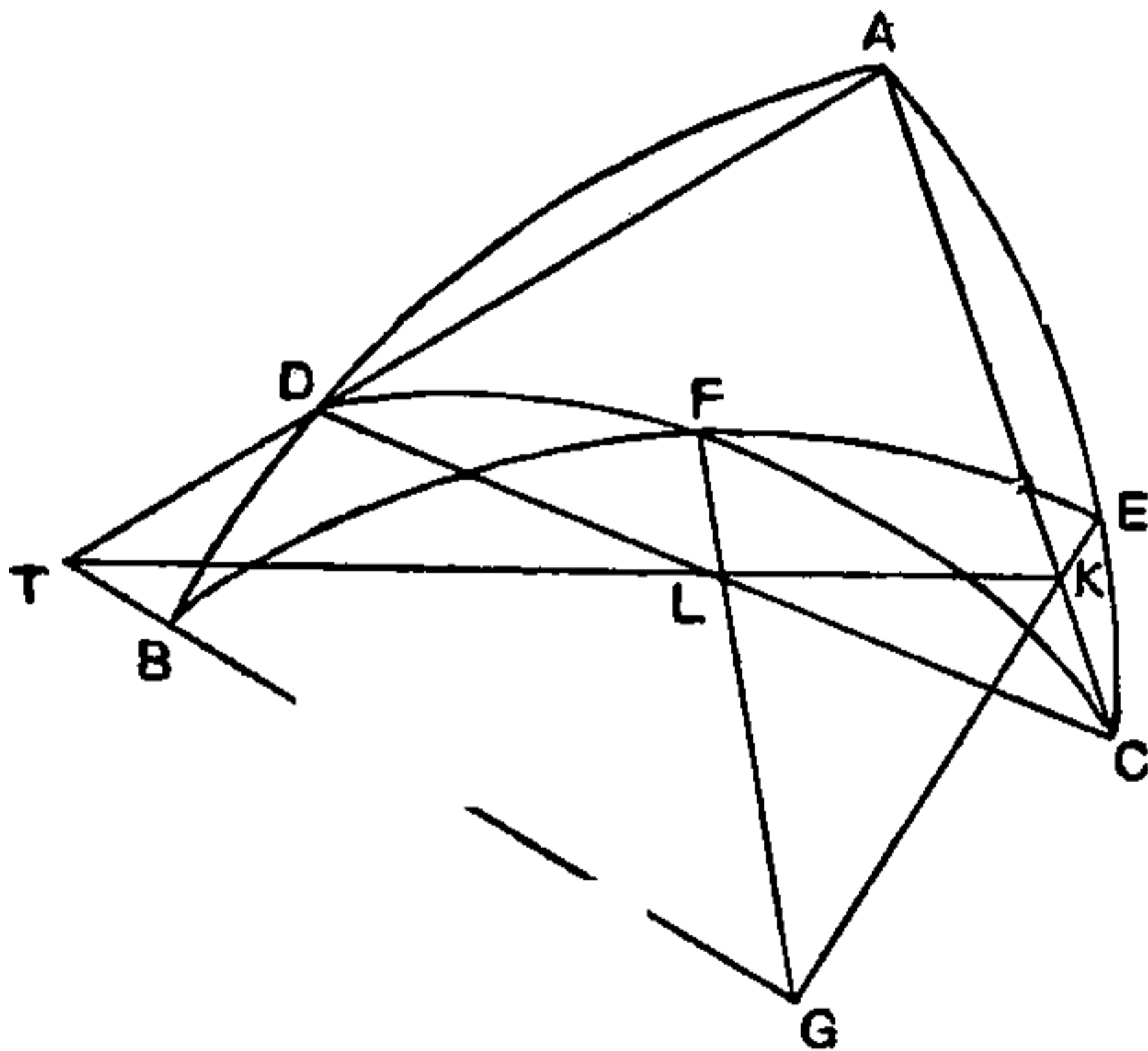

Thus we have two straight lines AC , AT cut by the two straight lines CD , TK which themselves intersect in L .

Therefore, by Menelaus's proposition in plane geometry,

$$\frac{CK}{KA} = \frac{CL}{LD} \cdot \frac{DT}{TA}.$$

¹ So Ptolemy. In other words, since the straight lines GB , GE , GF , which are in one plane, respectively intersect the straight lines AD , AC , CD which are also in one plane, the points of intersection T , K , L are in both planes, and therefore lie on the straight line in which the planes intersect.

But, by the propositions proved above,

$$\frac{CK}{KA} = \frac{\sin CE}{\sin EA}, \quad \frac{CL}{LD} = \frac{\sin CF}{\sin FD}, \quad \text{and} \quad \frac{DT}{TA} = \frac{\sin DB}{\sin BA};$$

therefore, by substitution, we have

$$\frac{\sin CE}{\sin EA} = \frac{\sin CF}{\sin FD} \cdot \frac{\sin DB}{\sin BA}.$$

Menelaus apparently also gave the proof for the cases in which AD, GB meet towards A, G , and in which AD, GB are parallel respectively, and also proved that in like manner, in the above figure,

$$\frac{\sin CA}{\sin AE} = \frac{\sin CD}{\sin DF} \cdot \frac{\sin FB}{\sin BE}$$

(the triangle cut by the transversal being here CFE instead of ADC). Ptolemy¹ gives the proof of the above case only, and dismisses the last-mentioned result with a 'similarly'.

(β) *Deductions from Menelaus's Theorem.*

III. 2 proves, by means of I. 14, 10 and III. 1, that, if $ABC, A'B'C'$ be two spherical triangles in which $A = A'$, and C, C' are either equal or supplementary, $\sin c / \sin a = \sin c' / \sin a'$ and conversely. The particular case in which C, C' are right angles gives what was afterwards known as the 'regula quattuor quantitatum' and was fundamental in Arabian trigonometry.² A similar association attaches to the result of III. 3, which is the so-called 'tangent' or 'shadow-rule' of the Arabs. If $ABC, A'B'C'$ be triangles right-angled at A, A' , and C, C' are equal and both either $>$ or $<$ 90° , and if P, P' be the poles of $AC, A'C'$, then

$$\frac{\sin AB}{\sin AC} = \frac{\sin A'B'}{\sin A'C'} \cdot \frac{\sin BP}{\sin B'P'}.$$

Apply the triangles so that C' falls on $C, C'B'$ on CB as CE , and $C'A'$ on CA as CD ; then the result follows directly from III. 1. Since $\sin BP = \cos AB$, and $\sin B'P' = \cos A'B'$, the result becomes

$$\frac{\sin CA}{\sin C'A'} = \frac{\tan AB}{\tan A'B'},$$

which is the 'tangent-rule' of the Arabs.³

¹ Ptolemy, *Syntaxis*, i. 13, vol. i, p. 76.

² See Braunmühl, *Gesch. der Trig.* i, pp. 17, 47, 58-60, 127-9.

³ Cf. Braunmühl, *op. cit.* i, pp. 17-18, 58, 67-9, &c.

It follows at once (Prop. 4) that, if $AM, A'M'$ are great circles drawn perpendicular to the bases $BC, B'C'$ of two spherical triangles $ABC, A'B'C'$ in which $B = B', C = C'$,

$$\frac{\sin BM}{\sin B'M'} = \frac{\sin MC}{\sin M'C'} \left(\text{since both are equal to } \frac{\tan AM}{\tan A'M'} \right).$$

III. 5 proves that, if there are two spherical triangles $ABC,$

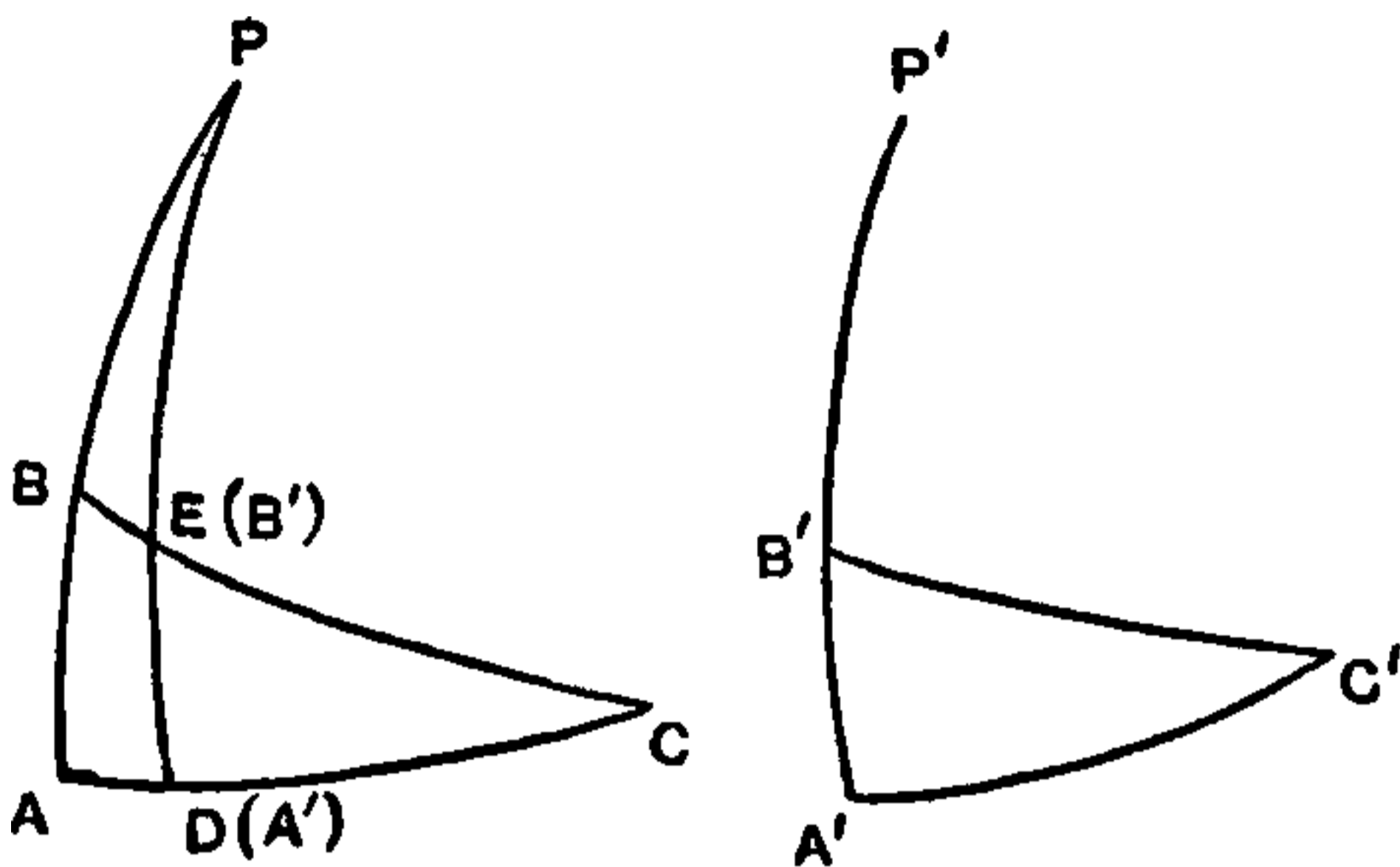

$A'B'C'$ right-angled at A, A' and such that $C = C'$, while b and b' are less than 90° ,

$$\frac{\sin (a + b)}{\sin (a - b)} = \frac{\sin (a' + b')}{\sin (a' - b')},$$

from which we may deduce¹ the formula

$$\frac{\sin (a + b)}{\sin (a - b)} = \frac{1 + \cos C}{1 - \cos C},$$

which is equivalent to $\tan b = \tan a \cos C$.

(γ) *Anharmonic property of four great circles through one point.*

But more important than the above result is the fact that the proof assumes as known the anharmonic property of four great circles drawn from a point on a sphere in relation to any great circle intersecting them all, viz. that, if $ABCD, A'B'C'D'$ be two transversals,

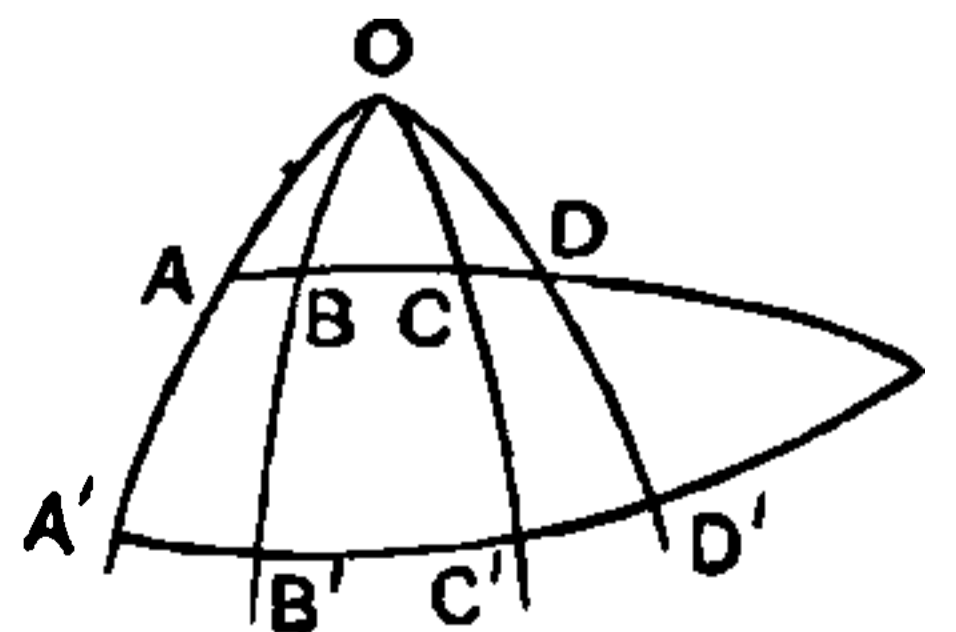

$$\frac{\sin AD}{\sin DC} \cdot \frac{\sin BC}{\sin AB} = \frac{\sin A'D'}{\sin D'C'} \cdot \frac{\sin B'C'}{\sin A'B'}.$$

¹ Braunmühl, *op. cit.* i, p. 18; Björnbo, p. 96.



THIS PAGE IS LOCKED TO FREE MEMBERS

Purchase full membership to immediately unlock this page

DELVE INTO FANTASY, MAGIC, MYTHOLOGY & FOLKLORE

Forgotten Books'
Full Membership gives
access to 797,885 ancient
and modern, fiction and
non-fiction books.

Continue

*Fair usage policy applies

III. 9 and III. 10 show, for a spherical triangle, that (1) the great circles bisecting the three angles, (2) the great circles through the angular points meeting the opposite sides at right angles meet in a point.

The remaining propositions, III. 11–15, return to the same sort of astronomical problem as those dealt with in Euclid's *Phaenomena*, Theodosius's *Sphaerica* and Book II of Menelaus's own work. Props. 11–14 amount to theorems in spherical trigonometry such as the following.

Given arcs $\alpha_1, \alpha_2, \alpha_3, \alpha_4, \beta_1, \beta_2, \beta_3, \beta_4$, such that

$$90^\circ \geq \alpha_1 > \alpha_2 > \alpha_3 > \alpha_4,$$

$$90^\circ > \beta_1 > \beta_2 > \beta_3 > \beta_4,$$

and also $\alpha_1 > \beta_1, \alpha_2 > \beta_2, \alpha_3 > \beta_3, \alpha_4 > \beta_4$,

(1) If $\sin \alpha_1 : \sin \alpha_2 : \sin \alpha_3 : \sin \alpha_4 = \sin \beta_1 : \sin \beta_2 : \sin \beta_3 : \sin \beta_4$,

then
$$\frac{\alpha_1 - \alpha_2}{\alpha_3 - \alpha_4} > \frac{\beta_1 - \beta_2}{\beta_3 - \beta_4}.$$

(2) If
$$\frac{\sin(\alpha_1 + \beta_1)}{\sin(\alpha_1 - \beta_1)} = \frac{\sin(\alpha_2 + \beta_2)}{\sin(\alpha_2 - \beta_2)} = \frac{\sin(\alpha_3 + \beta_3)}{\sin(\alpha_3 - \beta_3)} = \frac{\sin(\alpha_4 + \beta_4)}{\sin(\alpha_4 - \beta_4)},$$

then
$$\frac{\alpha_1 - \alpha_2}{\alpha_3 - \alpha_4} < \frac{\beta_1 - \beta_2}{\beta_3 - \beta_4}.$$

(3) If
$$\frac{\sin(\alpha_1 - \alpha_2)}{\sin(\alpha_3 - \alpha_4)} < \frac{\sin(\beta_1 - \beta_2)}{\sin(\beta_3 - \beta_4)}$$

then
$$\frac{\alpha_1 - \alpha_2}{\alpha_3 - \alpha_4} < \frac{\beta_1 - \beta_2}{\beta_3 - \beta_4}.$$

Again, given three series of three arcs such that

$$\alpha_1 > \alpha_2 > \alpha_3, \quad \beta_1 > \beta_2 > \beta_3, \quad 90^\circ > \gamma_1 > \gamma_2 > \gamma_3,$$

and $\sin(\alpha_1 - \gamma_1) : \sin(\alpha_2 - \gamma_2) : \sin(\alpha_3 - \gamma_3)$

$$= \sin(\beta_1 - \gamma_1) : \sin(\beta_2 - \gamma_2) : \sin(\beta_3 - \gamma_3)$$

$$= \sin \gamma_1 : \sin \gamma_2 : \sin \gamma_3$$

But, by III. 1 applied to the triangle BC_1A_1 cut by the transversal PC_3A_3 ,

$$\frac{\sin A_1A_3}{\sin BA_3} = \frac{\sin C_1C_3}{\sin BC_3} \cdot \frac{\sin PA_1}{\sin PC_1},$$

or
$$\frac{\sin A_1A_3}{\sin C_1C_3} = \frac{\sin PA_1}{\sin PC_1} \cdot \frac{\sin BA_3}{\sin BC_3} = \frac{\sin PA_1}{\sin PC_1} \cdot \frac{\sin PC}{\sin PC_3},$$

from above,

$$= \frac{Rr}{r_1 r_3}.$$

Part 2 of the proposition proves that, if PC_2A_2 be drawn such that $\sin^2 PC_2 = \sin PA_2 \cdot \sin PC$, or $r_2^2 = Rr$ (where r_2 is the radius of the parallel circle through C_2), $BC_2 - BA_2$ is a maximum, while Parts 3, 4 discuss the limits to the value of the ratio between the arcs A_1A_3 and C_1C_3 .

Nothing is known of the life of CLAUDIUS PTOLEMY except that he was of Alexandria, made observations between the years A.D. 125 and 141 or perhaps 151, and therefore presumably wrote his great work about the middle of the reign of Antoninus Pius (A.D. 138–61). A tradition handed down by the Byzantine scholar Theodorus Meliteniota (about 1361) states that he was born, not at Alexandria, but at Ptolemais ἡ Ἐρμείου. Arabian traditions, going back probably to Ḥunain b. Ishāq, say that he lived to the age of 78, and give a number of personal details to which too much weight must not be attached.

The *Μαθηματικὴ σύνταξις* (Arab. *Almagest*).

Ptolemy's great work, the definitive achievement of Greek astronomy, bore the title *Μαθηματικῆς Συντάξεως βιβλία ιγ*, the *Mathematical Collection* in thirteen Books. By the time of the commentators who distinguished the lesser treatises on astronomy forming an introduction to Ptolemy's work as *μικρὸς ἀστρονομούμενος (τόπος)*, the 'Little Astronomy', the book came to be called the 'Great Collection', *μεγάλη σύνταξις*. Later still the Arabs, combining the article Al with



THIS PAGE IS LOCKED TO FREE MEMBERS

Purchase full membership to immediately unlock this page

FORGOTTEN BOOKS

FULL

MEMBERSHIP

797,885 Books!

All you can read

for only

\$8.99/month

Continue

*Fair usage policy applies



(died 901), is extant in part, as well as the version by Naṣīrad-dīn at-Tūsī (1201-74).

The first edition to be published was the Latin translation made by Gherard of Cremona from the Arabic, which was finished in 1175 but was not published till 1515, when it was brought out, without the author's name, by Peter Liechtenstein at Venice. A translation from the Greek had been made about 1160 by an unknown writer for a certain Henricus Aristippus, Archdeacon of Catania, who, having been sent by William I, King of Sicily, on a mission to the Byzantine Emperor Manuel I. Comnenus in 1158, brought back with him a Greek manuscript of the *Syntaxis* as a present; this translation, however, exists only in manuscripts in the Vatican and at Florence. The first Latin translation from the Greek to be published was that made by Georgius 'of Trebizond' for Pope Nicolas V in 1451; this was revised and published by Lucas Gauricus at Venice in 1528. The *editio princeps* of the Greek text was brought out by Grynaeus at Basel in 1538. The next complete edition was that of Halma published 1813-16, which is now rare. All the more welcome, therefore, is the definitive Greek text of the astronomical works of Ptolemy edited by Heiberg (1899-1907), to which is now added, so far as the *Syntaxis* is concerned, a most valuable supplement in the German translation (with notes) by Manitius (Teubner, 1912-13).

Summary of Contents.

The *Syntaxis* is most valuable for the reason that it contains very full particulars of observations and investigations by Hipparchus, as well as of the earlier observations recorded by him, e.g. that of a lunar eclipse in 721 B.C. Ptolemy based himself very largely upon Hipparchus, e.g. in the preparation of a Table of Chords (equivalent to sines), the theory of eccentrics and epicycles, &c.; and it is questionable whether he himself contributed anything of great value except a definite theory of the motion of the five planets, for which Hipparchus had only collected material in the shape of observations made by his predecessors and himself. A very short indication of the subjects of the different Books is all that can

be given here. Book I: Indispensable preliminaries to the study of the Ptolemaic system, general explanations of the different motions of the heavenly bodies in relation to the earth as centre, propositions required for the preparation of Tables of Chords, the Table itself, some propositions in spherical geometry leading to trigonometrical calculations of the relations of arcs of the equator, ecliptic, horizon and meridian, a 'Table of Obliquity', for calculating declinations for each degree-point on the ecliptic, and finally a method of finding the right ascensions for arcs of the ecliptic equal to one-third of a sign or 10° . Book II: The same subject continued, i.e. problems on the sphere, with special reference to the differences between various latitudes, the length of the longest day at any degree of latitude, and the like. Book III: On the length of the year and the motion of the sun on the eccentric and epicycle hypotheses. Book IV: The length of the months and the theory of the moon. Book V: The construction of the astrolabe, and the theory of the moon continued, the diameters of the sun, the moon and the earth's shadow, the distance of the sun and the dimensions of the sun, moon and earth. Book VI: Conjunctions and oppositions of sun and moon, solar and lunar eclipses and their periods. Books VII and VIII are about the fixed stars and the precession of the equinoxes, and Books IX–XIII are devoted to the movements of the planets.

Trigonometry in Ptolemy.

What interests the historian of mathematics is the trigonometry in Ptolemy. It is evident that no part of the trigonometry, or of the matter preliminary to it, in Ptolemy was new. What he did was to abstract from earlier treatises, and to condense into the smallest possible space, the minimum of propositions necessary to establish the methods and formulae used. Thus at the beginning of the preliminaries to the Table of Chords in Book I he says:

'We will first show how we can establish a systematic and speedy method of obtaining the lengths of the chords based on the uniform use of the smallest possible number of propositions, so that we may not only have the lengths of the chords

set out correctly, but may be in possession of a ready proof of our method of obtaining them based on geometrical considerations.'¹

He explains that he will use the division (1) of the circle into 360 equal parts or degrees and (2) of the diameter into 120 equal parts, and will express fractions of these parts on the sexagesimal system. Then come the geometrical propositions, as follows.

(a) *Lemma for finding* $\sin 18^\circ$ *and* $\sin 36^\circ$.

To find the side of a pentagon and decagon inscribed in a circle or, in other words, the chords subtending arcs of 72° and 36° respectively.

Let AB be the diameter of a circle, O the centre, OC the radius perpendicular to AB .

Bisect OB at D , join DC , and measure DE along DA equal to DC . Join EC .

Then shall OE be the side of the inscribed regular decagon, and EC the side of the inscribed regular pentagon.

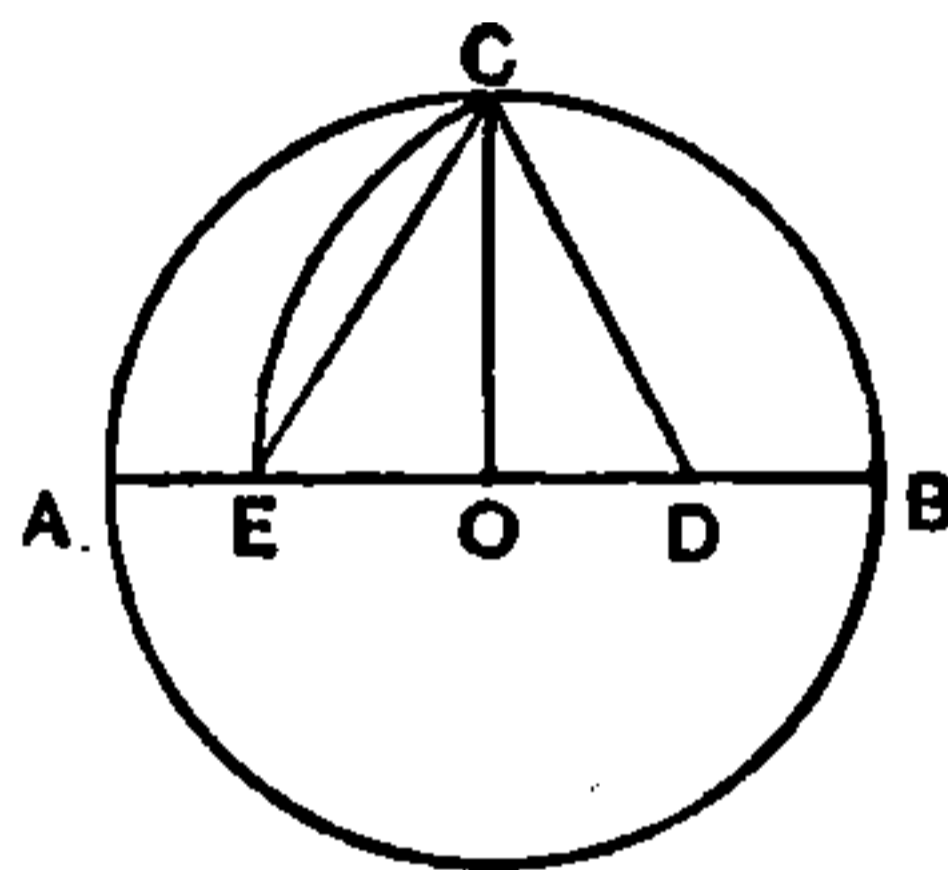

For, since OB is bisected at D ,

$$\begin{aligned} BE \cdot EO + OD^2 &= DE^2 \\ &= DC^2 = DO^2 + OC^2. \end{aligned}$$

Therefore $BE \cdot EO = OC^2 = OB^2$,

and BE is divided in extreme and mean ratio.

But (Eucl. XIII. 9) the sides of the regular hexagon and the regular decagon inscribed in a circle when placed in a straight line with one another form a straight line divided in extreme and mean ratio at the point of division.

Therefore, BO being the side of the hexagon, EO is the side of the decagon.

Also (by Eucl. XIII. 10)

$$\begin{aligned} (\text{side of pentagon})^2 &= (\text{side of hexagon})^2 + (\text{side of decagon})^2 \\ &= CO^2 + OE^2 = EC^2; \end{aligned}$$

therefore EC is the side of the regular pentagon inscribed in the circle.

¹ Ptolemy, *Syntaxis*, i. 10, pp. 31 2.



THIS PAGE IS LOCKED TO FREE MEMBERS

Purchase full membership to immediately unlock this page

DELVE INTO FANTASY, MAGIC, MYTHOLOGY & FOLKLORE

Forgotten Books'
Full Membership gives
access to 797,885 ancient
and modern, fiction and
non-fiction books.

Continue

*Fair usage policy applies

The proposition giving the required formula depends upon a lemma, which is the famous 'Ptolemy's theorem'.

Given a quadrilateral $ABCD$ inscribed in a circle, the diagonals being AC, BD , to prove that

$$AC \cdot BD = AB \cdot DC + AD \cdot BC.$$

The proof is well known. Draw BE so that the angle ABE is equal to the angle DBC , and let BE meet AC in E .

Then the triangles ABE, DBC are equiangular, and therefore

$$AB : AE = BD : DC,$$

or $AB \cdot DC = AE \cdot BD. \quad (1)$

Again, to each of the equal angles ABE, DBC add the angle EBD ;

then the angle ABD is equal to the angle EBC , and the triangles ABD, EBC are equiangular;

therefore $BC : CE = BD : DA,$

or $AD \cdot BC = CE \cdot BD. \quad (2)$

By adding (1) and (2), we obtain

$$AB \cdot DC + AD \cdot BC = AC \cdot BD.$$

Now let AB, AC be two arcs terminating at A , the extremity of the diameter AD of a circle, and let $AC (= \alpha)$ be greater than $AB (= \beta)$. Suppose that $(\text{crd. } AC)$ and $(\text{crd. } AB)$ are given: it is required to find $(\text{crd. } BC)$.

Join BD, CD .

Then, by the above theorem,

$$AC \cdot BD = BC \cdot AD + AB \cdot CD.$$

Now AB, AC are given; therefore $BD = \text{crd. } (180^\circ - AB)$ and $CD = \text{crd. } (180^\circ - AC)$ are known. And AD is known. Hence the remaining chord BC ($\text{crd. } BC$) is known.

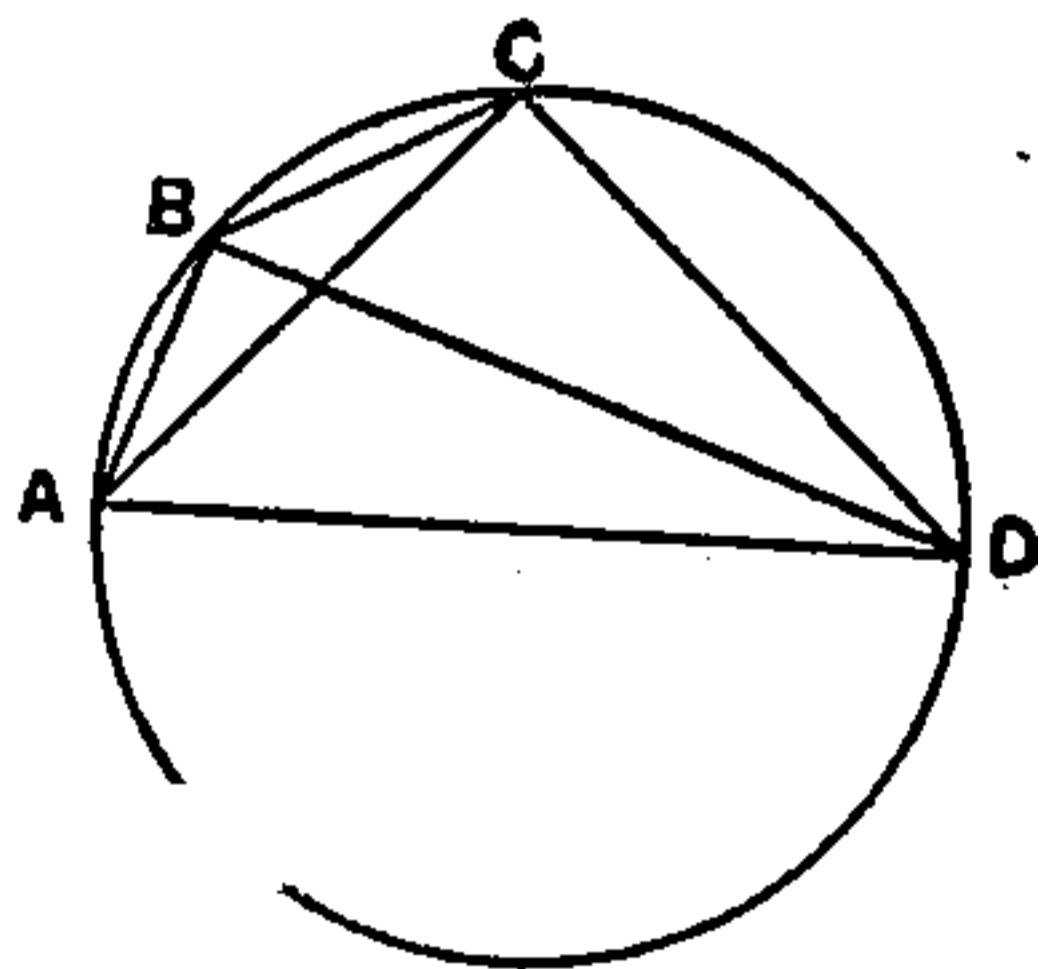
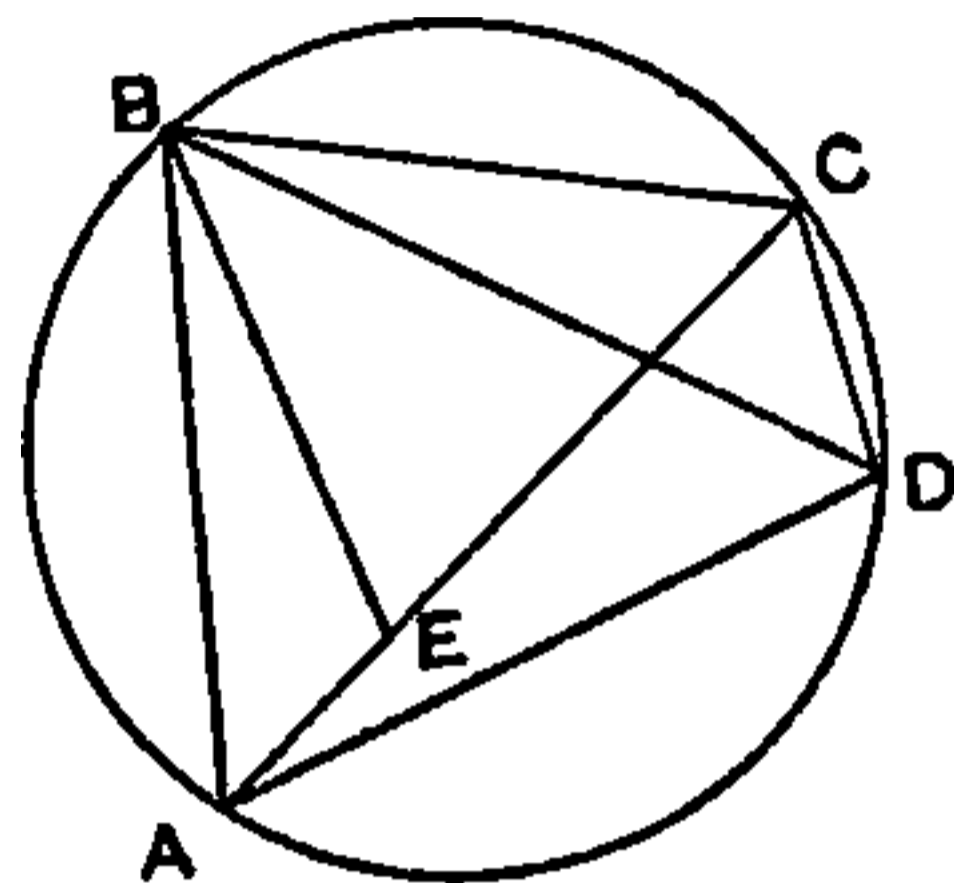

The equation in fact gives the formula,

$$\{\text{crd. } (\alpha - \beta)\} \cdot (\text{crd. } 180^\circ) = (\text{crd. } \alpha) \cdot \{\text{crd. } (180^\circ - \beta)\} \\ - (\text{crd. } \beta) \cdot \{\text{crd. } (180^\circ - \alpha)\},$$

which is, of course, equivalent to

$$\sin (\theta - \phi) = \sin \theta \cos \phi - \cos \theta \sin \phi, \text{ where } \alpha = 2\theta, \beta = 2\phi.$$

By means of this formula Ptolemy obtained

$$\text{crd. } 12^\circ = \text{crd. } (72^\circ - 60^\circ) = 12^p 32' 36''.$$

$$(\delta) \text{ Equivalent of } \sin^2 \frac{1}{2} \theta = \frac{1}{2} (1 - \cos \theta).$$

But, in order to get the chords of smaller angles still, we want a formula for finding the chord of half an arc when the chord of the arc is given. This is the subject of Ptolemy's next proposition.

Let BC be an arc of a circle with diameter AC , and let the arc BC be bisected at D . Given ($\text{crd. } BC$), it is required to find ($\text{crd. } DC$).

Draw DF perpendicular to AC , and join AB, AD, BD, DC . Measure AE along AC equal to AB , and join DE .

Then shall FC be equal to EF , or FC shall be half the difference between AC and AB .

For the triangles ABD, AED are equal in all respects, since two sides of the one are equal to two sides of the other and the included angles BAD, EAD , standing on equal arcs, are equal.

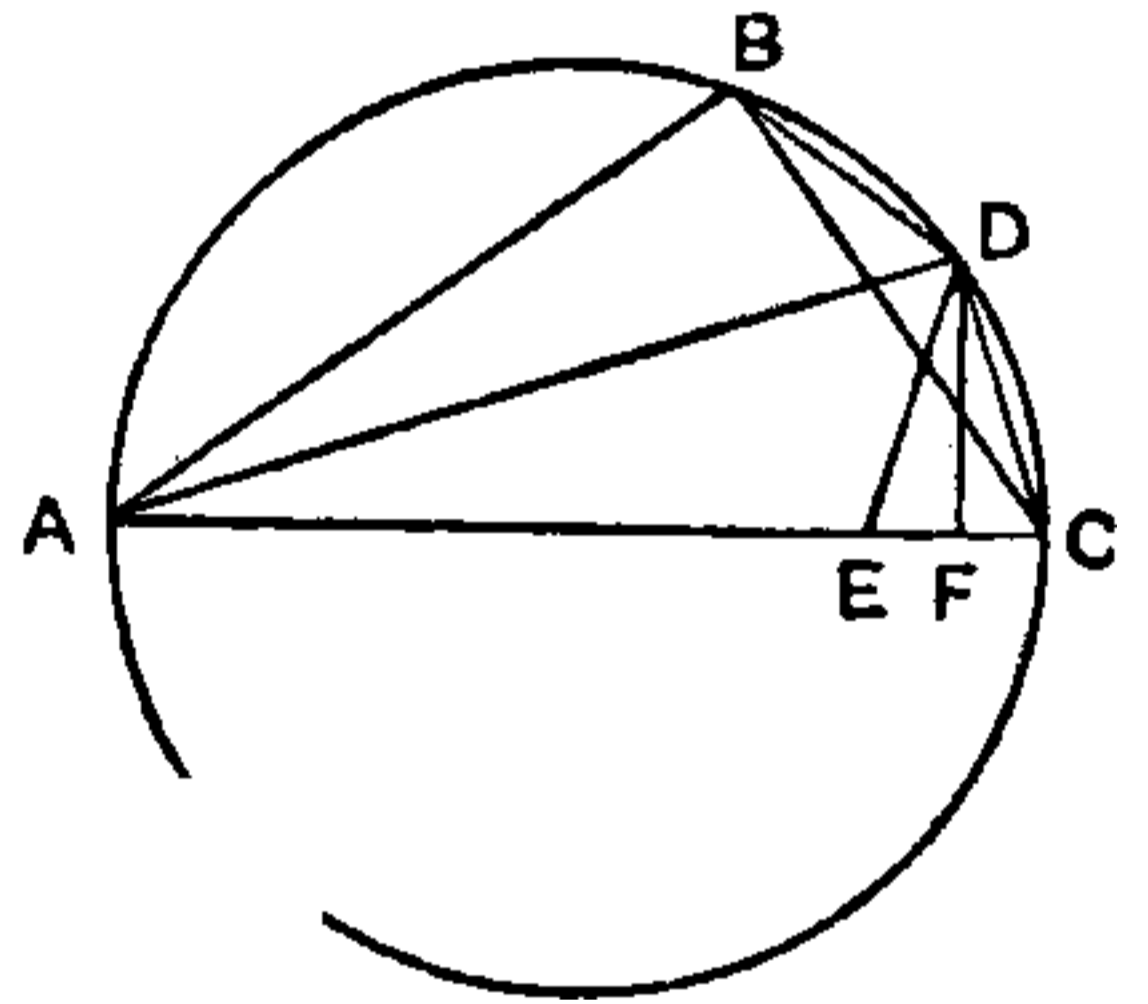

$$\text{Therefore} \quad ED = BD = DC,$$

and the right-angled triangles DEF, DCF are equal in all respects, whence $EF = FC$, or $CF = \frac{1}{2}(AC - AB)$.

$$\text{Now} \quad AC \cdot CF = CD^2,$$

$$\text{whence } (\text{crd. } CD)^2 = \frac{1}{2} AC (AC - AB)$$

$$= \frac{1}{2} (\text{crd. } 180^\circ) \cdot \{(\text{crd. } 180^\circ) - (\text{crd. } 180^\circ - BC)\}.$$

This is, of course, equivalent to the formula

$$\sin^2 \frac{1}{2} \theta = \frac{1}{2} (1 - \cos \theta).$$

By successively applying this formula, Ptolemy obtained (crd. 6°), (crd. 3°) and finally (crd. $1\frac{1}{2}^\circ = 1^p 34' 15''$ and (crd. $\frac{3}{4}^\circ = 0^p 47' 8''$). But we want a table going by half-degrees, and hence two more things are necessary; we have to get a value for (crd. 1°) lying between (crd. $1\frac{1}{2}^\circ$) and (crd. $\frac{3}{4}^\circ$), and we have to obtain an *addition* formula enabling us when (crd. α) is given to find {crd. $(\alpha + \frac{1}{2}^\circ)$ }, and so on.

(ϵ) *Equivalent of* $\cos(\theta + \phi) = \cos\theta \cos\phi - \sin\theta \sin\phi$.

To find the addition formula. Suppose AD is the diameter of a circle, and AB, BC two arcs. Given (crd. AB) and (crd. BC), to find (crd. AC). Draw the diameter BOE , and join CE, CD, DE, BD .

Now, (crd. AB) being known, (crd. BD) is known, and therefore also (crd. DE), which is equal to (crd. AB); and, (crd. BC) being known, (crd. CE) is known.

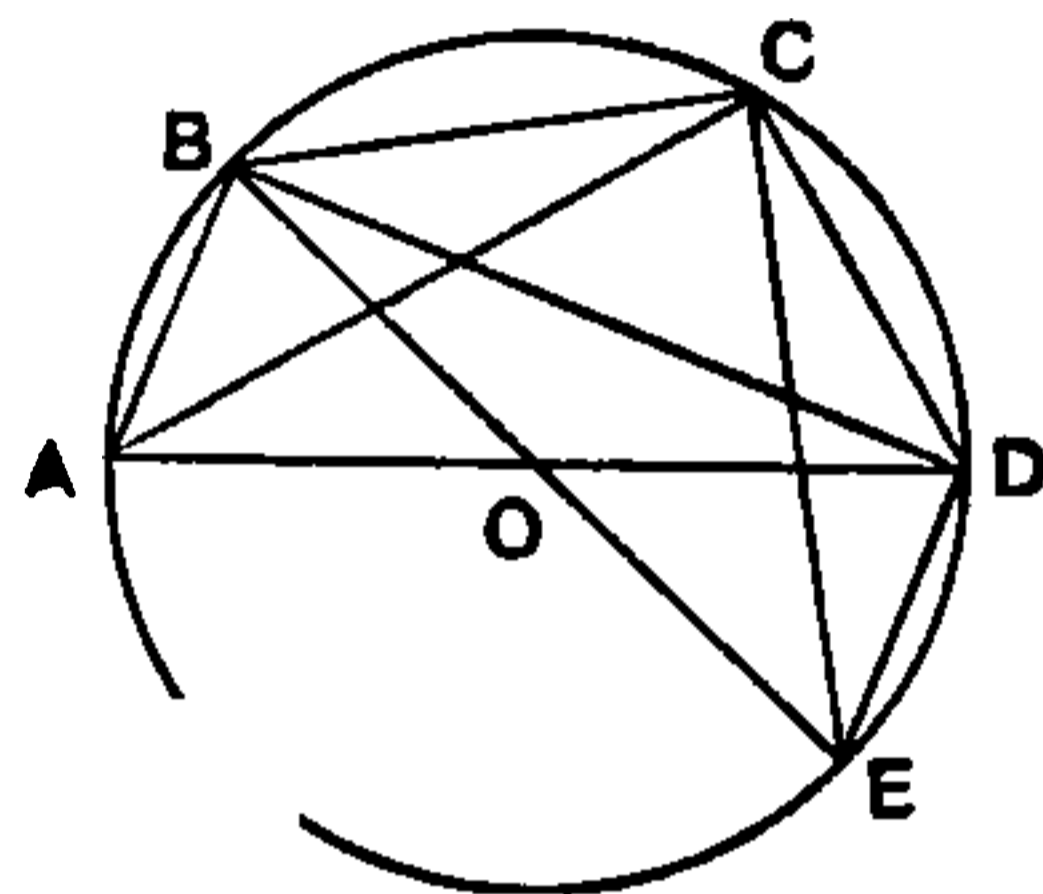

And, by Ptolemy's theorem,

$$BD \cdot CE = BC \cdot DE + BE \cdot CD.$$

The diameter BE and all the chords in this equation except CD being given, we can find CD or crd. $(180^\circ - AC)$. We have in fact

$$\begin{aligned} &(\text{crd. } 180^\circ) \cdot \{\text{crd. } (180^\circ - AC)\} \\ &= \{\text{crd. } (180^\circ - AB)\} \cdot \{\text{crd. } (180^\circ - BC)\} - (\text{crd. } AB) \cdot (\text{crd. } BC); \end{aligned}$$

thus crd. $(180^\circ - AC)$ and therefore (crd. AC) is known.

If $AB = 2\theta, BC = 2\phi$, the result is equivalent to

$$\cos(\theta + \phi) = \cos\theta \cos\phi - \sin\theta \sin\phi.$$

(ζ) *Method of interpolation based on formula*

$$\sin\alpha / \sin\beta < \alpha / \beta \text{ (where } \frac{1}{2}\pi > \alpha > \beta).$$

Lastly we have to find (crd. 1°), having given (crd. $1\frac{1}{2}^\circ$) and (crd. $\frac{3}{4}^\circ$).

Ptolemy uses an ingenious method of *interpolation* based on a proposition already assumed as known by Aristarchus.

If AB, BC be unequal chords in a circle, BC being the



THIS PAGE IS LOCKED TO FREE MEMBERS

Purchase full membership to immediately unlock this page

FORGOTTEN BOOKS

FULL

MEMBERSHIP

797,885 Books!

All you can read

for only

\$8.99/month

Continue

*Fair usage policy applies



(η) Table of Chords.

From this Ptolemy deduces that $(\text{crd. } \frac{1}{2}^\circ)$ is very nearly $0^p 31' 25''$, and by the aid of the above propositions he is in a position to complete his Table of Chords for arcs subtending angles increasing from $\frac{1}{2}^\circ$ to 180° by steps of $\frac{1}{2}^\circ$; in other words, a Table of Sines for angles from $\frac{1}{4}^\circ$ to 90° by steps of $\frac{1}{4}^\circ$.

(θ) Further use of proportional increase.

Ptolemy carries further the principle of proportional increase as a method of finding approximately the chords of arcs containing an odd number of minutes between $0'$ and $30'$. Opposite each chord in the Table he enters in a third column $\frac{1}{30}$ th of the excess of that chord over the one before, i.e. the chord of the arc containing $30'$ less than the chord in question. For example $(\text{crd. } 2\frac{1}{2}^\circ)$ is stated in the second column of the Table as $2^p 37' 4''$. The excess of $(\text{crd. } 2\frac{1}{2}^\circ)$ over $(\text{crd. } 2^\circ)$ in the Table is $0^p 31' 24''$; $\frac{1}{30}$ th of this is $0^p 1' 2'' 48'''$, which is therefore the amount entered in the third column opposite $(\text{crd. } 2\frac{1}{2}^\circ)$. Accordingly, if we want $(\text{crd. } 2^\circ 25')$, we take $(\text{crd. } 2^\circ)$ or $2^p 5' 40''$ and add 25 times $0^p 1' 2'' 48'''$; or we take $(\text{crd. } 2\frac{1}{2}^\circ)$ or $2^p 37' 4''$ and subtract 5 times $0^p 1' 2'' 48'''$. Ptolemy adds that if, by using the approximation for 1° and $\frac{1}{2}^\circ$, we gradually accumulate an error, we can check the calculation by comparing the chord with that of other related arcs, e.g. the double, or the supplement (the difference between the arc and the semicircle).

Some particular results obtained from the Table may be mentioned. Since $(\text{crd. } 1^\circ) = 1^p 2' 50''$, the whole circumference = $360 (1^p 2' 50'')$, nearly, and, the length of the diameter being 120^p , the value of π is $3 (1 + \frac{2}{60} + \frac{50}{3600}) = 3 + \frac{8}{60} + \frac{30}{3600}$, which is the value used later by Ptolemy and is equivalent to $3.14166\dots$ Again, $\sqrt{3} = 2 \sin 60^\circ$ and, $2 (\text{crd. } 120^\circ)$ being equal to $2 (103^p 55' 23'')$, we have $\sqrt{3} = \frac{2}{120} (103 + \frac{55}{60} + \frac{23}{3600})$

$$= 1 + \frac{43}{60} + \frac{55}{60^2} + \frac{23}{60^3} = 1.7320509,$$

which is correct to 6 places of decimals. Speaking generally,

the sines obtained from Ptolemy's Table are correct to 5 places.

(i) *Plane trigonometry in effect used.*

There are other cases in Ptolemy in which plane trigonometry is in effect used, e.g. in the determination of the eccentricity of the sun's orbit.¹ Suppose that $ACBD$ is the eccentric circle with centre O , and AB , CD are chords at right angles through E , the centre of the earth. To find OE . The arc BC is known ($= \alpha$, say) as also the arc CA ($= \beta$). If BF be the chord parallel to CD , and CG the chord parallel to AB , and if N , P be the middle points of the arcs BF , GC , Ptolemy finds (1) the arc BF ($= \alpha + \beta - 180^\circ$), then the chord BF , $\text{crd.}(\alpha + \beta - 180^\circ)$, then the half of it, (2) the arc GC $= \text{arc}(\alpha + \beta - 2\beta)$ or $\text{arc}(\alpha - \beta)$, then the chord GC , and lastly half of it. He then adds the squares on the half-chords, i.e. he obtains

$$OE^2 = \frac{1}{4} \{ \text{crd.}(\alpha + \beta - 180) \}^2 + \frac{1}{4} \{ \text{crd.}(\alpha - \beta) \}^2,$$

that is, $OE^2/r^2 = \cos^2 \frac{1}{2}(\alpha + \beta) + \sin^2 \frac{1}{2}(\alpha - \beta)$.

He proceeds to obtain the angle OEC from its sine OR/OE , which he expresses as a chord of double the angle in the circle on OE as diameter in relation to that diameter.

Spherical trigonometry: formulae in solution of spherical triangles.

In spherical trigonometry, as already stated, Ptolemy obtains everything that he wants by using the one fundamental proposition known as 'Menelaus's theorem' applied to the sphere (Menelaus III. 1), of which he gives a proof following that given by Menelaus of the first case taken in his proposition. Where Ptolemy has occasion for other propositions of Menelaus's *Sphaerica*, e.g. III. 2 and 3, he does

¹ Ptolemy, *Syntaxis*, iii. 4, vol. i, pp. 234-7.

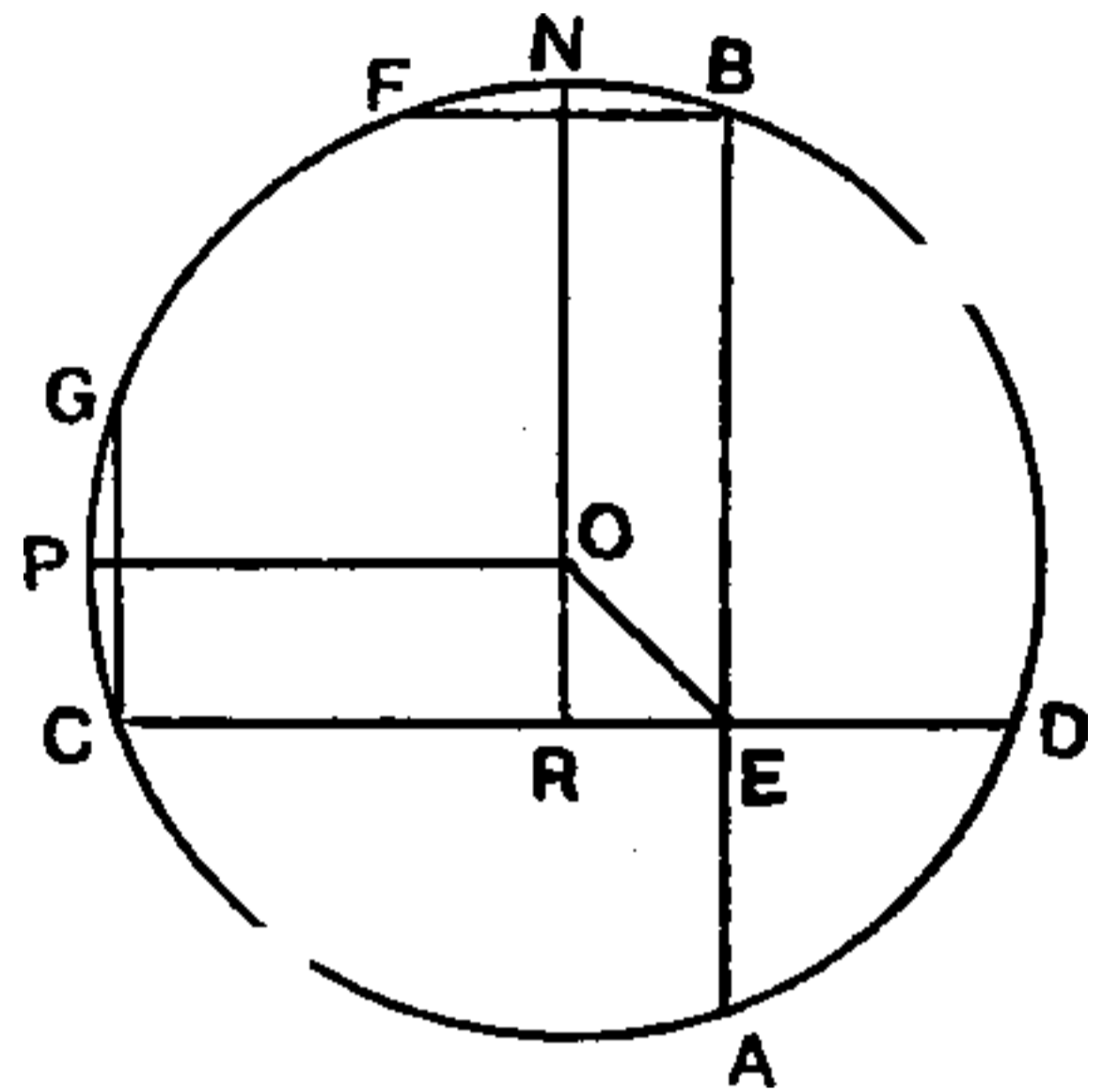

not quote those propositions, as he might have done, but proves them afresh by means of Menelaus's theorem.¹ The application of the theorem in other cases gives in effect the following different formulae belonging to the solution of a spherical triangle ABC right-angled at C , viz.

$$\begin{aligned} \sin a &= \sin c \sin A, \\ \tan a &= \sin b \tan A, \\ \cos c &= \cos a \cos b, \\ \tan b &= \tan c \cos A. \end{aligned}$$

One illustration of Ptolemy's procedure will be sufficient.² Let HAH' be the horizon, $PEZH$ the meridian circle, EE' the equator, ZZ' the ecliptic, F an equinoctial point. Let EE' , ZZ' cut the horizon in A , B . Let P be the pole, and let the great circle through P , B cut the equator at C . Now let it be required to find the time which the arc FB of the ecliptic takes to rise; this time will be measured by the arc FA of the equator. (Ptolemy has previously found the length of the arcs BC , the declination, and FC , the right ascension, of B , I. 14, 16.)

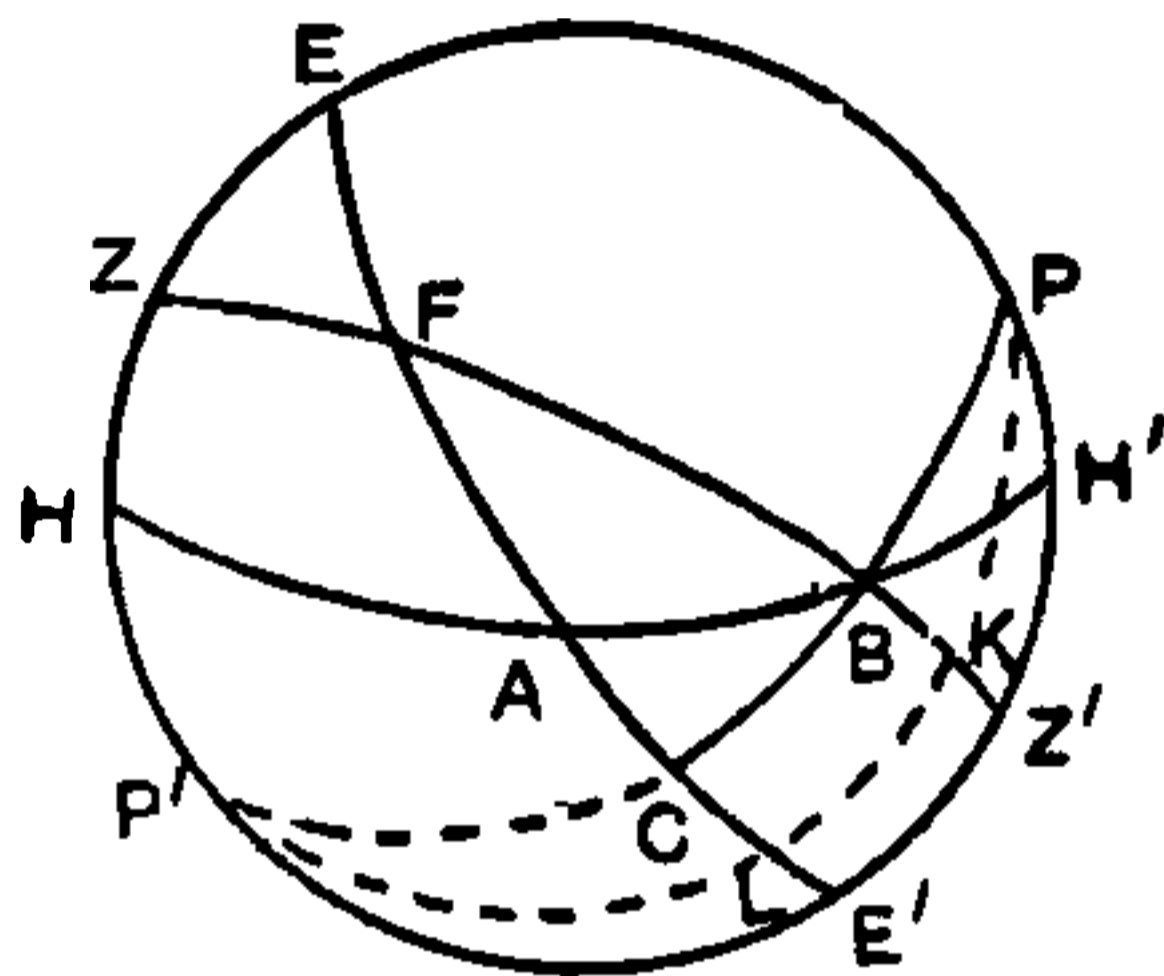

By Menelaus's theorem applied to the arcs AE' , $E'P$ cut by the arcs AH' , PC which also intersect one another in B ,

$$\frac{\text{crd. } 2PH'}{\text{crd. } 2H'E'} = \frac{\text{crd. } 2PB}{\text{crd. } 2BC} \cdot \frac{\text{crd. } 2CA}{\text{crd. } 2AE'};$$

that is,
$$\frac{\sin PH'}{\sin H'E'} = \frac{\sin PB}{\sin BC} \cdot \frac{\sin CA}{\sin AE'}.$$

Now $\sin PH' = \cos H'E'$, $\sin PB = \cos BC$, and $\sin AE' = 1$; therefore
$$\cot H'E' = \cot BC \cdot \sin CA,$$

in other words, in the triangle ABC right-angled at C ,

$$\cot A = \cot a \sin b,$$

or
$$\tan a = \sin b \tan A.$$

¹ *Syntaxis*, vol. i, p. 169 and pp. 126-7 respectively.

² *Ib.*, vol. i, pp. 121-2.



THIS PAGE IS LOCKED TO FREE MEMBERS

Purchase full membership to immediately unlock this page

DELVE INTO FANTASY, MAGIC, MYTHOLOGY & FOLKLORE

Forgotten Books'
Full Membership gives
access to 797,885 ancient
and modern, fiction and
non-fiction books.

Continue

*Fair usage policy applies

and arcs of the heavenly sphere by means of *orthogonal projection* upon three planes mutually at right angles, the meridian, the horizon, and the 'prime vertical'. The definite problem attacked is that of showing the position of the sun at any given time of the day, and the use of the method and of the instruments described in the book by Ptolemy was connected with the construction of sundials, as we learn from Vitruvius.¹ There was another *ἀνάλημμα* besides that of Ptolemy; the author of it was Diodorus of Alexandria, a contemporary of Caesar and Cicero ('Diodorus, famed among the makers of gnomons, tell me the time!' says the Anthology²), and Pappus wrote a commentary upon it in which, as he tells us,³ he used the conchoid in order to trisect an angle, a problem evidently required in the *Analemma* in order to divide any arc of a circle into six equal parts (hours). The word *ἀνάλημμα* evidently means 'taking up' ('Aufnahme') in the sense of 'making a graphic representation' of something, in this case the representation on a plane of parts of the heavenly sphere. Only a few fragments remain of the Greek text of the *Analemma* of Ptolemy; these are contained in a palimpsest (Ambros. Gr. L. 99 sup., now 491) attributed to the seventh century but probably earlier. Besides this, we have a translation by William of Moerbeke from an Arabic version. This Latin translation was edited with a valuable commentary by the indefatigable Commandinus (Rome, 1562); but it is now available in William of Moerbeke's own words, Heiberg having edited it from Cod. Vaticanus Ottobon. lat. 1850 of the thirteenth century (written in William's own hand), and included it with the Greek fragments (so far as they exist) in parallel columns in vol. ii of Ptolemy's works (Teubner, 1907).

The figure is referred to three fixed planes (1) the meridian, (2) the horizon, (3) the prime vertical; these planes are the planes of the three circles $APZB$, ACB , ZQC respectively shown in the diagram below. Three other great circles are used, one of which, the equator with pole P , is fixed; the other two are movable and were called by special names; the first is the circle represented by any position of the circle of the horizon as it revolves round $CO'C'$ as diameter (CSM in

¹ Vitruvius, *De architect.* ix. 4.

² *Anth. Palat.* xiv. 139.

³ Pappus, iv, p. 246. 1.

the diagram is one position of it, coinciding with the equator), and it was called *ἐκτῆμορος κύκλος* ('the circle in six parts') because the highest point of it above the horizon corresponds to the lapse of six hours; the second, called the *hour-circle*, is the circle represented by any position, as $BSQA$, of the circle of the horizon as it revolves round BA as axis.

The problem is, as above stated, to find the position of the sun at a given hour of the day. In order to illustrate the method, it is sufficient, with A. v. Braunmühl,¹ to take the simplest case where the sun is on the equator, i.e. at one of the equinoctial points, so that the *hctemoron* circle coincides with the equator.

Let S be the position of the sun, lying on the equator MSC , P the pole, MZA the meridian, BCA the horizon, $BSQA$ the *hour-circle*, and let the vertical great circle ZSV be drawn through S , and the vertical great circle ZQC through Z the zenith and C the east-point.

We are given the arc $SC' = 90^\circ - t$, where t is the hour-angle, and the arc $MB = 90^\circ - \phi$, where ϕ is the elevation of the pole; and we have to find the arcs SV (the sun's altitude),

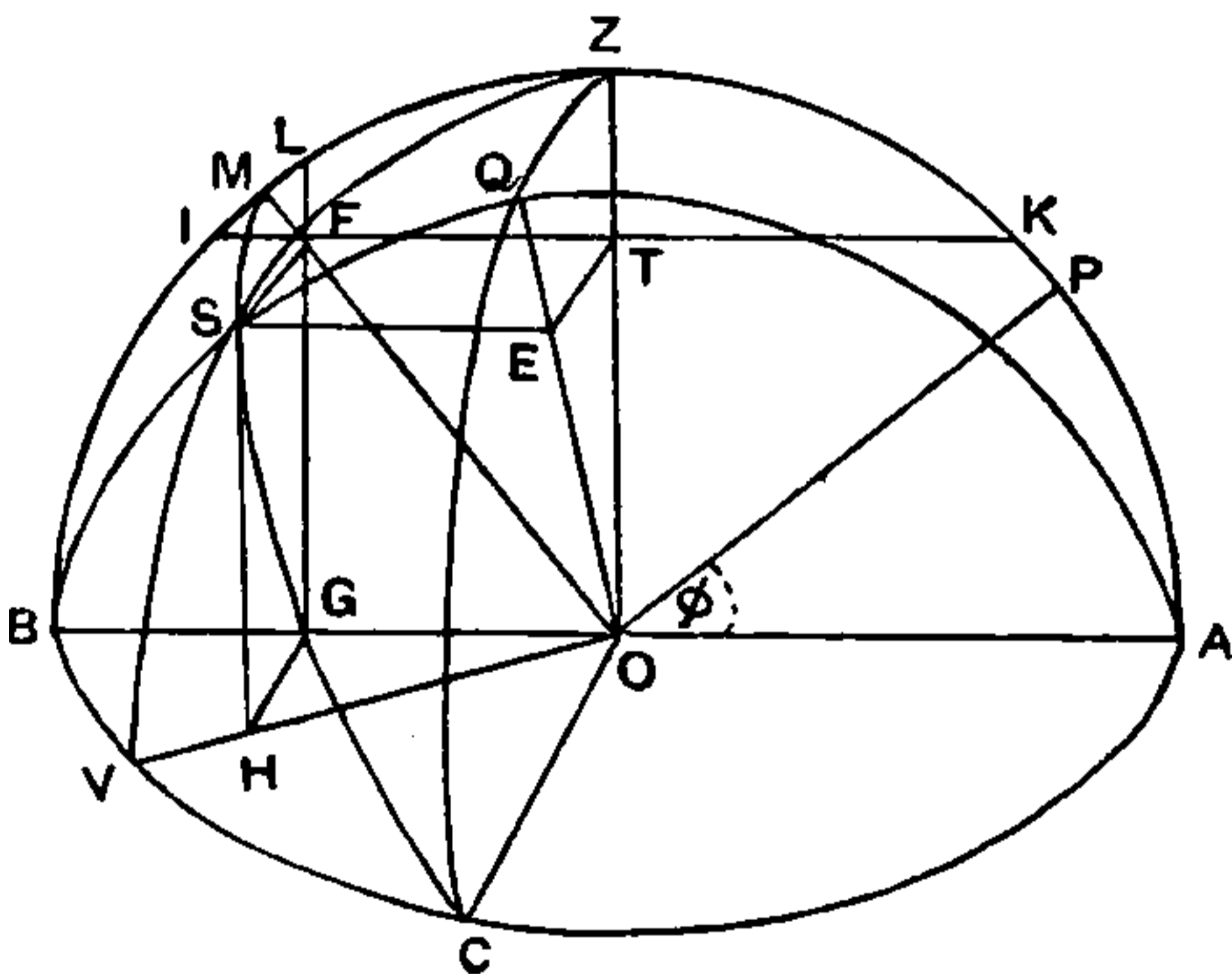

VC , the 'ascensional difference', SQ and QC . Ptolemy, in fact, practically determines the position of S in terms of certain spherical coordinates.

Draw the perpendiculars, SF to the plane of the meridian, SH to that of the horizon, and SE to the plane of the prime

¹ Braunmühl, *Gesch. der Trigonometrie*, i, pp. 12, 13.



THIS PAGE IS LOCKED TO FREE MEMBERS

Purchase full membership to immediately unlock this page

FORGOTTEN BOOKS

FULL

MEMBERSHIP

797,885 Books!

All you can read

for only

\$8.99/month

Continue

*Fair usage policy applies



or $\tan VC = \tan SC \cos SCV$ in the right-angled spherical triangle SVC .

Thirdly,

$$\tan QZ = \tan Z'Y' = \frac{S'F'}{O'T'} = \frac{S'F'}{O'F'} \cdot \frac{O'F'}{O'T'} = \tan t \cdot \frac{1}{\cos \phi};$$

that is, $\frac{\tan QZ}{\tan SM} = \frac{\sin BZ}{\sin BM}$, which is Menelaus, *Sphaerica*, III. 3, applied to the right-angled spherical triangles ZBQ , MBS with the angle B common.

Zeuthen points out that later in the same treatise Ptolemy finds the arc 2α described above the horizon by a star of given declination δ' , by a procedure equivalent to the formula

$$\cos \alpha = \tan \delta' \tan \phi,$$

and this is the same formula which, as we have seen, Hipparchus must in effect have used in his *Commentary on the Phaenomena of Eudoxus and Aratus*.

Lastly, with regard to the calculations of the height h and the azimuth ω in the general case where the sun's declination is δ' , Zeuthen has shown that they may be expressed by the formulae

$$\sin h = (\cos \delta' \cos t - \sin \delta' \tan \phi) \cos \phi,$$

and
$$\tan \omega = \frac{\cos \delta' \sin t}{\frac{\sin \delta'}{\cos \phi} + (\cos \delta' \cos t - \sin \delta' \tan \phi) \sin \phi},$$

or
$$\frac{\cos \delta' \sin t}{\sin \delta' \cos \phi + \cos \delta' \cos t \sin \phi}.$$

The statement therefore of A. v. Braunmühl¹ that the Indians were the first to utilize the method of projection contained in the *Analemma* for actual trigonometrical calculations with the help of the Table of Chords or Sines requires modification in so far as the Greeks at all events showed the way to such use of the figure. Whether the practical application of the method of the *Analemma* for what is equivalent to the solution of spherical triangles goes back as far as Hipparchus is not certain; but it is quite likely that it does,

¹ Braunmühl, i, pp. 13, 14, 38-41.

seeing that Diodorus wrote his *Analemma* in the next century. The other alternative source for Hipparchus's spherical trigonometry is the Menelaus-theorem applied to the sphere, on which alone Ptolemy, as we have seen, relies in his *Syntaxis*. In any case the Table of Chords or Sines was in full use in Hipparchus's works, for it is presupposed by either method.

The *Planisphaerium*.

With the *Analemma* of Ptolemy is associated another work of somewhat similar content, the *Planisphaerium*. This again has only survived in a Latin translation from an Arabic version made by one Maslama b. Ahmad al-Majrīṭī, of Cordova (born probably at Madrid, died 1007/8); the translation is now found to be, not by Rudolph of Bruges, but by 'Hermannus Secundus', whose pupil Rudolph was; it was first published at Basel in 1536, and again edited, with commentary, by Commandinus (Venice, 1558). It has been re-edited from the manuscripts by Heiberg in vol. ii. of his text of Ptolemy. The book is an explanation of the system of projection known as *stereographic*, by which points on the heavenly sphere are represented on the plane of the equator by projection from one point, a pole; Ptolemy naturally takes the south pole as centre of projection, as it is the northern hemisphere which he is concerned to represent on a plane. Ptolemy is aware that the projections of all circles on the sphere (great circles—other than those through the poles which project into straight lines—and small circles either parallel or not parallel to the equator) are likewise circles. It is curious, however, that he does not give any general proof of the fact, but is content to prove it of particular circles, such as the ecliptic, the horizon, &c. This is remarkable, because it is easy to show that, if a cone be described with the pole as vertex and passing through any circle on the sphere, i.e. a circular cone, in general oblique, with that circle as base, the section of the cone by the plane of the equator satisfies the criterion found for the 'subcontrary sections' by Apollonius at the beginning of his *Conics*, and is therefore a circle. The fact that the method of stereographic projection is so easily connected with the property of subcontrary sections

of oblique circular cones has led to the conjecture that Apollonius was the discoverer of the method. But Ptolemy makes no mention of Apollonius, and all that we know is that Synesius of Cyrene (a pupil of Hypatia, and born about A.D. 365–370) attributes the discovery of the method and its application to Hipparchus; it is curious that he does not mention Ptolemy's treatise on the subject, but speaks of himself alone as having perfected the theory. While Ptolemy is fully aware that circles on the sphere become circles in the projection, he says nothing about the other characteristic of this method of projection, namely that the angles on the sphere are represented by equal angles on the projection.

We must content ourselves with the shortest allusion to other works of Ptolemy. There are, in the first place, other minor astronomical works as follows:

(1) *Φάσεις ἀπλανῶν ἀστέρων* of which only Book II survives, (2) *ὑποθέσεις τῶν πλανωμένων* in two Books, the first of which is extant in Greek, the second in Arabic only, (3) the inscription in Canopus, (4) *Προχείρων κανόνων διάτασις καὶ ψηφοφορία*. All these are included in Heiberg's edition, vol. ii.

The *Optics*.

Ptolemy wrote an *Optics* in five Books, which was translated from an Arabic version into Latin in the twelfth century by a certain Admiral Eugenius Siculus¹; Book I, however, and the end of Book V are wanting. Books I, II were physical, and dealt with generalities; in Book III Ptolemy takes up the theory of mirrors, Book IV deals with concave and composite mirrors, and Book V with refraction. The theoretical portion would suggest that the author was not very proficient in geometry. Many questions are solved incorrectly owing to the assumption of a principle which is clearly false, namely that 'the image of a point on a mirror is at the point of concurrence of two lines, one of which is drawn from the luminous point to the centre of curvature of the mirror, while the other is the line from the eye to the point

¹ See G. Govi, *L'ottica di Claudio Tolomeo di Eugenio Ammiraglio di Sicilia*, ... Torino, 1884; and particulars in G. Loria, *Le scienze esatte nell' antica Grecia*, pp. 570, 571.



THIS PAGE IS LOCKED TO FREE MEMBERS

Purchase full membership to immediately unlock this page

DELVE INTO FANTASY, MAGIC, MYTHOLOGY & FOLKLORE

Forgotten Books'
Full Membership gives
access to 797,885 ancient
and modern, fiction and
non-fiction books.

Continue

*Fair usage policy applies

but the translation into Latin (now included in the Teubner edition of Heron, ii, 1900, pp. 316–64), which was made by William of Moerbeke in 1269, was evidently made from the Greek and not from the Arabic, as is shown by Graecisms in the translation.

A mechanical work, *Περὶ ῥοπῶν*.

There are allusions in Simplicius¹ and elsewhere to a book by Ptolemy of mechanical content, *περὶ ῥοπῶν*, on balancings or turnings of the scale, in which Ptolemy maintained as against Aristotle that air or water (e.g.) in their own 'place' have no weight, and, when they are in their own 'place', either remain at rest or rotate simply, the tendency to go up or to fall down being due to the desire of things which are not in their own places to move to them. Ptolemy went so far as to maintain that a bottle full of air was not only not heavier than the same bottle empty (as Aristotle held), but actually lighter when inflated than when empty. The same work is apparently meant by the 'book on the elements' mentioned by Simplicius.² Suidas attributes to Ptolemy three Books of *Mechanica*.

Simplicius³ also mentions a single book, *περὶ διαστάσεως*, 'On dimension', i.e. dimensions, in which Ptolemy tried to show that the possible number of dimensions is limited to three.

Attempt to prove the Parallel-Postulate.

Nor should we omit to notice Ptolemy's attempt to prove the Parallel-Postulate. Ptolemy devoted a tract to this subject, and Proclus⁴ has given us the essentials of the argument used. Ptolemy gives, first, a proof of Eucl. I. 28, and then an attempted proof of I. 29, from which he deduces Postulate 5.

¹ Simplicius on Arist. *De caelo*, p. 710. 14, Heib. (Ptolemy, ed. Heib., vol. ii, p. 263).

² *Ib.*, p. 20. 10 sq.

³ *Ib.*, p. 9. 21 sq., (Ptolemy, ed. Heib., vol. ii, p. 265).

⁴ Proclus on Eucl. I, pp. 362. 14 sq., 365. 7–367. 27 (Ptolemy, ed. Heib., vol. ii, pp. 266–70).

I. To prove I. 28, Ptolemy takes two straight lines AB , CD , and a transversal $EFGH$. We have to prove that, if the sum

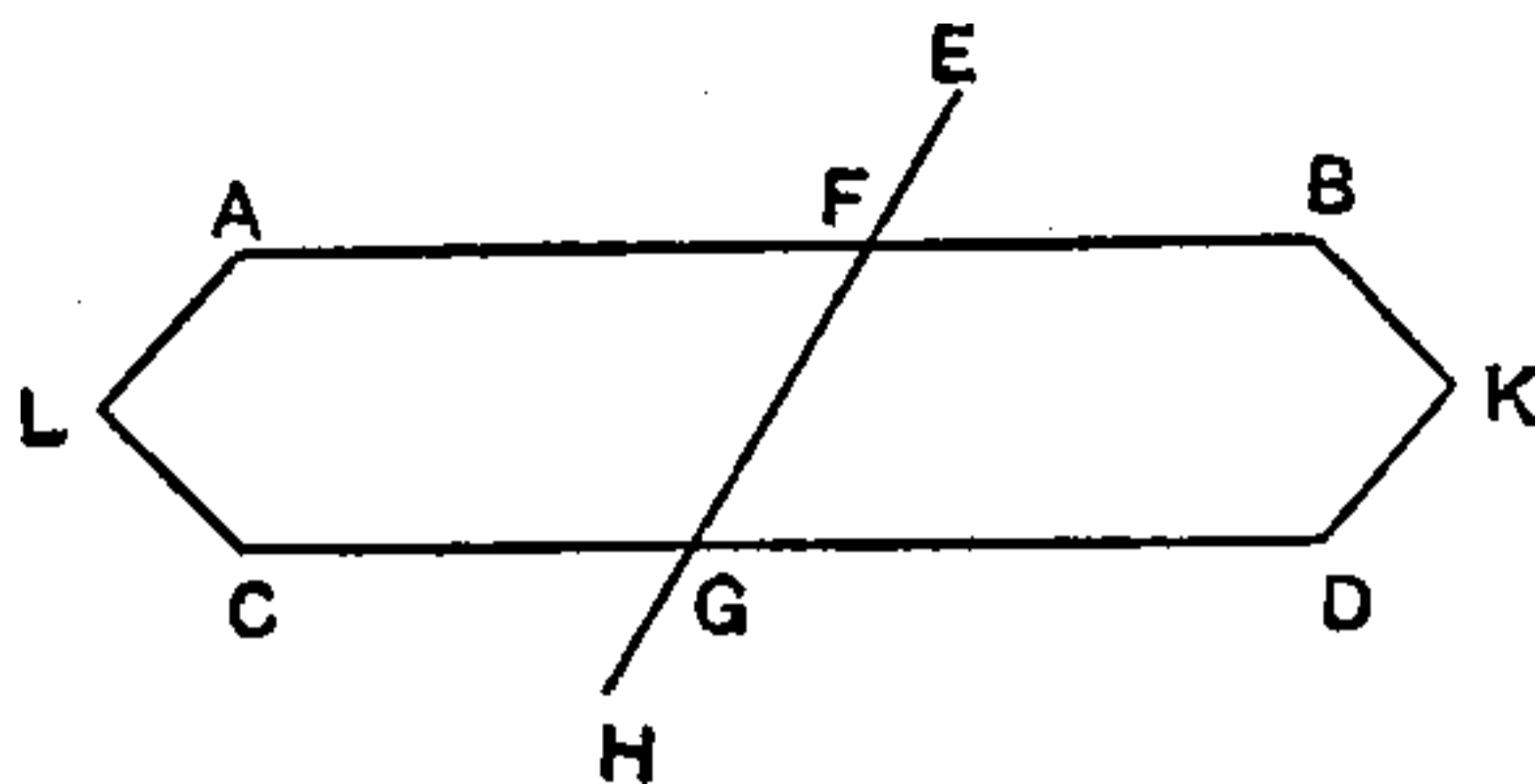

of the angles BFG , FGD is equal to two right angles, the straight lines AB , CD are parallel, i.e. non-secant.

Since AFG is the supplement of BFG , and FGC of FGD , it follows that the sum of the angles AFG , FGC is also equal to two right angles.

Now suppose, if possible, that FB , GD , making the sum of the angles BFG , FGD equal to two right angles, meet at K ; then similarly FA , GC making the sum of the angles AFG , FGC equal to two right angles must also meet, say at L .

[Ptolemy would have done better to point out that not only are the two sums equal but the angles themselves are equal in pairs, i.e. AFG to FGD and FGC to BFG , and we can therefore take the triangle KFG and apply it to FG on the other side so that the sides FK , GK may lie along GC , FA respectively, in which case GC , FA will meet at the point where K falls.]

Consequently the straight lines $LABK$, $LCDK$ enclose a space: which is impossible.

It follows that AB , CD cannot meet in either direction; they are therefore parallel.

II. To prove I. 29, Ptolemy takes two parallel lines AB , CD and the transversal FG , and argues thus. It is required to prove that $\angle AFG + \angle CGF =$ two right angles.

For, if the sum is not equal to two right angles, it must be either (1) greater or (2) less.

(1) If it is greater, the sum of the angles on the other side, BFG , FGD , which are the supplements of the first pair of angles, must be less than two right angles.

But AF , CG are no more parallel than FB , GD , so that, if FG makes one pair of angles AFG , FGC together greater than

two right angles, it must also make the other pair BFG , FGD together greater than two right angles.

But the latter pair of angles were proved less than two right angles: which is impossible.

Therefore the sum of the angles AFG , FGC cannot be greater than two right angles.

(2) Similarly we can show that the sum of the two angles AFG , FGC cannot be less than two right angles.

Therefore $\angle AFG + \angle CGF =$ two right angles.

[The fallacy here lies in the inference which I have marked by italics. When Ptolemy says that AF , CG are no more parallel than FB , GD , he is in effect assuming that *through any one point only one parallel can be drawn to a given straight line*, which is an equivalent for the very Postulate he is endeavouring to prove. The alternative Postulate is known as 'Playfair's axiom', but it is of ancient origin, since it is distinctly enunciated in Proclus's note on Eucl. I. 31.]

III. Post. 5 is now deduced, thus.

Suppose that the straight lines making with a transversal angles the sum of which is less than two right angles do not meet on the side on which those angles are.

Then, *a fortiori*, they will not meet on the other side on which are the angles the sum of which is greater than two right angles. [This is enforced by a supplementary proposition showing that, if the lines met on that side, Eucl. I. 16 would be contradicted.]

Hence the straight lines cannot meet in either direction: they are therefore *parallel*.

But in that case the angles made with the transversal are equal to two right angles: which contradicts the assumption.

Therefore the straight lines will meet.



THIS PAGE IS LOCKED TO FREE MEMBERS

Purchase full membership to immediately unlock this page

FORGOTTEN BOOKS

FULL

MEMBERSHIP

797,885 Books!

All you can read

for only

\$8.99/month

Continue

*Fair usage policy applies



above quoted; the title, however, in itself need not imply more than that Heron's work was a new edition of a similar work by Ctesibius, and the *Κτησιβίου* may even have been added by some well-read editor who knew both works and desired to indicate that the greater part of the contents of Heron's work was due to Ctesibius. One manuscript has "*Ἡρωνος Ἀλεξανδρέως Βελοποιικά*", which corresponds to the titles of the other works of Heron and is therefore more likely to be genuine.

The discovery of the Greek text of the *Metrica* by R. Schöne in 1896 made it possible to fix with certainty an upper limit. In that work there are a number of allusions to Archimedes, three references to the *χωρίου ἀποτομή* of Apollonius, and two to 'the (books) about straight lines (chords) in a circle' (*δέδεικται δὲ ἐν τοῖς περὶ τῶν ἐν κύκλῳ εὐθειῶν*). Now, although the first beginnings of trigonometry may go back as far as Apollonius, we know of no work giving an actual Table of Chords earlier than that of Hipparchus. We get, therefore, at once the date 150 B.C. or thereabouts as the *terminus post quem*. A *terminus ante quem* is furnished by the date of the composition of Pappus's *Collection*; for Pappus alludes to, and draws upon, the works of Heron. As Pappus was writing in the reign of Diocletian (A.D. 284–305), it follows that Heron could not be much later than, say, A.D. 250. In speaking of the solutions by 'the old geometers' (*οἱ παλαιοὶ γεωμέτραι*) of the problem of finding the two mean proportionals, Pappus may seem at first sight to include Heron along with Eratosthenes, Nicomedes and Philon in that designation, and it has been argued, on this basis, that Heron lived long before Pappus. But a close examination of the passage¹ shows that this is by no means necessary. The relevant words are as follows:

'The ancient geometers were not able to solve the problem of the two straight lines [the problem of finding two mean proportionals to them] by ordinary geometrical methods, since the problem is by nature "solid" . . . but by attacking it with mechanical means they managed, in a wonderful way, to reduce the question to a practical and convenient construction, as may be seen in the *Mesolabon* of Eratosthenes and in the mechanics of Philon and Heron . . . Nicomedes also solved it by means of the cochloid curve, with which he also trisected an angle.'

¹ Pappus, iii, pp. 54-6.

Pappus goes on to say that he will give four solutions, one of which is his own; the first, second, and third he describes as those of Eratosthenes, Nicomedes and Heron. But in the earlier sentence he mentions Philon along with Heron, and we know from Eutocius that Heron's solution is practically the same as Philon's. Hence we may conclude that by the third solution Pappus really meant Philon's, and that he only mentioned Heron's *Mechanics* because it was a convenient place in which to find the same solution.

Another argument has been based on the fact that the extracts from Heron's *Mechanics* given at the end of Pappus's Book VIII, as we have it, are introduced by the author with a complaint that the copies of Heron's works in which he found them were in many respects corrupt, having lost both beginning and end.¹ But the extracts appear to have been added, not by Pappus, but by some later writer, and the argument accordingly falls to the ground.

The limits of date being then, say, 150 B.C. to A.D. 250, our only course is to try to define, as well as possible, the relation in time between Heron and the other mathematicians who come, roughly, within the same limits. This method has led one of the most recent writers on the subject (Tittel²) to place Heron not much later than 100 B.C., while another,³ relying almost entirely on a comparison between passages in Ptolemy and Heron, arrives at the very different conclusion that Heron was later than Ptolemy and belonged in fact to the second century A.D.

In view of the difference between these results, it will be convenient to summarize the evidence relied on to establish the earlier date, and to consider how far it is or is not conclusive against the later. We begin with the relation of Heron to Philon. Philon is supposed to come not more than a generation later than Ctesibius, because it would appear that machines for throwing projectiles constructed by Ctesibius and Philon respectively were both available at one time for inspection by experts on the subject⁴; it is inferred that

¹ Pappus, viii, p. 1116. 4-7.

² Art. 'Heron von Alexandria' in Pauly-Wissowa's *Real-Encyclopädie der class. Altertumswissenschaft*, vol. 8. 1, 1912.

³ I. Hammer-Jensen in *Hermes*, vol. 48, 1913, pp. 224-35.

⁴ Philon, *Mech. Synt.* iv, pp. 68. 1, 72. 36.

Philon's date cannot be later than the end of the second century B.C. (If Ctesibius flourished before 247 B.C. the argument would apparently suggest rather the beginning than the end of the second century.) Next, Heron is supposed to have been a younger contemporary of Philon, the grounds being the following. (1) Heron mentions a 'stationary-automaton' representation by Philon of the Nauplius-story,¹ and this is identified by Tittel with a representation of the same story by some contemporary of Heron's (*οἱ καθ' ἡμᾶς*²). But a careful perusal of the whole passage seems to me rather to suggest that the latter representation was not Philon's, and that Philon was included by Heron among the 'ancient' automaton-makers, and not among his contemporaries.³ (2) Another argument adduced to show that Philon was contemporary

¹ Heron, *Autom.*, pp. 404. 11-408. 9.

² *Ib.*, p. 412. 13.

³ The relevant remarks of Heron are as follows. (1) He says that he has found no arrangements of 'stationary automata' better or more instructive than those described by Philon of Byzantium (p. 404. 11). As an instance he mentions Philon's setting of the Nauplius-story, in which he found everything good except two things (*a*) the mechanism for the appearance of Athene, which was too difficult (*ἐργωδέστερον*), and (*b*) the absence of an incident promised by Philon in his description, namely the falling of a thunderbolt on Ajax with a sound of thunder accompanying it (pp. 404. 15-408. 9). This latter incident Heron could not find anywhere in Philon, though he had consulted a great number of copies of his work. He continues (p. 408. 9-13) that we are not to suppose that he is running down Philon or charging him with not being capable of carrying out what he promised. On the contrary, the omission was probably due to a slip of memory, for it is easy enough to make stage-thunder (he proceeds to show how to do it). But the rest of Philon's arrangements seemed to him satisfactory, and this, he says, is why he has not ignored Philon's work: 'for I think that my readers will get the most benefit if they are shown, first what has been well said by the ancients and then, separately from this, what the ancients overlooked or what in their work needed improvement' (pp. 408. 22-410. 6). (2) The next chapter (pp. 410. 7-412. 2) explains generally the sort of thing the automaton-picture has to show, and Heron says he will give one example which he regards as the best. Then (3), after drawing a contrast between the simpler pictures made by 'the ancients', which involved three different movements only, and the contemporary (*οἱ καθ' ἡμᾶς*) representations of interesting stories by means of more numerous and varied movements (p. 412. 3-15), he proceeds to describe a setting of the Nauplius-story. This is the representation which Tittel identifies with Philon's. But it is to be observed that the description includes that of the episode of the thunderbolt striking Ajax (c. 30, pp. 448. 1-452. 7) which Heron expressly says that Philon omitted. Further, the mechanism for the appearance of Athene described in c. 29 is clearly not Philon's 'more difficult' arrangement, but the simpler device described (pp. 404. 18-408. 5) as possible and preferable to Philon's (cf. Heron, vol. i, ed. Schmidt, pp. lxxviii-lxxix).



THIS PAGE IS LOCKED TO FREE MEMBERS

Purchase full membership to immediately unlock this page

DELVE INTO FANTASY, MAGIC, MYTHOLOGY & FOLKLORE

Forgotten Books'
Full Membership gives
access to 797,885 ancient
and modern, fiction and
non-fiction books.

Continue

*Fair usage policy applies

machines used by the two for the same purpose frequently differ in details; e.g. in Vitruvius's hodometer a pebble drops into a box at the end of each Roman mile,¹ while in Heron's the distance completed is marked by a pointer.² It is indeed pointed out that the water-organ of Heron is in many respects more primitive than that of Vitruvius; but, as the instruments are altogether different, this can scarcely be said to prove anything.

On the other hand, there are points of contact between certain propositions of Heron and of the Roman *agrimensores*. Columella, about A.D. 62, gave certain measurements of plane figures which agree with the formulae used by Heron, notably those for the equilateral triangle, the regular hexagon (in this case not only the formula but the actual figures agree with Heron's) and the segment of a circle which is less than a semicircle, the formula in the last case being

$$\frac{1}{2}(s+h)h + \frac{1}{14}\left(\frac{1}{2}s\right)^2,$$

where s is the chord and h the height of the segment. Here there might seem to be dependence, one way or the other; but the possibility is not excluded that the two writers may merely have drawn from a common source; for Heron, in giving the formula for the area of the segment of a circle, states that it was the formula used by 'the more accurate investigators' (*οἱ ἀκριβέστερον ἐζητηκότες*).³

We have, lastly, to consider the relation between Ptolemy and Heron. If Heron lived about 100 B.C., he was 200 years earlier than Ptolemy (A.D. 100–178). The argument used to prove that Ptolemy came some time after Heron is based on a passage of Proclus where Ptolemy is said to have remarked on the untrustworthiness of the method in vogue among the 'more ancient' writers of measuring the apparent diameter of the sun by means of water-clocks.⁴ Hipparchus, says Proclus, used his dioptra for the purpose, and Ptolemy followed him. Proclus proceeds:

'Let us then set out here not only the observations of the ancients but also the construction of the dioptra of

¹ Vitruvius, x. 14.

² Heron, *Dioptra*, c. 34.

³ Heron, *Metrica*, i. 31, p. 74. 21.

⁴ Proclus, *Hypotyposis*, pp. 120. 9–15, 124. 7–26.

Hipparchus. And first we will show how we can measure an interval of time by means of the regular efflux of water, a procedure which was explained by Heron the mechanician in his treatise on water-clocks.'

Theon of Alexandria has a passage to a similar effect.¹ He first says that the most ancient mathematicians contrived a vessel which would let water flow out uniformly through a small aperture at the bottom, and then adds at the end, almost in the same words as Proclus uses, that Heron showed how this is managed in the first book of his work on water-clocks. Theon's account is from Pappus's Commentary on the *Syntaxis*, and this is also Proclus's source, as is shown by the fact that Proclus gives a drawing of the water-clock which appears to have been lost in Theon's transcription from Pappus, but which Pappus must have reproduced from the work of Heron. Tittel infers that Heron must have ranked as one of the 'more ancient' writers as compared with Ptolemy. But this again does not seem to be a necessary inference. No doubt Heron's work was a convenient place to refer to for a description of a water-clock, but it does not necessarily follow that Ptolemy was referring to Heron's clock rather than some earlier form of the same instrument.

An entirely different conclusion from that of Tittel is reached in the article 'Ptolemaios and Heron' already alluded to.² The arguments are shortly these. (1) Ptolemy says in his *Geography* (c. 3) that his predecessors had only been able to measure the distance between two places (as an arc of a great circle on the earth's circumference) in the case where the two places are on the same meridian. He claims that he himself invented a way of doing this even in the case where the two places are neither on the same meridian nor on the same parallel circle, provided that the heights of the pole at the two places respectively, and the angle between the great circle passing through both and the meridian circle through one of the places, are known. Now Heron in his *Dioptra* deals with the problem of measuring the distance between two places by means of the dioptra, and takes as an example

¹ Theon, *Comm. on the Syntaxis*, Basel, 1538, pp. 261 sq. (quoted in Proclus, *Hypotyposis*, ed. Manitius, pp. 309-11).

² Hammer-Jensen, *op. cit.*

the distance between Rome and Alexandria.¹ Unfortunately the text is in places corrupt and deficient, so that the method cannot be reconstructed in detail. But it involved the observation of the same lunar eclipse at Rome and Alexandria respectively and the drawing of the *analemma* for Rome. That is to say, the mathematical method which Ptolemy claims to have invented is spoken of by Heron as a thing generally known to experts and not more remarkable than other technical matters dealt with in the same book. Consequently Heron must have been later than Ptolemy. (It is right to add that some hold that the chapter of the *Dioptra* in question is not germane to the subject of the treatise, and was probably not written by Heron but interpolated by some later editor; if this is so, the argument based upon it falls to the ground.) (2) The dioptra described in Heron's work is a fine and accurate instrument, very much better than anything Ptolemy had at his disposal. If Ptolemy had been aware of its existence, it is highly unlikely that he would have taken the trouble to make his separate and imperfect 'parallactic' instrument, since it could easily have been grafted on to Heron's dioptra. Not only, therefore, must Heron have been later than Ptolemy but, seeing that the technique of instrument-making had made such strides in the interval, he must have been considerably later. (3) In his work *περὶ ῥοπῶν*² Ptolemy, as we have seen, disputed the view of Aristotle that air has weight even when surrounded by air. Aristotle satisfied himself experimentally that a vessel full of air is heavier than the same vessel empty; Ptolemy, also by experiment, convinced himself that the former is actually the lighter. Ptolemy then extended his argument to water, and held that water with water round it has no weight, and that the diver, however deep he dives, does not feel the weight of the water above him. Heron³ asserts that water has no appreciable weight and has no appreciable power of compressing the air in a vessel inverted and forced down into the water. In confirmation of this he cites the case of the diver, who is not prevented from breathing when far below

¹ Heron, *Dioptra*, c. 35 (vol. iii, pp. 302-6).

² Simplicius on *De caelo*, p. 710. 14, Heib. (Ptolemy, vol. ii, p. 263).

³ Heron, *Pneumatica*, i. Pref. (vol. i, p. 22. 14 sq.).



THIS PAGE IS LOCKED TO FREE MEMBERS

Purchase full membership to immediately unlock this page

FORGOTTEN BOOKS

FULL

MEMBERSHIP

797,885 Books!

All you can read

for only

\$8.99/month

Continue

*Fair usage policy applies



Heron was known as ὁ Ἀλεξανδρεύς (e.g. by Pappus) or ὁ μηχανικός (*mechanicus*), to distinguish him from other persons of the same name; Proclus and Damianus use the latter title, while Pappus also speaks of οἱ περὶ τὸν Ἡρώνα μηχανικοί.

Character of works.

Heron was an almost encyclopaedic writer on mathematical and physical subjects. Practical utility rather than theoretical completeness was the object aimed at; his environment in Egypt no doubt accounts largely for this. His *Metrica* begins with the old legend of the traditional origin of geometry in Egypt, and in the *Dioptra* we find one of the very problems which geometry was intended to solve, namely that of re-establishing boundaries of lands when the flooding of the Nile had destroyed the land-marks: 'When the boundaries of an area have become obliterated to such an extent that only two or three marks remain, in addition to a plan of the area, to supply afresh the remaining marks.'¹ Heron makes little or no claim to originality; he often quotes authorities, but, in accordance with Greek practice, he more frequently omits to do so, evidently without any idea of misleading any one; only when he has made what is in his opinion any slight improvement on the methods of his predecessors does he trouble to mention the fact, a habit which clearly indicates that, except in these cases, he is simply giving the best traditional methods in the form which seemed to him easiest of comprehension and application. The *Metrica* seems to be richest in definite references to the discoveries of predecessors; the names mentioned are Archimedes, Dionysodorus, Eudoxus, Plato; in the *Dioptra* Eratosthenes is quoted, and in the introduction to the *Catoptrica* Plato and Aristotle are mentioned.

The practical utility of Heron's manuals being so great, it was natural that they should have great vogue, and equally natural that the most popular of them at any rate should be re-edited, altered and added to by later writers; this was inevitable with books which, like the *Elements* of Euclid, were in regular use in Greek, Byzantine, Roman, and Arabian

¹ Heron, *Dioptra*, c. 25, p. 268. 17-19.

education for centuries. The geometrical or mensurational books in particular gave scope for expansion by multiplication of examples, so that it is difficult to disentangle the genuine Heron from the rest of the collections which have come down to us under his name. Hultsch's considered criterion is as follows: 'The Heron texts which have come down to our time are authentic in so far as they bear the author's name and have kept the original design and form of Heron's works, but are unauthentic in so far as, being constantly in use for practical purposes, they were repeatedly re-edited and, in the course of re-editing, were rewritten with a view to the particular needs of the time.'

List of Treatises.

Such of the works of Heron as have survived have reached us in very different ways. Those which have come down in the Greek are:

I. The *Metrica*, first discovered in 1896 in a manuscript of the eleventh (or twelfth) century at Constantinople by R. Schöne and edited by his son, H. Schöne (*Heronis Opera*, iii, Teubner, 1903)..

II. *On the Dioptra*, edited in an Italian version by Venturi in 1814; the Greek text was first brought out by A. J. H. Vincent¹ in 1858, and the critical edition of it by H. Schöne is included in the Teubner vol. iii just mentioned.

III. The *Pneumatica*, in two Books, which appeared first in a Latin translation by Commandinus, published after his death in 1575; the Greek text was first edited by Thévenot in *Veterum mathematicorum opera Graece et Latine edita* (Paris, 1693), and is now available in *Heronis Opera*, i (Teubner, 1899), by W. Schmidt.

IV. *On the art of constructing automata* (περὶ αὐτοματοποιητικῆς), or *The automaton-theatre*, first edited in an Italian translation by B. Baldi in 1589; the Greek text was included in Thévenot's *Vet. math.*, and now forms part of *Heronis Opera*, vol. i, by W. Schmidt.

V. *Belopoeica* (on the construction of engines of war), edited

¹ *Notices et extraits des manuscrits de la Bibliothèque impériale*, xix, pt. 2, pp. 157-337.

by B. Baldi (Augsburg, 1616), Thévenot (*Vet. math.*), Köchly and Rüstow (1853) and by Wescher (*Poliorcétique des Grecs*, 1867, the first critical edition).

VI. The *Cheirobalistra* ("Ἡρωνος χειροβαλλίστρας κατασκευὴ καὶ συμμετρία (?)), edited by V. Prou, *Notices et extraits*, xxvi. 2 (Paris, 1877).

VII. The geometrical works, *Definitiones*, *Geometria*, *Geodaesia*, *Stereometrica* I and II, *Mensurae*, *Liber Geeponicus*, edited by Hultsch with *Variae collectiones (Heronis Alexandrini geometricorum et stereometricorum reliquiae*, 1864). This edition will now be replaced by that of Heiberg in the Teubner collection (vols. iv, v), which contains much additional matter from the Constantinople manuscript referred to, but omits the *Liber Geeponicus* (except a few extracts) and the *Geodaesia* (which contains only a few extracts from the *Geometry* of Heron).

Only fragments survive of the Greek text of the *Mechanics* in three Books, which, however, is extant in the Arabic (now edited, with German translation, in *Heronis Opera*, vol. ii, by L. Nix and W. Schmidt, Teubner, 1901).

A smaller separate mechanical treatise, the *Βαρουλκός*, is quoted by Pappus.¹ The object of it was 'to move a given weight by means of a given force', and the machine consisted of an arrangement of interacting toothed wheels with different diameters.

At the end of the *Dioptra* is a description of a *hodometer* for measuring distances traversed by a wheeled vehicle, a kind of taxameter, likewise made of a combination of toothed wheels.

A work on *Water-clocks* (περὶ ὑδρίων ὠροσκοπείων) is mentioned in the *Pneumatica* as having contained four Books, and is also alluded to by Pappus.² Fragments are preserved in Proclus (*Hypotyposis*, chap. 4) and in Pappus's commentary on Book V of Ptolemy's *Syntaxis* reproduced by Theon.

Of Heron's *Commentary on Euclid's Elements* only very meagre fragments survive in Greek (Proclus), but a large number of extracts are fortunately preserved in the Arabic commentary of an-Nairīzī, edited (1) in the Latin version of Gherard of Cremona by Curtze (Teubner, 1899), and (2) by

¹ Pappus, viii, p. 1060. 5.

² *Ib.*, p. 1026. 1.



THIS PAGE IS LOCKED TO FREE MEMBERS

Purchase full membership to immediately unlock this page

DELVE INTO FANTASY, MAGIC, MYTHOLOGY & FOLKLORE

Forgotten Books'
Full Membership gives
access to 797,885 ancient
and modern, fiction and
non-fiction books.

Continue

*Fair usage policy applies

Of this class are the different cases of I. 35, 36, III. 7, 8 (where the chords to be compared are drawn on different sides of the diameter instead of on the same side), III. 12 (which is not Euclid's at all but Heron's own, adding the case of external to that of internal contact in III. 11), VI. 19 (where the triangle in which an additional line is drawn is taken to be the *smaller* of the two), VII. 19 (where the particular case is given of *three* numbers in continued proportion instead of four proportionals).

(3) Alternative proofs.

It appears to be Heron who first introduced the easy but uninformative semi-algebraical method of proving the propositions II. 2–10 which is now so popular. On this method the propositions are proved 'without figures' as consequences of II. 1 corresponding to the algebraical formula

$$a(b + c + d + \dots) = ab + ac + ad + \dots$$

Heron explains that it is not possible to prove II. 1 without drawing a number of lines (i.e. without actually drawing the rectangles), but that the following propositions up to II. 10 can be proved by merely drawing one line. He distinguishes two varieties of the method, one by *dissolutio*, the other by *compositio*, by which he seems to mean *splitting-up* of rectangles and squares and *combination* of them into others. But in his proofs he sometimes combines the two varieties.

Alternative proofs are given (a) of some propositions of Book III, namely III. 25 (placed after III. 30 and starting from the *arc* instead of the chord), III. 10 (proved by means of III. 9), III. 13 (a proof preceded by a lemma to the effect that a straight line cannot meet a circle in more than two points).

A class of alternative proof is (b) that which is intended to meet a particular objection (*ένστασις*) which had been or might be raised to Euclid's constructions. Thus in certain cases Heron avoids *producing* a certain straight line, where Euclid produces it, the object being to meet the objection of one who should deny our right to assume that there is *any space available*. Of this class are his proofs of I. 11, 20 and his note on I. 16. Similarly in I. 48 he supposes the right-angled

triangle which is constructed to be constructed on the same side of the common side as the given triangle is.

A third class (c) is that which avoids *reductio ad absurdum*, e.g. a direct proof of I. 19 (for which he requires and gives a preliminary lemma) and of I. 25.

(4) Heron supplies certain *converses* of Euclid's propositions e.g. of II. 12, 13 and VIII. 27.

(5) A few additions to, and extensions of, Euclid's propositions are also found. Some are unimportant, e.g. the construction of isosceles and scalene triangles in a note on I. 1 and the construction of *two* tangents in III. 17. The most important extension is that of III. 20 to the case where the angle at the circumference is greater than a right angle, which gives an easy way of proving the theorem of III. 22. Interesting also are the notes on I. 37 (on I. 24 in Proclus), where Heron proves that two triangles with two sides of the one equal to two sides of the other and with the included angles *supplementary* are equal in area, and compares the areas where the sum of the included angles (one being supposed greater than the other) is less or greater than two right angles, and on I. 47, where there is a proof (depending on preliminary lemmas) of the fact that, in the figure of Euclid's proposition (see next page), the straight lines AL , BG , CE meet in a point. This last proof is worth giving. First come the lemmas.

(1) If in a triangle ABC a straight line DE be drawn parallel to the base BC cutting the sides AB , AC or those

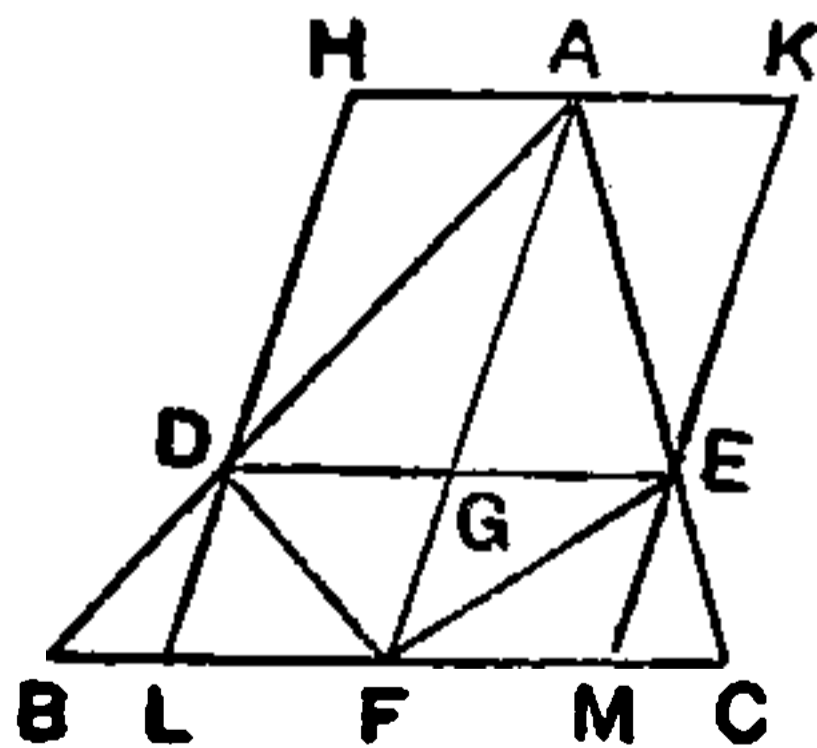

sides produced in D , E , and if F be the middle point of BC , then the straight line AF (produced if necessary) will also bisect DE . (HK is drawn through A parallel to DE , and HDL , KEM through D , E parallel to AF meeting the base in L , M respectively. Then the triangles ABF , AFC

between the same parallels are equal. So are the triangles DBF , EFC . Therefore the differences, the triangles ADF , AEF , are equal and so therefore are the parallelograms HF , KF . Therefore $LF = FM$, or $DG = GE$.)

(2) is the converse of Eucl. I. 43. If a parallelogram is

cut into four others $ADGE$, DF , $FGCB$, CE , so that DF , CE are equal, the common vertex G will lie on the diagonal AB .

Heron produces AG to meet CF in H , and then proves that AHB is a straight line:

Since DF , CE are equal; so are the triangles DGF , ECG . Adding the triangle GCF , we have the triangles ECF , DCF equal, and DE , CF are parallel.

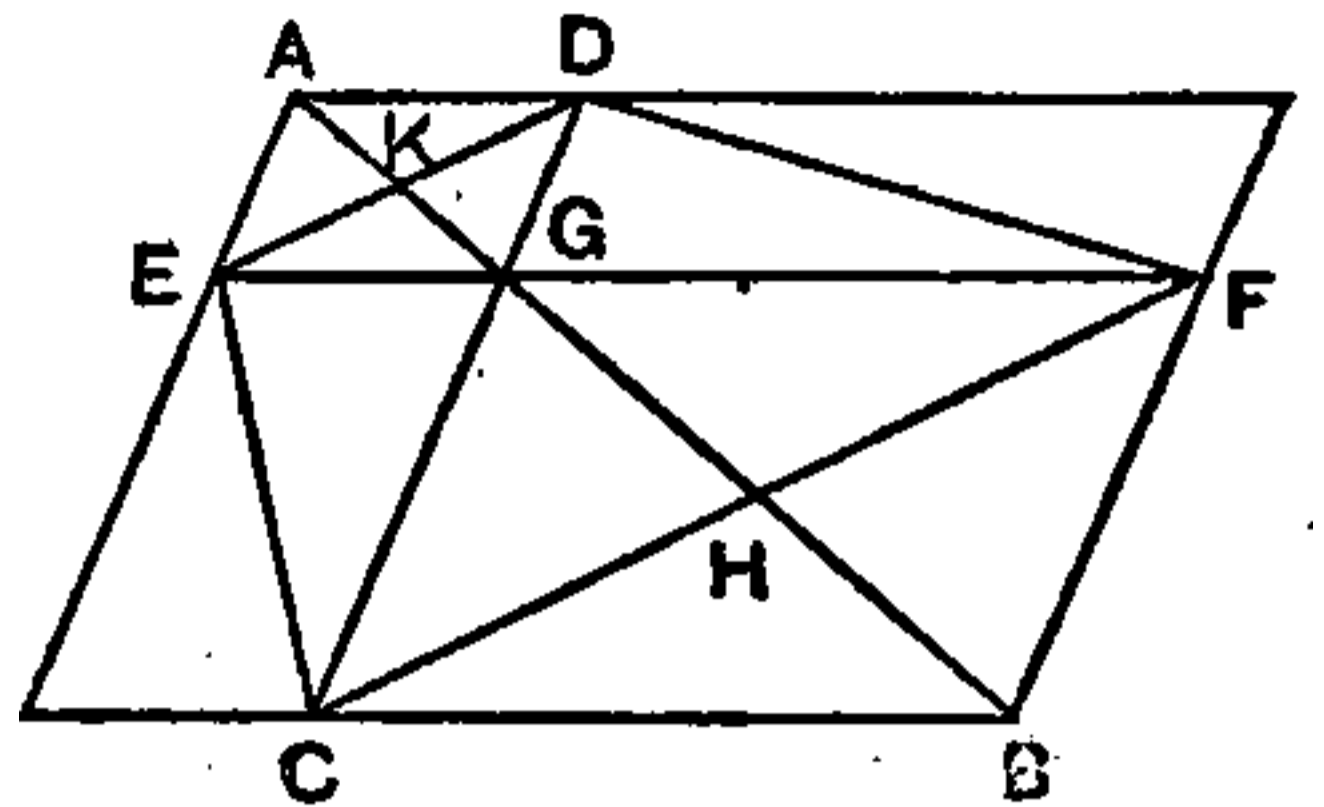

But (by I. 34, 29, 26) the triangles AKE , GKD are congruent,

so that $EK = KD$; and by lemma (1) it follows that $CH = HF$.

Now, in the triangles FHB , CHG , two sides (BF , FH and GC , CH) and the included angles are equal; therefore the triangles are congruent, and the angles BHF , GHC are equal.

Add to each the angle GHF , and

$$\angle BHF + \angle FHG = \angle CHG + \angle GHF = \text{two right angles.}$$

To prove his substantive proposition Heron draws AKL perpendicular to BC , and joins EC meeting AK in M . Then we have only to prove that BMG is a straight line.

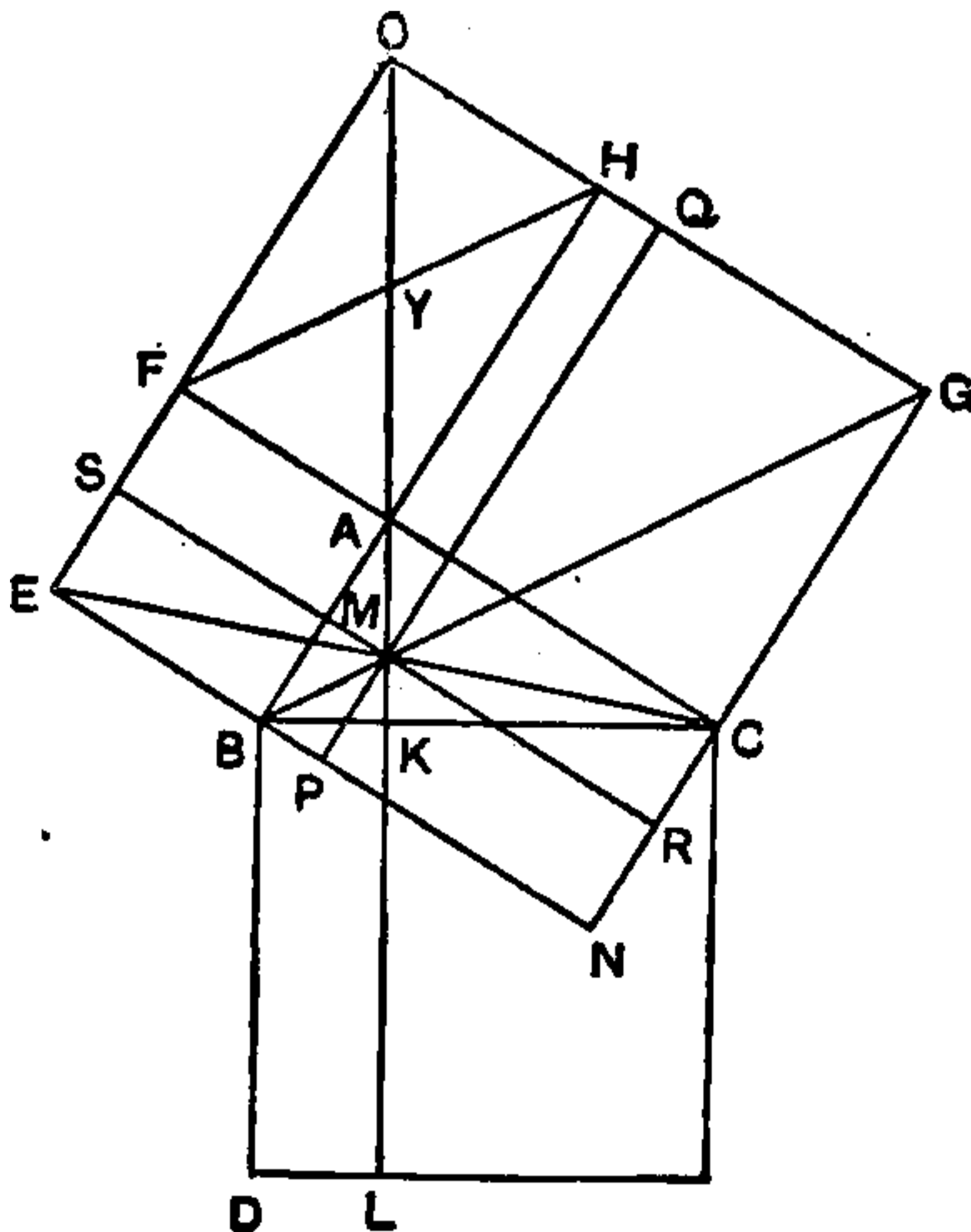

Complete the parallelogram $FAHO$, and draw the diagonals OA , FH meeting in Y . Through M draw PQ , SR parallel respectively to BA , AC .



THIS PAGE IS LOCKED TO FREE MEMBERS

Purchase full membership to immediately unlock this page

FORGOTTEN BOOKS

FULL

MEMBERSHIP

797,885 Books!

All you can read

for only

\$8.99/month

Continue

*Fair usage policy applies



‘concave’ and ‘convex’, lune, garland (these last two are composite of homogeneous parts) and *axe* (πέλεκυς), bounded by four circular arcs, two concave and two convex, Defs. 27–38. Rectilinear figures follow, the various kinds of triangles and of quadrilaterals, the gnomon in a parallelogram, and the gnomon in the more general sense of the figure which added to a given figure makes the whole into a similar figure, polygons, the parts of figures (side, diagonal, height of a triangle), perpendicular, parallels, the three figures which will fill up the space round a point, Defs. 39–73. Solid figures are next classified according to the surfaces bounding them, and lines on surfaces are divided into (1) simple and circular, (2) mixed, like the conic and spiric curves, Defs. 74, 75. The sphere is then defined, with its parts, and stated to be the figure which, of all figures having the same surface, is the greatest in content, Defs. 76–82. Next the cone, its different species and its parts are taken up, with the distinction between the three conics, the section of the acute-angled cone (‘by some also called *ellipse*’) and the sections of the right-angled and obtuse-angled cones (also called *parabola* and *hyperbola*), Defs. 83–94; the cylinder, a section in general, the *spire* or *tore* in its three varieties, open, continuous (or just closed) and ‘crossing-itself’, which respectively have sections possessing special properties, ‘square rings’ which are cut out of cylinders (i. e. presumably rings the cross-section of which through the centre is two squares), and various other figures cut out of spheres or mixed surfaces, Defs. 95–7; rectilinear solid figures, pyramids, the five regular solids, the semi-regular solids of Archimedes two of which (each with fourteen faces) were known to Plato, Defs. 98–104; prisms of different kinds, parallelepipeds, with the special varieties, the cube, the *beam*, δοκός (length longer than breadth and depth, which may be equal), the *brick*, πλινθίς (length less than breadth and depth), the σφηνίσκος or βωμίσκος with length, breadth and depth unequal, Defs. 105–14.

Lastly come definitions of relations, equality of lines, surfaces, and solids respectively, similarity of figures, ‘reciprocal figures’, Defs. 115–18; indefinite increase in magnitude, parts (which must be homogeneous with the wholes, so that e. g. the horn-like angle is not a part or submultiple of a right

or any angle), multiples, Defs. 119–21; proportion in magnitudes, what magnitudes can have a ratio to one another, magnitudes in the same ratio or magnitudes in proportion, definition of greater ratio, Defs. 122–5; transformation of ratios (*componendo*, *separando*, *convertendo*, *alternando*, *invertendo* and *ex aequali*), Defs. 126–7; commensurable and incommensurable magnitudes and straight lines, Defs. 128, 129. There follow two tables of measures, Defs. 130–2.

The *Definitions* are very valuable from the point of view of the historian of mathematics, for they give the different alternative definitions of the fundamental conceptions; thus we find the Archimedean ‘definition’ of a straight line, other definitions which we know from Proclus to be due to Apollonius, others from Posidonius, and so on. No doubt the collection may have been recast by some editor or editors after Heron’s time, but it seems, at least in substance, to go back to Heron or earlier still. So far as it contains original definitions of Posidonius, it cannot have been compiled earlier than the first century B.C.; but its content seems to belong in the main to the period before the Christian era. Heiberg adds to his edition of the *Definitions* extracts from Heron’s *Geometry*, postulates and axioms from Euclid, extracts from Geminus on the classification of mathematics, the principles of geometry, &c., extracts from Proclus or some early collection of scholia on Euclid, and extracts from Anatolius and Theon of Smyrna, which followed the actual definitions in the manuscripts. These various additions were apparently collected by some Byzantine editor, perhaps of the eleventh century.

Mensuration.

The *Metrica*, *Geometrica*, *Stereometrica*, *Geodaesia*,
Mensurae.

We now come to the mensuration of Heron. Of the different works under this head the *Metrica* is the most important from our point of view because it seems, more than any of the others, to have preserved its original form. It is also more fundamental in that it gives the theoretical basis of the formulae used, and is not a mere application of rules to particular examples. It is also more akin to theory in that it

does not use concrete measures, but simple numbers or units which may then in particular cases be taken to be feet, cubits, or any other unit of measurement. Up to 1896, when a manuscript of it was discovered by R. Schöne at Constantinople, it was only known by an allusion to it in Eutocius (on Archimedes's *Measurement of a Circle*), who states that the way to obtain an approximation to the square root of a non-square number is shown by Heron in his *Metrica*, as well as by Pappus, Theon, and others who had commented on the *Syntaxis* of Ptolemy.¹ Tannery² had already in 1894 discovered a fragment of Heron's *Metrica* giving the particular rule in a Paris manuscript of the thirteenth century containing Prolegomena to the *Syntaxis* compiled presumably from the commentaries of Pappus and Theon. Another interesting difference between the *Metrica* and the other works is that in the former the Greek way of writing fractions (which is our method) largely preponderates, the Egyptian form (which expresses a fraction as the sum of diminishing submultiples) being used comparatively rarely, whereas the reverse is the case in the other works.

In view of the greater authority of the *Metrica*, we shall take it as the basis of our account of the mensuration, while keeping the other works in view. It is desirable at the outset to compare broadly the contents of the various collections. Book I of the *Metrica* contains the mensuration of squares, rectangles and triangles (chaps. 1–9), parallel-trapezia, rhombi, rhomboids and quadrilaterals with one angle right (10–16), regular polygons from the equilateral triangle to the regular dodecagon (17–25), a ring between two concentric circles (26), segments of circles (27–33), an ellipse (34), a parabolic segment (35), the surfaces of a cylinder (36), an isosceles cone (37), a sphere (38) and a segment of a sphere (39). Book II gives the mensuration of certain solids, the solid content of a cone (chap. 1), a cylinder (2), rectilinear solid figures, a parallelepiped, a prism, a pyramid and a frustum, &c. (3–8), a frustum of a cone (9, 10), a sphere and a segment of a sphere (11, 12), a *spire* or *tore* (13), the section of a cylinder measured in Archimedes's *Method* (14), and the solid

¹ Archimedes, vol. iii, p. 232. 13–17.

² Tannery, *Mémoires scientifiques*, ii, 1912, pp. 447–54.



THIS PAGE IS LOCKED TO FREE MEMBERS

Purchase full membership to immediately unlock this page

DELVE INTO FANTASY, MAGIC, MYTHOLOGY & FOLKLORE

Forgotten Books'
Full Membership gives
access to 797,885 ancient
and modern, fiction and
non-fiction books.

Continue

*Fair usage policy applies

Heiberg puts side by side with corresponding sections of the *Geometrica* in parallel columns; others he inserts in suitable places; sections 78. 79 contain two important problems in indeterminate analysis (= *Geom.* 24, 1-2, Heib.). Heiberg adds, from the Constantinople manuscript containing the *Metrica*, eleven more sections (chap. 24, 3-13) containing indeterminate problems, and other sections (chap. 24, 14-30 and 37-51) giving the mensuration, mainly, of figures inscribed in or circumscribed to others, e. g. squares or circles in triangles, circles in squares, circles about triangles, and lastly of circles and segments of circles.

The *Stereometrica* I has at the beginning the title *Εἰσαγωγὰ τῶν στερεομετρομένων Ἡρώου* but, like the *Geometrica*, seems to have been edited by Patricius. Chaps. 1-40 give the mensuration of the geometrical solid figures, the sphere, the cone, the frustum of a cone, the obelisk with circular base, the cylinder, the 'pillar', the cube, the *σφηνίσκος* (also called *ὄνυξ*), the *μείουρον προεσκαριφευμένον*, pyramids, and frusta. Some portions of this section of the book go back to Heron; thus in the measurement of the sphere chap. 1 = *Metrica* II. 11, and both here and elsewhere the ordinary form of fractions appears. Chaps. 41-54 measure the contents of certain buildings or other constructions, e. g. a theatre, an amphitheatre, a swimming-bath, a well, a ship, a wine-butt, and the like.

The second collection, *Stereometrica* II, appears to be of Byzantine origin and contains similar matter to *Stereometrica* I, parts of which are here repeated. Chap. 31 (27, Heib.) gives the problem of Thales, to find the height of a pillar or a tree by the measurement of shadows; the last sections measure various pyramids, a prism, a *βωμίσκος* (little altar).

The *Geodaesia* is not an independent work, but only contains extracts from the *Geometry*; thus chaps. 1-16 = *Geom.* 5-31, Hultsch (= 5, 2-12, 32, Heib.); chaps. 17-19 give the methods of finding, in any scalene triangle the sides of which are given, the segments of the base made by the perpendicular from the vertex, and of finding the area direct by the well-known 'formula of Heron'; i. e. we have here the equivalent of *Metrica* I. 5-8.

Lastly, the *μετρήσεις*, or *Mensurae*, was attributed to Heron

in an Archimedes manuscript of the ninth century, but cannot in its present form be due to Heron, although portions of it have points of contact with the genuine works. Sects. 2-27 measure all sorts of objects, e.g. stones of different shapes, a pillar, a tower, a theatre, a ship, a vault, a hippodrome; but sects. 28-35 measure geometrical figures, a circle and segments of a circle (cf. *Metrica* I), and sects. 36-48 on spheres, segments of spheres, pyramids, cones and frusta are closely connected with *Stereom.* I and *Metrica* II; sects. 49-59, giving the measurement of receptacles and plane figures of various shapes, seem to have a different origin. We can now take up the

Contents of the *Metrica*.

Book I. Measurement of Areas.

The preface records the tradition that the first geometry arose out of the practical necessity of measuring and distributing land (whence the name 'geometry'), after which extension to three dimensions became necessary in order to measure solid bodies. Heron then mentions Eudoxus and Archimedes as pioneers in the discovery of difficult measurements, Eudoxus having been the first to prove that a cylinder is three times the cone on the same base and of equal height, and that circles are to one another as the squares on their diameters, while Archimedes first proved that the surface of a sphere is equal to four times the area of a great circle in it, and the volume two-thirds of the cylinder circumscribing it.

(a) *Area of scalene triangle.*

After the easy cases of the rectangle, the right-angled triangle and the isosceles triangle, Heron gives two methods of finding the area of a scalene triangle (acute-angled or obtuse-angled) when the lengths of the three sides are given.

The first method is based on Eucl. II. 12 and 13. If a, b, c be the sides of the triangle opposite to the angles A, B, C respectively, Heron observes (chap. 4) that any angle, e.g. C , is acute, right or obtuse according as $c^2 < =$ or $> a^2 + b^2$, and this is the criterion determining which of the two propositions is applicable. The method is directed to determining, first the segments into which any side is divided by the perpendicular

from the opposite vertex, and thence the length of the perpendicular itself. We have, in the cases of the triangle acute-angled at C and the triangle obtuse-angled at C respectively,

$$c^2 = a^2 + b^2 \mp 2a \cdot CD,$$

or
$$CD = \{(a^2 + b^2) \sim c^2\} / 2a,$$

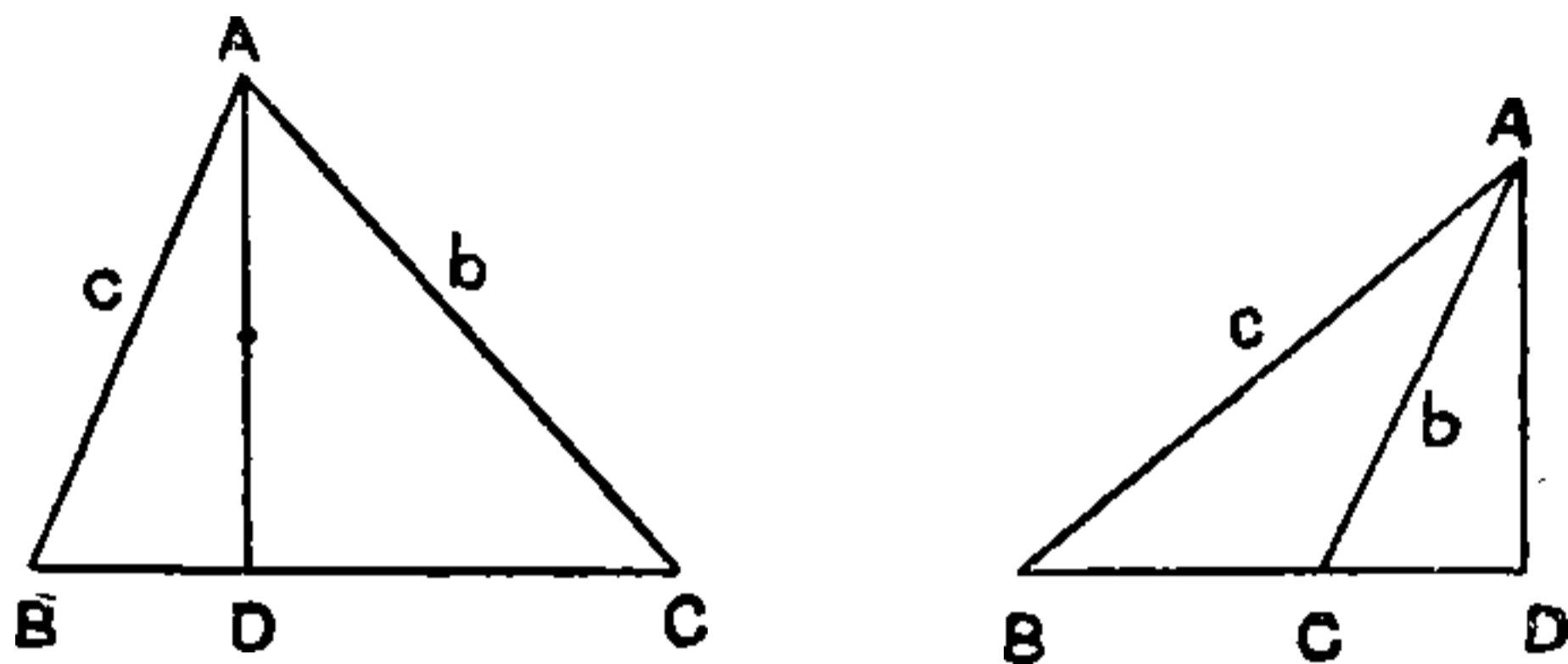

whence $AD^2 (= b^2 - CD^2)$ is found, so that we know the area $(= \frac{1}{2}a \cdot AD)$.

In the cases given in *Metrica* I. 5, 6 the sides are (14, 15, 13) and (11, 13, 20) respectively, and AD is found to be rational ($= 12$). But of course both CD (or BD) and AD may be surds, in which case Heron gives approximate values. Cf. *Geom.* 53, 54, Hultsch (15, 1-4, Heib.), where we have a triangle in which $a = 8$, $b = 4$, $c = 6$, so that $a^2 + b^2 - c^2 = 44$ and $CD = 44 / 16 = 2\frac{1}{2} \frac{1}{4}$. Thus $AD^2 = 16 - (2\frac{1}{2} \frac{1}{4})^2 = 16 - 7\frac{1}{2} \frac{1}{16} = 8\frac{1}{4} \frac{1}{8} \frac{1}{16}$, and $AD = \sqrt{(8\frac{1}{4} \frac{1}{8} \frac{1}{16})} = 2\frac{2}{3} \frac{1}{4}$ approximately, whence the area $= 4 \times 2\frac{2}{3} \frac{1}{4} = 11\frac{2}{3}$. Heron then observes that we get a nearer result still if we multiply AD^2 by $(\frac{1}{2}a)^2$ before extracting the square root, for the area is then $\sqrt{(16 \times 8\frac{1}{4} \frac{1}{8} \frac{1}{16})}$ or $\sqrt{(135)}$, which is very nearly $11\frac{1}{2} \frac{1}{4} \frac{1}{21}$ or $11\frac{1}{2} \frac{3}{1}$.

So in *Metrica* I. 9, where the triangle is 10, 8, 12 (10 being the base), Heron finds the perpendicular to be $\sqrt{63}$, but he obtains the area as $\sqrt{(\frac{1}{4}AD^2 \cdot BC^2)}$, or $\sqrt{(1575)}$, while observing that we can, of course, take the approximation to $\sqrt{63}$, or $7\frac{1}{2} \frac{1}{4} \frac{1}{8} \frac{1}{16}$, and multiply it by half 10, obtaining $39\frac{1}{2} \frac{1}{8} \frac{1}{16}$ as the area.

Proof of the formula $\Delta = \sqrt{\{s(s-a)(s-b)(s-c)\}}$.

The second method is that known as the 'formula of Heron', namely, in our notation, $\Delta = \sqrt{\{s(s-a)(s-b)(s-c)\}}$. The proof of the formula is given in *Metrica* I. 8 and also in



THIS PAGE IS LOCKED TO FREE MEMBERS

Purchase full membership to immediately unlock this page

FORGOTTEN BOOKS

FULL

MEMBERSHIP

797,885 Books!

All you can read

for only

\$8.99/month

Continue

*Fair usage policy applies



Draw OL at right angles to OC cutting BC in K , and BL at right angles to BC meeting OL in L . Join CL .

Then, since each of the angles COL , CBL is right, $COBL$ is a quadrilateral in a circle.

Therefore $\angle COB + \angle CLB = 2R$.

But $\angle COB + \angle AOF = 2R$, because AO , BO , CO bisect the angles round O , and the angles COB , AOF are together equal to the angles AOC , BOF , while the sum of all four angles is equal to $4R$.

Consequently $\angle AOF = \angle CLB$.

Therefore the right-angled triangles AOF , CLB are similar ;

therefore $BC : BL = AF : FO$
 $= BH : OD$,

and, alternately, $CB : BH = BL : OD$
 $= BK : KD$;

whence, *componendo*, $CH : HB = BD : DK$.

It follows that

$$CH^2 : CH \cdot HB = BD \cdot DC : CD \cdot DK$$

$$= BD \cdot DC : OD^2, \text{ since the angle } COK \text{ is right.}$$

$$\text{Therefore } (\Delta ABC)^2 = CH^2 \cdot OD^2 \text{ (from above)}$$

$$= CH \cdot HB \cdot BD \cdot DC$$

$$= s(s-a)(s-b)(s-c).$$

(β) *Method of approximating to the square root of a non-square number.*

It is à propos of the triangle 7, 8, 9 that Heron gives the important statement of his method of approximating to the value of a surd, which before the discovery of the passage of the *Metrica* had been a subject of unlimited conjecture as bearing on the question how Archimedes obtained his approximations to $\sqrt{3}$.

In this case $s = 12$, $s-a = 5$, $s-b = 4$, $s-c = 3$, so that

$$\Delta = \sqrt{(12 \cdot 5 \cdot 4 \cdot 3)} = \sqrt{(720)}.$$

'Since', says Heron,¹ '720 has not its side rational, we can obtain its side within a very small difference as follows. Since the next succeeding square number is 729, which has 27 for its side, divide 720 by 27. This gives $26\frac{2}{3}$. Add 27 to this, making $53\frac{2}{3}$, and take half of this or $26\frac{1}{2}\frac{1}{3}$. The side of 720 will therefore be very nearly $26\frac{1}{2}\frac{1}{3}$. In fact, if we multiply $26\frac{1}{2}\frac{1}{3}$ by itself, the product is $720\frac{1}{36}$, so that the difference (in the square) is $\frac{1}{36}$.

'If we desire to make the difference still smaller than $\frac{1}{36}$, we shall take $720\frac{1}{36}$ instead of 729 [or rather we should take $26\frac{1}{2}\frac{1}{3}$ instead of 27], and by proceeding in the same way we shall find that the resulting difference is much less than $\frac{1}{36}$.'

In other words, if we have a non-square number A , and a^2 is the nearest square number to it, so that $A = a^2 \pm b$, then we have, as the first approximation to \sqrt{A} .

$$\alpha_1 = \frac{1}{2} \left(a + \frac{A}{a} \right); \quad (1)$$

for a second approximation we take

$$\alpha_2 = \frac{1}{2} \left(\alpha_1 + \frac{A}{\alpha_1} \right), \quad (2)$$

and so on.²

¹ *Metrica*, i. 8, pp. 18, 22-20. 5.

² The method indicated by Heron was known to Barlaam and Nicolas Rhabdas in the fourteenth century. The equivalent of it was used by Luca Paciolo (fifteenth-sixteenth century), and it was known to the other Italian algebraists of the sixteenth century. Thus Luca Paciolo gave $2\frac{1}{2}$, $2\frac{9}{20}$ and $2\frac{881}{1960}$ as successive approximations to $\sqrt{6}$. He obtained

the first as $2 + \frac{2}{2 \cdot 2}$, the second as $2\frac{1}{2} - \frac{(2\frac{1}{2})^2 - 6}{2 \cdot 2\frac{1}{2}}$, and the third as

$2\frac{9}{20} - \frac{(\frac{49}{20})^2 - 6}{2 \cdot \frac{49}{20}}$. The above rule gives $\frac{1}{2} (2 + \frac{6}{2}) = 2\frac{1}{2}$, $\frac{1}{2} (\frac{5}{2} + \frac{2}{5}) = 2\frac{9}{20}$,

$\frac{1}{2} (\frac{49}{20} + \frac{120}{49}) = 2\frac{881}{1960}$.

The formula of Heron was again put forward, in modern times, by Buzengeiger as a means of accounting for the Archimedean approximation to $\sqrt{3}$, apparently without knowing its previous history. Bertrand also stated it in a treatise on arithmetic (1853). The method, too, by which Oppermann and Alexeieff sought to account for Archimedes's approximations is in reality the same. The latter method depends on the formula

$$\frac{1}{2} (\alpha + \beta) : \sqrt{(\alpha\beta)} = \sqrt{(\alpha\beta)} : \frac{2\alpha\beta}{\alpha + \beta}.$$

Alexeieff separated A into two factors a_0, b_0 , and pointed out that if, say,

$$a_0 > \sqrt{A} > b_0,$$

then, $\frac{1}{2} (a_0 + b_0) > \sqrt{A} > \frac{2A}{a_0 + b_0}$ or $\frac{2a_0b_0}{a_0 + b_0}$,

Substituting in (1) the value $a^2 \pm b$ for A , we obtain

$$\alpha_1 = a \pm \frac{b}{2a}.$$

Heron does not seem to have used this formula with a negative sign, unless in *Stereom.* I. 33 (34, Hultsch), where $\sqrt{(63)}$

and again, if $\frac{1}{2}(a_0 + b_0) = a_1, 2A/(a_0 + b_0) = b_1,$

$$\frac{1}{2}(a_1 + b_1) > \sqrt{A} > \frac{2A}{a_1 + b_1},$$

and so on.

Now suppose that, in Heron's formulae, we put $a = X_0, A/a = x_0, \alpha_1 = X_1, A/\alpha_1 = x_1,$ and so on. We then have

$$X_1 = \frac{1}{2} \left(a + \frac{A}{a} \right) = \frac{1}{2} (X_0 + x_0), \quad x_1 = \frac{A}{X_1} = \frac{A}{\frac{1}{2}(X_0 + x_0)} \text{ or } \frac{2X_0x_0}{X_0 + x_0};$$

that is, X_1, x_1 are, respectively, the arithmetic and harmonic means between X_0, x_0 ; X_2, x_2 are the arithmetic and harmonic means between $X_1, x_1,$ and so on, exactly as in Alexeieff's formulae.

Let us now try to apply the method to Archimedes's case, $\sqrt{3}$, and we shall see to what extent it serves to give what we want. Suppose we begin with $3 > \sqrt{3} > 1.$ We then have

$$\frac{1}{2}(3 + 1) > \sqrt{3} > 3 / \frac{1}{2}(3 + 1), \text{ or } 2 > \sqrt{3} > \frac{3}{2},$$

and from this we derive successively

$$\frac{7}{4} > \sqrt{3} > \frac{12}{7}, \quad \frac{97}{56} > \sqrt{3} > \frac{168}{97}, \quad \frac{18817}{10864} > \sqrt{3} > \frac{32592}{18817}.$$

But, if we start from $\frac{3}{2}$, obtained by the formula $a + \frac{b}{2a+1} < \sqrt{(a^2 + b)},$ we obtain the following approximations by excess,

$$\frac{1}{2} \left(\frac{3}{2} + \frac{3}{2} \right) = \frac{26}{15}, \quad \frac{1}{2} \left(\frac{26}{15} + \frac{15}{26} \right) = \frac{1351}{780}.$$

The second process then gives one of Archimedes's results, $\frac{1351}{780}$, but neither of the two processes gives the other, $\frac{265}{153}$, directly. The latter

can, however, be obtained by using the formula that, if $\frac{a}{b} < \frac{c}{d},$ then

$$\frac{a}{b} < \frac{ma + nc}{mb + nd} < \frac{c}{d}.$$

For we can obtain $\frac{265}{153}$ from $\frac{97}{56}$ and $\frac{168}{97}$ thus: $\frac{97 + 168}{56 + 97} = \frac{265}{153},$ or from

$\frac{97}{56}$ and $\frac{7}{4}$ thus: $\frac{11 \cdot 97 - 7}{11 \cdot 56 - 4} = \frac{1060}{612} = \frac{265}{153};$ and so on. Or again $\frac{1351}{780}$ can

be obtained from $\frac{18817}{10864}$ and $\frac{97}{56}$ thus: $\frac{18817 + 97}{10864 + 56} = \frac{18914}{10920} = \frac{1351}{780}.$

The advantage of the method is that, as compared with that of continued fractions, it is a very rapid way of arriving at a close approximation. Günther has shown that the $(m+1)$ th approximation obtained by Heron's formula is the 2^m th obtained by continued fractions. ('Die quadratischen Irrationalitäten der Alten und deren Entwicklungsmethoden' in *Abhandlungen zur Gesch. d. Math.* iv. 1882, pp. 83-6.)



THIS PAGE IS LOCKED TO FREE MEMBERS

Purchase full membership to immediately unlock this page

DELVE INTO FANTASY, MAGIC, MYTHOLOGY & FOLKLORE

Forgotten Books'
Full Membership gives
access to 797,885 ancient
and modern, fiction and
non-fiction books.

Continue

*Fair usage policy applies

now $\frac{1}{3} + \frac{1}{10} = \frac{13}{30} = \frac{1}{4} \left(\frac{26}{15} \right)$, so that the approximation used by Heron for $\sqrt{3}$ is here $\frac{26}{15}$. For the side 10, the method gives the same result as above, for $\frac{13}{30} \cdot 100 = 43\frac{1}{3}$.

The regular *pentagon* is next taken (chap. 18). Heron premises the following lemma.

Let ABC be a right-angled triangle, with the angle A equal to $\frac{2}{5}R$. Produce AC to O so that $CO = AC$. If now AO is divided in extreme and mean ratio, AB is equal to the greater segment. (For produce AB to D so that $AD = AO$, and join BO, DO . Then, since ADO is isosceles and the angle at $A = \frac{2}{5}R$, $\angle ADO = \angle AOD = \frac{4}{5}R$, and, from the equality of the triangles ABC, OBC , $\angle AOB = \angle BAO = \frac{2}{5}R$. It follows that the triangle ADO is the isosceles triangle of Eucl. IV. 10, and AD is divided in extreme and mean ratio in B .) Therefore, says Heron, $(BA + AC)^2 = 5AC^2$. [This is Eucl. XIII. 1.]

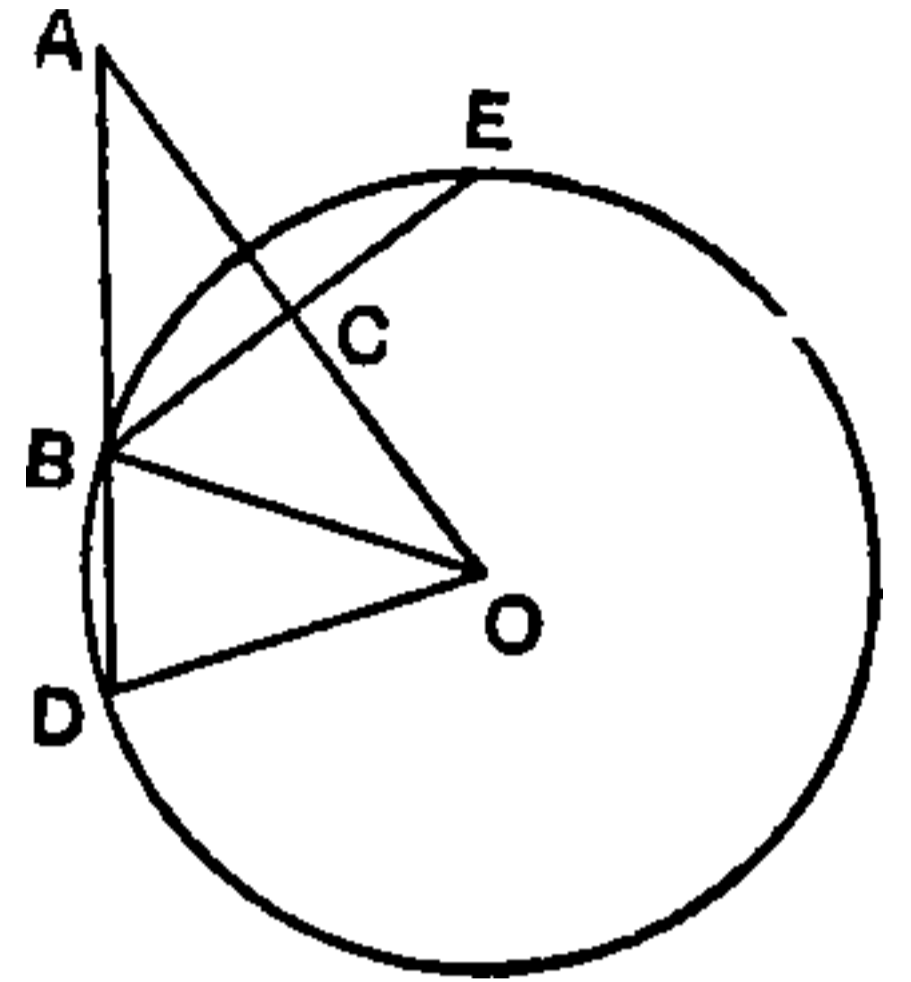

Now, since $\angle BOC = \frac{2}{5}R$, if BC be produced to E so that $CE = BC$, BE subtends at O an angle equal to $\frac{4}{5}R$, and therefore BE is the side of a regular pentagon inscribed in the circle with O as centre and OB as radius. (This circle also passes through D , and BD is the side of a regular decagon in the same circle.) If now $BO = AB = r$, $OC = p$, $BE = a$, we have from above, $(r + p)^2 = 5p^2$, whence, since $\sqrt{5}$ is approximately $\frac{9}{4}$, we obtain approximately $r = \frac{5}{4}p$, and $\frac{1}{2}a = \frac{3}{4}p$, so that $p = \frac{2}{3}a$. Hence $\frac{1}{2}pa = \frac{1}{3}a^2$, and the area of the pentagon $= \frac{5}{3}a^2$. Heron adds that, if we take a closer approximation to $\sqrt{5}$ than $\frac{9}{4}$, we shall obtain the area still more exactly. In the *Geometry*¹ the formula is given as $\frac{1}{7}^2 a^2$.

The regular *hexagon* (chap. 19) is simply 6 times the equilateral triangle with the same side. If Δ be the area of the equilateral triangle with side a , Heron has proved that $\Delta^2 = \frac{3}{16}a^4$ (*Metrica* I. 17), hence $(\text{hexagon})^2 = \frac{27}{4}a^4$. If, e.g. $a = 10$, $(\text{hexagon})^2 = 67500$, and $(\text{hexagon}) = 259$ nearly. In the *Geometry*² the formula is given as $\frac{1}{5}^3 a^2$, while 'another book' is quoted as giving $6 \left(\frac{1}{3} + \frac{1}{10} \right) a^2$; it is added that the latter formula, obtained from the area of the triangle, $\left(\frac{1}{3} + \frac{1}{10} \right) a^2$, represents the more accurate procedure, and is fully set out by

¹ *Geom.* 102 (21, 14, Heib.).

² *Ib.* 102 (21, 16, 17, Heib.).

Heron. As a matter of fact, however, $6 \left(\frac{1}{3} + \frac{1}{10} \right) = \frac{1}{5}^3$ exactly, and only the *Metrica* gives the more accurate calculation.

The regular *heptagon*.

Heron assumes (chap. 20) that, if a be the side and r the radius of the circumscribing circle, $a = \frac{7}{8}r$, being approximately equal to the perpendicular from the centre of the circle to the side of the regular hexagon inscribed in it (for $\frac{7}{8}$ is the approximate value of $\frac{1}{2}\sqrt{3}$). This theorem is quoted by Jordanus Nemorarius (d. 1237) as an 'Indian rule'; he probably obtained it from Abū'l Wafā (940-98). The *Metrica* shows that it is of Greek origin, and, if Archimedes really wrote a book on the heptagon in a circle, it may be due to him. If then p is the perpendicular from the centre of the circle on the side (a) of the inscribed heptagon, $r / (\frac{1}{2}a) = 8 / 3\frac{1}{2}$ or $16/7$, whence $p^2 / (\frac{1}{2}a)^2 = \frac{207}{49}$, and $p / \frac{1}{2}a =$ (approximately) $14\frac{1}{3}/7$ or $43/21$. Consequently the area of the heptagon $= 7 \cdot \frac{1}{2}pa = 7 \cdot \frac{43}{84}a^2 = \frac{43}{12}a^2$.

The regular *octagon*, *decagon* and *dodecagon*.

In these cases (chaps. 21, 23, 25) Heron finds p by drawing the perpendicular OG from O , the centre of the circumscribed circle, on a side AB , and then making the angle OAD equal to the angle AOD .

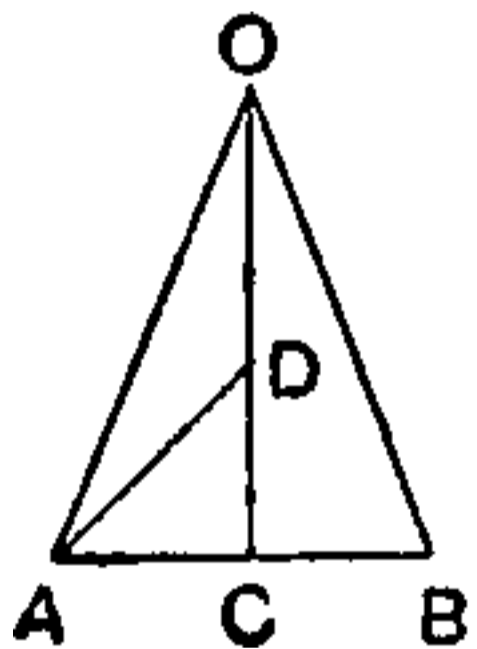

For the octagon,

$$\angle ADC = \frac{1}{2}R, \text{ and } p = \frac{1}{2}a(1 + \sqrt{2}) = \frac{1}{2}a\left(1 + \frac{17}{12}\right) \\ \text{or } \frac{1}{2}a \cdot \frac{29}{12} \text{ approximately.}$$

For the decagon,

$$\angle ADC = \frac{2}{5}R, \text{ and } AD:DC = 5:4 \text{ nearly (see preceding page);} \\ \text{hence } AD:AC = 5:3, \text{ and } p = \frac{1}{2}a\left(\frac{5}{3} + \frac{4}{3}\right) = \frac{3}{2}a.$$

For the dodecagon,

$$\angle ADC = \frac{1}{3}R, \text{ and } p = \frac{1}{2}a(2 + \sqrt{3}) = \frac{1}{2}a\left(2 + \frac{7}{4}\right) = \frac{15}{8}a \\ \text{approximately.}$$

Accordingly $A_8 = \frac{29}{6}a^2$, $A_{10} = \frac{15}{2}a^2$, $A_{12} = \frac{45}{4}a^2$, where a is the side in each case.

The regular *enneagon* and *hendecagon*.

In these cases (chaps. 22, 24) the Table of Chords (i.e.

presumably Hipparchus's Table) is appealed to. If AB be the side (a) of an enneagon or hendecagon inscribed in a circle, AC the diameter through A , we are told that the Table of Chords gives $\frac{1}{3}$ and $\frac{7}{25}$ as the respective approximate values of the ratio AB/AC . The angles subtended at the centre O by the side AB are 40° and $32\frac{8}{11}^\circ$ respectively, and Ptolemy's Table gives, as the chords subtended by angles of 40° and 33° respectively, $41^p 2' 33''$ and $34^p 4' 55''$ (expressed in 120th parts of the diameter); Heron's figures correspond to 40^p and $33^p 36'$ respectively. For the *enneagon* $AC^2 = 9AB^2$, whence $BC^2 = 8AB^2$ or approximately $\frac{289}{36}AB^2$, and $BC = \frac{17}{6}a$; therefore (area of enneagon) $= \frac{9}{2} \cdot \Delta ABC = \frac{51}{8}a^2$. For the *hendecagon* $AC^2 = \frac{625}{49}AB^2$ and $BC^2 = \frac{576}{49}AB^2$, so that $BC = \frac{24}{7}a$, and area of hendecagon $= \frac{11}{2} \cdot \Delta ABC = \frac{66}{7}a^2$.

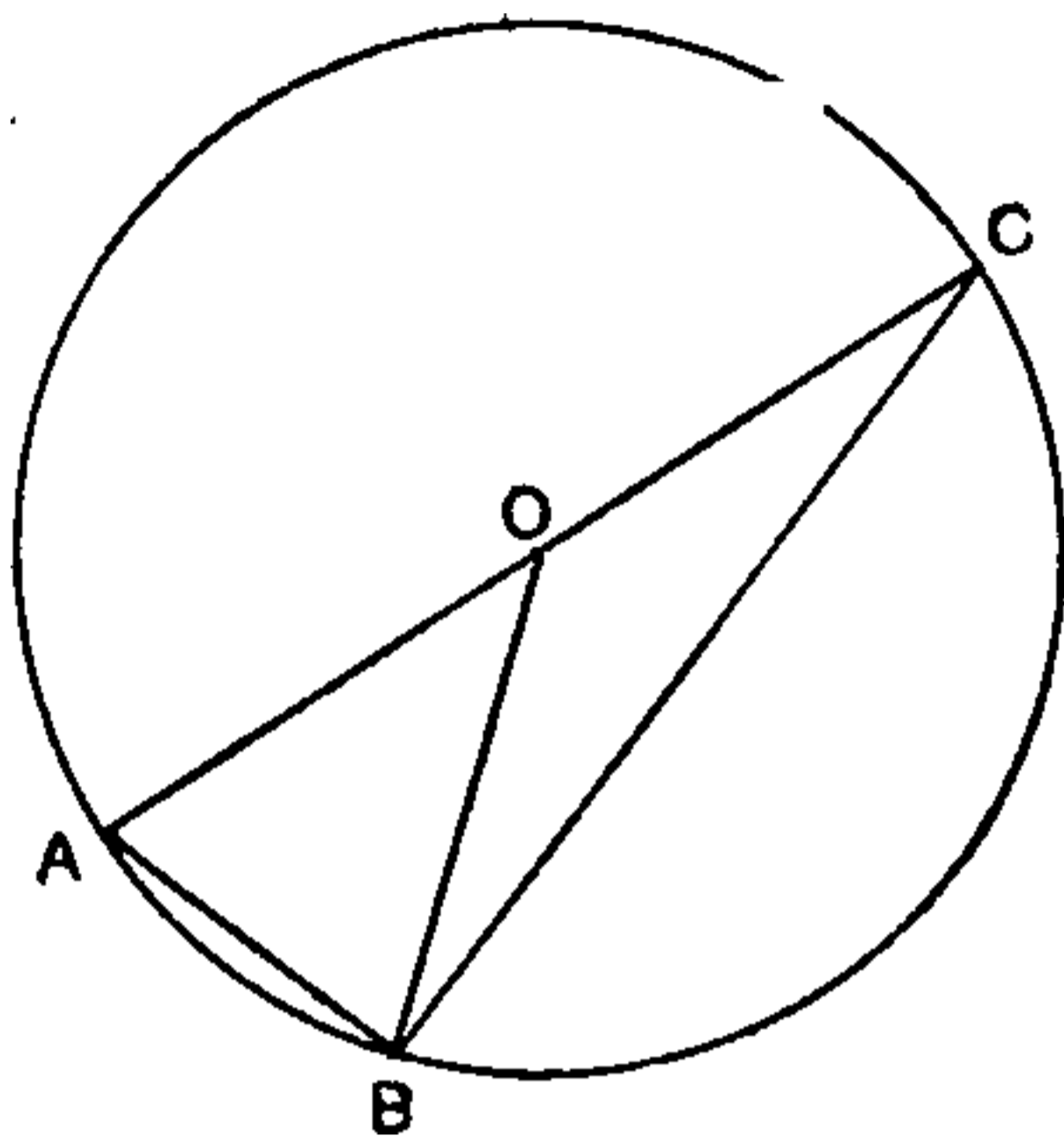

An ancient formula for the ratio between the side of any regular polygon and the diameter of the circumscribing circle is preserved in *Geëpon*. 147 sq. (= Pseudo-Dioph. 23-41), namely $d_n = n \frac{a_n}{3}$. Now the ratio na_n/d_n tends to π as the number (n) of sides increases, and the formula indicates a time when π was generally taken as $= 3$.

(e) The Circle.

Coming to the circle (*Metrica* I. 26) Heron uses Archimedes's value for π , namely $\frac{22}{7}$, making the circumference of a circle $\frac{44}{7}r$ and the area $\frac{11}{14}d^2$, where r is the radius and d the diameter. It is here that he gives the more exact limits for π which he says that Archimedes found in his work *On Plinthis and Cylinders*, but which are not convenient for calculations. The limits, as we have seen, are given in the text as $\frac{211875}{67441} < \pi < \frac{197888}{62351}$, and with Tannery's alteration to $\frac{211872}{67441} < \pi < \frac{195882}{62351}$ are quite satisfactory.¹

¹ See vol. i, pp. 232-3.



THIS PAGE IS LOCKED TO FREE MEMBERS

Purchase full membership to immediately unlock this page

FORGOTTEN BOOKS

FULL

MEMBERSHIP

797,885 Books!

All you can read

for only

\$8.99/month

Continue

*Fair usage policy applies



The first of these formulae is applied to a segment greater than a semicircle, the second to a segment less than a semicircle.

In the *Metrica* the area of a segment greater than a semicircle is obtained by subtracting the area of the complementary segment from the area of the circle.

From the *Geometrica*¹ we find that the circumference of the segment less than a semicircle was taken to be $\sqrt{(b^2 + 4h^2)} + \frac{1}{4}h$ or alternatively $\sqrt{(b^2 + 4h^2)} + \left\{ \sqrt{(b^2 + 4h^2)} - b \right\} \frac{h}{b}$.

(η) *Ellipse, parabolic segment, surface of cylinder, right cone, sphere and segment of sphere.*

After the area of an ellipse (*Metrica* I. 34) and of a parabolic segment (chap. 35), Heron gives the surface of a cylinder (chap. 36) and a right cone (chap. 37); in both cases he unrolls the surface on a plane so that the surface becomes that of a parallelogram in the one case and a sector of a circle in the other. For the surface of a sphere (chap. 38) and a segment of it (chap. 39) he simply uses Archimedes's results.

Book I ends with a hint how to measure irregular figures, plane or not. If the figure is plane and bounded by an irregular curve, neighbouring points are taken on the curve such that, if they are joined in order, the contour of the polygon so formed is not much different from the curve itself, and the polygon is then measured by dividing it into triangles. If the surface of an irregular solid figure is to be found, you wrap round it pieces of very thin paper or cloth, enough to cover it, and you then spread out the paper or cloth and measure that.

·Book II. Measurement of volumes.

The preface to Book II is interesting as showing how vague the traditions about Archimedes had already become.

‘After the measurement of surfaces, rectilinear or not, it is proper to proceed to the solid bodies, the surfaces of which we have already measured in the preceding book, surfaces plane and spherical, conical and cylindrical, and irregular surfaces as well. The methods of dealing with these solids are, in

¹ Cf. *Geom.*, 94, 95 (19. 2, 4, Heib.), 97. 4 (20. 7, Heib.).

view of their surprising character, referred to Archimedes by certain writers who give the traditional account of their origin. But whether they belong to Archimedes or another, it is necessary to give a sketch of these methods as well.'

The Book begins with generalities about figures all the sections of which parallel to the base are equal to the base and similarly situated, while the centres of the sections are on a straight line through the centre of the base, which may be either obliquely inclined or perpendicular to the base; whether the said straight line ('the axis') is or is not perpendicular to the base, the volume is equal to the product of the area of the base and the *perpendicular* height of the top of the figure from the base. The term 'height' is thenceforward restricted to the length of the perpendicular from the top of the figure on the base.

(*a*) Cone, cylinder, parallelepiped (prism), pyramid, and frustum.

II. 1-7 deal with a cone, a cylinder, a 'parallelepiped' (the base of which is not restricted to the parallelogram but is in the illustration given a regular hexagon, so that the figure is more properly a prism with polygonal bases), a triangular prism, a pyramid with base of any form, a frustum of a triangular pyramid; the figures are in general *oblique*.

(*β*) Wedge-shaped solid (*βωμίσκος* or *σφηνίσκος*).

II. 8 is a case which is perhaps worth giving. It is that of a rectilinear solid, the base of which is a rectangle $ABCD$ and has opposite to it another rectangle $EFGH$, the sides of which are respectively parallel but not necessarily proportional to those of $ABCD$. Take AK equal to EF , and BL equal to FG . Bisect BK , CL in V , W , and draw $KRPV$, $VQOM$ parallel to AD , and $LQRN$, $WOPT$ parallel to AB . Join FK , GR , LG , GU , HN .

Then the solid is divided into (1) the parallelepiped with AR , EG as opposite faces, (2) the prism with KL as base and FG as the opposite edge, (3) the prism with NU as base and GH as opposite edge, and (4) the pyramid with $RLCU$ as base and G as vertex. Let h be the 'height' of the figure. Now

the parallelepiped (1) is on AR as base and has height h ; the prism (2) is equal to a parallelepiped on KQ as base and with height h ; the prism (3) is equal to a parallelepiped with NP as base and height h ; and finally the pyramid (4) is equal to a parallelepiped of height h and one-third of RC as base.

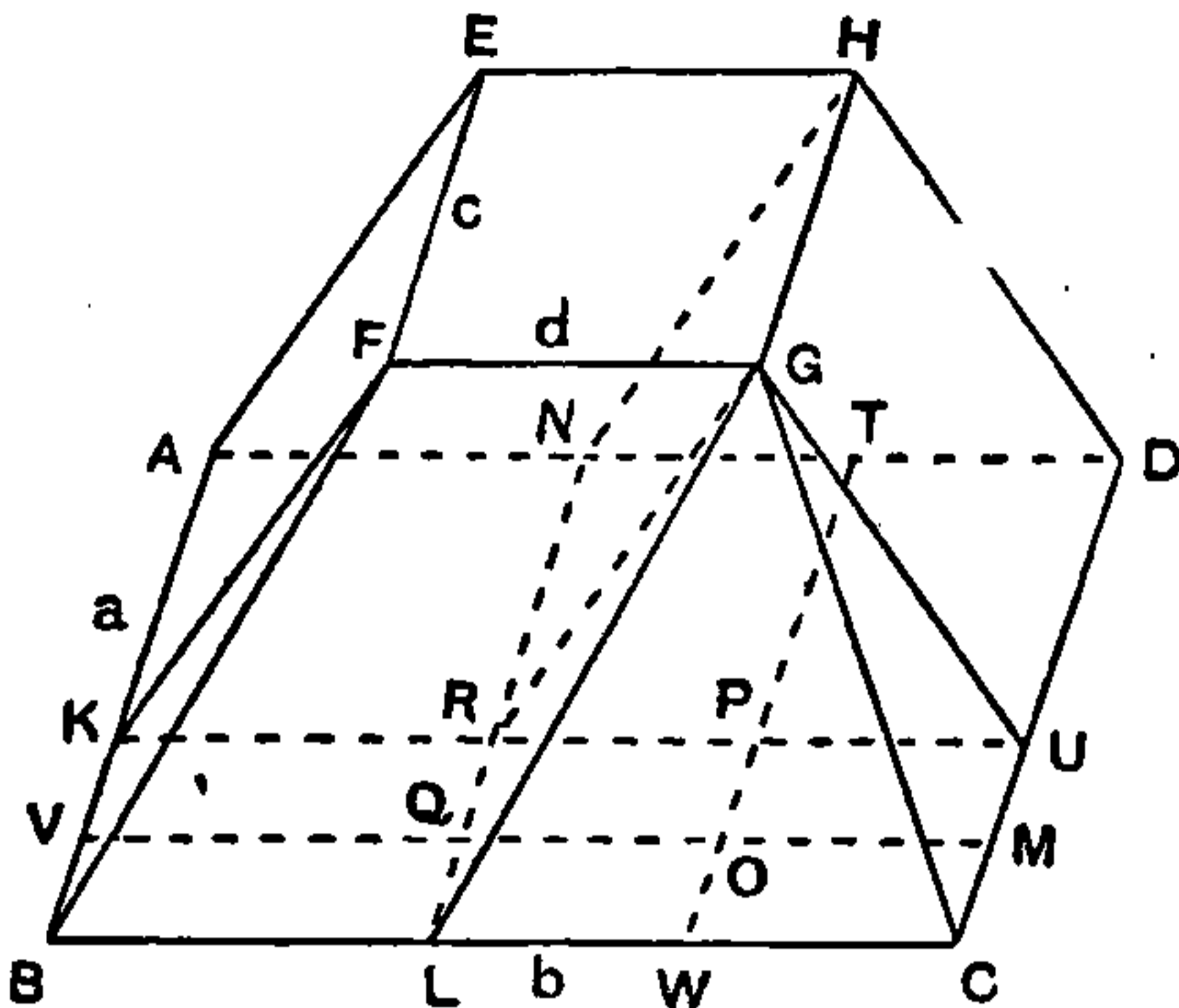

Therefore the whole solid is equal to one parallelepiped with height h and base equal to $(AR + KQ + NP + RO + \frac{1}{3}RO)$ or $AO + \frac{1}{3}RO$.

Now, if $AB = a$, $BC = b$, $EF = c$, $FG = d$,

$AV = \frac{1}{2}(a + c)$, $AT = \frac{1}{2}(b + d)$, $RQ = \frac{1}{2}(a - c)$, $RP = \frac{1}{2}(b - d)$.

Therefore volume of solid

$$= \left\{ \frac{1}{4}(a + c)(b + d) + \frac{1}{12}(a - c)(b - d) \right\} h.$$

The solid in question is evidently the true $\beta\omega\mu\acute{\iota}\sigma\kappa\omicron\varsigma$ ('little altar'), for the formula is used to calculate the content of a $\beta\omega\mu\acute{\iota}\sigma\kappa\omicron\varsigma$ in *Stereom.* II. 40 (68, Heib.) It is also, I think, the $\sigma\phi\eta\nu\acute{\iota}\sigma\kappa\omicron\varsigma$ ('little wedge'), a measurement of which is given in *Stereom.* I. 26 (25, Heib.) It is true that the second term of the first factor $\frac{1}{12}(a - c)(b - d)$ is there neglected, perhaps because in the case taken ($a = 7$, $b = 6$, $c = 5$, $d = 4$) this term ($= \frac{1}{3}$) is small compared with the other ($= 30$). A particular $\sigma\phi\eta\nu\acute{\iota}\sigma\kappa\omicron\varsigma$, in which either $c = a$ or $d = b$, was called $\delta\nu\nu\xi$; the second term in the factor of the content vanishes in this case, and, if e.g. $c = a$, the content is $\frac{1}{2}(b + d)ah$. Another $\beta\omega\mu\acute{\iota}\sigma\kappa\omicron\varsigma$ is measured in *Stereom.* I. 35 (34, Heib.), where the solid is inaccurately called 'a pyramid oblong ($\acute{\epsilon}\tau\epsilon\rho\omicron\mu\acute{\eta}\kappa\eta\varsigma$) and truncated ($\kappa\acute{\omicron}\lambda\omicron\upsilon\rho\omicron\varsigma$) or half-perfect'.



THIS PAGE IS LOCKED TO FREE MEMBERS

Purchase full membership to immediately unlock this page

DELVE INTO FANTASY, MAGIC, MYTHOLOGY & FOLKLORE

Forgotten Books'
Full Membership gives
access to 797,885 ancient
and modern, fiction and
non-fiction books.

Continue

*Fair usage policy applies

describing circle and the length of the path of its centre. For, he says, since 14 is a radius (of the path of the centre), 28 is its diameter and 88 its circumference. 'If then the tore be straightened out and made into a cylinder, it will have 88 for its length, and the diameter of the base of the cylinder is 12; so that the solid content of the cylinder is, as we have seen, $9956\frac{4}{7}$ ' ($= 88 \cdot \frac{11}{4} \cdot 144$).

(ε) *The two special solids of Archimedes's 'Method'.*

Chaps. 14, 15 give the measurement of the two remarkable solids of Archimedes's *Method*, following Archimedes's results.

(ζ) *The five regular solids.*

In chaps. 16-18 Heron measures the content of the five regular solids after the cube. He has of course in each case to find the perpendicular from the centre of the circumscribing sphere on any face. Let p be this perpendicular, a the edge of the solid, r the radius of the circle circumscribing any face. Then (1) for the *tetrahedron*

$$a^2 = 3r^2, p^2 = a^2 - \frac{1}{3}a^2 = \frac{2}{3}a^2.$$

(2) In the case of the *octahedron*, which is the sum of two equal pyramids on a square base, the content is one-third of that base multiplied by the diagonal of the figure, i.e. $\frac{1}{3} \cdot a^2 \cdot \sqrt{2}a$ or $\frac{1}{3}\sqrt{2} \cdot a^3$; in the case taken $a = 7$, and Heron takes 10 as an approximation to $\sqrt{(2 \cdot 7^2)}$ or $\sqrt{98}$, the result being $\frac{1}{3} \cdot 10 \cdot 49$ or $163\frac{1}{3}$. (3) In the case of the *icosahedron* Heron merely says that

$$p : a = 93 : 127 \left(\text{the real value of the ratio is } \frac{1}{2} \sqrt{\frac{7 + 3\sqrt{5}}{6}} \right).$$

(4) In the case of the *dodecahedron*, Heron says that $p : a = 9 : 8$ (the true value is $\frac{1}{2} \sqrt{\frac{25 + 11\sqrt{5}}{10}}$, and, if $\sqrt{5}$ is put equal to $\frac{9}{4}$, Heron's ratio is readily obtained).

Book II ends with an allusion to the method attributed to Archimedes for measuring the contents of irregular bodies by immersing them in water and measuring the amount of fluid displaced.

Book III. Divisions of figures.

This book has much in common with Euclid's book *On divisions (of figures)*, the problem being to divide various figures, plane or solid, by a straight line or plane into parts having a given ratio. In III. 1–3 a triangle is divided into two parts in a given ratio by a straight line (1) passing through a vertex, (2) parallel to a side, (3) through any point on a side. III. 4 is worth description: 'Given a triangle ABC , to cut out of it a triangle DEF (where D, E, F are points on the sides respectively) given in magnitude and such that the triangles AEF, BFD, CED may be equal in area.' Heron assumes that, if D, E, F divide the sides so that

$$AF:FB = BD:DC = CE:EA,$$

the latter three triangles are equal in area.

He then has to find the value of each of the three ratios which will result in the triangle DEF having a given area.

Join AD .

Since $BD:CD = CE:EA$,

$$BC:CD = CA:AE,$$

and $\triangle ABC:\triangle ADC = \triangle ADC:\triangle ADE$.

Also $\triangle ABC:\triangle ABD = \triangle ADC:\triangle EDC$.

But (since the area of the triangle DEF is given) $\triangle EDC$ is given, as well as $\triangle ABC$. Therefore $\triangle ABD \times \triangle ADC$ is given.

Therefore, if AH be perpendicular to BC ,

$$AH^2 \cdot BD \cdot DC \text{ is given;}$$

therefore $BD \cdot DC$ is given, and, since BC is given, D is given in position (we have to apply to BC a rectangle equal to $BD \cdot DC$ and falling short by a square).

As an example Heron takes $AB = 13, BC = 14, CA = 15, \triangle DEF = 24$. $\triangle ABC$ is then 84, and $AH = 12$.

Thus $\triangle EDC = 20$, and $AH^2 \cdot BD \cdot DC = 4 \cdot 84 \cdot 20 = 6720$; therefore $BD \cdot DC = 6720/144$ or $46\frac{2}{3}$ (the text omits the $\frac{2}{3}$).

Therefore, says Heron, $BD = 8$ approximately. For 8 we

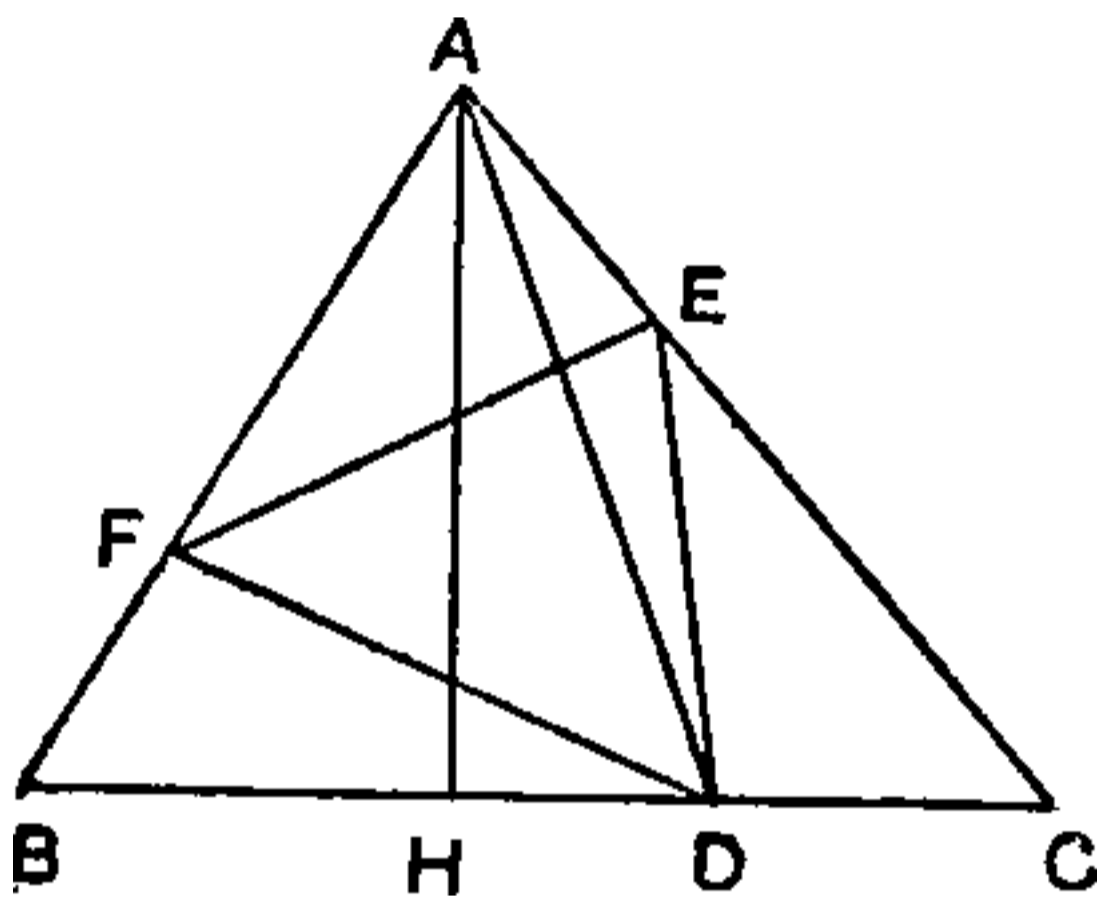

should apparently have $8\frac{1}{2}$, since DC is immediately stated to be $5\frac{1}{2}$ (not 6). That is, in solving the equation

$$x^2 - 14x + 46\frac{2}{3} = 0,$$

which gives $x = 7 \pm \sqrt{(2\frac{1}{3})}$, Heron apparently substituted $2\frac{1}{4}$ or $\frac{9}{4}$ for $2\frac{1}{3}$, thereby obtaining $1\frac{1}{2}$ as an approximation to the surd.

(The lemma assumed in this proposition is easily proved. Let $m:n$ be the ratio $AF:FB = BD:DC = CE:EA$.

Then $AF = mc/(m+n)$, $FB = nc/(m+n)$, $CE = mb/(m+n)$,

$$EA = nb/(m+n), \text{ \&c.}$$

Hence

$$\Delta AFE / \Delta ABC = \frac{mn}{(m+n)^2} = \Delta BDF / \Delta ABC = \Delta CDE / \Delta ABC,$$

and the triangles AFE , BDF , CDE are equal.

Pappus¹ has the proposition that the triangles ABC , DEF have the same centre of gravity.)

Heron next shows how to divide a parallel-trapezium into two parts in a given ratio by a straight line (1) through the point of intersection of the non-parallel sides, (2) through a given point on one of the parallel sides, (3) parallel to the parallel sides, (4) through a point on one of the non-parallel sides (III. 5-8). III. 9 shows how to divide the area of a circle into parts which have a given ratio by means of an inner circle with the same centre. For the problems beginning with III. 10 Heron says that numerical calculation alone no longer suffices, but geometrical methods must be applied. Three problems are reduced to problems solved by Apollonius in his treatise *On cutting off an area*. The first of these is III. 10, to cut off from the angle of a triangle a given proportion of the triangle by a straight line through a point on the opposite side produced. III. 11, 12, 13 show how to cut any quadrilateral into parts in a given ratio by a straight line through a point (1) on a side (a) dividing the side in the given ratio, (b) not so dividing it, (2) not on any side, (a) in the case where the quadrilateral is a trapezium, i.e. has two sides parallel, (b) in the case where it is not; the last case (b) is reduced (like III. 10) to the 'cutting-off' of an

¹ Pappus, viii, pp. 1034-8. Cf. pp. 430-2 *post*.



THIS PAGE IS LOCKED TO FREE MEMBERS

Purchase full membership to immediately unlock this page

FORGOTTEN BOOKS

FULL

MEMBERSHIP

797,885 Books!

All you can read

for only

\$8.99/month

Continue

*Fair usage policy applies



two opposite sides which the required straight line cuts are (a) parallel or (b) not parallel. In the first case (a) the problem reduces to drawing a straight line through E intersecting the parallel sides in points F, G such that $BF + AG$

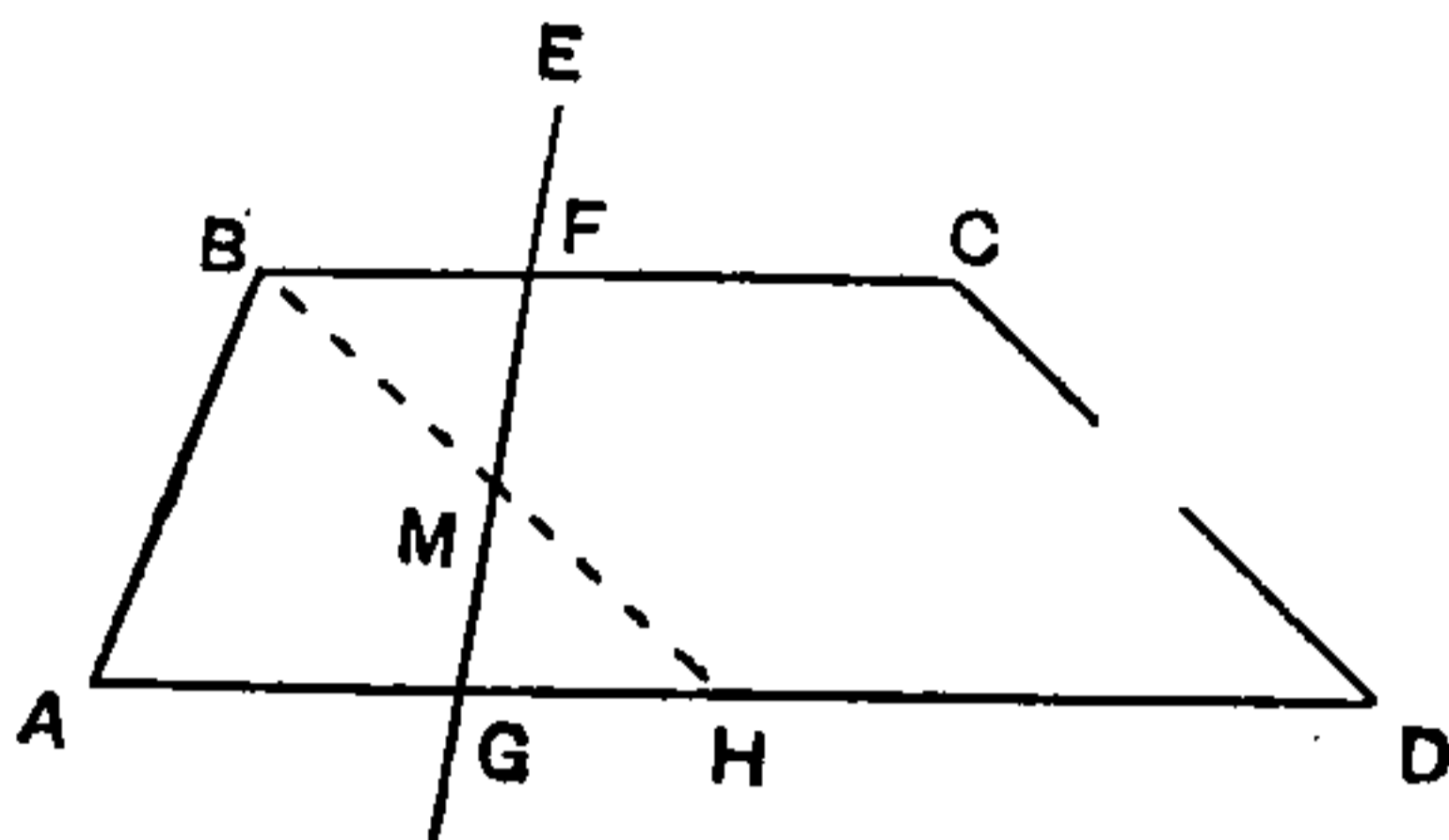

is equal to a given length. In the second case (b) where BC, AD are not parallel Heron supposes them to meet in H . The angle at H is then given, and the area ABH . It is then a question of cutting off from a triangle with vertex H a triangle HFG of given area by a straight line drawn from E , which is again a problem in Apollonius's *Cutting-off of an*

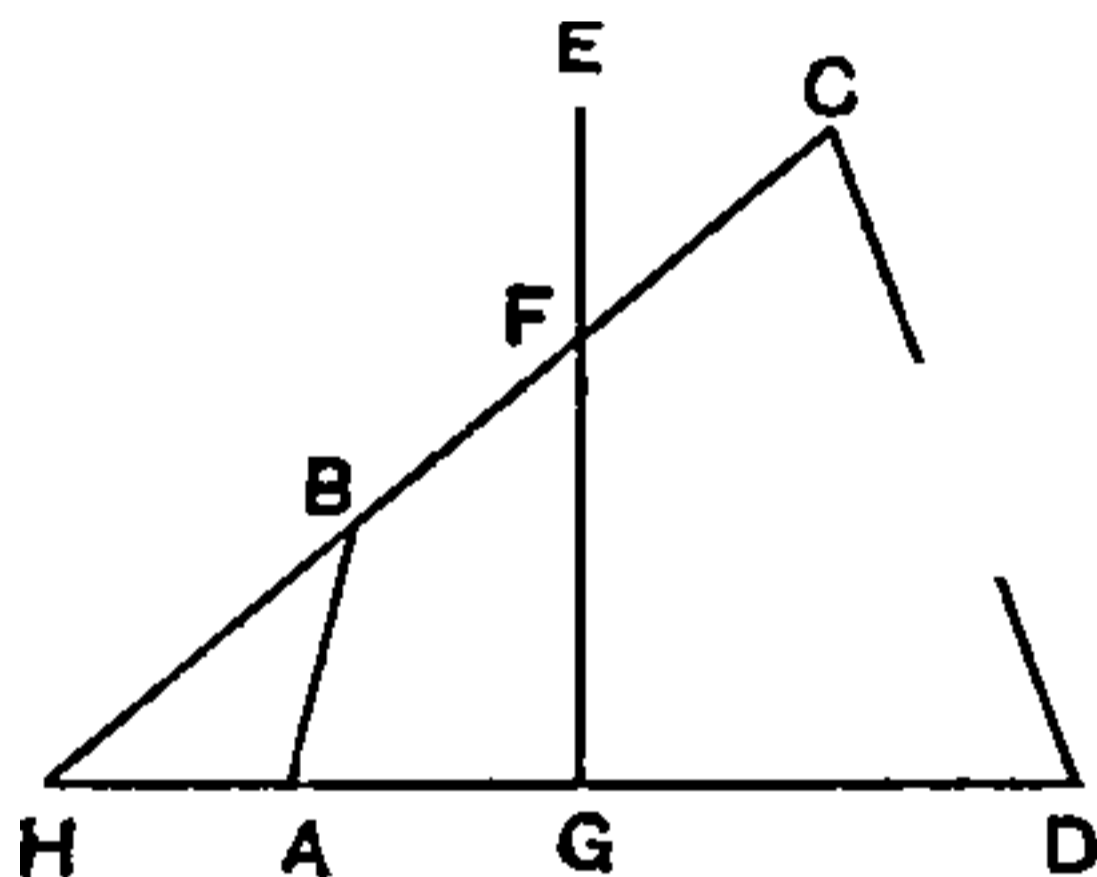

area. The auxiliary problem in case (a) is easily solved in III. 16. Measure AH equal to the given length. Join BH and bisect it at M . Then EM meets BC, AD in points such that $BF + AG =$ the given length. For, by congruent triangles, $BF = GH$.

The same problems are solved for the case of any polygon in III. 14, 15. A sphere is then divided (III. 17) into segments such that their surfaces are in a given ratio, by means of Archimedes, *On the Sphere and Cylinder*, II. 3, just as, in III. 23, Prop. 4 of the same Book is used to divide a sphere into segments having their volumes in a given ratio.

III. 18 is interesting because it recalls an ingenious proposition in Euclid's book *On Divisions*. Heron's problem is 'To divide a given circle into three equal parts by two straight

lines', and he observes that, 'as the problem is clearly not rational, we shall, for practical convenience, make the division,

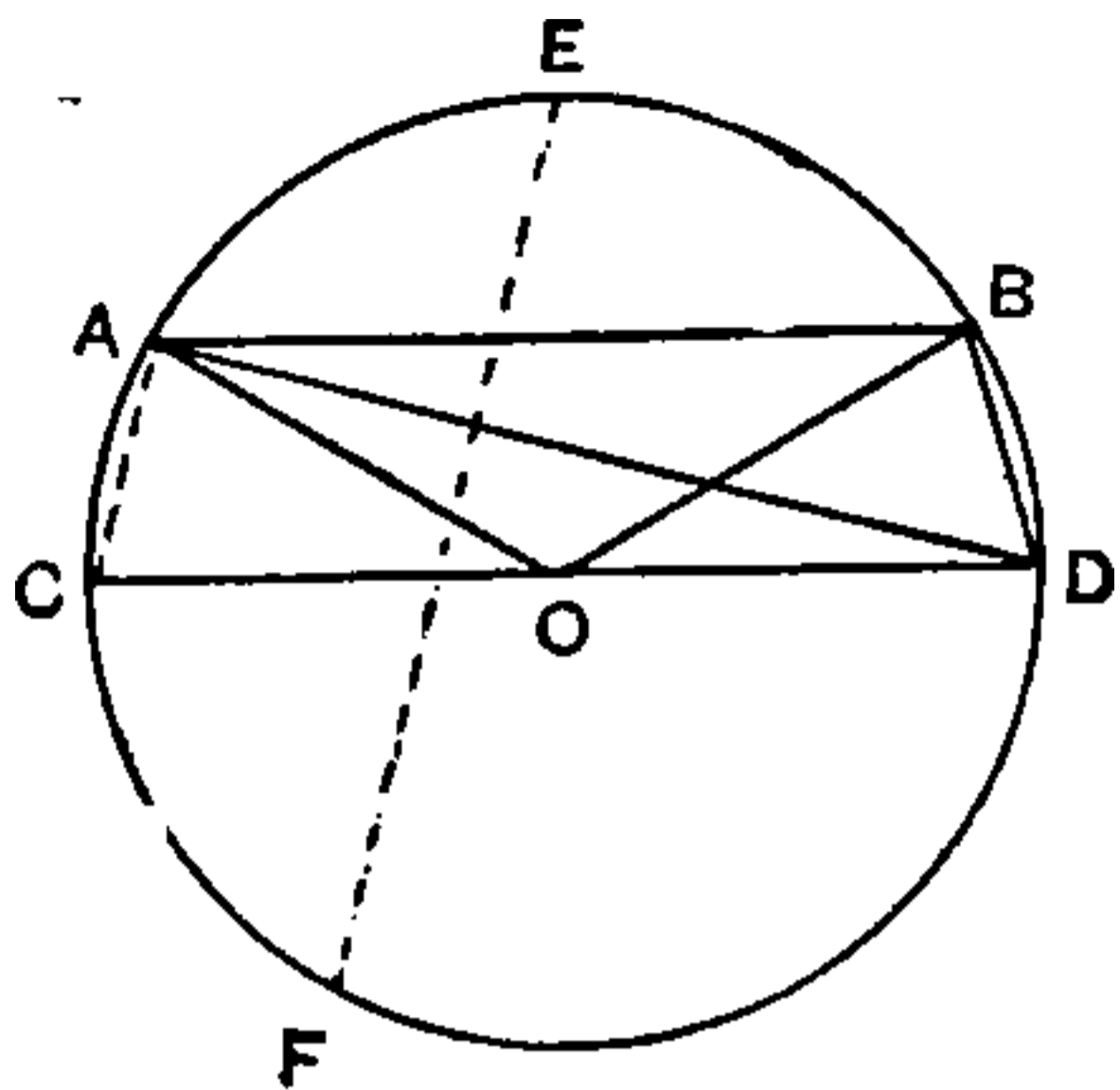

as exactly as possible, in the following way.' AB is the side of an equilateral triangle inscribed in the circle. Let CD be the parallel diameter, O the centre of the circle, and join AO , BO , AD , DB . Then shall the segment ABD be very nearly one-third of the circle. For, since AB is the side of an equilateral triangle in the circle, the sector OAE is one-third of the

circle. And the triangle AOB forming part of the sector is equal to the triangle ADB ; therefore the segment AEB plus the triangle ABD is equal to one-third of the circle, and the segment ABD only differs from this by the small segment on BD as base, which may be neglected. Euclid's proposition is to cut off one-third (or any fraction) of a circle between two parallel chords (see vol. i, pp. 429-30).

III. 19 finds a point D within any triangle ABC such that the triangles DBC , DCA , DAB are all equal; and then Heron passes to the division of solid figures.

The solid figures divided in a given ratio (besides the sphere) are the pyramid with base of any form (III. 20), the cone (III. 21) and the frustum of a cone (III. 22), the cutting planes being parallel to the base in each case. These problems involve the extraction of the cube root of a number which is in general not an exact cube, and the point of interest is Heron's method of approximating to the cube root in such a case. Take the case of the cone, and suppose that the portion to be cut off at the top is to the rest of the cone as m to n . We have to find the ratio in which the height or the edge is cut by the plane parallel to the base which cuts the cone in the given ratio. The volume of a cone being $\frac{1}{3}\pi c^2 h$, where c is the radius of the base and h the height, we have to find the height of the cone the volume of which

is $\frac{m}{m+n} \cdot \frac{1}{3}\pi c^2 h$, and, as the height h' is to the radius c' of its base as h is to c , we have simply to find h' where

$h'^3/h^3 = m/(m+n)$. Or, if we take the edges e, e' instead of the heights, $e'^3/e^3 = m/(m+n)$. In the case taken by Heron $m:n = 4:1$, and $e = 5$. Consequently $e'^3 = \frac{4}{5} \cdot 5^3 = 100$. Therefore, says Heron, $e' = 4\frac{9}{14}$ approximately, and in III. 20 he shows how this is arrived at.

Approximation to the cube root of a non-cube number.

'Take the nearest cube numbers to 100 both above and below; these are 125 and 64.

Then $125 - 100 = 25$,
and $100 - 64 = 36$.

Multiply 5 into 36; this gives 180. Add 100, making 280. (Divide 180 by 280); this gives $\frac{9}{14}$. Add this to the side of the smaller cube: this gives $4\frac{9}{14}$. This is as nearly as possible the cube root ("cubic side") of 100 units.'

We have to conjecture Heron's formula from this example. Generally, if $a^3 < A < (a+1)^3$, suppose that $A - a^3 = d_1$, and $(a+1)^3 - A = d_2$. The best suggestion that has been made is Wertheim's,¹ namely that Heron's formula for the approxi-

mate cube root was $a + \frac{(a+1)d_1}{(a+1)d_1 + ad_2}$. The 5 multiplied into the 36 might indeed have been the square root of 25 or $\sqrt{d_2}$, and the 100 added to the 180 in the denominator of the fraction might have been the original number 100 (A) and not $4 \cdot 25$ or ad_2 , but Wertheim's conjecture is the more satisfactory because it can be evolved out of quite elementary considerations. This is shown by G. Eneström as follows.² Using the same notation, Eneström further supposes that x is the exact value of $\sqrt[3]{A}$ and that $(x-a)^3 = \delta_1$, $(a+1-x)^3 = \delta_2$.

Thus

$$\delta_1 = x^3 - 3x^2a + 3xa^2 - a^3, \text{ and } 3ax(x-a) = x^3 - a^3 - \delta_1 = d_1 - \delta_1.$$

Similarly from $\delta_2 = (a+1-x)^3$ we derive

$$3(a+1)x(a+1-x) = (a+1)^3 - x^3 - \delta_2 = d_2 - \delta_2.$$

Therefore

$$\begin{aligned} \frac{d_2 - \delta_2}{d_1 - \delta_1} &= \frac{3(a+1)x(a+1-x)}{3ax(x-a)} = \frac{(a+1)\{1-(x-a)\}}{a(x-a)} \\ &= \frac{a+1}{a(x-a)} - \frac{a+1}{a}; \end{aligned}$$

¹ *Zeitschr. f. Math. u. Physik*, xliv, 1899, hist.-litt. Abt., pp. 1-3.

² *Bibliotheca Mathematica*, viii, 1907-8, pp. 412-13.



THIS PAGE IS LOCKED TO FREE MEMBERS

Purchase full membership to immediately unlock this page

DELVE INTO FANTASY, MAGIC, MYTHOLOGY & FOLKLORE

Forgotten Books'
Full Membership gives
access to 797,885 ancient
and modern, fiction and
non-fiction books.

Continue

*Fair usage policy applies

Since $(DG) : (FB) = m : n,$
 $(DB) : (DG) = (m + n) : m.$

Now

$$(DB) = \frac{1}{2} \pi h (a^2 + aa' + a'^2),$$

and $(DG) = \frac{m}{m+n} (DB).$

Let y be the height (CM) of the cone CFG .

Then $DH : AH = CK : KA,$

or $h : \frac{1}{2} (a - a') = (x + h) : \frac{1}{2} a,$

whence x is known.

Cone $CDE = \frac{1}{2} \pi a'^2 x,$

cone $CFG = (CDE) + \frac{m}{m+n} (DB),$

cone $CAB = (CDE) + (DB).$

Now, says Heron,

$$\frac{(CAB) + (CDE)}{(CFG)} = \frac{(x+h)^3 + x^3}{y^3}.$$

[He might have said simply

$$(CDE) : (CFG) = x^3 : y^3.]$$

This gives y or $CM,$

whence LM is known.

Now $AD^2 = AH^2 + DH^2$
 $= \left\{ \frac{1}{2} (a - a') \right\}^2 + h^2,$

so that AD is known.

Therefore $DF = \frac{y-x}{h} \cdot AD$ is

known.

$$(DG) : (FB) = 4 : 1,$$

$$(DB) : (DG) = 5 : 4.$$

$$(DB) = 5698,$$

$$(DG) = 4558 \frac{2}{5}.$$

$$x + h = \frac{14 \cdot 12}{3 \frac{1}{2}} = 48,$$

and $x = 48 - 12 = 36.$

(cone CDE) = 4158,

(cone CFG) = 4158 + 4558 $\frac{2}{5}$ = 8

(cone CAB) = 4158 + 5698 =

$$y^3 = \frac{8716 \frac{2}{5}}{9856 + 4158} \cdot (48^3 + 36^3)$$

$$= 8716 \frac{2}{5} \cdot \frac{157248}{14014} = 978$$

whence $y = 46$ approximately

Therefore $LM = y - x = 10$

$$AD^2 = (3 \frac{1}{2})^2 + 12^2$$

$$= 156 \frac{1}{4},$$

and $AD = 12 \frac{1}{2}.$

Therefore $DF = \frac{10}{1 \frac{1}{2}} \cdot 12 \frac{1}{2}$
 $= 10 \frac{5}{1 \frac{1}{2}}.$

Quadratic equations solved in Heron.

We have already met with one such equation (in *Metrica* III. 4), namely $x^2 - 14x + 46\frac{2}{3} = 0$, the result only ($x = 8\frac{1}{2}$) being given. There are others in the *Geometrica* where the process of solution is shown.

(1) *Geometrica* 24, 3 (Heib.). 'Given a square such that the sum of its area and perimeter is 896 feet: to separate the area from the perimeter': i.e. $x^2 + 4x = 896$. Heron takes half of 4 and adds its square, completing the square on the left side.

(2) *Geometrica* 21, 9 and 24, 46 (Heib.) give one and the same equation, *Geom.* 24, 47 another like it. 'Given the sum of the diameter, perimeter and area of a circle, to find each of them.'

The two equations are

$$\frac{11}{14}d^2 + \frac{29}{7}d = 212,$$

and

$$\frac{11}{14}d^2 + \frac{29}{7}d = 67\frac{1}{2}.$$

Our usual method is to begin by dividing by $\frac{1}{14}$ throughout, so as to leave d^2 as the first term. Heron's is to *multiply* by such a number as will leave a square as the first term. In this case he multiplies by 154, giving $11^2d^2 + 58 \cdot 11d = 212 \cdot 154$ or $67\frac{1}{2} \cdot 154$ as the case may be. Completing the square, he obtains $(11d + 29)^2 = 32648 + 841$ or $10395 + 841$. Thus $11d + 29 = \sqrt{(33489)}$ or $\sqrt{(11236)}$, that is, 183 or 106. Thus $11d = 154$ or 77 , and $d = 14$ or 7 , as the case may be.

Indeterminate problems in the Geometrica.

Some very interesting indeterminate problems are now included by Heiberg in the *Geometrica*.¹ Two of them (chap. 24, 1-2) were included in the *Geëponicus* in Hultsch's edition (sections 78, 79); the rest are new, having been found in the Constantinople manuscript from which Schöne edited the *Metrica*. As, however, these problems, to whatever period they belong, are more akin to algebra than to mensuration, they will be more properly described in a later chapter on Algebra.

¹ *Heronis Alexandrini opera*, vol. iv, p. 414. 28 sq.

The *Dioptra* (περὶ διόπτρας).

This treatise begins with a careful description of the *dioptra*, an instrument which served with the ancients for the same purpose as a theodolite with us (chaps. 1–5). The problems with which the treatise goes on to deal are (a) problems of ‘heights and distances’, (b) engineering problems, (c) problems of mensuration, to which is added (chap. 34) a description of a ‘hodometer’, or taxameter, consisting of an arrangement of toothed wheels and endless screws on the same axes working on the teeth of the next wheels respectively. The book ends with the problem (chap. 37), ‘With a given force to move a given weight by means of interacting toothed wheels’, which really belongs to mechanics, and was apparently added, like some other problems (e.g. 31, ‘to measure the outflow of, i.e. the volume of water issuing from, a spring’), in order to make the book more comprehensive. The essential problems dealt with are such as the following. To determine the difference of level between two given points (6), to draw a straight line connecting two points the one of which is not visible from the other (7), to measure the least breadth of a river (9), the distance of two inaccessible points (10), the height of an inaccessible point (12), to determine the difference between the heights of two inaccessible points and the position of the straight line joining them (13), the depth of a ditch (14); to bore a tunnel through a mountain going straight from one mouth to the other (15), to sink a shaft through a mountain perpendicularly to a canal flowing underneath (16); given a subterranean canal of any form, to find on the ground above a point from which a vertical shaft must be sunk in order to reach a given point on the canal (for the purpose e.g. of removing an obstruction) (20); to construct a harbour on the model of a given segment of a circle, given the ends (17), to construct a vault so that it may have a spherical surface modelled on a given segment (18). The mensuration problems include the following: to measure an irregular area, which is done by inscribing a rectilinear figure and then drawing perpendiculars to the sides at intervals to meet the contour (23), or by drawing one straight line across the area and erecting perpendiculars from



THIS PAGE IS LOCKED TO FREE MEMBERS

Purchase full membership to immediately unlock this page

FORGOTTEN BOOKS

FULL

MEMBERSHIP

797,885 Books!

All you can read

for only

\$8.99/month

Continue

*Fair usage policy applies



the first chapter or chapters of the real *Mechanics* which had been lost. The treatise would doubtless begin with generalities introductory to mechanics such as we find in the (much interpolated) beginning of Pappus, Book VIII. It must then apparently have dealt with the properties of circles, cylinders, and spheres with reference to their importance in mechanics; for in Book II. 21 Heron says that the circle is of all figures the most movable and most easily moved, the same thing applying also to the cylinder and sphere, and he adds in support of this a reference to a proof 'in the preceding Book'. This reference may be to I. 21, but at the end of that chapter he says that 'cylinders, even when heavy, if placed on the ground so that they touch it in one line only, are easily moved, and the same is true of spheres also, a matter *which we have already discussed*'; the discussion may have come earlier in the Book, in a chapter now lost.

The treatise, beginning with chap. 2 after the passage interpolated from the *Βαρουλκός*, is curiously disconnected. Chaps. 2–7 discuss the motion of circles or wheels, equal or unequal, moving on different axes (e.g. interacting toothed wheels), or fixed on the same axis, much after the fashion of the Aristotelian *Mechanical problems*.

Aristotle's Wheel.

In particular (chap. 7) Heron attempts to explain the puzzle of the 'Wheel of Aristotle', which remained a puzzle up to quite modern times, and gave rise to the proverb, 'rotam Aristotelis magis torquere, quo magis torqueretur'.¹ 'The question is', says the Aristotelian problem 24, 'why does the greater circle roll an equal distance with the lesser circle when they are placed about the same centre, whereas, when they roll separately, as the size of one is to the size of the other, so are the straight lines traversed by them to one another?'² Let AC , BD be quadrants of circles with centre O bounded by the same radii, and draw tangents AE , BF at A and B . In the first case suppose the circle BD to roll along BF till D takes the position H ; then the radius ODC will be at right angles to AE , and C will be at G , a point such that AG is equal to BH . In the second

¹ See Van Capelle, *Aristotelis quaestiones mechanicae*, 1812, p. 263 sq.

² Arist. *Mechanica*, 855 a 28.

case suppose the circle AC to roll along AE till ODC takes the position $O'FE$; then D will be at F where $AE = BF$. And similarly if a whole revolution is performed and OBA is again perpendicular to AE . Contrary, therefore, to the principle that the greater circle moves quicker than the smaller on the same axis, it would appear that the movement of the

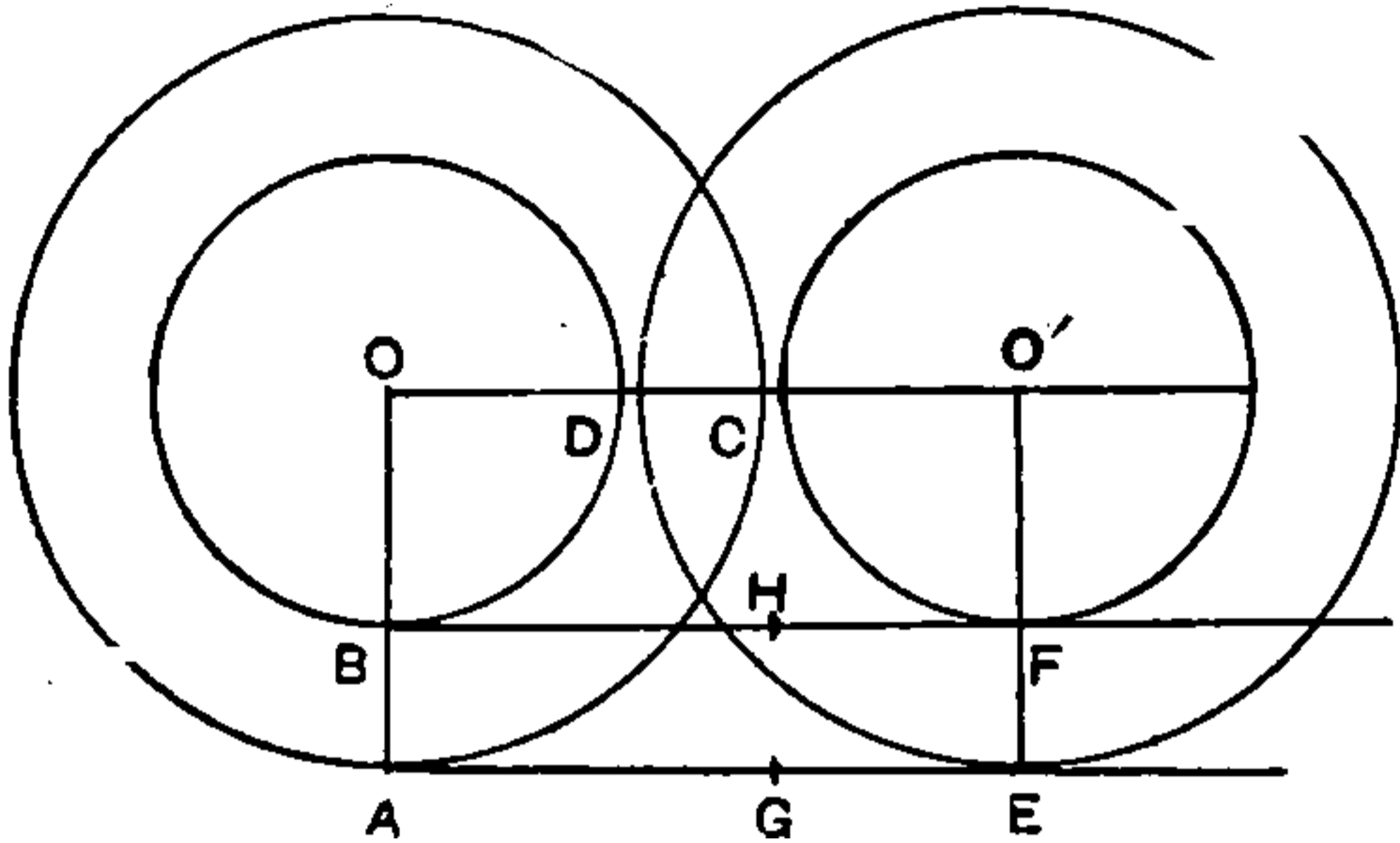

smaller in this case is as quick as that of the greater, since $BH = AG$, and $BF = AE$. Heron's explanation is that, e.g. in the case where the larger circle rolls on AE , the lesser circle maintains the same speed as the greater because it has *two* motions; for if we regard the smaller circle as merely fastened to the larger, and not rolling at all, its centre O will move to O' traversing a distance OO' equal to AE and BF ; hence the greater circle will take the lesser with it over an equal distance, the rolling of the lesser circle having no effect upon this. *

The parallelogram of velocities.

Heron next proves the parallelogram of velocities (chap. 8); he takes the case of a rectangle, but the proof is applicable generally.

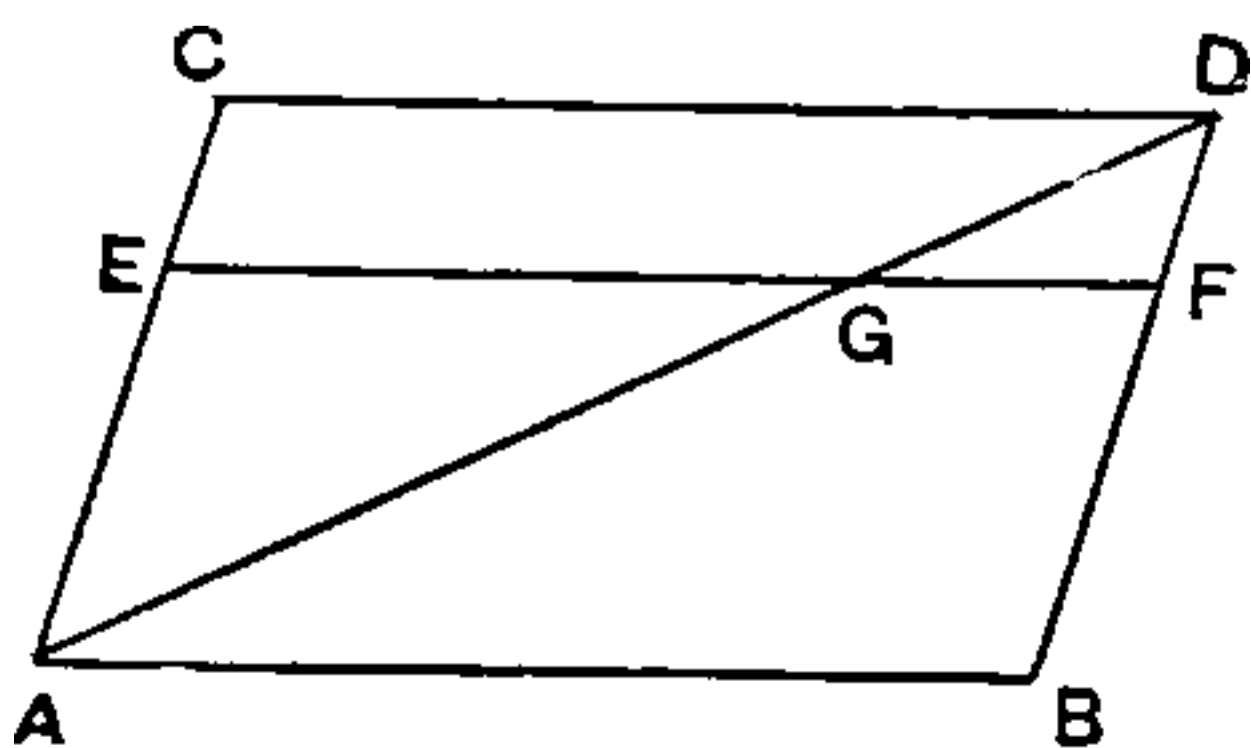

Suppose that, when the point arrives at B , the straight line

The way it is put is this. A point moves with uniform velocity along a straight line AB , from A to B , while at the same time AB moves with uniform velocity always parallel to itself with its extremity A describing the straight line AC .

reaches the position CD . Let EF be any intermediate position of AB , and G the position at the same instant of the moving point on it. Then clearly $AE:AC = EG:EF$; therefore $AE:EG = AC:EF = AC:CD$, and it follows that G lies on the diagonal AD , which is therefore the actual path of the moving point.

Chaps. 9–19 contain a digression on the construction of plane and solid figures similar to given figures but greater or less in a given ratio. Heron observes that the case of plane figures involves the finding of a mean proportional between two straight lines, and the case of solid figures the finding of *two* mean proportionals; in chap. 11 he gives his solution of the latter problem, which is preserved in Pappus and Eutocius as well, and has already been given above (vol. i, pp. 262–3).

The end of chap. 19 contains, quite inconsequently, the construction of a toothed wheel to move on an endless screw, after which chap. 20 makes a fresh start with some observations on weights in equilibrium on a horizontal plane but tending to fall when the plane is inclined, and on the ready mobility of objects of cylindrical form which touch the plane in one line only.

Motion on an inclined plane.

When a weight is hanging freely by a rope over a pulley, no force applied to the other end of the rope less than the weight itself will keep it up, but, if the weight is placed on an inclined plane, and both the plane and the portion of the weight in contact with it are smooth, the case is different. Suppose, e.g., that a weight in the form of a cylinder is placed on an inclined plane so that the line in which they touch is horizontal; then the force required to be applied to a rope parallel to the line of greatest slope in the plane in order to keep the weight in equilibrium is less than the weight. For the vertical plane passing through the line of contact between the cylinder and the plane divides the cylinder into two unequal parts, that on the downward side of the plane being the greater, so that the cylinder will tend to roll down; but the force required to support the cylinder is the 'equivalent', not of the weight of the whole cylinder, but of the difference



THIS PAGE IS LOCKED TO FREE MEMBERS

Purchase full membership to immediately unlock this page

DELVE INTO FANTASY, MAGIC, MYTHOLOGY & FOLKLORE

Forgotten Books'
Full Membership gives
access to 797,885 ancient
and modern, fiction and
non-fiction books.

Continue

*Fair usage policy applies

Supports'. As, however, the principles are the same whether the body is supported or hung up, it does not follow that this was a different work from that known as *περὶ ζυγῶν*. Chaps. 32-3, which are on the principles of the lever or of weighing, end with an explanation amounting to the fact that 'greater circles overpower smaller when their movement is about the same centre', a proposition which Pappus says that Archimedes proved in his work *περὶ ζυγῶν*.¹ In chap. 32, too, Heron gives as his authority a proof given by Archimedes in the same work. With I. 33 may be compared II. 7, where Heron returns to the same subject of the greater and lesser circles moving about the same centre and states the fact that weights reciprocally proportional to their radii are in equilibrium when suspended from opposite ends of the horizontal diameters, observing that Archimedes proved the proposition in his work 'On the equalization of inclination' (presumably *ἰσορροπίαι*).

Book II. The five mechanical powers.

Heron deals with the wheel and axle, the lever, the pulley, the wedge and the screw, and with combinations of these powers. The description of the powers comes first, chaps. 1-6, and then, after II. 7, the proposition above referred to, and the theory of the several powers based upon it (chaps. 8-20). Applications to specific cases follow. Thus it is shown how to move a weight of 1000 talents by means of a force of 5 talents, first by the system of wheels described in the *Βαρουλκός*, next by a system of pulleys, and thirdly by a combination of levers (chaps. 21-5). It is possible to combine the different powers (other than the wedge) to produce the same result (chap. 29). The wedge and screw are discussed with reference to their angles (chaps. 30-1). and chap. 32 refers to the effect of friction.

Mechanics in daily life; queries and answers.

After a prefatory chapter (33), a number of queries resembling the Aristotelian problems are stated and answered (chap. 34), e.g. 'Why do waggons with two wheels carry a weight more easily than those with four wheels?', 'Why

¹ Pappus, viii, p. 1068. 20-3.

do great weights fall to the ground in a shorter time than lighter ones?', 'Why does a stick break sooner when one puts one's knee against it in the middle?', 'Why do people use pincers rather than the hand to draw a tooth?', 'Why is it easy to move weights which are suspended?', and 'Why is it the more difficult to move such weights the farther the hand is away from them, right up to the point of suspension or a point near it?', 'Why are great ships turned by a rudder although it is so small?', 'Why do arrows penetrate armour or metal plates but fail to penetrate cloth spread out?'

Problems on the centre of gravity, &c.

II. 35, 36, 37 show how to find the centre of gravity of a triangle, a quadrilateral and a pentagon respectively. Then, assuming that a triangle of uniform thickness is supported by a prop at each angle, Heron finds what weight is supported by each prop, (a) when the props support the triangle only, (b) when they support the triangle plus a given weight placed at any point on it (chaps. 38, 39). Lastly, if known weights are put on the triangle at each angle, he finds the centre of gravity of the system (chap. 40); the problem is then extended to the case of any polygon (chap. 41).

Book III deals with the practical construction of engines for all sorts of purposes, machines employing pulleys with one, two, or more supports for lifting weights, oil-presses, &c.

The Catoptrica.

This work need not detain us long. Several of the theoretical propositions which it contains are the same as propositions in the so-called *Catoptrica* of Euclid, which, as we have seen, was in all probability the work of Theon of Alexandria and therefore much later in date. In addition to theoretical propositions, it contains problems the purpose of which is to construct mirrors or combinations of mirrors of such shape as will reflect objects in a particular way, e.g. to make the right side appear as the right in the picture (instead of the reverse), to enable a person to see his back or to appear in the mirror head downwards, with face distorted, with three eyes or two noses, and so forth. Concave and convex

cylindrical mirrors play a part in these arrangements. The whole theory of course ultimately depends on the main propositions 4 and 5 that the angles of incidence and reflection are equal whether the mirror is plane or circular.

Heron's proof of equality of angles of incidence and reflection.

Let AB be a plane mirror, C the eye, D the object seen. The argument rests on the fact that nature 'does nothing in vain'. Thus light travels in a straight line, that is, by the quickest road. Therefore, even

when the ray is a line broken at a point by reflection, it must mark the shortest broken line of the kind connecting the eye and the object. Now, says Heron, I maintain that the shortest of the broken lines (broken at the mirror) which connect C and D is the line, as CAD , the parts of which make equal angles with the mirror. Join DA and produce it to meet in F the perpendicular from C to AB . Let B be any point on the mirror other than A , and join FB , BD .

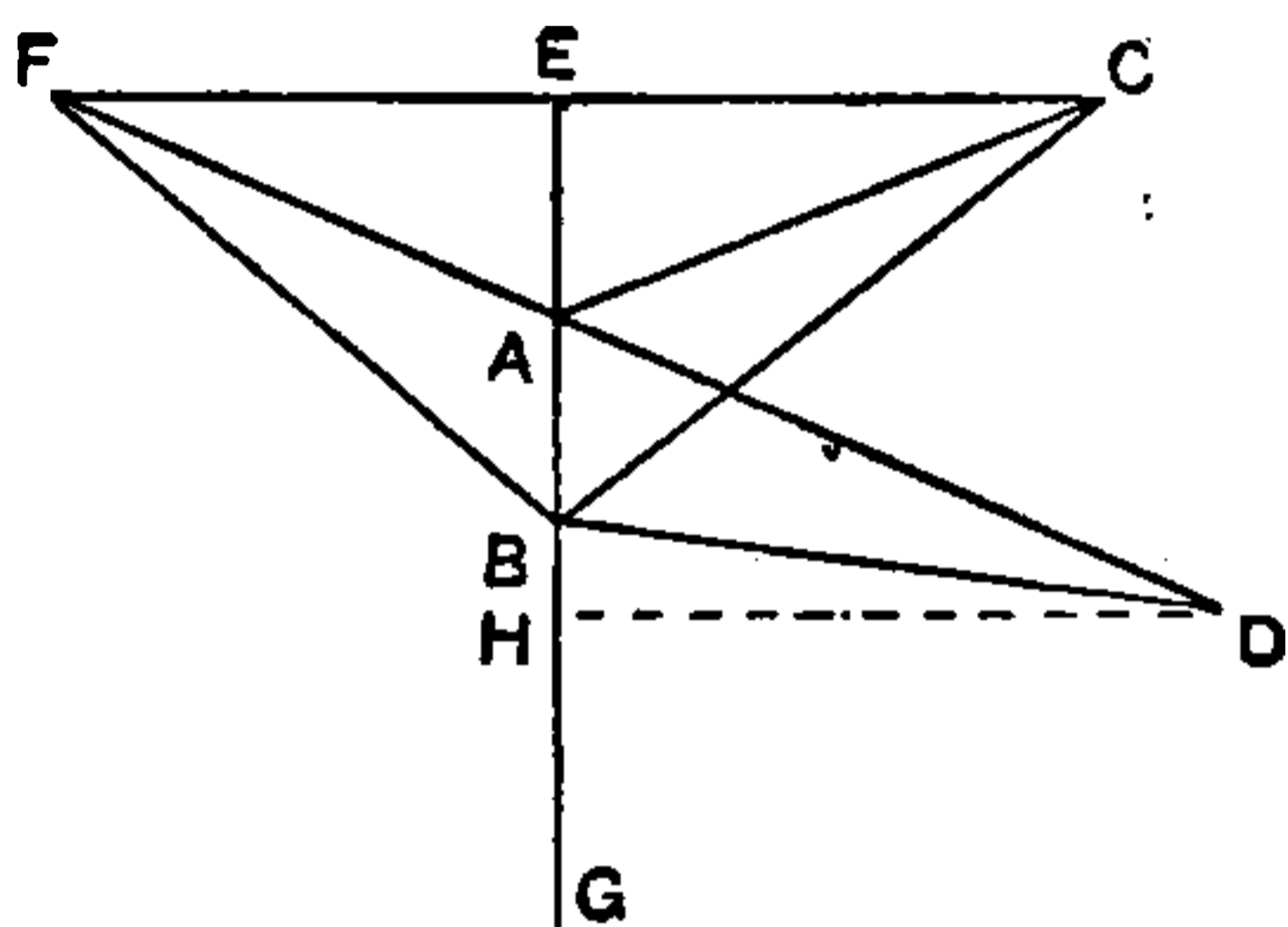

Join DA and produce it to meet in F the perpendicular from C to AB . Let B be any point on the mirror other than A , and join FB , BD .

$$\begin{aligned} \text{Now} \quad \angle EAF &= \angle BAD \\ &= \angle CAE, \text{ by hypothesis.} \end{aligned}$$

Therefore the triangles AEF , AEC , having two angles equal and AE common, are equal in all respects.

Therefore $CA = AF$, and $CA + AD = DF$.

Since $FE = EC$, and BE is perpendicular to FC , $BF = BC$.

Therefore $CB + BD = FB + BD$

$$> FD,$$

$$\text{i.e. } > CA + AD.$$

The proposition was of course known to Archimedes. We gather from a scholium to the Pseudo-Euclidean *Catoptrica* that he proved it in a different way, namely by *reductio ad absurdum*, thus: Denote the angles CAE , DAB by α , β respectively. Then, α is $> =$ or $< \beta$. Suppose $\alpha > \beta$. Then,



THIS PAGE IS LOCKED TO FREE MEMBERS

Purchase full membership to immediately unlock this page

FORGOTTEN BOOKS

FULL

MEMBERSHIP

797,885 Books!

All you can read

for only

\$8.99/month

Continue

*Fair usage policy applies



PAPPUS OF ALEXANDRIA

WE have seen that the Golden Age of Greek geometry ended with the time of Apollonius of Perga. But the influence of Euclid, Archimedes and Apollonius continued, and for some time there was a succession of quite competent mathematicians who, although not originating anything of capital importance, kept up the tradition. Besides those who were known for particular investigations, e.g. of new curves or surfaces, there were such men as Geminus who, it cannot be doubted, were thoroughly familiar with the great classics. Geminus, as we have seen, wrote a comprehensive work of almost encyclopaedic character on the classification and content of mathematics, including the history of the development of each subject. But the beginning of the Christian era sees quite a different state of things. Except in sphaeric and astronomy (Menelaus and Ptolemy), production was limited to elementary textbooks of decidedly feeble quality. In the meantime it would seem that the study of higher geometry languished or was completely in abeyance, until Pappus arose to revive interest in the subject. From the way in which he thinks it necessary to describe the contents of the classical works belonging to the *Treasury of Analysis*, for example, one would suppose that by his time many of them were, if not lost, completely forgotten, and that the great task which he set himself was the re-establishment of geometry on its former high plane of achievement. Presumably such interest as he was able to arouse soon flickered out, but for us his work has an inestimable value as constituting, after the works of the great mathematicians which have actually survived, the most important of all our sources.

Date of Pappus.

Pappus lived at the end of the third century A.D. The authority for this date is a marginal note in a Leyden manuscript of chronological tables by Theon of Alexandria, where, opposite to the name of Diocletian, a scholium says, 'In his time Pappus wrote'. Diocletian reigned from 284 to 305, and this must therefore be the period of Pappus's literary activity. It is true that Suidas makes him a contemporary of Theon of Alexandria, adding that they both lived under Theodosius I (379-395). But Suidas was evidently not well acquainted with the works of Pappus; though he mentions a description of the earth by him and a commentary on four Books of Ptolemy's *Syntaxis*, he has no word about his greatest work, the *Synagoge*. As Theon also wrote a commentary on Ptolemy and incorporated a great deal of the commentary of Pappus, it is probable that Suidas had Theon's commentary before him and from the association of the two names wrongly inferred that they were contemporaries.

Works (commentaries) other than the *Collection*.

Besides the *Synagoge*, which is the main subject of this chapter, Pappus wrote several commentaries, now lost except for fragments which have survived in Greek or Arabic. One was a commentary on the *Elements* of Euclid. This must presumably have been pretty complete, for, while Proclus (on Eucl. I) quotes certain things from Pappus which may be assumed to have come in the notes on Book I, fragments of his commentary on Book X actually survive in the Arabic (see above, vol. i, pp. 154-5, 209), and again Eutocius in his note on Archimedes, *On the Sphere and Cylinder*, I. 13, says that Pappus explained in his commentary on the *Elements* how to inscribe in a circle a polygon similar to a polygon inscribed in another circle, which problem would no doubt be solved by Pappus, as it is by a scholiast, in a note on XII. 1. Some of the references by Proclus deserve passing mention. (1) Pappus said that the converse of Post. 4 (equality of all right angles) is not true, i.e. it is not true that all angles equal to a right angle are themselves right, since the 'angle' between the conterminous arcs of two semicircles which are equal and have their

diameters at right angles and terminating at one point is equal to, but is not, a right angle.¹ (2) Pappus said that, in addition to the genuine axioms of Euclid, there were others on record about unequals added to equals and equals added to unequals. Others given by Pappus are (says Proclus) involved by the definitions, e.g. that 'all parts of the plane and of the straight line coincide with one another', that 'a point divides a line, a line a surface, and a surface a solid', and that 'the infinite is (obtained) in magnitudes both by addition and diminution'.² (3) Pappus gave a pretty proof of Eucl. I. 5, which modern editors have spoiled when introducing it into text-books. If AB , AC are the equal sides in an isosceles triangle, Pappus compares the triangles ABC and ACB (i.e. as if he were comparing the triangle ABC seen from the front with the same triangle seen from the back), and shows that they satisfy the conditions of I. 4, so that they are equal in all respects, whence the result follows.³

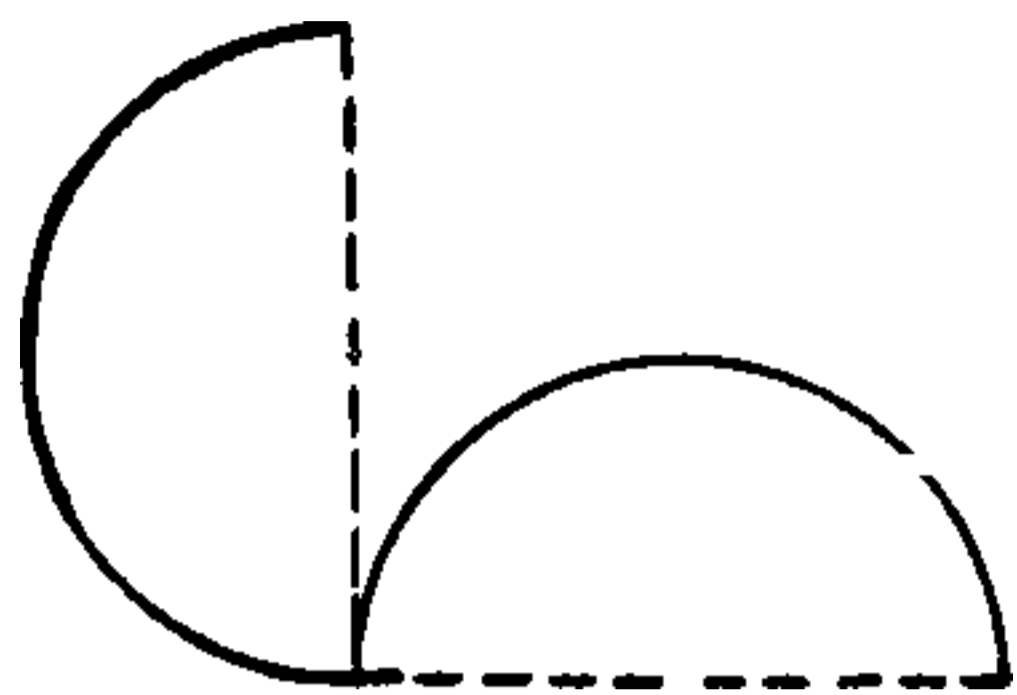

Marinus at the end of his commentary on Euclid's *Data* refers to a commentary by Pappus on that book.

Pappus's commentary on Ptolemy's *Syntaxis* has already been mentioned (p. 274); it seems to have extended to six Books, if not to the whole of Ptolemy's work. The *Fihrist* says that he also wrote a commentary on Ptolemy's *Planisphaerium*, which was translated into Arabic by Thābit b. Qurra. Pappus himself alludes to his own commentary on the *Analemma* of Diodorus, in the course of which he used the conchoid of Nicomedes for the purpose of trisecting an angle.

We come now to Pappus's great work.

The *Synagoge* or *Collection*.

(a) *Character of the work; wide range.*

Obviously written with the object of reviving the classical Greek geometry, it covers practically the whole field. It is,

¹ Proclus on Eucl. I, pp. 189-90.

² *Ib.*, pp. 197. 6-198. 15.

³ *Ib.*, pp. 249. 20-250. 12.



THIS PAGE IS LOCKED TO FREE MEMBERS

Purchase full membership to immediately unlock this page

DELVE INTO FANTASY, MAGIC, MYTHOLOGY & FOLKLORE

Forgotten Books'
Full Membership gives
access to 797,885 ancient
and modern, fiction and
non-fiction books.

Continue

*Fair usage policy applies

sizes and distances of the sun and moon), Autolycus (*On the moving sphere*), Carpus of Antioch (who is quoted as having said that Archimedes wrote only one mechanical book, that on sphere-making, since he held the mechanical appliances which made him famous to be nevertheless unworthy of written description: Carpus himself, who was known as *mechanicus*, applied geometry to other arts of this practical kind), Charmandrus (who added three simple and obvious loci to those which formed the beginning of the *Plane Loci* of Apollonius), Conon of Samos, the friend of Archimedes (cited as the propounder of a theorem about the spiral in a plane which Archimedes proved: this would, however, seem to be a mistake, as Archimedes says at the beginning of his treatise that he sent certain theorems, without proofs, to Conon, who would certainly have proved them had he lived), Demetrius of Alexandria (mentioned as the author of a work called 'Linear considerations', *γραμμικαὶ ἐπιστάσεις*, i.e. considerations on curves, as to which nothing more is known), Dinostratus, the brother of Menaechmus (cited, with Nicomedes, as having used the curve of Hippias, to which they gave the name of *quadratrix*, *τετραγωνίζουσα*, for the squaring of the circle), Diodorus (mentioned as the author of an *Analemma*), Eratosthenes (whose *mean-finder*, an appliance for finding two or any number of geometric means, is described, and who is further mentioned as the author of two Books 'On means' and of a work entitled 'Loci with reference to means'), Erycinus (from whose *Paradoxa* are quoted various problems seeming at first sight to be inconsistent with Eucl. I. 21, it being shown that straight lines can be drawn from two points on the base of a triangle to a point within the triangle which are together greater than the other two sides, provided that the points in the base may be points other than the extremities), Euclid, Geminus the mathematician (from whom is cited a remark on Archimedes contained in his book 'On the classification of the mathematical sciences', see above, p. 223), Heraclitus (from whom Pappus quotes an elegant solution of a *νεῦσις* with reference to a square), Hermodorus (Pappus's son, to whom he dedicated Books VII, VIII of his *Collection*), Heron of Alexandria (whose mechanical works are extensively quoted from), Hierius the philosopher (a contemporary of Pappus,

who is mentioned, as having asked Pappus's opinion on the attempted solution by 'plane' methods of the problem of the two means, which actually gives a method of approximating to a solution¹), Hipparchus (quoted as practically adopting three of the hypotheses of Aristarchus of Samos), Megethion (to whom Pappus dedicated Book V of his *Collection*), Menelaus of Alexandria (quoted as the author of *Sphaerica* and as having applied the name *παράδοξος* to a certain curve), Nicomachus (on three means additional to the first three), Nicomedes, Pandrosion (to whom Book III of the *Collection* is dedicated), Pericles (editor of Euclid's *Data*), Philon of Byzantium (mentioned along with Heron), Philon of Tyana (mentioned as the discoverer of certain complicated curves derived from the interweaving of plectoid and other surfaces), Plato (with reference to the five regular solids), Ptolemy, Theodosius (author of the *Sphaerica* and *On Days and Nights*).

(γ) *Translations and editions.*

The first published edition of the *Collection* was the Latin translation by Commandinus (Venice 1589, but dated at the end 'Pisauri apud Hieronymum Concordiam 1588'; reissued with only the title-page changed 'Pisauri... 1602'). Up to 1876 portions only of the Greek text had appeared, namely Books VII, VIII in Greek and German, by C. J. Gerhardt, 1871, chaps. 33–105 of Book V, by Eisenmann, Paris 1824, chaps. 45–52 of Book IV in *Iosephi Torelli Veronensis Geometrica*, 1769, the remains of Book II, by John Wallis (in *Opera mathematica*, III, Oxford 1699); in addition, the restorers of works of Euclid and Apollonius from the indications furnished by Pappus give extracts from the Greek text relating to the particular works, Breton le Champ on Euclid's *Porisms*, Halley in his edition of the *Conics* of Apollonius (1710) and in his translation from the Arabic and restoration respectively of the *De sectione rationis* and *De sectione spatii* of Apollonius (1706), Camerer on Apollonius's *Tactiones* (1795), Simson and Horsley in their restorations of Apollonius's *Plane Loci* and *Inclinationes* published in the years 1749 and 1770 respectively. In the years 1876–8 appeared the only com-

¹ See vol. i, pp. 268–70.

plete Greek text, with apparatus, Latin translation, commentary, appendices and indices, by Friedrich Hultsch; this great edition is one of the first monuments of the revived study of the history of Greek mathematics in the last half of the nineteenth century, and has properly formed the model for other definitive editions of the Greek text of the other classical Greek mathematicians, e.g. the editions of Euclid, Archimedes, Apollonius, &c., by Heiberg and others. The Greek index in this edition of Pappus deserves special mention because it largely serves as a dictionary of mathematical terms used not only in Pappus but by the Greek mathematicians generally.

(δ) *Summary of contents.*

At the beginning of the work, Book I and the first 13 propositions (out of 26) of Book II are missing. The first 13 propositions of Book II evidently, like the rest of the Book, dealt with Apollonius's method of working with very large numbers expressed in successive powers of the myriad, 10000. This system has already been described (vol. i, pp. 40, 54-7). The work of Apollonius seems to have contained 26 propositions (25 leading up to, and the 26th containing, the final continued multiplication).

Book III consists of four sections. Section (1) is a sort of history of the problem of *finding two mean proportionals, in continued proportion, between two given straight lines.*

It begins with some general remarks about the distinction between theorems and problems. Pappus observes that, whereas the ancients called them all alike by one name, some regarding them all as problems and others as theorems, a clear distinction was drawn by those who favoured more exact terminology. According to the latter a problem is that in which it is proposed to *do* or *construct* something, a theorem that in which, given certain hypotheses, we investigate that which follows from and is necessarily implied by them. Therefore he who propounds a theorem, no matter how he has become aware of the fact which is a necessary consequence of the premisses, must state, as the object of inquiry, the right result and no other. On the other hand, he who propounds



THIS PAGE IS LOCKED TO FREE MEMBERS

Purchase full membership to immediately unlock this page

FORGOTTEN BOOKS

FULL

MEMBERSHIP

797,885 Books!

All you can read

for only

\$8.99/month

Continue

*Fair usage policy applies



Section (2). *The theory of means.*

Next follows a section (pp. 69–105) on the theory of the different kinds of *means*. The discussion takes its origin from the statement of the ‘second problem’, which was that of ‘exhibiting the three means’ (i.e. the arithmetic, geometric and harmonic) ‘in a semicircle’. Pappus first gives a construction by which another geometer (*ἄλλος τις*) claimed to have solved this problem, but he does not seem to have understood it, and returns to the same problem later (pp. 80–2).

In the meantime he begins with the definitions of the three means and then shows how, given any two of three terms a, b, c in arithmetical, geometrical or harmonical progression, the third can be found. The definition of the mean (b) of three terms a, b, c in harmonic progression being that it satisfies the relation $a : c = a - b : b - c$, Pappus gives alternative definitions for the arithmetic and geometric means in corresponding form, namely for the arithmetic mean $a : a = a - b : b - c$ and for the geometric $a : b = a - b : b - c$.

The construction for the harmonic mean is perhaps worth giving. Let AB, BG be two given straight lines. At A draw DAE perpendicular to AB , and make DA, AE equal. Join DB, BE . From G draw GF at right angles to AB meeting DB in F . Join EF meeting AB in C . Then BC is the required harmonic mean.

For

$$\begin{aligned} AB : BG &= DA : FG \\ &= EA : FG \\ &= AC : CG \\ &= (AB - BC) : (BC - BG). \end{aligned}$$

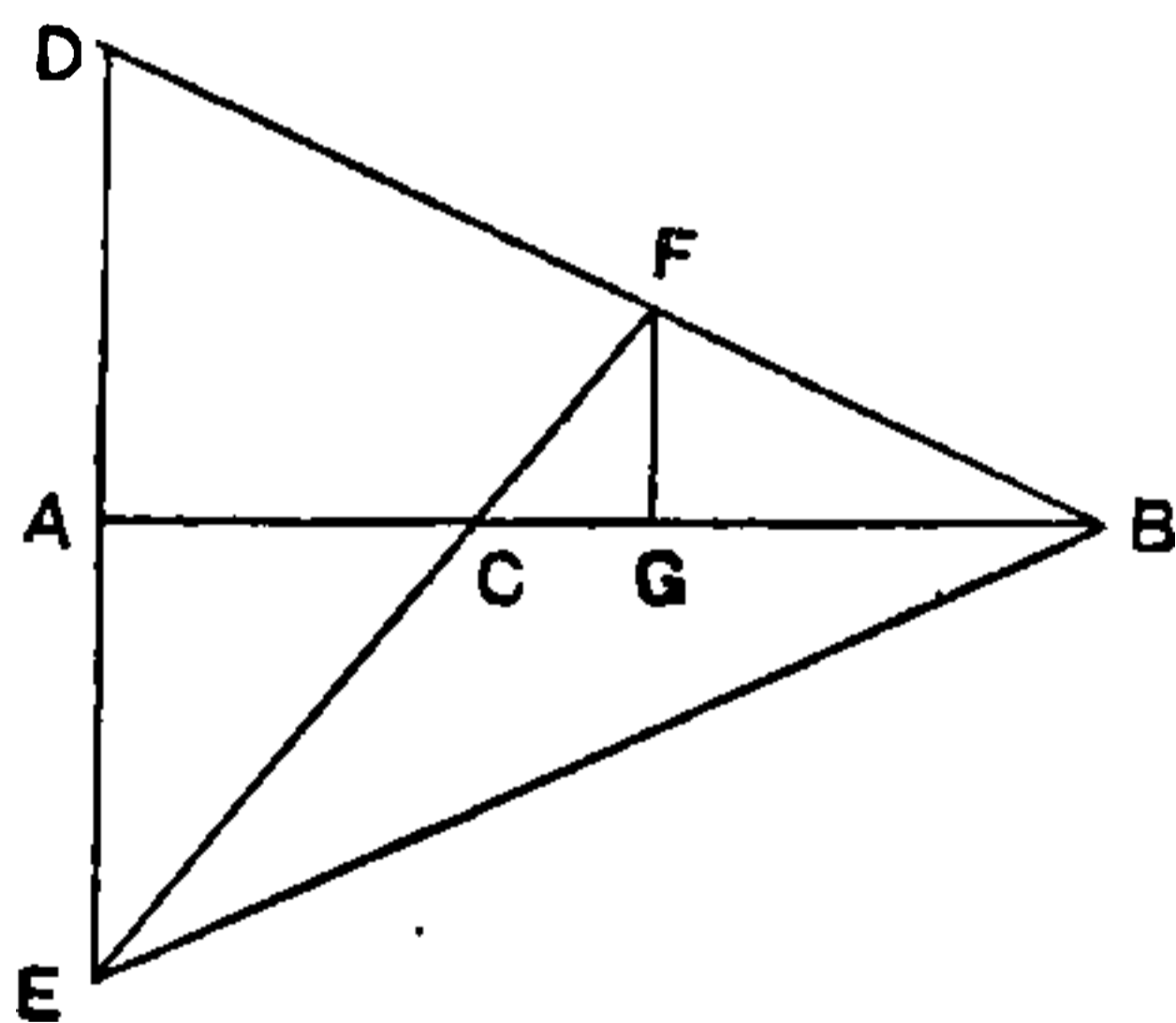

Similarly, by means of a like figure, we can find BG when AB, BC are given, and AB when BC, BG are given (in the latter case the perpendicular DE is drawn through G instead of A).

Then follows a proposition that, if the three means and the several extremes are represented in one set of lines, there must be five of them at least, and, after a set of five such lines have been found in the smallest possible integers, Pappus passes to

the problem of representing the three means with the respective extremes by *six* lines drawn in a semicircle.

Given a semicircle on the diameter AC , and B any point on the diameter, draw BD at right angles to AC . Let the tangent

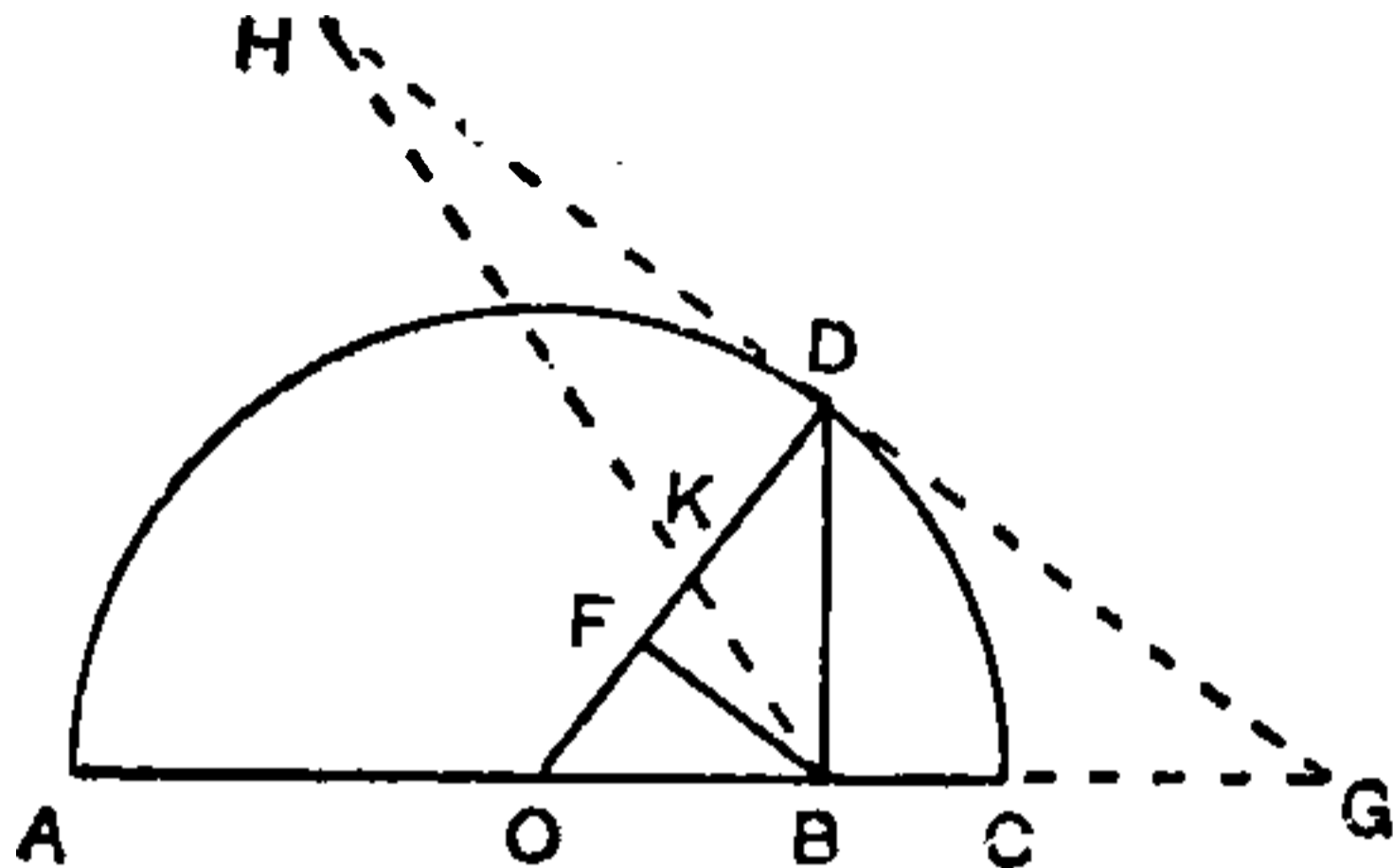

at D meet AC produced in G , and measure DH along the tangent equal to DG . Join HB meeting the radius OD in K . Let BF be perpendicular to OD .

Then, exactly as above, it is shown that OK is a harmonic mean between OF and OD . Also BD is the geometric mean between AB , BC , while OC ($= OD$) is the arithmetic mean between AB , BC .

Therefore the *six* lines DO ($= OC$), OK , OF , AB , BC , BD supply the three means with the respective extremes.

But Pappus seems to have failed to observe that the 'certain other geometer', who has the same figure excluding the dotted lines, supplied the same in *five* lines. For he said that DF is 'a harmonic mean'. It is in fact the harmonic mean between AB , BC , as is easily seen thus.

Since ODB is a right-angled triangle, and BF perpendicular to OD ,

$$DF : BD = BD : DO,$$

or
$$DF \cdot DO = BD^2 = AB \cdot BC.$$

But
$$DO = \frac{1}{2}(AB + BC);$$

therefore
$$DF \cdot (AB + BC) = 2 AB \cdot BC.$$

Therefore
$$AB \cdot (DF - BC) = BC \cdot (AB - DF),$$

that is,
$$AB : BC = (AB - DF) : (DF - BC),$$

and DF is the harmonic mean between AB , BC .

Consequently the *five* lines DO ($= OC$), DF , AB , BC , BD exhibit all the three means with the extremes.

Pappus does not seem to have seen this, for he observes that the geometer in question, though saying that DF is a harmonic mean, does not say how it is a harmonic mean or between what straight lines.

In the next chapters (pp. 84–104) Pappus, following Nicomachus and others, defines seven more means, three of which were ancient and the last four more modern, and shows how we can form all ten means as linear functions of α, β, γ , where α, β, γ are in geometrical progression. The exposition has already been described (vol. i, pp. 86–9).

Section (3). *The 'Paradoxes' of Erycinus.*

The third section of Book III (pp. 104–30) contains a series of propositions, all of the same sort, which are curious rather than geometrically important. They appear to have been taken direct from a collection of *Paradoxes* by one Erycinus.¹ The first set of these propositions (Props. 28–34) are connected with Eucl. I. 21, which says that, if from the extremities of the base of any triangle two straight lines be drawn meeting at any point within the triangle, the straight lines are together less than the two sides of the triangle other than the base, but contain a greater angle. It is pointed out that, if the straight lines are allowed to be drawn from points in the base other than the extremities, their sum may be greater than the other two sides of the triangle.

The first case taken is that of a right-angled triangle ABC right-angled at B . Draw AD to any point D on BC . Measure on AB DE equal to AB , bisect AE in F , and join FC . Then shall

$$DF + FC \text{ be } > BA + AC.$$

$$\text{For } EF + FC = AF + FC > AC.$$

Add DE and AB respectively, and we have

$$DF + FC > BA + AC.$$

More elaborate propositions are next proved, such as the following.

1. In any triangle, except an equilateral triangle or an isosceles

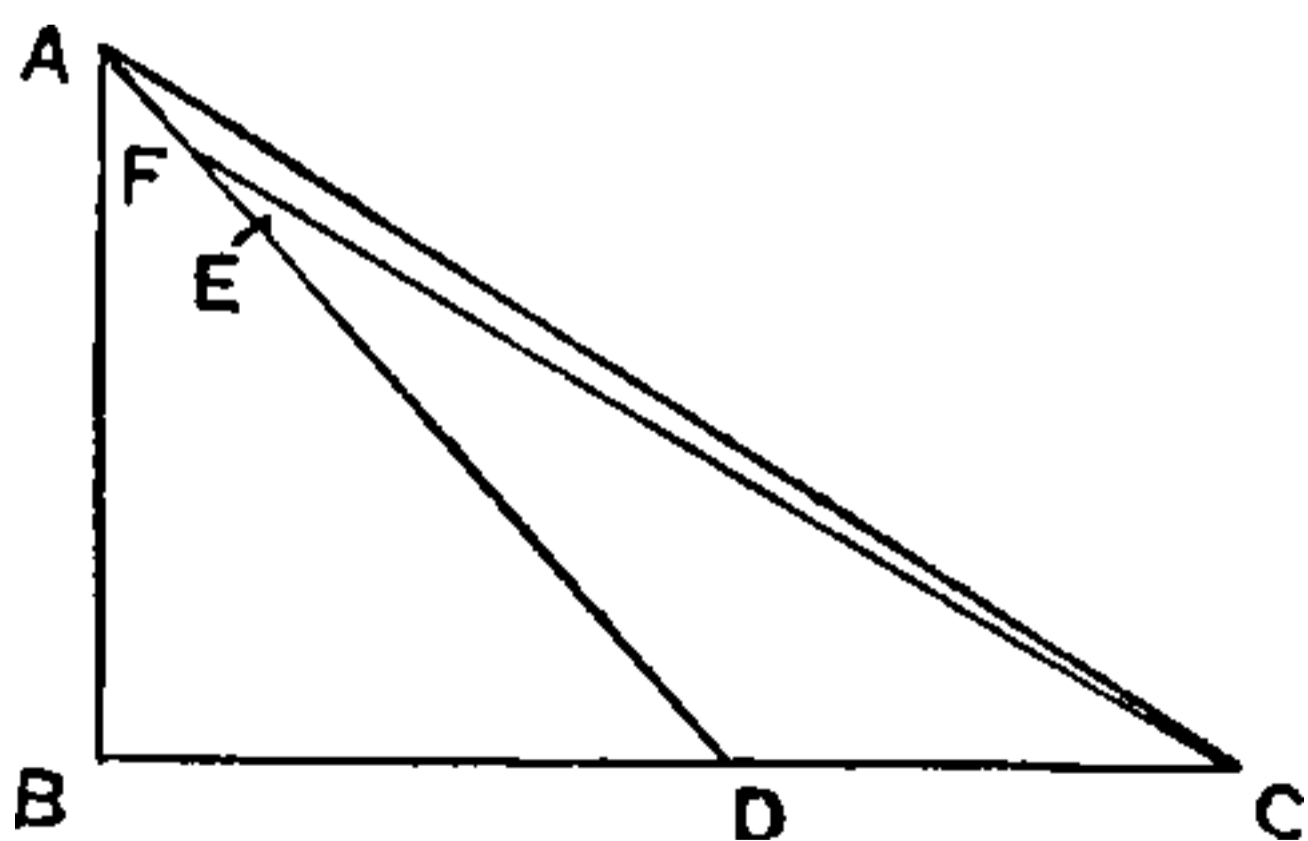

¹ Pappus, iii, p. 106. 5–9.



THIS PAGE IS LOCKED TO FREE MEMBERS

Purchase full membership to immediately unlock this page

DELVE INTO FANTASY, MAGIC, MYTHOLOGY & FOLKLORE

Forgotten Books'
Full Membership gives
access to 797,885 ancient
and modern, fiction and
non-fiction books.

Continue

*Fair usage policy applies

Now $EA + AC > EF + FC$
 $> EG + GC$ and $> GC$, *a fortiori*.

Produce GC to K so that $GK = EA + AC$, and with G as centre and GK as radius describe a circle. This circle will meet HC and HG , because $GH = EB > BD$ or $DA + AC$ and $> GK$, *a fortiori*.

Then $HG + GL = BE + EA + AC = BA + AC$.

To obtain two straight lines HG' , $G'L$ such that $HG' + G'L > BA + AC$, we have only to choose G' so that HG' , $G'L$ enclose the straight lines HG , GL completely.

Next suppose that, given a triangle ABC in which $BC > BA$

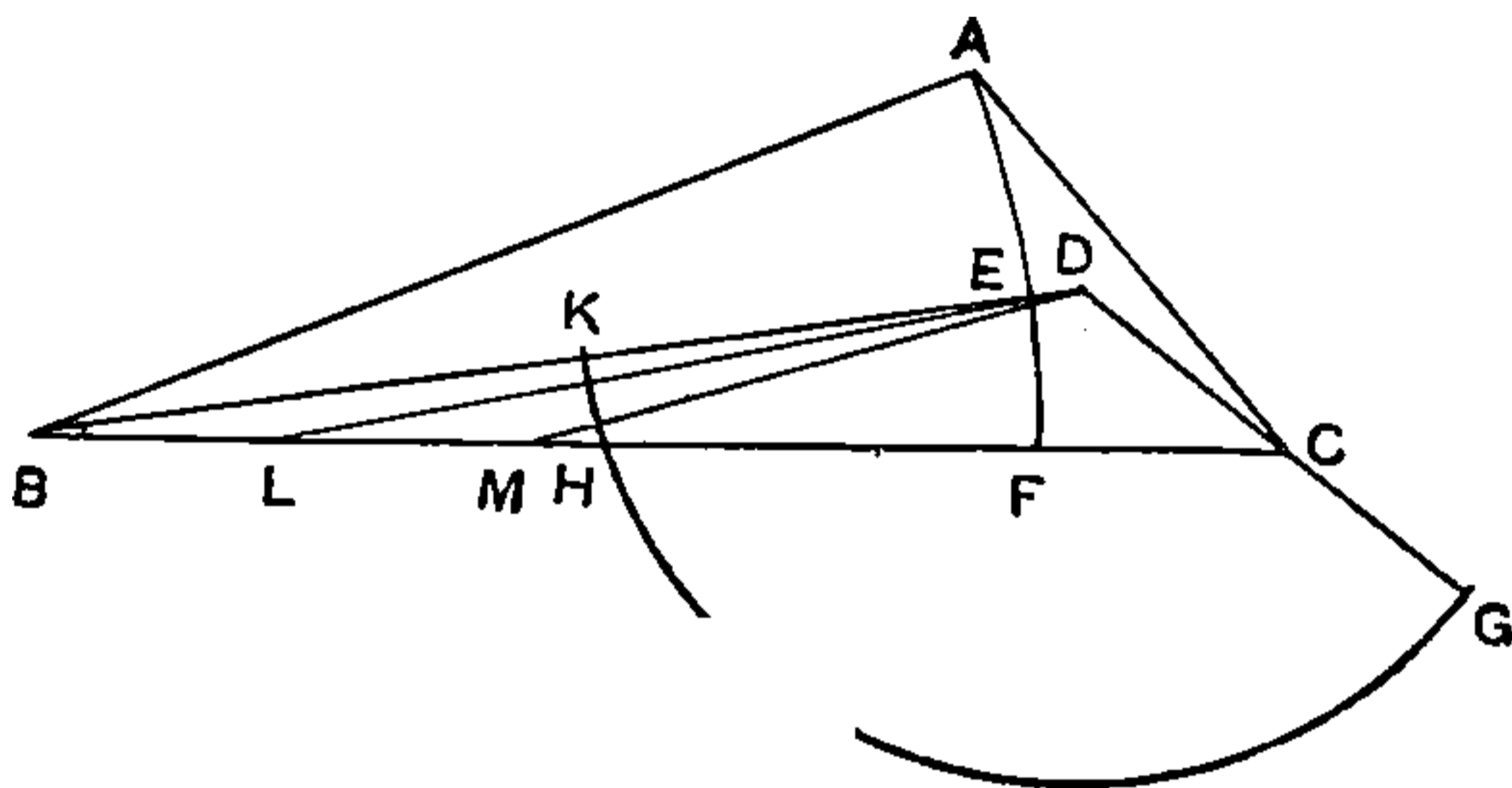

$> AC$, we are required to draw from two points on BC to an internal point two straight lines greater *respectively* than BA , AC .

With B as centre and BA as radius describe the arc AEF . Take any point E on it, and any point D on BE produced but within the triangle. Join DC , and produce it to G so that $DG = AC$. Then with D as centre and DG as radius describe a circle. This will meet both BC and BD because $BA > AC$, and *a fortiori* $DB > DG$.

Then, if L be any point on BH , it is clear that BD , DL are two straight lines satisfying the conditions.

A point L' on BH can be found such that DL' is equal to AB by marking off DN on DB equal to AB and drawing with D as centre and DN as radius a circle meeting BH in L' . Also, if DH be joined, $DH = AC$.

Propositions follow (35-9) having a similar relation to the Postulate in Archimedes, *On the Sphere and Cylinder*, I, about conterminous broken lines one of which wholly encloses

the other, i.e. it is shown that broken lines, consisting of several straight lines, can be drawn with two points on the base of a triangle or parallelogram as extremities, and of greater total length than the remaining two sides of the triangle or three sides of the parallelogram.

Props. 40–2 show that triangles or parallelograms can be constructed with sides respectively greater than those of a given triangle or parallelogram but having a less area.

Section (4). *The inscribing of the five regular solids in a sphere.*

The fourth section of Book III (pp. 132–62) solves the problems of inscribing each of the five regular solids in a given sphere. After some preliminary lemmas (Props. 43–53), Pappus attacks the substantive problems (Props. 54–8), using the method of analysis followed by synthesis in the case of each solid.

(a) In order to inscribe a regular pyramid or tetrahedron in the sphere, he finds two circular sections equal and parallel to one another, each of which contains one of two opposite edges as its diameter. If d be the diameter of the sphere, the parallel circular sections have d' as diameter, where $d^2 = \frac{3}{2}d'^2$.

(b) In the case of the cube Pappus again finds two parallel circular sections with diameter d' such that $d^2 = \frac{3}{2}d'^2$; a square inscribed in one of these circles is one face of the cube and the square with sides parallel to those of the first square inscribed in the second circle is the opposite face.

(c) In the case of the octahedron the same two parallel circular sections with diameter d' such that $d^2 = \frac{3}{2}d'^2$ are used; an equilateral triangle inscribed in one circle is one face, and the opposite face is an equilateral triangle inscribed in the other circle but placed in exactly the opposite way.

(d) In the case of the icosahedron Pappus finds four parallel circular sections each passing through three of the vertices of the icosahedron; two of these are small circles circumscribing two opposite triangular faces respectively, and the other two circles are between these two circles, parallel to them, and equal to one another. The pairs of circles are determined in

this way. If d be the diameter of the sphere, set out two straight lines x, y such that d, x, y are in the ratio of the sides of the regular pentagon, hexagon and decagon respectively described in one and the same circle. The smaller pair of circles have r as radius where $r^2 = \frac{1}{3}y^2$, and the larger pair have r' as radius where $r'^2 = \frac{1}{3}x^2$.

(e) In the case of the dodecahedron the *same* four parallel circular sections are drawn as in the case of the icosahedron. Inscribed pentagons set the opposite way are inscribed in the two smaller circles; these pentagons form opposite faces. Regular pentagons inscribed in the larger circles with vertices at the proper points (and again set the opposite way) determine ten more vertices of the inscribed dodecahedron.

The constructions are quite different from those in Euclid XIII. 13, 15, 14, 16, 17 respectively, where the problem is first to construct the particular regular solid and then to 'comprehend it in a sphere', i. e. to determine the circumscribing sphere in each case. I have set out Pappus's propositions in detail elsewhere.¹

Book IV.

At the beginning of Book IV the title and preface are missing, and the first section of the Book begins immediately with an enunciation. The first section (pp. 176-208) contains Propositions 1-12 which, with the exception of Props. 8-10, seem to be isolated propositions given for their own sakes and not connected by any general plan.

Section (1). *Extension of the theorem of Pythagoras.*

The first proposition is of great interest, being the generalization of Eucl. I. 47, as Pappus himself calls it, which is by this time pretty widely known to mathematicians. The enunciation is as follows.

'If ABC be a triangle and on AB, AC any parallelograms whatever be described, as $ABDE, ACFG$, and if DE, FG produced meet in H and HA be joined, then the parallelograms $ABDE, ACFG$ are together equal to the parallelogram

¹ *Vide* notes to Euclid's propositions in *The Thirteen Books of Euclid's Elements*, pp. 473, 480, 477, 489-91, 501-3.



THIS PAGE IS LOCKED TO FREE MEMBERS

Purchase full membership to immediately unlock this page

FORGOTTEN BOOKS

FULL

MEMBERSHIP

797,885 Books!

All you can read

for only

\$8.99/month

Continue

*Fair usage policy applies



we may say that the algebraic sum of the three parallelograms is equal to zero.

Though Pappus only takes one case, as was the Greek habit, I see no reason to doubt that he was aware of the results in the other possible cases.

Props. 2, 3 are noteworthy in that they use the method and phraseology of Eucl. X, proving that a certain line in one figure is the irrational called *minor* (see Eucl. X. 76), and a certain line in another figure is 'the excess by which the *binomial* exceeds the *straight line which produces with a rational area a medial whole*' (Eucl. X. 77). The propositions 4-7 and 11-12 are quite interesting as geometrical exercises, but their bearing is not obvious: Props. 4 and 12 are remarkable in that they are cases of analysis followed by synthesis applied to the proof of *theorems*. Props. 8-10 belong to the subject of *tangencies*, being the sort of propositions that would come as particular cases in a book such as that of Apollonius *On Contacts*; Prop. 8 shows that, if there are two equal circles and a given point outside both, the diameter of the circle passing through the point and touching both circles is 'given'; the proof is in many places obscure and assumes lemmas of the same kind as those given later à propos of Apollonius's treatise; Prop. 10 purports to show how, given three unequal circles touching one another two and two, to find the diameter of the circle including them and touching all three.

Section (2). *On circles inscribed in the ἄρβηλος*
(*'shoemaker's knife'*).

The next section (pp. 208-32), directed towards the demonstration of a theorem about the relative sizes of successive circles inscribed in the ἄρβηλος (shoemaker's knife), is extremely interesting and clever, and I wish that I had space to reproduce it completely. The ἄρβηλος, which we have already met with in Archimedes's 'Book of Lemmas', is formed thus. BC is the diameter of a semicircle BGC and BC is divided into two parts (in general unequal) at D ; semicircles are described on BD , DC as diameters on the same side of BC as BGC is; the figure included between the three semicircles is the ἄρβηλος.

There is, says Pappus, on record an ancient proposition to the following effect. Let successive circles be inscribed in the ἀρβηλος touching the semicircles and one another as shown in the figure on p. 376, their centres being $A, P, O \dots$. Then, if $p_1, p_2, p_3 \dots$ be the perpendiculars from the centres $A, P, O \dots$ on BC and $d_1, d_2, d_3 \dots$ the diameters of the corresponding circles,

$$p_1 = d_1, \quad p_2 = 2d_2, \quad p_3 = 3d_3 \dots$$

He begins by some lemmas, the course of which I shall reproduce as shortly as I can.

I. If (Fig. 1) two circles with centres A, C of which the former is the greater touch externally at B , and another circle with centre G touches the two circles at K, L respectively, then KL produced cuts the circle BL again in D and meets AC produced in a point E such that $AB:BC = AE:EC$. This is easily proved, because the circular segments DL, LK are similar, and CD is parallel to AG . Therefore

$$AB:BC = AK:CD = AE:EC.$$

Also $KE \cdot EL = EB^2$.

For $AE:EC = AB:BC = AB:CF = (AE - AB):(EC - CF)$
 $= BE:EF$.

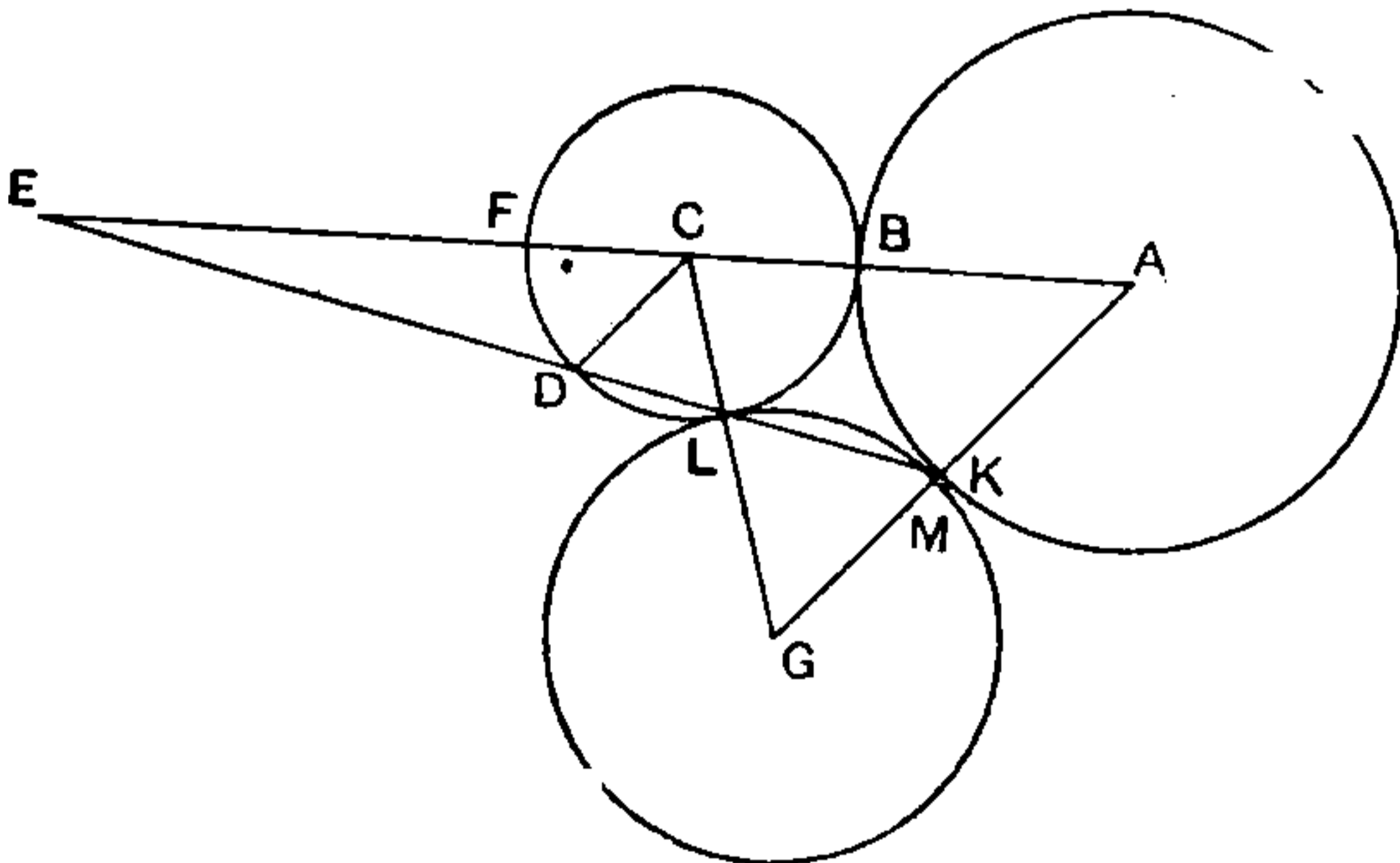

FIG 1.

But $AE:EC = KE:ED$; therefore $KE:ED = BE:EF$.

Therefore $KE \cdot EL:EL \cdot ED = BE^2:BE \cdot EF$.

And $EL \cdot ED = BE \cdot EF$; therefore $KE \cdot EL = EB^2$.

II. Let (Fig. 2) BC, BD , being in one straight line, be the diameters of two semicircles BGC, BED , and let any circle as FGH touch both semicircles, A being the centre of the circle. Let M be the foot of the perpendicular from A on BC , r the radius of the circle FGH . There are two cases according as BD lies along BC or B lies between D and C ; i.e. in the first case the two semicircles are the outer and one of the inner semicircles of the $\alpha\rho\beta\eta\lambda\omicron\varsigma$, while in the second case they are the two inner semicircles; in the latter case the circle FGH may either include the two semicircles or be entirely external to them. Now, says Pappus, it is to be proved that

in case (1) $BM : r = (BC + BD) : (BC - BD),$

and in case (2) $BM : r = (BC - BD) : (BC + BD).$

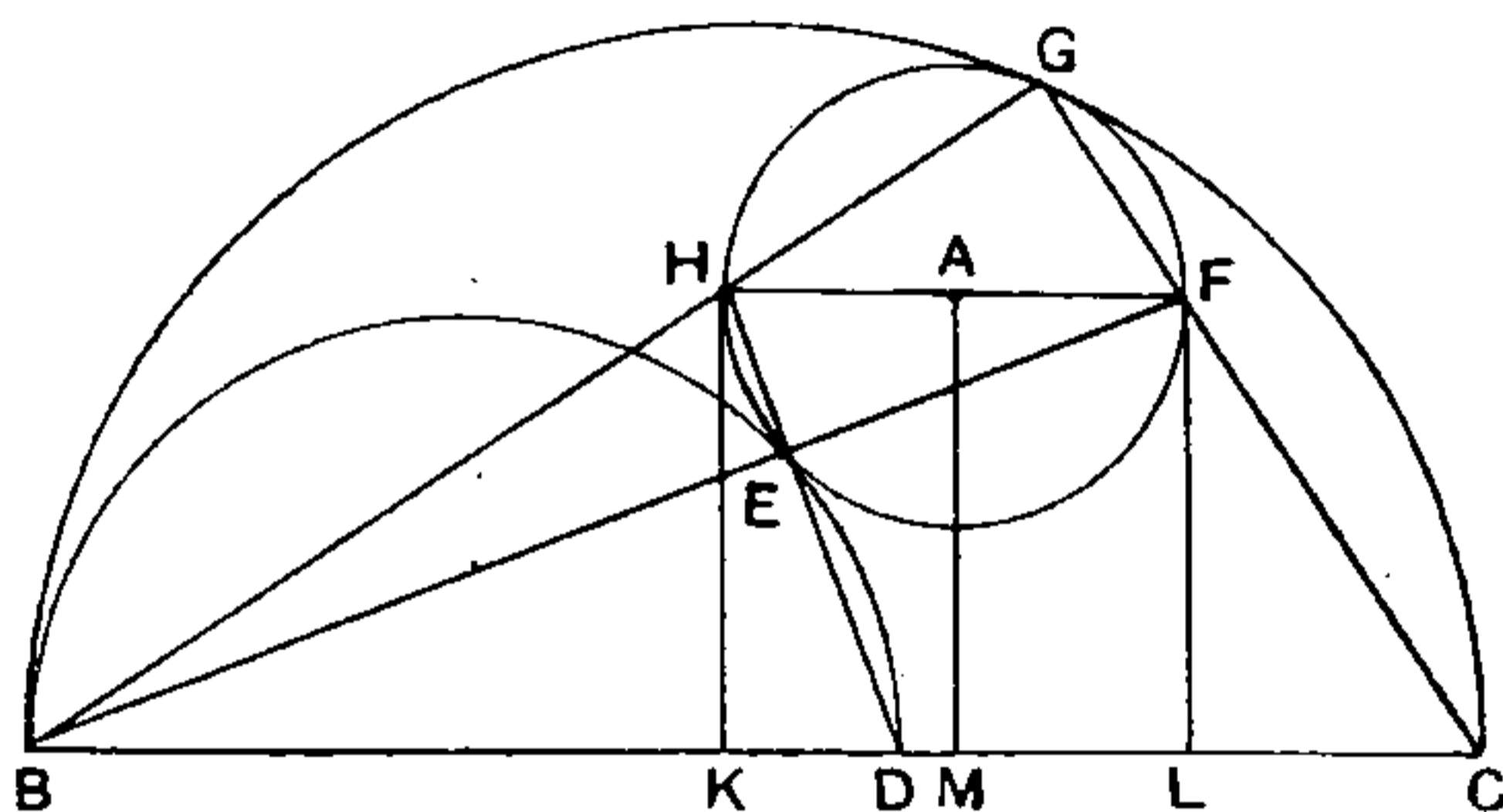

FIG. 2.

We will confine ourselves to the first case, represented in the figure (Fig. 2).

Draw through A the diameter HF parallel to BC . Then, since the circles BGC, HGF touch at G , and BC, HF are parallel diameters, GHB, GFC are both straight lines.

Let E be the point of contact of the circles FGH and BED ; then, similarly, BEF, HED are straight lines.

Let HK, FL be drawn perpendicular to BC .

By the similar triangles BGC, BKH we have

$$BC : BG = BH : BK, \text{ or } CB \cdot BK = GB \cdot BH;$$

and by the similar triangles BLF, BED

$$BF : BL = BD : BE, \text{ or } DB \cdot BL = FB \cdot BE.$$



THIS PAGE IS LOCKED TO FREE MEMBERS

Purchase full membership to immediately unlock this page

DELVE INTO FANTASY, MAGIC, MYTHOLOGY & FOLKLORE

Forgotten Books'
Full Membership gives
access to 797,885 ancient
and modern, fiction and
non-fiction books.

Continue

*Fair usage policy applies

Therefore (Lemma I), if the two circles touch the semi-circle BED in R, E respectively, FRE is a straight line and $EF \cdot FR = FH^2$.

But $EF \cdot FR = FB^2$; therefore $FH = FB$.

If now BH meets PN in O and MA produced in S , we have, by similar triangles, $FH : FB = PH : PO = AH : AS$, whence $PH = PO$ and $SA = AH$, so that O, S are the intersections of PN, AM with the respective circles.

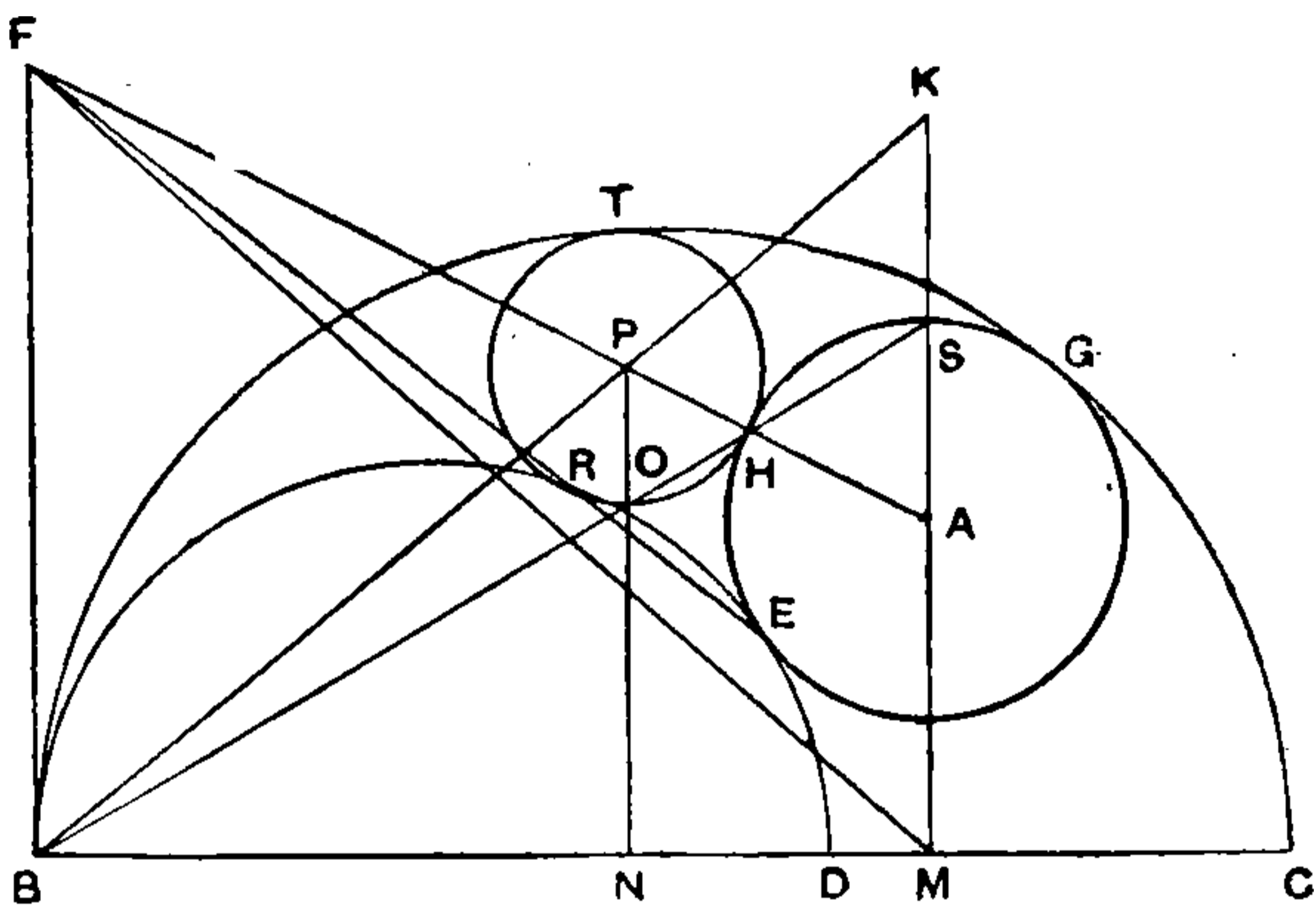

FIG. 3.

Join BP , and produce it to meet MA in K .

Now $BM : BN = FA : FP$
 $= AH : PH$, from above,
 $= AS : PO$.

And $BM : BN = BK : BP$
 $= KS : PO$.

Therefore $KS = AS$, and $KA = d$, the diameter of the circle EHG .

Lastly, $MK : KS = PN : PO$,

that is, $(AM + d) : \frac{1}{2}d = PN : \frac{1}{2}d'$,

or $(AM + d) : d = PN : d'$.

IV. We now come to the substantive theorem.

Let FGH be the circle touching all three semicircles (Fig. 4). We have then, as in Lemma II,

$$BC \cdot BK = BD \cdot BL,$$

and for the same reason (regarding FGH as touching the semicircles BGC, DUC)

$$BC \cdot CL = CD \cdot CK.$$

From the first relation we have

$$BC^2 : BD = BL : BK,$$

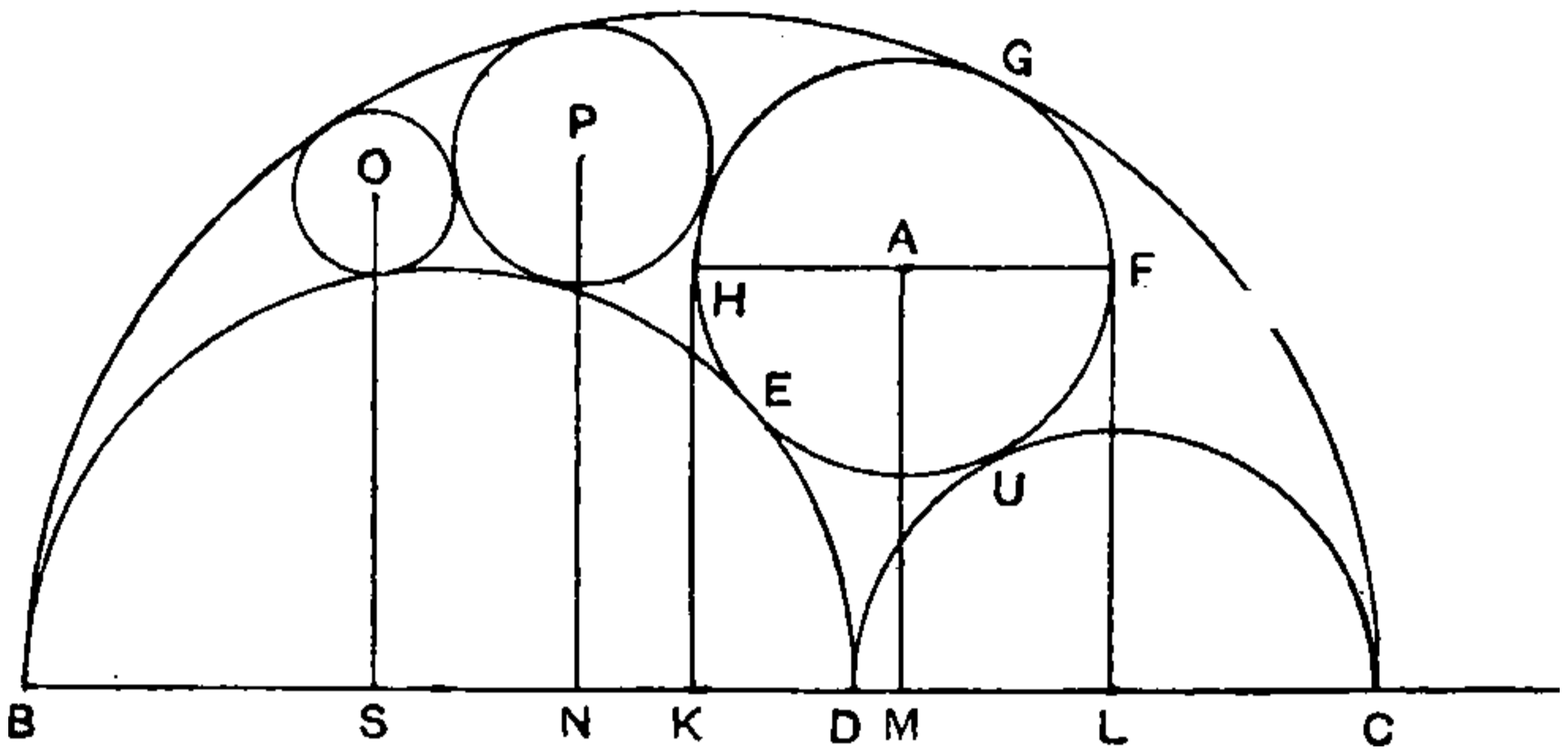

FIG. 4.

whence $DC : BD = KL : BK$, and inversely $BD : DC = BK : KL$, while, from the second relation, $BC : CD = CK : CL$,

whence $BD : DC = KL : CL$.

Consequently $BK : KL = KL : CL$,

or $BK \cdot LC = KL^2$.

But we saw in Lemma II (b) that $BK \cdot LC = AM^2$.

Therefore $KL = AM$, or $p_1 = d_1$.

For the second circle Lemma III gives us

$$(p_1 + d_1) : d_1 = p_2 : d_2,$$

whence, since $p_1 = d_1$, $p_2 = 2d_2$.

For the third circle

$$(p_2 + d_2) : d_2 = p_3 : d_3,$$

whence $p_3 = 3d_3$.

And so on *ad infinitum*.

The same proposition holds when the successive circles, instead of being placed between the large and one of the small semicircles, come down between the two small semicircles.

Pappus next deals with special cases (1) where the two smaller semicircles become straight lines perpendicular to the diameter of the other semicircle at its extremities, (2) where we replace one of the smaller semicircles by a straight line through D at right angles to BC , and lastly (3) where instead of the semicircle DUC we simply have the straight line DC and make the first circle touch it and the two other semicircles.

Pappus's propositions of course include as particular cases the partial propositions of the same kind included in the 'Book of Lemmas' attributed to Archimedes (Props. 5, 6); cf. p. 102.

Sections (3) and (4). *Methods of squaring the circle, and of trisecting (or dividing in any ratio) any given angle.*

The last sections of Book IV (pp. 234–302) are mainly devoted to the solutions of the problems (1) of squaring or rectifying the circle and (2) of trisecting any given angle or dividing it into two parts in any ratio. To this end Pappus gives a short account of certain curves which were used for the purpose.

(a) *The Archimedean spiral.*

He begins with the spiral of Archimedes, proving some of the fundamental properties. His method of finding the area included (1) between the first turn and the initial line, (2) between any radius vector on the first turn and the curve, is worth giving because it differs from the method of Archimedes. It is the area of the whole first turn which Pappus works out in detail. We will take the area up to the radius vector OB , say.

With centre O and radius OB draw the circle $A'BCD$.

Let BC be a certain fraction, say $1/n$ th, of the arc $BCDA'$, and CD the same fraction, OC, OD meeting the spiral in F, E respectively. Let KS, SV be the same fraction of a straight line KR , the side of a square $KNLR$. Draw ST, VW parallel to KN meeting the diagonal KL of the square in U, Q respectively, and draw MU, PQ parallel to KR .



THIS PAGE IS LOCKED TO FREE MEMBERS

Purchase full membership to immediately unlock this page

FORGOTTEN BOOKS

FULL

MEMBERSHIP

797,885 Books!

All you can read

for only

\$8.99/month

Continue

*Fair usage policy applies



We have a similar proportion connecting a figure circumscribed to the spiral and a figure circumscribed to the cone.

By increasing n the inscribed and circumscribed figures can be compressed together, and by the usual method of exhaustion we have ultimately

$$\begin{aligned} (\text{sector } OA'DB) : (\text{area of spiral}) &= (\text{cyl. } KN, NL) : (\text{cone } KN, NL) \\ &= 3 : 1, \end{aligned}$$

or (area of spiral cut off by OB) = $\frac{1}{3}$ (sector $OA'DB$).

The ratio of the sector $OA'DB$ to the complete circle is that of the angle which the radius vector describes in passing from the position OA to the position OB to four right angles, that is, by the property of the spiral, $r : a$, where $r = OB$, $a = OA$.

Therefore (area of spiral cut off by OB) = $\frac{1}{3} \frac{r}{a} \cdot \pi r^2$.

Similarly the area of the spiral cut off by any other radius vector r' = $\frac{1}{3} \frac{r'}{a} \cdot \pi r'^2$.

Therefore (as Pappus proves in his next proposition) the first area is to the second as r^3 to r'^3 .

Considering the areas cut off by the radii vectores at the points where the revolving line has passed through angles of $\frac{1}{2}\pi$, π , $\frac{3}{2}\pi$ and 2π respectively, we see that the areas are in the ratio of $(\frac{1}{4})^3$, $(\frac{1}{2})^3$, $(\frac{3}{4})^3$, 1 or 1, 8, 27, 64, so that the areas of the spiral included in the four quadrants are in the ratio of 1, 7, 19, 37 (Prop. 22).

(β) *The conchoid of Nicomedes.*

The conchoid of Nicomedes is next described (chaps. 26–7), and it is shown (chaps. 28, 29) how it can be used to find two geometric means between two straight lines, and consequently to find a cube having a given ratio to a given cube (see vol. i, pp. 260–2 and pp. 238–40, where I have also mentioned Pappus's remark that the conchoid which he describes is the *first* conchoid, while there also exist a *second*, a *third* and a *fourth* which are of use for other theorems).

(γ) *The quadratrix.*

The *quadratrix* is taken next (chaps. 30–2), with Sporus's criticism questioning the construction as involving a *petitio*

principia. Its use for squaring the circle is attributed to Dinostratus and Nicomedes. The whole substance of this subsection is given above (vol. i, pp. 226-30).

*Two constructions for the quadratrix by means of
'surface-loci'.*

In the next chapters (chaps. 33, 34, Props. 28, 29) Pappus gives two alternative ways of producing the *quadratrix* 'by means of surface-loci', for which he claims the merit that they are geometrical rather than 'too mechanical' as the traditional method (of Hippias) was.

(1) The first method uses a cylindrical helix thus.

Let ABC be a quadrant of a circle with centre B , and let BD be any radius. Suppose that EF , drawn from a point E on the radius BD perpendicular to BC , is (for all such radii) in a given ratio to the arc DC .

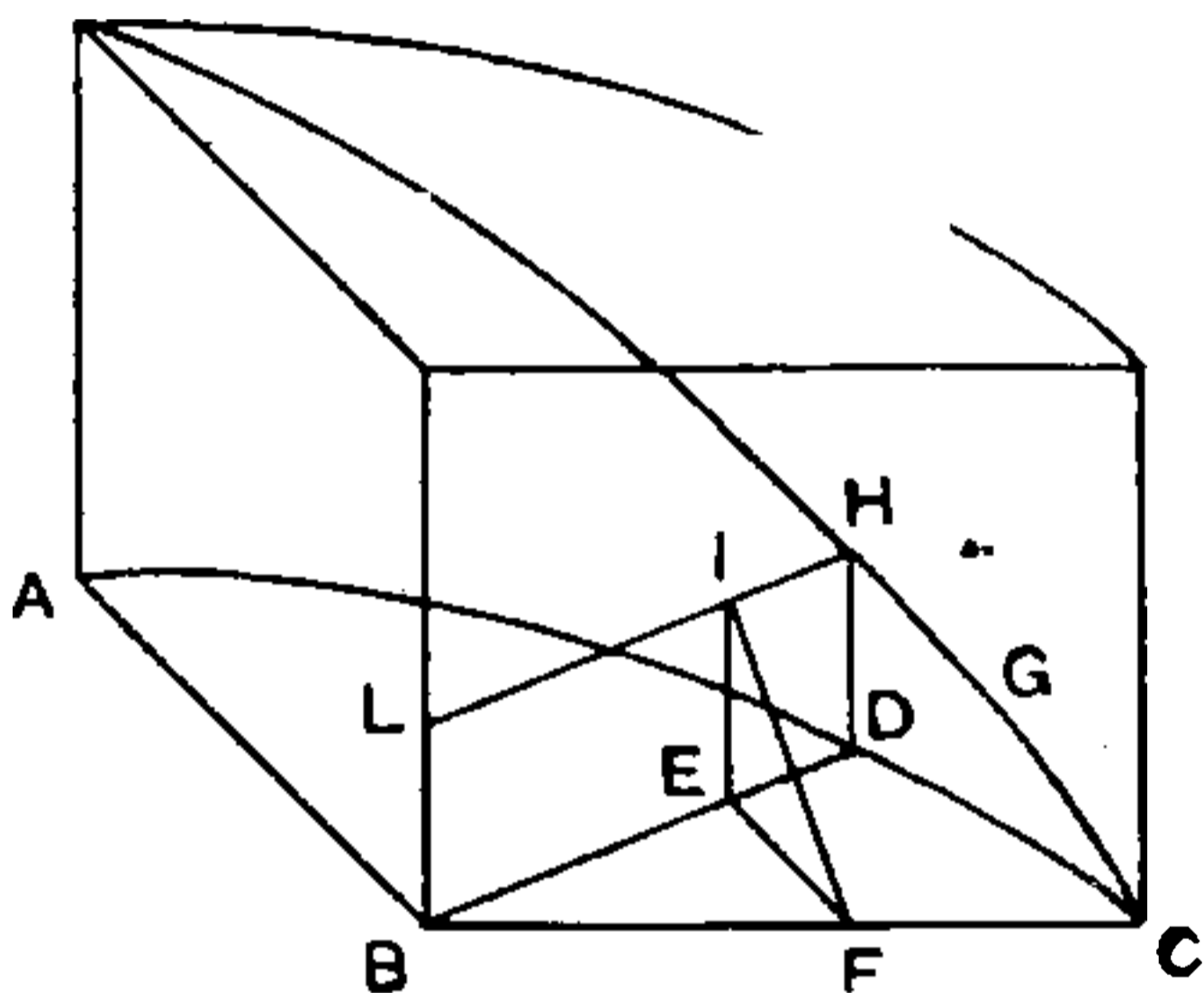

'I say', says Pappus, 'that the locus of E is a certain curve.'

Suppose a right cylinder erected from the quadrant and a cylindrical helix CGH drawn upon its surface. Let DH be the generator of this cylinder through D , meeting the helix in H . Draw BL , EI at right angles to the plane of the quadrant, and draw HIL parallel to BD .

Now, by the property of the helix, $EI (= DH)$ is to the arc CD in a given ratio. Also $EF : (\text{arc } CD) = \text{a given ratio}$.

Therefore the ratio $EF : EI$ is given. And since EF , EI are given in position, FI is given in position. But FI is perpendicular to BC . Therefore FI is in a plane given in position, and so therefore is I .

But I is also on a certain surface described by the line LH , which moves always parallel to the plane ABC , with one extremity L on BL and the other extremity H on the helix. Therefore I lies on the intersection of this surface with the plane through FI .

Hence I lies on a certain curve. Therefore E , its projection on the plane ABC , also lies on a curve.

In the particular case where the given ratio of EF to the arc CD is equal to the ratio of BA to the arc CA , the locus of E is a *quadratrix*.

[The surface described by the straight line LH is a *plectoid*. The shape of it is perhaps best realized as a *continuous* spiral staircase, i.e. a spiral staircase with infinitely small steps. The *quadratrix* is thus produced as the orthogonal projection of the curve in which the plectoid is intersected by a plane through BC inclined at a given angle to the plane ABC . It is not difficult to verify the result analytically.]

(2) The second method uses a right cylinder the base of which is an Archimedean spiral.

Let ABC be a quadrant of a circle, as before, and EF , perpendicular at F to BC , a straight line of such length that EF is to the arc DC as AB is to the arc ADC .

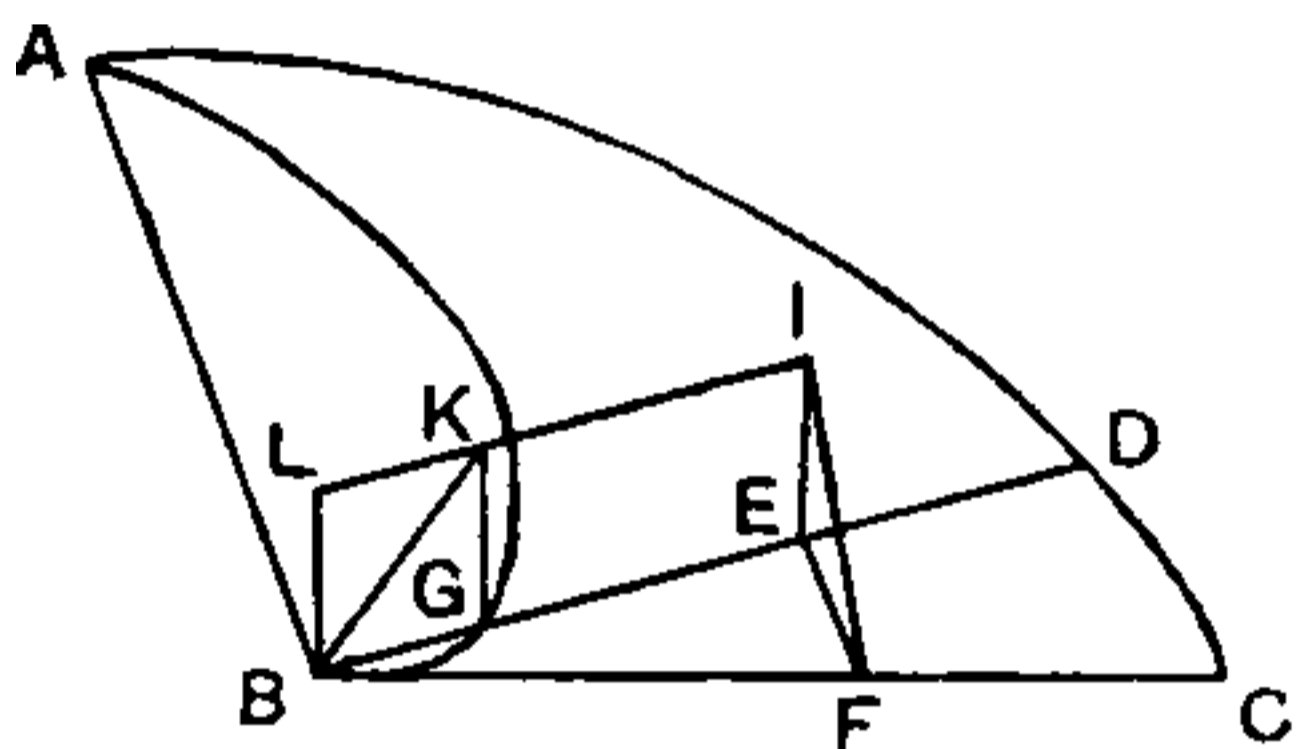

Let a point on AB move uniformly from A to B while, in the same time, AB itself revolves uniformly about B from the position BA to the position BC . The point thus describes the spiral AGB . If the spiral cuts BD in G ,

$$BA : BG = (\text{arc } ADC) : (\text{arc } DC),$$

or $BG : (\text{arc } DC) = BA : (\text{arc } ADC).$

Therefore $BG = EF$.

Draw GK at right angles to the plane ABC and equal to BG . Then GK , and therefore K , lies on a right cylinder with the spiral as base.

But BK also lies on a conical surface with vertex B such that its generators all make an angle of $\frac{1}{4}\pi$ with the plane ABC .

Consequently K lies on the intersection of two surfaces, and therefore on a curve.

Through K draw LKI parallel to BD , and let BL , EI be at right angles to the plane ABC .

Then LKI , moving always parallel to the plane ABC , with one extremity on BL and passing through K on a certain



THIS PAGE IS LOCKED TO FREE MEMBERS

Purchase full membership to immediately unlock this page

DELVE INTO FANTASY, MAGIC, MYTHOLOGY & FOLKLORE

Forgotten Books'
Full Membership gives
access to 797,885 ancient
and modern, fiction and
non-fiction books.

Continue

*Fair usage policy applies

a certain ratio shown in the second figure where ABC is a quadrant of a circle equal to a great circle in the sphere, namely the ratio of the segment ABC to the sector $DABC$.

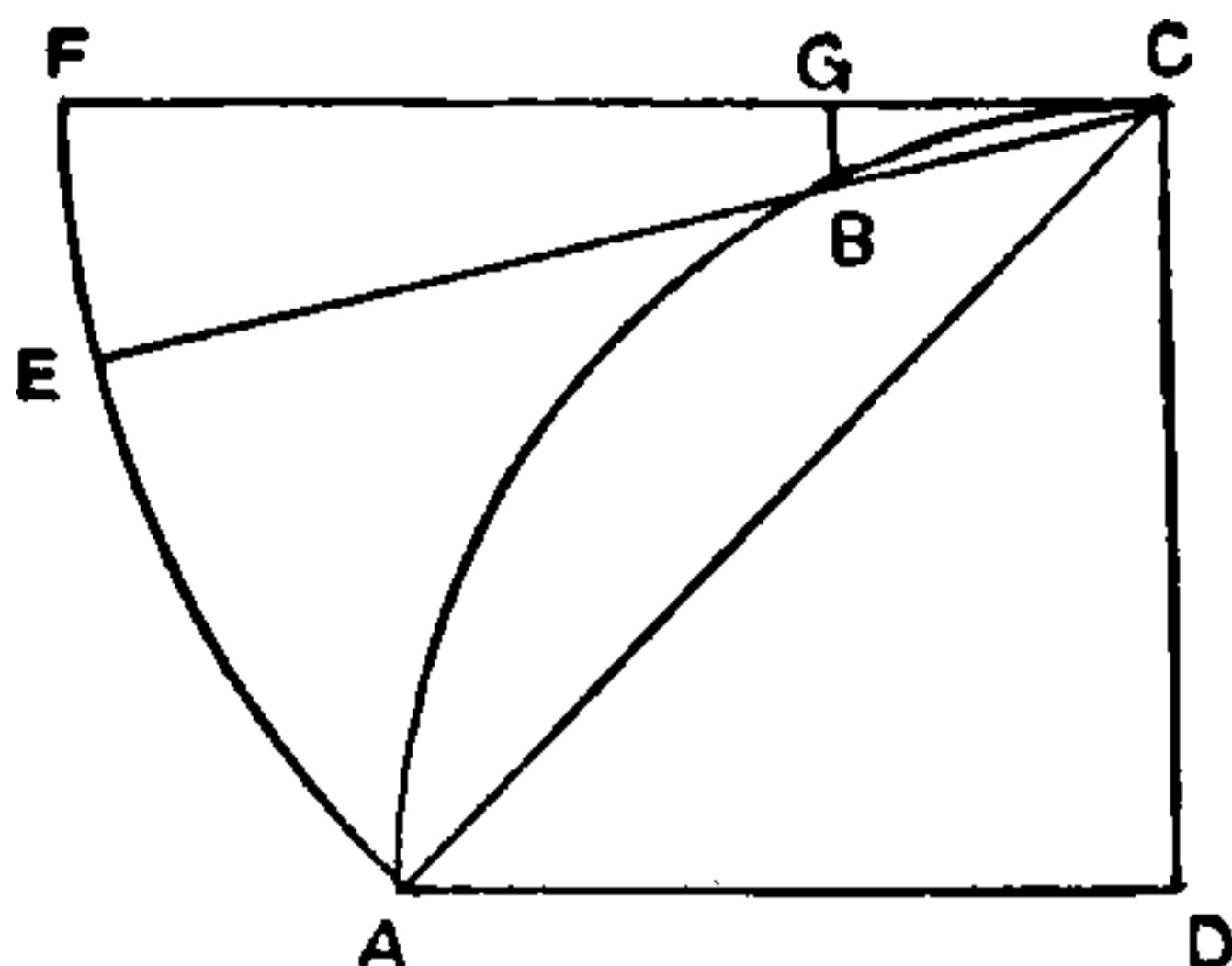

Draw the tangent CF to the quadrant at C . With C as centre and radius CA draw the circle AEF meeting CF in F .

Then the sector CAF is equal to the sector ADC (since $CA^2 = 2AD^2$, while $\angle ACF = \frac{1}{2} \angle ADC$).

It is required, therefore, to prove that, if S be the area cut off by the spiral as above described,

$$S : (\text{surface of hemisphere}) = (\text{segmt. } ABC) : (\text{sector } CAF).$$

Let KL be a (small) fraction, say $1/n$ th, of the circumference of the circle KLM , and let HPL be the quadrant of the great circle through H , L meeting the spiral in P . Then, by the property of the spiral,

$$\begin{aligned} (\text{arc } HP) : (\text{arc } HL) &= (\text{arc } KL) : (\text{circumf. of } KLM) \\ &= 1 : n. \end{aligned}$$

Let the small circle NPQ passing through P be described about the pole H .

Next let FE be the same fraction, $1/n$ th, of the arc FA that KL is of the circumference of the circle KLM , and join EC meeting the arc ABC in B . With C as centre and CB as radius describe the arc BG meeting CF in G .

Then the arc CB is the same fraction, $1/n$ th, of the arc CBA that the arc FE is of FA (for it is easily seen that $\angle FCE = \frac{1}{2} \angle BDC$, while $\angle FCA = \frac{1}{2} \angle CDA$). Therefore, since $(\text{arc } CBA) = (\text{arc } HPL)$, $(\text{arc } CB) = (\text{arc } HP)$, and chord $CB = \text{chord } HP$.

$$\begin{aligned} \text{Now (sector } HPN \text{ on sphere) : (sector } HKL \text{ on sphere)} \\ = (\text{chord } HP)^2 : (\text{chord } HL)^2 \end{aligned}$$

(a consequence of Archimedes, *On Sphere and Cylinder*, I. 42).

$$\begin{aligned} \text{And} \quad HP^2 : HL^2 &= CB^2 : CA^2 \\ &= CB^2 : CE^2. \end{aligned}$$

Therefore

$$(\text{sector } HPN) : (\text{sector } HKL) = (\text{sector } CBG) : (\text{sector } CEF).$$

Similarly, if the arc LL' be taken equal to the arc KL and the great circle through H, L' cuts the spiral in P' , and a small circle described about H and through P' meets the arc HPL in p ; and if likewise the arc BB' is made equal to the arc BC , and CB' is produced to meet AF in E' , while again a circular arc with C as centre and CB' as radius meets CE in b ,

$$\begin{aligned} (\text{sector } HP'p \text{ on sphere) : (sector } HLL' \text{ on sphere)} \\ = (\text{sector } CB'b) : (\text{sector } CE'E). \end{aligned}$$

And so on.

Ultimately then we shall get a figure consisting of sectors on the sphere circumscribed about the area S of the spiral and a figure consisting of sectors of circles circumscribed about the segment CBA ; and in like manner we shall have inscribed figures in each case similarly made up.

The method of exhaustion will then give

$$\begin{aligned} S : (\text{surface of hemisphere}) &= (\text{segmt. } ABC) : (\text{sector } CAF) \\ &= (\text{segmt. } ABC) : (\text{sector } DAC). \end{aligned}$$

[We may, as an illustration, give the analytical equivalent of this proposition. If ρ, ω be the spherical coordinates of P with reference to H as pole and the arc HNK as polar axis, the equation of Pappus's curve is obviously $\omega = 4\rho$.

If now the radius of the sphere is taken as unity, we have as the element of area

$$dA = d\omega (1 - \cos \rho) = 4d\rho (1 - \cos \rho).$$

$$\text{Therefore} \quad A = \int_0^{\frac{1}{2}\pi} 4d\rho (1 - \cos \rho) = 2\pi - 4.$$

Therefore

$$\frac{A}{(\text{surface of hemisphere})} = \frac{2\pi - 4}{2\pi} = \frac{\frac{1}{4}\pi - \frac{1}{2}}{\frac{1}{4}\pi} = \frac{(\text{segment } ABC')}{(\text{sector } DABC)} \cdot]$$

The second part of the last section of Book IV (chaps. 36-41, pp. 270-302) is mainly concerned with the problem of trisecting any given angle or dividing it into parts in any given ratio. Pappus begins with another account of the distinction between *plane*, *solid* and *linear* problems (cf. Book III, chaps. 20-2) according as they require for their solution (1) the straight line and circle only, (2) conics or their equivalent, (3) higher curves still, 'which have a more complicated and forced (or unnatural) origin, being produced from more irregular surfaces and involved motions. Such are the curves which are discovered in the so-called *loci on surfaces*, as well as others more complicated still and many in number discovered by Demetrius of Alexandria in his *Linear considerations* and by Philon of Tyana by means of the interlacing of plectoids and other surfaces of all sorts, all of which curves possess many remarkable properties peculiar to them. Some of these curves have been thought by the more recent writers to be worthy of considerable discussion; one of them is that which also received from Menelaus the name of the *paradoxical* curve. Others of the same class are spirals, quadratrices, cochloids and cissoids.' He adds the often-quoted reflection on the error committed by geometers when they solve a problem by means of an 'inappropriate class' (of curve or its equivalent), illustrating this by the use in Apollonius, Book V, of a rectangular hyperbola for finding the feet of normals to a *parabola* passing through one point (where a circle would serve the purpose), and by the assumption by Archimedes of a *solid νεῦσις* in his book *On Spirals* (see above, pp. 65-8).

Trisection (or division in any ratio) of any angle.

The method of trisecting any angle based on a certain *νεῦσις* is next described, with the solution of the *νεῦσις* itself by



THIS PAGE IS LOCKED TO FREE MEMBERS

Purchase full membership to immediately unlock this page

FORGOTTEN BOOKS

FULL

MEMBERSHIP

797,885 Books!

All you can read

for only

\$8.99/month

Continue

*Fair usage policy applies



length (consistent with a real solution). The problem is best exhibited by means of analytical geometry.

If $BD = a$, $DC = b$, $AD = c$ (so that $DE = ab/c$), we have

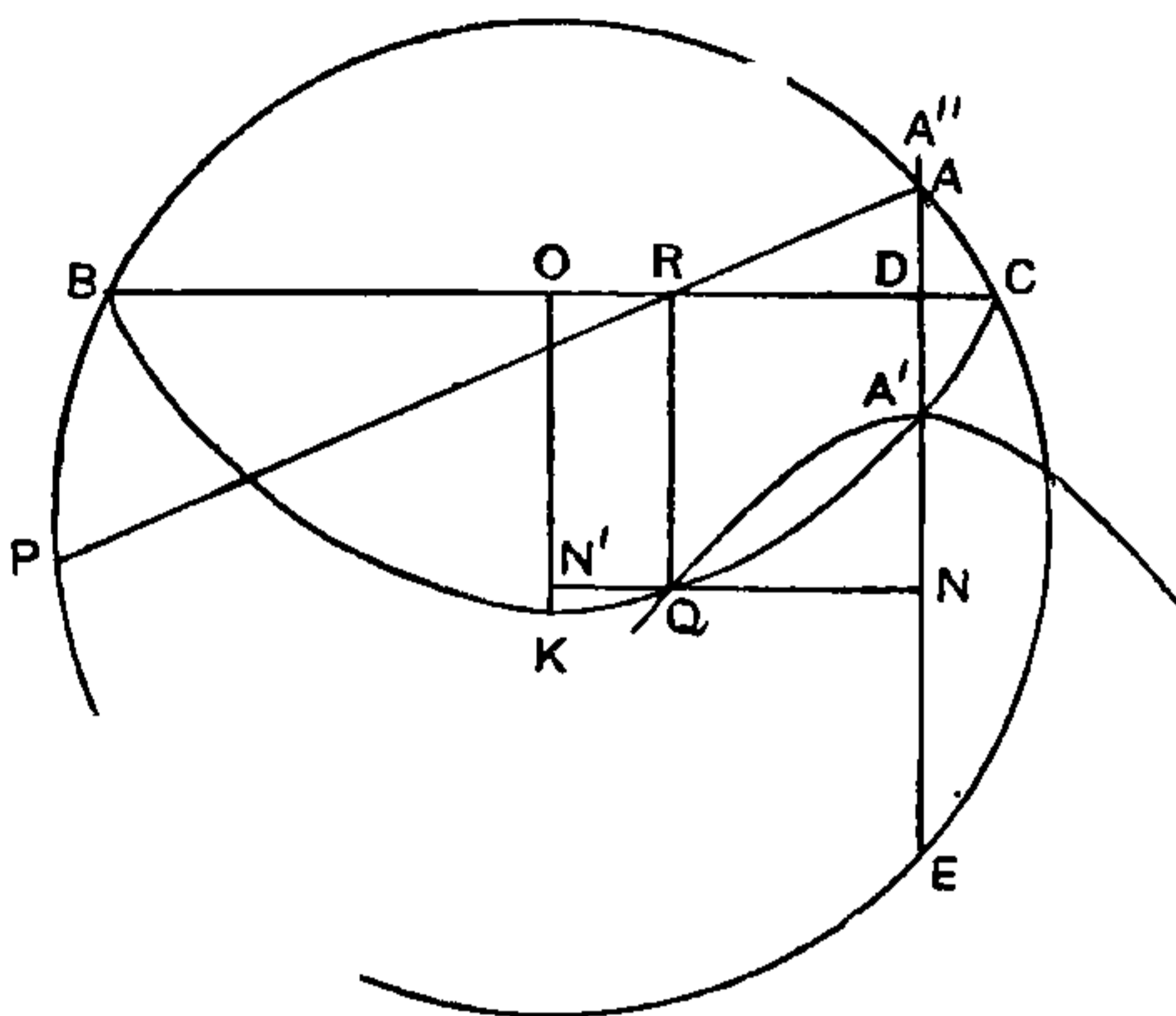

to find the point R on BC such that AR produced solves the problem by making PR equal to k , say.

Let $DR = x$. Then, since $BR \cdot RC = PR \cdot RA$, we have

$$(a-x)(b+x) = k\sqrt{c^2+x^2}.$$

An obvious expedient is to put y for $\sqrt{c^2+x^2}$, when we have

$$(a-x)(b+x) = ky, \tag{1}$$

and
$$y^2 = c^2 + x^2. \tag{2}$$

These equations represent a parabola and a hyperbola respectively, and Pappus does in fact solve the problem by means of the intersection of a parabola and a hyperbola; one of his preliminary lemmas is, however, again a little more general. In the above figure y is represented by RQ .

The first lemma of Pappus (Prop. 42, p. 298) states that, if from a given point A any straight line be drawn meeting a straight line BC given in position in R , and if RQ be drawn at right angles to BC and of length bearing a given ratio to AR , the locus of Q is a *hyperbola*.

For draw AD perpendicular to BC and produce it to A' so that

$$QR:RA = A'D:DA = \text{the given ratio.}$$

Measure DA'' along DA equal to DA' .

Then, if QN be perpendicular to AD ,

$$(AR^2 - AD^2) : (QR^2 - A'D^2) = (\text{const.}),$$

that is, $QN^2 : A'N \cdot A''N = (\text{const.}),$

and the locus of Q is a hyperbola.

The equation of the hyperbola is clearly

$$x^2 = \mu(y^2 - c^2),$$

where μ is a constant. In the particular case taken by Archimedes $QR = RA$, or $\mu = 1$, and the hyperbola becomes the rectangular hyperbola (2) above.

The second lemma (Prop. 43, p. 300) proves that, if BC is given in length, and Q is such a point that, when QR is drawn perpendicular to BC , $BR \cdot RC = k \cdot QR$, where k is a given length, the locus of Q is a *parabola*.

Let O be the middle point of BC , and let OK be drawn at right angles to BC and of length such that

$$OC^2 = k \cdot KO.$$

Let QN' be drawn perpendicular to OK .

$$\begin{aligned} \text{Then } QN'^2 &= OR^2 \\ &= OC^2 - BR \cdot RC \\ &= k \cdot (KO - QR), \text{ by hypothesis,} \\ &= k \cdot KN'. \end{aligned}$$

Therefore the locus of Q is a parabola.

The equation of the parabola referred to DB , DE as axes of x and y is obviously

$$\left\{ \frac{1}{2}(a-b) - x \right\}^2 = k \left\{ \frac{(a+b)^2}{4k} - y \right\},$$

which easily reduces to

$$(a-x)(b+x) = ky, \text{ as above (1).}$$

In Archimedes's particular case $k = ab/c$.

To solve the problem then we have only to draw the parabola and hyperbola in question, and their intersection then gives Q , whence R , and therefore ARP , is determined.

Book V. Preface on the Sagacity of Bees.

It is characteristic of the great Greek mathematicians that, whenever they were free from the restraint of the technical language of mathematics, as when for instance they had occasion to write a preface, they were able to write in language of the highest literary quality, comparable with that of the philosophers, historians, and poets. We have only to recall the introductions to Archimedes's treatises and the prefaces to the different Books of Apollonius's *Conics*. Heron, though severely practical, is no exception when he has any general explanation, historical or other, to give. We have now to note a like case in Pappus, namely the preface to Book V of the *Collection*. The editor, Hultsch, draws attention to the elegance and purity of the language and the careful writing; the latter is illustrated by the studied avoidance of hiatus.¹ The subject is one which a writer of taste and imagination would naturally find attractive, namely the practical intelligence shown by bees in selecting the hexagonal form for the cells in the honeycomb. Pappus does not disappoint us; the passage is as attractive as the subject, and deserves to be reproduced.

‘It is of course to men that God has given the best and most perfect notion of wisdom in general and of mathematical science in particular, but a partial share in these things he allotted to some of the unreasoning animals as well. To men, as being endowed with reason, he vouchsafed that they should do everything in the light of reason and demonstration, but to the other animals, while denying them reason, he granted that each of them should, by virtue of a certain natural instinct, obtain just so much as is needful to support life. This instinct may be observed to exist in very many other species of living creatures, but most of all in bees. In the first place their orderliness and their submission to the queens who rule in their state are truly admirable, but much more admirable still is their emulation, the cleanliness they observe in the gathering of honey, and the forethought and housewifely care they devote to its custody. Presumably because they know themselves to be entrusted with the task of bringing from the gods to the accomplished portion of mankind a share of

¹ Pappus, vol. iii, p. 1233.



THIS PAGE IS LOCKED TO FREE MEMBERS

Purchase full membership to immediately unlock this page

DELVE INTO FANTASY, MAGIC, MYTHOLOGY & FOLKLORE

Forgotten Books'
Full Membership gives
access to 797,885 ancient
and modern, fiction and
non-fiction books.

Continue

*Fair usage policy applies

the same circumference the semicircle is the greatest, with some preliminary lemmas which deserve notice (chaps. 15, 16).

(1) ABC is a triangle right-angled at B . With C as centre and radius CA describe the arc AD cutting CB produced in D .

To prove that (R denoting a right angle)

$$\begin{aligned} (\text{sector } CAD) : (\text{area } ABD) \\ > R : \angle BCA. \end{aligned}$$

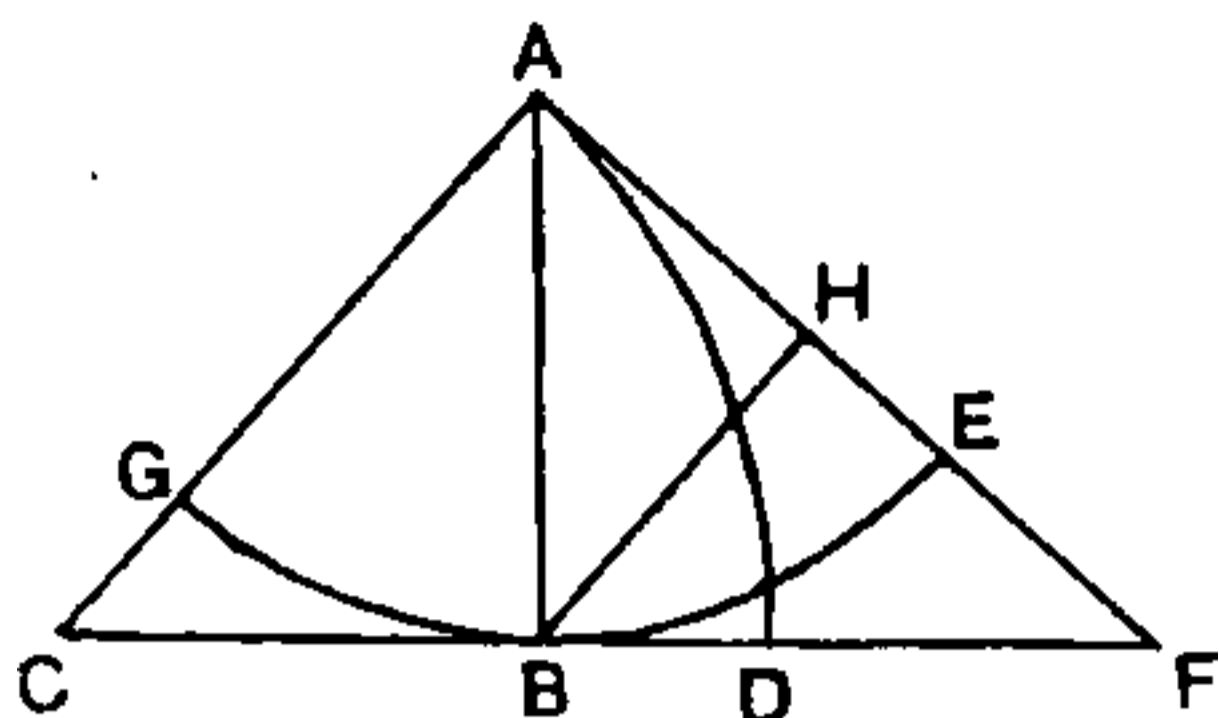

Draw AF at right angles to CA meeting CD produced in F , and draw BH perpendicular to AF . With A as centre and AB as radius describe the arc GBE .

Now $(\text{area } EBF) : (\text{area } EBH) > (\text{area } EBF) : (\text{sector } ABE)$, and, *componendo*, $\Delta FBH : (EBH) > \Delta ABF : (ABE)$.

But (by an easy lemma which has just preceded)

$$\Delta FBH : (EBH) = \Delta ABF : (ABD),$$

whence $\Delta ABF : (ABD) > \Delta ABF : (ABE)$,

and $(ABE) > (ABD)$.

Therefore $(ABE) : (ABG) > (ABD) : (ABG) > (ABD) : \Delta ABC$, *a fortiori*.

Therefore $\angle BAF : \angle BAC > (ABD) : \Delta ABC$,

whence, inversely, $\Delta ABC : (ABD) > \angle BAC : \angle BAF$.

and, *componendo*, $(\text{sector } ACD) : (ABD) > R : \angle BCA$.

[If α be the circular measure of $\angle BCA$, this gives (if $AC = b$)

$$\frac{1}{2} \alpha b^2 : (\frac{1}{2} \alpha b^2 - \frac{1}{2} \sin \alpha \cos \alpha \cdot b^2) > \frac{1}{2} \pi : \alpha,$$

or $2\alpha : (2\alpha - \sin 2\alpha) > \pi : 2\alpha$;

that is, $\theta / (\theta - \sin \theta) > \pi / \theta$, where $0 < \theta < \pi$.]

(2) ABC is again a triangle right-angled at B . With C as centre and CA as radius draw a circle AD meeting BC produced in D . To prove that

$$(\text{sector } CAD) : (\text{area } ABD) > R : \angle ACD.$$

Draw AE at right angles to AC . With A as centre and AC as radius describe the circle FCE meeting AB produced in F and AE in E .

Then, since $\angle ACD > \angle CAE$, (sector ACD) $>$ (sector ACE).

Therefore $(ACD) : \Delta ABC > (ACE) : \Delta ABC$

$> (ACE) : (ACF)$, *a fortiori*,

$> \angle EAC : \angle CAB$.

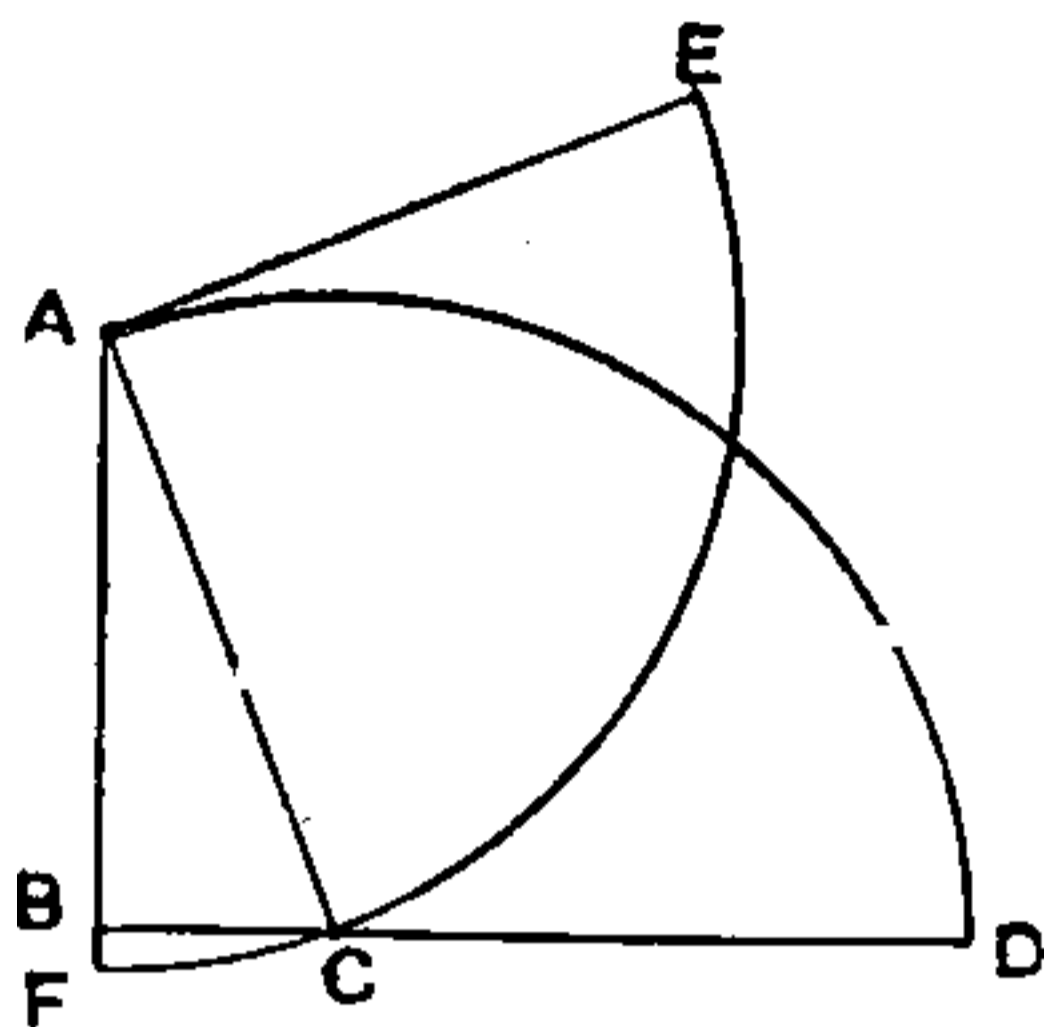

Inversely,

$\Delta ABC : (ACD) < \angle CAB : \angle EAC$,

and, *componendo*,

$(ABD) : (ACD) < \angle EAB : \angle EAC$.

Inversely, $(ACD) : (ABD) > \angle EAC : \angle EAB$

$> R : \angle ACD$.

We come now to the application of these lemmas to the proposition comparing the area of a semicircle with that of other segments of equal circumference (chaps. 17, 18).

A semicircle is the greatest of all segments of circles which have the same circumference.

Let ABC be a semicircle with centre G , and DEF another segment of a circle such that the circumference DEF is equal

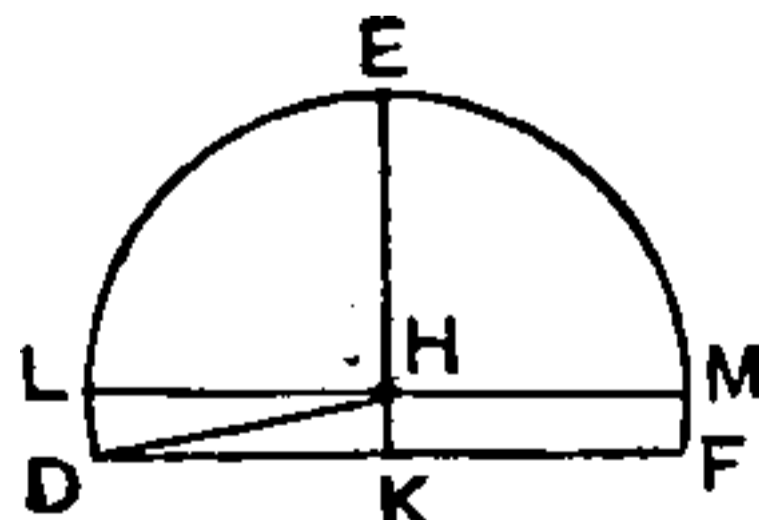
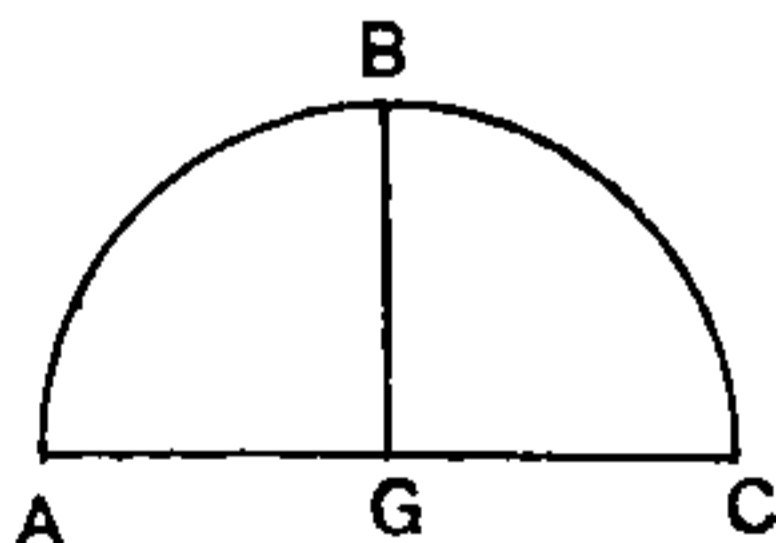
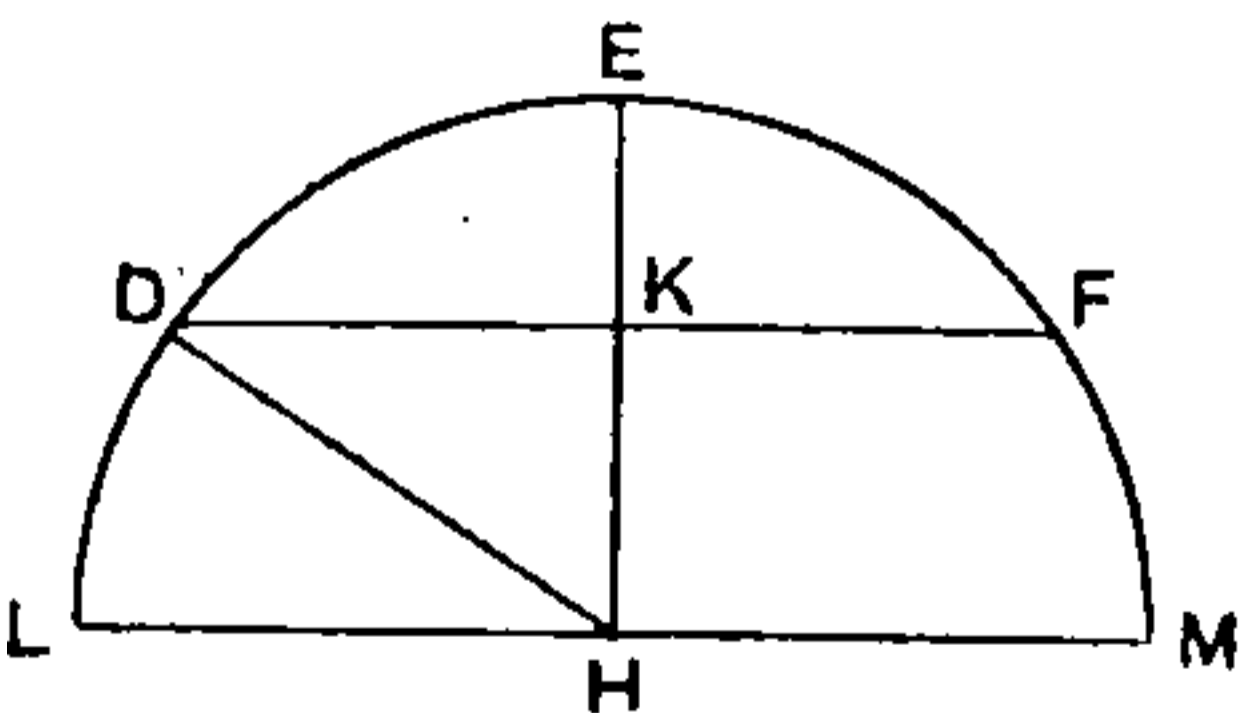

to the circumference ABC . I say that the area of ABC is greater than the area of DEF .

Let H be the centre of the circle DEF . Draw EHK , BG at right angles to DF , AC respectively. Join DH , and draw LHM parallel to DF .

$$\begin{aligned} \text{Then} \quad LH:AG &= (\text{arc } LE) : (\text{arc } AB) \\ &= (\text{arc } LE) : (\text{arc } DE) \\ &= (\text{sector } LHE) : (\text{sector } DHE). \end{aligned}$$

$$\text{Also} \quad LH^2:AG^2 = (\text{sector } LHE) : (\text{sector } AGB).$$

Therefore the sector LHE is to the sector AGB in the ratio duplicate of that which the sector LHE has to the sector DHE .

Therefore

$$(\text{sector } LHE) : (\text{sector } DHE) = (\text{sector } DHE) : (\text{sector } AGB).$$

Now (1) in the case of the segment less than a semicircle and (2) in the case of the segment greater than a semicircle

$$(\text{sector } EDH) : (EDK) > R : \angle DHE,$$

by the lemmas (1) and (2) respectively.

That is,

$$\begin{aligned} (\text{sector } EDH) : (EDK) &> \angle LHE : \angle DHE \\ &> (\text{sector } LHE) : (\text{sector } DHE) \\ &> (\text{sector } EDH) : (\text{sector } AGB), \end{aligned}$$

from above.

Therefore the half segment EDK is less than the half semicircle AGB , whence the semicircle ABC is greater than the segment DEF .

We have already described the content of Zenodorus's treatise (pp. 207–13, above) to which, so far as plane figures are concerned, Pappus added nothing except the above proposition relating to segments of circles.

Section (2). *Comparison of volumes of solids having their surfaces equal. Case of the sphere.*

The portion of Book V dealing with solid figures begins (p. 350. 20) with the statement that the philosophers who considered that the creator gave the universe the form of a sphere because that was the most beautiful of all shapes also asserted that the sphere is the greatest of all solid figures



THIS PAGE IS LOCKED TO FREE MEMBERS

Purchase full membership to immediately unlock this page

FORGOTTEN BOOKS

FULL

MEMBERSHIP

797,885 Books!

All you can read

for only

\$8.99/month

Continue

*Fair usage policy applies



of the sphere, Pappus quotes Archimedes, *On the Sphere and Cylinder*, but thinks proper to add a series of propositions (chaps. 20–43, pp. 362–410) on much the same lines as those of Archimedes and leading to the same results as Archimedes obtains for the surface of a segment of a sphere and of the whole sphere (Prop. 28), and for the volume of a sphere (Prop. 35). Prop. 36 (chap. 42) shows how to divide a sphere into two segments such that their surfaces are in a given ratio and Prop. 37 (chap. 43) proves that the volume as well as the surface of the cylinder circumscribing a sphere is $1\frac{1}{2}$ times that of the sphere itself.

Among the lemmatic propositions in this section of the Book Props. 21, 22 may be mentioned. Prop. 21 proves that, if C, E be two points on the tangent at H to a semicircle such that $CH = HE$, and if CD, EF be drawn perpendicular to the diameter AB , then $(CD + EF) CE = AB \cdot DF$; Prop. 22 proves a like result where C, E are points on the semicircle, CD, EF are as before perpendicular to AB , and EH is the chord of the circle subtending the arc which with CE makes up a semicircle; in this case $(CD + EF) CE = EH \cdot DF$. Both results are easily seen to be the equivalent of the trigonometrical formula

$$\sin(x + y) + \sin(x - y) = 2 \sin x \cos y,$$

or, if certain different angles be taken as x, y ,

$$\frac{\sin x + \sin y}{\cos y - \cos x} = \cot \frac{1}{2}(x - y).$$

Section (5). *Of regular solids with surfaces equal, that is greater which has more faces.*

Returning to the main problem of the Book, Pappus shows that, of the five regular solid figures assumed to have their surfaces equal, that is greater which has the more faces, so that the pyramid, the cube, the octahedron, the dodecahedron and the icosahedron of equal surface are, as regards solid content, in ascending order of magnitude (Props. 38–56). Pappus indicates (p. 410. 27) that ‘some of the ancients’ had worked out the proofs of these propositions by the analytical method; for himself, he will give a method of his own by

synthetical deduction, for which he claims that it is clearer and shorter. We have first propositions (with auxiliary lemmas) about the perpendiculars from the centre of the circumscribing sphere to a face of (*a*) the octahedron, (*b*) the icosahedron (Props. 39, 43), then the proposition that, if a dodecahedron and an icosahedron be inscribed in the same sphere, the same small circle in the sphere circumscribes both the pentagon of the dodecahedron and the triangle of the icosahedron (Prop. 48); this last is the proposition proved by Hypsicles in the so-called 'Book XIV of Euclid', Prop. 2, and Pappus gives two methods of proof, the second of which (chap. 56) corresponds to that of Hypsicles. Prop. 49 proves that twelve of the regular pentagons inscribed in a circle are together greater than twenty of the equilateral triangles inscribed in the same circle. The final propositions proving that the cube is greater than the pyramid with the same surface, the octahedron greater than the cube, and so on, are Props. 52–6 (chaps. 60–4). Of Pappus's auxiliary propositions, Prop. 41 is practically contained in Hypsicles's Prop. 1, and Prop. 44 in Hypsicles's last lemma; but otherwise the exposition is different.

Book VI.

On the contents of Book VI we can be brief. It is mainly astronomical, dealing with the treatises included in the so-called *Little Astronomy*, that is, the smaller astronomical treatises which were studied as an introduction to the great *Syntaxis* of Ptolemy. The preface says that many of those who taught the *Treasury of Astronomy*, through a careless understanding of the propositions, added some things as being necessary and omitted others as unnecessary. Pappus mentions at this point an incorrect addition to Theodosius, *Sphaerica*, III. 6, an omission from Euclid's *Phaenomena*, Prop. 2, an inaccurate representation of Theodosius, *On Days and Nights*, Prop. 4, and the omission later of certain other things as being unnecessary. His object is to put these mistakes right. Allusions are also found in the Book to Menelaus's *Sphaerica*, e.g. the statement (p. 476. 16) that Menelaus in his *Sphaerica* called a spherical triangle *τρίπλευρον*, *three-side*.

The *Sphaerica* of Theodosius is dealt with at some length (chaps. 1–26, Props. 1–27), and so are the theorems of Autolycus *On the moving Sphere* (chaps. 27–9), Theodosius *On Days and Nights* (chaps. 30–6, Props. 29–38), Aristarchus *On the sizes and distances of the Sun and Moon* (chaps. 37–40, including a proposition, Prop. 39 with two lemmas, which is corrupt at the end and is not really proved), Euclid's *Optics* (chaps. 41–52, Props. 42–54), and Euclid's *Phaenomena* (chaps. 53–60, Props. 55–61).

Problem arising out of Euclid's 'Optics'.

There is little in the Book of general mathematical interest except the following propositions which occur in the section on Euclid's *Optics*.

Two propositions are fundamental in solid geometry, namely:

(a) If from a point A above a plane AB be drawn perpendicular to the plane, and if from B a straight line BD be drawn perpendicular to any straight line EF in the plane, then will AD also be perpendicular to EF (Prop. 43).

(b) If from a point A above a plane AB be drawn to the plane but not at right angles to it, and AM be drawn perpendicular to the plane (i.e. if BM be the orthogonal projection of BA on the plane), the angle ABM is the least of all the angles which AB makes with any straight lines through B , as BP , in the plane; the angle ABP increases as BP moves away from BM on either side; and, given any straight line BP making a certain angle with BA , only one other straight line in the plane will make the same angle with BA , namely a straight line BP' on the other side of BM making the same angle with it that BP does (Prop. 44).

These are the first of a series of lemmas leading up to the main problem, the investigation of the apparent form of a circle as seen from a point outside its plane. In Prop. 50 (= Euclid, *Optics*, 34) Pappus proves the fact that all the diameters of the circle will appear equal if the straight line drawn from the point representing the eye to the centre of the circle is either (a) at right angles to the plane of the circle or (b), if not at right angles to the plane of the circle, is equal.



THIS PAGE IS LOCKED TO FREE MEMBERS

Purchase full membership to immediately unlock this page

DELVE INTO FANTASY, MAGIC, MYTHOLOGY & FOLKLORE

Forgotten Books'
Full Membership gives
access to 797,885 ancient
and modern, fiction and
non-fiction books.

Continue

*Fair usage policy applies

The test of apparent equality is of course that the two straight lines should subtend equal angles at F .

The main points in the proof are these. The plane through CF, CK is perpendicular to the planes BFE, PFM and LFR ; hence CF is perpendicular to BE, QF to PM and HF to LR , whence BC and CE subtend equal angles at F : so do LH, HR , and PQ, QM .

Since FC bisects the angle AFD , and $AC:CD = AK:KD$ (by the polar property), $\angle CFK$ is a right angle. And CF is the intersection of two planes at right angles, namely AFK and BFE , in the former of which FK lies; therefore KF is perpendicular to the plane BFE , and therefore to FN . Since therefore (by the polar property) $LN:NP = LK:KP$, it follows that the angle LFP is bisected by FN ; hence LN, NP are apparently equal.

Again $LC:CM = LN:NP = LF:FP = LF:FM$.

Therefore the angles LFC, CFM are equal, and LC, CM are apparently equal.

Lastly $LR:PM = LK:KP = LN:NP = LF:FP$; therefore the isosceles triangles FLR, FPM are equiangular; therefore the angles PFM, LFR , and consequently PFQ, LFH , are equal. Hence LP, RM will appear to be parallel to AD .

We have, based on this proposition, an easy method of solving Pappus's final problem (Prop. 54). 'Given a circle $ABDE$ and any point within it, to find outside the plane of the circle a point from which the circle will have the appearance of an ellipse with centre C .'

We have only to produce the diameter AD through C to the pole K of the chord BE perpendicular to AD and then, in the plane through AK perpendicular to the plane of the circle, to describe a semicircle on CK as diameter. Any point F on this semicircle satisfies the condition.

Book VII. *On the 'Treasury of Analysis'.*

Book VII is of much greater importance, since it gives an account of the books forming what was called the *Treasury of Analysis* (*ἀναλυόμενος τόπος*) and, as regards those of the books which are now lost, Pappus's account, with the hints derivable from the large collection of lemmas supplied by him to each

book, practically constitutes our only source of information. The Book begins (p. 634) with a definition of *analysis* and *synthesis* which, as being the most elaborate Greek utterance on the subject, deserves to be quoted in full.

‘The so-called *Ἀναλυόμενος* is, to put it shortly, a special body of doctrine provided for the use of those who, after finishing the ordinary Elements, are desirous of acquiring the power of solving problems which may be set them involving (the construction of) lines, and it is useful for this alone. It is the work of three men, Euclid the author of the Elements, Apollonius of Perga and Aristaeus the elder, and proceeds by way of analysis and synthesis.’

Definition of Analysis and Synthesis.

‘*Analysis*, then, takes that which is sought as if it were admitted and passes from it through its successive consequences to something which is admitted as the result of synthesis: for in analysis we assume that which is sought as if it were already done (*γεγονός*), and we inquire what it is from which this results, and again what is the antecedent cause of the latter, and so on, until by so retracing our steps we come upon something already known or belonging to the class of first principles, and such a method we call analysis as being solution backwards (*ἀνάπαλιν λύσιν*).

‘But in *synthesis*, reversing the process, we take as already done that which was last arrived at in the analysis and, by arranging in their natural order as consequences what before were antecedents, and successively connecting them one with another, we arrive finally at the construction of what was sought; and this we call synthesis.

‘Now analysis is of two kinds, the one directed to searching for the truth and called *theoretical*, the other directed to finding what we are told to find and called *problematical*. (1) In the *theoretical* kind we assume what is sought as if it were existent and true, after which we pass through its successive consequences, as if they too were true and established by virtue of our hypothesis, to something admitted: then (a), if that something admitted is true, that which is sought will also be true and the proof will correspond in the reverse order to the analysis, but (b), if we come upon something admittedly false, that which is sought will also be false. (2) In the *problematical* kind we assume that which is propounded as if it were known, after which we pass through its

successive consequences, taking them as true, up to something admitted: if then (a) what is admitted is possible and obtainable, that is, what mathematicians call *given*, what was originally proposed will also be possible, and the proof will again correspond in the reverse order to the analysis, but if (b) we come upon something admittedly impossible, the problem will also be impossible.'

This statement could hardly be improved upon except that it ought to be added that each step in the chain of inference in the analysis must be *unconditionally convertible*; that is, when in the analysis we say that, if A is true, B is true, we must be sure that each statement is a necessary consequence of the other, so that the truth of A equally follows from the truth of B . This, however, is almost implied by Pappus when he says that we inquire, not what it is (namely B) which follows from A , but what it is (B) from which A follows, and so on.

List of works in the 'Treasury of Analysis'.

Pappus adds a list, in order, of the books forming the *Ἀναλυόμενος*, namely:

'Euclid's *Data*, one Book, Apollonius's *Cutting-off of a ratio*, two Books, *Cutting-off of an area*, two Books, *Determinate Section*, two Books, *Contacts*, two Books, Euclid's *Porisms*, three Books, Apollonius's *Inclinations or Vergings* (*νεύσεις*), two Books, the same author's *Plane Loci*, two Books, and *Conics*, eight Books, Aristaeus's *Solid Loci*, five Books, Euclid's *Surface-Loci*, two Books, Eratosthenes's *On means*, two Books. There are in all thirty-three Books, the contents of which up to the *Conics* of Apollonius I have set out for your consideration, including not only the number of the propositions, the *diorismi* and the cases dealt with in each Book, but also the lemmas which are required; indeed I have not, to the best of my belief, omitted any question arising in the study of the Books in question.'

Description of the treatises.

Then follows the short description of the contents of the various Books down to Apollonius's *Conics*; no account is given of Aristaeus's *Solid Loci*, Euclid's *Surface-Loci* and



THIS PAGE IS LOCKED TO FREE MEMBERS

Purchase full membership to immediately unlock this page

FORGOTTEN BOOKS

FULL

MEMBERSHIP

797,885 Books!

All you can read

for only

\$8.99/month

Continue

*Fair usage policy applies



utility. In justification of this statement and 'in order that he may not appear empty-handed when leaving the subject', he will present his readers with the following.

(Anticipation of Guldin's Theorem.)

The enunciations are not very clearly worded, but there is no doubt as to the sense.

'Figures generated by a complete revolution of a plane figure about an axis are in a ratio compounded (1) of the ratio of the areas of the figures, and (2) of the ratio of the straight lines similarly drawn to (i.e. drawn to meet at the same angles) the axes of rotation from the respective centres of gravity. Figures generated by incomplete revolutions are in the ratio compounded (1) of the ratio of the areas of the figures and (2) of the ratio of the arcs described by the centres of gravity of the respective figures, the latter ratio being itself compounded (a) of the ratio of the straight lines similarly drawn (from the respective centres of gravity to the axes of rotation) and (b) of the ratio of the angles contained (i.e. described) about the axes of revolution by the extremities of the said straight lines (i.e. the centres of gravity).'

Here, obviously, we have the essence of the celebrated theorem commonly attributed to P. Guldin (1577–1643), 'quantitas rotunda in viam rotationis ducta producit Potestatem Rotundam uno grado altiore Potestate sive Quantitate Rotata'.¹

Pappus adds that

'these propositions, which are practically one, include any number of theorems of all sorts about curves, surfaces, and solids, all of which are proved at once by one demonstration, and include propositions both old and new, and in particular those proved in the twelfth Book of these Elements.'

Hultsch attributes the whole passage (pp. 680. 30–682. 20) to an interpolator, I do not know for what reason; but it seems to me that the propositions are quite beyond what could be expected from an interpolator, indeed I know of no Greek mathematician from Pappus's day onward except Pappus himself who was capable of discovering such a proposition.

¹ *Centrobarryca*, Lib. ii, chap. viii, Prop. 3. Viennae 1641.

If the passage is genuine, it seems to indicate, what is not elsewhere confirmed, that the *Collection* originally contained, or was intended to contain, twelve Books.

Lemmas to the different treatises.

After the description of the treatises forming the *Treasury of Analysis* come the collections of lemmas given by Pappus to assist the student of each of the books (except Euclid's *Data*) down to Apollonius's *Conics*, with two isolated lemmas to the *Surface-Loci* of Euclid. It is difficult to give any summary or any general idea of these lemmas, because they are very numerous, extremely various, and often quite difficult, requiring first-rate ability and full command of all the resources of pure geometry. Their number is also greatly increased by the addition of alternative proofs, often requiring lemmas of their own, and by the separate formulation of particular cases where by the use of algebra and conventions with regard to sign we can make one proposition cover all the cases. The style is admirably terse, often so condensed as to make the argument difficult to follow without some little filling-out; the hand is that of a master throughout. The only misfortune is that, the books elucidated being lost (except the *Conics* and the *Cutting-off of a ratio* of Apollonius), it is difficult, often impossible, to see the connexion of the lemmas with one another and the problems of the book to which they relate. In the circumstances, all that I can hope to do is to indicate the types of propositions included in the lemmas and, by way of illustration, now and then to give a proof where it is sufficiently out of the common.

(*a*) Pappus begins with Lemmas to the *Sectio rationis* and *Sectio spatii* of Apollonius (Props. 1–21, pp. 684–704). The first two show how to divide a straight line in a given ratio, and how, given the first, second and fourth terms of a proportion between straight lines, to find the third term. The next section (Props. 3–12 and 16) shows how to manipulate relations between greater and less ratios by transforming them, e.g. *componendo*, *convertendo*, &c., in the same way as Euclid transforms *equal* ratios in Book V; Prop. 16 proves that, according as $a:b >$ or $< c:d$, $ad >$ or $< bc$. Props.

17–20 deal with three straight lines a, b, c in geometrical progression, showing how to mark on a straight line containing a, b, c as segments (including the whole among ‘segments’), lengths equal to $a + c \pm 2\sqrt{ac}$; the lengths are of course equal to $a + c \pm 2b$ respectively. These lemmas are preliminary to the problem (Prop. 21), Given two straight lines AB, BC (C lying between A and B), to find a point D on BA produced such that $BD:DA = CD:(AB + BC - 2\sqrt{AB \cdot BC})$. This is, of course, equivalent to the quadratic equation $(a+x):x = (a-c+x):(a+c-2\sqrt{ac})$, and, after marking off AE along AD equal to the fourth term of this proportion, Pappus solves the equation in the usual way by application of areas.

(β) *Lemmas to the ‘Determinate Section’ of Apollonius.*

The next set of Lemmas (Props. 22–64, pp. 704–70) belongs to the *Determinate Section* of Apollonius. As we have seen (pp. 180–1, above), this work seems to have amounted to a *Theory of Involution*. Whether the application of certain of Pappus’s lemmas corresponded to the conjecture of Zeuthen or not, we have at all events in this set of lemmas some remarkable applications of ‘geometrical algebra’. They may be divided into groups as follows

I. Props. 22, 25, 29.

If in the figure $AD \cdot DC = BD \cdot DE$, then

$$BD:DE = AB \cdot BC:AE \cdot EC.$$



The proofs by proportions are not difficult. Prop. 29 is an alternative proof by means of Prop. 26 (see below). The algebraic equivalent may be expressed thus: if $ax = by$, then

$$\frac{b}{y} = \frac{(a+b)(b+x)}{(a+y)(x+y)}.$$

II. Props. 30, 32, 34.

If in the same figure $AD \cdot DE = BD \cdot DC$, then

$$BD:DC = AB \cdot BE:EC \cdot CA.$$



THIS PAGE IS LOCKED TO FREE MEMBERS

Purchase full membership to immediately unlock this page

DELVE INTO FANTASY, MAGIC, MYTHOLOGY & FOLKLORE

Forgotten Books'
Full Membership gives
access to 797,885 ancient
and modern, fiction and
non-fiction books.

Continue

*Fair usage policy applies

Two proofs are given of the first theorem. We will give the first (Prop. 26) because it is a case of *theoretical analysis* followed by *synthesis*. Describe a circle about ABD : produce EA , CA to meet the circle again in F , G , and join BF , FG .

Substituting $GC \cdot CA$ for $BC \cdot CD$ and $FE \cdot EA$ for $BE \cdot ED$, we have to inquire whether $GC \cdot CA : CA^2 = FE \cdot EA : AE^2$,

i.e. whether $GC : CA = FE : EA$,

i.e. whether $GA : AC = FA : AE$,

i.e. whether the triangles GAF , CAE are similar or, in other words, whether GF is parallel to BC .

But GF is parallel to BC , because, the angles BAC , DAE being supplementary, $\angle DAE = \angle GAB = \angle GFB$, while at the same time $\angle DAE = \text{suppt. of } \angle FAD = \angle FBD$.

The synthesis is obvious.

An alternative proof (Prop. 27) dispenses with the circle, and only requires EKH to be drawn parallel to CA to meet AB , AD in H , K .

Similarly (Prop. 28) for case (b) it is only necessary to draw FG through D parallel to AC meeting BA in F and AE produced in G .

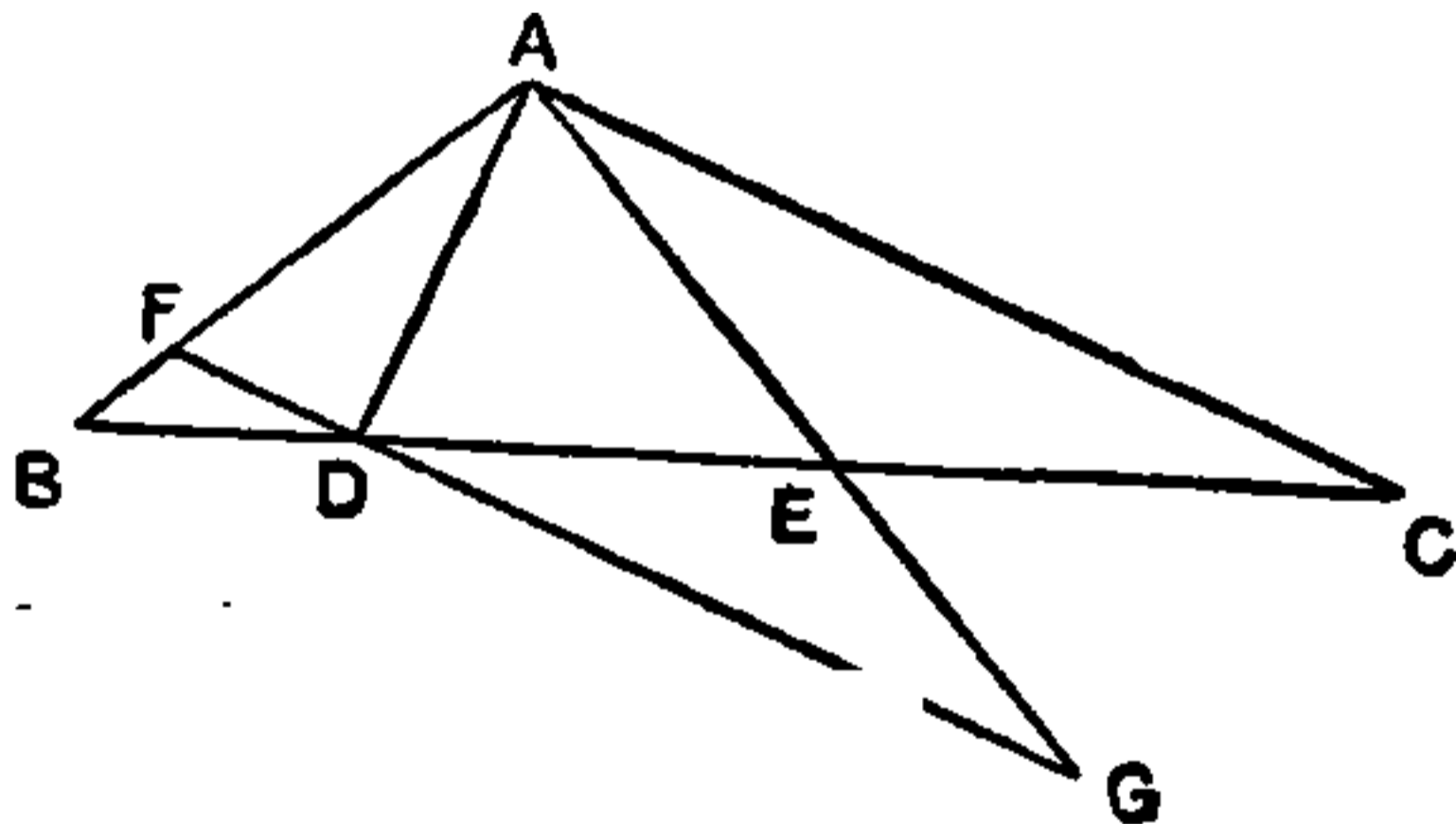

Then, $\angle FAG$, $\angle ADF$ ($= \angle DAC$) being both right angles, $FD \cdot DG = DA^2$.

Therefore $CA^2 : AD^2 = CA^2 : FD \cdot DG = (CA : FD) \cdot (CA : DG)$
 $= (BC : BD) \cdot (CE : DE)$
 $= BC \cdot CE : BD \cdot DE$.

In case (c) a circle is circumscribed to ADE cutting AB in F and AC in G . Then, since $\angle FAD = \angle GAE$, the arcs DF , EG are equal and therefore FG is parallel to DE . The proof is like that of case (a).

VI. Props. 37, 38.

If $AB:BC = AD^2:DC^2$, whether AB be greater or less than AD , then

$$AB \cdot BC = BD^2.$$

[E in the figure is a point such that $ED = CD$.]

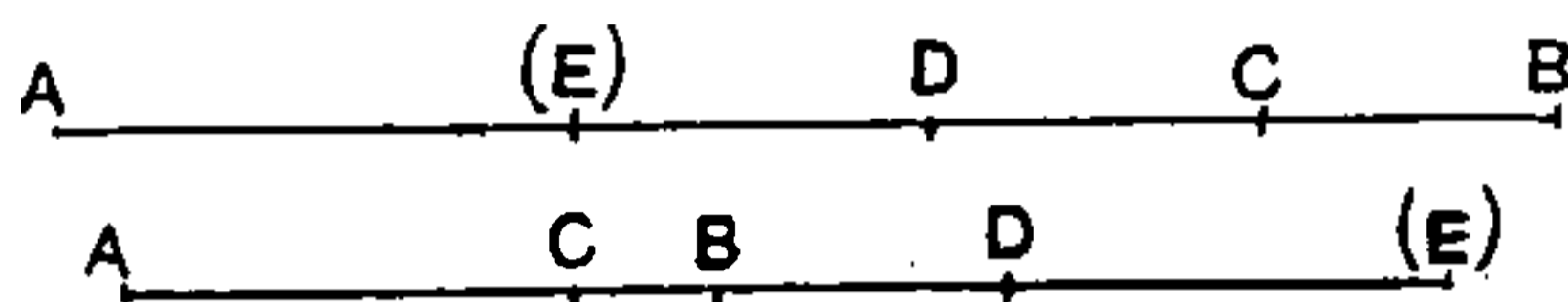

The algebraical equivalent is: If $\frac{a}{c} = \frac{(a \pm b)^2}{(b \pm c)^2}$, then $ac = b^2$.

These lemmas are subsidiary to the next (Props. 39, 40), being used in the first proofs of them.

Props. 39, 40 prove the following:

If $ACDEB$ be a straight line, and if

$$BA \cdot AE : BD \cdot DE = AC^2 : CD^2,$$

then

$$AB \cdot BD : AE \cdot ED = BC^2 : CE^2;$$

if, again,

$$AC \cdot CB : AE \cdot EB = CD^2 : DE^2,$$

then

$$EA \cdot AC : CB \cdot BE = AD^2 : DB^2.$$

If $AB = a$, $BC = b$, $BD = c$, $BE = d$, the algebraic equivalents are the following.

$$\text{If } \frac{a(a-d)}{c(c-d)} = \frac{(a-b)^2}{(b-c)^2}, \text{ then } \frac{ac}{(a-d)(c-d)} = \frac{b^2}{(b-d)^2};$$

$$\text{and if } \frac{(a-b)b}{(a-d)d} = \frac{(b-c)^2}{(c-d)^2}, \text{ then } \frac{(a-d)(a-b)}{bd} = \frac{(a-c)^2}{c^2}.$$

VII. Props. 41, 42, 43.

If $AD \cdot DC = BD \cdot DE$, suppose that in Figures (1) and (2)

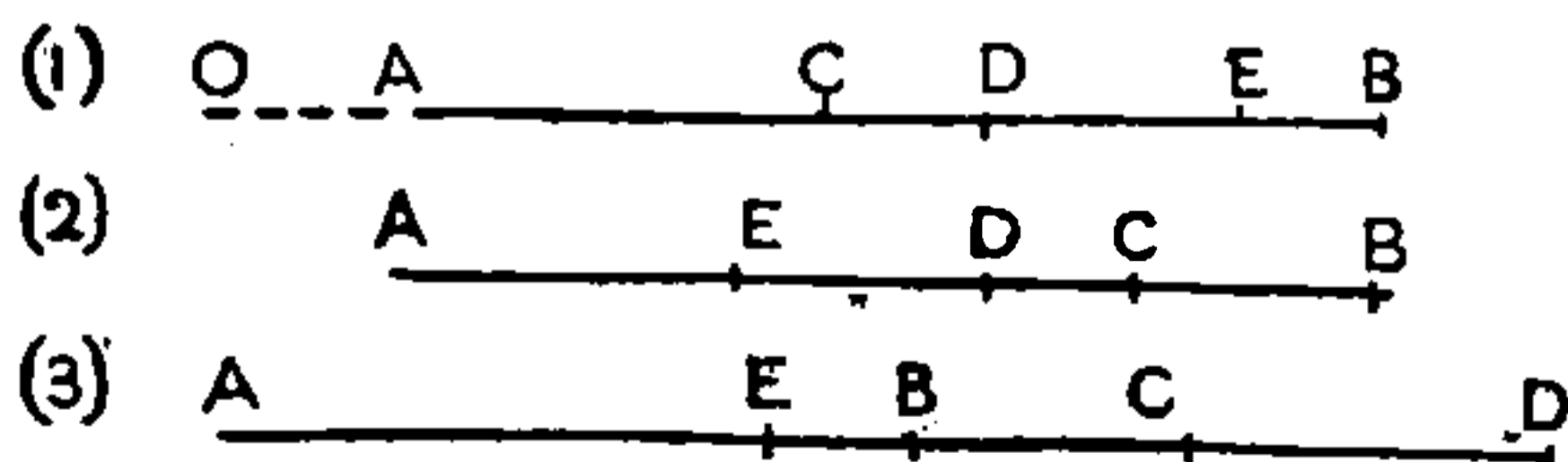

$k = AE + CB$, and in Figure (3) $k = AE - BC$, then

$$k \cdot AD = BA \cdot AE, \quad k \cdot CD = BC \cdot CE, \quad k \cdot BD = AB \cdot BC,$$

$$k \cdot DE = AE \cdot EC.$$

The algebraical equivalents for Figures (1) and (2) respectively may be written (if $a = AD$, $b = DC$, $c = BD$, $d = DE$):

$$\begin{aligned} \text{If } ab = cd, \text{ then } (a \pm d + c \pm b) a &= (a + c) (a \pm d), \\ (a \pm d + c \pm b) b &= (c \pm b) (b + d), \\ (a \pm d + c \pm b) c &= (c + a) (c \pm b), \\ (a \pm d + c \pm b) d &= (a \pm d) (d + b). \end{aligned}$$

Figure (3) gives other varieties of sign. Troubles about sign can be avoided by measuring all lengths in one direction from an origin O outside the line. Thus, if $OA = a$, $OB = b$, &c., the proposition may be as follows:

$$\begin{aligned} \text{If } (d - a) (d - c) &= (b - d) (e - d) \text{ and } k = e - a + b - c, \\ \text{then } k (d - a) &= (b - a) (e - a), \quad k (d - c) = (b - c) (e - c), \\ k (b - d) &= (b - a) (b - c) \text{ and } k (e - d) = (e - a) (e - c). \end{aligned}$$

VIII. Props. 45-56.

More generally, if $AD : DC = BD . DE$ and $k = AE \pm BC$, then, if F be any point on the line, we have, according to the position of F in relation to A, B, C, D, E ,

$$\pm AF . FC \pm EF . FB = k . DF.$$

Algebraically, if $OA = a$, $OB = b \dots OF = x$, the equivalent is: If $(d - a) (d - c) = (b - d) (e - d)$, and $k = (e - a) + (b - c)$, then

$$(x - a) (x - c) + (x - e) (b - x) = k (x - d).$$

By making $x = a, b, c, e$ successively in this equation, we obtain the results of Props. 41-3 above.

IX. Props. 59-64.

In this group Props. 59, 60, 63 are lemmas required for the remarkable propositions (61, 62, 64) in which Pappus investigates 'singular and minimum' values of the ratio

$$AP . PD : BP . PC,$$

where $(A, D), (B, C)$ are point-pairs on a straight line and P is another point on the straight line. He finds, not only when the ratio has the 'singular and minimum (or maximum)' value,



THIS PAGE IS LOCKED TO FREE MEMBERS

Purchase full membership to immediately unlock this page

FORGOTTEN BOOKS

FULL

MEMBERSHIP

797,885 Books!

All you can read

for only

\$8.99/month

Continue

*Fair usage policy applies



Now suppose $(A, D), (B, C)$ to be two point-pairs on a straight line, and let P , another point on it, be determined by the relation

$$AB \cdot BD : AC \cdot CD = BP^2 : CP^2;$$

then, says Pappus, the ratio $AP \cdot PD : BP \cdot PC$ is singular and a minimum, and is equal to

$$AD^2 : (\sqrt{AC \cdot BD} - \sqrt{AB \cdot CD})^2.$$

On AD as diameter draw a circle, and draw BF, CG perpendicular to AD on opposite sides.

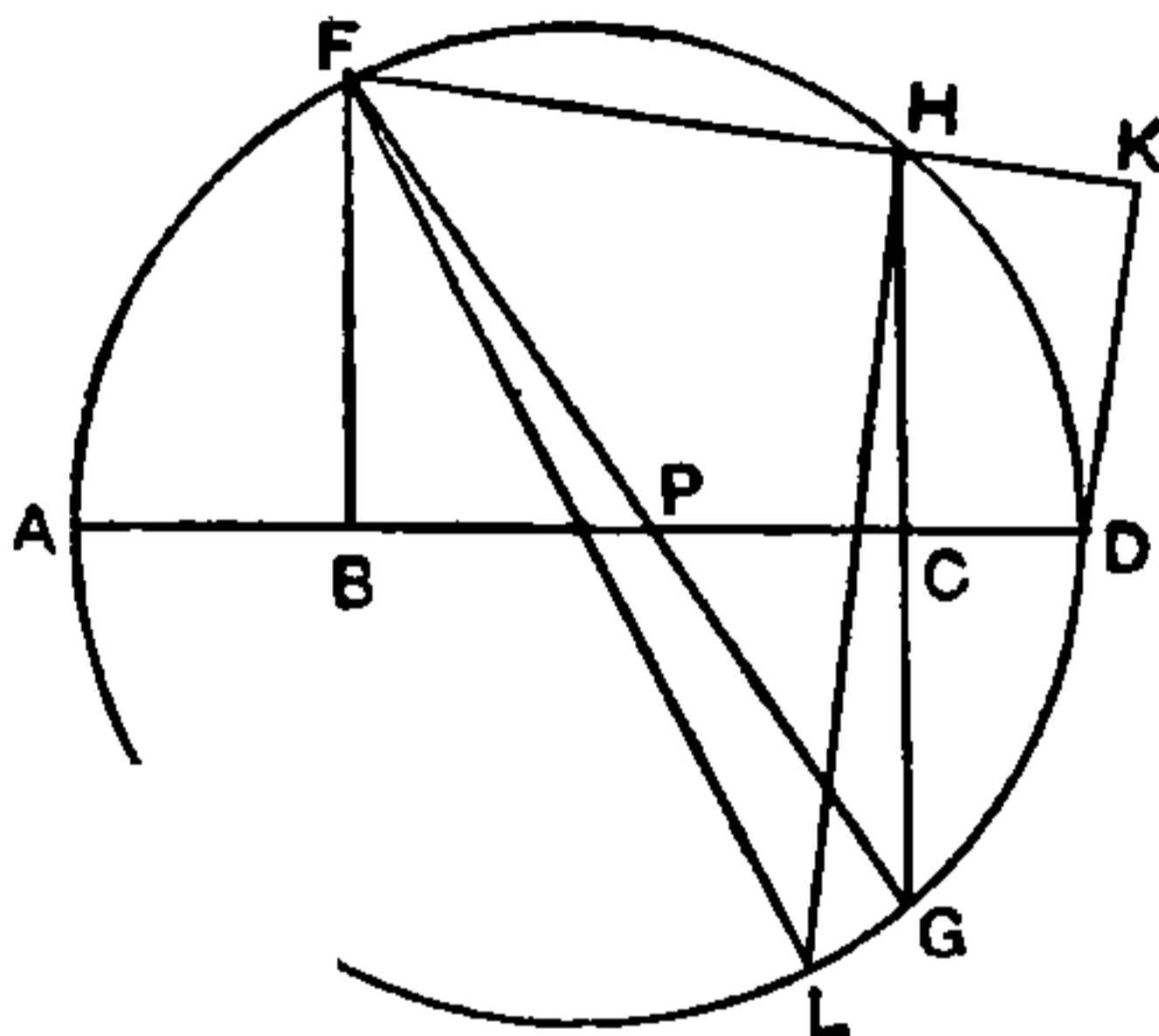

Then, by hypothesis, $AB \cdot BD : AC \cdot CD = BP^2 : CP^2$;

therefore

$$BF^2 : CG^2 = BP^2 : CP^2,$$

or

$$BF : CG = BP : CP,$$

whence the triangles FBP, GCP are similar and therefore equiangular, so that FPG is a straight line.

Produce GC to meet the circle in H , join FH , and draw DK perpendicular to FH produced. Draw the diameter FL and join LH .

Now, by the lemma, $FK^2 = AC \cdot BD$, and $HK^2 = AB \cdot CD$; therefore $FH = FK - HK = \sqrt{(AC \cdot BD)} - \sqrt{(AB \cdot CD)}$.

Since, in the triangles FHL, PCG , the angles at H, C are right and $\angle FLH = \angle PGC$, the triangles are similar, and

$$\begin{aligned} GP : PC &= FL : FH = AD : FH \\ &= AD : \{ \sqrt{(AC \cdot BD)} - \sqrt{(AB \cdot CD)} \}. \end{aligned}$$

But

$$GP : PC = FP : PB;$$

therefore

$$\begin{aligned} GP^2 : PC^2 &= FP \cdot PG : BP \cdot PC \\ &= AP \cdot PD : BP \cdot PC. \end{aligned}$$

Therefore

$$AP \cdot PD : BP \cdot PC = AD^2 : \{ \sqrt{(AC \cdot BD)} - \sqrt{(AB \cdot CD)} \}^2.$$

The proofs of Props. 62 and 64 are different, the former being long and involved. The results are:

Prop. 62. If P is between C and D , and

$$AD \cdot DB : AC \cdot CB = DP^2 : PC^2,$$

then the ratio $AP \cdot PB : CP \cdot PD$ is singular and a minimum and is equal to $\{ \sqrt{(AC \cdot BD)} + \sqrt{(AD \cdot BC)} \}^2 : DC^2$.

Prop. 64. If P is on AD produced, and

$$AB \cdot BD : AC \cdot CD = BP^2 : CP^2,$$

then the ratio $AP \cdot PD : BP \cdot PC$ is singular and a maximum, and is equal to $AD^2 : \{ \sqrt{(AC \cdot BD)} + \sqrt{(AB \cdot CD)} \}^2$.

(γ) *Lemmas on the Νεύσεις of Apollonius.*

After a few easy propositions (e.g. the equivalent of the proposition that, if $ax + x^2 = by + y^2$, then, according as $a >$ or $< b$, $a + x >$ or $< b + y$), Pappus gives (Prop. 70) the lemma leading to the solution of the *νεύσεις* with regard to the rhombus (see pp. 190–2, above), and after that the solution by one Heraclitus of the same problem with respect to a square (Props. 71, 72, pp. 780–4). The problem is, *Given a square $ABCD$, to draw through B a straight line, meeting CD in H and AD produced in E , such that HE is equal to a given length.*

The solution depends on a lemma to the effect that, if any straight line BHE through B meets CD in H and AD pro-

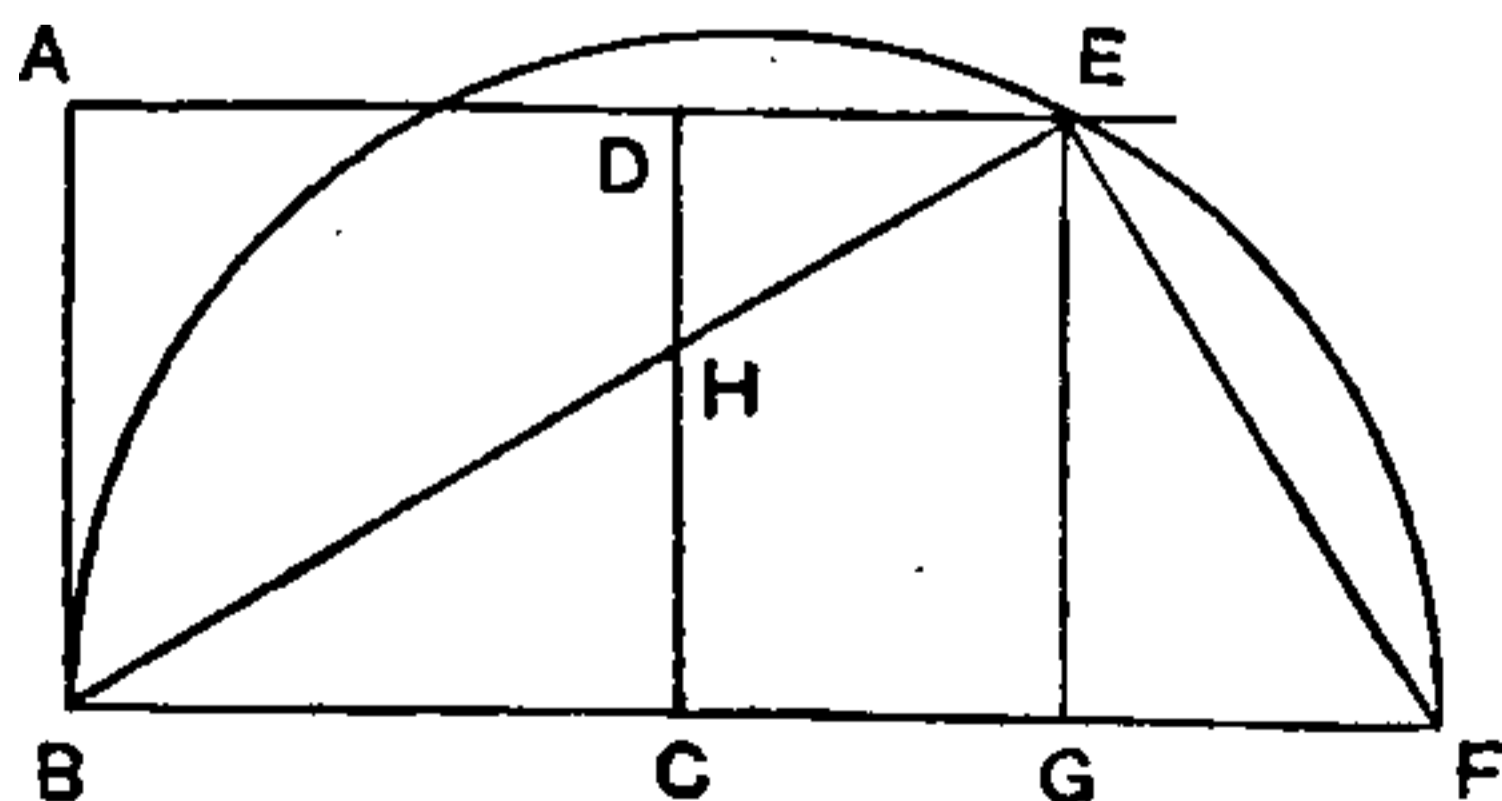

duced in E , and if EF be drawn perpendicular to BE meeting BC produced in F , then

$$CF^2 = BC^2 + HE^2.$$

Draw EG perpendicular to BF .

Then the triangles BCH , EGF are similar and (since $BC = EG$) equal in all respects: therefore $EF = BH$.

$$\text{Now} \quad BF^2 = BE^2 + EF^2,$$

$$\text{or} \quad BC \cdot BF + BF \cdot FC = BH \cdot BE + BE \cdot EH + EF^2.$$

But, the angles HCF , HEF being right, H , C , F , E are concyclic, and $BC \cdot BF = BH \cdot BE$.

Therefore, by subtraction,

$$\begin{aligned} BF \cdot FC &= BE \cdot EH + EF^2 \\ &= BE \cdot EH + BH^2 \\ &= BH \cdot HE + EH^2 + BH^2 \\ &= EB \cdot BH + EH^2 \\ &= FB \cdot BC + EH^2. \end{aligned}$$

Taking away the common part, $BC \cdot CF$, we have

$$CF^2 = BC^2 + EH^2.$$

Now suppose that we have to draw BHE through B in such a way that $HE = k$. Since BC , EH are both given, we have only to determine a length x such that $x^2 = BC^2 + k^2$, produce BC to F so that $CF = x$, draw a semicircle on BF as diameter, produce AD to meet the semicircle in E , and join BE . BE is thus the straight line required.

Prop. 73 (pp. 784–6) proves that, if D be the middle point of BC , the base of an isosceles triangle ABC , then BC is the shortest of all the straight lines through D terminated by the straight lines AB , AC , and the nearer to BC is shorter than the more remote.

There follows a considerable collection of lemmas mostly showing the equality of certain intercepts made on straight lines through one extremity of the diameter of one of two semicircles having their diameters in a straight line, either one including or partly including the other, or wholly external to one another, on the same or opposite sides of the diameter.



THIS PAGE IS LOCKED TO FREE MEMBERS

Purchase full membership to immediately unlock this page

DELVE INTO FANTASY, MAGIC, MYTHOLOGY & FOLKLORE

Forgotten Books'
Full Membership gives
access to 797,885 ancient
and modern, fiction and
non-fiction books.

Continue

*Fair usage policy applies

The problem is reduced to a problem contained in Apollonius's *Determinate Section* thus.

Suppose the problem solved by the semicircle DEF , BE being equal to AD . Join E to the centre G of the semicircle

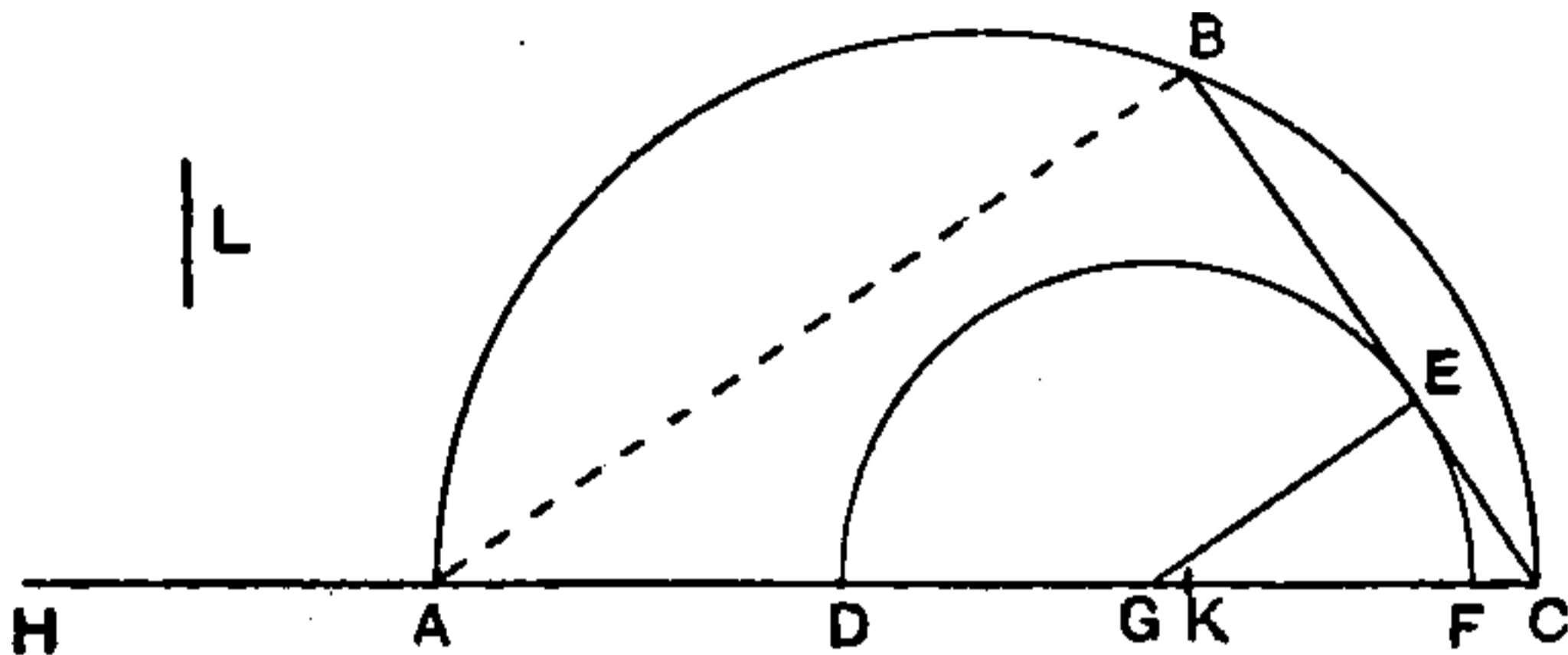

DEF . Produce DA to H , making HA equal to AD . Let K be the middle point of DC .

Since the triangles ABC , GEC are similar,

$$\begin{aligned} AG^2 : GC^2 &= BE^2 : EC^2 \\ &= AD^2 : EC^2, \text{ by hypothesis,} \\ &= AD^2 : GC^2 - DG^2 \text{ (since } DG = GE) \\ &= AG^2 - AD^2 : DG^2 \\ &= HG \cdot DG : DG^2 \\ &= HG : DG. \end{aligned}$$

Therefore

$$\begin{aligned} HG : DG &= AD^2 : GC^2 - DG^2 \\ &= AD^2 : 2DC \cdot GK. \end{aligned}$$

Take a straight line L such that $AD^2 = L \cdot 2DC$;

therefore $HG : DG = L : GK$,

or $HG \cdot GK = L \cdot DG$.

Therefore, given the two straight lines HD , DK (or the three points H , D , K on a straight line), we have to find a point G between D and K such that

$$HG \cdot GK = L \cdot DG,$$

which is the second *epitagma* of the third Problem in the *Determinate Section* of Apollonius, and therefore may be taken as solved. (The problem is the equivalent of the

solution of a certain quadratic equation.) Pappus observes that the problem is always possible (requires no *διορισμός*), and proves that it has only one solution.

(δ) *Lemmas on the treatise 'On contacts.' by Apollonius.*

These lemmas are all pretty obvious except two, which are important, one belonging to Book I of the treatise, and the other to Book II. The two lemmas in question have already been set out à propos of the treatise of Apollonius (see pp. 182–5, above). As, however, there are several cases of the first (Props. 105, 107, 108, 109), one case (Prop. 108, pp. 836–8), different from that before given, may be put down here: *Given a circle and two points D, E within it, to draw straight lines through D, E to a point A on the circumference in such a way that, if they meet the circle again in B, C , BC shall be parallel to DE .*

We proceed by analysis. Suppose the problem solved and DA, EA drawn ('inflected') to A in such a way that, if AD, AE meet the circle again in B, C , BC is parallel to DE .

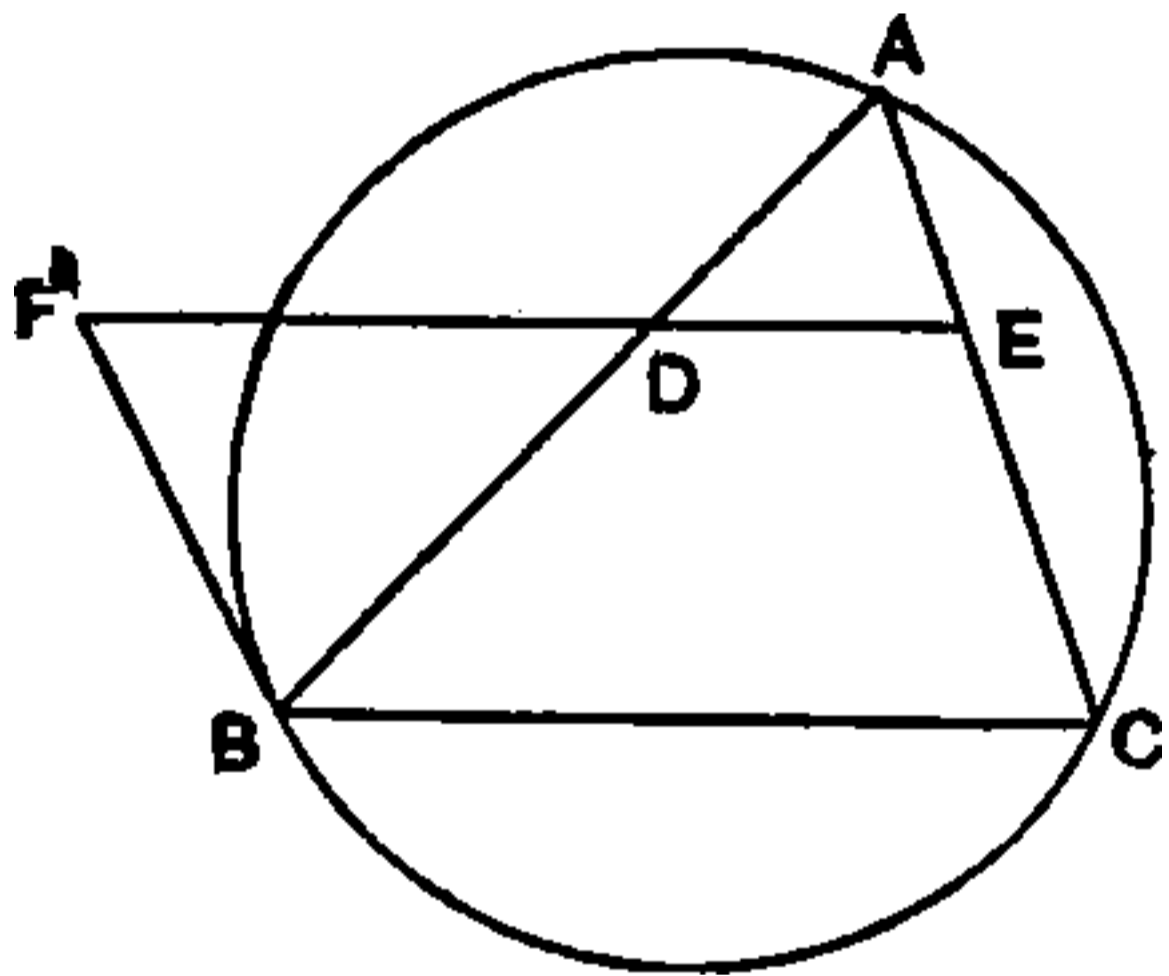

Draw the tangent at B meeting ED produced in F .

Then $\angle FBD = \angle ACB = \angle AED$;
therefore A, E, B, F are concyclic,
and consequently

$$FD \cdot DE = AD \cdot DB.$$

But the rectangle $AD \cdot DB$ is given, since it depends only on the position of D in relation to the circle, and the circle is given.

Therefore the rectangle $FD \cdot DE$ is given.

And DE is given; therefore FD is given, and therefore F .

It follows that the tangent FB is given in position, and therefore B is given. Therefore BDA is given and consequently AE also.

To solve the problem, therefore, we merely take F on ED produced such that $FD \cdot DE =$ the given rectangle made by the segments of any chord through D , draw the tangent FB , join BD and produce it to A , and lastly draw AE through to C ; BC is then parallel to DE .

The other problem (Prop. 117, pp. 848–50) is, as we have seen, equivalent to the following: *Given a circle and three points D, E, F in a straight line external to it, to inscribe in the circle a triangle ABC such that its sides pass severally through the three points D, E, F .* For the solution, see pp. 182–4, above.

(ε) The Lemmas to the *Plane Loci* of Apollonius (Props. 119–26, pp. 852–64) are mostly propositions in geometrical algebra worked out by the methods of Eucl., Books II and VI. We may mention the following:

Prop. 122 is the well-known proposition that, if D be the middle point of the side BC in a triangle ABC ,

$$BA^2 + AC^2 = 2(AD^2 + DC^2).$$

Props. 123 and 124 are two cases of the same proposition, the enunciation being marked by an expression which is also found in Euclid's *Data*. Let $AB:BC$ be a given ratio, and

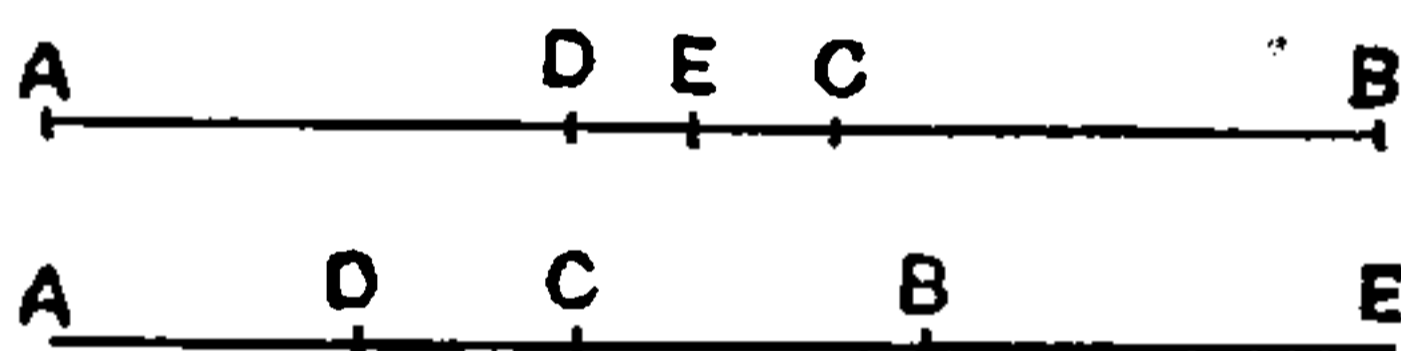

let the rectangle $CA \cdot AD$ be given; then, if BE is a mean proportional between DB, BC , 'the square on AE is greater by the rectangle $CA \cdot AD$ than in the ratio of AB to BC to the square on EC ', by which is meant that

$$AE^2 = CA \cdot AD + \frac{AB}{BC} \cdot EC^2,$$

or $(AE^2 - CA \cdot AD) : EC^2 = AB : BC.$

The algebraical equivalent may be expressed thus (if $AB = a$, $BC = b$, $AD = c$, $BE = x$):

If $x = \sqrt{(a-c)b}$, then $\frac{(a+x)^2 - (a-b)c}{(x+b)^2} = \frac{a}{b}.$

Prop. 125 is remarkable: If C, D be two points on a straight line AB ,

$$AD^2 + \frac{AC}{BC} \cdot DB^2 = AC^2 + AC \cdot CB + \frac{AB}{BC} \cdot CD^2,$$



THIS PAGE IS LOCKED TO FREE MEMBERS

Purchase full membership to immediately unlock this page

FORGOTTEN BOOKS

FULL

MEMBERSHIP

797,885 Books!

All you can read

for only

\$8.99/month

Continue

*Fair usage policy applies



i. e. (if $DA \cdot AC$ be subtracted from each side) .

that $AD \cdot DC + FD \cdot DB = AC \cdot DB + AF \cdot CD,$

i. e. (if $AF \cdot CD$ be subtracted from each side)

that $FD \cdot DC + FD \cdot DB = AC \cdot DB,$

or $FD \cdot CB = AC \cdot DB:$

which is true, since, by (1) above, $FD : DB = AC : CB.$

(ζ) *Lemmas to the 'Porisms' of Euclid.*

The 38 Lemmas to the *Porisms* of Euclid form an important collection which, of course, has been included in one form or other in the 'restorations' of the original treatise. Chasles¹ in particular gives a classification of them, and we cannot do better than use it in this place: '23 of the Lemmas relate to rectilinear figures, 7 refer to the harmonic ratio of four points, and 8 have reference to the circle.

'Of the 23 relating to rectilinear figures, 6 deal with the quadrilateral cut by a transversal; 6 with the equality of the anharmonic ratios of two systems of four points arising from the intersections of four straight lines issuing from one point with two other straight lines; 4 may be regarded as expressing a property of the hexagon inscribed in two straight lines; 2 give the relation between the areas of two triangles which have two angles equal or supplementary; 4 others refer to certain systems of straight lines; and the last is a case of the problem of the *Cutting-off of an area.*'

The lemmas relating to the quadrilateral and the transversal are 1, 2, 4, 5, 6 and 7 (Props. 127, 128, 130, 131, 132, 133). Prop. 130 is a general proposition about any transversal

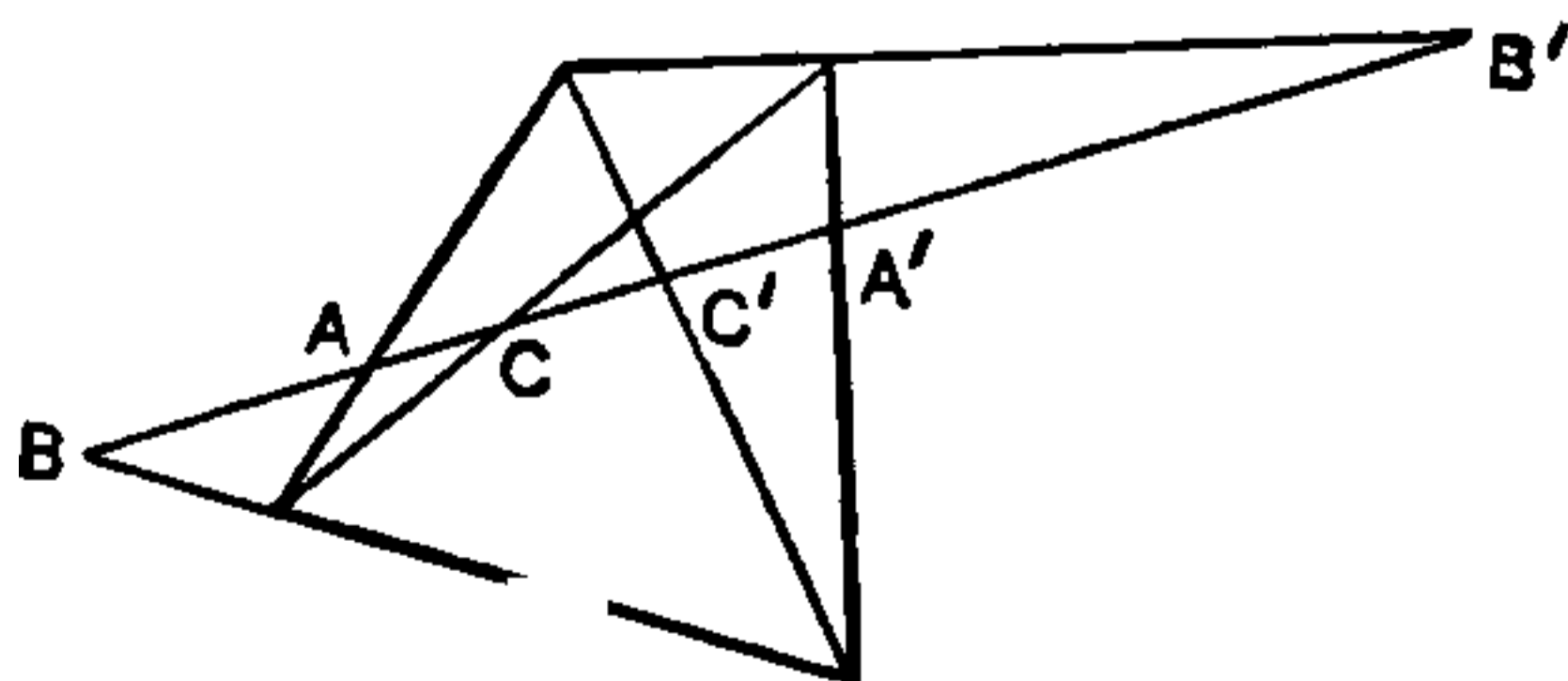

whatever, and is equivalent to one of the equations by which we express the involution of six points. If A, A' ; B, B' ; C, C' be the points in which the transversal meets the pairs of

¹ Chasles, *Les trois livres de Porismes d'Euclide*, Paris, 1860, pp. 74 sq.

opposite sides and the two diagonals respectively, Pappus's result is equivalent to

$$\frac{AB \cdot B'C}{A'B' \cdot BC'} = \frac{CA}{C'A'}$$

Props. 127, 128 are particular cases in which the transversal is parallel to a side; in Prop. 131 the transversal passes through the points of concurrence of opposite sides, and the result is equivalent to the fact that the two diagonals divide into proportional parts the straight line joining the points of concurrence of opposite sides; Prop. 132 is the particular case of Prop. 131 in which the line joining the points of concurrence of opposite sides is parallel to a diagonal; in Prop. 133 the transversal passes through one only of the points of concurrence of opposite sides and is parallel to a diagonal, the result being $CA^2 = CB \cdot CB'$.

Props. 129, 136, 137, 140, 142, 145 (Lemmas 3, 10, 11, 14, 16, 19) establish the equality of the anharmonic ratios which four straight lines issuing from a point determine on two transversals; but both transversals are supposed to be drawn from the same point on one of the four straight lines. Let

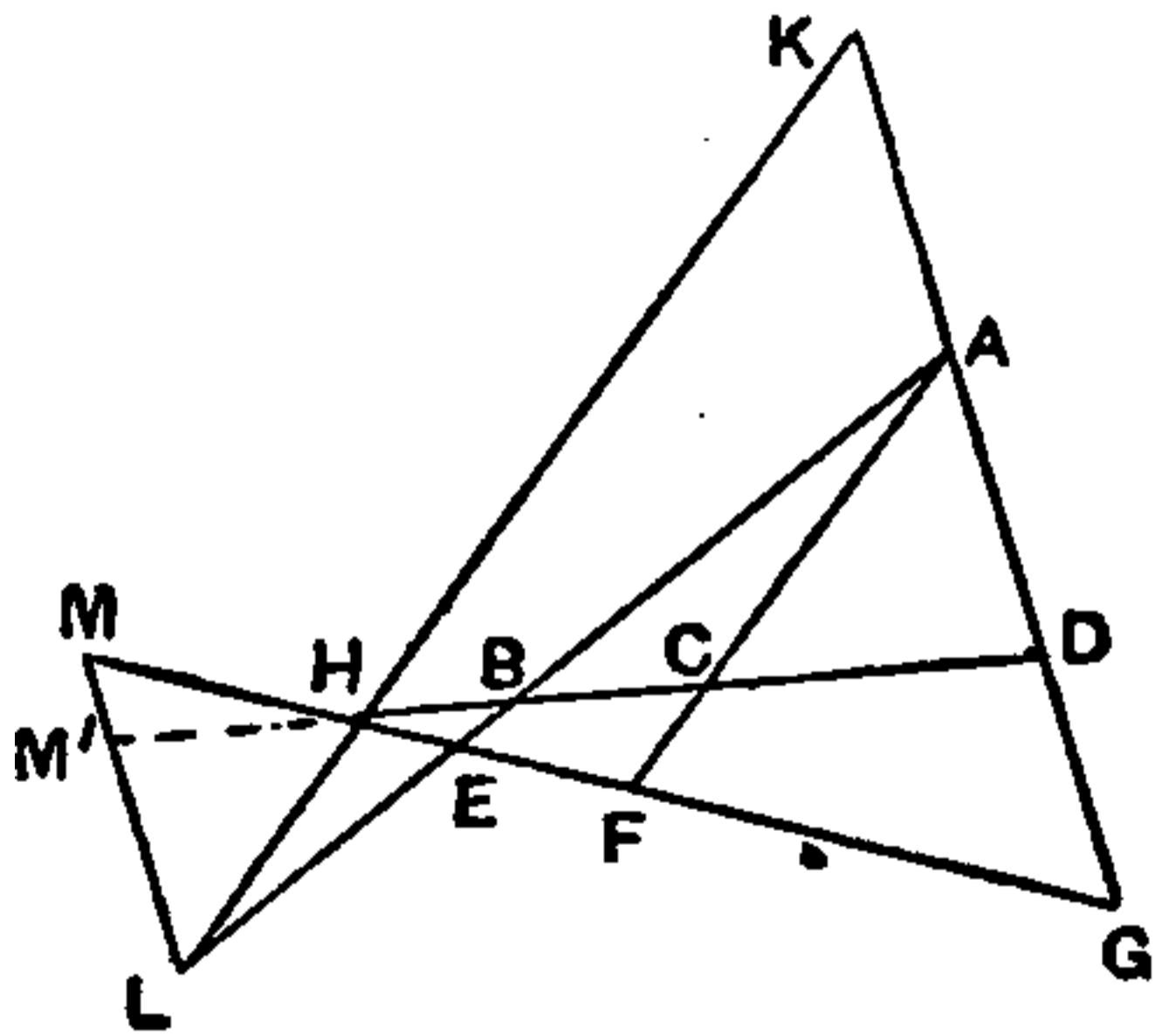

AB, AC, AD be cut by transversals $HBCD, HEFG$. It is required to prove that

$$\frac{HE \cdot FG}{HG \cdot EF} = \frac{HB \cdot CD}{HD \cdot BC}$$

Pappus gives (Prop. 129) two methods of proof which are practically equivalent. The following is the proof 'by compound ratios'.

Draw HK parallel to AF meeting DA and AE produced

in K, L ; and draw LM parallel to AD meeting GH produced in M .

Then
$$\frac{HE \cdot FG}{HG \cdot EF} = \frac{HE}{EF} \cdot \frac{FG}{HG} = \frac{LH}{AF} \cdot \frac{AF}{HK} = \frac{LH}{HK}.$$

In exactly the same way, if DH produced meets LM in M' we prove that

$$\frac{HB \cdot CD}{HD \cdot BC} = \frac{LH}{HK}.$$

Therefore
$$\frac{HE \cdot FG}{HG \cdot EF} = \frac{HB \cdot CD}{HD \cdot BC}.$$

(The proposition is proved for $HBCD$ and any other transversal not passing through H by applying our proposition twice, as usual.)

Props. 136, 142 are the reciprocal; Prop. 137 is a particular case in which one of the transversals is parallel to one of the straight lines, Prop. 140 a reciprocal of Prop. 137, Prop. 145 another case of Prop. 129.

The Lemmas 12, 13, 15, 17 (Props. 138, 139, 141, 143) are equivalent to the property of the hexagon inscribed in two straight lines, viz. that, if the vertices of a hexagon are situate, three and three, on two straight lines, the points of concurrence of opposite sides are in a straight line; in Props. 138, 141 the straight lines are parallel, in Props. 139, 143 not parallel.

Lemmas 20, 21 (Props. 146, 147) prove that, when one angle of one triangle is equal or supplementary to one angle of another triangle, the areas of the triangles are in the ratios of the rectangles contained by the sides containing the equal or supplementary angles.

The seven Lemmas 22, 23, 24, 25, 26, 27, 34 (Props. 148-53 and 160) are propositions relating to the segments of a straight line on which two intermediate points are marked. Thus:

Props. 148, 150.

If C, D be two points on AB , then

(a) if $2AB \cdot CD = CB^2, AD^2 = AC^2 + DB^2;$



(b) if $2AC \cdot BD = CD^2, AB^2 = AD^2 + CB^2.$



THIS PAGE IS LOCKED TO FREE MEMBERS

Purchase full membership to immediately unlock this page

DELVE INTO FANTASY, MAGIC, MYTHOLOGY & FOLKLORE

Forgotten Books'
Full Membership gives
access to 797,885 ancient
and modern, fiction and
non-fiction books.

Continue

*Fair usage policy applies

Since AB bisects DE perpendicularly, $(\text{arc } AE) = (\text{arc } AD)$ and $\angle EFA = \angle AFD$, or AF bisects the angle EFD .

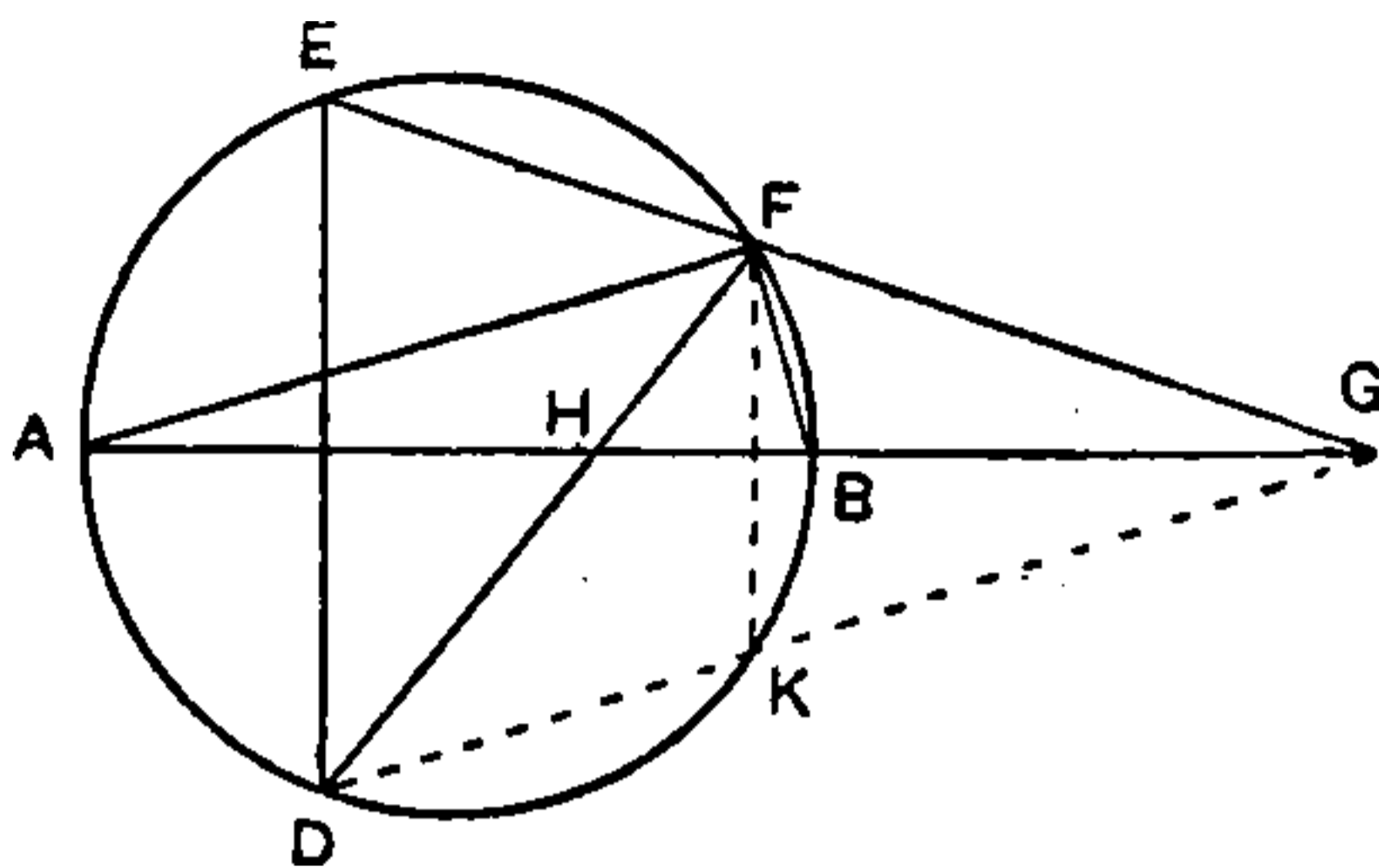

Since the angle AFB is right, FB bisects $\angle HFG$, the supplement of $\angle EFD$.

Therefore (Eucl. VI: 3) $GB : BH = GF : FH = GA : AH$,
and, alternately and inversely, $AH : HB = AG : GB$.

Prop. 157 is remarkable in that (without any mention of a conic) it is practically identical with Apollonius's *Conics* III. 45 about the foci of a central conic. Pappus's theorem is as follows. Let AB be the diameter of a semicircle, and

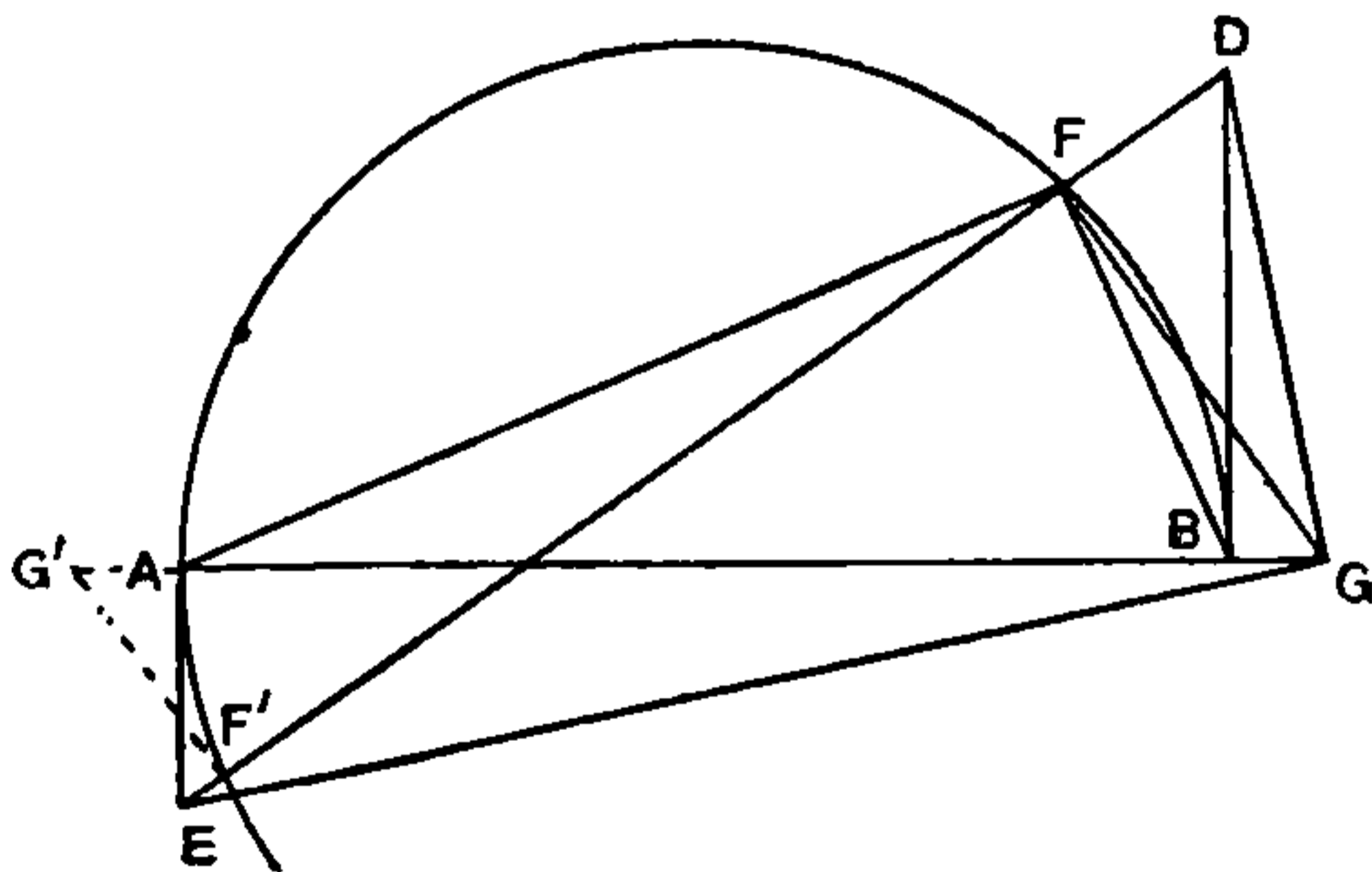

from A, B let two straight lines AE, BD be drawn at right angles to AB . Let any straight line DE meet the two perpendiculars in D, E and the semicircle in F . Further, let FG be drawn at right angles to DE , meeting AB produced in G .

It is to be proved that

$$AG \cdot GB = AE \cdot BD$$

Since F, D, G, B are concyclic, $\angle BDG = \angle BFG$.

And, since AFB , EFG are both right angles, $\angle BFG = \angle AFE$.

But, since A , E , G , F are concyclic, $\angle AFE = \angle AGE$.

Therefore $\angle BDG = \angle AGE$;

and the right-angled triangles DBG , GAE are similar.

Therefore $AG : AE = BD : GB$,

or $AG \cdot GB = AE \cdot DB$.

In Apollonius G and the corresponding point G' on BA produced which is obtained by drawing $F'G'$ perpendicular to ED (where DE meets the circle again in F') are the foci of a central conic (in this case a hyperbola), and DE is any tangent to the conic; the rectangle $AE \cdot BD$ is of course equal to the square on half the conjugate axis.

(η) The Lemmas to the *Conics* of Apollonius (pp. 918–1004) do not call for any extended notice. There are a large number of propositions in geometrical algebra of the usual kind, relating to the segments of a straight line marked by a number of points on it; propositions about lines divided into proportional segments and about similar figures; two propositions relating to the construction of a hyperbola (Props. 204, 205) and a proposition (208) proving that two hyperbolas with the same asymptotes do not meet one another. There are also two propositions (221, 222) equivalent to an obvious trigono-

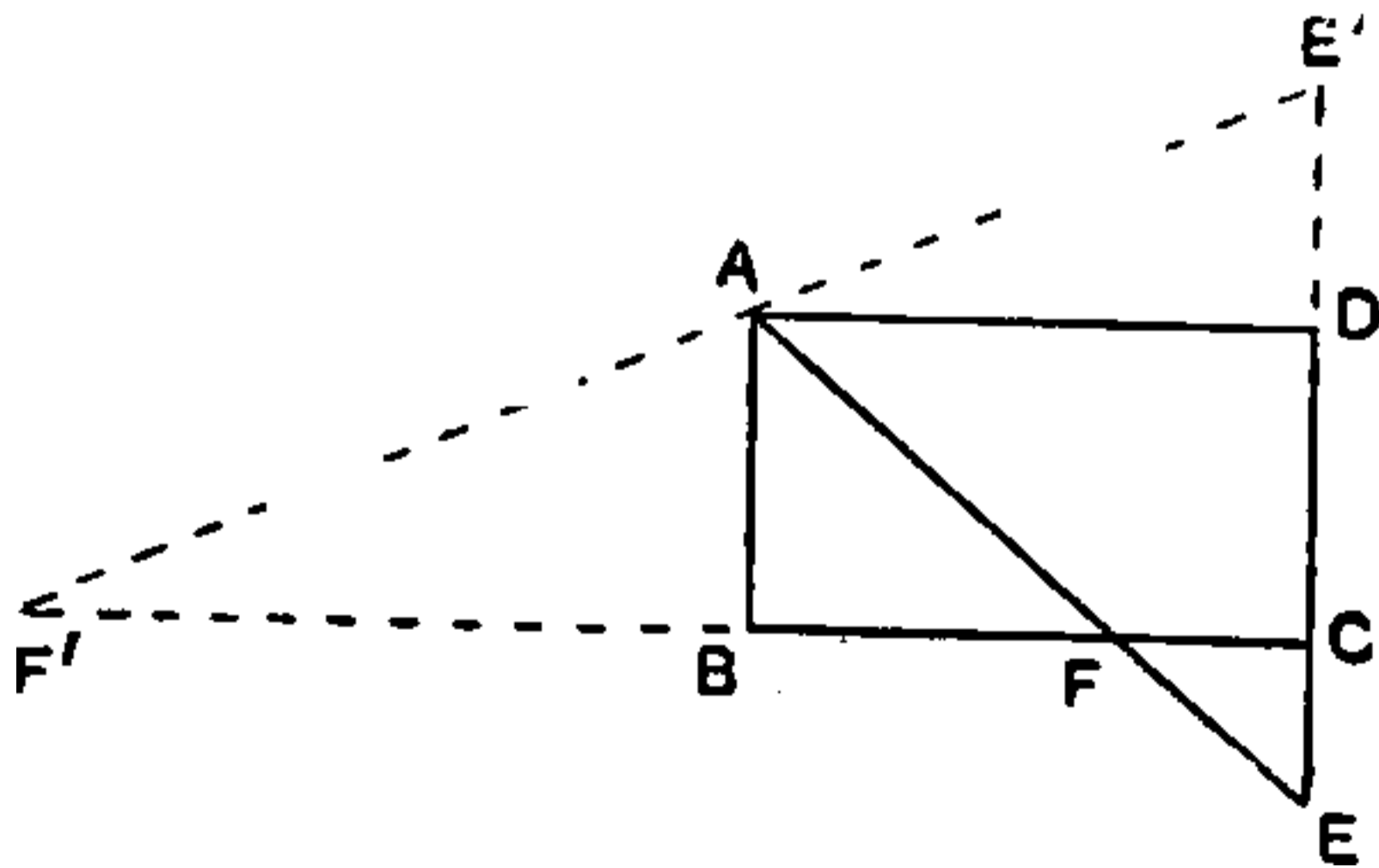

metrical formula. Let $ABCD$ be a rectangle, and let any straight line through A meet DC produced in E and BC (produced if necessary) in F .

Then $EA \cdot AF = ED \cdot DC + CB \cdot BF$.

$$\begin{aligned} \text{For } EA^2 + AF^2 &= ED^2 + DA^2 + AB^2 + BF^2 \\ &= ED^2 + BC^2 + CD^2 + BF^2. \end{aligned}$$

$$\text{Also } EA^2 + AF^2 = EF^2 + 2EA \cdot AF.$$

Therefore

$$\begin{aligned} 2EA \cdot AF &= EA^2 + AF^2 - EF^2 \\ &= ED^2 + BC^2 + CD^2 + BF^2 - EF^2 \\ &= (ED^2 + CD^2) + (BC^2 + BF^2) - EF^2 \\ &= EC^2 + 2ED \cdot DC + CF^2 + 2CB \cdot BF - EF^2 \\ &= 2ED \cdot DC + 2CB \cdot BF; \end{aligned}$$

$$\text{i.e. } EA \cdot AF = ED \cdot DC + CB \cdot BF.$$

This is equivalent to $\sec \theta \operatorname{cosec} \theta = \tan \theta + \cot \theta$.

The algebraical equivalents of some of the results obtained by the usual geometrical algebra may be added.

Props. 178, 179, 192-4.

$$(a + 2b)a + (b + x)(b - x) = (a + b + x)(a + b - x).$$

$$\text{Prop. 195. } 4a^2 = 2\{(a - x)(a + x) + (a - y)(a + y) + x^2 + y^2\}.$$

Prop. 196.

$$(a + b - x)^2 + (a + b + x)^2 = (x - b)^2 + (x + b)^2 + 2(a + 2b)a.$$

Props. 197, 199, 198.

$$\left. \begin{aligned} \text{If } (x + y + a)a + x^2 &= (a + x)^2, \\ \text{or if } (x + y + a)a + x^2 &= (a + y)^2, \\ \text{or if } (x + y - a)a + (x - a)^2 &= y^2, \end{aligned} \right\} \text{ then } x = y.$$

$$\begin{aligned} \text{Props. 200, 201. If } (a + b)x &= b^2, \text{ then } \frac{2b + a}{a} = \frac{b + x}{b - x} \text{ and} \\ (2b + a)a &= (a + b)(a + b - x). \end{aligned}$$

Prop. 207. If $(a + b)b = 2a^2$, then $a = b$.

(θ) The two Lemmas to the *Surface-Loci* of Euclid have already been mentioned as significant. The first has the appearance of being a general enunciation, such as Pappus



THIS PAGE IS LOCKED TO FREE MEMBERS

Purchase full membership to immediately unlock this page

FORGOTTEN BOOKS

FULL

MEMBERSHIP

797,885 Books!

All you can read

for only

\$8.99/month

Continue

*Fair usage policy applies



but the genuine proof is indicated, although it breaks off before it is quite complete.

Since $AF : FB = BG : GC$,

$AB : FB = BC : GC$,

or $AB : BC = FB : GC$.

But, by hypothesis, $AB : BC = BG : GC$;

therefore $BF = BG$.

From this point the proof apparently proceeded by analysis. 'Suppose it done' ($\gamma\epsilon\gamma\omicron\nu\acute{\epsilon}\tau\omega$), i.e. suppose the proposition true, and BED perpendicular to AC .

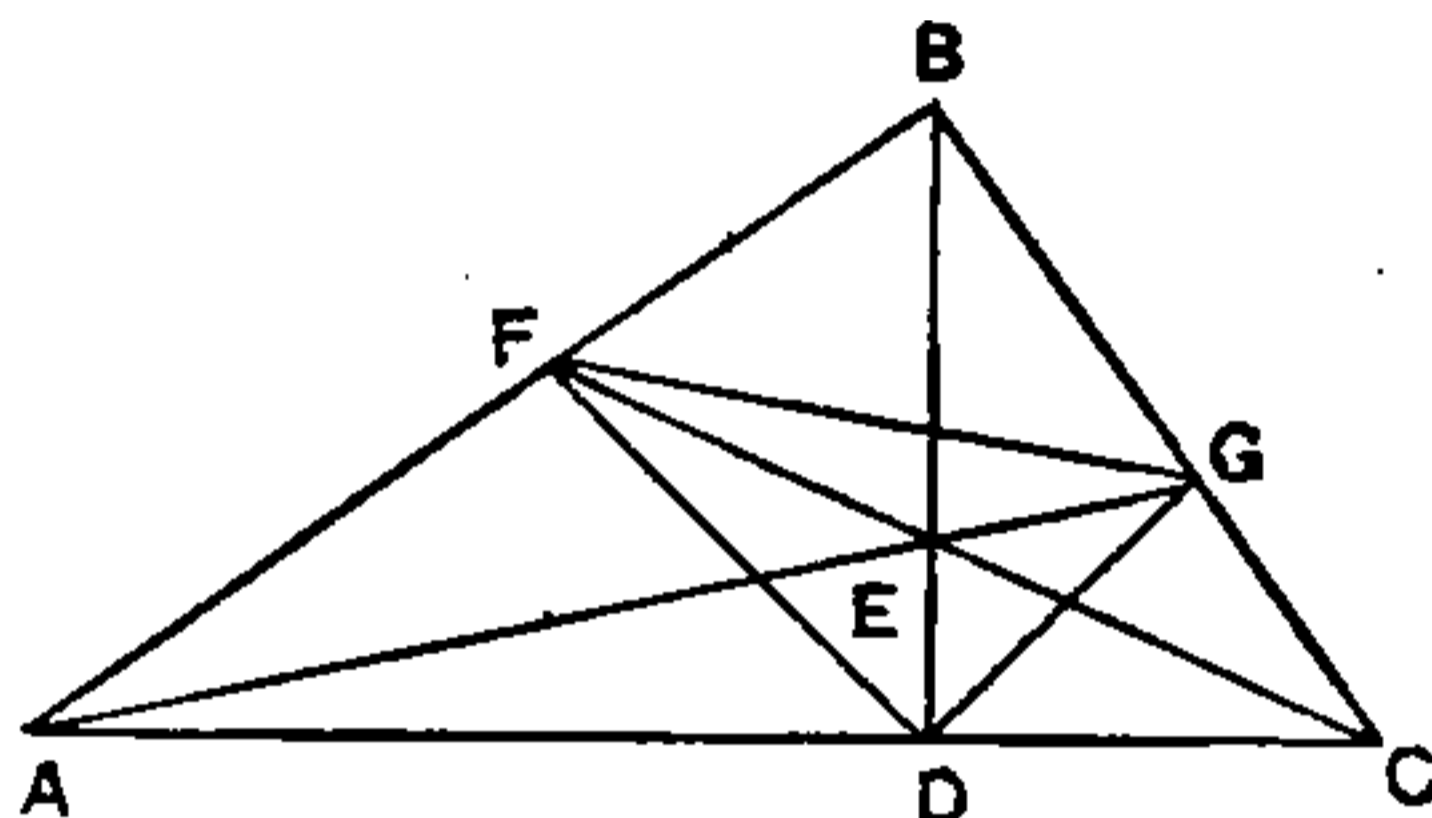

Then, by similarity of triangles, $AD : DB = AB : BC$;

therefore $AF : FB = AD : DB$, and consequently the angle ADB is bisected by DF .

Similarly the angle BDC is bisected by DG .

Therefore each of the angles BDF , BDG is half a right angle, and consequently the angle FDG is a right angle.

Therefore B , G , D , F are concyclic; and, since the angles FDB , BDG are equal, $FB = BG$.

This is of course the result above proved.

Evidently the interpolator tried to clinch the argument by proving that the angle BDA could not be anything but a right angle.

Book VIII.

Book VIII of the *Collection* is mainly on mechanics, although it contains, in addition, some propositions of purely geometrical interest.

Historical preface.

It begins with an interesting preface on the claim of theoretical mechanics, as distinct from the merely practical or industrial, to be regarded as a mathematical subject. Archimedes, Philon, Heron of Alexandria are referred to as the principal exponents of the science, while Carpus of Antioch is also mentioned as having applied geometry to 'certain (practical) arts'.

The date of Carpus is uncertain, though it is probable that he came after Geminus; the most likely date seems to be the first or second century A.D. Simplicius gives the authority of Iamblichus for the statement that Carpus squared the circle by means of a certain curve, which he simply called a curve generated by a double motion.¹ Proclus calls him 'Carpus the writer on mechanics (ὁ μηχανικός)', and quotes from a work of his on Astronomy some remarks about the relation between problems and theorems and the 'priority in order' of the former.² Proclus also mentions him as having held that an angle belongs to the category of *quantity* (ποσόν), since it represents a sort of 'distance' between the two lines forming it, this distance being 'extended one way' (ἐφ' ἐν διεστῶς) though in a different sense from that in which a line represents extension one way, so that Carpus's view appeared to be 'the greatest possible paradox'³; Carpus seems in reality to have been anticipating the modern view of an angle as representing *divergence* rather than distance, and to have meant by ἐφ' ἐν *in one sense* (rotationally), as distinct from one way or in one dimension (linearly).

Pappus tells us that Heron distinguished the logical, i.e. theoretical, part of mechanics from the practical or manual (χειρουργικόν), the former being made up of geometry, arithmetic, astronomy and physics, the latter of work in metal, architecture, carpentering and painting; the man who had been trained from his youth up in the *sciences* aforesaid as well as practised in the said *arts* would naturally prove the best architect and inventor of mechanical devices, but, as it is difficult or impossible for the same person to do both the necessary

¹ Simplicius on Arist. *Categ.*, p. 192, Kalbfleisch.

² Proclus on Eucl. I, pp. 241-3.

³ *Ib.*, pp. 125. 25-126. 6.

mathematics and the practical work, he who has not the former must perforce use the resources which practical experience in his particular art or craft gives him. Other varieties of mechanical work included by the ancients under the general term mechanics were (1) the use of the mechanical powers, or devices for moving or lifting great weights by means of a small force, (2) the construction of engines of war for throwing projectiles a long distance, (3) the pumping of water from great depths, (4) the devices of 'wonder-workers' (*θαυμασιουργοί*), some depending on pneumatics (like Heron in the *Pneumatica*), some using strings, &c., to produce movements like those of living things (like Heron in 'Automata and Balancings'), some employing floating bodies (like Archimedes in 'Floating Bodies'), others using water to measure time (like Heron in his 'Water-clocks'), and lastly 'sphere-making', or the construction of mechanical imitations of the movements of the heavenly bodies with the uniform circular motion of water as the motive power. Archimedes, says Pappus, was held to be the one person who had understood the cause and the reason of all these various devices, and had applied his extraordinarily versatile genius and inventiveness to all the purposes of daily life, and yet, although this brought him unexampled fame the world over, so that his name was on every one's lips, he disdained (according to Carpus) to write any mechanical work save a tract on sphere-making, but diligently wrote all that he could in a small compass of the most advanced parts of geometry and of subjects connected with arithmetic. Carpus himself, says Pappus, as well as others applied geometry to practical arts, and with reason: 'for geometry is in no wise injured, nay it is by nature capable of giving substance to many arts by being associated with them, and, so far from being injured, it may be said, while itself advancing those arts, to be honoured and adorned by them in return.'

The object of the Book.

Pappus then describes the object of the Book, namely to set out the propositions which the ancients established by geometrical methods, besides certain useful theorems discovered by himself, but in a shorter and clearer form and



THIS PAGE IS LOCKED TO FREE MEMBERS

Purchase full membership to immediately unlock this page

DELVE INTO FANTASY, MAGIC, MYTHOLOGY & FOLKLORE

Forgotten Books'
Full Membership gives
access to 797,885 ancient
and modern, fiction and
non-fiction books.

Continue

*Fair usage policy applies

Now, by hypothesis,

$$CE : EA = BD : DC,$$

whence

$$CA : AE = BC : CD,$$

and, if we halve the antecedents,

$$AK : AE = HC : CD;$$

therefore

$$AK : EK = HC : HD \text{ or } BH : HD,$$

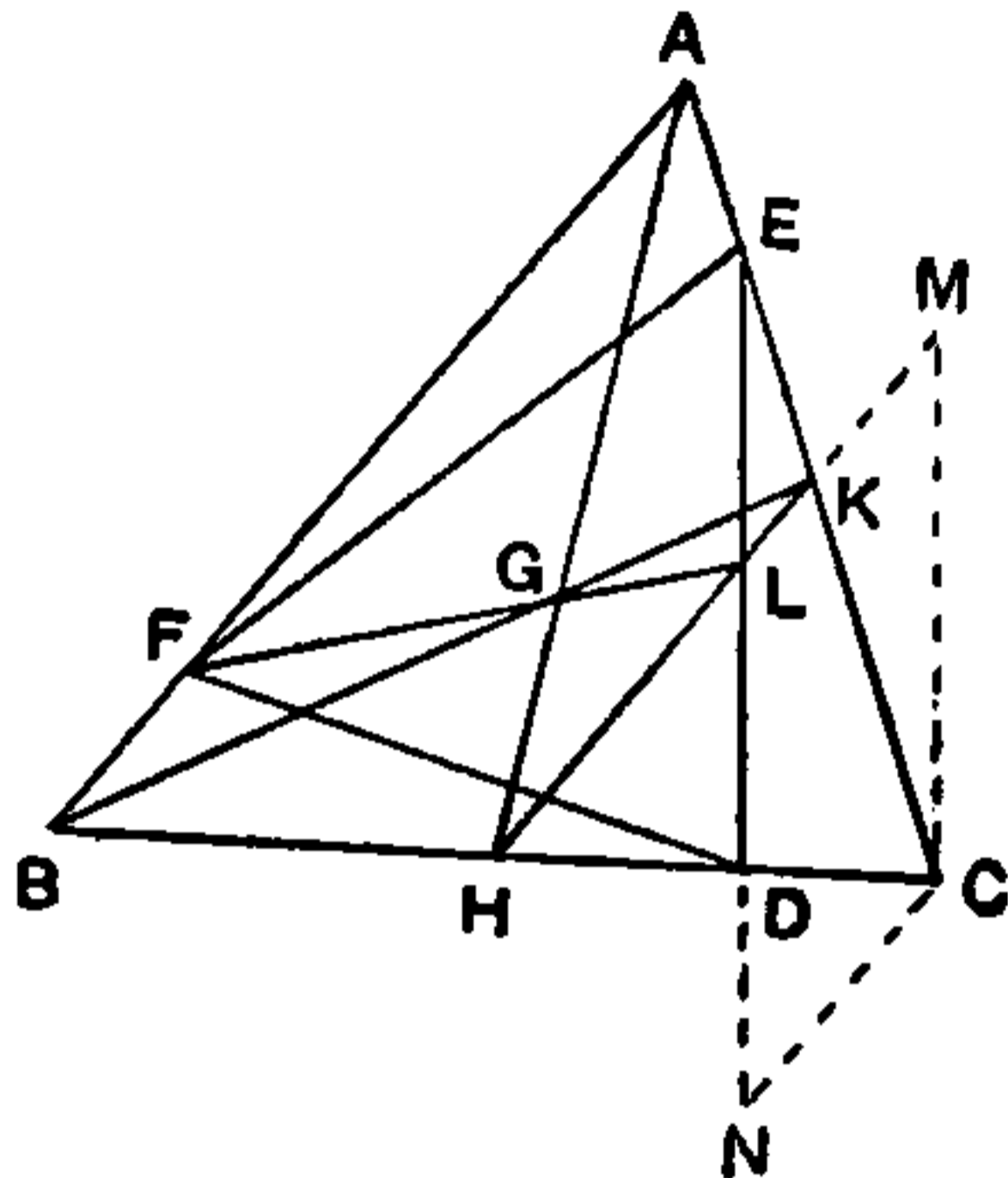

whence, *componendo*, $CE : EK = BD : DH$. (1)

$$\begin{aligned} \text{But } AF : FB &= BD : DC = (BD : DH) \cdot (DH : DC) \\ &= (CE : EK) \cdot (DH : DC). \end{aligned} \quad (2)$$

Now, ELD being a transversal cutting the sides of the triangle KHC , we have

$$HL : KL = (CE : EK) \cdot (DH : DC). \quad (3)$$

[This is 'Menelaus's theorem'; Pappus does not, however, quote it, but proves the relation *ad hoc* in an added lemma by drawing CM parallel to DE to meet HK produced in M . The proof is easy, for $HL : LK = (HL : LM) \cdot (LM : LK) = (HD : DC) \cdot (CE : EK)$.]

It follows from (2) and (3) that

$$AF : FB = HL : LK,$$

and, since AB is parallel to HK , and AH , BK are straight lines meeting in G , FGL is a straight line.

[This is proved in another easy lemma by *reductio ad absurdum*.]

We have next to prove that $EL = LD$.

Now [again by 'Menelaus's theorem', proved *ad hoc* by drawing CN parallel to HK to meet ED produced in N]

$$EL : LD = (EK : KC) \cdot (CH : HD). \quad (4)$$

But, by (1) above, $CE : EK = BD : DH$;

therefore $CK : KE = BH : HD = CH : HD$,

so that $(EK : KC) \cdot (CH : HD) = 1$, and therefore, from (4),

$$EL = LD.$$

It remains to prove that $FG = 2GL$, which is obvious by parallels, since $FG : GL = AG : GH = 2 : 1$.

Two more propositions follow with reference to the centre of gravity. The first is, Given a rectangle with AB , BC as adjacent sides, to draw from C a straight line meeting the side opposite BC in a point D such that, if the trapezium $ADCB$ is hung from the point D , it will rest with AD , BC horizontal.

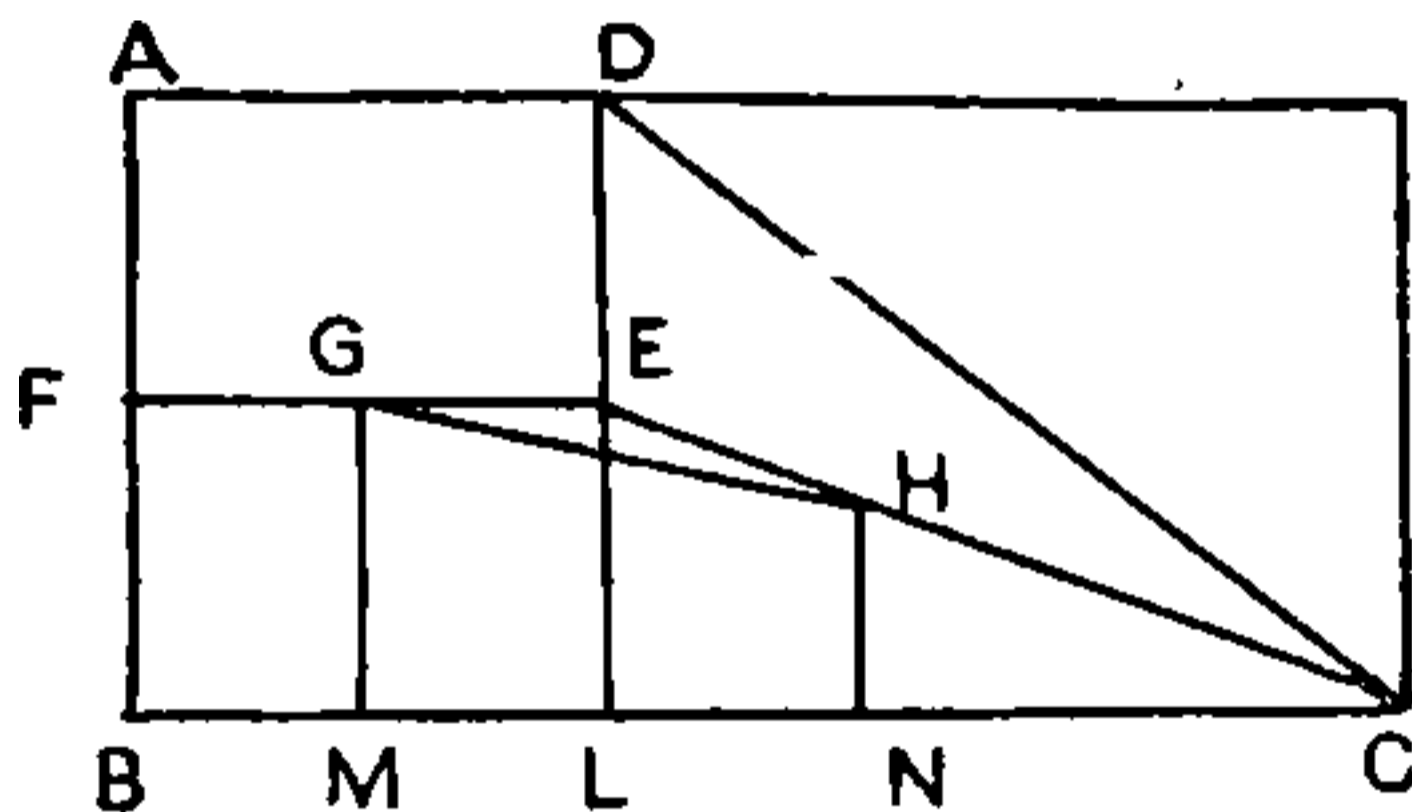

In other words, the centre of gravity must be in DL drawn perpendicular to BC . Pappus proves by analysis that $CL^2 = 3BL^2$, so that the problem is reduced to that of dividing BC into parts BL , LC such that this relation holds. The latter problem is solved (Prop. 6) by taking a point, say X , in CB such that $CX = 3XB$, describing a semicircle on BC as diameter and drawing XY at right angles to BC to meet the semicircle in Y , so that $XY^2 = \frac{3}{16}BC^2$, and then dividing CB at L so that

$$CL : LB = CX : XY (= \frac{3}{4} : \frac{1}{4}\sqrt{3} = \sqrt{3} : 1).$$

The second proposition is this (Prop. 7). Given two straight lines AB , AC , and B a fixed point on AB , if CD be drawn

with its extremities on AC , AB and so that $AC:BD$ is a given ratio, then the centre of gravity of the triangle ADC will lie on a straight line.

Take E , the middle point of AC , and F a point on DE such that $DF = 2FE$. Also let H be a point on BA such that $BH = 2HA$. Draw FG parallel to AC . Then $AG = \frac{1}{3}AD$, and $AH = \frac{1}{3}AB$; therefore $HG = \frac{1}{3}BD$.

Also $FG = \frac{2}{3}AE = \frac{1}{3}AC$. Therefore, since the ratio $AC:BD$ is given, the ratio $GH:GF$ is given.

And the angle $FGH (= A)$ is given; therefore the triangle FGH is given in species, and consequently the angle GHF is given. And H is a given point. Therefore HF is a given straight line, and it contains the centre of gravity of the triangle ADC .

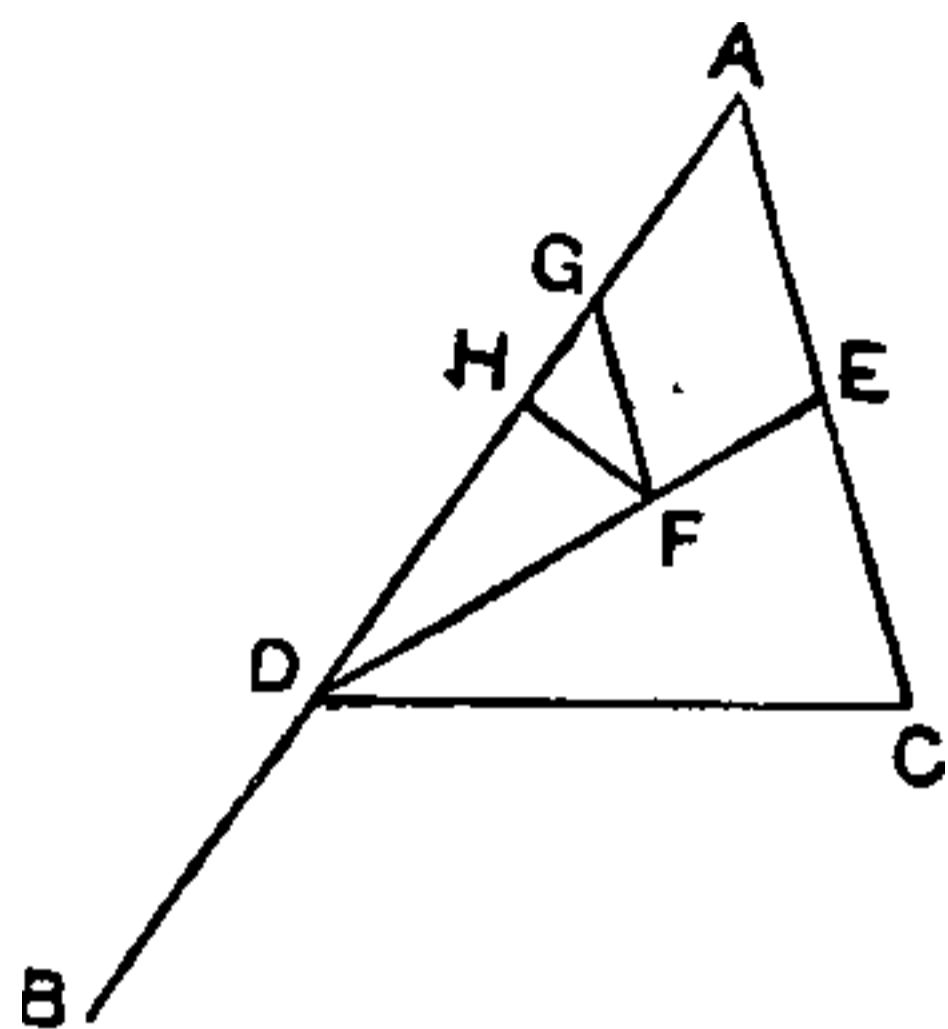

The inclined plane.

Prop. 8 is on the construction of a plane at a given inclination to another plane parallel to the horizon, and with this Pappus leaves theory and proceeds to the practical part. Prop. 9 (p. 1054. 4 sq.) investigates the problem 'Given a weight which can be drawn along a plane parallel to the horizon by a given force, and a plane inclined to the horizon at a given angle, to find the force required to draw the weight upwards on the inclined plane'. This seems to be the first or only attempt in ancient times to investigate motion on an inclined plane, and as such it is curious, though of no value.

Let A be the weight which can be moved by a force C along a horizontal plane. Conceive a sphere with weight equal to A placed in contact at L with the given inclined plane; the circle OGL represents a section of the sphere by a vertical plane passing through E its centre and LK the line of greatest slope drawn through the point L . Draw EGH horizontal and therefore parallel to MN in the plane of section, and draw LF perpendicular to EH . Pappus seems to regard the plane as rough, since he proceeds to make a system in equilibrium



THIS PAGE IS LOCKED TO FREE MEMBERS

Purchase full membership to immediately unlock this page

FORGOTTEN BOOKS

FULL

MEMBERSHIP

797,885 Books!

All you can read

for only

\$8.99/month

Continue

*Fair usage policy applies



is left intact, and let it be required to find the diameter of a circular section of the cylinder. We take any two points A, B on the surface of the fragment and by means of these we find five points on the surface all lying in one plane section, in general oblique. This is done by taking five different radii and drawing pairs of circles with A, B as centres and with each of the five radii successively. These pairs of circles with equal radii, intersecting at points on the surface, determine five points on the plane bisecting AB at right angles. The five points are then represented on any plane by triangulation.

Suppose the points are A, B, C, D, E and are such that no two of the lines connecting the different pairs are parallel.

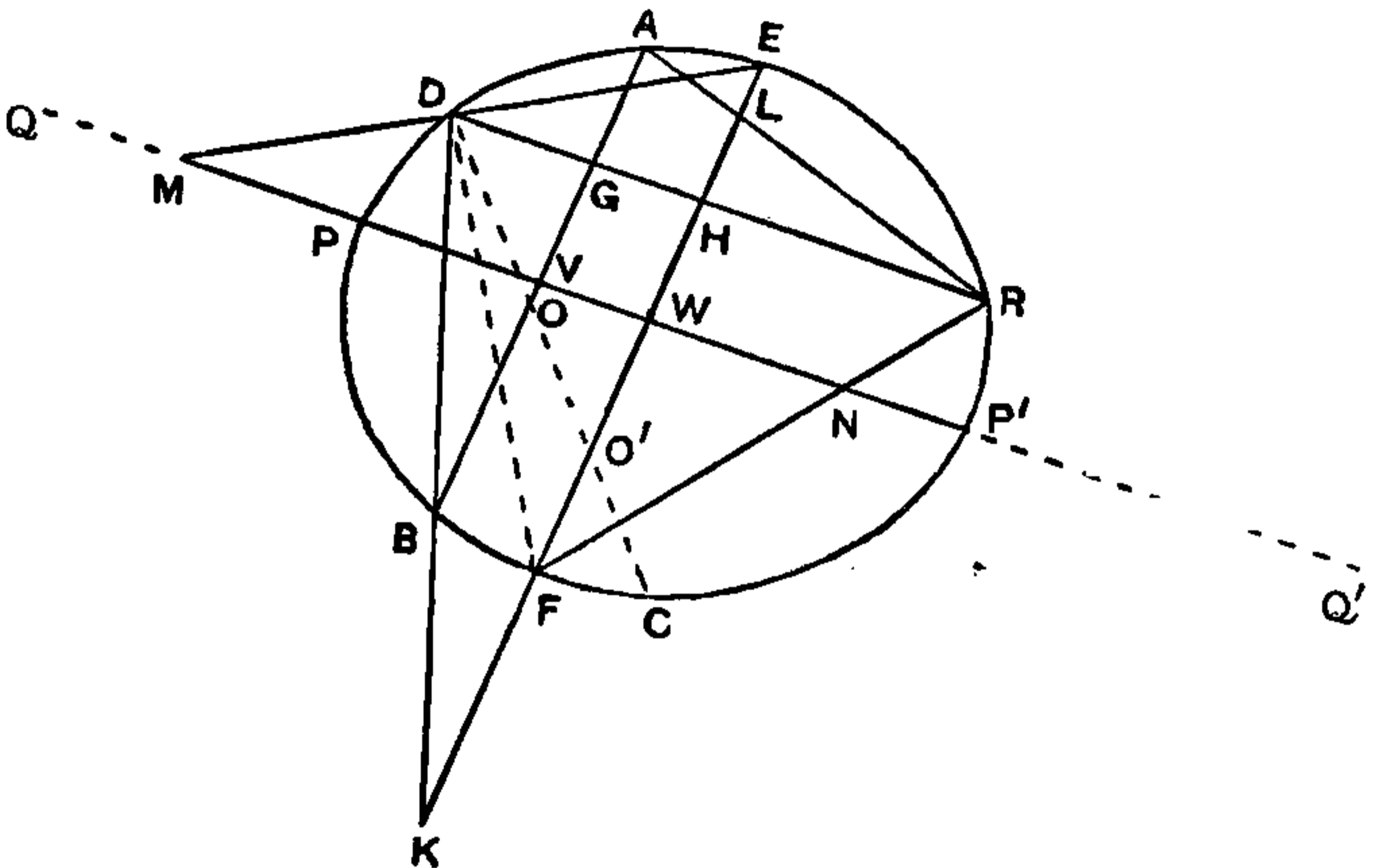

This case can be reduced to the construction of a conic through the five points A, B, D, E, F where EF is parallel to AB . This is shown in a subsequent lemma (chap. 16).

For, if EF be drawn through E parallel to AB , and if CD meet AB in O and EF in O' , we have, by the well-known proposition about intersecting chords,

$$CO \cdot OD : AO \cdot OB = CO' \cdot O'D : EO' \cdot O'F,$$

whence $O'F$ is known, and F is determined.

We have then (Prop. 13) to construct a conic through A, B, D, E, F , where EF is parallel to AB .

Bisect AB, EF at V, W ; then VW produced both ways is a diameter. Draw DR , the chord through D parallel

to this diameter. Then R is determined by means of the relation

$$RG \cdot GD : BG \cdot GA = RH \cdot HD : FH \cdot HE \quad (1)$$

in this way.

Join DB , RA , meeting EF in K , L respectively.

Then, by similar triangles,

$$\begin{aligned} RG \cdot GD : BG \cdot GA &= (RH : HL) \cdot (DH : HK) \\ &= RH \cdot HD : KH \cdot HL. \end{aligned}$$

Therefore, by (1), $FH \cdot HE = KH \cdot HL$,

whence HL is determined, and therefore L . The intersection of AL , DH determines R .

Next, in order to find the extremities P , P' of the diameter through V , W , we draw ED , RF meeting PP' in M , N respectively.

Then, as before,

$$\begin{aligned} FW \cdot WE : P'W \cdot WP &= FH \cdot HE : RH \cdot HD, \text{ by the ellipse,} \\ &= FW \cdot WE : NW \cdot WM, \text{ by similar triangles.} \end{aligned}$$

Therefore $P'W \cdot WP = NW \cdot WM$;

and similarly we can find the value of $P'V \cdot VP$.

Now, says Pappus, since $P'W \cdot WP$ and $P'V \cdot VP$ are given areas and the points V , W are given, P , P' are given. His determination of P , P' amounts (Prop. 14 following) to an elimination of one of the points and the finding of the other by means of an equation of the second degree.

Take two points Q , Q' on the diameter such that

$$P'V \cdot VP = WV \cdot VQ, \quad (\alpha)$$

$$P'W \cdot WP = VW \cdot WQ'; \quad (\beta)$$

Q , Q' are thus known, while P , P' remain to be found.

By (α) $P'V : VW = QV : VP$,

whence $P'W : VW = PQ : PV$.

Therefore, by means of (β),

$$PQ : PV = Q'W : WP,$$

so that

$$PQ : QV = Q'W : PQ',$$

or

$$PQ \cdot PQ' = QV \cdot Q'W.$$

Thus P can be found, and similarly P' .

The conjugate diameter is found by virtue of the relation

$$(\text{conjugate diam.})^2 : PP'^2 = p : PP'.$$

where p is the latus rectum to PP' determined by the property of the curve

$$p : PP' = AV^2 : PV \cdot VP'.$$

Problem, Given two conjugate diameters of an ellipse, to find the axes.

Lastly, Pappus shows (Prop. 14, chap. 17) how, when we are given two conjugate diameters, we can find the axes. The construction is as follows. Let AB, CD be conjugate diameters (CD being the greater), E the centre.

Produce EA to H so that

$$EA \cdot AH = DE^2.$$

Through A draw FG parallel to CD . Bisect EH in K , and draw KL at right angles to EH meeting FG in L .

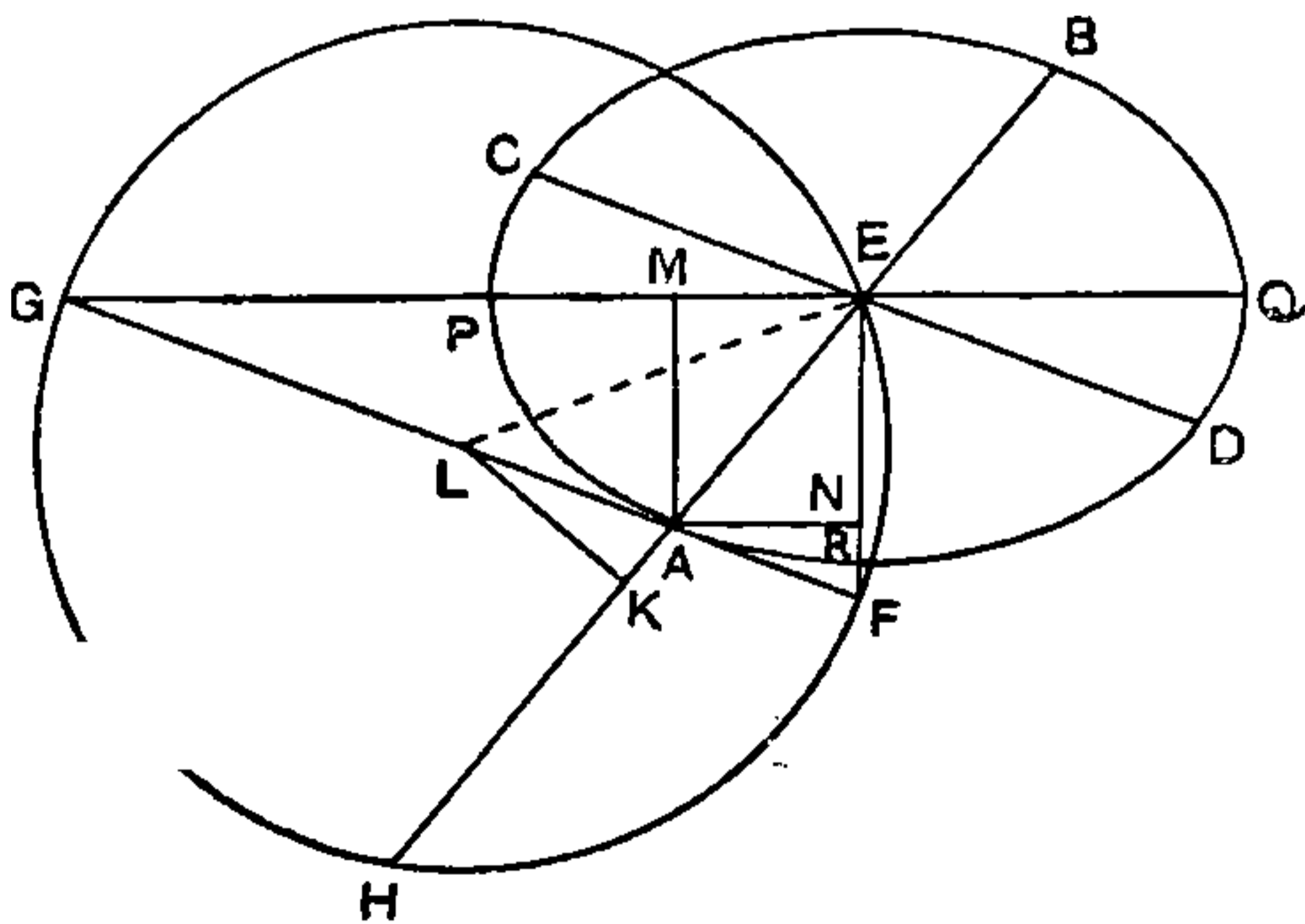

With L as centre, and LE as radius, describe a circle cutting GF in G, F .

Join EF, EG , and from A draw AM, AN parallel to EF, EG respectively.



THIS PAGE IS LOCKED TO FREE MEMBERS

Purchase full membership to immediately unlock this page

DELVE INTO FANTASY, MAGIC, MYTHOLOGY & FOLKLORE

Forgotten Books'
Full Membership gives
access to 797,885 ancient
and modern, fiction and
non-fiction books.

Continue

*Fair usage policy applies

Then he proves that, if we join AB , AB is equal to the length of the side of the hexagon required.

Produce BC to D so that $BD = BA$, and join DA . ABD is then equilateral.

Since EB is a tangent to the segment, $AE \cdot EC = EB^2$ or $AE : EB = EB : EC$, and the triangles EAB , EBC are similar.

Therefore $BA^2 : BC^2 = AE^2 : EB^2 = AE : EC = 9 : 4$;

and $BC = \frac{2}{3}BA = \frac{2}{3}BD$, so that $BC = 2CD$.

But $CF = 2CA$; therefore $AC : CF = DC : CB$, and AD , BF are parallel.

Therefore $BF : AD = BC : CD = 2 : 1$, so that

$$BF = 2AD = 2AB.$$

Also $\angle FBC = \angle BDA = 60^\circ$, so that $\angle ABF = 120^\circ$, and the triangle ABF is therefore equal and similar to the required triangle NLO .

Construction of toothed wheels and indented screws.

The rest of the Book is devoted to the construction (1) of toothed wheels with a given number of teeth equal to those of a given wheel, (2) of a cylindrical helix, the *cochlias*, indented so as to work on a toothed wheel. The text is evidently defective, and at the end an interpolator has inserted extracts about the mechanical powers from Heron's *Mechanics*.

ALGEBRA: DIOPHANTUS OF ALEXANDRIA

Beginnings learnt from Egypt.

IN algebra, as in geometry, the Greeks learnt the beginnings from the Egyptians. Familiarity on the part of the Greeks with Egyptian methods of calculation is well attested. (1) These methods are found in operation in the Heronian writings and collections. (2) Psellus in the letter published by Tannery in his edition of Diophantus speaks of 'the method of arithmetical calculations used by the Egyptians, by which problems in analysis are handled'; he adds details, doubtless taken from Anatolius, of the technical terms used for different kinds of numbers, including the powers of the unknown quantity. (3) The scholiast to Plato's *Charmides* 165 E says that 'parts of λογιστική, the science of calculation, are the so-called Greek and Egyptian methods in multiplications and divisions, and the additions and subtractions of fractions'. (4) Plato himself in the *Laws* 819 A-C says that free-born boys should, as is the practice in Egypt, learn, side by side with reading, simple mathematical calculations adapted to their age, which should be put into a form such as to combine amusement with instruction: problems about the distribution of, say, apples or garlands, the calculation of mixtures, and other questions arising in military or civil life.

'Hau'-calculations.

The Egyptian calculations here in point (apart from their method of writing and calculating in fractions, which, with the exception of $\frac{2}{3}$, were always decomposed and written as the sum of a diminishing series of aliquot parts or sub-multiples) are the *hau*-calculations. *Hau*, meaning a *heap*, is the term denoting the unknown quantity, and the calculations

in terms of it are equivalent to the solutions of simple equations with one unknown quantity. Examples from the Papyrus Rhind correspond to the following equations:

$$\frac{1}{7}x + x = 19,$$

$$\frac{2}{3}x + \frac{1}{2}x + \frac{1}{7}x + x = 33,$$

$$(x + \frac{2}{3}x) - \frac{1}{3}(x + \frac{2}{3}x) = 10.$$

The Egyptians anticipated, though only in an elementary form, a favourite method of Diophantus, that of the ‘false supposition’ or ‘regula falsi’. An arbitrary assumption is made as to the value of the unknown, and the true value is afterwards found by a comparison of the result of substituting the wrong value in the original expression with the actual data. Two examples may be given. The first, from the Papyrus Rhind, is the problem of dividing 100 loaves among five persons in such a way that the shares are in arithmetical progression, and one-seventh of the sum of the first three shares is equal to the sum of the other two. If $a + 4d$, $a + 3d$, $a + 2d$, $a + d$, a be the shares, then

$$3a + 9d = 7(2a + d),$$

or
$$d = 5\frac{1}{2}a.$$

Ahmes says, without any explanation, ‘make the difference, as it is, $5\frac{1}{2}$ ’, and then, assuming $a = 1$, writes the series 23, $17\frac{1}{2}$, 12, $6\frac{1}{2}$, 1. The addition of these gives 60, and 100 is $1\frac{2}{3}$ times 60. Ahmes says simply ‘multiply $1\frac{2}{3}$ times’ and thus gets the correct values $38\frac{1}{3}$, $29\frac{1}{6}$, 20, $10\frac{2}{3}\frac{1}{6}$, $1\frac{2}{3}$.

The second example (taken from the Berlin Papyrus 6619) is the solution of the equations

$$x^2 + y^2 = 100,$$

$$x : y = 1 : \frac{3}{4}, \text{ or } y = \frac{3}{4}x.$$

x is first assumed to be 1, and $x^2 + y^2$ is thus found to be $\frac{25}{16}$. In order to make 100, $\frac{25}{16}$ has to be multiplied by 64 or 8^2 . The true value of x is therefore 8 times 1, or 8.

Arithmetical epigrams in the Greek Anthology.

The simple equations solved in the Papyrus Rhind are just the kind of equations of which we find many examples in the



THIS PAGE IS LOCKED TO FREE MEMBERS

Purchase full membership to immediately unlock this page

FORGOTTEN BOOKS

FULL

MEMBERSHIP

797,885 Books!

All you can read

for only

\$8.99/month

Continue

*Fair usage policy applies



tions of this type with the same number of unknown quantities which was given by Thymaridas, an early Pythagorean, and was called the *ἐπάνθημα*, 'flower' or 'bloom' of Thymaridas (see vol. i, pp. 94–6). (3) Six more are problems of the usual type about the filling and emptying of vessels by pipes; e.g. (xiv. 130) one pipe fills the vessel in one day, a second in two and a third in three; how long will all three running together take to fill it? Another about brickmakers (xiv. 136) is of the same sort.

Indeterminate equations of the first degree.

The Anthology contains (4) two *indeterminate* equations of the first degree which can be solved in positive integers in an infinite number of ways (xiv. 48, 144); the first is a distribution of apples, $3x$ in number, into parts satisfying the equation $x - 3y = y$, where y is not less than 2; the second leads to three equations connecting four unknown quantities:

$$x + y = x_1 + y_1,$$

$$x = 2y_1,$$

$$x_1 = 3y,$$

the general solution of which is $x = 4k$, $y = k$, $x_1 = 3k$, $y_1 = 2k$. These very equations, which, however, are made determinate by assuming that $x + y = x_1 + y_1 = 100$, are solved in Dioph. I. 12.

Enough has been said to show that Diophantus was not the inventor of Algebra. Nor was he the first to solve indeterminate problems of the second degree.

Indeterminate equations of second degree before Diophantus.

Take first the problem (Dioph. II. 8) of dividing a square number into two squares; or of finding a right-angled triangle with sides in rational numbers. We have already seen that Pythagoras is credited with the discovery of a general formula for finding such triangles, namely,

$$n^2 + \left\{ \frac{1}{2}(n^2 - 1) \right\}^2 = \left\{ \frac{1}{2}(n^2 + 1) \right\}^2,$$

where n is any odd number, and Plato with another formula of the same sort, namely $(2n)^2 + (n^2 - 1)^2 = (n^2 + 1)^2$. Euclid (Lemma following X. 28) finds the following more general formula

$$m^2 n^2 p^2 q^2 = \left\{ \frac{1}{2} (mnp^2 + mnq^2) \right\}^2 - \left\{ \frac{1}{2} (mnp^2 - mnq^2) \right\}^2.$$

The Pythagoreans too, as we have seen (vol. i, pp. 91-3), solved another indeterminate problem, discovering, by means of the series of 'side-' and 'diameter-numbers', any number of successive integral solutions of the equations

$$2x^2 - y^2 = \pm 1.$$

Diophantus does not particularly mention this equation, but from the Lemma to VI. 15 it is clear that he knew how to find any number of solutions when one is known. Thus, seeing that $2x^2 - 1 = y^2$ is satisfied by $x = 1$, $y = 1$, he would put

$$\begin{aligned} 2(1+x)^2 - 1 &= \text{a square} \\ &= (px - 1)^2, \text{ say;} \end{aligned}$$

whence
$$x = (4 + 2p) / (p^2 - 2).$$

Take the value $p = 2$, and we have $x = 4$, and $x + 1 = 5$; in this case $2 \cdot 5^2 - 1 = 49 = 7^2$. Putting $x + 5$ in place of x , we can find a still higher value, and so on.

Indeterminate equations in the Heronian collections.

Some further Greek examples of indeterminate analysis are now available. They come from the Constantinople manuscript (probably of the twelfth century) from which Schöne edited the *Metrica* of Heron; they have been published and translated by Heiberg, with comments by Zeuthen.¹ Two of the problems (thirteen in number) had been published in a less complete form in Hultsch's Heron (*Geëponicus*, 78, 79); the others are new.

I. The first problem is to find two rectangles such that the perimeter of the second is three times that of the first, and the area of the first is three times that of the second. The

¹ *Bibliotheca mathematica*, viii₃, 1907-8, pp. 118-34. See now *Geom.* 24. 1-13 in Heron, vol. iv (ed. Heiberg), pp. 414-26.

number 3 is of course only an illustration, and the problem is equivalent to the solution of the equations

$$\left. \begin{aligned} (1) \quad u + v &= n(x + y) \\ (2) \quad xy &= n \cdot uv \end{aligned} \right\}.$$

The solution given in the text is equivalent to

$$\left. \begin{aligned} x &= 2n^3 - 1, & y &= 2n^3 \\ u &= n(4n^3 - 2), & v &= n \end{aligned} \right\}.$$

Zeuthen suggests that the solution may have been obtained thus. As the problem is indeterminate, it would be natural to start with some hypothesis, e.g. to put $v = n$. It would follow from equation (1) that u is a multiple of n , say nz . We have then

$$x + y = 1 + z,$$

while, by (2), $xy = n^3 z,$

whence $xy = n^3(x + y) - n^3,$

or $(x - n^3)(y - n^3) = n^3(n^3 - 1).$

An obvious solution is

$$x - n^3 = n^3 - 1, \quad y - n^3 = n^3,$$

which gives $z = 2n^3 - 1 + 2n^3 - 1 = 4n^3 - 2$, so that

$$u = nz = n(4n^3 - 2).$$

II. The second is a similar problem about two rectangles, equivalent to the solution of the equations

$$\left. \begin{aligned} (1) \quad x + y &= u + v \\ (2) \quad xy &= n \cdot uv \end{aligned} \right\},$$

and the solution given in the text is

$$x + y = u + v = n^3 - 1, \tag{3}$$

$$\left. \begin{aligned} u &= n - 1, & v &= n(n^2 - 1) \\ x &= n^2 - 1, & y &= n^2(n - 1) \end{aligned} \right\}. \tag{4}$$

In this case trial may have been made of the assumptions

$$v = nx, \quad y = n^2u,$$



THIS PAGE IS LOCKED TO FREE MEMBERS

Purchase full membership to immediately unlock this page

DELVE INTO FANTASY, MAGIC, MYTHOLOGY & FOLKLORE

Forgotten Books'
Full Membership gives
access to 797,885 ancient
and modern, fiction and
non-fiction books.

Continue

*Fair usage policy applies

and b . The method employed is to take the sum of the area and the perimeter $S + 2s$, separated into its two obvious factors $s(r + 2)$, to put $s(r + 2) = A$ (the given number), and then to separate A into suitable factors to which s and $r + 2$ may be equated. They must obviously be such that sr , the area, is divisible by 6. To take the first example where $A = 280$: the possible factors are 2×140 , 4×70 , 5×56 , 7×40 , 8×35 , 10×28 , 14×20 . The suitable factors in this case are $r + 2 = 8$, $s = 35$, because r is then equal to 6, and rs is a multiple of 6.

The author then says that

$$a = \frac{1}{2} [6 + 35 - \sqrt{\{(6 + 35)^2 - 8 \cdot 6 \cdot 35\}}] = \frac{1}{2} (41 - 1) = 20,$$

$$b = \frac{1}{2} (41 + 1) = 21,$$

$$c = 35 - 6 = 29.$$

The triangle is therefore (20, 21, 29) in this case. The triangles found in the other three cases, by the same method, are (9, 40, 41), (8, 15, 17) and (9, 12, 15).

Unfortunately there is no guide to the date of the problems just given. The probability is that the original formulation of the most important of the problems belongs to the period between Euclid and Diophantus. This supposition best agrees with the fact that the problems include nothing taken from the great collection in the *Arithmetica*. On the other hand, it is strange that none of the seven problems above mentioned is found in Diophantus. The five relating to rational right-angled triangles might well have been included by him; thus he finds rational right-angled triangles such that the area *plus* or *minus* one of the perpendiculars is a given number, but not the rational triangle which has a given area; and he finds rational right-angled triangles such that the area *plus* or *minus* the sum of *two* sides is a given number, but not the rational triangle such that the sum of the area and the *three* sides is a given number. The omitted problems might, it is true, have come in the lost Books; but, on the other hand, Book VI would have been the appropriate place for them.

The crowning example of a difficult indeterminate problem propounded before Diophantus's time is the Cattle-Problem attributed to Archimedes, described above (pp. 97-8).

Numerical solution of quadratic equations.

The *geometrical* algebra of the Greeks has been in evidence all through our history from the Pythagoreans downwards, and no more need be said of it here except that its arithmetical application was no new thing in Diophantus. It is probable, for example, that the solution of the quadratic equation, discovered first by geometry, was applied for the purpose of finding *numerical* values for the unknown as early as Euclid, if not earlier still. In Heron the numerical solution of equations is well established, so that Diophantus was not the first to treat equations algebraically. What he did was to take a step forward towards an algebraic *notation*.

The date of DIOPHANTUS can now be fixed with fair certainty. He was later than Hypsicles, from whom he quotes a definition of a polygonal number, and earlier than Theon of Alexandria, who has a quotation from Diophantus's definitions. The possible limits of date are therefore, say, 150 B.C. to A.D. 350. But the letter of Psellus already mentioned says that Anatolius (Bishop of Laodicea about A.D. 280) dedicated to Diophantus a concise treatise on the Egyptian method of reckoning; hence Diophantus must have been a contemporary, so that he probably flourished A.D. 250 or not much later.

An epigram in the Anthology gives some personal particulars: his boyhood lasted $\frac{1}{6}$ th of his life; his beard grew after $\frac{1}{12}$ th more; he married after $\frac{1}{7}$ th more, and his son was born 5 years later; the son lived to half his father's age, and the father died 4 years after his son. Thus, if x was his age when he died,

$$\frac{1}{6}x + \frac{1}{12}x + \frac{1}{7}x + 5 + \frac{1}{2}x + 4 = x,$$

which gives $x = 84$.

Works of Diophantus.

The works on which the fame of Diophantus rests are:

- (1) the *Arithmetica* (originally in thirteen Books),
- (2) a tract *On Polygonal Numbers*.

Six Books only of the former and a fragment of the latter survive.

Allusions in the *Arithmetica* imply the existence of

(3) A collection of propositions under the title of *Porisms*; in three propositions (3, 5, 16) of Book V, Diophantus quotes as known certain propositions in the Theory of Numbers, prefixing to the statement of them the words 'We have it in the *Porisms* that...'

A scholium on a passage of Iamblichus, where Iamblichus cites a dictum of certain Pythagoreans about the unit being the dividing line (*μεθόριον*) between number and aliquot parts, says 'thus Diophantus in the *Moriastica* . . . for he describes as "parts" the progression without limit in the direction of less than the unit'. The *Moriastica* may be a separate work by Diophantus giving rules for reckoning with fractions; but I do not feel sure that the reference may not simply be to the definitions at the beginning of the *Arithmetica*.

The *Arithmetica*.

The seven lost Books and their place.

None of the manuscripts which we possess contain more than six Books of the *Arithmetica*, the only variations being that some few divide the six Books into seven, while one or two give the fragment on Polygonal Numbers as VIII. The missing Books were evidently lost at a very early date. Tannery suggests that Hypatia's commentary extended only to the first six Books, and that she left untouched the remaining seven, which, partly as a consequence, were first forgotten and then lost (cf. the case of Apollonius's *Conics*, where the only Books which have survived in Greek, I–IV, are those on which Eutocius commented). There is no sign that even the Arabians ever possessed the missing Books. The *Fakhrī*, an algebraical treatise by Abū Bekr Muḥ. b. al-Ḥasan al-Karkhī (d. about 1029), contains a collection of problems in determinate and indeterminate analysis which not only show that their author had deeply studied Diophantus but in many cases are taken direct from the *Arithmetica*, sometimes with a change in constants; in the fourth section of the work,



THIS PAGE IS LOCKED TO FREE MEMBERS

Purchase full membership to immediately unlock this page

FORGOTTEN BOOKS

FULL

MEMBERSHIP

797,885 Books!

All you can read

for only

\$8.99/month

Continue

*Fair usage policy applies



Relation of the 'Porisms' to the Arithmetica.

Did the *Porisms* form part of the *Arithmetica* in its original form? The phrase in which they are alluded to, and which occurs three times, 'We have it in the *Porisms* that...' suggests that they were a distinct collection of propositions concerning the properties of certain numbers, their divisibility into a certain number of squares, and so on; and it is possible that it was from the same collection that Diophantus took the numerous other propositions which he assumes, explicitly or implicitly. If the collection was part of the *Arithmetica*, it would be strange to quote the propositions under a separate title 'The *Porisms*' when it would have been more natural to refer to particular propositions of particular Books, and more natural still to say *τοῦτο γὰρ προδέδεικται*, or some such phrase, 'for this has been proved', without any reference to the particular place where the proof occurred. The expression 'We have it in the *Porisms*' (in the plural) would be still more inappropriate if the *Porisms* had been, as Tannery supposed, not collected together as one or more Books of the *Arithmetica*, but scattered about in the work as *corollaries* to particular propositions. Hence I agree with the view of Hultsch that the *Porisms* were not included in the *Arithmetica* at all, but formed a separate work.

If this is right, we cannot any longer hold to the view of Nesselmann that the lost Books were in the middle and not at the end of the treatise; indeed Tannery produces strong arguments in favour of the contrary view, that it is the last and most difficult Books which are lost. He replies first to the assumption that Diophantus could not have proceeded to problems more difficult than those of Book V. 'If the fifth or the sixth Book of the *Arithmetica* had been lost, who, pray, among us would have believed that such problems had ever been attempted by the Greeks? It would be the greatest error, in any case in which a thing cannot clearly be proved to have been unknown to all the ancients, to maintain that it could not have been known to some Greek mathematician. If we do not know to what lengths Archimedes brought the theory of numbers (to say nothing of other things), let us admit our ignorance. But, between the famous problem of the

cattle and the most difficult of Diophantus's problems, is there not a sufficient gap to require seven Books to fill it? And, without attributing to the ancients what modern mathematicians have discovered, may not a number of the things attributed to the Indians and Arabs have been drawn from Greek sources? May not the same be said of a problem solved by Leonardo of Pisa, which is very similar to those of Diophantus but is not now to be found in the *Arithmetica*? In fact, it may fairly be said that, when Chasles made his reasonably probable restitution of the *Porisms* of Euclid, he, notwithstanding that he had Pappus's lemmas to help him, undertook a more difficult task than he would have undertaken if he had attempted to fill up seven Diophantine Books with numerical problems which the Greeks may reasonably be supposed to have solved.'¹

It is not so easy to agree with Tannery's view of the relation of the treatise *On Polygonal Numbers* to the *Arithmetica*. According to him, just as Serenus's treatise on the sections of cones and cylinders was added to the mutilated *Conics* of Apollonius consisting of four Books only, in order to make up a convenient volume, so the tract on Polygonal Numbers was added to the remains of the *Arithmetica*, though forming no part of the larger work.² Thus Tannery would seem to deny the genuineness of the whole tract on Polygonal Numbers, though in his text he only signalizes the portion beginning with the enunciation of the problem 'Given a number, to find in how many ways it can be a polygonal number' as 'a vain attempt by a commentator' to solve this problem. Hultsch, on the other hand, thinks that we may conclude that Diophantus really solved the problem. The tract begins, like Book I of the *Arithmetica*, with definitions and preliminary propositions; then comes the difficult problem quoted, the discussion of which breaks off in our text after a few pages, and to these it would be easy to tack on a great variety of other problems.

The name of Diophantus was used, as were the names of Euclid, Archimedes and Heron in their turn, for the purpose of palming off the compilations of much later authors.

¹ Diophantus, ed. Tannery, vol. ii, p. xx.

² *Ib.*, p. xviii.

Tannery includes in his edition three fragments under the heading 'Diophantus Pseudepigraphus'. The first, which is not 'from the Arithmetic of Diophantus' as its heading states, is worth notice as containing some particulars of one of 'two methods of finding the square root of any square number'; we are told to begin by writing the number 'according to the arrangement of the Indian method', i.e. in the Indian numerical notation which reached us through the Arabs. The second fragment is the work edited by C. Henry in 1879 as *Opusculum de multiplicatione et divisione sexagesimalibus Diophanto vel Pappo attribuendum*. The third, beginning with *Διοφάντου ἐπιπεδομετρικά* is a Byzantine compilation from later reproductions of the *γεωμετρούμενα* and *στερεομετρούμενα* of Heron. Not one of the three fragments has anything to do with Diophantus.

Commentators from Hypatia downwards.

The first commentator on Diophantus of whom we hear is Hypatia, the daughter of Theon of Alexandria; she was murdered by Christian fanatics in A.D. 415. I have already mentioned the attractive hypothesis of Tannery that Hypatia's commentary extended only to our six Books, and that this accounts for their survival when the rest were lost. It is possible that the remarks of Psellus (eleventh century) at the beginning of his letter about Diophantus, Anatolius and the Egyptian method of arithmetical reckoning were taken from Hypatia's commentary.

Georgius Pachymeres (1240 to about 1310) wrote in Greek a paraphrase of at least a portion of Diophantus. Sections 25-44 of this commentary relating to Book I, Def. 1 to Prop. 11, survive. Maximus Planudes (about 1260-1310) also wrote a systematic commentary on Books I, II. Arabian commentators were Abū'l Wafā al-Būzjānī (940-98), Qustā b. Lūqā al-Ba'labakkī (d. about 912) and probably Ibn al-Haitham (about 965-1039).

Translations and editions.

To Regiomontanus belongs the credit of being the first to call attention to the work of Diophantus as being extant in



THIS PAGE IS LOCKED TO FREE MEMBERS

Purchase full membership to immediately unlock this page

DELVE INTO FANTASY, MAGIC, MYTHOLOGY & FOLKLORE

**Forgotten Books'
Full Membership gives
access to 797,885 ancient
and modern, fiction and
non-fiction books.**

Continue

*Fair usage policy applies

unfortunately spoiled by corrections made, especially in Books I, II, from some manuscript of the 'Planudean' class; where this is the case recourse must be had to Vat. gr. 191 which was copied from it before it had suffered the general alteration referred to: these are the first two of the manuscripts used by Tannery in his definitive edition of the Greek text (Teubner, 1893, 1895).

Other editors can only be shortly enumerated. In 1585 Simon Stevin published a French version of the first four Books, based on Xylander. Albert Girard added the fifth and sixth Books, the complete edition appearing in 1625. German translations were brought out by Otto Schulz in 1822 and by G. Wertheim in 1890. Poselger translated the fragment on Polygonal Numbers in 1810. All these translations depended on the text of Bachet.

A reproduction of Diophantus in modern notation with introduction and notes by the present writer (second edition 1910) is based on the text of Tannery and may claim to be the most complete and up-to-date edition.

My account of the *Arithmetica* of Diophantus will be most conveniently arranged under three main headings (1) the notation and definitions, (2) the principal methods employed, so far as they can be generally stated, (3) the nature of the contents, including the assumed Porisms, with indications of the devices by which the problems are solved.

Notation and definitions.

In his work *Die Algebra der Griechen* Nesselmann distinguishes three stages in the evolution of algebra. (1) The first stage he calls 'Rhetorical Algebra' or reckoning by means of complete words. The characteristic of this stage is the absolute want of all symbols, the whole of the calculation being carried on by means of complete words and forming in fact continuous prose. This first stage is represented by such writers as Iamblichus, all Arabian and Persian algebraists, and the oldest Italian algebraists and their followers, including Regiomontanus. (2) The second stage Nesselmann calls the 'Syncopated Algebra', essentially like the first as regards

literary style, but marked by the use of certain abbreviational symbols for constantly recurring quantities and operations. To this stage belong Diophantus and, after him, all the later Europeans until about the middle of the seventeenth century (with the exception of Vieta, who was the first to establish, under the name of *Logistica speciosa*, as distinct from *Logistica numerosa*, a regular system of reckoning with letters denoting magnitudes as well as numbers). (3) To the third stage Nesselmann gives the name of 'Symbolic Algebra', which uses a complete system of notation by signs having no visible connexion with the words or things which they represent, a complete language of symbols, which entirely supplants the 'rhetorical' system, it being possible to work out a solution without using a single word of ordinary language with the exception of a connecting word or two here and there used for clearness' sake.

Sign for the unknown ($= x$), and its origin.

Diophantus's system of notation then is merely abbreviational. We will consider first the representation of the unknown quantity (our x). Diophantus defines the unknown quantity as 'containing an indeterminate or undefined multitude of units' (*πλήθος μονάδων ἀόριστον*), adding that it is called *ἀριθμός*, i.e. *number* simply, and is denoted by a certain sign. This sign is then used all through the book. In the earliest (the Madrid) MS. the sign takes the form ς , in Marcianus 308 it appears as S. In the printed editions of Diophantus before Tannery's it was represented by the final sigma with an accent, ς' , which is sufficiently like the second of the two forms. Where the symbol takes the place of inflected forms *ἀριθμόν*, *ἀριθμοῦ*, &c., the termination was put above and to the right of the sign like an exponent, e.g. ς'' for *ἀριθμόν* as τ'' for *τὸν*, $\varsigma^{o\upsilon}$ for *ἀριθμοῦ*; the symbol was, in addition, doubled in the plural cases, thus $\varsigma\varsigma^{o\iota}$, $\varsigma\varsigma^{o\upsilon\varsigma}$, &c. The coefficient is expressed by putting the required Greek numeral immediately after it; thus $\varsigma\varsigma^{o\iota} \iota\alpha = 11$ *ἀριθμοί*, equivalent to $11x$, $\varsigma' \alpha = x$, and so on. Tannery gives reasons for thinking that in the archetype the case-endings did not appear, and

that the sign was not duplicated for the plural, although such duplication was the practice of the Byzantines. That the sign was merely an abbreviation for the word ἀριθμός and no algebraical symbol is shown by the fact that it occurs in the manuscripts for ἀριθμός in the ordinary sense as well as for ἀριθμός in the technical sense of the unknown quantity. Nor is it confined to Diophantus. It appears in more or less similar forms in the manuscripts of other Greek mathematicians, e.g. in the Bodleian MS. of Euclid (D'Orville 301) of the ninth century (in the forms ζ̇ ζ̇ζ̇, or as a curved line similar to the abbreviation for καί), in the manuscripts of the *Sand-reckoner* of Archimedes (in a form approximating to s), where again there is confusion caused by the similarity of the signs for ἀριθμός and καί, in a manuscript of the *Geodaesia* included in the Heronian collections edited by Hultsch (where it appears in various forms resembling sometimes ζ, sometimes ρ, sometimes ο, and once ξ, with case-endings superposed) and in a manuscript of Theon of Smyrna.

What is the origin of the sign? It is certainly not the final sigma, as is proved by several of the forms which it takes. I found that in the Bodleian manuscript of Diophantus it is written in the form ζ̇, larger than and quite unlike the final sigma. This form, combined with the fact that in one place Xylander's manuscript read αρ for the full word, suggested to me that the sign might be a simple contraction of the first two letters of ἀριθμός. This seemed to be confirmed by Gardthausen's mention of a contraction for αρ, in the form υρ occurring in a papyrus of A.D. 154, since the transition to the form found in the manuscripts of Diophantus might easily have been made through an intermediate form ς. The loss of the downward stroke, or of the loop, would give a close approximation to the forms which we know. This hypothesis as to the origin of the sign has not, so far as I know, been improved upon. It has the immense advantage that it makes the sign for ἀριθμός similar to the signs for the powers of the unknown, e.g. Δ^Υ for δύναμις, Κ^Υ for κύβος, and to the sign $\overset{\circ}{M}$ for the unit, the sole difference being that the two letters coalesce into one instead of being separate.



THIS PAGE IS LOCKED TO FREE MEMBERS

Purchase full membership to immediately unlock this page

FORGOTTEN BOOKS

FULL

MEMBERSHIP

797,885 Books!

All you can read

for only

\$8.99/month

Continue

*Fair usage policy applies



When there are units in addition, the units are indicated by the abbreviation $\overset{\circ}{M}$; thus $K^Y \alpha \Delta^Y \iota \gamma s \epsilon \overset{\circ}{M} \beta$ corresponds to $x^3 + 13x^2 + 5x + 2$.

The sign (Λ) for minus and its meaning.

For subtraction alone is a sign used. The full term for *wanting* is $\lambda\epsilon\acute{\iota}\psi\iota\varsigma$, as opposed to $\epsilon\upsilon\pi\alpha\rho\xi\iota\varsigma$, a *forthcoming*, which denotes a *positive* term. The symbol used to indicate a *wanting*, corresponding to our sign for *minus*, is Λ , which is described in the text as a ' ψ turned downwards and truncated' ($\Psi \acute{\epsilon}\lambda\lambda\iota\pi\acute{\epsilon}\varsigma \kappa\acute{\alpha}\tau\omega \nu\epsilon\upsilon\omicron\nu$). The description is evidently interpolated, and it is now certain that the sign has nothing to do with ψ . Nor is it confined to Diophantus, for it appears in practically the same form in Heron's *Metrica*,¹ where in one place the reading of the manuscript is $\mu\omicron\nu\acute{\alpha}\delta\omega\nu \omicron\delta \Upsilon \acute{\iota}\delta'$, $74 - \frac{1}{14}$. In the manuscripts of Diophantus, when the sign is resolved by writing the full word instead of it, it is generally resolved into $\lambda\epsilon\acute{\iota}\psi\epsilon\iota$, the dative of $\lambda\epsilon\acute{\iota}\psi\iota\varsigma$, but in other places the symbol is used instead of parts of the verb $\lambda\epsilon\acute{\iota}\pi\epsilon\iota\nu$, namely $\lambda\iota\pi\acute{\omega}\nu$ or $\lambda\epsilon\acute{\iota}\psi\alpha\varsigma$ and once even $\lambda\acute{\iota}\pi\omega\sigma\iota$; sometimes $\lambda\epsilon\acute{\iota}\psi\epsilon\iota$ in the manuscripts is followed by the *accusative*, which shows that in these cases the sign was wrongly resolved. It is therefore a question whether Diophantus himself ever used the dative $\lambda\epsilon\acute{\iota}\psi\epsilon\iota$ for *minus* at all. The use is certainly foreign to classical Greek. Ptolemy has in two places $\lambda\epsilon\acute{\iota}\psi\alpha\nu$ and $\lambda\epsilon\acute{\iota}\pi\omicron\upsilon\sigma\alpha\nu$ respectively followed, properly, by the *accusative*, and in one case he has $\tau\omicron\delta \acute{\alpha}\pi\omicron\tau\eta\varsigma \Gamma\Lambda \lambda\epsilon\iota\phi\theta\acute{\epsilon}\nu \acute{\upsilon}\pi\omicron\delta \tau\omicron\upsilon\delta \acute{\alpha}\pi\omicron\tau\eta\varsigma Z\Gamma$ (where the meaning is $Z\Gamma^2 - \Gamma\Lambda^2$). Hence Heron would probably have written a participle where the Υ occurs in the expression quoted above, say $\mu\omicron\nu\acute{\alpha}\delta\omega\nu \omicron\delta \lambda\epsilon\iota\psi\alpha\sigma\acute{\omega}\nu \tau\epsilon\sigma\sigma\alpha\rho\alpha\kappa\alpha\iota\delta\acute{\epsilon}\kappa\alpha\tau\omicron\nu$. On the whole, therefore, it is probable that in Diophantus, and wherever else it occurred, Λ is a compendium for the root of the verb $\lambda\epsilon\acute{\iota}\pi\epsilon\iota\nu$, in fact a Λ with ι placed in the middle (cf. Λ , an abbreviation for $\tau\acute{\alpha}\lambda\alpha\nu\tau\omicron\nu$). This is the hypothesis which I put forward in 1885, and it seems to be confirmed by the fresh evidence now available as shown above.

¹ Heron, *Metrica*, p. 156. 8, 10.

Attached to the definition of *minus* is the statement that 'a *wanting* (i.e. a *minus*) multiplied by a *wanting* makes a *forthcoming* (i.e. a *plus*); and a *wanting* (a *minus*) multiplied by a *forthcoming* (a *plus*) makes a *wanting* (a *minus*)'.

Since Diophantus uses no sign for *plus*, he has to put all the positive terms in an expression together and write all the negative terms together after the sign for *minus*; e.g. for $x^3 - 5x^2 + 8x - 1$ he necessarily writes $\text{K}^{\text{Y}} \alpha \varsigma \eta \text{A} \Delta^{\text{Y}} \epsilon \overset{\circ}{\text{M}} \alpha$.

The Diophantine notation for fractions as well as for large numbers has been fully explained with many illustrations in Chapter II above. It is only necessary to add here that, when the numerator and denominator consist of composite expressions in terms of the unknown and its powers, he puts the numerator first followed by *ἐν μορίῳ* or *μορίου* and the denominator.

$$\begin{aligned} \text{Thus } \quad \Delta^{\text{Y}} \xi \overset{\circ}{\text{M}} \beta \phi \kappa \text{ ἐν μορίῳ } \Delta^{\text{Y}} \Delta \alpha \overset{\circ}{\text{M}} \eta \text{A} \Delta^{\text{Y}} \xi \\ = (60x^2 + 2520) / (x^4 + 900 - 60x^2), \quad [\text{VI. 12}] \end{aligned}$$

$$\begin{aligned} \text{and } \quad \Delta^{\text{Y}} \iota \epsilon \text{A} \overset{\circ}{\text{M}} \lambda \varsigma \text{ ἐν μορίῳ } \Delta^{\text{Y}} \Delta \alpha \overset{\circ}{\text{M}} \lambda \varsigma \text{A} \Delta^{\text{Y}} \iota \beta \\ = (15x^2 - 36) / (x^4 + 36 - 12x^2) \quad [\text{VI. 14}]. \end{aligned}$$

For a *term* in an algebraical expression, i.e. a power of x with a certain coefficient, and the term containing a certain number of units, Diophantus uses the word *εἶδος*, 'species', which primarily means the particular power of the variable without the coefficient. At the end of the definitions he gives directions for simplifying equations until each side contains positive terms only, by the addition or subtraction of coefficients, and by getting rid of the negative terms (which is done by adding the necessary quantities to both sides); the object, he says, is to reduce the equation until one term only is left on each side; 'but', he adds, 'I will show you later how, in the case also where two terms are left equal to one term, such a problem is solved'. We find in fact that, when he has to solve a quadratic equation, he endeavours by means of suitable assumptions to reduce it either to a simple equation or a *pure* quadratic. The solution of the mixed quadratic

in three terms is clearly assumed in several places of the *Arithmetica*, but Diophantus never gives the necessary explanation of this case as promised in the preface.

Before leaving the notation of Diophantus, we may observe that the form of it limits him to the use of one unknown at a time. The disadvantage is obvious. For example, where we can begin with any number of unknown quantities and gradually eliminate all but one, Diophantus has practically to perform his eliminations beforehand so as to express every quantity occurring in the problem in terms of only one unknown. When he handles problems which are by nature indeterminate and would lead in our notation to an indeterminate equation containing two or three unknowns, he has to assume for one or other of these some particular number arbitrarily chosen, the effect being to make the problem determinate. However, in doing so, Diophantus is careful to say that we may for such and such a quantity put any number whatever, say such and such a number; there is therefore (as a rule) no real loss of generality. The particular devices by which he contrives to express all his unknowns in terms of one unknown are extraordinarily various and clever. He can, of course, use the same variable s in the same problem with different significations *successively*, as when it is necessary in the course of the problem to solve a subsidiary problem in order to enable him to make the coefficients of the different terms of expressions in x such as will answer his purpose and enable the original problem to be solved. There are, however, two cases, II. 28, 29, where for the proper working-out of the problem two unknowns are imperatively necessary. We should of course use x and y ; Diophantus calls the first s as usual; the second, for want of a term, he agrees to call in the first instance 'one unit', i.e. 1. Then later, having completed the part of the solution necessary to find x , he substitutes its value and uses s over again for what he had originally called 1. That is, he has to put his finger on the place to which the 1 has passed, so as to substitute s for it. This is a *tour de force* in the particular cases, and would be difficult or impossible in more complicated problems.



THIS PAGE IS LOCKED TO FREE MEMBERS

Purchase full membership to immediately unlock this page

DELVE INTO FANTASY, MAGIC, MYTHOLOGY & FOLKLORE

Forgotten Books'
Full Membership gives
access to 797,885 ancient
and modern, fiction and
non-fiction books.

Continue

*Fair usage policy applies

equation and neutralize negative terms by adding to both sides, then take like from like again, until we have one term left equal to one term. After these operations have been performed, the equation (after dividing out, if both sides contain a power of x , by the lesser power) reduces to $Ax^m = B$, and is considered solved. Diophantus regards this as giving one root only, excluding any negative value as 'impossible'. No equation of the kind is admitted which does not give a 'rational' value, integral or fractional. The value $x = 0$ is ignored in the case where the degree of the equation is reduced by dividing out by any power of x .

(2) *Mixed quadratic equations.*

Diophantus never gives the explanation of the method of solution which he promises in the preface. That he had a definite method like that used in the Geometry of Heron is proved by clear verbal explanations in different propositions. As he requires the equation to be in the form of two positive terms being equal to one positive term, the possible forms for Diophantus are

$$(a) \quad mx^2 + px = q, \quad (b) \quad mx^2 = px + q, \quad (c) \quad mx^2 + q = px.$$

It does not appear that Diophantus divided by m in order to make the first term a square; rather he multiplied by m for this purpose. It is clear that he stated the roots in the above cases in a form equivalent to

$$(a) \quad \frac{-\frac{1}{2}p + \sqrt{(\frac{1}{4}p^2 + mq)}}{m}, \quad (b) \quad \frac{\frac{1}{2}p + \sqrt{(\frac{1}{4}p^2 + mq)}}{m},$$

$$(c) \quad \frac{\frac{1}{2}p + \sqrt{(\frac{1}{4}p^2 - mq)}}{m}.$$

The explanations which show this are to be found in VI. 6, in IV. 39 and 31, and in V. 10 and VI. 22 respectively. For example in V. 10 he has the equation $17x^2 + 17 < 72x$, and he says 'Multiply half the coefficient of x into itself and we have 1296; subtract the product of the coefficient of x^2 and the term in units, or 289. The remainder is 1007, the square root of which is not greater than 31. Add half the coefficient of x and the result is not greater than 67. Divide by the coefficient of x^2 , and x is not greater than $\frac{67}{17}$.' In IV. 39 he has the

equation $2x^2 > 6x + 18$ and says, 'To solve this, take the square of half the coefficient of x , i.e. 9, and the product of the unit-term and the coefficient of x^2 , i.e. 36. Adding, we have 45, the square root of which is not less than 7. Add half the coefficient of x [and divide by the coefficient of x^2]; whence x is not less than 5.' In these cases it will be observed that 31 and 7 are not accurate limits, but are the nearest integral limits which will serve his purpose.

Diophantus always uses the positive sign with the radical, and there has been much discussion as to whether he knew that a quadratic equation has *two* roots. The evidence of the text is inconclusive because his only object, in every case, is to get one solution; in some cases the other root would be negative, and would therefore naturally be ignored as 'absurd' or 'impossible'. In yet other cases where the second root is possible it can be shown to be useless from Diophantus's point of view. For my part, I find it difficult or impossible to believe that Diophantus was unaware of the existence of two real roots in such cases. It is so obvious from the geometrical form of solution based on Eucl. II. 5, 6 and that contained in Eucl. VI. 27-9; the construction of VI. 28, too, corresponds in fact to the *negative* sign before the radical in the case of the particular equation there solved, while a quite obvious and slight variation of the construction would give the solution corresponding to the *positive* sign.

The following particular cases of quadratics occurring in the *Arithmetica* may be quoted, with the results stated by Diophantus.

$$x^2 = 4x - 4; \text{ therefore } x = 2. \quad (\text{IV. 22})$$

$$325x^2 = 3x + 18; x = \frac{78}{325} \text{ or } \frac{6}{25}. \quad (\text{IV. 31})$$

$$84x^2 + 7x = 7; x = \frac{1}{4}. \quad (\text{VI. 6})$$

$$84x^2 - 7x = 7; x = \frac{1}{3}. \quad (\text{VI. 7})$$

$$630x^2 - 73x = 6; x = \frac{6}{35}. \quad (\text{VI. 9})$$

$$630x^2 + 73x = 6; x \text{ is rational.} \quad (\text{VI. 8})$$

$$5x < x^2 - 60 < 8x; x \text{ not } < 11 \text{ and not } > 12. \quad (\text{V. 30})$$

$$17x^2 + 17 < 72x < 19x^2 + 19; x \text{ not } > \frac{67}{17} \text{ and not } < \frac{66}{19}. \quad (\text{V. 10})$$

$$22x < x^2 + 60 < 24x; x \text{ not } < 19 \text{ but } < 21. \quad (\text{V. 30})$$

In the first and third of the last three cases the limits are not accurate, but are *integral* limits which are *a fortiori* safe. In the second $\frac{66}{19}$ should have been $\frac{67}{19}$, and it would have been more correct to say that, if x is not greater than $\frac{67}{19}$ and not less than $\frac{67}{19}$, the given conditions are *a fortiori* satisfied.

For comparison with Diophantus's solutions of quadratic equations we may refer to a few of his solutions of

(3) *Simultaneous equations involving quadratics.*

In I. 27, 28, and 30 we have the following pairs of equations.

$$\left. \begin{array}{l} (\alpha) \quad \xi + \eta = 2a \\ \quad \quad \xi\eta = B \end{array} \right\}, \quad \left. \begin{array}{l} (\beta) \quad \xi + \eta = 2a \\ \quad \quad \xi^2 + \eta^2 = B. \end{array} \right\}, \quad \left. \begin{array}{l} (\gamma) \quad \xi - \eta = 2a \\ \quad \quad \xi\eta = B \end{array} \right\}.$$

I use the Greek letters for the numbers required to be found as distinct from the one unknown which Diophantus uses, and which I shall call x .

In (α), he says, let $\xi - \eta = 2x$ ($\xi > \eta$).

It follows, by addition and subtraction, that $\xi = a + x$, $\eta = a - x$;

therefore $\xi\eta = (a + x)(a - x) = a^2 - x^2 = B$,

and x is found from the pure quadratic equation.

In (β) similarly he assumes $\xi - \eta = 2x$, and the resulting equation is $\xi^2 + \eta^2 = (a + x)^2 + (a - x)^2 = 2(a^2 + x^2) = B$.

In (γ) he puts $\xi + \eta = 2x$ and solves as in the case of (α).

(4) *Cubic equation.*

Only one very particular case occurs. In VI. 17 the problem leads to the equation

$$x^2 + 2x + 3 = x^3 + 3x - 3x^2 - 1.$$

Diophantus says simply 'whence x is found to be 4'. In fact the equation reduces to

$$x^3 + x = 4x^2 + 4.$$

Diophantus no doubt detected, and divided out by, the common factor $x^2 + 1$, leaving $x = 4$.



THIS PAGE IS LOCKED TO FREE MEMBERS

Purchase full membership to immediately unlock this page

FORGOTTEN BOOKS

FULL

MEMBERSHIP

797,885 Books!

All you can read

for only

\$8.99/month

Continue

*Fair usage policy applies



(β) when C is positive and a square, say c^2 ;
 in this case Diophantus puts $Ax^2 + c^2 = (mx \pm c)^2$, and obtains

$$x = \pm \frac{2mc}{A - m^2}.$$

(γ) When one solution is known, any number of other solutions can be found. This is stated in the Lemma to VI. 15. It would be true not only of the cases $\pm Ax^2 \mp C = y^2$, but of the general case $Ax^2 + Bx + C = y^2$. Diophantus, however, only states it of the case $Ax^2 - C = y^2$.

His method of finding other (greater) values of x satisfying the equation when one (x_0) is known is as follows. If $Ax_0^2 - C = q^2$, he substitutes in the original equation $(x_0 + x)$ for x and $(q - kx)$ for y , where k is some integer.

Then, since $A(x_0 + x)^2 - C = (q - kx)^2$, while $Ax_0^2 - C = q^2$, it follows by subtraction that

$$2x(Ax_0 + kq) = x^2(k^2 - A),$$

whence
$$x = 2(Ax_0 + kq) / (k^2 - A),$$

and the new value of x is $x_0 + \frac{2(Ax_0 + kq)}{k^2 - A}$.

Form $Ax^2 - c^2 = y^2$.

Diophantus says (VI. 14) that a rational solution of this case is only possible when A is the sum of two squares.

[In fact, if $x = p/q$ satisfies the equation, and $Ax^2 - c^2 = k^2$,

we have
$$Ap^2 = c^2q^2 + k^2q^2,$$

or
$$A = \left(\frac{cq}{p}\right)^2 + \left(\frac{kq}{p}\right)^2.]$$

Form $Ax^2 + C = y^2$.

Diophantus proves in the Lemma to VI. 12 that this equation has an infinite number of solutions when $A + C$ is a square, i. e. in the particular case where $x = 1$ is a solution. (He does not, however, always bear this in mind, for in III. 10 he regards the equation $52x^2 + 12 = y^2$ as impossible though $52 + 12 = 64$ is a square, just as, in III. 11, $266x^2 - 10 = y^2$ is regarded as impossible.)

Suppose that $A + C = q^2$; the equation is then solved by

substituting in the original equation $1 + x$ for x and $(q - kx)$ for y , where k is some integer.

3. Form $Ax^2 + Bx + C = y^2$.

This can be reduced to the form in which the second term is wanting by replacing x by $z - \frac{B}{2A}$.

Diophantus, however, treats this case separately and less fully. According to him, a rational solution of the equation $Ax^2 + Bx + C = y^2$ is only possible

(α) when A is positive and a square, say a^2 ;

(β) when C is positive and a square, say c^2 ;

(γ) when $\frac{1}{4}B^2 - AC$ is positive and a square.

In case (α) y is put equal to $(ax - m)$, and in case (β) y is put equal to $(mx - c)$.

Case (γ) is not expressly enunciated, but occurs, as it were, accidentally (IV. 31). The equation to be solved is $3x + 18 - x^2 = y^2$. Diophantus first assumes $3x + 18 - x^2 = 4x^2$, which gives the quadratic $3x + 18 = 5x^2$; but this 'is not rational'. Therefore the assumption of $4x^2$ for y^2 will not do, 'and we must find a square [to replace 4] such that 18 times (this square + 1) + $(\frac{3}{2})^2$ may be a square'. The auxiliary equation is therefore $18(m^2 + 1) + \frac{9}{4} = y^2$, or $72m^2 + 81 =$ a square, and Diophantus assumes $72m^2 + 81 = (8m + 9)^2$, whence $m = 18$. Then, assuming $3x + 18 - x^2 = (18)^2x^2$, he obtains the equation $325x^2 - 3x - 18 = 0$, whence $x = \frac{78}{325}$, that is, $\frac{6}{25}$.

(2) *Double equation.*

The Greek term is $\delta\iota\pi\lambda\omicron\iota\sigma\acute{o}\tau\eta\varsigma$, $\delta\iota\pi\lambda\hat{\eta}$ $\acute{\iota}\sigma\acute{o}\tau\eta\varsigma$ or $\delta\iota\pi\lambda\hat{\eta}$ $\acute{\iota}\sigma\omega\sigma\iota\varsigma$. Two different functions of the unknown have to be made simultaneously squares. The general case is to solve in rational numbers the equations

$$\left. \begin{aligned} mx^2 + \alpha x + a &= u^2 \\ nx^2 + \beta x + b &= w^2 \end{aligned} \right\}.$$

The necessary preliminary condition is that each of the two expressions can be made a square. This is always possible when the first term (in x^2) is wanting. We take this simplest case first.

1. *Double equation of the first degree.*

The equations are

$$\begin{aligned}\alpha x + a &= u^2, \\ \beta x + b &= w^2.\end{aligned}$$

Diophantus has one general method taking slightly different forms according to the nature of the coefficients.

(α) First method of solution.

This depends upon the identity

$$\left\{\frac{1}{2}(p+q)\right\}^2 - \left\{\frac{1}{2}(p-q)\right\}^2 = pq.$$

If the difference between the two expressions in x can be separated into two factors p, q , the expressions themselves are equated to $\left\{\frac{1}{2}(p+q)\right\}^2$ and $\left\{\frac{1}{2}(p-q)\right\}^2$ respectively. As Diophantus himself says in II. 11, we 'equate either the square of half the difference of the two factors to the lesser of the expressions, or the square of half the sum to the greater'.

We will consider the general case and investigate to what particular classes of cases the method is applicable from Diophantus's point of view, remembering that the final quadratic in x must always reduce to a single equation.

Subtracting, we have $(\alpha - \beta)x + (a - b) = u^2 - w^2$.

Separate $(\alpha - \beta)x + (a - b)$ into the factors

$$p, \{(\alpha - \beta)x + (a - b)\} / p.$$

We write accordingly

$$\begin{aligned}u \pm w &= \frac{(\alpha - \beta)x + (a - b)}{p}, \\ u \mp w &= p.\end{aligned}$$

$$\text{Thus } u^2 = \alpha x + a = \frac{1}{4} \left\{ \frac{(\alpha - \beta)x + (a - b)}{p} + p \right\}^2;$$

$$\text{therefore } \{(\alpha - \beta)x + a - b + p^2\}^2 = 4p^2(\alpha x + a).$$

This reduces to

$$\begin{aligned}(\alpha - \beta)^2 x^2 + 2x \{(\alpha - \beta)(a - b) - p^2(\alpha + \beta)\} \\ + (a - b)^2 - 2p^2(a + b) + p^4 = 0.\end{aligned}$$



THIS PAGE IS LOCKED TO FREE MEMBERS

Purchase full membership to immediately unlock this page

DELVE INTO FANTASY, MAGIC, MYTHOLOGY & FOLKLORE

Forgotten Books'
Full Membership gives
access to 797,885 ancient
and modern, fiction and
non-fiction books.

Continue

*Fair usage policy applies

Ex. from Diophantus:

$$\left. \begin{aligned} 65 - 6x &= u^2 \\ 65 - 24x &= w^2 \end{aligned} \right\}; \quad (\text{IV. 32})$$

therefore

$$\left. \begin{aligned} 260 - 24x &= u'^2 \\ 65 - 24x &= w'^2 \end{aligned} \right\}.$$

The difference = $195 = 15 \cdot 13$, say;

therefore $\frac{1}{4}(15 - 13)^2 = 65 - 24x$; that is, $24x = 64$, and $x = \frac{8}{3}$.

Taking now the condition (2) that ab is a square, we see that the equations can be solved in the cases where either a and b are both squares, or the ratio of a to b is the ratio of a square to a square. If the equations are

$$\begin{aligned} \alpha x + c^2 &= u^2, \\ \beta x + d^2 &= w^2, \end{aligned}$$

and factors are taken of the difference between the expressions as they stand, then, since one factor p , as we saw, satisfies the equation

$$\{p^2 - (c^2 + d^2)\}^2 = 4c^2d^2,$$

we must have

$$p = c \pm d.$$

Ex. from Diophantus:

$$\left. \begin{aligned} 10x + 9 &= u^2 \\ 5x + 4 &= w^2 \end{aligned} \right\}. \quad (\text{III. 15})$$

The difference is $5x + 5 = 5(x + 1)$; the solution is given by $(\frac{1}{2}x + 3)^2 = 10x + 9$, and $x = 28$.

Another method is to multiply the equations by squares such that, when the expressions are subtracted, the absolute term vanishes. The case can be worked out generally, thus.

Multiply by d^2 and c^2 respectively, and we have to solve

$$\left. \begin{aligned} \alpha d^2 x + c^2 d^2 &= u^2 \\ \beta c^2 x + c^2 d^2 &= w^2 \end{aligned} \right\}.$$

Difference = $(\alpha d^2 - \beta c^2)x = px \cdot q$ say.

Then x is found from the equation

$$\alpha d^2 x + c^2 d^2 = \frac{1}{4}(px + q)^2,$$

which gives $p^2 x^2 + 2x(pq - 2\alpha d^2) + q^2 - 4c^2 d^2 = 0$,

or, since

$$pq = \alpha d^2 - \beta c^2,$$

$$p^2 x^2 - 2x(\alpha d^2 + \beta c^2) + q^2 - 4c^2 d^2 = 0.$$

In order that this may reduce to a simple equation, as Diophantus requires, the absolute term must vanish, so that $q = 2cd$. The method therefore only gives one solution, since q is restricted to the value $2cd$.

Ex. from Diophantus:

$$\left. \begin{aligned} 8x + 4 &= u^2 \\ 6x + 4 &= w^2 \end{aligned} \right\}. \quad (\text{IV. 39})$$

Difference $2x$; q necessarily taken to be $2\sqrt{4}$ or 4 ; factors therefore $\frac{1}{2}x, 4$. Therefore $8x + 4 = \frac{1}{4}(\frac{1}{2}x + 4)^2$, and $x = 112$.

(β) Second method of solution of a double equation of the first degree.

There is only one case of this in Diophantus, the equations being of the form

$$\left. \begin{aligned} hx + n^2 &= u^2 \\ (h + f)x + n^2 &= w^2 \end{aligned} \right\}.$$

Suppose $hx + n^2 = (y + n)^2$; therefore $hx = y^2 + 2ny$,

and $(h + f)x + n^2 = (y + n)^2 + \frac{f}{h}(y^2 + 2ny)$.

It only remains to make the latter expression a square, which is done by equating it to $(py - n)^2$.

The case in Diophantus is the same as that last mentioned (IV. 39). Where I have used y , Diophantus as usual contrives to use his one unknown a second time.

2. Double equations of the second degree.

The general form is

$$\left. \begin{aligned} Ax^2 + Bx + C &= u^2 \\ A'x^2 + B'x + C' &= w^2 \end{aligned} \right\};$$

but only three types appear in Diophantus, namely

$$(1) \left. \begin{aligned} \rho^2 x^2 + \alpha x + a &= u^2 \\ \rho^2 x^2 + \beta x + b &= w^2 \end{aligned} \right\}, \text{ where, except in one case, } a = b.$$

$$(2) \left. \begin{aligned} x^2 + \alpha x + a &= u^2 \\ \beta x^2 + a &= w^2 \end{aligned} \right\}.$$

(The case where the absolute terms are in the ratio of a square to a square reduces to this.)

In all examples of these cases the usual method of solution applies.

$$(3) \left. \begin{aligned} \alpha x^2 + ax &= u^2 \\ \beta x^2 + bx &= w^2 \end{aligned} \right\}.$$

The usual method does not here serve, and a special artifice is required.

Diophantus assumes $u^2 = m^2 x^2$.

Then $x = a / (m^2 - \alpha)$ and, by substitution in the second equation, we have

$$\beta \left(\frac{a}{m^2 - \alpha} \right)^2 + \frac{ba}{m^2 - \alpha}, \text{ which must be made a square,}$$

or $a^2 \beta + ba(m^2 - \alpha)$ must be a square.

We have therefore to solve the equation

$$abm^2 + a(a\beta - \alpha b) = y^2,$$

which can or cannot be solved by Diophantus's methods according to the nature of the coefficients. Thus it can be solved if $(a\beta - \alpha b) / a$ is a square, or if a / b is a square. Examples in VI. 12. 14.

(b) Indeterminate equations of a degree higher than the second.

(1) Single equations.

There are two classes, namely those in which expressions in x have to be made squares or cubes respectively. The general form is therefore

$$Ax^n + Bx^{n-1} + \dots + Kx - L = y^2 \text{ or } y^3.$$

In Diophantus n does not exceed 6, and in the second class of cases, where the expression has to be made a cube, n does not generally exceed 3.



THIS PAGE IS LOCKED TO FREE MEMBERS

Purchase full membership to immediately unlock this page

FORGOTTEN BOOKS

FULL

MEMBERSHIP

797,885 Books!

All you can read

for only

\$8.99/month

Continue

*Fair usage policy applies



a square. Where this does not hold (in IV. 18) Diophantus harks back and replaces the equation $x^6 - 16x^3 + x + 64 = y^2$ by another, $x^6 - 128x^3 + x + 4096 = y^2$.

Of expressions which have to be made *cubes*, we have the following cases.

1. $Ax^2 + Bx + C = y^3$.

There are only two cases of this. First, in VI. 1, $x^2 - 4x + 4$ has to be made a cube, being already a square. Diophantus naturally makes $x - 2$ a cube.

Secondly, a peculiar case occurs in VI. 17, where a cube has to be found exceeding a square by 2. Diophantus assumes $(x - 1)^3$ for the cube and $(x + 1)^2$ for the square. This gives

$$x^3 - 3x^2 + 3x - 1 = x^2 + 2x + 3,$$

or $x^3 + x = 4x^2 + 4$. We divide out by $x^2 + 1$, and $x = 4$. It seems evident that the assumptions were made with knowledge and intention. That is, Diophantus knew of the solution 27 and 25 and deliberately led up to it. It is unlikely that he was aware of the fact, observed by Fermat, that 27 and 25 are the only integral numbers satisfying the condition.

2. $Ax^3 + Bx^2 + Cx + D = y^3$, where either A or D is a cube number, or both are cube numbers. Where A is a cube (a^3),

we have only to assume $y = ax + \frac{B}{3a^2}$, and where D is a cube

(d^3), $y = \frac{C}{3d^2}x + d$. Where $A = a^3$ and $D = d^3$, we can use

either assumption, or put $y = ax + d$. Apparently Diophantus used the last assumption only in this case, for in IV. 27 he rejects as impossible the equation $8x^3 - x^2 + 8x - 1 = y^3$, because the assumption $y = 2x - 1$ gives a negative value $x = -\frac{2}{11}$, whereas either of the above assumptions gives a rational value.

(2) *Double equations.*

Here one expression has to be made a square and another a cube. The cases are mostly very simple, e.g. (VI. 19)

$$\left. \begin{aligned} 4x + 2 &= y^3 \\ 2x + 1 &= z^2 \end{aligned} \right\};$$

thus $y^3 = 2z^2$, and $z = 2$.

More complicated is the case in VI. 21 :

$$\left. \begin{aligned} 2x^2 + 2x &= y^2 \\ x^3 + 2x^2 + x &= z^3 \end{aligned} \right\}.$$

Diophantus assumes $y = mx$, whence $x = 2 / (m^2 - 2)$, and

$$\left(\frac{2}{m^2 - 2}\right)^3 + 2\left(\frac{2}{m^2 - 2}\right)^2 + \frac{2}{m^2 - 2} = z^3,$$

or

$$\frac{2m^4}{(m^2 - 2)^3} = z^3.$$

We have only to make $2m^4$, or $2m$, a cube.

II. Method of Limits.

As Diophantus often has to find a series of numbers in order of magnitude, and as he does not admit negative solutions, it is often necessary for him to reject a solution found in the usual course because it does not satisfy the necessary conditions; he is then obliged, in many cases, to find solutions lying *within certain limits* in place of those rejected. For example:

1. It is required to find a value of x such that some power of it, x^n , shall lie between two given numbers, say a and b .

Diophantus multiplies both a and b by 2^n , 3^n , and so on, successively, until some n th power is seen which lies between the two products. Suppose that c^n lies between ap^n and bp^n ; then we can put $x = c/p$, for $(c/p)^n$ lies between a and b .

Ex. To find a square between $1\frac{1}{4}$ and 2. Diophantus multiplies by a square 64; this gives 80 and 128, between which lies 100. Therefore $(\frac{10}{8})^2$ or $\frac{25}{16}$ solves the problem (IV. 31 (2)).

To find a sixth power between 8 and 16. The sixth powers of 1, 2, 3, 4 are 1, 64, 729, 4096. Multiply 8 and 16 by 64 and we have 512 and 1024, between which 729 lies; $\frac{729}{64}$ is therefore a solution (VI. 21).

2. Sometimes a value of x has to be found which will give

some function of x a value intermediate between the values of two other functions of x .

Ex. 1. In IV. 25 a value of x is required such that $8/(x^2 + x)$ shall lie between x and $x + 1$.

One part of the condition gives $8 > x^3 + x^2$. Diophantus accordingly assumes $8 = (x + \frac{1}{3})^3 = x^3 + x^2 + \frac{1}{3}x + \frac{1}{27}$, which is $> x^3 + x^2$. Thus $x + \frac{1}{3} = 2$ or $x = \frac{5}{3}$ satisfies one part of the condition. Incidentally it satisfies the other, namely $8/(x^2 + x) < x + 1$. This is a piece of luck, and Diophantus is satisfied with it, saying nothing more.

Ex. 2. We have seen how Diophantus concludes that, if

$$\frac{1}{5}(x^2 - 60) > x > \frac{1}{8}(x^2 - 60),$$

then x is not less than 11 and not greater than 12 (V. 30).

The problem further requires that $x^2 - 60$ shall be a square. Assuming $x^2 - 60 = (x - m)^2$, we find $x = (m^2 + 60)/2m$.

Since $x > 11$ and < 12 , says Diophantus, it follows that

$$24m > m^2 + 60 > 22m;$$

from which he concludes that m lies between 19 and 21. Putting $m = 20$, he finds $x = 11\frac{1}{2}$.

III. Method of approximation to Limits.

Here we have a very distinctive method called by Diophantus *παρισότης* or *παρισότητος ἀγωγή*. The object is to solve such problems as that of finding two or three square numbers the sum of which is a given number, while each of them either approximates to one and the same number, or is subject to limits which may be the same or different.

Two examples will best show the method.

Ex. 1. Divide 13 into two squares each of which > 6 (V. 9).

Take half of 13, i.e. $6\frac{1}{2}$, and find what *small* fraction $1/x^2$ added to it will give a square;

thus $6\frac{1}{2} + \frac{1}{x^2}$, or $26 + \frac{1}{y^2}$, must be a square.



THIS PAGE IS LOCKED TO FREE MEMBERS

Purchase full membership to immediately unlock this page

DELVE INTO FANTASY, MAGIC, MYTHOLOGY & FOLKLORE

Forgotten Books'
Full Membership gives
access to 797,885 ancient
and modern, fiction and
non-fiction books.

Continue

*Fair usage policy applies

therefore $y = 2$, and $1/x^2 = \frac{1}{36}$; and $3\frac{1}{3} + \frac{1}{36} = \frac{121}{36}$, a square.

We have now, says Diophantus, to divide 10 into three squares with sides as near as may be to $\frac{11}{6}$.

$$\text{Now} \quad 10 = 9 + 1 = 3^2 + \left(\frac{3}{5}\right)^2 + \left(\frac{4}{5}\right)^2.$$

Bringing $3, \frac{3}{5}, \frac{4}{5}$ and $\frac{11}{6}$ to a common denominator, we have $\frac{90}{30}, \frac{18}{30}, \frac{24}{30}$ and $\frac{55}{30}$,

$$\text{and} \quad 3 > \frac{55}{30} \text{ by } \frac{35}{30},$$

$$\frac{3}{5} < \frac{55}{30} \text{ by } \frac{37}{30},$$

$$\frac{4}{5} < \frac{55}{30} \text{ by } \frac{31}{30}.$$

If now we took $3 - \frac{35}{30}, \frac{3}{5} + \frac{37}{30}, \frac{4}{5} + \frac{31}{30}$ as the sides of squares, the sum of the squares would be $3\left(\frac{11}{6}\right)^2$ or $\frac{363}{36}$, which is > 10 .

Accordingly we assume as the sides $3 - 35x, \frac{3}{5} + 37x, \frac{4}{5} + 31x$, where x must therefore be not exactly $\frac{1}{30}$ but near it.

$$\text{Solving} \quad (3 - 35x)^2 + \left(\frac{3}{5} + 37x\right)^2 + \left(\frac{4}{5} + 31x\right)^2 = 10,$$

$$\text{or} \quad 10 - 116x + 3555x^2 = 10,$$

$$\text{we find} \quad x = \frac{116}{3555};$$

thus the sides of the required squares are $\frac{1321}{711}, \frac{1285}{711}, \frac{1288}{711}$;

the squares themselves are $\frac{1745041}{505521}, \frac{1651225}{505521}, \frac{1658944}{505521}$.

Other instances of the application of the method will be found in V. 10, 12, 13, 14.

Porisms and propositions in the Theory of Numbers.

I. Three propositions are quoted as occurring in the *Porisms* ('We have it in the *Porisms* that...'); and some other propositions assumed without proof may very likely have come from the same collection. The three propositions from the *Porisms* are to the following effect.

1. If a is a given number and x, y numbers such that $x + a = m^2, y + a = n^2$, then, if $xy + a$ is also a square, m and n differ by unity (V. 3).

[From the first two equations we obtain easily

$$xy + a = m^2n^2 - a(m^2 + n^2 - 1) + a^2,$$

and this is obviously a square if $m^2 + n^2 - 1 = 2mn$, or $m - n = \pm 1$.]

2. If m^2 , $(m + 1)^2$ be consecutive squares and a third number be taken equal to $2\{m^2 + (m + 1)^2\} + 2$, or $4(m^2 + m + 1)$, the three numbers have the property that the product of any two *plus* either the sum of those two or the remaining number gives a square (V. 5).

[In fact, if X , Y , Z denote the numbers respectively,

$$XY + X + Y = (m^2 + m + 1)^2, \quad XY + Z = (m^2 + m + 2)^2,$$

$$YZ + Y + Z = (2m^2 + 3m + 3)^2, \quad YZ + X = (2m^2 + 3m + 2)^2,$$

$$ZX + Z + X = (2m^2 + m + 2)^2, \quad ZX + Y = (2m^2 + m + 1)^2.]$$

3. The difference of any two cubes is also the sum of two cubes, i.e. can be transformed into the sum of two cubes (V. 16).

[Diophantus merely states this without proving it or showing how to make the transformation. The subject of the transformation of sums and differences of cubes was investigated by Vieta, Bachet and Fermat.]

II. Of the many other propositions assumed or implied by Diophantus which are not referred to the *Porisms* we may distinguish two classes.

1. The first class are of two sorts; some are more or less of the nature of identical formulae, e.g. the facts that the expressions $\{\frac{1}{2}(a + b)\}^2 - ab$ and $a^2(a + 1)^2 + a^2 + (a + 1)^2$ are respectively squares, that $a(a^2 - a) + a + (a^2 - a)$ is always a cube, and that 8 times a triangular number *plus* 1 gives a square, i.e. $8 \cdot \frac{1}{2}x(x + 1) + 1 = (2x + 1)^2$. Others are of the same kind as the first two propositions quoted from the *Porisms*, e.g.

(1) If $X = a^2x + 2a$, $Y = (a + 1)^2x + 2(a + 1)$ or, in other words, if $xX + 1 = (ax + 1)^2$ and $xY + 1 = \{(a + 1)x + 1\}^2$, then $XY + 1$ is a square (IV. 20). In fact

$$XY + 1 = \{a(a + 1)x + (2a + 1)\}^2.$$

(2) If $X \pm a = m^2$, $Y \pm a = (m + 1)^2$, and $Z = 2(X + Y) - 1$, then $YZ \pm a$, $ZX \pm a$, $XY \pm a$ are all squares (V. 3, 4).

In fact $YZ \pm a = \{(m+1)(2m+1) \mp 2a\}^2,$
 $ZX \pm a = \{m(2m+1) \mp 2a\}^2,$
 $XY \pm a = \{m(m+1) \mp a\}^2.$

(3) If

$$X = m^2 + 2, \quad Y = (m+1)^2 + 2, \quad Z = 2\{m^2 + (m+1)^2 + 1\} + 2,$$

then the six expressions

$$\begin{array}{lll} YZ - (Y + Z), & ZX - (Z + X), & XY - (X + Y), \\ YZ - X, & ZX - Y, & XY - Z \end{array}$$

are all squares (V. 6).

In fact

$$YZ - (Y + Z) = (2m^2 + 3m + 3)^2, \quad YZ - X = (2m^2 + 3m + 4)^2, \quad \&c.$$

2. The second class is much more important, consisting of propositions in the Theory of Numbers which we find first stated or assumed in the *Arithmetica*. It was in explanation or extension of these that Fermat's most famous notes were written. How far Diophantus possessed scientific proofs of the theorems which he assumes must remain largely a matter of speculation.

(a) *Theorems on the composition of numbers as the sum of two squares.*

(1) Any square number can be resolved into two squares in any number of ways (II. 8).

(2) Any number which is the sum of two squares can be resolved into two other squares in any number of ways (II. 9).

(It is implied throughout that the squares may be fractional as well as integral.)

(3) If there are two whole numbers each of which is the sum of two squares, the product of the numbers can be resolved into the sum of two squares in two ways.

In fact $(a^2 + b^2)(c^2 + d^2) = (ac \pm bd)^2 + (ad \mp bc)^2.$

This proposition is used in III. 19, where the problem is to find four rational right-angled triangles with the same



THIS PAGE IS LOCKED TO FREE MEMBERS

Purchase full membership to immediately unlock this page

FORGOTTEN BOOKS

FULL

MEMBERSHIP

797,885 Books!

All you can read

for only

\$8.99/month

Continue

*Fair usage policy applies



a given number is added to either part, the result will be a square.' The condition is in two parts. There is no doubt as to the first, 'The given number must not be odd' [i.e. no number of the form $4n + 3$ or $4n - 1$ can be the sum of two squares]; the text of the second part is corrupt, but the words actually found in the text make it quite likely that corrections made by Hankel and Tannery give the real meaning of the original, 'nor must the double of the given number *plus* 1 be measured by any prime number which is less by 1 than a multiple of 4'. This is tolerably near the true condition stated by Fermat, 'The given number must not be odd, and the double of it increased by 1, when divided by the greatest square which measures it, must not be divisible by a prime number of the form $4n - 1$.'

(β) *On numbers which are the sum of three squares.*

In V. 11 the number $3a + 1$ has to be divisible into three squares. Diophantus says that a 'must not be 2 or any multiple of 8 increased by 2'. That is, '*a number of the form $24n + 7$ cannot be the sum of three squares*'. As a matter of fact, the factor 3 in the 24 is irrelevant here, and Diophantus might have said that a number of the form $8n + 7$ cannot be the sum of three squares. The latter condition is true, but does not include *all* the numbers which cannot be the sum of three squares. Fermat gives the conditions to which a must be subject, proving that $3a + 1$ cannot be of the form $4^n(24k + 7)$ or $4^n(8k + 7)$, where $k = 0$ or any integer.

(γ) *Composition of numbers as the sum of four squares.*

There are three problems, IV. 29, 30 and V. 14, in which it is required to divide a number into four squares. Diophantus states no necessary condition in this case, as he does when it is a question of dividing a number into *three* or *two* squares. Now *every number is either a square or the sum of two, three or four squares* (a theorem enunciated by Fermat and proved by Lagrange who followed up results obtained by Euler), and this shows that any number can be divided into four squares (admitting fractional as well as integral squares), since any square number can be divided into two other squares, integral

or fractional. It is possible, therefore, that Diophantus was *empirically* aware of the truth of the theorem of Fermat, but we cannot be sure of this.

Conspectus of the *Arithmetica*, with typical solutions.

There seems to be no means of conveying an idea of the extent of the problems solved by Diophantus except by giving a conspectus of the whole of the six Books. Fortunately this can be done by the help of modern notation without occupying too many pages.

It will be best to classify the propositions according to their character rather than to give them in Diophantus's order. It should be premised that $x, y, z \dots$ indicating the first, second and third \dots numbers required do not mean that Diophantus indicates any of them by his unknown (s); he gives his unknown in each case the signification which is most convenient, his object being to express all his required numbers at once in terms of the one unknown (where possible), thereby avoiding the necessity for eliminations. Where I have occasion to specify Diophantus's unknown, I shall as a rule call it ξ , except when a problem includes a subsidiary problem and it is convenient to use different letters for the unknown in the original and subsidiary problems respectively, in order to mark clearly the distinction between them. When in the equations expressions are said to be $= u^2, v^2, w^2, t^2 \dots$ this means simply that they are to be made squares. Given numbers will be indicated by $a, b, c \dots m, n \dots$ and will take the place of the numbers used by Diophantus, which are always specific numbers.

Where the solutions, or particular devices employed, are specially ingenious or interesting, the methods of solution will be shortly indicated. The character of the book will be best appreciated by means of such illustrations.

[The problems marked with an asterisk are probably spurious.]

(i) Equations of the first degree with one unknown.

I. 7. $x - a = m(x - b)$.

I. 8. $x + a = m(x + b)$.

I. 9. $a - x = m(b - x)$.

I. 10. $x + b = m(a - x)$.

I. 11. $x + b = m(x - a)$.

I. 39. $(a + x)b + (b + x)a = 2(a + b)x,$
 or $(a + b)x + (b + x)a = 2(a + x)b,$
 or $(a + b)x + (a + x)b = 2(b + x)a.$ } $(a > b)$

Diophantus states this problem in this form, 'Given two numbers (a, b) , to find a third number (x) such that the numbers

$$(a + x)b, (b + x)a, (a + b)x$$

are in arithmetical progression.'

The result is of course different according to the order of magnitude of the three expressions. If $a > b$ (5 and 3 are the numbers in Diophantus), then $(a + x)b < (b + x)a$; there are consequently three alternatives, since $(a + x)b$ must be either the least or the middle, and $(b + x)a$ either the middle or the greatest of the three products. We may have

$$(a + x)b < (a + b)x < (b + x)a,$$

or $(a + b)x < (a + x)b < (b + x)a,$

or $(a + x)b < (b + x)a < (a + b)x$

and the corresponding equations are as set out above.

(ii) Determinate systems of equations of the first degree.

I. 1. $x + y = a, x - y = b.$

{ I. 2. $x + y = a, x = my,$

{ I. 4. $x - y = a, x = my.$

I. 3. $x + y = a, x = my + b.$

{ I. 5. $x + y = a, \frac{1}{m}x + \frac{1}{n}y = b,$ subject to necessary condition.
 { I. 6. $x + y = a, \frac{1}{m}x - \frac{1}{n}y = b,$ „



THIS PAGE IS LOCKED TO FREE MEMBERS

Purchase full membership to immediately unlock this page

DELVE INTO FANTASY, MAGIC, MYTHOLOGY & FOLKLORE

Forgotten Books'
Full Membership gives
access to 797,885 ancient
and modern, fiction and
non-fiction books.

Continue

*Fair usage policy applies

I. 35. $x = my, y^2 = nx.$

II. 36. $x = my, y^2 = ny.$

I. 37. $x = my, y^2 = n(x + y).$

I. 38. $x = my, y^2 = n(x - y).$

I. 38. Cor. $x = my, x^2 = ny.$

„ $x = my, x^2 = nx.$

„ $x = my, x^2 = n(x + y).$

„ $x = my, x^2 = n(x - y).$

II. 6*. $x - y = a, x^2 - y^2 = x - y + b.$

IV. 36. $yz = m(y + z), zx = n(z + x), xy = p(x + y).$

[Solved by means of Lemma: see under (vi) Indeterminate equations of the first degree.]

(iv) Determinate systems reducible to equations of second degree.

I. 27. $x + y = a, xy = b.$

[Dioph. states the necessary condition, namely that $\frac{1}{4}a^2 - b$ must be a square, with the words *ἔστι δὲ τοῦτο πλασματικόν*, which no doubt means ‘this is of the nature of a formula (easily obtained)’. He puts $x - y = 2\xi$.]

I. 30. $x - y = a, xy = b.$

[Necessary condition (with the same words) $4b + a^2 =$ a square. $x + y$ is put $= 2\xi$.]

I. 28. $x + y = a, x^2 + y^2 = b.$

[Necessary condition $2b - a^2 =$ a square. $x - y = 2\xi$.]

IV. 1. $x^3 + y^3 = a, x + y = b.$

[Dioph. puts $x - y = 2\xi$, whence $x = \frac{1}{2}b + \xi, y = \frac{1}{2}b - \xi$. The numbers a, b are so chosen that $(a - \frac{1}{4}b^3)/3b$ is a square.]

IV. 2. $x^3 - y^3 = a, x - y = b.$

[$x + y = 2\xi$.]

$$\text{IV. 15. } (y+z)x = a, (z+x)y = b, (x+y)z = c.$$

[Dioph. takes the third number z as his unknown ;

thus

$$x + y = c/z.$$

Assume $x = p/z$, $y = q/z$. Then

$$\frac{pq}{z^2} + p = a,$$

$$\frac{pq}{z^2} + q = b.$$

These equations are inconsistent unless $p - q = a - b$. We have therefore to determine p, q by dividing c into two parts such that their difference = $a - b$ (cf. I. 1).

A very interesting use of the 'false hypothesis' (Diophantus first takes two *arbitrary* numbers for p, q such that $p + q = c$, and finds that the values taken have to be corrected).

The final equation being $\frac{pq}{z^2} + p = a$, where p, q are determined in the way described, $z^2 = pq/(a - p)$ or $pq/(b - q)$, and the numbers a, b, c have to be such that either of these expressions gives a square.]

$$\text{IV. 34. } yz + (y+z) = a^2 - 1, \quad zx + (z+x) = b^2 - 1,$$

$$xy + (x+y) = c^2 - 1.$$

[Dioph. states as the necessary condition for a rational solution that each of the three constants to which the three expressions are to be equal must be some square diminished by 1. The true condition is seen in our notation by transforming the equations $yz + (y+z) = \alpha$, $zx + (z+x) = \beta$, $xy + (x+y) = \gamma$ into

$$(y+1)(z+1) = \alpha + 1,$$

$$(z+1)(x+1) = \beta + 1,$$

$$(x+1)(y+1) = \gamma + 1,$$

whence $x + 1 = \sqrt{\left\{ \frac{(\beta + 1)(\gamma + 1)}{\alpha + 1} \right\}}$ &c.;

and it is only necessary that $(\alpha + 1)(\beta + 1)(\gamma + 1)$ should be a square, not that *each* of the expressions $\alpha + 1$, $\beta + 1$, $\gamma + 1$ should be a square.

Dioph. finds in a Lemma (see under (vi) below) a solution $\acute{\epsilon}\nu$ $\acute{\alpha}\rho\acute{\iota}\sigma\tau\omega$ (indeterminately) of $xy + (x + y) = k$, which practically means finding y in terms of x .]

$$\text{IV. 35. } yz - (y + z) = a^2 - 1, \quad zx - (z + x) = b^2 - 1,$$

$$xy - (x + y) = c^2 - 1.$$

[The remarks on the last proposition apply *mutatis mutandis*. The lemma in this case is the indeterminate solution of $xy - (x + y) = k$.]

$$\text{IV. 37. } yz = a(x + y + z), \quad zx = b(x + y + z), \quad xy = c(x + y + z).$$

[Another interesting case of 'false hypothesis'. Dioph. first gives $x + y + z$ an *arbitrary* value, then finds that the result is not rational, and proceeds to solve the new problem of finding a value of $x + y + z$ to take the place of the first value.

If $w = x + y + z$, we have $x = cw/y$, $z = aw/y$, so that $zx = acw^2/y^2 = bw$ by hypothesis; therefore $y^2 = \frac{ac}{b}w$.

For a rational solution this last expression must be a square. Suppose, therefore, that $w = \frac{ac}{b}\xi^2$, and we have

$$x + y + z = \frac{ac}{b}\xi^2, \quad y = \frac{ac}{b}\xi, \quad z = a\xi, \quad x = c\xi.$$

Eliminating x , y , z , we obtain $\xi = (bc + ca + ab)/ac$, and

$$x = (bc + ca + ab)/a, \quad y = (bc + ca + ab)/b,$$

$$z = (bc + ca + ab)/c.]$$

Lemma to V. 8. $yz = a^2$, $zx = b^2$, $xy = c^2$.



THIS PAGE IS LOCKED TO FREE MEMBERS

Purchase full membership to immediately unlock this page

FORGOTTEN BOOKS

FULL

MEMBERSHIP

797,885 Books!

All you can read

for only

\$8.99/month

Continue

*Fair usage policy applies



IV. 33. $x + \frac{1}{z}y = m \left(y - \frac{1}{z}y \right), \quad y + \frac{1}{z}x = n \left(x - \frac{1}{z}x \right).$

[Dioph. assumes $\frac{1}{z}y = 1.$]

(vi) Indeterminate equations of the first degree.

Lemma to IV. 34. $xy + (x + y) = a.$
 „ „ IV. 35. $xy - (x + y) = a.$
 „ „ IV. 36. $xy = m(x + y).$ } [Solutions ἐν ἀορίστῳ.
 y practically found
 in terms of $x.$]

(vii) Indeterminate analysis of the second degree.

- II. 8. $x^2 + y^2 = a^2.$
 [$y^2 = a^2 - x^2$ must be a square = $(mx - a)^2$, say.]
- II. 9. $x^2 + y^2 = a^2 + b^2.$ [Put $x = \xi + a, y = m\xi - b.$]
- II. 10. $x^2 - y^2 = a.$
 [Put $x = y + m$, choosing m such that $m^2 < a.$]
- II. 11. $x + a = u^2, \quad x + b = v^2.$
- II. 12. $a - x = u^2, \quad b - x = v^2.$
- II. 13. $x - a = u^2, \quad x - b = v^2.$

[Dioph. solves II. 11 and 13, (1) by means of the 'double equation' (see p. 469 above), (2) without a double equation by putting $x = \xi^2 \pm a$ and equating $(\xi^2 \pm a) \pm b$ to $(\xi - m)^2$. In II. 12 he puts $x = a - \xi^2.$]

II. 14 = III. 21. $x + y = a, \quad x + z^2 = u^2, \quad y + z^2 = v^2.$

[Diophantus takes z as the unknown, and puts $u^2 = (z + m)^2, v^2 = (z + n)^2$. Therefore $x = 2mz + m^2, y = 2nz + n^2$, and z is found, by substitution in the first equation, to be $\frac{a - (m^2 + n^2)}{2(m + n)}$. In order that the solution

may be rational, m, n must satisfy a certain condition. Dioph. takes them such that $m^2 + n^2 < a$, but it is sufficient, if $m > n$, that $a + mn$ should be $> n^2.$]

II. 15 = III. 20. $x + y = a, \quad z^2 - x = u^2, \quad z^2 - y = v^2.$

[The solution is similar, and a similar remark applies to Diophantus's implied condition.]

$$\text{II. 16. } x = my, a^2 + x = u^2, a^2 + y = v^2.$$

$$\text{II. 19. } x^2 - y^2 = m(y^2 - z^2).$$

$$\text{II. 20. } x^2 + y = u^2, y^2 + x = v^2.$$

[Assume $y = 2mx + m^2$, and one condition is satisfied.]

$$\text{II. 21. } x^2 - y = u^2, y^2 - x = v^2.$$

[Assume $x = \xi + m, y = 2m\xi + m^2$, and one condition is satisfied.]

$$\text{II. 22. } x^2 + (x + y) = u^2, y^2 + (x + y) = v^2.$$

[Put $x + y = 2mx + m^2$.]

$$\text{II. 23. } x^2 - (x + y) = u^2, y^2 - (x + y) = v^2.$$

$$\text{II. 24. } (x + y)^2 + x = u^2, (x + y)^2 + y = v^2.$$

[Assume $x = (m^2 - 1)\xi^2, y = (n^2 - 1)\xi^2, x + y = \xi$.]

$$\text{II. 25. } (x + y)^2 - x = u^2, (x + y)^2 - y = v^2.$$

$$\text{II. 26. } xy + x = u^2, xy + y = v^2, u + v = a.$$

[Put $y = m^2x - 1$.]

$$\text{II. 27. } xy - x = u^2, xy - y = v^2, u + v = a.$$

$$\text{II. 28. } x^2y^2 + x^2 = u^2, x^2y^2 + y^2 = v^2.$$

$$\text{II. 29. } x^2y^2 - x^2 = u^2, x^2y^2 - y^2 = v^2.$$

$$\text{II. 30. } xy + (x + y) = u^2, xy - (x + y) = v^2.$$

[Since $m^2 + n^2 \pm 2mn$ is a square, assume

$$xy = (m^2 + n^2)\xi^2 \text{ and } x + y = 2mn\xi^2;$$

put $x = p\xi, y = q\xi$, where $pq = m^2 + n^2$; then

$$(p + q)\xi = 2mn\xi^2.]$$

$$\text{II. 31. } xy + (x + y) = u^2, xy - (x + y) = v^2, x + y = w^2.$$

[Suppose $w^2 = 2 \cdot 2m \cdot n$, which is a square, and use formula $(2m)^2 + m^2 \pm 2 \cdot 2m \cdot n = \text{a square.}$]

$$\text{II. 32. } y^2 + z = u^2, z^2 + x = v^2, x^2 + y = w^2.$$

[$y = \xi, z = (2a\xi + a^2), x = 2b(2a\xi + a^2) + b^2$.]

$$\text{II. 33. } y^2 - z = u^2, z^2 - x = v^2, x^2 - y = w^2.$$

$$\text{II. 34. } x^2 + (x + y + z) = u^2, \quad y^2 + (x + y + z) = v^2, \\ z^2 + (x + y + z) = w^2.$$

[Since $\{\frac{1}{2}(m - n)\}^2 + mn$ is a square, take any number separable into two factors (m, n) in three ways. This gives three values, say, p, q, r for $\frac{1}{2}(m - n)$. Put $x = p\xi, y = q\xi, z = r\xi$, and $x + y + z = mn\xi^2$; therefore $(p + q + r)\xi = mn\xi^2$, and ξ is found.]

$$\text{II. 35. } x^2 - (x + y + z) = u^2, \quad y^2 - (x + y + z) = v^2, \\ z^2 - (x + y + z) = w^2.$$

[Use the formula $\{\frac{1}{2}(m + n)\}^2 - mn = \text{a square}$ and proceed similarly.]

$$\text{III. 1*} \cdot (x + y + z) - x^2 = u^2, \quad (x + y + z) - y^2 = v^2, \\ (x + y + z) - z^2 = w^2.$$

$$\text{III. 2*} \cdot (x + y + z)^2 + x = u^2, \quad (x + y + z)^2 + y = v^2, \\ (x + y + z)^2 + z = w^2.$$

$$\text{III. 3*} \cdot (x + y + z)^2 - x = u^2, \quad (x + y + z)^2 - y = v^2, \\ (x + y + z)^2 - z = w^2.$$

$$\text{III. 4*} \cdot x - (x + y + z)^2 = u^2, \quad y - (x + y + z)^2 = v^2, \\ z - (x + y + z)^2 = w^2.$$

$$\text{III. 5. } x + y + z = t^2, \quad y + z - x = u^2, \quad z + x - y = v^2, \\ x + y - z = w^2.$$

[The first solution of this problem assumes

$$t^2 = x + y + z = (\xi + 1)^2, \quad w^2 = 1, \quad u^2 = \xi^2,$$

whence x, y, z are found in terms of ξ , and $z + x - y$ is then made a square.

The alternative solution, however, is much more elegant, and can be generalized thus.

We have to find x, y, z so that

$$\left. \begin{aligned} -x + y + z &= \text{a square} \\ x - y + z &= \text{a square} \\ x + y - z &= \text{a square} \\ x + y + z &= \text{a square} \end{aligned} \right\} .$$

Equate the first three expressions to a^2, b^2, c^2 , being squares such that their sum is also a square $= k^2$, say.



THIS PAGE IS LOCKED TO FREE MEMBERS

Purchase full membership to immediately unlock this page

DELVE INTO FANTASY, MAGIC, MYTHOLOGY & FOLKLORE

Forgotten Books'
Full Membership gives
access to 797,885 ancient
and modern, fiction and
non-fiction books.

Continue

*Fair usage policy applies

III. 14. $yz + x^2 = u^2, zx + y^2 = v^2, xy + z^2 = w^2.$

III. 15. $yz + (y + z) = u^2, zx + (z + x) = v^2, xy + (x + y) = w^2.$

[*Lemma.* If $a, a + 1$ be two consecutive numbers, $a^2(u + 1)^2 + a^2 + (a + 1)^2$ is a square. Let

$$y = m^2, z = (m + 1)^2.$$

Therefore $(m^2 + 2m + 2)x + (m + 1)^2$
and $(m^2 + 1)x + m^2$ }

have to be made squares. This is solved as a double-equation; in Diophantus's problem $m = 2$.

Second solution. Let x be the first number, m the second; then $(m + 1)x + m$ is a square $= n^2$, say; therefore $x = (n^2 - m) / (m + 1)$, while $y = m$. We have then

and $(m + 1)z + m = \text{a square}$
 $\left(\frac{n^2 + 1}{m + 1} \right)z + \frac{n^2 - m}{m + 1} = \text{a square}$ }

Diophantus has $m = 3, n = 5$, so that the expressions to be made squares are with him

$$\left. \begin{aligned} 4z + 3 \\ 6\frac{1}{2}z + 5\frac{1}{2} \end{aligned} \right\}.$$

This is not possible because, of the corresponding coefficients, neither pair are in the ratio of squares. In order to substitute, for $6\frac{1}{2}, 4$, coefficients which are in the ratio of a square to a square he then finds two numbers, say, p, q to replace $5\frac{1}{2}, 3$ such that $pq + p + q = \text{a square}$, and $(p + 1) / (q + 1) = \text{a square}$. He assumes ξ and $4\xi + 3$, which satisfies the second condition, and then solves for ξ , which must satisfy

$$4\xi^2 + 8\xi + 3 = \text{a square} = (2\xi - 3)^2, \text{ say,}$$

which gives $\xi = \frac{3}{10}, 4\xi + 3 = 4\frac{1}{5}.$

He then solves, for z , the third number, the double-equation

$$\left. \begin{aligned} 5\frac{1}{5}z + 4\frac{1}{5} = \text{square} \\ \frac{1}{10}z + \frac{3}{10} = \text{square} \end{aligned} \right\},$$

after multiplying by 25 and 100 respectively, making expressions

$$\left. \begin{array}{l} 130x + 105 \\ 130x + 30 \end{array} \right\} .$$

In the above equations we should only have to make $n^2 + 1$ a square, and then multiply the first by $n^2 + 1$ and the second by $(m + 1)^2$.

Diophantus, with his notation, was hardly in a position to solve, as we should, by writing

$$(y + 1)(z + 1) = a^2 + 1,$$

$$(z + 1)(x + 1) = b^2 + 1,$$

$$(x + 1)(y + 1) = c^2 + 1,$$

which gives $x + 1 = \sqrt{\{(b^2 + 1)(c^2 + 1)/(a^2 + 1)\}}$, &c.]

$$\text{III. 16. } yz - (y + z) = u^2, \quad zx - (z + x) = v^2, \quad xy - (x + y) = w^2.$$

[The method is the same *mutatis mutandis* as the second of the above solutions.]

$$\left\{ \begin{array}{l} \text{III. 17. } xy + (x + y) = u^2, \quad xy + x = v^2, \quad xy + y = w^2. \\ \text{III. 18. } xy - (x + y) = u^2, \quad xy - x = v^2, \quad xy - y = w^2. \end{array} \right.$$

$$\text{III. 19. } (x_1 + x_2 + x_3 + x_4)^2 \pm x_1 = \begin{cases} t^2 \\ t'^2 \end{cases}$$

$$(x_1 + x_2 + x_3 + x_4)^2 \pm x_2 = \begin{cases} u^2 \\ u'^2 \end{cases}$$

$$(x_1 + x_2 + x_3 + x_4)^2 \pm x_3 = \begin{cases} v^2 \\ v'^2 \end{cases}$$

$$(x_1 + x_2 + x_3 + x_4)^2 \pm x_4 = \begin{cases} w^2 \\ w'^2 \end{cases}$$

[Diophantus finds, in the way we have seen (p. 482), four different rational right-angled triangles with the same hypotenuse, namely (65, 52, 39), (65, 60, 25), (65, 56, 33), (65, 63, 16), or, what is the same thing, a square which is divisible into two squares in four different ways; this will solve the problem, since, if h, p, b be the three sides of a right-angled triangle, $h^2 \pm 2pb$ are both squares.

Put therefore $x_1 + x_2 + x_3 + x_4 = 65\xi$.

and $x_1 = 2 \cdot 39 \cdot 52\xi^2$, $x_2 = 2 \cdot 25 \cdot 60\xi^2$, $x_3 = 2 \cdot 33 \cdot 56\xi^2$,

$$x_4 = 2 \cdot 16 \cdot 63\xi^2;$$

this gives $12768\xi^2 = 65\xi$, and $\xi = \frac{65}{12768}$.]

{ IV. 4. $x^2 + y = u^2$, $x + y = u$.

{ IV. 5. $x^2 + y = u$, $x + y = u^2$.

IV. 13. $x + 1 = t^2$, $y + 1 = u^2$, $x + y + 1 = v^2$, $y - x + 1 = w^2$.

[Put $x = (m\xi + 1)^2 - 1 = m^2\xi^2 + 2m\xi$; the second and third conditions require us to find two squares with x as difference. The difference $m^2\xi^2 + 2m\xi$ is separated into the factors $m^2\xi + 2m$, ξ ; the square of half the difference $= \{\frac{1}{2}(m^2 - 1)\xi + m\}^2$. Put this equal to $y + 1$, so that $y = \frac{1}{4}(m^2 - 1)^2\xi^2 + m(m^2 - 1)\xi + m^2 - 1$, and the first three conditions are satisfied. The fourth gives $\frac{1}{4}(m^4 - 6m^2 + 1)\xi^2 + (m^3 - 3m)\xi + m^2 =$ a square, which we can equate to $(n\xi - m)^2$.]

IV. 14. $x^2 + y^2 + z^2 = (x^2 - y^2) + (y^2 - z^2) + (x^2 - z^2)$. ($x > y > z$.)

IV. 16. $x + y + z = t^2$, $x^2 + y = u^2$, $y^2 + z = v^2$, $z^2 + x = w^2$.

[Put $4m\xi$ for y , and by means of the factors $2m\xi$, 2 we can satisfy the second condition by making x equal to half the difference, or $m\xi - 1$. The third condition is satisfied by subtracting $(4m\xi)^2$ from some square, say $(4m\xi + 1)^2$; therefore $z = 8m\xi + 1$. By the first condition $13m\xi$ must be a square. Let it be $169\eta^2$; the numbers are therefore $13\eta^2 - 1$, $52\eta^2$, $104\eta^2 + 1$, and the last condition gives $10816\eta^4 + 221\eta^2 =$ a square, i.e. $10816\eta^2 + 221 =$ a square $= (104\eta + 1)^2$, say. This gives the value of η , and solves the problem.]

IV. 17. $x + y + z = t^2$, $x^2 - y = u^2$, $y^2 - z = v^2$, $z^2 - x = w^2$.

IV. 19. $yz + 1 = u^2$, $zx + 1 = v^2$, $xy + 1 = w^2$.

[We are asked to solve this indeterminately ($\epsilon\nu\tau\omega$ $\acute{\alpha}\omicron\rho\acute{\iota}\sigma\tau\omega$). Put for yz some square minus 1, say $m^2\xi^2 + 2m\xi$; one condition is now satisfied. Put $z = \xi$, so that $y = m^2\xi + 2m$.



THIS PAGE IS LOCKED TO FREE MEMBERS

Purchase full membership to immediately unlock this page

FORGOTTEN BOOKS

FULL

MEMBERSHIP

797,885 Books!

All you can read

for only

\$8.99/month

Continue

*Fair usage policy applies



IV. 29. $x^2 + y^2 + z^2 + w^2 + x + y + z + w = a.$

[Since $x^2 + x + \frac{1}{4}$ is a square,

$$(x^2 + x) + (y^2 + y) + (z^2 + z) + (w^2 + w) + 1$$

is the sum of four squares, and we only have to separate $a + 1$ into four squares.]

IV. 30. $x^2 + y^2 + z^2 + w^2 - (x + y + z + w) = a.$

IV. 31. $x + y = 1, (x + a)(y + b) = u^2.$

IV. 32. $x + y + z = a, xy + z = u^2, xy - z = v^2.$

IV. 39. $x - y = m(y - z), y + z = u^2, z + x = v^2, x + y = w^2.$

IV. 40. $x^2 - y^2 = m(y - z), y + z = u^2, z + x = v^2, x + y = w^2.$

V. 1. $xz = y^2, x - a = u^2, y - a = v^2, z - a = w^2.$

V. 2. $xz = y^2, x + a = u^2, y + a = v^2, z + a = w^2.$

V. 3. $x + a = r^2, y + a = s^2, z + a = t^2,$
 $yz + a = u^2, zx + a = v^2, xy + a = w^2.$

V. 4. $x - a = r^2, y - a = s^2, z - a = t^2,$
 $yz - a = u^2, zx - a = v^2, xy - a = w^2.$

[Solved by means of the *Porisms* that, if a be the given number, the numbers $m^2 - a, (m + 1)^2 - a$ satisfy the conditions of V. 3, and the numbers $m^2 + a, (m + 1)^2 + a$ the conditions of V. 4 (see p. 479 above). The third number is taken to be $2\{m^2 \mp a + (m + 1)^2 \mp a\} - 1$, and the three numbers automatically satisfy two more conditions (see p. 480 above). It only remains to make

$$2\{m^2 \mp a + (m + 1)^2 \mp a\} - 1 \pm a \text{ a square,}$$

or $4m^2 + 4m \mp 3a + 1 = \text{a square,}$

which is easily solved.

With Diophantus $\xi + 3$ takes the place of m in V. 3 and ξ takes its place in V. 4, while a is 5 in V. 3 and 6 in V. 4.]

V. 5. $y^2 z^2 + x^2 = r^2, z^2 x^2 + y^2 = s^2, x^2 y^2 + z^2 = t^2, \quad \S$

$$y^2 z^2 + y^2 + z^2 = u^2, z^2 x^2 + z^2 + x^2 = v^2, x^2 y^2 + x^2 + y^2 = w^2$$

[Solved by means of the Porism numbered 2 on p. 480.

$$\begin{aligned} \text{V. 6. } x-2 &= r^2, \quad y-2 = s^2, \quad z-2 = t^2, \\ yz - y - z &= u^2, \quad zx - z - x = v^2, \quad xy - x - y = w^2, \\ yz - x &= u'^2, \quad zx - y = v'^2, \quad xy - z = w'^2. \end{aligned}$$

[Solved by means of the proposition numbered (3) on p. 481.]

Lemma 1 to V. 7. $xy + x^2 + y^2 = u^2$.

$$\begin{aligned} \text{V. 7. } x^2 \pm (x + y + z) &= \begin{cases} u^2 \\ u'^2 \end{cases}, \quad y^2 \pm (x + y + z) = \begin{cases} v^2 \\ v'^2 \end{cases}, \\ z^2 \pm (x + y + z) &= \begin{cases} w^2 \\ w'^2 \end{cases}. \end{aligned}$$

[Solved by means of the subsidiary problem (Lemma 2) of finding three rational right-angled triangles with equal area. If m, n satisfy the condition in Lemma 1, i.e. if $mn + m^2 + n^2 = p^2$, the triangles are 'formed' from the pairs of numbers $(p, m), (p, n), (p, m + n)$ respectively. Diophantus assumes this, but it is easy to prove. In his case $m = 3, n = 5$, so that $p = 7$. Now, in a right-angled triangle, (hypotenuse)² \pm four times area is a square. We equate, therefore, $x + y + z$ to four times the common area multiplied by ξ^2 , and the several numbers x, y, z to the three hypotenuses multiplied by ξ , and equate the two values. In Diophantus's case the triangles are $(40, 42, 58), (24, 70, 74)$ and $(15, 112, 113)$, and $245\xi = 3360\xi^2$.]

$$\begin{aligned} \text{V. 8. } yz \pm (x + y + z) &= \begin{cases} u^2 \\ u'^2 \end{cases}, \quad zx \pm (x + y + z) = \begin{cases} v^2 \\ v'^2 \end{cases}, \\ xy \pm (x + y + z) &= \begin{cases} w^2 \\ w'^2 \end{cases}. \end{aligned}$$

[Solved by means of the same three rational right-angled triangles found in the Lemma to V. 7, together with the Lemma that we can solve the equations $yz = a^2, zx = b^2, xy = c^2$.]

$$\begin{cases} \text{V. 9. (Cf. II. 11). } x + y = 1, \quad x + a = u^2, \quad y + a = v^2. \\ \text{V. 11. } x + y + z = 1, \quad x + a = u^2, \quad y + a = v^2, \quad z + a = w^2. \end{cases}$$

[These are the problems of *παρισότητος ἀγωγή*

described above (pp. 477-9). The problem is 'to divide unity into two (or three) parts such that, if one and the same given number be added to each part, the results are all squares'.]

$$\left\{ \begin{array}{l} \text{V. 10. } x + y = 1, \quad x + a = u^2, \quad y + b = v^2. \\ \text{V. 12. } x + y + z = 1, \quad x + a = u^2, \quad y + b = v^2, \quad z + c = w^2. \end{array} \right.$$

[These problems are like the preceding except that *different* given numbers are added. The second of the two problems is not worked out, but the first is worth reproducing. We must take the particular figures used by Diophantus, namely $a = 2$, $b = 6$. We have then to divide 9 into two squares such that one of them lies between 2 and 3. Take two squares lying between 2 and 3, say $\frac{289}{144}$, $\frac{361}{144}$. We have then to find a square ξ^2 lying between them; if we can do this, we can make $9 - \xi^2$ a square, and so solve the problem.

Put $9 - \xi^2 = (3 - m\xi)^2$, say, so that $\xi = 6m/(m^2 + 1)$; and m has to be determined so that ξ lies between $\frac{17}{12}$ and $\frac{19}{12}$.

$$\text{Therefore} \quad \frac{17}{12} < \frac{6m}{m^2 + 1} < \frac{19}{12}.$$

Diophantus, as we have seen, finds *a fortiori* integral limits for m by solving these inequalities, making m not greater than $\frac{67}{17}$ and not less than $\frac{66}{19}$ (see pp. 463-5 above). He then takes $m = 3\frac{1}{2}$ and puts $9 - \xi^2 = (3 - 3\frac{1}{2}\xi)^2$, which gives $\xi = \frac{84}{53}$.]

$$\left\{ \begin{array}{l} \text{V. 13. } x + y + z = a, \quad y + z = u^2, \quad z + x = v^2, \quad x + y = w^2. \\ \text{V. 14. } x + y + z + w = a, \quad x + y + z = s^2, \quad y + z + w = t^2, \\ \qquad \qquad \qquad z + w + x = u^2, \quad w + x + y = v^2. \end{array} \right.$$

[The method is the same.]

$$\left\{ \begin{array}{l} \text{V. 21. } x^2y^2z^2 + x^2 = u^2, \quad x^2y^2z^2 + y^2 = v^2, \quad x^2y^2z^2 + z^2 = w^2. \\ \text{V. 22. } x^2y^2z^2 - x^2 = u^2, \quad x^2y^2z^2 - y^2 = v^2, \quad x^2y^2z^2 - z^2 = w^2. \\ \text{V. 23. } x^2 - x^2y^2z^2 = u^2, \quad y^2 - x^2y^2z^2 = v^2, \quad z^2 - x^2y^2z^2 = w^2. \end{array} \right.$$

[Solved by means of right-angled triangles in rational numbers.]



THIS PAGE IS LOCKED TO FREE MEMBERS

Purchase full membership to immediately unlock this page

DELVE INTO FANTASY, MAGIC, MYTHOLOGY & FOLKLORE

Forgotten Books'
Full Membership gives
access to 797,885 ancient
and modern, fiction and
non-fiction books.

Continue

*Fair usage policy applies

Let the first part = $5z$; therefore $\frac{1}{8}$ (second part) = $11\frac{1}{2} - z$, or second part = $92 - 8z$.

Therefore $5z + 92 - 8z = 72\frac{1}{4}$, and $z = \frac{79}{12}$;

therefore the number of five-drachma measures is $\frac{79}{12}$ and the number of eight-drachma measures $\frac{59}{12}$.]

Lemma 2 to VI. 12. $ax^2 + b = u^2$ (where $a + b = c^2$). } (see p. 467
 Lemma to VI. 15. $ax^2 - b = u^2$ (where $ad^2 - b = c^2$). } above.)

$$\left\{ \begin{array}{l} \text{[III. 15]. } xy + x + y = u^2, \quad x + 1 = \frac{v^2}{w^2} (y + 1). \\ \text{[III. 16]. } xy - (x + y) = u^2, \quad x - 1 = \frac{v^2}{w^2} (y - 1). \end{array} \right.$$

$$\text{[IV. 32]. } x + 1 = \frac{u^2}{v^2} (x - 1).$$

$$\text{[V. 21]. } x^2 + 1 = u^2, \quad y^2 + 1 = v^2, \quad z^2 + 1 = w^2.$$

(viii) Indeterminate analysis of the third degree.

$$\text{IV. 3. } x^2y = u, \quad xy = u^3.$$

$$\text{IV. 6. } x^3 + y^2 = u^3, \quad z^2 + y^2 = v^2.$$

$$\text{IV. 7. } x^3 + y^2 = u^2, \quad z^2 + y^2 = v^3.$$

$$\text{IV. 8. } x + y^3 = u^3, \quad x + y = u.$$

$$\text{IV. 9. } x + y^3 = u, \quad x + y = u^3.$$

$$\text{IV. 10. } x^3 + y^3 = x + y.$$

$$\text{IV. 11. } x^3 - y^3 = x - y.$$

$$\text{IV. 12. } x^3 + y = y^3 + x.$$

(really reducible to the second degree.)

the same problem.

{We may give as examples the solutions of IV. 7, IV. 8, IV. 11.

IV. 7. Since $z^2 + y^2 =$ a cube, suppose $z^2 + y^2 = x^3$. To make $x^3 + y^2$ a square, put $x^3 = a^2 + b^2$, $y^2 = 2ab$, which also satisfies $x^3 - y^2 = z^2$. We have then to make $2ab$ a square. Let $a = \xi$, $b = 2\xi$; therefore $a^2 + b^2 = 5\xi^2$, $2ab = 4\xi^2$, $y = 2\xi$, $z = \xi$, and we have only to make $5\xi^2$ a cube. $\xi = 5$, and $x^3 = 125$, $y^2 = 100$, $z^2 = 25$.

IV. 8. Suppose $x = \xi$, $y^3 = m^3 \xi^3$; therefore $u = (m + 1) \xi$ must be the side of the cube $m^3 \xi^3 + \xi$, and

$$m^3 \xi^2 + 1 = (m^3 + 3m^2 + 3m + 1) \xi^2.$$

To solve this, we must have $3m^2 + 3m + 1$ (the difference between consecutive cubes) a square. Put

$$3m^2 + 3m + 1 = (1 - nm)^2, \text{ and } m = (3 + 2n) / (n^2 - 3).$$

IV. 11. Assume $x = (m + 1) \xi$, $y = m \xi$, and we have to make $(3m^3 + 3m^2 + 1) \xi^2$ equal to 1, i.e. we have only to make $3m^2 + 3m + 1$ a square.]

IV. 18. $x^3 + y = u^3$, $y^2 + x = v^2$.

IV. 24. $x + y = a$, $xy = u^3 - u$.

[$y = a - x$; therefore $ax - x^2$ has to be made a cube minus its side, say $(mx - 1)^3 - (mx - 1)$.

Therefore $ax - x^2 = m^3 x^3 - 3m^2 x^2 + 2mx$.

To reduce this to a simple equation, we have only to put $m = \frac{1}{2}a$.]

IV. 25. $x + y + z = a$, $xyz = \{(x - y) + (x - z) + (y - z)\}^3$.

$$(x > y > z)$$

[The cube = $8(x - z)^3$. Let $x = (m + 1) \xi$, $z = m \xi$, so that $y = 8\xi / (m^2 + m)$, and we have only to contrive that $8 / (m^2 + m)$ lies between m and $m + 1$. Dioph. takes the first limit $8 > m^3 + m^2$, and puts

$$8 = (m + \frac{1}{3})^3 \text{ or } m^3 + m^2 + \frac{1}{3}m + \frac{1}{27},$$

whence $m = \frac{5}{3}$; therefore $x = \frac{8}{3}\xi$, $y = \frac{9}{5}\xi$, $z = \frac{5}{3}\xi$. Or, multiplying by 15, we have $x = 40\xi$, $y = 27\xi$, $z = 25\xi$. The first equation then gives ξ .]

IV. 26. $xy + x = u^3$, $xy + y = v^3$.

IV. 27. $xy - x = u^3$, $xy - y = v^3$.

IV. 28. $xy + (x + y) = u^3$, $xy - (x + y) = v^3$.

[$x + y = \frac{1}{2}(u^3 - v^3)$, $xy = \frac{1}{2}(u^3 + v^3)$; therefore

$$(x - y)^2 = \frac{1}{4}(u^3 - v^3)^2 - 2(u^3 + v^3),$$

which latter expression has to be made a square.

Diophantus assumes $u = \xi + 1$, $v = \xi - 1$, whence

$$\frac{1}{4}(6\xi^2 + 2)^2 - 2(2\xi^3 + 6\xi)$$

must be a square, or

$$9\xi^4 - 4\xi^3 + 6\xi^2 - 12\xi + 1 = \text{a square} = (3\xi^2 - 6\xi + 1)^2, \text{ say;}$$

therefore $32\xi^3 = 36\xi^2$, and $\xi = \frac{9}{8}$. Thus u, v are found, and then x, y .

The second (alternative) solution uses the formula that $\xi(\xi^2 - \xi) + (\xi^2 - \xi) + \xi = \text{a cube}$. Put $x = \xi$, $y = \xi^2 - \xi$, and one condition is satisfied. We then only have to make $\xi(\xi^2 - \xi) - \xi - (\xi^2 - \xi)$ or $\xi^3 - 2\xi^2$ a cube (less than ξ^3), i.e. $\xi^3 - 2\xi^2 = (\frac{1}{2}\xi)^3$, say.]

IV. 38. $(x + y + z)x = \frac{1}{2}u(u + 1)$, $(x + y + z)y = v^2$,

$$(x + y + z)z = w^3, [x + y + z = t^2].$$

[Suppose $x + y + z = \xi^2$; then

$$x = \frac{u(u + 1)}{2\xi^2}, \quad y = \frac{v^2}{\xi^2}, \quad z = \frac{w^3}{\xi^2};$$

therefore $\xi^4 = \frac{1}{2}u(u + 1) + v^2 + w^3$.

Diophantus puts 8 for w^3 , but we may take any cube, as m^3 ; and he assumes $v^2 = (\xi^2 - 1)^2$, for which we might substitute $(\xi^2 - n^2)^2$. We then have the triangular number $\frac{1}{2}u(u + 1) = 2n^2\xi^2 - n^4 - m^3$. Since 8 times a triangular number *plus* 1 gives a square,

$$16n^2\xi^2 - 8n^4 - 8m^3 + 1 = \text{a square} = (4n\xi - k)^2, \text{ say,}$$

and the problem is solved.]

V. 15. $(x + y + z)^3 + x = u^3$, $(x + y + z)^3 + y = v^3$,

$$(x + y + z)^3 + z = w^3.$$

[Let $x + y + z = \xi$, $u^3 = m^3\xi^3$, $v^3 = n^3\xi^3$, $w^3 = p^3\xi^3$;

therefore $\xi = \{(m^3 - 1) + (n^3 - 1) + (p^3 - 1)\}\xi^3$;

and we have to find three cubes m^3, n^3, p^3 such that $m^3 + n^3 + p^3 - 3 = \text{a square}$. Diophantus assumes as the sides of the cubes $(k + 1), (2 - k), 2$; this gives



THIS PAGE IS LOCKED TO FREE MEMBERS

Purchase full membership to immediately unlock this page

FORGOTTEN BOOKS

FULL

MEMBERSHIP

797,885 Books!

All you can read

for only

\$8.99/month

Continue

*Fair usage policy applies



(ix) Indeterminate analysis of the fourth degree.

V. 29. $x^4 + y^4 + z^4 = u^2$.

['Why', says Fermat, 'did not Diophantus seek *two* fourth powers such that their sum is a square. This problem is, in fact, impossible, as by my method I am able to prove with all rigour.' No doubt Diophantus knew this truth empirically. Let $x^2 = \xi^2$, $y^2 = p^2$, $z^2 = q^2$. Therefore $\xi^4 + p^4 + q^4 =$ a square $= (\xi^2 - r)^2$, say; therefore $\xi^2 = (r^2 - p^4 - q^4) / 2r$, and we have to make this expression a square.

Diophantus puts $r = p^2 + 4$, $q^2 = 4$, so that the expression reduces to $8p^2 / (2p^2 + 8)$ or $4p^2 / (p^2 + 4)$. To make this a square, let $p^2 + 4 = (p + 1)^2$, say; therefore $p = 1\frac{1}{2}$, and $p^2 = 2\frac{1}{4}$, $q^2 = 4$, $r = 6\frac{1}{4}$; or (multiplying by 4) $p^2 = 9$, $q^2 = 16$, $r = 25$, which solves the problem.]

[V. 18]. $x^2 + y^2 + z^2 - 3 = u^4$.

(See above under V. 18.)

(x) Problems of constructing right-angled triangles with sides in rational numbers and satisfying various other conditions.

[I shall in all cases call the hypotenuse z , and the other two sides x, y , so that the condition $x^2 + y^2 = z^2$ applies in all cases, in addition to the other conditions specified.]

[Lemma to V. 7]. $xy = x_1y_1 = x_2y_2$.

VI. 1. $z - x = u^3, z - y = v^3$.

[Form a right-angled triangle from ξ, m , so that $z = \xi^2 + m^2$, $x = 2m\xi$, $y = \xi^2 - m^2$; thus $z - y = 2m^2$, and, as this must be a cube, we put $m = 2$; therefore $z - x = \xi^2 - 4\xi + 4$ must be a cube, or $\xi - 2 =$ a cube, say n^3 , and $\xi = n^3 + 2$.]

VI. 2. $z + x = u^3, z + y = v^3$.

VI. 3. $\frac{1}{2}xy + a = u^2$.

[Suppose the required triangle to be $h\xi, p\xi, b\xi$; therefore $\frac{1}{2}pb\xi^2 + a = \text{a square} = n^2\xi^2$, say, and the ratio of a to $n^2 - \frac{1}{2}pb$ must be the ratio of a square to a square. To find n, p, b so as to satisfy this condition, form a right-angled triangle from $m, \frac{1}{m}$,

i.e. $\left(m^2 + \frac{1}{m^2}, 2, m^2 - \frac{1}{m^2}\right)$;

therefore $\frac{1}{2}pb = m^2 - \frac{1}{m^2}$. Assume $n^2 = \left(m + \frac{2a}{m}\right)^2$;

therefore $n^2 - \frac{1}{2}pb = 4a + \frac{4a^2 + 1}{m^2}$; and $\left(4a + \frac{4a^2 + 1}{m^2}\right) / a$,

or $4a^2 + \frac{a(4a^2 + 1)}{m^2}$, has to be made a square. Put

$4a^2m^2 + a(4a^2 + 1) = (2am + k)^2$, and we have a solution.

Diophantus has $a = 5$, leading to $100m^2 + 505 = \text{a square} = (10m + 5)^2$, say, which gives $m = \frac{24}{5}$ and $n = \frac{413}{50}$.

h, p, b are thus determined in such a way that $\frac{1}{2}pb\xi^2 + a = n^2\xi^2$ gives a rational solution.]

VI. 4. $\frac{1}{2}xy - a = u^2$.

VI. 5. $a - \frac{1}{2}xy = u^2$.

VI. 6. $\frac{1}{2}xy + x = a$.

[Assume the triangle to be $h\xi, p\xi, b\xi$, so that $\frac{1}{2}pb\xi^2 + p\xi = a$, and for a rational solution of this equation we must have $(\frac{1}{2}p)^2 + a(\frac{1}{2}pb)$ a square. Diophantus assumes $p = 1, b = m$, whence $\frac{1}{2}am + \frac{1}{4}$ or $2am + 1 = \text{a square}$.

But, since the triangle is rational, $m^2 + 1 = \text{a square}$.

That is, we have a double equation. Difference $= m^2 - 2am = m(m - 2a)$. Put

$2am + 1 = \left\{\frac{1}{2}(m - \overline{m - 2a})\right\}^2 = a^2$, and $m = (a^2 - 1) / 2a$.

The sides of the auxiliary triangle are thus determined in such a way that the original equation in ξ is solved rationally.]

VI. 7. $\frac{1}{2}xy - x = a$.

$$\begin{cases} \text{VI. 8. } \frac{1}{2}xy + (x + y) = a. \\ \text{VI. 9. } \frac{1}{2}xy - (x + y) = a. \end{cases}$$

[With the same assumptions we have in these cases to make $\{\frac{1}{2}(p + b)\}^2 + a(\frac{1}{2}pb)$ a square. Diophantus assumes as before 1, m for the values of p , b , and obtains the double equation

$$\left. \begin{aligned} \frac{1}{4}(m + 1)^2 + \frac{1}{2}am &= \text{square} \\ m^2 + 1 &= \text{square} \end{aligned} \right\},$$

or

$$\left. \begin{aligned} m^2 + (2a + 2)m + 1 &= \text{square} \\ m^2 + 1 &= \text{square} \end{aligned} \right\},$$

solving in the usual way.]

$$\begin{cases} \text{VI. 10. } \frac{1}{2}xy + x + z = a. \\ \text{VI. 11. } \frac{1}{2}xy - (x + z) = a. \end{cases}$$

[In these cases the auxiliary right-angled triangle has to be found such that

$$\{\frac{1}{2}(h + p)\}^2 + a(\frac{1}{2}pb) = \text{a square.}$$

Diophantus assumes it formed from 1, $m + 1$; thus

$$\frac{1}{4}(h + p)^2 = \frac{1}{4}\{m^2 + 2m + 2 + m^2 + 2m\}^2 = (m^2 + 2m + 1)^2,$$

and $a(\frac{1}{2}pb) = a(m + 1)(m^2 + 2m),$

Therefore

$$\begin{aligned} m^4 + (a + 4)m^3 + (3a + 6)m^2 + (2a + 4)m + 1 \\ &= \text{a square} \\ &= \{1 + (a + 2)m - m^2\}^2, \text{ say;} \end{aligned}$$

and m is found.]

Lemma 1 to VI. 12. $x = u^2, x - y = v^2, \frac{1}{2}xy + y = w^2.$

$$\begin{cases} \text{VI. 12. } \frac{1}{2}xy + x = u^2, \frac{1}{2}xy + y = v^2. \\ \text{VI. 13. } \frac{1}{2}xy - x = u^2, \frac{1}{2}xy - y = v^2. \end{cases}$$

[These problems and the two following are interesting, but their solutions run to some length; therefore only one case can here be given. We will take VI. 12 with its Lemma 1.



THIS PAGE IS LOCKED TO FREE MEMBERS

Purchase full membership to immediately unlock this page

DELVE INTO FANTASY, MAGIC, MYTHOLOGY & FOLKLORE

Forgotten Books'
Full Membership gives
access to 797,885 ancient
and modern, fiction and
non-fiction books.

Continue

*Fair usage policy applies

[The auxiliary right-angled triangle in this case must be such that

$$m^2 hp - \frac{1}{2} pb \cdot p(h - p) \text{ is a square.}$$

If, says Diophantus (VI. 14), we form a triangle from the numbers X_1, X_2 and suppose that $p = 2 X_1 X_2$, and if we then divide out by $(X_1 - X_2)^2$, which is equal to $h - p$, we must find a square $k^2 [= m^2 / (X_1 - X_2)^2]$ such that $k^2 hp - \frac{1}{2} pb \cdot p$ is a square.

The problem, says Diophantus, can be solved if X_1, X_2 are 'similar plane numbers' (numbers such as $ab, \frac{m^2}{n^2} ab$).

This is stated without proof, but it can easily be verified that, if $k^2 = X_1 X_2$, the expression is a square. Dioph. takes 4, 1 as the numbers, so that $k^2 = 4$. The equation for m becomes

$$8 \cdot 17 m^2 - 4 \cdot 15 \cdot 8 \cdot 9 = \text{a square,}$$

or
$$136 m^2 - 4320 = \text{a square.}$$

The solution $m^2 = 36$ (derived from the fact that

$$k^2 = m^2 / (X_1 - X_2)^2, \text{ or } 4 = m^2 / 3^2)$$

satisfies the condition that

$$m^2 hp - \frac{1}{2} pb \cdot p(h - p) \text{ is a square.}]$$

VI. 16. $\xi + \eta = x, \xi / \eta = y / z$.

[To find a rational right-angled triangle such that the number representing the (portion intercepted within the triangle of the) bisector of an acute angle is rational.

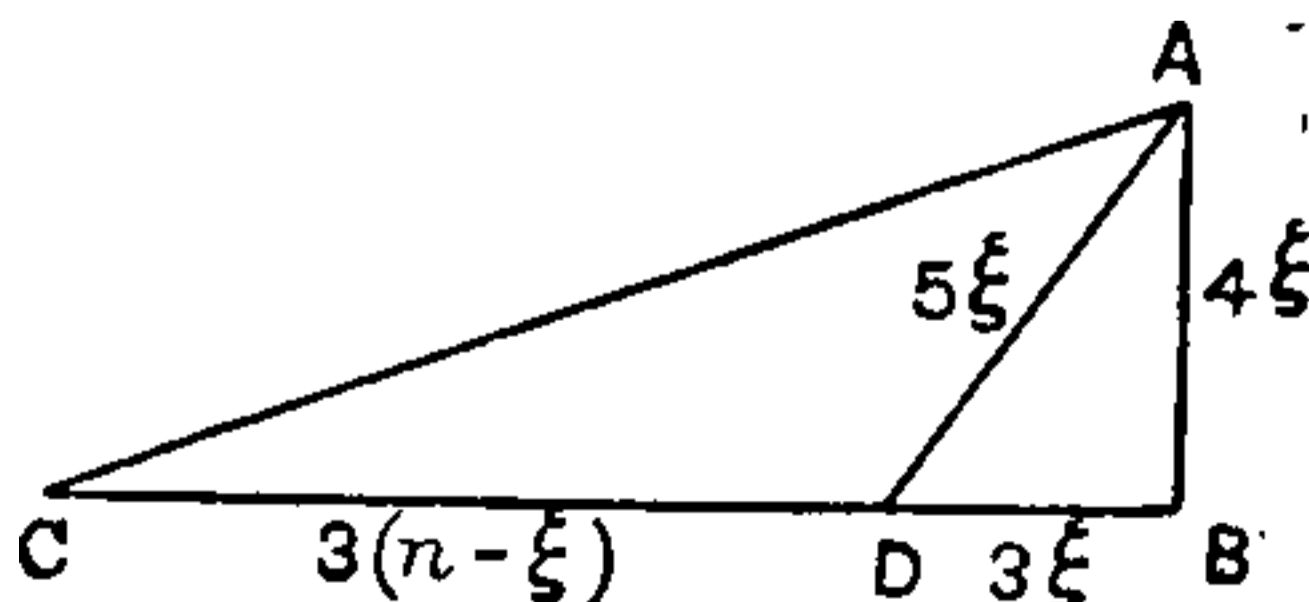

Let the bisector be 5ξ , the segment BD of the base 3ξ , so that the perpendicular is 4ξ .

Let $CB = 3 n$. Then $AC : AB = CD : DB$,

so that $AC = 4(n - \xi)$. Therefore (Eucl. I. 47)

$$16(n^2 - 2n\xi + \xi^2) = 16\xi^2 + 9n^2,$$

so that $\xi = 7n^2/32n = \frac{7}{32}n$. [Dioph. has $n = 1$.]

VI. 17. $\frac{1}{2}xy + z = u^2$, $x + y + z = v^3$.

[Let ξ be the area $\frac{1}{2}xy$, and let $z = k^2 - \xi$. Since $xy = 2\xi$, suppose $x = 2$, $y = \xi$. Therefore $2 + k^2$ must be a cube. As we have seen (p. 475), Diophantus takes $(m-1)^3$ for the cube and $(m+1)^2$ for k^2 , giving $m^3 - 3m^2 + 3m - 1 = m^2 + 2m + 3$, whence $m = 4$. Therefore $k = 5$, and we assume $\frac{1}{2}xy = \xi$, $z = 25 - \xi$, with $x = 2$, $y = \xi$ as before. Then we have to make $(25 - \xi)^2 = 4 + \xi^2$, and $\xi = \frac{621}{50}$.]

VI. 18. $\frac{1}{2}xy + z = u^3$, $x + y + z = v^2$.

VI. 19. $\frac{1}{2}xy + x = u^2$, $x + y + z = v^3$.

[Here a right-angled triangle is formed from one odd number, say $2\xi + 1$, according to the Pythagorean formula $m^2 + \{\frac{1}{2}(m^2 - 1)\}^2 = \{\frac{1}{2}(m^2 + 1)\}^2$, where m is an odd number. The sides are therefore $2\xi + 1$, $2\xi^2 + 2\xi$, $2\xi^2 + 2\xi + 1$. Since the perimeter = a cube,

$$4\xi^2 + 6\xi + 2 = (4\xi + 2)(\xi + 1) = \text{a cube.}$$

Or, if we divide the sides by $\xi + 1$, $4\xi + 2$ has to be made a cube.

$$\text{Again } \frac{1}{2}xy + x = \frac{2\xi^3 + 3\xi^2 + \xi}{(\xi + 1)^2} + \frac{2\xi + 1}{\xi + 1} = \text{a square,}$$

which reduces to $2\xi + 1 = \text{a square}$.

But $4\xi + 2$ is a cube. We therefore put 8 for the cube, and $\xi = 1\frac{1}{2}$.]

VI. 20. $\frac{1}{2}xy + x = u^3$, $x + y + z = v^2$.

VI. 21. $x + y + z = u^2$, $\frac{1}{2}xy + (x + y + z) = v^3$.

[Form a right-angled triangle from ξ , 1, i.e. $(2\xi, \xi^2 - 1, \xi^2 + 1)$. Then $2\xi^2 + 2\xi$ must be a square, and $\xi^5 + 2\xi^2 + \xi$

a cube. Put $2\xi^2 + 2\xi = m^2\xi^2$, so that $\xi = 2/(m^2 - 2)$, and we have to make

$$\frac{8}{(m^2 - 2)^3} + \frac{8}{(m^2 - 2)^2} + \frac{2}{m^2 - 2}, \text{ or } \frac{2m^4}{(m^2 - 2)^3}, \text{ a cube.}$$

Make $2m$ a cube $= n^3$, so that $2m^4 = m^3n^3$, and $m = \frac{1}{2}n^3$; therefore $\xi = \frac{8}{n^6 - 8}$, and ξ must be made greater than 1, in order that $\xi^2 - 1$ may be positive.

Therefore $8 < n^6 < 16$;

this is satisfied by $n^6 = \frac{7 \cdot 2^9}{6^4}$ or $n^3 = \frac{2^7}{8}$, and $m = \frac{2^7}{16}$.]

VI. 22. $x + y + z = u^3$, $\frac{1}{2}xy + (x + y + z) = v^2$.

[(1) First seek a rational right-angled triangle such that its perimeter and its area are given numbers, say p , m .

Let the perpendiculars be $\frac{1}{\xi}$, $2m\xi$; therefore the hypotenuse $= p - \frac{1}{\xi} - 2m\xi$, and (Eucl. I. 47)

$$\frac{1}{\xi^2} + 4m^2\xi^2 + (p^2 + 4m) - \frac{2p}{\xi} - 4mp\xi = \frac{1}{\xi^2} + 4m^2\xi^2,$$

or $p^2 + 4m = 4mp\xi + \frac{2p}{\xi}$,

that is, $(p^2 + 4m)\xi = 4mp\xi^2 + 2p$.

(2) In order that this may have a rational solution,

$$\left\{ \frac{1}{2}(p^2 + 4m) \right\}^2 - 8p^2m \text{ must be a square,}$$

i.e. $4m^2 - 6p^2m + \frac{1}{4}p^4 = \text{a square}$

or $m^2 - \frac{3}{2}p^2m + \frac{1}{16}p^4 = \text{a square}$

Also, by the second condition, $m + p = \text{a square}$

To solve this, we must take for p some number which is both a square and a cube (in order that it may be possible, by multiplying the second equation by some square, to make the constant term equal to the constant



THIS PAGE IS LOCKED TO FREE MEMBERS

Purchase full membership to immediately unlock this page

FORGOTTEN BOOKS

FULL

MEMBERSHIP

797,885 Books!

All you can read

for only

\$8.99/month

Continue

*Fair usage policy applies



Pythagoreans, while Philippus of Opus and Speusippus carried on the tradition. Hypsicles (about 170 B.C.) is twice mentioned by Diophantus as the author of a 'definition' of a polygonal number which, although it does not in terms mention any polygonal number beyond the pentagonal, amounts to saying that the n th a -gon (1 counting as the first) is

$$\frac{1}{2}n \{ 2 + (n - 1) (a - 2) \}.$$

Theon of Smyrna, Nicomachus and Iamblichus all devote some space to polygonal numbers. Nicomachus in particular gives various rules for transforming triangles into squares, squares into pentagons, &c.

1. If we put two consecutive triangles together, we get a square.

In fact

$$\frac{1}{2}(n - 1)n + \frac{1}{2}n(n + 1) = n^2.$$

2. A pentagon is obtained from a square by adding to it a triangle the side of which is 1 less than that of the square; similarly a hexagon from a pentagon by adding a triangle the side of which is 1 less than that of the pentagon, and so on.

In fact

$$\begin{aligned} \frac{1}{2}n \{ 2 + (n - 1) (a - 2) \} + \frac{1}{2}(n - 1)n \\ = \frac{1}{2}n [2 + (n - 1) \{ (a + 1) - 2 \}]. \end{aligned}$$

3. Nicomachus sets out the first triangles, squares, pentagons, hexagons and heptagons in a diagram thus:

Triangles	1	3	6	10	15	21	28	36	45	55,
Squares	1	4	9	16	25	36	49	64	81	100,
Pentagons	1	5	12	22	35	51	70	92	117	145,
Hexagons	1	6	15	28	45	66	91	120	153	190,
Heptagons	1	7	18	34	55	81	112	148	189	235,

and observes that:

Each polygon is equal to the polygon immediately above it in the diagram *plus* the triangle with 1 less in its side, i.e. the triangle in the preceding column.

4. The vertical columns are in arithmetical progression, the common difference being the triangle in the preceding column.

Plutarch, a contemporary of Nicomachus, mentions another method of transforming triangles into squares. *Every triangular number taken eight times and then increased by 1 gives a square.*

$$\text{In fact,} \quad 8 \cdot \frac{1}{2} n(n+1) + 1 = (2n+1)^2.$$

Only a fragment of Diophantus's treatise *On Polygonal Numbers* survives. Its character is entirely different from that of the *Arithmetica*. The method of proof is strictly geometrical, and has the disadvantage, therefore, of being long and involved. He begins with some preliminary propositions of which two may be mentioned. Prop. 3 proves that, if a be the first and l the last term in an arithmetical progression of n terms, and if s is the sum of the terms, $2s = n(l+a)$. Prop. 4 proves that, if $1, 1+b, 1+2b, \dots, 1+(n-1)b$ be an A. P., and s the sum of the terms,

$$2s = n \{ 2 + (n-1)b \}.$$

The main result obtained in the fragment as we have it is a generalization of the formula $8 \cdot \frac{1}{2} n(n+1) + 1 = (2n+1)^2$. Prop. 5 proves the fact stated in Hypsicles's definition and also (the generalization referred to) that

$$8P(a-2) + (a-4)^2 = \text{a square,}$$

where P is any polygonal number with a angles.

It is also proved that, if P be the n th a -gonal number (1 being the first),

$$8P(a-2) + (a-4)^2 = \{ 2 + (2n-1)(a-2) \}^2.$$

Diophantus deduces rules as follows.

1. *To find the number from its side.*

$$P = \frac{\{ 2 + (2n-1)(a-2) \}^2 - (a-4)^2}{8(a-2)}.$$

2. *To find the side from the number.*

$$n = \frac{1}{2} \left(\frac{\sqrt{\{ 8P(a-2) + (a-4)^2 \}} - 2}{a-2} + 1 \right).$$

The last proposition, which breaks off in the middle, is:

Given a number, to find in how many ways it can be polygonal.

The proposition begins in a way which suggests that Diophantus first proved geometrically that, if

$$8P(a-2) + (a-4)^2 = \{2 + (2n-1)(a-2)\}^2,$$

then $2P = n\{2 + (n-1)(a-2)\}.$

Wertheim (in his edition of Diophantus) has suggested a restoration of the complete proof of this proposition, and I have shown (in my edition) how the proof can be made shorter. Wertheim adds an investigation of the main problem, but no doubt opinions will continue to differ as to whether Diophantus actually solved it.



THIS PAGE IS LOCKED TO FREE MEMBERS

Purchase full membership to immediately unlock this page

DELVE INTO FANTASY, MAGIC, MYTHOLOGY & FOLKLORE

Forgotten Books'
Full Membership gives
access to 797,885 ancient
and modern, fiction and
non-fiction books.

Continue

*Fair usage policy applies

survive in Greek. Tannery, as we have seen, conjectured that, in like manner, the first six of the thirteen Books of Diophantus's *Arithmetica* survive because Hypatia wrote commentaries on these Books only and did not reach the others.

The first writer who calls for notice in this chapter is one who was rather more than a commentator in so far as he wrote a couple of treatises to supplement the *Conics* of Apollonius, I mean SERENUS. Serenus came from Antinoeia or Antinoupolis, a city in Egypt founded by Hadrian (A. D. 117-38). His date is uncertain, but he most probably belonged to the fourth century A. D., and came between Pappus and Theon of Alexandria. He tells us himself that he wrote a commentary on the *Conics* of Apollonius.¹ This has perished and, apart from a certain proposition 'of Serenus the philosopher, from the Lemmas' preserved in certain manuscripts of Theon of Smyrna (to the effect that, if a number of rectilinear angles be subtended at a point on a diameter of a circle which is not the centre, by equal arcs of that circle, the angle nearer to the centre is always less than the angle more remote), we have only the two small treatises by him entitled *On the Section of a Cylinder* and *On the Section of a Cone*. These works came to be connected, from the seventh century onwards, with the *Conics* of Apollonius, on account of the affinity of the subjects, and this no doubt accounts for their survival. They were translated into Latin by Commandinus in 1566; the first Greek text was brought out by Halley along with his Apollonius (Oxford 1710), and we now have the definitive text edited by Heiberg (Teubner 1896).

(a) *On the Section of a Cylinder.*

The occasion and the object of the tract *On the Section of a Cylinder* are stated in the preface. Serenus observes that many persons who were students of geometry were under the erroneous impression that the oblique section of a cylinder was different from the oblique section of a cone known as an ellipse, whereas it is of course the same curve. Hence he thinks it necessary to establish, by a regular geometrical

¹ Serenus, *Opuscula*, ed. Heiberg, p. 52. 25-6.

proof, that the said oblique sections cutting all the generators are equally ellipses whether they are sections of a cylinder or of a cone. He begins with 'a more general definition' of a cylinder to include any oblique circular cylinder. 'If in two equal and parallel circles which remain fixed the diameters, while remaining parallel to one another throughout, are moved round in the planes of the circles about the centres, which remain fixed, and if they carry round with them the straight line joining their extremities on the same side until they bring it back again to the same place, let the surface described by the straight line so carried round be called a *cylindrical surface*.' The *cylinder* is the figure contained by the parallel circles and the cylindrical surface intercepted by them; the parallel circles are the *bases*, the *axis* is the straight line drawn through their centres; the generating straight line in any position is a *side*. Thirty-three propositions follow. Of these Prop. 6 proves the existence in an oblique cylinder of the parallel circular sections subcontrary to the series of which the bases are two, Prop. 9 that the section by any plane not parallel to that of the bases or of one of the subcontrary sections but cutting all the generators is not a circle; the next propositions lead up to the main results, namely those in Props. 14 and 16, where the said section is proved to have the property of the ellipse which we write in the form

$$QV^2 : PV \cdot P'V = CD^2 : CP^2,$$

and in Prop. 17, where the property is put in the Apollonian form involving the *latus rectum*, $QV^2 = PV \cdot VR$ (see figure on p. 137 above), which is expressed by saying that the square on the semi-ordinate is equal to the rectangle applied to the *latus rectum* PL , having the abscissa PV as breadth and falling short by a rectangle similar to the rectangle contained by the diameter PP' and the *latus rectum* PL (which is determined by the condition $PL \cdot PP' = DD'^2$ and is drawn at right angles to PV). Prop. 18 proves the corresponding property with reference to the conjugate diameter DD' and the corresponding *latus rectum*, and Prop. 19 gives the main property in the form $QV^2 : PV \cdot P'V = Q'V'^2 : PV' \cdot P'V'$. Then comes the proposition that 'it is possible to exhibit a cone and a cylinder which are alike cut in one and the same ellipse' (Prop. 20).

Serenus then solves such problems as these: Given a cone (or cylinder) and an ellipse on it, to find the cylinder (cone) which is cut in the same ellipse as the cone (cylinder) (Props. 21, 22); given a cone (cylinder), to find a cylinder (cone) and to cut both by one and the same plane so that the sections thus made shall be similar ellipses (Props. 23, 24). Props. 27, 28 deal with similar elliptic sections of a scalene cylinder and cone; there are two pairs of infinite sets of these similar to any one given section, the first pair being those which are parallel and subcontrary respectively to the given section, the other pair subcontrary to one another but not to either of the other sets and having the conjugate diameter occupying the corresponding place to the transverse in the other sets, and vice versa.

In the propositions (29–33) from this point to the end of the book Serenus deals with what is really an optical problem. It is introduced by a remark about a certain geometer, Peithon by name, who wrote a tract on the subject of parallels. Peithon, not being satisfied with Euclid's treatment of parallels, thought to define parallels by means of an illustration, observing that parallels are such lines as are shown on a wall or a roof by the shadow of a pillar with a light behind it. This definition, it appears, was generally ridiculed; and Serenus seeks to rehabilitate Peithon, who was his friend, by showing that his statement is after all mathematically sound. He therefore proves, with regard to the cylinder, that, if any number of rays from a point outside the cylinder are drawn touching it on both sides, all the rays pass through the sides of a parallelogram (a section of the cylinder parallel to the axis)—Prop. 29—and if they are produced farther to meet any other plane parallel to that of the parallelogram the points in which they meet the plane will lie on two parallel lines (Prop. 30); he adds that the lines will not *seem* parallel (*vide* Euclid's *Optics*, Prop. 6). The problem about the rays touching the surface of a cylinder suggests the similar one about any number of rays from an external point touching the surface of a *cone*; these meet the surface in points on a triangular section of the cone (Prop. 32) and, if produced to meet a plane parallel to that of the triangle, meet that plane in points forming a similar triangle



THIS PAGE IS LOCKED TO FREE MEMBERS

Purchase full membership to immediately unlock this page

FORGOTTEN BOOKS

FULL

MEMBERSHIP

797,885 Books!

All you can read

for only

\$8.99/month

Continue

*Fair usage policy applies



Observing that the sum of x^2 and $r^2 - x^2 + h^2$ is constant, we see that A^2 , and therefore A , is a maximum when

$$x^2 = r^2 - x^2 + h^2, \quad \text{or} \quad x^2 = \frac{1}{2}(r^2 + h^2);$$

and, since x is not greater than r , it follows that, for a real value of x (other than r), h is less than r , or the cone is obtuse-angled. When h is not less than r , the maximum triangle is the triangle through the axis and vice versa (Props. 5, 8); when $h = r$, the maximum triangle is also right-angled (Prop. 13).

If the triangle with base $2c$ is equal to the triangle through the axis, $h^2 r^2 = c^2 (r^2 - c^2 + h^2)$, or $(r^2 - c^2)(c^2 - h^2) = 0$, and, since $c < r$, $h = c$, so that $h < r$ (Prop. 10). If x lies between r and c in this case, $(r^2 - x^2)(x^2 - h^2) > 0$ or $x^2(r^2 - x^2 + h^2) > h^2 r^2$, and the triangle with base $2x$ is greater than either of the equal triangles with bases $2r$, $2c$, or $2h$ (Prop. 11).

In the case of the scalene cone Serenus compares individual triangular sections belonging to one of three classes with other sections of the same class as regards their area. The classes are:

- (1) axial triangles, including all sections through the axis;
- (2) isosceles sections, i.e. the sections the bases of which are perpendicular to the projection of the axis of the cone on the plane of the base;
- (3) a set of triangular sections the bases of which are (a) the diameter of the circular base which passes through the foot of the perpendicular from the vertex to the plane of the base, and (b) the chords of the circular base parallel to that diameter.

After two preliminary propositions (15, 16) and some lemmas, Serenus compares the areas of the first class of triangles through the axis. If, as we said, p is the perpendicular from the vertex to the plane of the base, d the distance of the foot of this perpendicular from the centre of the base, and θ the angle which the base of any axial triangle with area A makes with the base of the axial triangle passing through p the perpendicular,

$$A = r \sqrt{(p^2 + d^2 \sin^2 \theta)}.$$

This area is a minimum when $\theta = 0$, and increases with θ

until $\theta = \frac{1}{2}\pi$ when it is a maximum, the triangle being then isosceles (Prop. 24).

In Prop. 29 Serenus takes up the third class of sections with bases parallel to d . If the base of such a section is $2x$,

$$A = x \sqrt{(r^2 - x^2 + p^2)}$$

and, as in the case of the right cone, we must have for a real maximum value

$$x^2 = \frac{1}{2}(r^2 + p^2), \text{ while } x < r,$$

so that, for a real value of x other than r , p must be less than r , and, if p is not less than r , the maximum triangle is that which is perpendicular to the base of the cone and has $2r$ for its base (Prop. 29). If $p < r$, the triangle in question is not the maximum of the set of triangles (Prop. 30).

Coming now to the isosceles sections (2), we may suppose 2θ to be the angle subtended at the centre of the base by the base of the section in the direction away from the projection of the vertex. Then

$$A = r \sin \theta \sqrt{\{p^2 + (d + r \cos \theta)^2\}}.$$

If A_0 be the area of the isosceles triangle through the axis, we have

$$\begin{aligned} A_0^2 - A^2 &= r^2(p^2 + d^2) - r^2 \sin^2 \theta (p^2 + d^2 + r^2 \cos^2 \theta + 2dr \cos \theta) \\ &= r^2(p^2 + d^2) \cos^2 \theta - r^4 \sin^2 \theta \cos^2 \theta - 2dr^3 \cos \theta \sin^2 \theta. \end{aligned}$$

If $A = A_0$, we must have for triangles on the side of the centre of the base of the cone towards the vertex of the cone (since $\cos \theta$ is negative for such triangles)

$$p^2 + d^2 < r^2 \sin^2 \theta, \text{ and } a \text{ fortiori } p^2 + d^2 < r^2 \text{ (Prop. 35).}$$

If $p^2 + d^2 \geq r^2$, A_0 is always greater than A , so that A_0 is the maximum isosceles triangle of the set (Props. 31, 32).

If A is the area of any one of the isosceles triangles with bases on the side of the centre of the base of the cone away from the projection of the vertex, $\cos \theta$ is positive and A_0 is proved to be neither the minimum nor the maximum triangle of this set of triangles (Props. 36, 40-4).

In Prop. 45 Serenus returns to the set of triangular sections through the axis, proving that the feet of the perpendiculars from the vertex of the cone on their bases all lie on a circle the diameter of which is the straight line joining the centre of

the base of the cone to the projection of the vertex on its plane; the areas of the axial triangles are therefore proportional to the generators of the cone with the said circle as base and the same vertex as the original cone. Prop. 50 is to the effect that, if the axis of the cone is equal to the radius of the base, the least axial triangle is a mean proportional between the greatest axial triangle and the isosceles triangular section perpendicular to the base; that is, with the above notation, if $r = \sqrt{(p^2 + d^2)}$, then $r \sqrt{(p^2 + d^2)} : rp = rp : p \sqrt{(r^2 - d^2)}$, which is indeed obvious.

Prop. 57 is interesting because of the lemmas leading to it. It proves that the greater axial triangle in a scalene cone has the greater perimeter, and conversely. This is proved by means of the lemma (Prop. 54), applied to the variable sides of axial triangles, that if $a^2 + d^2 = b^2 + c^2$ and $a > b \geq c > d$, then $a + d < b + c$ (a, d are the sides other than the base of one axial triangle, and b, c those of the other axial triangle compared with it; and if ABC, ADE be two axial triangles and O the centre of the base, $BA^2 + AC^2 = DA^2 + AE^2$ because each of these sums is equal to $2AO^2 + 2BO^2$, Prop. 17). This proposition again depends on the lemma (Props. 52, 53) that, if straight lines be 'inflected' from the ends of the base of a segment of a circle to the curve (i.e. if we join the ends of the base to any point on the curve) the line (i.e. the sum of the chords) is greatest when the point taken is the middle point of the arc, and diminishes as the point is taken farther and farther from that point.

Let B be the middle point of the arc of the segment ABC , D, E any other points on the curve towards C ; I say that

$$AB + BC > AD + DC > AE + EC.$$

With B as centre and BA as radius describe a circle, and produce AB, AD, AE to meet this circle in F, G, H . Join FC, GC, HC .

Since $AB = BC = BF$, we have $AF = AB + BC$. Also the angles BFC, BCF are equal, and each of them is half of the angle ABC .

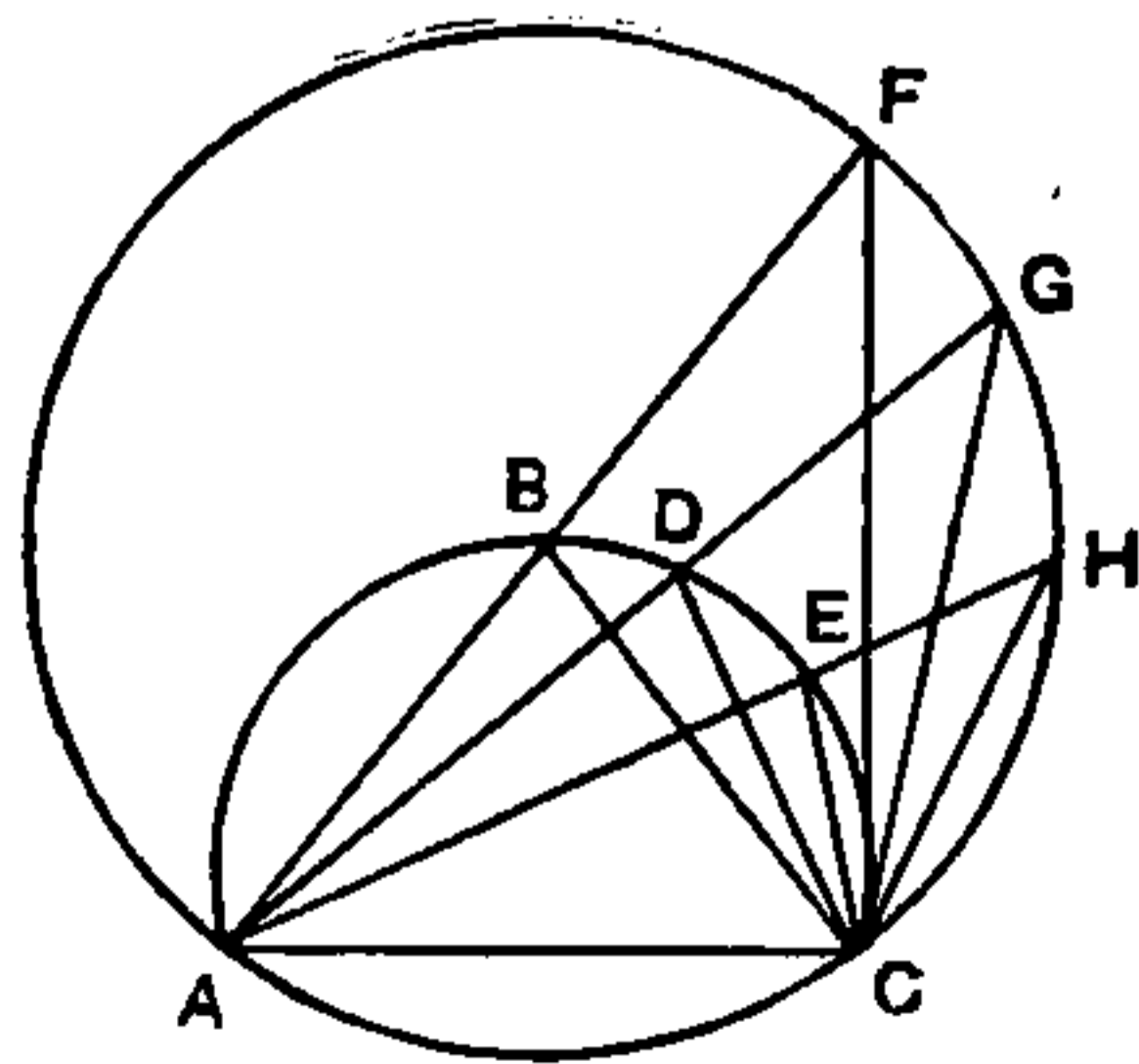



THIS PAGE IS LOCKED TO FREE MEMBERS

Purchase full membership to immediately unlock this page

DELVE INTO FANTASY, MAGIC, MYTHOLOGY & FOLKLORE

Forgotten Books'
Full Membership gives
access to 797,885 ancient
and modern, fiction and
non-fiction books.

Continue

*Fair usage policy applies

pp. 58–63). Of the historical notices we may mention the following. (1) Theon mentions the treatise of Menelaus *On Chords in a Circle*, i.e. Menelaus's Table of Chords, which came between the similar Tables of Hipparchus and Ptolemy. (2) A quotation from Diophantus furnishes incidentally a lower limit for the date of the *Arithmetica*. (3) It is in the commentary on Ptolemy that Theon tells us that the second part of Euclid VI. 33 relating to *sectors* in equal circles was inserted by himself in his edition of the *Elements*, a notice which is of capital importance in that it enables the Theonine manuscripts of Euclid to be distinguished from the ante-Theonine, and is therefore the key to the question how far the genuine text of Euclid was altered in Theon's edition. (4) As we have seen (pp. 207 sq.), Theon, à propos of an allusion of Ptolemy to the theory of isoperimetric figures, has preserved for us several propositions from the treatise by Zenodorus on that subject.

Theon's edition of Euclid's *Elements*.

We are able to judge of the character of Theon's edition of Euclid by a comparison between the Theonine manuscripts and the famous Vatican MS. 190, which contains an earlier edition than Theon's, together with certain fragments of ancient papyri. It appears that, while Theon took some trouble to follow older manuscripts, it was not so much his object to get the most authoritative text as to make what he considered improvements of one sort or other. (1) He made alterations where he found, or thought he found, mistakes in the original; while he tried to remove some real blots, he altered other passages too hastily when a little more consideration would have shown that Euclid's words are right or could be excused, and offer no difficulty to an intelligent reader. (2) He made emendations intended to improve the form or diction of Euclid; in general they were prompted by a desire to eliminate anything which was out of the common in expression or in form, in order to reduce the language to one and the same standard or norm. (3) He bestowed, however, most attention upon additions designed to supplement or explain the original; (a) he interpolated whole propositions where he thought them necessary or useful, e.g. the addition to VI. 33

already referred to, a second case to VI. 27, a porism or corollary to II. 4, a second porism to III. 16, the proposition VII. 22, a lemma after X. 12, besides alternative proofs here and there; (b) he added words for the purpose of making smoother and clearer, or more precise, things which Euclid had expressed with unusual brevity, harshness, or carelessness; (c) he supplied intermediate steps where Euclid's argument seemed too difficult to follow. In short, while making only inconsiderable additions to the content of the *Elements*, he endeavoured to remove difficulties that might be felt by learners in studying the book, as a modern editor might do in editing a classical text-book for use in schools; and there is no doubt that his edition was approved by his pupils at Alexandria for whom it was written, as well as by later Greeks, who used it almost exclusively, with the result that the more ancient text is only preserved complete in one manuscript.

Edition of the *Optics* of Euclid.

In addition to the *Elements*, Theon edited the *Optics* of Euclid; Theon's recension as well as the genuine work is included by Heiberg in his edition. It is possible that the *Catoptrica* included by Heiberg in the same volume is also by Theon.

Next to Theon should be mentioned his daughter HYPATIA, who is mentioned by Theon himself as having assisted in the revision of the commentary on Ptolemy. This learned lady is said to have been mistress of the whole of pagan science, especially of philosophy and medicine, and by her eloquence and authority to have attained such influence that Christianity considered itself threatened, and she was put to death by a fanatical mob in March 415. According to Suidas she wrote commentaries on Diophantus, on the Astronomical Canon (of Ptolemy) and on the Conics of Apollonius. These works have not survived, but it has been conjectured (by Tannery) that the remarks of Psellus (eleventh century) at the beginning of his letter about Diophantus, Anatolius, and the Egyptian method of arithmetical reckoning were taken bodily from some manuscript of Diophantus containing an ancient and systematic commentary which may very well have been that of Hypatia. Possibly her commentary may have extended

only to the first six Books, in which case the fact that Hypatia wrote a commentary on them may account for the survival of these Books while the rest of the thirteen were first forgotten and then lost.

It will be convenient to take next the series of Neo-Platonist commentators. It does not appear that Ammonius Saccas (about A.D. 175–250), the founder of Neo-Platonism, or his pupil Plotinus (A.D. 204–69), who first expounded the doctrines in systematic form, had any special connexion with mathematics, but PORPHYRY (about 232–304), the disciple of Plotinus and the reviser and editor of his works, appears to have written a commentary on the *Elements*. This we gather from Proclus, who quotes from Porphyry comments on Eucl. I. 14 and 26 and alternative proofs of I. 18, 20. It is possible that Porphyry's work may have been used later by Pappus in writing his own commentary, and Proclus may have got his references from Pappus, but the form of these references suggests that he had direct access to the original commentary of Porphyry.

IAMBlichus (died about A.D. 330) was the author of a commentary on the *Introductio arithmetica* of Nicomachus, and of other works which have already been mentioned. He was a pupil of Porphyry as well as of Anatolius, also a disciple of Porphyry.

But the most important of the Neo-Platonists to the historian of mathematics is PROCLUS (A.D. 410–85). Proclus received his early training at Alexandria, where Olympiodorus was his instructor in the works of Aristotle, and mathematics was taught him by one Heron (of course a different Heron from the 'mechanicus Hero' of the *Metrica*, &c.). He afterwards went to Athens, where he learnt the Neo-Platonic philosophy from Plutarch, the grandson of Nestorius, and from his pupil Syrianus, and became one of its most prominent exponents. He speaks everywhere with the highest respect of his masters, and was in turn regarded with extravagant veneration by his contemporaries, as we learn from Marinus, his pupil and biographer. On the death of Syrianus he was put at the head of the Neo-Platonic school. He was a man of untiring industry, as is shown by the



THIS PAGE IS LOCKED TO FREE MEMBERS

Purchase full membership to immediately unlock this page

FORGOTTEN BOOKS

FULL

MEMBERSHIP

797,885 Books!

All you can read

for only

\$8.99/month

Continue

*Fair usage policy applies



viated form usual with ancient writers. Now in the second book of the history of geometry he writes as follows'.¹ In like manner Eutocius speaks of the paralogisms handed down in connexion with the attempts of Hippocrates and Antiphon to square the circle, 'with which I imagine that all persons are accurately acquainted who have *examined* (ἐπεσκεμμένους) the geometrical history of Eudemus and know the *Ceria Aristotelica*'.²

The references by Proclus to Eudemus by name are not indeed numerous; they are five in number; but on the other hand he gives at least as many other historical data which can with great probability be attributed to Eudemus.

Proclus was even more indebted to Geminus, from whom he borrows long extracts, often mentioning him by name—there are some eighteen such references—but often omitting to do so. We are able to form a tolerably certain judgment as to the origin of the latter class of passages on the strength of the similarity of the subjects treated and the views expressed to those found in the acknowledged extracts. As we have seen, the work of Geminus mainly cited seems to have borne the title *The Doctrine or Theory of the Mathematics*, which was a very comprehensive work dealing, in a portion of it, with the 'classification of mathematics'.

We have already discussed the question of the authorship of the famous historical summary given by Proclus. It is divided, as every one knows, into two distinct parts between which comes the remark, 'Those who compiled histories bring the development of this science up to this point. Not much younger than these is Euclid, who', &c. The ultimate source at any rate of the early part of the summary must presumably have been the great work of Eudemus above mentioned.

It is evident that Proclus had before him the original works of Plato, Aristotle, Archimedes and Plotinus, the *Συμμικτά* of Porphyry and the works of his master Syrianus, as well as a group of works representing the Pythagorean tradition on its mystic, as distinct from its mathematical, side, from Philolaus downwards, and comprising the more or less apocryphal

¹ Simplicius on Arist. *Phys.*, p. 60. 28, Diels.

² Archimedes, ed. Heib., vol. iii, p. 228. 17-19.

ἱερὸς λόγος of Pythagoras, the *Oracles* (λόγια) and Orphic verses.

The following will be a convenient summary of the other works used by Proclus, and will at the same time give an indication of the historical value of his commentary on Euclid, Book I :

Eudemus : *History of Geometry*.

Geminus : *The Theory of the Mathematical Sciences*.

Heron : *Commentary on the Elements of Euclid*.

Porphry : „

Pappus : „ „ „

Apollonius of Perga : A work relating to elementary geometry.

Ptolemy : *On the parallel-postulate*.

Posidonius : A book controverting Zeno of Sidon.

Carpus : *Astronomy*.

Syrianus : A discussion on the *angle*.

(β) *Character of the Commentary.*

We know that in the Neo-Platonic school the pupils learnt mathematics; and it is clear that Proclus taught this subject, and that this was the origin of his commentary. Many passages show him as a master speaking to scholars; in one place he speaks of 'my hearers'.¹ Further, the pupils whom he was addressing were *beginners* in mathematics; thus in one passage he says that he omits 'for the present' to speak of the discoveries of those who employed the curves of Nicomedes and Hippias for trisecting an angle, and of those who used the Archimedean spiral for dividing an angle in a given ratio, because these things would be 'too difficult for beginners'.² But there are signs that the commentary was revised and re-edited for a larger public; he speaks for instance in one place of 'those who will come across his work'.³ There are also passages, e.g. passages about the cylindrical helix, conchoids and cissoids, which would not have been understood by the beginners to whom he lectured.

¹ Proclus on Eucl. I, p. 210. 19.

² *Ib.*, p. 272. 12.

³ *Ib.*, p. 84. 9.

The commentary opens with two Prologues. The first is on mathematics in general and its relation to, and use in, philosophy, from which Proclus passes to the classification of mathematics. Prologue II deals with geometry generally and its subject-matter according to Plato, Aristotle and others. After this section comes the famous summary (pp. 64-8) ending with a eulogium of Euclid, with particular reference to the admirable discretion shown in the selection of the propositions which should constitute the *Elements* of geometry, the ordering of the whole subject-matter, the exactness and the conclusiveness of the demonstrations, and the power with which every question is handled. Generalities follow, such as the discussion of the nature of *elements*, the distinction between theorems and problems according to different authorities, and finally a division of Book I into three main sections, (1) the construction and properties of triangles and their parts and the comparison between triangles in respect of their angles and sides, (2) the properties of parallels and parallelograms and their construction from certain data, and (3) the bringing of triangles and parallelograms into relation as regards area.

Coming to the Book itself, Proclus deals historically and critically with all the definitions, postulates and axioms in order. The notes on the postulates and axioms are preceded by a general discussion of the principles of geometry, hypotheses, postulates and axioms, and their relation to one another; here as usual Proclus quotes the opinions of all the important authorities. Again, when he comes to Prop. 1, he discusses once more the difference between theorems and problems, then sets out and explains the formal divisions of a proposition, the *enunciation* (πρότασις), the *setting-out* (ἔκθεσις), the *definition or specification* (διορισμός), the *construction* (κατασκευή), the *proof* (ἀπόδειξις), the *conclusion* (συμπέρασμα), and finally a number of other technical terms, e.g. things said to be *given*, in the various senses of this term, the *lemma*, the *case*, the *porism* in its two senses, the *objection* (ἔνστασις), the *reduction* of a problem, *reductio ad absurdum*, *analysis* and *synthesis*.

In his comments on the separate propositions Proclus generally proceeds in this way: first he gives explanations regarding Euclid's proofs, secondly he gives a few different



THIS PAGE IS LOCKED TO FREE MEMBERS

Purchase full membership to immediately unlock this page

DELVE INTO FANTASY, MAGIC, MYTHOLOGY & FOLKLORE

Forgotten Books'
Full Membership gives
access to 797,885 ancient
and modern, fiction and
non-fiction books.

Continue

*Fair usage policy applies

second Book'. But at the time when the commentary on Book I was written he was evidently uncertain whether he would be able to continue it, for at the end he says, 'For my part, if I should be able to discuss the other Books in the same way, I should give thanks to the gods; but, if other cares should draw me away, I beg those who are attracted by this subject to complete the exposition of the other Books as well, following the same method and addressing themselves throughout to the deeper and more sharply defined questions involved'.¹ Wachsmuth, finding a Vatican manuscript containing a collection of scholia on Books I, II, V, VI, X, headed *Εἰς τὰ Εὐκλείδου στοιχεῖα προλαμβανόμενα ἐκ τῶν Πρόκλου σποράδην καὶ κατ' ἐπιτομήν*, and seeing that the scholia on Book I were extracts from the extant commentary of Proclus, concluded that those on the other Books were also from Proclus; but the *προ-* in *προλαμβανόμενα* rather suggests that only the scholia to Book I are from Proclus. Heiberg found and published in 1903 a scholium to X. 9, in which Proclus is expressly quoted as the authority, but he does not regard this circumstance as conclusive. On the other hand, Heiberg has noted two facts which go against the view that Proclus wrote on the later Books: (1) the scholiast's copy of Proclus was not much better than our manuscripts; in particular, it had the same lacunae in the notes to I. 36, 37, and I. 41-3; this makes it improbable that the scholiast had further commentaries of Proclus which have vanished for us; (2) there is no trace in the scholia of the notes which Proclus promised in the passages already referred to. All, therefore, that we can say is that, while the Wachsmuth scholia *may* be extracts from Proclus, it is on the whole improbable.

Hypotyposis of Astronomical Hypotheses.

Another extant work of Proclus which should be referred to is his *Hypotyposis of Astronomical Hypotheses*, a sort of readable and easy introduction to the astronomical system of Hipparchus and Ptolemy. It has been well edited by Manitius (Teubner, 1909). Three things may be noted as

¹ Proclus on Eucl. I, p. 432. 9-15.

regards this work. It contains¹ a description of the method of measuring the sun's apparent diameter by means of Heron's water-clock, which, by comparison with the corresponding description in Theon's commentary to the *Syntaxis* of Ptolemy, is seen to have a common source with it. That source is Pappus, and, inasmuch as Proclus has a figure (reproduced by Manitius in his text from one set of manuscripts) corresponding to the description, while the text of Theon has no figure, it is clear that Proclus drew directly on Pappus, who doubtless gave, in his account of the procedure, a figure taken from Heron's own work on water-clocks. A simple proof of the equivalence of the epicycle and eccentric hypotheses is quoted by Proclus from one Hilarius of Antioch.² An interesting passage is that in chap. 4 (p. 130, 18) where Sosigenes the Peripatetic is said to have recorded in his work 'on reacting spheres' that an *annular* eclipse of the sun is sometimes observed at times of perigee; this is, so far as I know, the only allusion in ancient times to annular eclipses, and Proclus himself questions the correctness of Sosigenes's statement.

Commentary on the *Republic*.

The commentary of Proclus on the *Republic* contains some passages of great interest to the historian of mathematics. The most important is that³ in which Proclus indicates that Props. 9, 10 of Euclid, Book II, are Pythagorean propositions invented for the purpose of proving geometrically the fundamental property of the series of 'side-' and 'diameter-' numbers, giving successive approximations to the value of $\sqrt{2}$ (see vol. i, p. 93). The explanation⁴ of the passage in Plato about the Geometrical Number is defective and disappointing, but it contains an interesting reference to one Paterius, of date presumably intermediate between Nestorius and Proclus. Paterius is said to have made a calculation, in units and submultiples, of the lengths of different segments of

¹ Proclus, *Hypotyposis*, c. 4, pp. 120-22.

² *Ib.*, c. 3, pp. 76, 17 sq.

³ *Procli Diadochi in Platonis Rempublicam Commentarii*, ed. Kroll, vol. ii, p. 27.

⁴ *Ib.*, vol. ii, pp. 36-42.

straight lines in a figure formed by taking a triangle with sides 3, 4, 5 as ABC , then drawing BD from the right angle B perpendicular to AC , and lastly drawing perpendiculars DE , DF to AB , BC . A diagram in the text with the lengths of the segments shown alongside them in the usual numerical notation shows that Paterius obtained from the data $AB = 3$, $BC = 4$, $CA = 5$ the following:

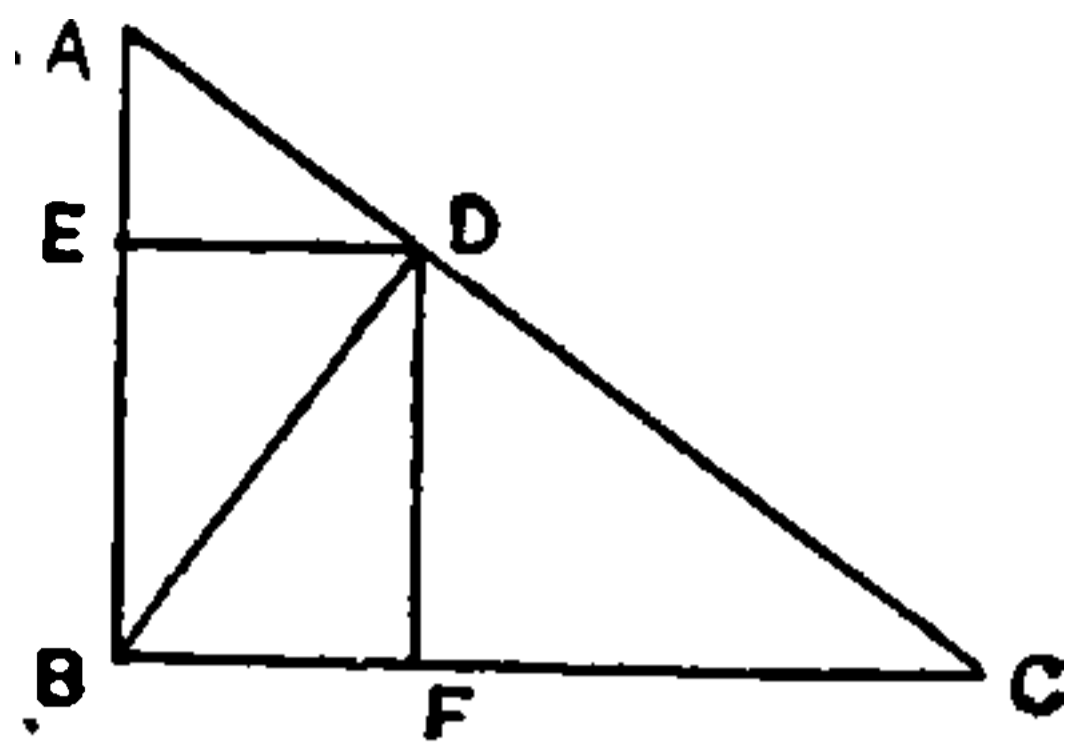

$$DC = \gamma \epsilon' = 3\frac{1}{5}$$

$$BD = \beta \gamma' \iota \epsilon' = 2\frac{1}{3} \frac{1}{15} [= 2\frac{2}{5}]$$

$$AD = \alpha \varsigma \delta' \kappa' = 1\frac{1}{2} \frac{1}{4} \frac{1}{20} [= 1\frac{4}{5}]$$

$$FC = \beta \varsigma \kappa' \rho' = 2\frac{1}{2} \frac{1}{20} \frac{1}{100} [= 2\frac{14}{25}]$$

$$FB = \alpha \gamma' \iota \epsilon' \kappa \epsilon' = 1\frac{1}{3} \frac{1}{15} \frac{1}{25} [= 1\frac{11}{25}]$$

$$BE = \alpha \varsigma \gamma' \iota \epsilon' \nu' = 1\frac{1}{2} \frac{1}{3} \frac{1}{15} \frac{1}{50} [= 1\frac{23}{25}]$$

$$EA = \alpha \iota \epsilon' \omicron \epsilon' = 1\frac{1}{15} \frac{1}{75} [= 1\frac{2}{25}].$$

This is an example of the Egyptian method of stating fractions preceding by some three or four centuries the exposition of the same method in the papyrus of Akhmim.

MARINUS of Neapolis, the pupil and biographer of Proclus, wrote a commentary or rather introduction to the *Data* of Euclid.¹ It is mainly taken up with a discussion of the question *τί τὸ δεδομένον*, what is meant by *given*? There were apparently many different definitions of the term *given* by earlier and later authorities. Of those who tried to define it in the simplest way by means of a single *differentia*, three are mentioned by name. Apollonius in his work on *νεύσεις* and his 'general treatise' (presumably that on elementary geometry) described the *given* as *assigned* or *fixed* (*τεταγμένον*), Diodorus called it *known* (*γνώριμον*); others regarded it as *rational* (*ρήτόν*) and Ptolemy is classed with these, rather oddly, because 'he called those things given the measure of which is given either exactly or approximately'. Others

¹ See Heiberg and Menge's *Euclid*, vol. vi, pp. 234-56.



THIS PAGE IS LOCKED TO FREE MEMBERS

Purchase full membership to immediately unlock this page

FORGOTTEN BOOKS

FULL

MEMBERSHIP

797,885 Books!

All you can read

for only

\$8.99/month

Continue

*Fair usage policy applies



sophy at Athens, the last members of the school, including Damascius and Simplicius, migrated to Persia, but returned about 533 to Athens, where Simplicius continued to teach for some time though the school remained closed.

Extracts from Eudemus.

To Simplicius we owe two long extracts of capital importance for the history of mathematics and astronomy. The first is his account, based upon and to a large extent quoted textually from Eudemus's *History of Geometry*, of the attempt by Antiphon to square the circle and of the quadratures of lunes by Hippocrates of Chios. It is contained in Simplicius's commentary on Aristotle's *Physics*,¹ and has been the subject of a considerable literature extending from 1870, the date when Bretschneider first called attention to it, to the latest critical edition with translation and notes by Rudio (Teubner, 1907). It has already been discussed (vol. i, pp. 183-99).

The second, and not less important, of the two passages is that containing the elaborate and detailed account of the system of concentric spheres, as first invented by Eudoxus for explaining the apparent motion of the sun, moon, and planets, and of the modifications made by Callippus and Aristotle. It is contained in the commentary on Aristotle's *De caelo*²; Simplicius quotes largely from Sosigenes the Peripatetic (second century A.D.), observing that he in his turn drew from Eudemus, who dealt with the subject in the second book of his *History of Astronomy*. It is this passage of Simplicius which, along with a passage in Aristotle's *Metaphysics*,³ enabled Schiaparelli to reconstruct Eudoxus's system (see vol. i, pp. 329-34). Nor must it be forgotten that it is in Simplicius's commentary on the *Physics*⁴ that the extract from Geminus's summary of the *Meteorologica* of Posidonius occurs which was used by Schiaparelli to support his view that it was Heraclides of Pontus, not Aristarchus of Samos, who first propounded the heliocentric hypothesis.

Simplicius also wrote a commentary on Euclid's *Elements*, Book I, from which an-Nairizī, the Arabian commentator,

¹ *Simpl. in Phys.*, pp. 54-69, ed. Diels.

² *Simpl. on Arist. De caelo*, p. 488. 18-24 and pp. 493-506, ed. Heiberg.

³ *Metaph.* A. 8, 1073 b 17-1074 a 14.

⁴ *Simpl. in Phys.*, pp. 291-2, ed. Diels.

made valuable extracts, including the account of the attempt of 'Aganis' to prove the parallel-postulate (see pp. 228-30 above).

Contemporary with Simplicius, or somewhat earlier, was EUTOCIUS, the commentator on Archimedes and Apollonius. As he dedicated the commentary on Book I *On the Sphere and Cylinder* to Ammonius (a pupil of Proclus and teacher of Simplicius), who can hardly have been alive after A.D. 510, Eutocius was probably born about A.D. 480. His date used to be put some fifty years later because, at the end of the commentaries on Book II *On the Sphere and Cylinder* and on the *Measurement of a Circle*, there is a note to the effect that 'the edition was revised by Isidorus of Miletus, the mechanical engineer, *our teacher*'. But, in view of the relation to Ammonius, it is impossible that Eutocius can have been a pupil of Isidorus, who was younger than Anthemius of Tralles, the architect of Saint Sophia at Constantinople in 532, whose work was continued by Isidorus after Anthemius's death about A.D. 534. Moreover, it was to Anthemius that Eutocius dedicated, separately, the commentaries on the first four Books of Apollonius's *Conics*, addressing Anthemius as 'my dear friend'. Hence we conclude that Eutocius was an elder contemporary of Anthemius, and that the reference to Isidorus is by an editor of Eutocius's commentaries who was a pupil of Isidorus. For a like reason, the reference in the commentary on Book II *On the Sphere and Cylinder*¹ to a *διαβήτης* invented by Isidorus 'our teacher' for drawing a parabola must be considered to be an interpolation by the same editor.

Eutocius's commentaries on Archimedes apparently extended only to the three works, *On the Sphere and Cylinder*, *Measurement of a Circle* and *Plane Equilibriums*, and those on the *Conics* of Apollonius to the first four Books only. We are indebted to these commentaries for many valuable historical notes. Those deserving special mention here are (1) the account of the solutions of the problem of the duplication of the cube, or the finding of two mean proportionals, by 'Plato', Heron, Philon, Apollonius, Diocles, Pappus, Sporus, Menaechmus, Archytas, Eratosthenes, Nicomedes, (2) the fragment discovered by Eutocius himself containing the

¹ Archimedes, ed. Heiberg, vol. iii, p. 84. 8-11.

missing solution, promised by Archimedes in *On the Sphere and Cylinder*, II. 4, of the auxiliary problem amounting to the solution by means of conics of the cubic equation $(a-x)x^2 = bc^2$, (3) the solutions (a) by Diocles of the original problem of II. 4 without bringing in the cubic, (b) by Dionysodorus of the auxiliary cubic equation.

ANTHEMIUS of Tralles, the architect, mentioned above, was himself an able mathematician, as is seen from a fragment of a work of his, *On Burning-mirrors*. This is a document of considerable importance for the history of conic sections. Originally edited by L. Dupuy in 1777, it was reprinted in Westermann's *Παραδοξογράφοι* (*Scriptores rerum mirabilium Graeci*), 1839, pp. 149–58. The first and third portions of the fragment are those which interest us.¹ The first gives a solution of the problem, To contrive that a ray of the sun (admitted through a small hole or window) shall fall in a given spot, without moving away at any hour and season. This is contrived by constructing an elliptical mirror one focus of which is at the point where the ray of the sun is admitted while the other is at the point to which the ray is required to be reflected at all times. Let B be the hole, A the point to which reflection must always take place, BA being in the meridian and parallel to the horizon. Let BC be at right angles to BA , so that CB is an equinoctial ray; and let BD be the ray at the summer solstice, BE a winter ray.

Take F at a convenient distance on BE and measure FQ equal to FA . Draw HFG through F bisecting the angle AFQ , and let BG be the straight line bisecting the angle EBC between the winter and the equinoctial rays. Then clearly, since FG bisects the angle QFA , if we have a plane mirror in the position HFG , the ray BFE entering at B will be reflected to A .

To get the equinoctial ray similarly reflected to A , join GA , and with G as centre and GA as radius draw a circle meeting BC in K . Bisect the angle KGA by the straight line GLM meeting BK in L and terminated at M , a point on the bisector of the angle CBD . Then LM bisects the angle KLA also, and $KL = LA$, and $KM = MA$. If then GLM is a plane mirror, the ray BL will be reflected to A .

¹ See *Bibliotheca mathematica*, vii₃, 1907, pp. 225–33.



THIS PAGE IS LOCKED TO FREE MEMBERS

Purchase full membership to immediately unlock this page

DELVE INTO FANTASY, MAGIC, MYTHOLOGY & FOLKLORE

Forgotten Books'
Full Membership gives
access to 797,885 ancient
and modern, fiction and
non-fiction books.

Continue

*Fair usage policy applies

the focus to the intersection of two tangents bisects the angle between the straight lines joining the focus to the two points of contact respectively.

In the third portion of the fragment Anthemius proves that parallel rays can be reflected to one single point from a parabolic mirror of which the point is the focus. The *directrix* is used in the construction, which follows, *mutatis mutandis*, the same course as the above construction in the case of the ellipse.

As to the supposition of Heiberg that Anthemius may also be the author of the *Fragmentum mathematicum Bobiense*, see above (p. 203).

The Papyrus of Akhmīm.

Next in chronological order must apparently be placed the Papyrus of Akhmīm, a manual of calculation written in Greek, which was found in the metropolis of Akhmīm, the ancient Panopolis, and is now in the Musée du Gizeh. It was edited by J. Baillet¹ in 1892. According to the editor, it was written between the sixth and ninth centuries by a Christian. It is interesting because it preserves the Egyptian method of reckoning, with proper fractions written as the sum of primary fractions or submultiples, a method which survived alongside the Greek and was employed, and even exclusively taught, in the East. The advantage of this papyrus, as compared with Ahmes's, is that we can gather the formulae used for the decomposition of ordinary proper fractions into sums of submultiples. The formulae for decomposing a proper fraction into the sum of two submultiples may be shown thus:

$$(1) \quad \frac{a}{bc} = \frac{1}{c \cdot \frac{b+c}{a}} + \frac{1}{b \cdot \frac{b+c}{a}}.$$

$$\text{Examples} \quad \frac{2}{11} = \frac{1}{6} \frac{1}{66}, \quad \frac{3}{110} = \frac{1}{70} \frac{1}{77}, \quad \frac{18}{323} = \frac{1}{34} \frac{1}{38}.$$

$$(2) \quad \frac{a}{bc} = \frac{1}{c \cdot \frac{b+mc}{a}} + \frac{1}{b \cdot \frac{b+mc}{a} \cdot \frac{1}{m}}.$$

¹ *Mémoires publiés par les membres de la Mission archéologique française au Caire*, vol. ix, part 1, pp. 1-89.

$$\text{Ex. } \frac{7}{176} = \frac{1}{11 \left(\frac{16 + 3 \cdot 11}{7} \right)} + \frac{1}{16 \left(\frac{16 + 3 \cdot 11}{7} \right)^{\frac{1}{3}}} = \frac{1}{77} + \frac{3}{112};$$

$$\text{and again } \frac{3}{112} = \frac{1}{7 \left(\frac{16 + 2 \cdot 7}{3} \right)} + \frac{1}{16 \left(\frac{16 + 2 \cdot 7}{3} \right)^{\frac{1}{2}}} = \frac{1}{70} + \frac{1}{80}$$

$$(3) \frac{a}{cdf} = \frac{1}{c \cdot \frac{cd + df}{a}} + \frac{1}{f \cdot \frac{cd + df}{a}}$$

Example.

$$\frac{28}{1320} = \frac{28}{10 \cdot 12 \cdot 11} = \frac{1}{10 \cdot \frac{120 + 132}{28}} + \frac{1}{11 \cdot \frac{120 + 132}{28}} = \frac{1}{90} + \frac{1}{99}$$

The object is, of course, to choose the factors of the denominator, and the multiplier m in (2), in such a way as to make the two denominators on the right-hand side integral.

When the fraction has to be decomposed into a sum of three or more submultiples, we take out an obvious submultiple first, then if necessary a second, until one of the formulae will separate what remains into two submultiples. Or we take out a part which is not a submultiple but which can be divided into two submultiples by one of the formulae.

For example, to decompose $\frac{31}{616}$. The factors of 616 are 8.77 or 7.88. Take out $\frac{1}{88}$, and $\frac{31}{616} = \frac{1}{88} \frac{24}{616} = \frac{1}{88} \frac{3}{77} = \frac{1}{88} \frac{1}{77} \frac{2}{77}$; and $\frac{2}{77} = \frac{1}{63} \frac{1}{99}$ by formula (1), so that $\frac{31}{616} = \frac{1}{63} \frac{1}{77} \frac{1}{88} \frac{1}{99}$.

Take $\frac{239}{6460}$. The factors of 6460 are 85.76 or 95.68. Take out $\frac{1}{85}$, and $\frac{239}{6460} = \frac{1}{85} \frac{163}{6460}$. Again take out $\frac{1}{95}$, and we have $\frac{1}{85} \frac{1}{95} \frac{95}{6460}$ or $\frac{1}{85} \frac{1}{95} \frac{1}{68}$. The actual problem here is to find $\frac{1}{3 \cdot 2 \cdot 3}$ rd of $11 \frac{1}{2} \frac{1}{3} \frac{1}{10} \frac{1}{60}$, which latter expression reduces to $\frac{1}{20} \cdot 239$.

The sort of problems solved in the book are (1) the division of a number into parts in the proportion of certain given numbers, (2) the solution of simple equations such as this: From a certain treasure we take away $\frac{1}{3}$ th, then from the remainder $\frac{1}{7}$ th of that remainder, and we find 150 units left;

what was the treasure? $\left[\left\{ x - \frac{1}{a}x - \frac{1}{b} \left(x - \frac{1}{a}x \right) - \dots \right\} = R. \right]$

(3) subtractions such as: From $\frac{2}{3}$ subtract $\frac{1}{10} \frac{1}{11} \frac{1}{20} \frac{1}{22} \frac{1}{30} \frac{1}{33} \frac{1}{40} \frac{1}{44} \frac{1}{50} \frac{1}{55} \frac{1}{60} \frac{1}{66} \frac{1}{70} \frac{1}{77} \frac{1}{88} \frac{1}{90} \frac{1}{99} \frac{1}{100} \frac{1}{110}$. Answer, $\frac{1}{10} \frac{1}{50}$.

The book ends with long tables of results obtained (1) by multiplying successive numbers, tens, hundreds and thousands up to 10,000 by $\frac{2}{3}, \frac{1}{3}, \frac{1}{4}, \frac{1}{5}, \frac{1}{6}, \&c.$, up to $\frac{1}{10}$, (2) by multiplying all the successive numbers 1, 2, 3 ... n by $\frac{1}{n}$, where n is successively 11, 12, ... and 20; the results are all arranged as the sums of integers and submultiples.

The *Geodaesia* of a Byzantine author formerly called, without any authority, 'Heron the Younger' was translated into Latin by Barocius in 1572, and the Greek text was published with a French translation by Vincent.¹ The place of the author's observations was the hippodrome at Constantinople, and the date apparently about 938. The treatise was modelled on Heron of Alexandria, especially the *Dioptra*, while some measurements of areas and volumes are taken from the *Metrica*.

MICHAEL PSELLUS lived in the latter part of the eleventh century, since his latest work bears the date 1092. Though he was called 'first of philosophers', it cannot be said that what survives of his mathematics suits this title. Xylander edited in 1556 the Greek text, with a Latin translation, of a book purporting to be by Psellus on the four mathematical sciences, arithmetic, music, geometry and astronomy, but it is evident that it cannot be entirely Psellus's own work, since the astronomical portion is dated 1008. The arithmetic contains no more than the names and classification of numbers and ratios. The geometry has the extraordinary remark that, while opinions differed as to how to find the area of a circle, the method which found most favour was to take the area as the geometric mean between the inscribed and circumscribed squares; this gives $\pi = \sqrt{8} = 2.8284271!$ The only thing of Psellus which has any value for us is the letter published by Tannery in his edition of Diophantus.² In this letter Psellus says that both Diophantus and Anatolius (Bishop of Laodicea about A. D. 280) wrote on the Egyptian method of reckoning,

¹ *Notices et extraits*, xix, pt. 2, Paris, 1858.

² *Diophantus*, vol. ii, pp. 37-42.



THIS PAGE IS LOCKED TO FREE MEMBERS

Purchase full membership to immediately unlock this page

FORGOTTEN BOOKS

FULL

MEMBERSHIP

797,885 Books!

All you can read

for only

\$8.99/month

Continue

*Fair usage policy applies



Rechenbuch des Maximus Planudes in Greek by Gerhardt (Halle, 1865) and in a German translation by H. Waeschke (Halle, 1878). There was, however, an earlier book under the similar title *Ἀρχὴ τῆς μεγάλης καὶ Ἰνδικῆς ψηφιοφορίας* (*sic*), written in 1252, which is extant in the Paris MS. Suppl. Gr. 387; and Planudes seems to have raided this work. He begins with an account of the symbols which, he says, were

‘invented by certain distinguished astronomers for the most convenient and accurate expression of numbers. There are nine of these symbols (our 1, 2, 3, 4, 5, 6, 7, 8, 9), to which is added another called *Tzifra* (cypher), written 0 and denoting zero. The nine signs as well as this one are Indian.’

But this is, of course, not the first occurrence of the Indian numerals; they were known, except the zero, to Gerbert (Pope Sylvester II) in the tenth century, and were used by Leonardo of Pisa in his *Liber abaci* (written in 1202 and rewritten in 1228). Planudes used the Persian form of the numerals, differing in this from the writer of the treatise of 1252 referred to, who used the form then current in Italy. It scarcely belongs to Greek mathematics to give an account of Planudes’s methods of subtraction, multiplication, &c.

Extraction of the square root.

As regards the extraction of the square root, he claims to have invented a method different from the Indian method and from that of Theon. It does not appear, however, that there was anything new about it. Let us try to see in what the supposed new method consisted.

Planudes describes fully the method of extracting the square root of a number with several digits, a method which is essentially the same as ours. This appears to be what he refers to later on as ‘the Indian method’. Then he tells us how to find a first approximation to the root when the number is not a complete square.

‘Take the square root of the next lower actual square number, and double it: then, from the number the square root of which is required, subtract the next lower square number so found, and to the remainder (as numerator) give as denominator the double of the square root already found.’

The example given is $\sqrt{18}$. Since $4^2 = 16$ is the next lower square, the approximate square root is $4 + \frac{2}{2 \cdot 4}$ or $4\frac{1}{4}$.

The formula used is, therefore, $\sqrt{a^2 + b} = a + \frac{b}{2a}$ approximately. (An example in larger numbers is

$$\sqrt{1690196789} = 41112 + \frac{245}{82224} \text{ approximately.})$$

Planudes multiplies $4\frac{1}{4}$ by itself and obtains $18\frac{1}{16}$, which shows that the value $4\frac{1}{4}$ is not accurate. He adds that he will explain later a method which is more exact and nearer the truth, a method 'which I claim as a discovery made by me with the help of God'. Then, coming to the method which he claims to have discovered, Planudes applies it to $\sqrt{6}$. The object is to develop this in units and sexagesimal fractions. Planudes begins by multiplying the 6 by 3600, making 21600 second-sixtieths, and finds the square root of 21600 to lie between 146 and 147. Writing the 146' as 2 26', he proceeds to find the rest of the approximate square root (2 26' 58'' 9''') by the same procedure as that used by Theon in extracting the square root of 4500 and 2 28' respectively. The difference is that in neither of the latter cases does Theon multiply by 3600 so as to reduce the units to second-sixtieths, but he begins by taking the approximate square root of 2, viz. 1, just as he does that of 4500 (viz. 67). It is, then, the multiplication by 3600, or the reduction to second-sixtieths to start with, that constitutes the difference from Theon's method, and this must therefore be what Planudes takes credit for as a new discovery. In such a case as $\sqrt{2 \ 28'}$ or $\sqrt{3}$, Theon's method has the inconvenience that the number of *minutes* in the second term (34' in the one case and 43' in the other) cannot be found without some trouble, a difficulty which is avoided by Planudes's expedient. Therefore the method of Planudes had its advantage in such a case. But the discovery was not new. For it will be remembered that Ptolemy (and doubtless Hipparchus before him) expressed the chord in a circle subtending an angle of 120° at the centre (in terms of 120th parts of the diameter) as $103^p \ 55' \ 23''$, which indicates that the first step in calculating $\sqrt{3}$ was to multiply it by 3600, making 10800, the nearest square below which is $103^2 (= 10609)$. In

the scholia to Eucl., Book X, the same method is applied. Examples have been given above (vol. i, p. 63). The supposed new method was therefore not only already known to the scholiast, but goes back, in all probability, to Hipparchus.

Two problems.

Two problems given at the end of the Manual of Planudes are worth mention. The first is stated thus: 'A certain man finding himself at the point of death had his desk or safe brought to him and divided his money among his sons with the following words, "I wish to divide my money equally between my sons: the first shall have one piece and $\frac{1}{7}$ th of the rest, the second 2 and $\frac{1}{7}$ th of the remainder, the third 3 and $\frac{1}{7}$ th of the remainder." At this point the father died without getting to the end either of his money or the enumeration of his sons. I wish to know how many sons he had and how much money.' The solution is given as $(n-1)^2$ for the number of coins to be divided and $(n-1)$ for the number of his sons; or rather this is how it might be stated, for Planudes takes $n=7$ arbitrarily. Comparing the shares of the first two we must clearly have

$$1 + \frac{1}{n}(x-1) = 2 + \frac{1}{n}\left\{x - \left(1 + \frac{x-1}{n} + 2\right)\right\},$$

which gives $x = (n-1)^2$; therefore each of $(n-1)$ sons received $(n-1)$.

The other problem is one which we have already met with, that of finding two rectangles of equal perimeter such that the area of one of them is a given multiple of the area of the other. If n is the given multiple, the rectangles are (n^2-1, n^3-n^2) and $(n-1, n^3-n)$ respectively. Planudes states the solution correctly, but how he obtained it is not clear.

We find also in the Manual of Planudes the 'proof by nine' (i.e. by casting out nines), with a statement that it was discovered by the Indians and transmitted to us through the Arabs.

MANUEL MOSCHOPOULOS, a pupil and friend of Maximus Planudes, lived apparently under the Emperor Andronicus II (1282-1328) and perhaps under his predecessor Michael VIII (1261-82) also. A man of wide learning, he wrote (at the



THIS PAGE IS LOCKED TO FREE MEMBERS

Purchase full membership to immediately unlock this page

DELVE INTO FANTASY, MAGIC, MYTHOLOGY & FOLKLORE

Forgotten Books'
Full Membership gives
access to 797,885 ancient
and modern, fiction and
non-fiction books.

Continue

*Fair usage policy applies

of Smyrna, arithmetician and geometer, τοῦ 'Ραβδά, at the instance of the most revered Master of Requests, Georgius Chatzyces, and most easy for those who desire to study it.' A long passage, called ἔκφρασις τοῦ δακτυλικοῦ μέτρου, deals with a method of finger-notation, in which the fingers of each hand held in different positions are made to represent numbers.¹ The fingers of the left hand serve to represent all the units and tens, those of the right all the hundreds and thousands up to 9000; 'for numbers above these it is necessary to use writing, the hands not sufficing to represent such numbers.' The numbers begin with the little fingers of each hand; if we call the thumb and the fingers after it the 1st, 2nd, 3rd, 4th, and 5th fingers in the German style, the successive signs may be thus described, premising that, where fingers are not either bent or 'half-closed' (κλινόμενοι) or 'closed' (συστελλόμενοι), they are supposed to be held out straight (ἐκτεινόμενοι).

(a) *On the left hand:*

for 1, half-close the 5th finger only;

„ 2, „ „ 4th and 5th fingers only;

„ 3, „ „ 3rd, 4th and 5th fingers only;

„ 4, „ „ 3rd and 4th fingers only;

„ 5, „ „ 3rd finger only;

„ 6, „ „ 4th „ „

„ 7, close the 5th finger only;

„ 8, „ „ 4th and 5th fingers only;

„ 9, „ „ 3rd, 4th and 5th fingers only.

(b) The same operations on the *right hand* give the *thousands*, from 1000 to 9000.

(c) *On the left hand:*

for 10, apply the tip of the forefinger to the first joint of the thumb so that the resulting figure resembles σ ;

¹ A similar description occurs in the works of the Venerable Bede ('De computo vel loquela digitorum', forming chapter i of *De temporum ratione*), where expressions are also quoted from St. Jerome (d. 420 A. D.) as showing that he too was acquainted with the system (*The Miscellaneous Works of the Venerable Bede*, ed. J. A. Giles, vol. vi, 1843, pp. 141-3).

for 20, stretch out the forefinger straight and vertical, keep fingers 3, 4, 5 together but separate from it and inclined slightly to the palm; in this position touch the forefinger with the thumb;

„ 30, join the tips of the forefinger and thumb;

„ 40, place the thumb on the knuckle of the forefinger behind, making a figure like the letter Γ ;

„ 50, make a like figure with the thumb on the knuckle of the forefinger *inside*;

„ 60, place the thumb inside the forefinger as for 50 and bring the forefinger down over the thumb, touching the ball of it;

„ 70, rest the forefinger round the tip of the thumb, making a curve like a spiral;

„ 80, fingers 3, 4, 5 being held together and inclined at an angle to the palm, put the thumb across the palm to touch the third phalanx of the middle finger (3) and in this position bend the forefinger above the first joint of the thumb;

„ 90, close the forefinger only as completely as possible.

(d) The same operations on the *right hand* give the *hundreds*, from 100 to 900.

The first letter also contains tables for addition and subtraction and for multiplication and division; as these are said to be the 'invention of Palamedes', we must suppose that such tables were in use from a remote antiquity. Lastly, the first letter contains a statement which, though applied to particular numbers, expresses a theorem to the effect that

$$(a_0 + 10a_1 + \dots + 10^m a_m) (b_0 + 10b_1 + \dots + 10^n b_n) \text{ is not } > 10^{m+n+2},$$

where $a_0, a_1 \dots b_0, b_1 \dots$ are any numbers from 0 to 9.

In the second letter of Rhabdas we find simple algebraical problems of the same sort as those of the *Anthologia Graeca* and the Papyrus of Akhmim. Thus there are five problems leading to equations of the type

$$\frac{x}{m} + \frac{x}{n} + \dots = a.$$

Rhabdas solves the equation $\frac{x}{m} + \frac{x}{n} = a$, practically as we should, by multiplying up to get rid of fractions, whence he obtains $x = mna / (m + n)$. Again he solves the simultaneous equations $x + y = a$, $mx = ny$; also the pair of equations

$$x + \frac{y}{m} = y + \frac{x}{n} = a.$$

Of course, m , n , $a \dots$ have particular numerical values in all cases.

Rhabdas's Rule for approximating to the square root of a non-square number.

We find in Rhabdas the equivalent of the Heronian formula for the approximation to the square root of a non-square number $A = a^2 + b$, namely

$$\alpha = a + \frac{b}{2a};$$

he further observes that, if α be an approximation by excess, then $\alpha_1 = A/\alpha$ is an approximation by defect, and $\frac{1}{2}(\alpha + \alpha_1)$ is an approximation nearer than either. This last form is of course exactly Heron's formula $\alpha = \frac{1}{2}\left(a + \frac{A}{a}\right)$. The formula

was also known to Barlaam (presently to be mentioned), who also indicates that the procedure can be continued indefinitely.

It should here be added that there is interesting evidence of the Greek methods of approximating to square roots in two documents published by Heiberg in 1899.¹ The first of these documents (from a manuscript of the fifteenth century at Vienna) gives the approximate square root of certain non-square numbers from 2 to 147 in integers and proper fractions. The numerals are the Greek alphabetic numerals, but they are given place-value like our numerals: thus $\alpha\eta = 18$, $\alpha\delta\zeta = 147$, $\frac{\alpha\gamma}{\beta\eta} = \frac{13}{28}$, and so on: 0 is indicated by υ or, sometimes, by \bullet .

All these square roots, such as $\sqrt{(21)} = 4\frac{2}{3}\frac{1}{6}$, $\sqrt{(35)} = 5\frac{1}{1}\frac{1}{2}$, $\sqrt{(112)} = 10\frac{4}{8}\frac{9}{4}$, and so on, can be obtained (either exactly or, in a few cases, by neglecting or adding a small fraction in the

¹ 'Byzantinische Analekten' in *Abh. zur Gesch. d. Math.* ix. Heft, 1899, pp. 163 sqq.



THIS PAGE IS LOCKED TO FREE MEMBERS

Purchase full membership to immediately unlock this page

FORGOTTEN BOOKS

FULL

MEMBERSHIP

797,885 Books!

All you can read

for only

\$8.99/month

Continue

*Fair usage policy applies



ordinary fractions and sexagesimal fractions (printed at Strassburg in 1592 and at Paris in 1600). Barlaam, as we have seen, knew the Heronian formulae for finding successive approximations to square roots, and was aware that they could be indefinitely continued.

ISAAC ARGYRUS, a monk, who lived before 1368, was one of a number of Byzantine translators of Persian astronomical works. In mathematics he wrote a *Geodaesia* and scholia to the first six Books of Euclid's *Elements*. The former is contained in the Paris MS. 2428 and is called 'a method of geodesy or the measurement of surfaces, exact and shortened'; the introductory letter addressed to one Colybos is followed by a compilation of extracts from the *Geometrica* and *Stereometrica* of Heron. He is apparently the author of some further additions to Rhabdas's revision of the Manual of Planudes contained in the same manuscript. A short tract of his 'On the discovery of the square roots of non-rational square numbers' is mentioned as contained in two other manuscripts at Venice and Rome respectively (Codd. Marcianus Gr. 333 and Vaticanus Gr. 1058), where it is followed by a table of the square roots of all numbers from 1 to 102 in sexagesimal fractions (e.g. $\sqrt{2} = 1\ 24' 51'' 48'''$, $\sqrt{3} = 1\ 43' 56'' 0'''$).¹

¹ Heiberg, 'Byzantinische Analekten', in *Abh. zur Gesch. d. Math.* ix, pp. 169-70.

APPENDIX

On Archimedes's proof of the subtangent-property of a spiral.

THE section of the treatise *On Spirals* from Prop. 3 to Prop. 20 is an elaborate series of propositions leading up to the proof of the fundamental property of the subtangent corresponding to the tangent at any point on any turn of the spiral. Libri, doubtless with this series of propositions in mind, remarks (*Histoire des sciences mathématiques en Italie*, i, p. 31) that 'Après vingt siècles de travaux et de découvertes, les intelligences les plus puissantes viennent encore échouer contre la synthèse difficile du *Traité des Spirales* d'Archimède.' There is no foundation for this statement, which seems to be a too hasty generalization from a dictum, apparently of Fontenelle, in the *Histoire de l'Académie des Sciences pour l'année 1704* (p. 42 of the edition of 1722), who says of the proofs of Archimedes in the work *On Spirals*: 'Elles sont si longues, et si difficiles à embrasser, que, comme on l'a pû voir dans la Préface de l'Analyse des Infiniment petits, M. Bouillaud a avoué qu'il ne les avoit jamais bien entendues, et que Viète les a injustement soupçonnées de paralogisme, parce qu'il n'avoit pû non plus parvenir à les bien entendre. Mais toutes les preuves qu'on peut donner de leur difficulté et de leur obscurité tournent à la gloire d'Archimède; car quelle vigueur d'esprit, quelle quantité de vûes différentes, quelle opiniâtreté de travail n'a-t-il pas fallu pour lier et pour disposer un raisonnement que quelques-uns de nos plus grands géomètres ne peuvent suivre, tout lié et tout disposé qu'il est?'

P. Tannery has observed¹ that, as a matter of fact, no mathematicians of real authority who have applied or extended Archimedes's methods (such men as Huygens, Pascal, Roberval and Fermat, who alone could have expressed an opinion worth having), have ever complained of the

¹ *Bulletin des sciences mathématiques*, 1895, Part i, pp. 265-71.

'obscurity' of Archimedes; while, as regards Vieta, he has shown that the statement quoted is based on an entire misapprehension, and that, so far from suspecting a fallacy in Archimedes's proofs, Vieta made a special study of the treatise *On Spirals* and had the greatest admiration for that work.

But, as in many cases in Greek geometry where the analysis is omitted or even (as Wallis was tempted to suppose) of set purpose hidden, the reading of the completed synthetical proof leaves a certain impression of mystery; for there is nothing in it to show *why* Archimedes should have taken precisely this line of argument, or how he evolved it. It is a fact that, as Pappus said, the subtangent-property can be established by purely 'plane' methods, without recourse to a 'solid' *νεῦσις* (whether actually solved or merely assumed capable of being solved). If, then, Archimedes chose the more difficult method which we actually find him employing, it is scarcely possible to assign any reason except his definite predilection for the form of proof by *reductio ad absurdum* based ultimately on his famous 'Lemma' or Axiom.

It seems worth while to re-examine the whole question of the discovery and proof of the property, and to see how Archimedes's argument compares with an easier 'plane' proof suggested by the figures of some of the very propositions proved by Archimedes in the treatise.

In the first place, we may be sure that the property was not discovered by the steps leading to the proof as it stands. I cannot but think that Archimedes divined the result by an argument corresponding to our use of the differential calculus for determining tangents. He must have considered the instantaneous direction of the motion of the point P describing the spiral, using for this purpose the parallelogram of velocities. The motion of P is compounded of two motions, one along OP and the other at right angles to it. Comparing the distances traversed in an instant of time in the two directions, we see that, corresponding to a small increase in the radius vector r , we have a small distance traversed perpendicularly to it, a tiny arc of a circle of radius r subtended by the angle representing the simultaneous small increase of the angle θ (AOP). Now r has a constant ratio to θ which we call a (when θ is the circular measure of the angle θ). Consequently



THIS PAGE IS LOCKED TO FREE MEMBERS

Purchase full membership to immediately unlock this page

DELVE INTO FANTASY, MAGIC, MYTHOLOGY & FOLKLORE

Forgotten Books'
Full Membership gives
access to 797,885 ancient
and modern, fiction and
non-fiction books.

Continue

*Fair usage policy applies

But $(\text{arc } ASP) = OT$, by hypothesis;

therefore it was necessary to prove, *alternando*, that

$$(3) \quad F'R : (\text{arc } RP) < RO : OT, \text{ or } PO : OT,$$

i.e. $< PM : MO$, where OM is perpendicular to SP .

Similarly, in order to satisfy (2), it was necessary to prove that

$$(4) \quad FQ : (\text{arc } PQ) > PM : MO.$$

Now, as a matter of fact, (3) is *a fortiori* satisfied if

$$F'R : (\text{chord } RP) < PM : MO;$$

but in the case of (4) we cannot substitute the *chord* PQ for the arc PQ , and we have to substitute PG' , where G' is the point in which the tangent at P to the circle meets OQ produced; for of course $PG' > (\text{arc } PQ)$, so that (4) is *a fortiori* satisfied if

$$FQ : PG' > PM : MO.$$

It is remarkable that Archimedes uses for his proof of the two cases Prop. 8 and Prop. 7 respectively, and makes no use of Props 6 and 9, whereas

the above argument points precisely to the use of the figures of the two latter propositions only.

For in the figure of Prop. 6 (Fig. 1), if OFP is any radius cutting AB in F , and if PB produced cuts OT , the parallel to AB through O , in H , it is obvious, by parallels, that

$$PF : (\text{chord } PB) = OP : PH.$$

Also PH becomes greater the farther P moves from B towards A , so that the ratio $PF : PB$ diminishes continually, while it is always less than $OB : BT$ (where BT is the tangent at B and meets OH in T), i.e. always less than $BM : MO$.

Hence the relation (3) is always satisfied for any point R' of the spiral on the 'backward' side of P .

But (3) is equivalent to (1), from which it follows that $F'R$ is always less than RR' , so that R' always lies on the side of TP towards O .

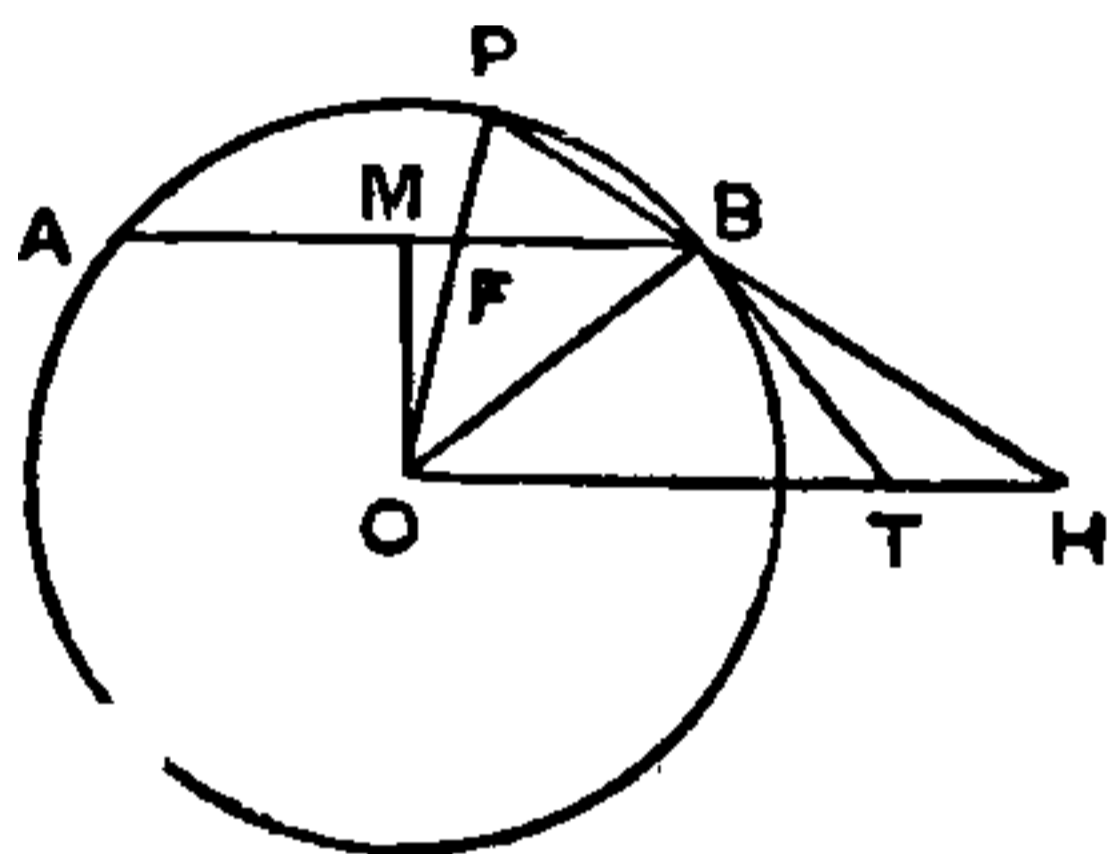

FIG. 1.

Next, for the point Q' on the 'forward' side of the spiral from P , suppose that in the figure of Prop. 9 or Prop. 7 (Fig. 2) any radius OP of the circle meets AB produced in F , and

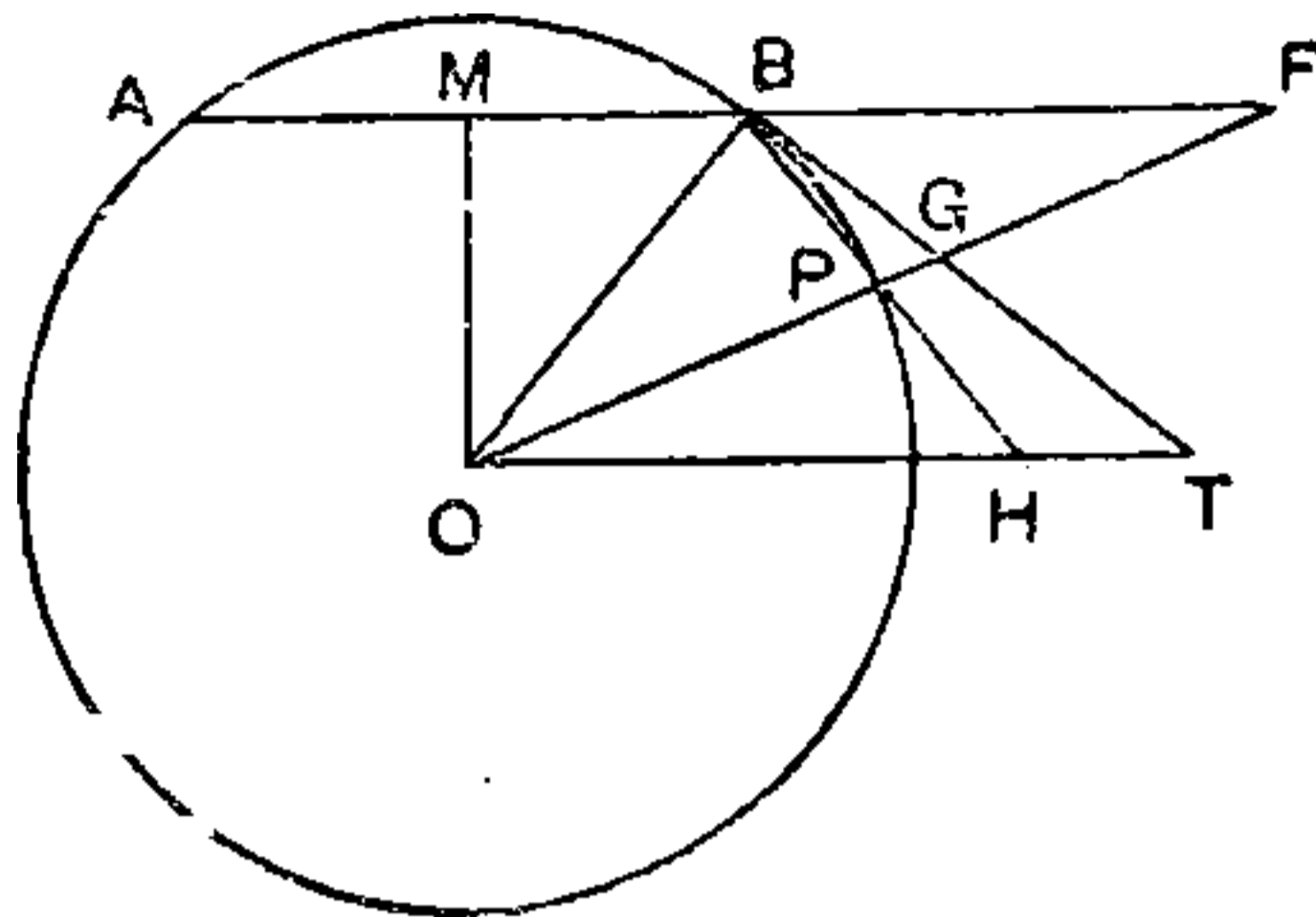

FIG. 2.

the tangent at B in G ; and draw BPH , BGT meeting OT , the parallel through O to AB , in H , T .

Then $PF : BG > FG : BG$, since $PF > FG$,
 $> OG : GT$, by parallels,
 $> OB : BT$, *a fortiori*,
 $> BM : MO$;

and obviously, as P moves away from B towards OT , i.e. as G moves away from B along BT , the ratio $OG : GT$ increases continually, while, as shown, $PF : BG$ is always $> BM : MO$, and, *a fortiori*,

$$PF : (\text{arc } PB) > BM : MO.$$

That is, (4) is always satisfied for any point Q' of the spiral 'forward' of P , so that (2) is also satisfied, and QQ' is always less than QF .

It will be observed that no *νεῦσις*, and nothing beyond 'plane' methods, is required in the above proof, and Pappus's criticism of Archimedes's proof is therefore justified.

Let us now consider for a moment what Archimedes actually does. In Prop. 8, which he uses to prove our proposition in the 'backward' case (R' , R , F'), he shows that, if $PO : OV$ is any ratio whatever less than $PO : OT$ or $PM : MO$, we can find points F' , G corresponding to any ratio $PO : OV'$ where $OT < OV' < OV$, i.e. we can find a point F' corresponding to a ratio still nearer to $PO : OT$ than $PO : OV$ is. This proves that the ratio $RF' : PG$, while it is always less than $PM : MO$,

approaches that ratio without limit as R approaches P . But the proof does not enable us to say that $RF' : (\text{chord } PR)$, which is $> RF' : PG$, is also always less than $PM : MO$. At first sight, therefore, it would seem that the proof must fail. Not so, however; Archimedes is nevertheless able to prove that, if PV and not PT is the tangent at P to the spiral, an absurdity follows. For his proof establishes that, if PV is the tangent and OF' is drawn as in the proposition, then

$$F'O : RO < OR' : OP,$$

or $F'O < OR'$, 'which is impossible'. Why this is impossible does not appear in Props. 18 and 20, but it follows from the argument in Prop. 13, which proves that a tangent to the spiral cannot meet the curve again, and in fact that the spiral is everywhere concave towards the origin.

Similar remarks apply to the proof by Archimedes of the impossibility of the other alternative supposition (that the tangent at P meets OT at a point U nearer to O than T is).

Archimedes's proof is therefore in both parts perfectly valid, in spite of any appearances to the contrary. The only drawback that can be urged seems to be that, if we assume the tangent to cut OT at a point *very near* to T on either side, Archimedes's construction brings us perilously near to infinitesimals, and the proof may appear to hang, as it were, on a thread, albeit a thread strong enough to carry it. But it is remarkable that he should have elaborated such a difficult proof by means of Props. 7, 8 (including the 'solid' $\nu\epsilon\upsilon\sigma\iota\varsigma$ of Prop. 8), when the figures of Props. 6 and 7 (or 9) themselves suggest the direct proof above given, which is independent of any $\nu\epsilon\upsilon\sigma\iota\varsigma$.

P. Tannery,¹ in a paper on Pappus's criticism of the proof as unnecessarily involving 'solid' methods, has given another proof of the subtangent-property based on 'plane' methods only; but I prefer the method which I have given above because it corresponds more closely to the preliminary propositions actually given by Archimedes.

¹ Tannery, *Mémoires scientifiques*, i, 1912, pp. 300-16.



THIS PAGE IS LOCKED TO FREE MEMBERS

Purchase full membership to immediately unlock this page

FORGOTTEN BOOKS

FULL

MEMBERSHIP

797,885 Books!

All you can read

for only

\$8.99/month

Continue

*Fair usage policy applies



INDEX OF GREEK WORDS

[The pages are those of the first volume except where otherwise stated.]

- ἄβαξ, ἀβάκιον 47.
 ἀγεωμέτρητος, -ον: ἀγεωμέτρητος μη-
 δεις εἰσίτω (Plato) iii. 355.
 ἀδιεξίτητος, -ον, that cannot be gone
 through, i. e. infinite 343.
 ἀδύνατος, -ον ii. 462: ἀπαγωγή εἰς
 ἀδύνατον, &c. 372.
 αἴτημα, postulate 373.
 ἀκουσματικοί 11.
 ἄλογος, -ον, irrational 84, 90: περὶ
 ἀλόγων γραμμῶν καὶ ναστῶν (Demo-
 critus) 156-7, 181: ἄλογοι ὡσπερ
 γραμμαί (Plato) 157.
 ἀνάλημμα ii. 287.
 ἀνάλογον, proportional: used as ad-
 jective 85.
 ἀναλυόμενος (τόπος), *Treasury of*
Analysis 421-2, ii. 399, 400, ii.
 426.
 ἀνάπαλιν, inversely 385: ἀνάπαλιν
 λύσις ii. 400.
 ἀναστρέψαντι (ἀναστρέφω), *conver-*
tendo 386.
 ἀναστροφή, conversion *ib.*
 ἀναστροφικός (τόπος), a class of locus
 ii. 185.
 Ἄναφορικός by Hypsicles 419, ii. 213.
 ἀνελίπτειν ii. 244.
 ἄξων, axis 341.
 ἀόριστος, -ον, undefined: πλῆθος μο-
 νίδων ἀόριστον (= unknown, x)
 94, ii. 456: ἐν ἀορίστῳ ii. 489, 491.
 ἀπαγωγή, reduction 372: ἀπ. εἰς
 ἀδύνατον, *reductio ad absurdum*
 372.
 ἀπόδειξις, proof 370, ii. 533.
 ἀποκαταστατικός, -ή, -όν, recurring 108.
 ἀπόστασις, distance or *dimension*
 305 n., or *interval* 306 n.
 ἄρβηλος, 'shoemaker's knife' ii. 23,
 ii. 101-2, ii. 371-7.
 ἀριθμητική, theory of numbers, opp.
 to λογιστική 13-16.
 ἀριθμητικός, -ή, -όν: ἀριθμητικὴ εἰσα-
 γωγή of Nicomachus 97.
 ἀριθμός, number: definitions of
 'number' 69-70: in Diophantus,
 used for unknown quantity (x)
 94, ii. 456.
 ἀριθμοστόν: reciprocal of ἀριθμός
 (= x) in Diophantus ii. 458.
 ἀρπεδονάπται, 'rope-stretchers' 121-
 2, 178.
 ἄρρητος, -ον, irrational 157.
 ἀρτιάκις ἄρτιος, *even-times-even* 71,
 with Neo-Pythagoreans = 2^n , 72.
 ἀρτιάκις περιττός, *even-times-odd* 72.
 ἀρτιοπέριτος, *even-odd*, restricted
 by Neo-Pythagoreans to form
 $2(2m+1)$, 72.
 ἄρτιος, -α, -ον, even 70.
 Ἄρχαί, a lost work of Archimedes
 ii. 81.
 Ἄστροθεσίαι of Eratosthenes ii. 109.
 ἀστρολάβον ὄργανον of Hipparchus
 ii. 256.
 ἀσύμμετρος, -ον, incommensurable
 157.
 ἀσύμπτωτος, -ον, non-secant ii. 227.
 ἀσύνθετος, -ον, incomposite 72.
 ἄτομος, -ον, indivisible 181: Aristot-
 elian περὶ ἀτόμων γραμμῶν 157,
 346-8.
 ἄτοπος, -ον, absurd ii. 462.
 αὐξάνειν: τρις αὐξηθεῖς (Plato) 306-7.
 αὐξή, τρίτη, 297: κύβων αὐξή, 297.
 αὐξησις 305-6 n.
 αὐτοματοποιητική ii. 308.
 ἀψίς, segment of circle less than a
 semicircle ii. 314.
 Βαρουλκός of Heron ii. 309, ii. 346-7.
 Βελοποιϊκά of Heron 18, ii. 298, ii.
 302, ii. 308-9.
 βιάζειν: βεβιασμένος, forced or un-
 natural ii. 362.

- βωμίσκος, 'little altar', properly a wedge-shaped solid ii. 319, ii. 333: measurement of (Heron), ii. 332-3: (= σφηνίσκος) of a certain kind of solid number 107, ii. 240, ii. 315.
- γεωδυσία = mensuration 16.
Γεωμέτρουμενα of Heron ii. 318, ii. 453.
- γλωχίς (arrow-head), Pythagorean name for angle 166.
- γωνονική 18.
- γνώμων, *gnomon*, q.v.: κατὰ γνώμονα = perpendicular 78, 175.
- γνώριμος, -ον, known: γνώριμον, an alternative term for δεδομένον, given ii. 537.
- γνωρίμως, 'in the recognized manner' ii. 79.
- γράμμα, 'figure' or proposition, of theorem of Eucl. I. 47, 144.
- γραμμή: διὰ οὐ ἐκ τῶν γραμμῶν of theoretical proof ii. 257, 258.
- γραμμικός, -ή, -όν, linear: used of prime numbers 73: γραμμικαὶ ἐπιστάσεις, 'Considerations on Curves', by Demetrius ii. 359: γραμμικῶς, graphically 93.
- γράφειν, to draw or write on 159, 173: also to prove 203 n., 339.
- δεδομένος, -η, -ον, given: senses of, ii. 537-8.
- δεικνύειν, to prove 328.
- δεῖν: δεῖ δὴ 371.
- δεύτερος, secondary: of composite numbers 72: δευτέρα μυριάς (= 10,000²) 40.
- διαβήτης, compasses 308, ii. 540.
- διαιρεῖν: διελόντι, *separando* or *dividendo* (in transformation of ratios) 386.
- διαίρεσις: λόγου, separation of a ratio 386: περὶ διαιρέσεων βιβλίον, *On divisions (of figures)*, by Euclid 425.
- διάστασις, dimension: περὶ διαστάσεως, a work of Ptolemy ii. 295.
- διάστημα, interval 215: distance 239.
- δίαιλος, 'race-course': representations of square and oblong numbers as sums of terms 114.
- διδόναι: δεδομένον, given, senses ii. 537-8.
- διεξοδικὸς (τόπος), a species of locus ii. 185.
- διίσταναι: ἐφ' ἐν διεστῶς, extended one way ii. 428.
- δικόλουρος, -ον, twice-truncated 107.
- δίοπτρα, dioptra, q.v.
- διοπτρική 18.
- διορίζειν: διορισμένη τομή, *Determinate Section*, by Apollonius ii. 180.
- διορισμός, definition, delimitation: two senses (1) a constituent part of a theorem or problem 370, (2) a statement of conditions of possibility of a problem 303, 319-20, 371, 377, 395, 396, 428, ii. 45-6, ii. 129-32, ii. 168, ii. 230.
- διπλοῖσότης, double-equation (Diophantus) ii. 468.
- διπλοῦς, -ῆ, -οῦν: διπλῆ μυριάς = 10,000² (Apollonius) 40: διπλῆ ἰσότης, διπλῆ ἴσωσις, double-equation (Diophantus) ii. 468.
- δοκίς, beam, a class of solid number 107, ii. 240.
- δοκός = δοκίς ii. 315.
- δραχμή, sign for, 31, 49, 50.
- δύναμις: incommensurable side of square containing a non-square number of units of area 203-4: square or square root 209 n., 297: square of unknown quantity (= x^2) (Diophantus) ii. 457-8: δυνάμει, 'in square' 187, 308: τετραπλῆ δύναμις = eighth power (Egypt) ii. 546; power in mechanics 445.
- δυναμοδύναμις, square-square = fourth power (Heron) ii. 458: fourth power of unknown (Diophantus) ii. 458, ii. 546.
- δυναμόκυβος, square-cube, = fifth power of unknown (Diophantus) ii. 458.
- δυναμοστόν, δυναμοδυναμοστόν, &c., reciprocals of powers of unknown (Diophantus) ii. 458.
- δύνασθαι, to be equivalent 'in square' to, i.e. to be the side of a square equal to (a given area): δυναμένη 305-6 n.
- δυναστευομένη, opp. to δυναμένη 305-6 n.
- εἶδος, 'figure' of a conic ii. 139: 'species' = particular power

- of unknown, or term, in an equation (Diophantus) ii. 460.
- εἷς, μία, ἓν, one : ἕνα πλείω, 'several ones' (definition of 'number') 70.
- εἰσηγεῖσθαι, to introduce or explain 213.
- ἔκθεσις, *setting-out* 370, ii. 533.
- Ἐκπετάσματα of Democritus 178, 181.
- ἐκτήμορος (κύκλος) ii. 288.
- ἔλλειψις, *falling-short* (in application of areas), name given to *ellipse* by Apollonius 150, ii. 138.
- ἔλλιπής, -ές, *defective* (of numbers), contrasted with *perfect* 74, 101 : Ψ ἔλλιπὲς κάτω νεῦον ii. 459.
- ἐναλλάξ, *alternately* (in proportions) 385.
- ἔννοια, *notion* : κοινὰ ἔννοιαί, *common notions* = *axioms* 336.
- ἔνστασις, *objection* 372, ii. 311, ii. 533.
- ἔντασις, *bulging out* 6.
- ἐξελιγμός ii. 234.
- ἐξήγησις, *elucidation* ii. 223, ii. 231-2.
- ἐξηκοστόν, or πρῶτον ἐξ., a 60th (= a *minute*), δεύτερον ἐξ., a *second*, &c. 45.
- ἐπάνθημα, ('*bloom*') of Thymaridas : a system of linear equations solved 94.
- ἐπαφή, *contact* : Ἐπαφαί, *Contacts or Tangencies*, by Apollonius ii. 181.
- ἐπί, on : τὸ σημεῖον ἐφ' ᾧ (or οὗ) K, *archaic* for 'the point K' 199 : ἡ ἐφ' ἧ AB, 'the straight line AB' *ib.*
- ἐπιμερίς, *superpartiens*,
 = ratio $1 + \frac{\quad}{m+n}$, 102.
- ἐπιμόριος, *superparticularis* = ratio of form $(n+1)/n$, 90, 101 : ἐπιμόριον διάστημα 215.
- ἐπιπεδομετρικά ii. 453.
- ἐπισημασίαι, *weather indications* 177 n., ii. 234.
- ἐπίτριτος = ratio 4/3, 101 : ἐπίτριτος πυθμίν (Plato) 306-7.
- ἔσχατος : τὰ ἔσχατα, *extremities* 293.
- ἑτερομήκης, -ες, *oblong* ; of numbers of form $m(m+1)$, 82, 108.
- εὐθυγραμμικὸς (ἀριθμὸς) = *prime* 72.
- ἐφεκτικός, a class of locus ii. 185, ii. 193.
- ἐφόδιον, *Method* ii. 246.
- ζυγόν, *lever or balance* : περὶ ζυγῶν, a work of Archimedes ii. 23-4, ii. 351.
- ἡμιόλιος, -α, -ον, ratio of 3/2, 101.
- ἡμιωβέλιον, $\frac{1}{2}$ -obol, sign for, 31, 49, 50.
- θαυματοποιϊκή 18.
- θεολογούμενα ἀριθμητικῆς 97.
- θέσις, *position* : παρὰ θέσει (sc. δεδομένην), parallel to a straight line given in position ii. 193 : πρὸς θέσει εὐθείαις, on straight lines given in position ii. 426.
- θυρεός, *shield*, old name for ellipse 439, ii. 111, ii. 125.
- ἴλλεσθαι : ἴλλομένην used by Plato of the earth 314-15.
- ἰσάκις ἴσος, equal an equal number of times, or equal multiplied by equal 204.
- ἰσόμετρος, -ον, of equal contour : περὶ ἰσομέτρων σχημάτων, by Zenodorus ii. 207, ii. 390.
- ἰσόπλευρος, -ον, *equilateral* : of square number (Plato) 204.
- ἰσορροπία, *equilibrium* : περὶ ἰσορροπιῶν, work by Archimedes ii. 24, ii. 351.
- ἴσος, equal : δι' ἴσου, *ex aequali* (in proportions) 386 : δι' ἴσου ἐν τετραγμείῃ ἀναλογία 386.
- ἰσότης or ἴσωσις, *equation* ii. 468.
- ἰστορία, *inquiry*, Pythagoras's name for geometry 166.
- ἰσχὺς, *power* (in mechanics) 445.
- καμπτήρ, *turning-point* in race-course 114.
- καμπύλος, -η, -ον, *curved* 249, 341.
- κανονική, *Canon*, q. v.
- κανών, *ruler* 239 : *Table* (astron.), Προχείρων κανόνων διάτασις καὶ ψηφοφορία, work by Ptolemy ii. 293 : *canon* (in music), v. Κατατομή.
- καταγράφειν : to *inscribe in or on* (c. gen.) 131.
- Κατάλογοι, work by Eratosthenes ii. 108.
- κατασκευάζειν 193 n.
- κατασκευή, *construction* (constituent part of proposition) 370, ii. 533.



THIS PAGE IS LOCKED TO FREE MEMBERS

Purchase full membership to immediately unlock this page

DELVE INTO FANTASY, MAGIC, MYTHOLOGY & FOLKLORE

Forgotten Books'
Full Membership gives
access to 797,885 ancient
and modern, fiction and
non-fiction books.

Continue

*Fair usage policy applies

νύσσα, goal or end of race-course
114.

ὀβολός, obol : sign for, 31, 49, 50.

Ὀλυμπιονίκαι, work by Eratosthenes
ii. 109.

ὄνυξ, a wedge-shaped figure ii. 319,
ii. 333.

ὄργανοποιική 18.

ὄρθιος, -α, -ον, right or perpendi-
cular : ὀρθία πλευρά, *latus rectum*
ii. 139 : ὀρθία διάμετρος, 'erect
diameter', in double hyperbola,
ii. 134.

ὀρίζειν : ὀρισμένος, defined, i. e. de-
terminate 94, 340.

ὀρίζων (κύκλος), dividing circle :
horizon (Eucl.) 351, 352.

ὄρος, (1) definition 373 : (2) limit
or boundary 293 : (3) *term* (in a
proportion) 306 n.

οὐδεμία or οὐδέν, sign for (O), 39, 45.

πᾶ βῶ καὶ κινῶ τὰν γᾶν, saying of
Archimedes ii. 18.

παρ' ἣν δύνανται (αἱ καταγόμεναι τεταγ-
μένως), expression for *parameter*
of ordinates ii. 139.

παραβολή, application : π. τῶν χωρίων,
application of areas 150 : τὰ ἐκ
τῆς παραβολῆς γινόμενα σημεῖα, the
foci of a central conic, ii. 156 :
parabola (the conic) 150, ii. 138.

Παραδοξογράφοι ii. 541.

παράδοξος γραμμή, paradoxical curve
(of Menelaus) ii. 260-1, ii. 360.

παράπηγμα 177, ii. 234.

παρασπᾶν, to pull awry : παρεσπα-
σμένος ii. 398.

παρισότης, nearness to equality, ap-
proximation : παρισότητος ἀγωγή
(Diophantus) ii. 477, ii. 500.

πέλεκυς, axe-shaped figure ii. 315.

πεμπάζειν, to 'five' (= count) 26.

πένταθλος 176, ii. 104.

περαίνουσα ποσότης = unit, 69.

πέρας, limit or extremity 293 :
limiting surface 166 : πέρας συγ-
κλείων, definition of figure ii. 221.

περισσάρτιος, *odd-even* : with Neo-
Pythagoreans is of form

$$2^{n+1} (2m+1), 72.$$

περισσός, -ή, -όν, *odd*, q.v.

πεττεία 19.

πηλίκος, -η, -ον, how great (of mag-
nitude) 12.

πηλικότης, size 384.

πλάγιος, -α, -ον, transverse : πλαγία
διάμετρος or πλευρά ii. 139.

πλασματικός, -όν, (easily) formable
ii. 487.

Πλατωνικός, a work by Eratosthenes
ii. 104.

πλήθος, multitude : πλήθος ἓν = unit,
69 : πλήθος ὠρισμένον = number,
70 : πλήθος μονάδων ἀόριστον, def.
of unknown 'quantity' 94, ii.
456.

πλινθίς, a brick, a solid number of
a certain form 107, ii. 240, ii.
315.

πολλαπλασιεπιμερής, *multiplex super-*
partiens, = ratio of form

$$p + \frac{m}{m+n}, 103.$$

πολλαπλασιεπιμόριος, *multiplex su-*
perparticularis, = ratio of form

$$m + \frac{1}{n}, 103.$$

πολλαπλάσιος, -α, -ον, multiple 101.

πολύσπαστος, a compound pulley ii.
18.

πόριμος, -ον (πορίζειν), procurable :
one sense of δεδομένος ii. 538.

πόρισμα, *porism* : (1) = corollary,
(2) a certain type of proposition
372-3, ii. 533.

ποσόν, quantity, of number, 12.

ποσότης, quantity 69, 70 : number
defined as ποσότητος χύμα ἐκ μονά-
δων συγκεείμενον 70.

προμήκης, *prolate* (= oblong) 203 :
but distinguished from ἑτερομήκης
83, 108.

προσαγωγίον 309.

πρότασις = *enunciation* 370, ii.
533.

πρῶτος, *prime* 72.

πτῶσις, *case* 372.

πυθμήν, base ; = digit 55-7, 115-17 :
ἐπίτριτος πυθμήν 306-7.

πυραμῖς, *pyramid* 126.

πύρειον, πύριον, burning mirror :
περὶ πυρείων, work by Diocles
264, ii. 200 ; περὶ τοῦ πυρίου, by
Apollonius ii. 194.

ῥητός, -ή, -όν, *rational* : used in sense
of 'given' ii. 537.

ῥοπή : περὶ ῥοπῶν, a mechanical
work by Ptolemy ii. 295.

- σάλινον of Archimedes ii. 23, ii. 103.
- σήκωμα 49.
- σκάφη, a form of sun-dial ii. 1, ii. 4.
- σκηνογραφική, scene-painting 18, ii. 224.
- Σοφία, nickname of Democritus 176.
- σπίρα, *spire* or *tore* ii. 117: varieties of (διεχής, συνεχής, ἐμπεπλεγμένη or ἐπαλλάττουσα), ii. 204.
- στάθμη, plumb-line 78, 309.
- στατήρ, sign for, 31.
- στερεομετρία, solid geometry 12-13.
- στερεομετρούμενα ii. 453.
- στηλίς, column, a class of solid number, 107.
- στιγμή, point 69: στιγμή ἄθετος = unit, 69.
- στοιχειώτης, -ός, the writer of Elements (στοιχείον), used of Euclid 357.
- στρογγύλος, -ον, round or circular 293.
- συμπέρασμα, *conclusion* (of proposition) 370, ii. 533.
- σύνθεσις (λόγου), composition (of a ratio) 385.
- σύνταξις, collection: Μεγάλη σύνταξις of Ptolemy 348, called Μαθηματικὴ σύνταξις ii. 273.
- συντιθέναι: συνθέντι = *componendo* (in proportion) 385.
- σύστασις, construction 151, 158.
- σφαιρικός, -ή, -όν, spherical: used of cube numbers ending in 5 or 6, 107-8.
- σφγκίσκος, *stake*, a form of solid number, 107.
- σφηνίσκος, *wedge*, a solid of a certain form, measurement of, ii. 332-3: a solid number, 107, ii. 315, ii. 319.
- σχέσις, relation 384.
- σχηματοποιεῖν, to form a figure ii. 226.
- Τάλαντον, sign for (Τ); 31, 50.
- ταράσσειν: (δι' ἴσου) ἐν τεταραγμένη ἀναλογία, *in disturbed proportion* 386.
- τίσσειν: τεταγμένον, *assigned* = *datum* ii. 192, ii. 537: αἱ καταγόμεναι τεταγμένως (εὐθείαι), (straight lines) drawn *ordinate-wise* = *ordinates* ii. 139: τεταγμένως κατῆχθαι ii. 134.
- τάχος, speed: περὶ ταχῶν, work by Eudoxus 329.
- τέλειος, -α, -ον, perfect: τέλειος ἀριθμός 74, 101.
- τεταρτημόριον, $\frac{1}{4}$ of obol, sign for, 31, 49, 50.
- τετραγωνίζειν, to square: ἡ τετραγωνίζουσα (γραμμή), the *quadratrix* 225, ii. 359.
- τετραγωνισμός, *squaring* 173.
- τετρακτύς 75, 99 n., 313, ii. 241.
- τετραπλῆ δύναμις = 8th power of unknown (Egyptian term) ii. 546.
- τμήμα, segment: used of lunes as well as segments of circles 184: segments or sectors 187-9: τμήματα = $1/360$ th parts of circumference and $1/120$ th parts of diameter of circle (Ptolemy) 45.
- τομεύς, shoemaker's knife, term for *sector* of circle 381.
- τομή, section: τὰ περὶ τὴν τομήν (Proclus) 324-5.
- τόπος, locus: classifications of loci 218-19, ii. 185: τόποι πρὸς γραμμαῖς, τόποι πρὸς ἐπιφανείαις (-α) 218-19, 439: τόποι πρὸς μεσότητος ii. 105: τόπος ἀναλυόμενος, *Treasury of Analysis*, q. v.
- τόρνος, circle-drawer 78, 308.
- τρίγωνος ἀριθμός, triangular number, 15-16.
- τρικόλουρος, thrice-truncated 107.
- τρίπλευρον, *three-side*, Menelaus's term for spherical triangle ii. 262.
- τριώβολον, sign for, 49.
- ὔδρια ὠροσκοπεῖα, water-clocks ii. 309.
- ὑπαρξίς, forthcoming: *positive* term, dist. from negative (λείψις) ii. 459.
- ὑπεπιμερής, *subsuperpartiens*, reciprocal of ἐπιμερής 102.
- ὑπεπιμόριος, *subsuperparticularis*, reciprocal of ἐπιμόριος 101.
- ὑπερβολή, *exceeding* (in application of areas): name given to *hyperbola* 150, ii. 138.
- ὑπερτέλειος, ὑπερτελής, *over-perfect* (number) 74, 100.
- ὑποθέσεις τῶν πλανωμένων, work by Ptolemy ii. 293.
- ὑποπολλαπλάσιος, ὑποπολλαπλασιεπι-

- μερῆς, ὑποπολλαπλασιεπιμόριος, &c. 101-3.
- ὑποτείνειν, subtend 193 n.
- ὑσπληξ, starting-point (of race-course) 114.
- Φάσεις ἀπλανῶν ἀστέρων, work by Ptolemy, ii. 293.
- φιαλίτης (ἀριθμός), (number) of bowls (in simple algebraical problems) 14, ii. 442.
- φιλοκαλία, by Geminus ii. 223.
- χαλκοῦς ($\frac{1}{3}$ th of obol), sign for, 31 : 48, 50.
- χείρ, *manus*, in sense of number of men 27.
- χειροβάλλιστρα ii. 309.
- χρoιά, colour or skin: Pythagorean name for surface 166, 293.
- Χρονογραφίαι, work by Eratosthenes ii. 109.
- χρῶμα, colour (in relation to surface) 293.
- χωρίον, area 300 n.: χωρίου ἀποτομή, *sectio spatii*, by Apollonius ii. 179.
- Ψηφοφορία κατ' Ἰνδοῦς ii. 546.
- Ὠκυτόκιον of Apollonius 234, ii. 194, ii. 253.



THIS PAGE IS LOCKED TO FREE MEMBERS

Purchase full membership to immediately unlock this page

FORGOTTEN BOOKS

FULL

MEMBERSHIP

797,885 Books!

All you can read

for only

\$8.99/month

Continue

*Fair usage policy applies



Anthemius of Tralles 243, ii. 194, ii. 200-3, ii. 518, ii. 540, ii. 541-3.

Antiphon 184, 219, 221-2, 224, 271.

Āpastamba-Sūtra 145-6.

Apelt, E. F. 330.

Apelt, O. 181 *n.*, 182.

Apices 47.

Apollodorus, author of *Chronica*, 176.

Apollodorus ὁ λογιστικός: distich of, 131, 133, 134, 144, 145.

Apollonius of Perga ii. 1, ii. 126.

Arithmetic: ὠκυτόκιον 234, ii. 194, ii. 253 (approximation to π , *ib.*), 'tetrads' 40, continued multiplications 54-7.

Astronomy ii. 195-6: A. and Tycho Brahe 317, ii. 196: on epicycles and eccentrics ii. 195-6, ii. 243: trigonometry ii. 253.

Conics ii. 126-75: text ii. 126-8, Arabic translations ii. 127, prefaces ii. 128-32, characteristics ii. 132-3: conics obtained from oblique cone ii. 134-8, prime property equivalent to Cartesian equation (oblique axes) ii. 139, new names, *parabola*, &c. 150, 167, ii. 138, transformation of coordinates ii. 141-7, tangents ii. 140-1, asymptotes ii. 148-9, rectangles under segments of intersecting chords ii. 152-3, harmonic properties ii. 154-5, focal properties (central conics) ii. 156-7, normals as maxima and minima ii. 159-67, construction of normals ii. 166-7, number of normals through point ii. 163-4, propositions giving evolute ii. 164-5.

On contacts ii. 181-5 (lemmas to, ii. 416-17), three-circle problem ii. 182-5.

Sectio rationis ii. 175-9 (lemmas to, ii. 404-5).

Sectio spatii ii. 179-80, ii. 337, ii. 339.

Determinate section ii. 180-1 (lemmas to, ii. 405-12).

Comparison of dodecahedron and icosahedron 419-20, ii. 192.

Duplication of cube 262-3, ii. 194.

'General treatise' ii. 192-3, ii. 253: on Book I of Euclid 358.

νεύσεις ii. 68, ii. 189-92 (lemmas to, ii. 412-16), rhombus-problem ii. 190-2, square-problem ii. 412-13.

Plane Loci ii. 185-9 (lemmas to, ii. 417-19).

On cochlias 232, ii. 193, 'sister of cochloid' 225, 231-2, *On irrationals* ii. 193, *On the burning-mirror* ii. 194, ii. 200-1.

Application of areas 150-3: method attributed to Pythagoras 150, equivalent to solution of general quadratic 150-2, 394-6.

Approximations to $\sqrt{2}$ (by means of 'side-' and 'diameter-' numbers) 91-3, (Indian) 146: to $\sqrt{3}$ (Ptolemy) 45, 62-3, (Archimedes) ii. 51-2: to π 232-5, ii. 194, ii. 253: to surds (Heron) ii. 323-6, cf. ii. 547-9, ii. 553-4: to cube root (Heron) ii. 341-2.

Apuleius of Madaura 97, 99.

Archibald, R. C. 425 *n.*

Archimedes 3, 52, 54, 180, 199, 202, 203 *n.*, 213, 217, 224-5, 229, 234, 272, ii. 1.

Traditions ii. 16-17, engines ii. 17, mechanics ii. 18, general estimate ii. 19-20.

Works: character of, ii. 20-2, works extant ii. 22-3, lost ii. 23-5, 103; text ii. 25-7, MSS. ii. 26, editions ii. 27: *The Method* ii. 20, 21, 22, 27-34, ii. 246, ii. 317-18: *On the Sphere and Cylinder* ii. 34-50: *Measurement of a circle* ii. 50-6, ii. 253: *On Conoids and Spheroids* ii. 56-64: *On Spirals* 230-1, ii. 64-75 (cf. ii. 377-9), ii. 556-61: *Sand-reckoner* ii. 81-5: *Quadrature of Parabola* ii. 85-91: mechanical works, titles ii. 23-4, *Plane equilibriums* ii. 75-81: *On Floating Bodies* ii. 91-7, problem of crown ii. 92-4: *Liber assumptorum* ii. 101-3: Cattle-problem 14, 15, ii. 23, ii. 97-8, ii. 447: *Catoptrica* 444, ii. 24.

Arithmetic: octads 40-1, fractions 42, value of π 232-3, 234, ii. 50-6: approximations to $\sqrt{3}$ ii. 51-2.

Astronomy ii. 17-18, sphere-

- making ii. 18, on Aristarchus's hypothesis ii. 3-4.
- Conics, propositions in, 438-9, ii. 122-6.
- Cubic equation solved by conics ii. 45-6.
- On Democritus 180, 327, equality of angles of incidence and reflection ii. 353-4, integral calculus anticipated ii. 41-2, 61, 62-3, 74, 89-90: Lemma or Axiom of A. 326-8, ii. 35: *νεύσεις* in, ii. 65-8 (Pappus on, ii. 68): on semi-regular solids ii. 98-101: triangle, area in terms of sides ii. 103: trisection of any angle 240-1.
- Archytas 2, 170, 212-16, ii. 1: on *μαθήματα* 11, on *logistic* 14, on 1 as odd-even 71: on means 85, 86: no mean proportional between n and $n+1$, 90, 215: on music 214: mechanics 213: solution of problem of two mean proportionals 214, 219, 245, 246-9, 334, ii. 261.
- Argyrus, Isaac, 224 *n.*, ii. 555.
- Aristaeus: comparison of five regular solids 420: *Solid Loci* (conics) 438, ii. 116, 118-19.
- Aristaeus of Croton 86.
- Aristarchus of Samos 43, 139, ii. 1-15, ii. 251: date ii. 2: *σκάφη* of, ii. 1: anticipated Copernicus ii. 2-3: other hypotheses ii. 3, 4: treatise *On sizes and distances of Sun and Moon* ii. 1, 3, 4-15, trigonometrical purpose ii. 5: numbers in, 39: fractions in, 43.
- Aristonophus, vase of, 162.
- Aristophanes 48, 161, 220.
- Aristotelian treatise on indivisible lines 157, 346-8.
- Aristotherus 348.
- Aristotle 5, 120, 121: on origin of science 8: on mathematical subjects 16-17: on first principles, definitions, postulates, axioms 336-8.
- Arithmetic: reckoning by tens 26-7, why 1 is odd-even 71: 2 even and prime 73: on Pythagoreans and numbers 67-9: on the gnomon 77-8, 83.
- Astronomy: Pythagorean system 164-5, on hypothesis of concentric spheres 329, 335, ii. 244, on Plato's view about the earth 314-15.
- On the continuous and infinite 342-3: proof of incommensurability of diagonal 91: on principle of exhaustion 340: on Zeno's paradoxes 272, 275-7, 278-9, 282: on Hippocrates 22: encomium on Democritus 176.
- Geometry: illustrations from, 335, 336, 338-40, on parallels 339, proofs differing from Euclid's 338-9, propositions not in Euclid 340, on quadratures 184-5, 221, 223, 224 *n.*, 271, on quadrature by lunes (Hippocrates) 184-5, 198-9: on Plato and regular solids 159: curves and solids in A. 341.
- Mechanics 344-6, 445-6: parallelogram of velocities 346: 'Aristotle's wheel' ii. 347-8.
- Aristoxenus 24 *n.*, 66.
- Arithmetic (1) = theory of numbers (opp. to *λογιστική*) 13-16: early 'Elements of Arithmetic' 90, 216: systematic treatises, Nicomachus *Introd. Ar.* 97-112, Theon of Smyrna 112-3, Iamblichus, *Comm. on Nicomachus* 113-15, Domninus ii. 538. (2) Practical arithmetic: originated with Phoenicians 120-1, in primary education 19-20.
- Arithmetic mean, defined 85.
- Arithmetica* of Diophantus 15-16, ii. 449-514.
- Arithmetical operations: see Addition, Subtraction, &c.
- Arrow of Zeno 276, 280-1.
- Āryabhaṭṭa 234.
- Asclepius of Tralles 99.
- Astronomy in elementary education 19: as secondary subject 20-1.
- Athelhard of Bath, first translator of Euclid 362-4.
- Athenaeus 144, 145.
- Athenaeus of Cyzicus 320-1.
- 'Attic' (or 'Herodianic') numerals 30-1.
- August, E. F. 299, 302, 361.
- Autolycus of Pitane 348: works *On the moving Sphere* 348-52, *On Risings and Settings* 352-3: relation to Euclid 351-2.
- Auverus, C. ii. 26.
- Axioms: Aristotle on, 336 =: *Common Notions* in Euclid 376: Axiom of Archimedes 326-8, ii. 35.

- Babylonians: civilization of, 8, 9: system of numerals 28-9: sexagesimal fractions 29: 'perfect proportion' 86.
- Bachet, editor of Diophantus ii. 454-5, ii. 480.
- Bacon, Roger: on Euclid 367-8.
- Baillet, J. ii. 543.
- Baldi, B. ii. 308.
- Barlaam ii. 324 *n.*, ii. 554-5.
- Barocius ii. 545.
- Barrow, I., edition of Euclid, 369-70: on Book V 384.
- Bathycles 142.
- Bāudhāyana Ś. S. 146.
- Baynard, D. ii. 128.
- Benecke, A. 298, 302-3.
- Benedetti, G. B. 344, 446.
- Bertrand, J. ii. 324 *n.*
- Bessarion ii. 27.
- Besthorn, R. O. 362, ii. 310.
- Billingsley, Sir H. 369.
- Björnbo, A. A. 197 *n.*, 363, ii. 262.
- Blass, C. 298.
- Blass, F. 182.
- Boeckh, A. 50, 78, 315.
- Boëtius 37, 47, 90: translation of Euclid 359.
- Boissonade ii. 538.
- Bombelli, Rafael, ii. 454.
- Borchardt, L. 125, 127.
- Borelli, G. A. ii. 127.
- Bouillaud (Bullialdus) ii. 238, ii. 556.
- Braunmühl, A. von, ii. 268-9 *n.*, ii. 288, ii. 291.
- Breton (de Champ), P. 436, ii. 360.
- Bretschneider, C. A. 149, 183, 324-5, ii. 539.
- Brochard, V. 276-7, 279 *n.*, 282.
- Brougham, Lord, 436.
- Brugsch, H. K. 124.
- Bryson 219, 223-5.
- Burnet, J. 203 *n.*, 285, 314-15.
- Butcher, S. H. 299, 300.
- Buzengeiger ii. 324 *n.*
- Cajori, F. 283 *n.*
- Calculation, practical: the abacus 46-8, addition and subtraction 52, multiplication (i) 52-3 (Russian? 53 *n.*), (Egyptian 53-8, division 58-60, extraction of square root 60-3, of cube root 63-4, ii. 341-2.
- Callimachus 141-2.
- Callippus: Great Year 177: system of concentric spheres 329, 335, ii. 244.
- Cambyses 5.
- Camerarius, Joachim, ii. 274.
- Camerer, J. G. ii. 360.
- Campanus, translator of Euclid 363-4.
- Canonic* = theory of musical intervals 17.
- Cantor, G. 279.
- Cantor, M. 37-8, 123, 127, 131, 135, 182, ii. 203, ii. 207.
- Carpus of Antioch 225, 232, ii. 359.
- Case* (*πρώσις*) 372, ii. 533.
- Cassini ii. 206.
- Casting out nines 115-17, ii. 549.
- Catoptric*, theory of mirrors 18.
- Catoptrica*: treatises by Euclid (?) 442, by Theon (?) 444, by Archimedes 444, and Heron 444, ii. 294, ii. 310, ii. 352-4.
- Cattle-problem of Archimedes 14, 15, ii. 23, ii. 97-8, ii. 447.
- Cavalieri, B. 180, ii. 20.
- Censorinus 177.
- Centre of gravity: definitions ii. 302, ii. 350-1, ii. 430.
- Ceria Aristotelica* ii. 531.
- Chalcidius ii. 242, 244.
- Chaldaeans: measurement of angles by *ells* ii. 215-16: order of planets ii. 242.
- Charmandrus ii. 359.
- Chasles, M. ii. 19, 20: on Porisms 435-7, ii. 419.
- Chords, Tables of, 45, ii. 257, ii. 259-60.
- Chrysippus 179: definition of unit 69.
- Cicero 144, 359, ii. 17, 19.
- Circle: division into degrees ii. 214-15: squaring of, 173, 220-35, Antiphon 221-2, Bryson 223-4, by Archimedes's spiral 225, 230-1, Nicomedes, Dinostratus, and quadratrix 225-9, Apollonius 225, Carpus 225; approximations to π 124, 232-5, ii. 194, ii. 253, ii. 545.
- Cisoid of Diocles 264-6.
- Clausen, Th. 200.
- Cleanthes ii. 2.
- Cleomedes: 'paradoxical' eclipse 6: *De motu circulari* ii. 235-8, 244.
- Cleonides 444.
- Cochlias* 232, ii. 193.



THIS PAGE IS LOCKED TO FREE MEMBERS

Purchase full membership to immediately unlock this page

DELVE INTO FANTASY, MAGIC, MYTHOLOGY & FOLKLORE

Forgotten Books'
Full Membership gives
access to 797,885 ancient
and modern, fiction and
non-fiction books.

Continue

*Fair usage policy applies

- 448: works and editions ii. 448-55: *Arithmetica* 15-16: fractions in, 42-4: notation and definitions ii. 455-61: signs for unknown (x) and powers ii. 456-9, for *minus* ii. 459: methods ii. 462-79: determinate equations ii. 462-5, 484-90: indeterminate analysis ii. 466-76, 491-514: 'Porisms' ii. 449, 450, 451, ii. 479-80: propositions in theory of numbers ii. 481-4: conspectus of *Arithmetica* ii. 484-514: *On Polygonal Numbers* 16, 84, ii. 514-17: '*Moriastica*' ii. 449.
- Dioptra 18, ii. 256: Heron's *Dioptra* ii. 345-6.
- Division: Egyptian method 53, Greek 58-60: example with sexagesimal fractions (Theon of Alexandria) 59-60.
- Divisions (of Figures), On*, by Euclid 425-30: similar problems in Heron ii. 336-40.
- Dodecagon, area of, ii. 328.
- Dodecahedron: discovery attributed to Pythagoras or Pythagoreans 65, 141, 158-60, 162: early occurrence 160: inscribed in sphere (Euclid) 418-19, (Pappus) ii. 369: Apollonius on, 419-20: volume of, ii. 335.
- Domnius ii. 538.
- Dositheus ii. 34.
- Dubem, P. 446.
- Dupuis, J. ii. 239.
- Earth: measurements of, ii. 82, (Eratosthenes) ii. 106-7, (Posidonius) ii. 220.
- Ecliptic: obliquity discovered by Oenopides 174, ii. 244: estimate of inclination (Eratosthenes, Ptolemy) ii. 107-8.
- Ecphantus 317, ii. 2.
- Edfu, Temple of Horus 124.
- Egypt: priests 4-5, 8-9: relations with Greece 8; origin of geometry in, 120-2: orientation of temples 122.
- Egyptian mathematics: numeral system 27-8, fractions 28, multiplication, &c. 14-15, 52-3: geometry (mensuration) 122-8: triangle (3, 4, 5) right-angled 122, 147: value of π 124, 125: measurement of pyramids 126-8: maps (regional) 139: algebra in Papyrus Rhind, &c. ii. 440-1.
- Eisenlohr, A. 123, 126, 127.
- Eisenmann, H. J. ii. 360.
- Elements: as known to Pythagoreans 166-8: progress in, down to Plato 170-1, 175-6, 201-2, 209-13, 216-17: writers of Elements, Hippocrates of Chios 170-1, 201-2, Leon, Theudius 320-1: other contributors to, Leodamas, Archytas 170, 212-13, Theaetetus 209-12, 354, Hermotimus of Colophon 320, Eudoxus 320, 323-9, 354: *Elements* of Euclid 357-419: the so-called 'Books XIV, XV' 419-21.
- Ell*, as measure of angles ii. 215-16.
- Empedocles: on Pythagoras 65.
- Eneström, G. ii. 341-2.
- Enneagon: Heron's measurement of side ii. 259, of area ii. 328-9.
- Epanthema* of Thymaridas (system of simple equations) 94: other types reduced to, 94-6.
- Equations: simple, in Papyrus Rhind, &c. ii. 441: in *epanthema* of Thymaridas and in Iamblichus 94-6: in Greek anthology ii. 441-3: indeterminate, *see* Indeterminate Analysis: *see also* Quadratic, Cubic.
- Eratosthenes ii. 1, 16: date, &c. ii. 104: *sieve* ($\kappa\acute{o}\sigma\kappa\iota\nu\acute{o}\nu$) for finding primes 16, 100, ii. 105: on duplication of cube 244-6, 251, 258-60: the *Platonicus* ii. 104-5: *On Means* ii. 105-6, ii. 359: *Measurement of earth* ii. 106-7, ii. 242, ii. 346: astronomy ii. 107-9: chronology and *Geographica* ii. 109: on *Octaëteris ib.*
- Erycinus ii. 359, 365-8.
- Euclid 2-3, 93, 131: date, &c. 354-6: stories of, 25, 354, 357: relation to predecessors 354, 357: Pappus on, 356-7.
- Arithmetic: classification and definitions of numbers 72-3, 397, 'perfect' numbers 74, 402: formula for right-angled triangles in rational numbers 81-2, 405.
- Conics* 438-9, ii. 121-2, focus-directrix property ii. 119-21: on ellipse 439, ii. 111, ii. 125.

- Data* 421-5, *Divisions* (of figures) 425-30, ii. 336, 339.
- Elements*: text 360-1, Theon's edition 358, 360, ii. 527-8, translation by Boëtius 359, Arabic translations 362, ancient commentaries 358-9, *editio princeps* of Greek text 360, Greek texts of Gregory, Peyrard, August, Heiberg 360-1: Latin translations, Athelhard 362-3, Gherard 363, Campanus 363-4, Commandinus 365: first printed editions, Ratdolt 364-5, Zamberti 365: first introduction into England 363: first English editions, Billingsley, &c. 369-70: Euclid in Middle Ages 365-9, at Universities 368-9: analysis of, 373-419: arrangement of postulates and axioms 361: I. 47, how originally proved 147-9: parallel-postulate 358, 375, ii. 227-30, ii. 295-7, ii. 534: so-called 'Books XIV, XV' 419-21.
- Mechanics 445-6: Music 444-5, *Sectio canonis* 17, 90, 215, 444-5: *Optics* 17-18, 441-4: *Phaenomena* 349, 351-2, 440-1, ii. 249: *Porisms* 431-8, lemmas to, ii. 419-24: *Pseudaria* 430-1: *Surface-Loci* 243-4, 439-40, lemmas to, ii. 119-21, ii. 425-6.
- Eudemus 201, 209, 222: *History of Geometry* 118, 119, 120, 130, 131, 135, 150, 171: on Hippocrates's lunes 173, 182, 183-98: *History of Astronomy* 174, 329, ii. 244.
- Eudoxus 24, 118, 119, 121, 320, 322-4: new theory of proportion (that of Eucl. V. ii) 2, 153, 216, 325-7: discovered method of exhaustion 2, 176, 202, 206, 217, 222, 326, 327-9: problem of two mean proportionals 245, 246, 249-51: discovered three new means 86: 'general theorems' 323-4: *On speeds*, theory of concentric spheres 329-34, ii. 244: *Phaenomena* and *Mirror* 322.
- Eugenius Siculus, Admiral, ii. 293.
- Euler, L. 75 n., ii. 482, ii. 483.
- Euphorbus (= Pythagoras) 142.
- Eurytus 69.
- Eutocius 52, 57-8, ii. 25, ii. 45, ii. 126, ii. 518, ii. 540-1.
- Exhaustion, method of, 2, 176, 202, 217, 222, 326, 327-9: development of, by Archimedes 224, ii. 35-6.
- False hypothesis: Egyptian use ii. 441: in Diophantus ii. 488, 489.
- Fermat, P. 75 n., ii. 20, ii. 185, ii. 454, ii. 480, ii. 481-4: on Porisms 435.
- Fontenelle ii. 556.
- Fractions: Egyptian (submultiples except $\frac{2}{3}$) 27-8, 41: Greek systems 42-4: Greek notation *ib.*: sexagesimal fractions, Babylonian 29, in Greek 44-5.
- 'Friendly' numbers 75.
- Galilei 344, 446.
- Geëponicus, Liber*, 124, ii. 309, ii. 318, ii. 344.
- Geminus 119, ii. 222-34: on arithmetic and logistic 14: on divisions of optics, &c. 17-18: on original steps in proof of Eucl. I 32, 135-6: on parallels 358: attempt to prove parallel-postulate ii. 227-30: on original way of producing the three conics ii. 111: encyclopaedic work on mathematics ii. 223-31: on Posidonius's *Meteorologica* ii. 231-2: *Introduction to Phaenomena* ii. 232-4.
- Geodesy (*γεωδαισία*) = mensuration (as distinct from geometry) 16-17.
- Geometric mean, defined (Archytas) 85: one mean between two squares (or similar numbers), two between cubes (or similar solid numbers) 89-90, 112, 201, 297, 400: no rational mean between consecutive numbers 90, 215.
- 'Geometrical harmony' (Philolaus's name for cube) 85-6.
- Geometry: origin in Egypt 120-2: geometry in secondary education 20-1.
- Georgius Pachymeres ii. 453, ii. 546.
- Gerbert (Pope Sylvester II) 365-7: geometry of, 366: ii. 547.
- Gerhardt, C. J. ii. 360, ii. 547.
- Gherard of Cremona, translator of Euclid and an-Nairīzī 363, 367, ii. 309: of Menelaus ii. 252, ii. 262.

- Ghetaldi, Marino, ii. 190.
 Girard, Albert, 435, ii. 455.
Gnomon: history of term 78-9: gnomons of square numbers 77-8, of oblong numbers 82-3, of polygonal numbers 79: in application of areas 151-2: use by al-Karkhī 109-10: in Euclid 379: sun-dial with vertical needle 139.
 Gomperz, Th. 176.
 Govi, G. ii. 293 *n.*
 Gow, J. 38.
 Great Year, of Oenopides 174-5, of Callippus and Democritus 177.
 Gregory, D. 360-1, 440, 441, ii. 127.
 Griffith, F. Ll. 125.
 Günther, S. ii. 325 *n.*, ii. 550.
 Guldin's theorem, anticipated by Pappus ii. 403.
- Halicarnassus inscriptions 32-3, 34.
 Halley, E., editions of Apollonius's *Conics* ii. 127-8, and *Sectio rationis* ii. 175, 179, of Menelaus ii. 252, ii. 262, of extracts from Pappus ii. 360, of Serenus ii. 519.
 Halma, editor of Ptolemy ii. 274, 275.
 Hammer-Jensen, I. ii. 300 *n.*, ii. 304 *n.*
 Hankel, H. 145, 149, 288, 369, ii. 483.
 Hardy, G. H. 280.
 Harmonic mean (originally 'subcontrary') 85.
Harpodonaptae, 'rope-stretchers' 121-2, 178.
 Hārūn ar-Rashīd 362.
Hau-calculations (Egyptian) ii. 440-1.
 Hecataeus of Miletus 65, 177.
 Heibien, J. L. 233 *n.*
 Heiberg, J. L. 184, 187 *n.*, 188, 192 *n.*, 196-7 *n.*, 315, 361, ii. 203, ii. 309, 310, 316, 318, 319, ii. 519, ii. 535, 543, 553, 555 *n.*
Helceph 111.
 Hendecagon in a circle (Heron) ii. 259, ii. 329.
 Henry, C. ii. 453.
 Heptagon in a circle, ii. 103: Heron's measurement of, ii. 328.
 Heraclides of Pontus 24, ii. 231-2: discovered rotation of earth about axis 316-17, ii. 2-3, and that Venus and Mercury revolve about sun 312, 317, ii. 2, ii. 244.
 Heraclitus of Ephesus 65.
 Heraclitus, mathematician ii. 192, ii. 359, ii. 412.
 Hermannus Secundus ii. 292.
 Hermesianax 142 *n.*, 163.
 Hermodorus ii. 359.
 Hermotimus of Colophon 320-1: *Elements and Loci ib.*, 354.
 'Herodianic' (or 'Attic') numerals 30-1.
 Herodotus 4, 5, 48, 65, 121, 139.
 Heron of Alexandria 121, ii. 198, ii. 259: controversies on date ii. 298-307: relation to Ctesibius and Philon ii. 298-302, to Pappus ii. 299-300, to Posidonius and Vitruvius ii. 302-3, to *agrimensores* ii. 303, to Ptolemy ii. 303-6.
 Arithmetic: fractions 42-4, multiplications 58, approximation to surds ii. 51, ii. 323-6, approximation to cube root 64, ii. 341-2, quadratic equations ii. 344, indeterminate problems ii. 344, 444-7.
 Character of works ii. 307-8: list of treatises ii. 308-10.
 Geometry ii. 310-14, *Definitions* ii. 314-16: comm. on Euclid's *Elements* 358, ii. 310-14: proof of formula for area of triangle in terms of sides ii. 321-3: duplication of cube 262-3.
Metrica ii. 320-43: (1) mensuration ii. 316-35: triangles ii. 320-3, quadrilaterals ii. 326, regular polygons ii. 326-9, circle and segments ii. 329-31: volumes ii. 331-5, *βωμίσκος* ii. 332-3, frustum of cone, sphere and segment ii. 334, *tore* ii. 334-5, five regular solids ii. 335. (2) divisions of figures ii. 336-43, of frustum of cone ii. 342-3.
Mechanics ii. 346-52: on Archimedes's mechanical works ii. 23-4, on centre of gravity ii. 350-1, 352.
Belopoeica 18, ii. 308-9, *Catoptrica* 18, ii. 294, ii. 310, ii. 352-4.
Dioptra ii. 345-6, *Pneumatica* and *Automata* 18, ii. 308, 310.
On Water-clocks ii. 429, ii. 536.
 Heron, teacher of Proclus ii. 529.



THIS PAGE IS LOCKED TO FREE MEMBERS

Purchase full membership to immediately unlock this page

FORGOTTEN BOOKS

FULL

MEMBERSHIP

797,885 Books!

All you can read

for only

\$8.99/month

Continue

*Fair usage policy applies



- Jan, C. 444.
 Joachim Camerarius ii. 274.
 Joachim, H. H. 348 *n.*
 Johannes de Sacrobosco 368.
 Jordanus Nemorarius ii. 328.
 Jourdain, P. E. B. 283 *n.*
- Kahun Papyri 125, 126.
 Kant 173.
 Keil, B. 34-5.
 Kepler ii. 20, ii. 99.
 Köchly, H. A. T. ii. 309.
 Koppa (Q for 90) = Phoenician Qoph 32.
 Kubitschek, W. 50.
- Lagrange ii. 483.
 Laird, A. G. 306 *n.*
 Laplace 173.
 Larfeld, W. 31 *n.*, 33-4.
 Lawson 436.
 Leibniz 279, ii. 20.
Lemma 373, ii. 533.
 Leodamas of Thasos 120, 170, 212, 291, 319.
 Leon 319.
 Leon (of Constantinople) ii. 25.
 Leonardo of Pisa 367, 426, ii. 547.
 Lepsius, C. R. 124.
 Leucippus 181.
 Libri, G. ii. 556.
 'Linear' (of numbers) 73.
 'Linear' loci and problems 218-19.
 Lines, classification of, ii. 226.
 Livy ii. 18.
 Loci: classification of, 218-19, plane, solid, linear 218: loci on surfaces 219: 'solid loci' ii. 116-19.
 Loftus, W. K. 28.
 Logistic (opp. to 'arithmetic'), science of calculation 13-16, 23, 53.
Logistica speciosa and numerosa (Vieta) ii. 456.
 Loria, G. iv-v, 350 *n.*, ii. 293 *n.*
 Luca Paciolo 367, ii. 324 *n.*
 Lucas, E. 75 *n.*
 Lucian 75 *n.*, 77, 99, 161, ii. 18.
 Lucretius 177.
- Magic squares ii. 550.
 Magnus, *Logistica* 234-5.
 Mamercus or Mamertius 140, 141, 171.
 al-Ma'mūn, Caliph 362.
 al-Mansūr, Caliph 362.
- Manus*, for number 27.
 Marinus 444, ii. 192, ii. 537-8.
 Martianus Capella 359, 365.
 Martin, T. H. ii. 238, ii. 546.
 Maslama b. Ahmad al-Majrītī ii. 292.
 Massalia 8.
 Mastaba tombs 128.
 Mathematics: meaning 10-11, classification of subjects 11-18: branches of applied mathematics 17-18: mathematics in Greek education 18-25.
 Maurolycus ii. 262.
 Means: arithmetic, geometric, and subcontrary (harmonic) known in Pythagoras's time 85: defined by Archytas *ib.*: fourth, fifth, and sixth discovered, perhaps by Eudoxus 86, four more by Myonides and Euphranor 86: ten means in Nicomachus and Pappus 87-9, Pappus's propositions 88-9: no rational geom. mean between successive numbers (Archytas) 90, 215.
 Mechanics, divisions of, 18: writers on, Archytas 213, Aristotle 344-6, 445-6, Archimedes ii. 18, ii. 23-4, ii. 75-81, Ptolemy ii. 295, Heron ii. 346-52, Pappus ii. 427-34.
 Megethion ii. 360.
 Memus, Johannes Baptista, ii. 127.
 Menaechmus 2, 25, 251-2, 320-1: discoverer of conic sections 251-3, ii. 110-16: solved problem of two mean proportionals 245, 246, 251-5: on 'problems' 318.
 Menelaus of Alexandria ii. 198, ii. 252-3: date, &c. ii. 260-1: Table of Chords ii. 257: *Sphaerica* ii. 261-73: Menelaus's theorem ii. 266-8, 270: anharmonic property ii. 269: *παράδοξος* curve ii. 260-1.
Mensa Pythagorea 47.
 Mensuration: in primary education 19: in Egypt 122-8: in Heron ii. 316-35.
 Meton 220.
 Metrodorus ii. 442.
 Minus, sign for, in Diophantus ii. 459-60.
 Mochus 4.
 Moschopoulos, Manuel, ii. 549-50.
 Muhammad Bagdadinus 425.
 Multiplication: Egyptian method

- 52-3, Greek 53-4, 'Russian' 53 *n.*: examples from Eutocius, Heron, Theon 57-8: Apollonius's continued multiplications 54-7.
 Multiplication Table 53.
Murrān, an angular measure ii. 215.
 Musical intervals and numerical ratios 69, 75-6, 85, 165.
 Myriads, 'first', 'second', &c., notation for, 39-40.
- Nagl, A. 50.
 an-Nairīzī: comm. on Euclid 363, ii. 224, ii. 228-30, ii. 309-10.
 Naṣīraddīn aṭ-Ṭūsī: version of Euclid 362, of Apollonius's *Conics* ii. 127: of Ptolemy ii. 275.
 Naucratis inscriptions 33.
 Nemesius 441.
 Neoclides 319.
Ner (Babylonian) (= 600) 28, ii. 215.
 Nesselmann, G. H. F. ii. 450-1, ii. 455-6.
 Newton 370, ii. 20, ii. 182.
 Nicolas Rhabdas 40, ii. 324 *n.*, ii. 550-3.
 Nicomachus of Gerasa 12, 69, 70, 72, 73, 74, 76, 83, 85, 86, ii. 238, ii. 515: works of, 97: *Introductio arithmetica*: character of treatise 98-9, contents 99-112, classification of numbers 99-100: on 'perfect' numbers 74, 100-1: on ten means 87: on a 'Platonic' theorem 297: sum of series of natural cubes 109-10.
 Nicomedes 225-6, ii. 199: cochloids or conchoids 238-40: duplication of cube 260-2.
 Niloxenus 129.
 Nine, rule of, 115-16: casting out nines ii. 549.
 Nipsus, M. Junius, 132.
 Nix, L. ii. 128, 131, ii. 309.
 Noël, G. 282.
 Number: defined, by Thales 69, by Moderatus, Eudoxus, Nicomachus, Aristotle 70: classification of numbers 70-4: 'perfect', 'over-perfect' and 'defective' numbers 74-5, 'friendly' 75, figured 76-9: 'oblong', 'prolate' 82-3, 108, 114, similar plane and solid numbers 81-2, 90, solid numbers classified 106-8: 'the number in the heaven' (Pythagorean) 68, 'number' of an object 69.
 Numerals: systems of, decimal, quinary, vigesimal 26: origin of decimal system 26-7: Egyptian 27-8; Babylonian systems (1) decimal 28, (2) sexagesimal 28-9: Greek (1) 'Attic' or 'Herodianic' 30-1: (2) alphabetic system, original in Greece 31-7, how evolved 31-2, date of introduction 33-5, mode of writing 36-7, comparison of two systems 37-9: notation for large numbers, Apollonius's tetrads 40, Archimedes's octads 40-1.
 Nymphodorus 213.
 'Oblong' numbers 82-3, 108, 114: gnomons of, 82-3.
 Ocreatus, 111.
 Octads, of Archimedes 40-1.
 Octagon, regular, area of, ii. 328.
 Octahedron 159, 160, 162: volume of, ii. 335.
 'Odd' number defined 70-1: 1 called 'odd-even' 71: 'odd-even', 'odd-times-odd', &c., 'numbers' 71-4.
 Oenopides of Chios 22, 121: discovered obliquity of ecliptic 138, 174, ii. 244: Great Year of, 174-5: called perpendicular *gnomon-wise* 78, 175: two propositions in elementary geometry 175.
 Olympiodorus 444.
 One, the principle of number 69.
 Oppermann ii. 324 *n.*
 Optics: divisions of, 17-18: of Euclid' 441-4: of Ptolemy ii. 293-4.
 Oval of Cassini ii. 206.
 Oxyrhynchus Papyri 142.
- Pamphile, 131, 133, 134.
 Pandrosion ii. 360.
 Pappus (*see also* Table of Contents, under Chap. XIX) ii. 17-18, ii. 175, 180, 181, 182, 183, 185, 186, 187, 188, 189, 190, ii. 207, 211, 212, 213, ii. 262, ii. 337, ii. 355-439: on Apollonius's tetrads 40, on Apollonius's continued multiplications 54-7: on ten means 87-9: on mechanical works of Archimedes ii. 23-4: on conics

- of Euclid and Apollonius 438, proof of focus-directrix property ii. 120-1: commentary on Euclid 358, ii. 356-7, on Book X 154-5, 209, 211, ii. 193: commentary on Euclid's *Data* 421-2, ii. 357, on Diodorus's *Analemma* ii. 287, scholia on *Syntaxis* ii. 274: on classification of problems and loci (plane, solid, linear) 218-19, ii. 117-18, criticism on Archimedes and Apollonius 288, ii. 68, ii. 167: on surface-loci 439-40, ii. 425-6: on Euclid's *Porisms* 431-3, 436-7, ii. 270, ii. 419-24: on 'Treasury of Analysis' 421, 422, 439, ii. 399-427: on *cochloids* 238-9: on *quadratrix* 229-30, ii. 379-80, constructions for, ii. 380-2: on duplication of cube 266-8, 268-70: on trisection of any angle 241-3, ii. 385-6, *νεύσις* with regard to parallelogram 236-7: on isoperimetry (cf. Zenodorus) ii. 207, ii. 211-12, ii. 390-4.
- 'Paradoxes' of Erycinus ii. 365-8.
- Parallelogram of velocities 346, ii. 348-9.
- Parapegma* of Democritus 177.
- Parmenides 138.
- Paterius ii. 536-7.
- Patricius ii. 318, 319.
- Pebbles, for calculation 46, 48.
- Pentagon, regular: construction Pythagorean 160-2; area of, ii. 327.
- Pentagram, Pythagorean 161-2 (*see Errata*).
- 'Perfect' numbers 74-5: list of first ten *ib.*: contrasted with 'over-perfect' and 'defective' *ib.*: 10 with Pythagoreans 75.
- 'Perfect' proportion 86.
- Pericles 172.
- Pericles, a mathematician ii. 360.
- Perseus 226: spiric sections ii. 203-6.
- 'Phaenomena' = observational astronomy 17: 322, 349.
- Philippus of Opus 354: works by, 321: on polygonal numbers 84, ii. 515: astronomy 321.
- Philolaus 67, 72, 76, 78, 86, 158, ii. 1: on odd, even, and even-odd numbers 70-1: Pythagorean non-geocentric astronomy attributed to, 163-4.
- Philon of Byzantium 213: duplication of cube 262-3: Philon, Ctesibius and Heron ii. 298-302.
- Philon of Gadara 234.
- Philon of Tyana ii. 260.
- Philoponus, Joannes, 99, 223, 224 *n.*
- Phocaeans 7.
- Phocus of Samos 138.
- Phoenician alphabet, how treated by Greeks 31-2: arithmetic originated with Phoenicians 120-1.
- 'Piremus' or 'peremus' in pyramid 126, 127.
- 'Plane' loci 218.
- 'Plane' problems 218-19.
- Planisphaerium* of Ptolemy ii. 292-3.
- Planudes, Maximus, 117, ii. 453, ii. 546-9.
- Plato 19, 22, 24, 121, 142 *n.*, 170, 176: Θεὸς ἀεὶ γεωμετρῆϊ 10: μηδεὶς ἀγεωμέτρητος εἰσίτω iii, 24, 355: on education in mathematics 19-20, 284: on mathematical 'arts', measurement and weighing 308, instruments for, 308-9, principle of lever 309: on optics 309, 441: on music 310: Plato's astronomy 310-15: on arithmetic and logistic 13-14: classification of numbers, odd, even, &c. 71-2, 292: on number 5040, 294: the Geometrical Number, 305-8: on arithmetical problems 15, ii. 442: on geometry 286-8, constructions alien to true geometry *ib.*: ontology of mathematics 288-9: hypotheses of mathematics 289-90: two intellectual methods 290-2: supposed discovery of mathematical analysis, 120, 212-13, 291-2: definitions of various species of numbers 292, figure 292-3, line and straight line 293, circle and sphere 293-4: on points and indivisible lines 293: formula for rational right-angled triangles 81, 304: 'rational' and 'irrational diameter of 5' 93, 306-7: Plato and the irrational 156, 203-5, 304: on solid geometry 12-13, 303: on regular and semi-regular solids 294-7: Plato and duplication of cube 245-6, 255, 287-8, 303: on geometric means between two squares and two cubes respectively 89, 112,



THIS PAGE IS LOCKED TO FREE MEMBERS

Purchase full membership to immediately unlock this page

DELVE INTO FANTASY, MAGIC, MYTHOLOGY & FOLKLORE

Forgotten Books'
Full Membership gives
access to 797,885 ancient
and modern, fiction and
non-fiction books.

Continue

*Fair usage policy applies

- Gizeh, and Mēdūm 128: measurement of height by Thales 129-30; volume of pyramid 176, 180, 217, ii. 21, &c., volume of frustum ii. 334.
- Pythagoras 65-6, 121, 131, 133, 138: travels 4-5, story of bribed pupil 24-5: motto 25, 141: Heraclitus, Empedocles and Herodotus on, 65: Proclus on discoveries of, 84-5, 90, 119, 141, 154: made mathematics a part of liberal education 141, called geometry 'inquiry.' 166, used definitions 166: arithmetic (theory of numbers) 66-80, figured numbers 76-9: gnomons 77, 79: 'friendly' numbers 75: formula for right-angled triangles in rational numbers 79-80: founded theory of proportion 84-5, introduced 'perfect' proportion 86: discovered dependence of musical intervals on numerical ratios 69, 75-6, 85, 165: astronomy 162-3, earth spherical *ib.*, independent movement of planets 67, 163: Theorem of Pythagoras 142, 144-9, how discovered? 147-9, general proof, how developed *ib.*, Pappus's extension ii. 369-71.
- Pythagoreans 2, 11, 220: *quadrivium* 11: a Pythagorean first taught for money 22: first to advance mathematics 66: 'all things are numbers' 67-9: 'number' of an object 69, 'number in the heaven' 68: figured numbers 69: definition of unit 69: 1 is odd-even 71: classification of numbers 72-4: 'friendly' numbers 75: 10 the 'perfect' number 75: oblong numbers 82-3, 108, 114: side- and diameter- numbers giving approximations to $\sqrt{2}$, 91-3: first cases of indeterminate analysis 80, 91, 96-7: sum of angles of triangle = $2R$, 135, 143: geometrical theorems attributed to, 143-54: invented application of areas and geometrical algebra 150-4: discovered the incommensurable 65, 90-1, 154, with reference to $\sqrt{2}$ 155, 168: theory of proportion only applicable to commensurables 153, 155, 167, 216: construction of regular pentagon 160-2: astronomical system (non-geocentric) 163-5: definitions 166: on order of planets ii. 242.
- Qay en heru*, height (of pyramid) 127.
- Quadratic equation: solved by Pythagorean application of areas 150-2, 167, 394-6, 422-3: numerical solutions ii. 344, ii. 448, ii. 463-5.
- Quadratrix* 2, 23, 171, 182, 218, 219, 225-30, ii. 379-82.
- Quadrivium* of Pythagoreans 11.
- Quinary system of numerals 26.
- Quintilian ii. 207.
- Qustā b. Lūqā, translator of Euclid 362, ii. 453.
- Rangabé, A. R. 49-50.
- Ratdolt, Erhard, first edition of Euclid 364-5.
- Reductio ad absurdum* 372: already used by Pythagoreans 168.
- Reduction* (of a problem) 372.
- Reflection: equality of angles of incidence and reflection 442, ii. 294, ii. 353-4.
- Refraction 6-7, 444: first attempt at a law (Ptolemy) ii. 294.
- Regiomontanus 369, ii. 27, ii. 453-4.
- Regula Nicomachi* 111.
- Rhabdas, Nicolas, 40, ii. 324 *n.*, ii. 550-3.
- Rhind Papyrus: mensuration in, 122-8: algebra in, ii. 440-1.
- Right-angled triangle: inscribed by Thales in circle 131: theorem of Eucl. I. 47, attributed to Pythagoras 142, 144-5, supposed Indian origin of, 145-6.
- Right-angled triangles in rational numbers: Pythagoras's formula 80, Plato's 81, Euclid's 81-2, 405: triangle (3, 4, 5) known to Egyptians 122: Indian examples 146: Diophantus's problems on, ii. 507-14.
- Robertson, Abram, ii. 27.
- Rodet, L. 234.
- Rodolphus Pius ii. 26.
- Roomen, A. van, ii. 182.
- Rudio, F. 173, 184, 187-91, ii. 539.

- Rudolph of Bruges ii. 292.
 Ruelle, Ch. Ém. ii. 538.
 Rüstow, F. W. ii. 309.
 Ruler-and-compasses restriction 175-6.
- Sachs, Eva, 209 n.
 Salaminian table 48, 50-1.
Salinon ii. 23, ii. 103.
 Sampi ($\aleph = 900$) derived from Ssade q.v.
Sar (Babylonian for 60^2) 28, ii. 215.
Satapatha Brāhmana, 146.
 Savile, Sir H., on Euclid 360, 369.
Scalene: of triangles 142: of certain solid numbers 107: of an odd number (Plato) 292: of an oblique cone ii. 134.
 Schiaparelli, G. 317, 330, ii. 539.
 Schmidt, W. ii. 308, 309, 310.
 Schöne, H. ii. 308.
 Schöne, R. ii. 308, 317.
 Scholiast to *Charmides* 14, 53.
 Schooten, F. van, 75 n., ii. 185.
 Schulz, O. ii. 455.
 Scopinas ii. 1.
 Secondary numbers 72.
Sectio canonis 17, 215, 444.
 Seelhoff, P. 75 n.
 Seleucus ii. 3.
 Semicircle: angle in; is right (Thales) 131, 133-7.
 Senkereh, Tables 28, 29.
Senti, base (of pyramid) 127.
Se-get, 'that which makes the nature' (of pyramid) = cotangent of angle of slope 127-8, 130, 131.
 Serenns ii. 519-26: *On section of cylinder* ii. 519-22, *On section of cone* ii. 522-6.
 Sesostris (Ramses II) 121.
 Sexagesimal system of numerals and fractions 28-9: sexagesimal fractions in Greek 44-5, 59, 61-3, 233, ii. 277-83.
 Sextius 220.
 Sicily 8.
 'Side-' and 'diameter-numbers' 91-3, 112, 153, 308, 380, ii. 536.
 Simon, M. 200.
 Simplicius: extract from Eudemus on Hippocrates's quadrature of lunes 171, 182-99: on Antiphon 221-2: on Eudoxus's theory of concentric spheres 329: commentary on Euclid 358, ii. 539-40: on mechanical works of Archimedes ii. 24: ii. 538-40.
 Simson, R., edition of Euclid's *Elements* 365, 369, and of Euclid's *Data* 421: on Euclid's *Porisms* 435-6: restoration of *Plane Loci* of Apollonius ii. 185, ii. 360.
 Simus of Posidonia 86.
 Sines, Tables of, ii. 253, ii. 259-60.
Sinus rectus, sinus versus 367.
 Sluse, R. F. de, 96.
 Smith, D. E. 49, 133 n.
 'Solid' loci and problems 218, ii. 117-18: *Solid Loci* of Aristaeus 438, ii. 118-19.
 'Solid' numbers, classified 106-8.
 Solids, Five regular: discovery attributed to Pythagoras or Pythagoreans 84, 141, 158-60, 168, alternatively (as regards octahedron and icosahedron) to Theaetetus 162: all five investigated by Theaetetus 159, 162, 212, 217: Plato on, 158-60: Euclid's constructions for, 415-19: Pappus's constructions ii. 368-9: content of, ii. 335, ii. 395-6.
 Solon 4, 48.
 Sophists: taught mathematics 23.
 Sosigenes 316, 329.
Soss = sussu = 60 (Babylonian) 28, ii. 215.
 Speusippus 72, 73, 75, ii. 515: on Pythagorean numbers 76, 318: on the five regular solids 318: on *theorems ib.*
Sphaeric 11-12: treatises on, by Autolycus and Euclid 348-52, 440-1: earlier text-book presupposed in Autolycus 349-50: *Sphaerica* of Theodosius ii. 245, 246-52, of Menelaus ii. 252-3, 260, 261-73.
 Sphere-making 18: Archimedes on, ii. 17-18.
 Spiric sections ii. 203-6.
 Sporns 226: criticisms on *quadratrix* 229-30: *κηρία* 234: duplication of cube 266-8.
 Square root, extraction of, 60-3: ex. in sexagesimal fractions (Theon) 61-2, (scholiast to Euclid) 63: method of approximating to surds ii. 51-2, ii. 323-6, ii. 547-9, ii. 553-4.
 Square numbers 69: formation by adding successive gnomons (odd



THIS PAGE IS LOCKED TO FREE MEMBERS

Purchase full membership to immediately unlock this page

FORGOTTEN BOOKS

FULL

MEMBERSHIP

797,885 Books!

All you can read

for only

\$8.99/month

Continue

*Fair usage policy applies

