

# OPA4H199-SP 40V, QML Class-P, Radiation Hardness Assured (RHA), Rail-to-Rail Input and Output, Low Offset Voltage, Low Noise Op Amp in Space-Grade Plastic

## 1 Features

- QML Class-P Radiation Hardness Assured (QMLP-RHA) grade
- Available in small-sized SOT-23 packaging
- Radiation performance:
  - Single Event Latch-up (SEL) immune to 65MeV-cm<sup>2</sup>/mg
  - Total Ionizing Dose (TID) Radiation-hardness-assured (RHA) up to 100krad(Si)
- Supports defense, aerospace, and medical applications
  - Single controlled baseline
  - One fabrication, assembly and test site
  - Gold wire
  - NiPdAu lead finish
  - Available in military (–55°C to 125°C) temperature range
  - Extended product life cycle
  - Product traceability
  - Enhanced mold compound for low outgassing
- Low offset voltage: ±125µV
- Low noise: 10.8nV/√Hz at 1kHz
- High common-mode rejection: 130dB
- Low bias current: ±10pA
- Rail-to-rail input and output
- Wide bandwidth: 4.5MHz GBW
- High slew rate: 21V/µs
- High capacitive load drive: 1nF
- MUX-friendly/comparator inputs
- Low quiescent current: 560µA per amplifier
- Wide supply: ±1.35V to ±20V, 2.7V to 40V
- Robust EMIRR performance: EMI/RFI filters on input and supply pins

## 2 Applications

- Support low earth orbit space applications
- Space sensor and control (telemetry)
- [Satellite electrical power system \(EPS\)](#)
- [Flight control](#)
- [Satellite command & data handling](#)
- [Satellite payloads](#)

## 3 Description

The OPA4H199-SP is a high voltage (40V) general purpose operational amplifiers for space application. The device offers exceptional DC precision and AC performance, including rail-to-rail input/output, low offset (±125µV, typical), low offset drift (±0.3µV/°C, typical), low noise (10.8nV/√Hz and 1.8µV<sub>PP</sub>), and 4.5MHz bandwidth.

Unique features such as differential and common-mode input-voltage range to the supply rail, high output current (±75mA), high slew rate (21V/µs), and high capacitive load drive (1nF) make the OPA4H199-SP a robust, high-performance operational amplifier for high-voltage space applications.

The OPA4H199-SP is available in a small-sized, radiation-hardened plastic, 14-pin SOT-23 (DYY) package. The SOT-23 (DYY) package has a body size that is less than 1/5<sup>th</sup> of the size of traditional 14-pin ceramic packages. The OPA4H199-SP is specified from –55°C to 125°C.

### Package Information

PART NUMBER <sup>(1)</sup>	PACKAGE	PACKAGE SIZE <sup>(2)</sup>
OPA4H199-SP	DYY (SOT-23, 14)	4.2mm × 3.26mm

- (1) For all available packages, see the orderable addendum at the end of the data sheet.
- (2) The package size (length × width) is a nominal value and includes pins, where applicable.

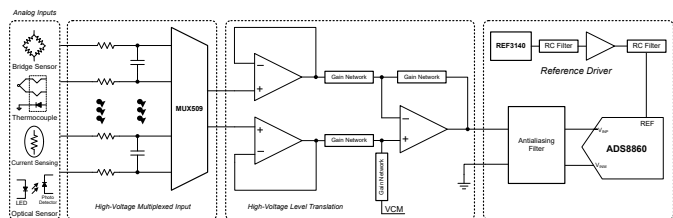

OPA4H199-SP in a High-Voltage Signal Chain



## Table of Contents

<b>1 Features</b> .....	<b>1</b>	<b>7 Application and Implementation</b> .....	<b>24</b>
<b>2 Applications</b> .....	<b>1</b>	7.1 Application Information.....	24
<b>3 Description</b> .....	<b>1</b>	7.2 Typical Applications.....	24
<b>4 Pin Configuration and Functions</b> .....	<b>3</b>	7.3 Power Supply Recommendations.....	26
<b>5 Specifications</b> .....	<b>4</b>	7.4 Layout.....	26
5.1 Absolute Maximum Ratings.....	4	<b>8 Device and Documentation Support</b> .....	<b>28</b>
5.2 ESD Ratings.....	4	8.1 Device Support.....	28
5.3 Recommended Operating Conditions.....	4	8.2 Documentation Support.....	28
5.4 Thermal Information for Quad Channel.....	4	8.3 Receiving Notification of Documentation Updates....	28
5.5 Electrical Characteristics.....	5	8.4 Support Resources.....	28
5.6 Typical Characteristics.....	7	8.5 Trademarks.....	28
<b>6 Detailed Description</b> .....	<b>14</b>	8.6 Electrostatic Discharge Caution.....	28
6.1 Overview.....	14	8.7 Glossary.....	29
6.2 Functional Block Diagram.....	14	<b>9 Revision History</b> .....	<b>29</b>
6.3 Feature Description.....	15	<b>10 Mechanical, Packaging, and Orderable Information</b> .....	<b>29</b>
6.4 Device Functional Modes.....	23		

## 4 Pin Configuration and Functions

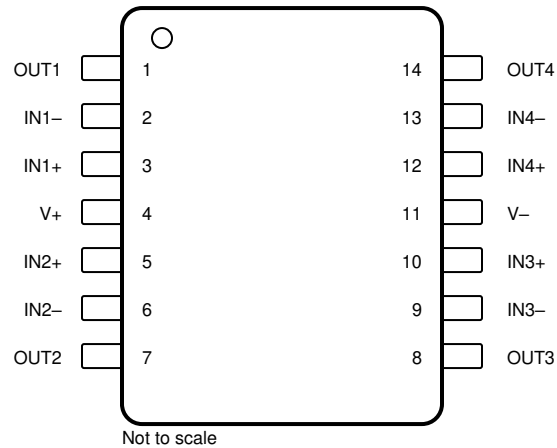

**Figure 4-1. OPA4H199-SP DYY Package  
14-Pin SOT-23  
Top View**

**Table 4-1. Pin Functions: OPA4H199-SP**

PIN		I/O	DESCRIPTION
NAME	NO.		
IN1+	3	I	Noninverting input, channel 1
IN1-	2	I	Inverting input, channel 1
IN2+	5	I	Noninverting input, channel 2
IN2-	6	I	Inverting input, channel 2
IN3+	10	I	Noninverting input, channel 3
IN3-	9	I	Inverting input, channel 3
IN4+	12	I	Noninverting input, channel 4
IN4-	13	I	Inverting input, channel 4
OUT1	1	O	Output, channel 1
OUT2	7	O	Output, channel 2
OUT3	8	O	Output, channel 3
OUT4	14	O	Output, channel 4
V+	4	—	Positive (highest) power supply
V-	11	—	Negative (lowest) power supply

## 5 Specifications

### 5.1 Absolute Maximum Ratings

over operating ambient temperature range (unless otherwise noted) <sup>(1)</sup>

		MIN	MAX	UNIT
Supply voltage, $V_S = (V+) - (V-)$		0	42	V
Signal input pins	Common-mode voltage <sup>(3)</sup>	$(V-) - 0.5$	$(V+) + 0.5$	V
	Differential voltage <sup>(3)</sup>		$V_S + 0.2$	V
	Current <sup>(3)</sup>	-10	10	mA
Output short-circuit <sup>(2)</sup>		Continuous		
Operating ambient temperature, $T_A$		-55	150	°C
Junction temperature, $T_J$			150	°C
Storage temperature, $T_{stg}$		-65	150	°C

- (1) Operation outside the *Absolute Maximum Ratings* may cause permanent device damage. *Absolute Maximum Ratings* do not imply functional operation of the device at these or any other conditions beyond those listed under *Recommended Operating Conditions*. If used outside the *Recommended Operating Conditions* but within the *Absolute Maximum Ratings*, the device may not be fully functional, and this may affect device reliability, functionality, performance, and shorten the device lifetime.
- (2) Short-circuit to ground, one amplifier per package. This device has been designed to limit *electrical* damage due to excessive output current, but extended short-circuit current, especially with higher supply voltage, can cause excessive heating and eventual *thermal* destruction. See the [Thermal Protection](#) section for more information.
- (3) Input pins are diode-clamped to the power-supply rails. Input signals that may swing more than 0.5V beyond the supply rails must be current limited to 10mA or less.

### 5.2 ESD Ratings

		VALUE	UNIT
$V_{(ESD)}$	Electrostatic discharge	Human body model (HBM), per ANSI/ESDA/JEDEC JS-001 <sup>(1)</sup>	±2000
		Charged device model (CDM), per ANSI/ESDA/JEDEC JS-002 <sup>(2)</sup>	±1000

- (1) JEDEC document JEP155 states that 500V HBM allows safe manufacturing with a standard ESD control process.
- (2) JEDEC document JEP157 states that 250V CDM allows safe manufacturing with a standard ESD control process.

### 5.3 Recommended Operating Conditions

over operating ambient temperature range (unless otherwise noted)

		MIN	MAX	UNIT
$V_S$	Supply voltage, $(V+) - (V-)$	2.7	40	V
$V_I$	Input voltage range	$(V-) - 0.1$	$(V+) + 0.1$	V
$T_A$	Specified ambient temperature	-55	125	°C

### 5.4 Thermal Information for Quad Channel

THERMAL METRIC <sup>(1)</sup>		OPA4H199-SP	UNIT
		DYY (SOT-23)	
		14 PINS	
$R_{\theta JA}$	Junction-to-ambient thermal resistance	121.6	°C/W
$R_{\theta JC(top)}$	Junction-to-case (top) thermal resistance	53.6	°C/W
$R_{\theta JB}$	Junction-to-board thermal resistance	47.8	°C/W
$\Psi_{JT}$	Junction-to-top characterization parameter	2.1	°C/W
$\Psi_{JB}$	Junction-to-board characterization parameter	47.6	°C/W
$R_{\theta JC(bot)}$	Junction-to-case (bottom) thermal resistance	N/A	°C/W

- (1) For more information about traditional and new thermal metrics, see the [Semiconductor and IC Package Thermal Metrics](#) application note.

## 5.5 Electrical Characteristics

For  $V_S = (V+) - (V-) = 2.7V$  to  $40V$  ( $\pm 1.35V$  to  $\pm 20V$ ) at  $T_A = 25^\circ C$ ,  $R_L = 10k\Omega$  connected to  $V_S / 2$ ,  $V_{CM} = V_S / 2$ ,  $V_{O\ UT} = V_S / 2$ , and the device is connected in a closed-loop feedback configuration unless otherwise noted.

PARAMETER		TEST CONDITIONS		MIN	TYP	MAX	UNIT
<b>OFFSET VOLTAGE</b>							
$V_{OS}$	Input offset voltage	$V_{CM} = V-$			$\pm 125$	$\pm 895$	$\mu V$
			$T_A = -55^\circ C$ to $125^\circ C$			$\pm 925$	
$dV_{OS}/dT$	Input offset voltage drift		$T_A = -55^\circ C$ to $125^\circ C$		$\pm 0.3$		$\mu V/^\circ C$
PSRR	Input offset voltage versus power supply	$V_{CM} = V-, V_S = 4V$ to $40V$	$T_A = -55^\circ C$ to $125^\circ C$		$\pm 0.3$	$\pm 1$	$\mu V/V$
		$V_{CM} = V-, V_S = 2.7V$ to $40V$			$\pm 1$	$\pm 5$	
	Channel separation	$f = 0Hz$			5		$\mu V/V$
<b>INPUT BIAS CURRENT</b>							
$I_B$	Input bias current				$\pm 10$		$pA$
$I_{OS}$	Input offset current				$\pm 10$		$pA$
<b>NOISE</b>							
$E_N$	Input voltage noise	$f = 0.1Hz$ to $10Hz$			1.8		$\mu V_{PP}$
					0.3		$\mu V_{RMS}$
$e_N$	Input voltage noise density	$f = 1kHz$			10.8		$nV/\sqrt{Hz}$
		$f = 10kHz$			9.4		
$i_N$	Input current noise	$f = 1kHz$			82		$fA/\sqrt{Hz}$
<b>INPUT VOLTAGE RANGE</b>							
$V_{CM}$	Common-mode voltage range			$(V-) - 0.1$		$(V+) + 0.1$	V
CMRR	Common-mode rejection ratio	$V_S = 40V, (V-) - 0.1V < V_{CM} < (V+) - 2V$ (Main input pair)	$T_A = -55^\circ C$ to $125^\circ C$		107	130	dB
		$V_S = 4V, (V-) - 0.1V < V_{CM} < (V+) - 2V$ (Main input pair)			82	100	
		$V_S = 2.7V, (V-) - 0.1V < V_{CM} < (V+) - 2V$ (Main input pair)			75	95	
		$V_S = 2.7V$ to $40V, (V+) - 1V < V_{CM} < (V+) + 0.1V$ (Aux input pair)				85	
<b>INPUT CAPACITANCE</b>							
$Z_{ID}$	Differential				$100 \parallel 9$		$M\Omega \parallel pF$
$Z_{ICM}$	Common-mode				$6 \parallel 1$		$T\Omega \parallel pF$
<b>OPEN-LOOP GAIN</b>							
$A_{OL}$	Open-loop voltage gain	$V_S = 40V, V_{CM} = V- (V-) + 0.1V < V_O < (V+) - 0.1V$	$T_A = -55^\circ C$ to $125^\circ C$		120	145	dB
						142	
		$V_S = 4V, V_{CM} = V- (V-) + 0.1V < V_O < (V+) - 0.1V$	$T_A = -55^\circ C$ to $125^\circ C$		104	130	
						125	
$V_S = 2.7V, V_{CM} = V- (V-) + 0.1V < V_O < (V+) - 0.1V$	$T_A = -55^\circ C$ to $125^\circ C$		101	120			
				118			

For  $V_S = (V+) - (V-) = 2.7V$  to  $40V$  ( $\pm 1.35V$  to  $\pm 20V$ ) at  $T_A = 25^\circ C$ ,  $R_L = 10k\Omega$  connected to  $V_S / 2$ ,  $V_{CM} = V_S / 2$ ,  $V_{O\ UT} = V_S / 2$ , and the device is connected in a closed-loop feedback configuration unless otherwise noted.

PARAMETER		TEST CONDITIONS	MIN	TYP	MAX	UNIT
<b>FREQUENCY RESPONSE</b>						
GBW	Gain-bandwidth product			4.5		MHz
SR	Slew rate	$V_S = 40V$ , $G = +1$ , $C_L = 20pF$		21		V/ $\mu s$
$t_S$	Settling time	To 0.01%, $V_S = 40V$ , $V_{STEP} = 10V$ , $G = +1$ , $C_L = 20pF$		2.5		$\mu s$
		To 0.01%, $V_S = 40V$ , $V_{STEP} = 2V$ , $G = +1$ , $C_L = 20pF$		1.5		
		To 0.1%, $V_S = 40V$ , $V_{STEP} = 10V$ , $G = +1$ , $C_L = 20pF$		2		
		To 0.1%, $V_S = 40V$ , $V_{STEP} = 2V$ , $G = +1$ , $C_L = 20pF$		1		
	Phase margin	$G = +1$ , $R_L = 10k\Omega$ , $C_L = 20pF$		60		$^\circ$
	Overload recovery time	$V_{IN} \times \text{gain} > V_S$		400		ns
THD+N	Total harmonic distortion + noise <sup>(1)</sup>	$V_S = 40V$ , $V_O = 3V_{RMS}$ , $G = 1$ , $f = 1kHz$		0.00021%		
<b>OUTPUT</b>						
	Voltage output swing from rail	Positive and negative rail headroom	$V_S = 40V$ , $R_L = \text{no load}$	5	10	mV
			$V_S = 40V$ , $R_L = 10k\Omega$	50	70	
			$V_S = 40V$ , $R_L = 2k\Omega$	300	350	
			$V_S = 2.7V$ , $R_L = \text{no load}$	1	6	
			$V_S = 2.7V$ , $R_L = 10k\Omega$	5	12	
			$V_S = 2.7V$ , $R_L = 2k\Omega$	25	40	
$I_{SC}$	Short-circuit current			$\pm 75$		mA
$C_{LOAD}$	Capacitive load drive			1000		pF
$Z_O$	Open-loop output impedance	$f = 1MHz$ , $I_O = 0A$		525		$\Omega$
<b>POWER SUPPLY</b>						
$I_Q$	Quiescent current per amplifier	$V_{CM} = V_-$ , $I_O = 0A$		560	685	$\mu A$
			$T_A = -55^\circ C$ to $125^\circ C$		750	

(1) Third-order filter; bandwidth = 80kHz at -3dB.

## 5.6 Typical Characteristics

at  $T_A = 25^\circ\text{C}$ ,  $V_S = \pm 20\text{V}$ ,  $V_{CM} = V_S / 2$ ,  $R_{LOAD} = 10\text{k}\Omega$  connected to  $V_S / 2$ , and  $C_L = 10\text{pF}$  (unless otherwise noted)

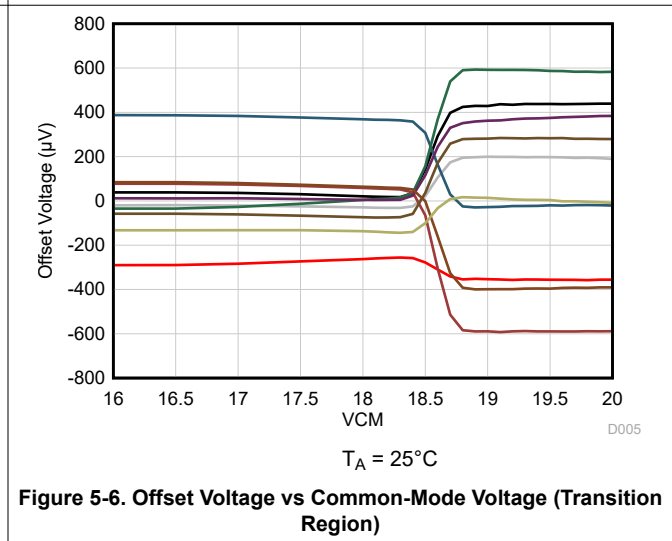
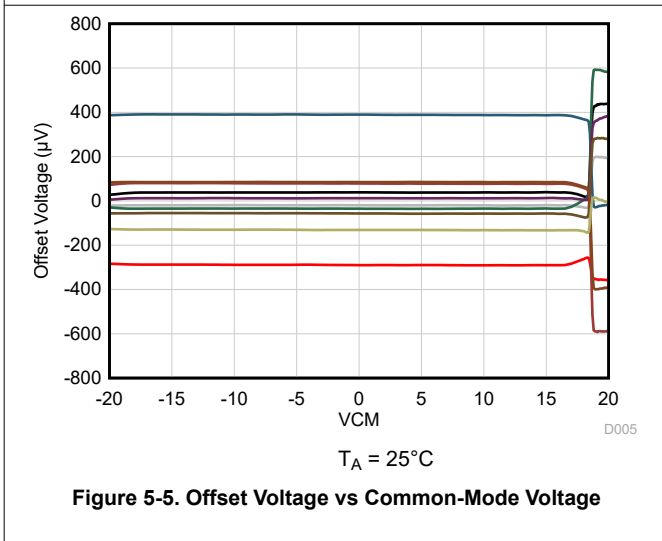
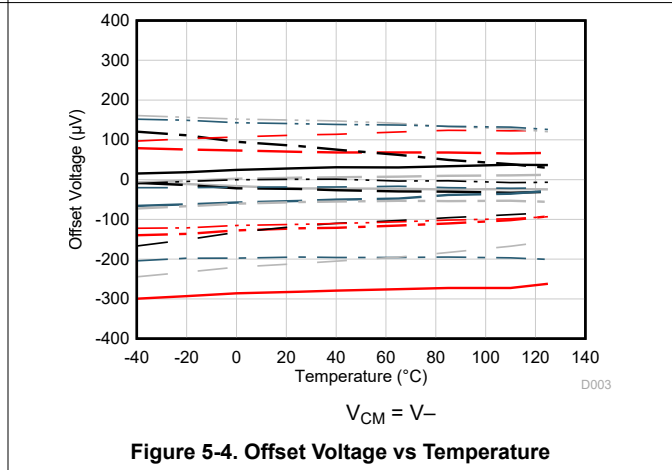
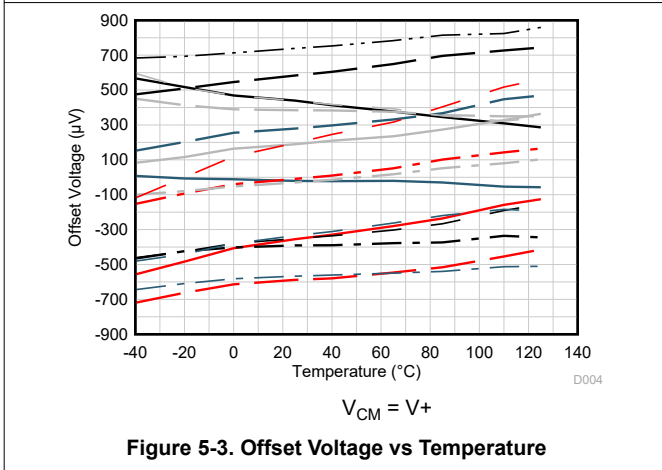
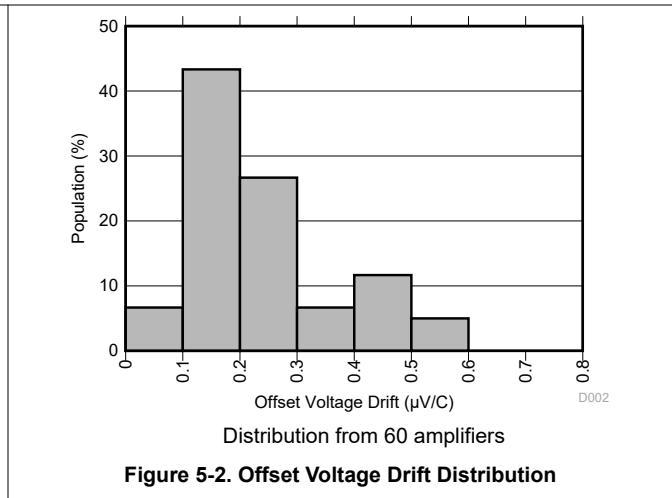
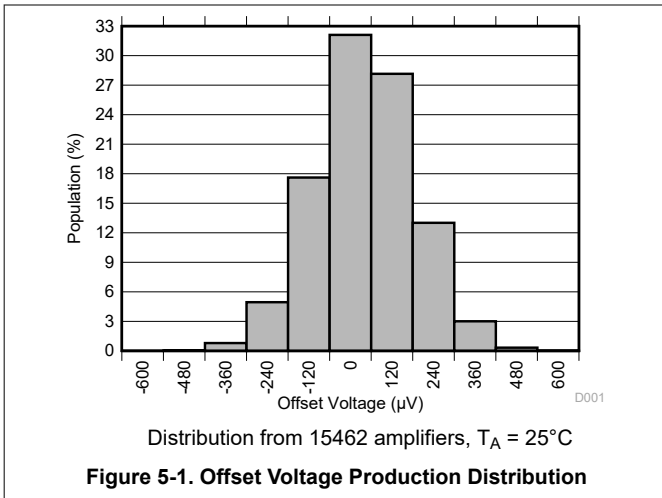

## 5.6 Typical Characteristics (continued)

at  $T_A = 25^\circ\text{C}$ ,  $V_S = \pm 20\text{V}$ ,  $V_{CM} = V_S / 2$ ,  $R_{LOAD} = 10\text{k}\Omega$  connected to  $V_S / 2$ , and  $C_L = 10\text{pF}$  (unless otherwise noted)

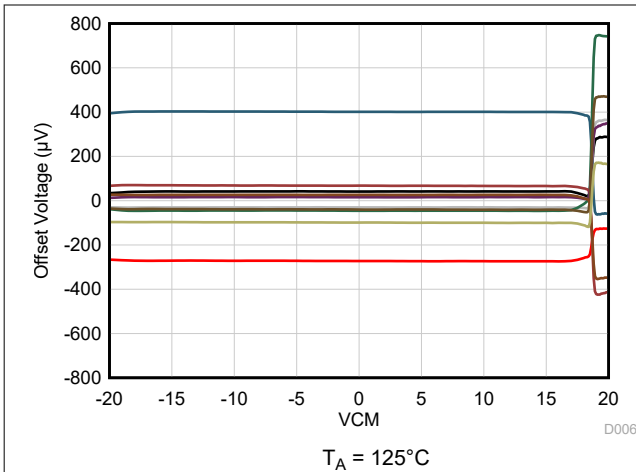

Figure 5-7. Offset Voltage vs Common-Mode Voltage

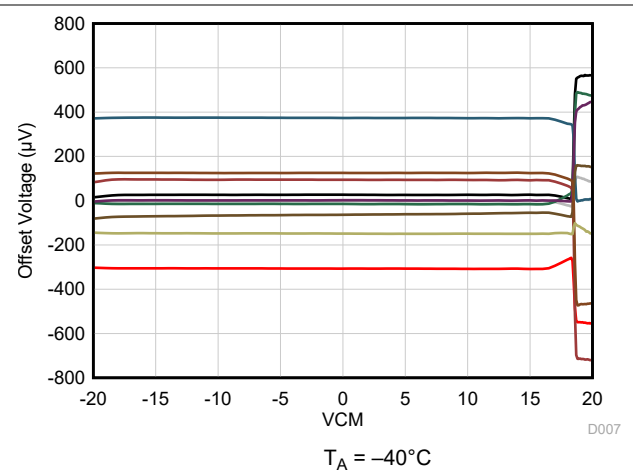

Figure 5-8. Offset Voltage vs Common-Mode Voltage

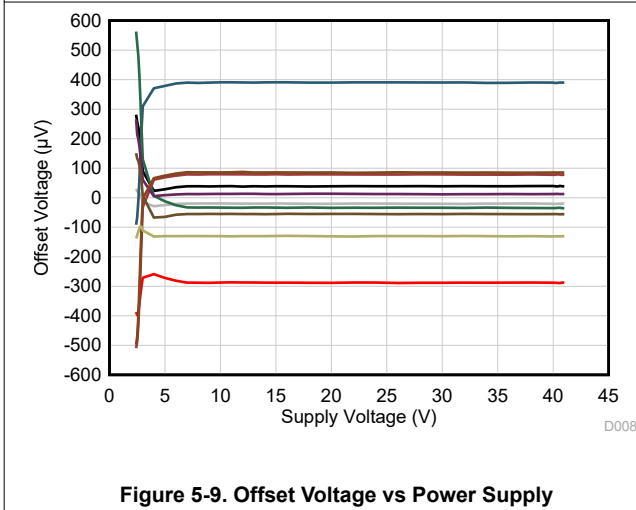

Figure 5-9. Offset Voltage vs Power Supply

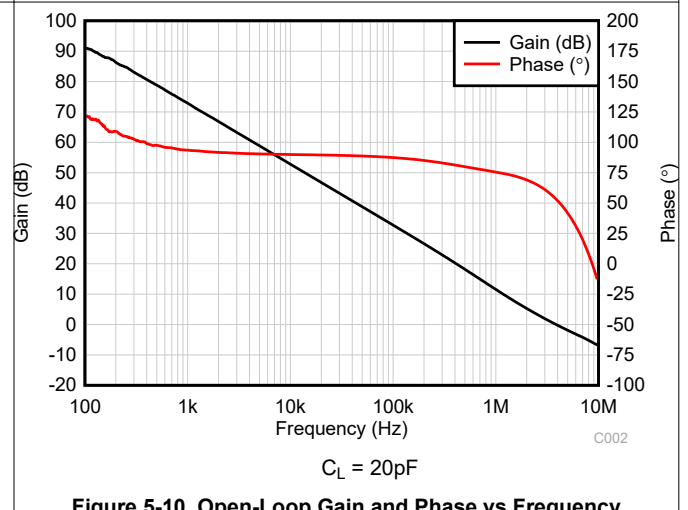

Figure 5-10. Open-Loop Gain and Phase vs Frequency

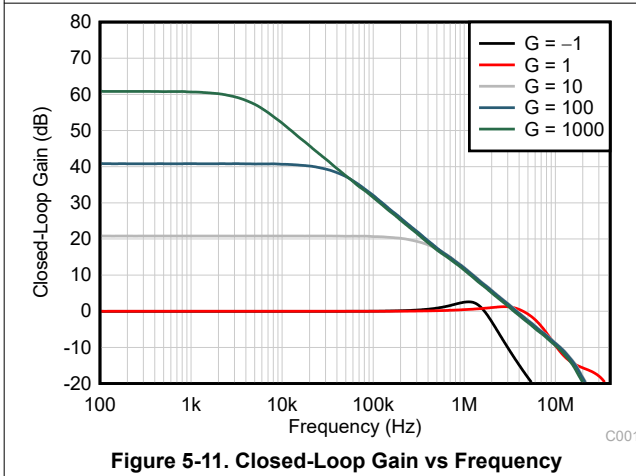

Figure 5-11. Closed-Loop Gain vs Frequency

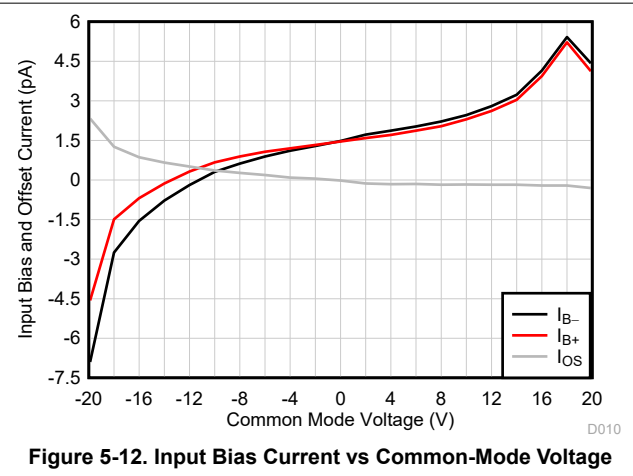
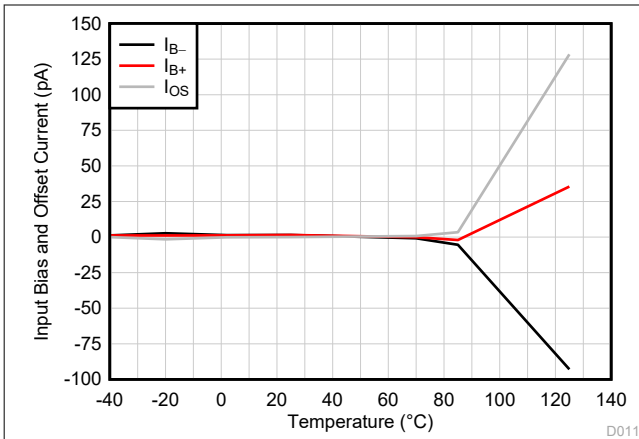

Figure 5-12. Input Bias Current vs Common-Mode Voltage



### 5.6 Typical Characteristics (continued)

at  $T_A = 25^\circ\text{C}$ ,  $V_S = \pm 20\text{V}$ ,  $V_{CM} = V_S / 2$ ,  $R_{LOAD} = 10\text{k}\Omega$  connected to  $V_S / 2$ , and  $C_L = 10\text{pF}$  (unless otherwise noted)



**Figure 5-13. Input Bias Current vs Temperature**

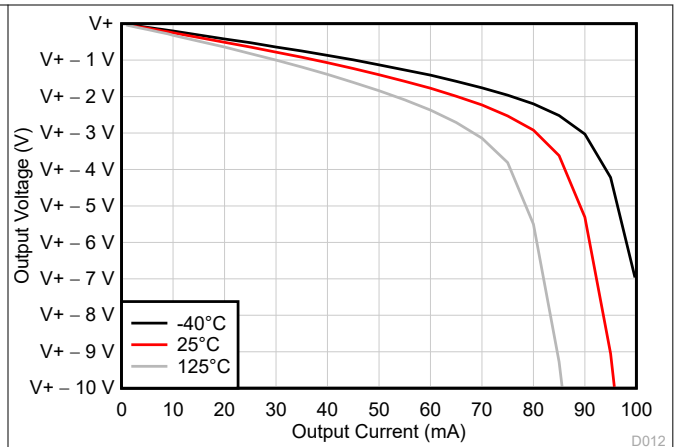

**Figure 5-14. Output Voltage Swing vs Output Current (Sourcing)**

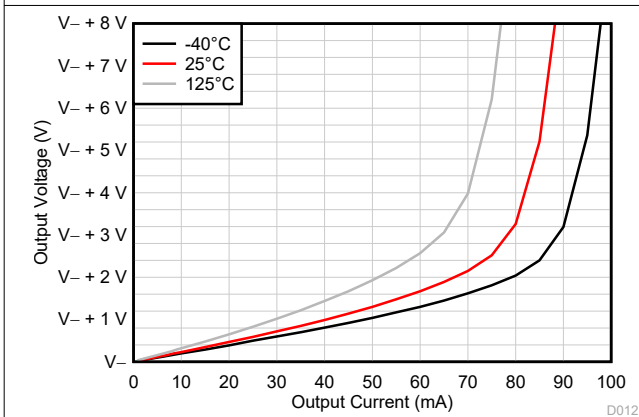

**Figure 5-15. Output Voltage Swing vs Output Current (Sinking)**

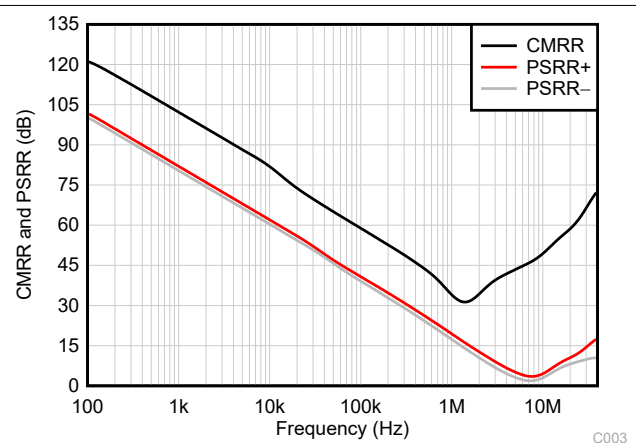

**Figure 5-16. CMRR and PSRR vs Frequency**

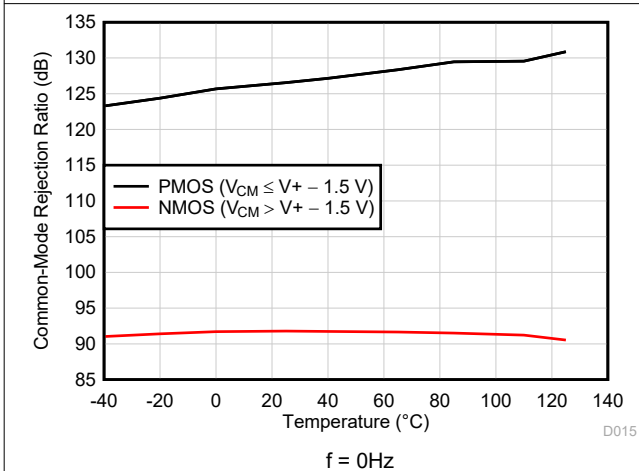

**Figure 5-17. CMRR vs Temperature (dB)**

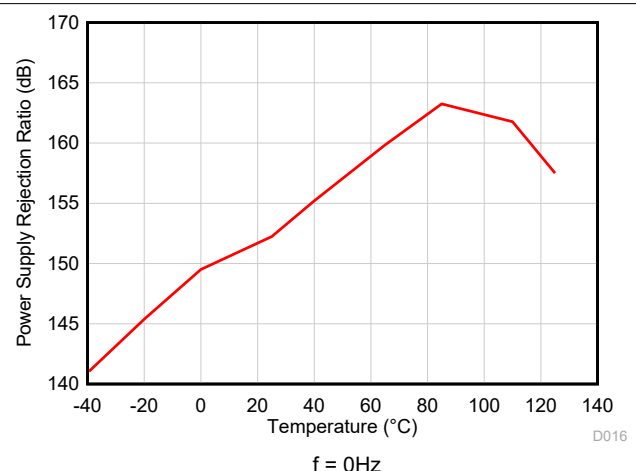

**Figure 5-18. PSRR vs Temperature (dB)**

## 5.6 Typical Characteristics (continued)

at  $T_A = 25^\circ\text{C}$ ,  $V_S = \pm 20\text{V}$ ,  $V_{CM} = V_S / 2$ ,  $R_{LOAD} = 10\text{k}\Omega$  connected to  $V_S / 2$ , and  $C_L = 10\text{pF}$  (unless otherwise noted)

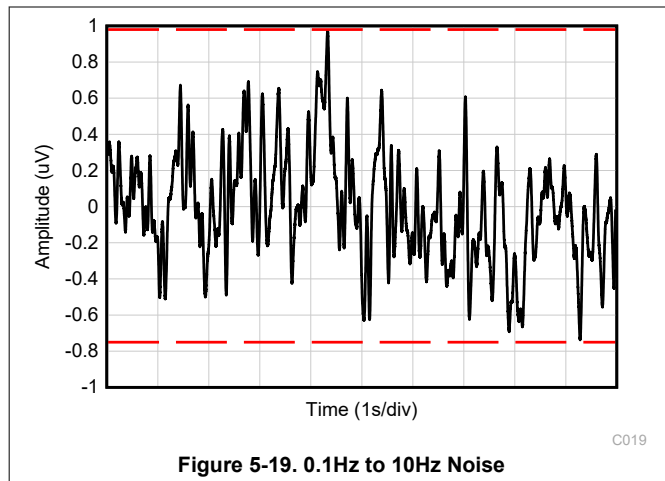

Figure 5-19. 0.1Hz to 10Hz Noise

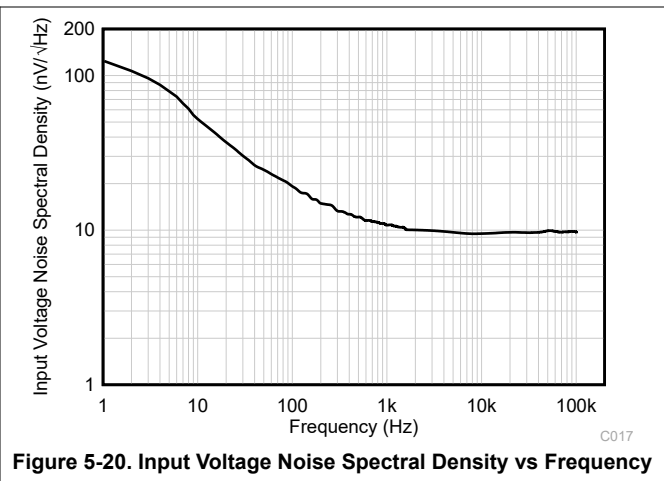

Figure 5-20. Input Voltage Noise Spectral Density vs Frequency

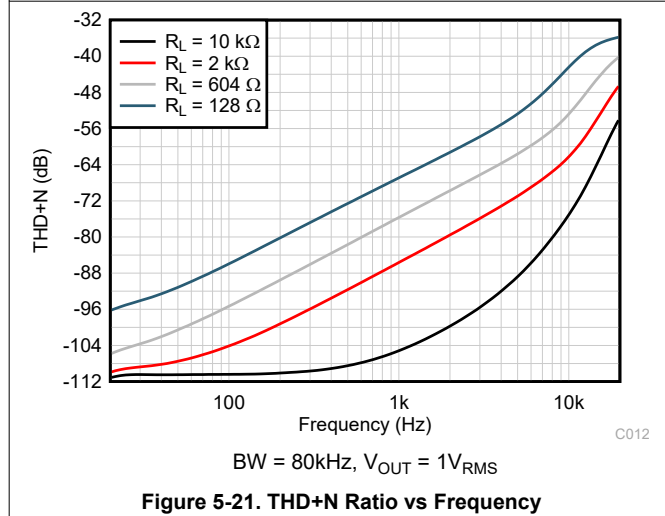

Figure 5-21. THD+N Ratio vs Frequency

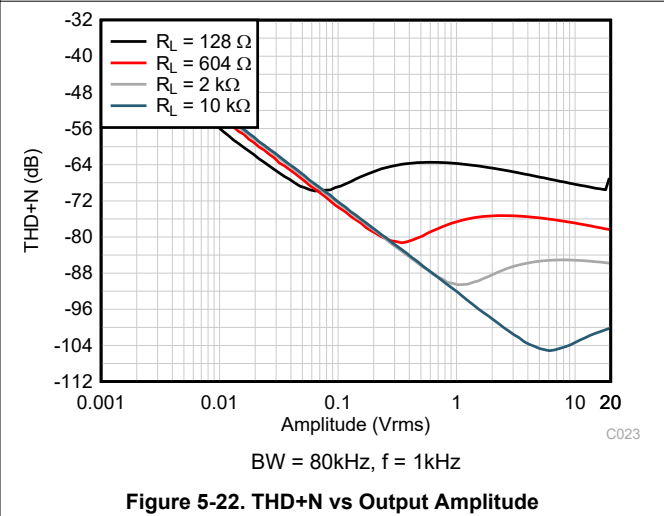

Figure 5-22. THD+N vs Output Amplitude

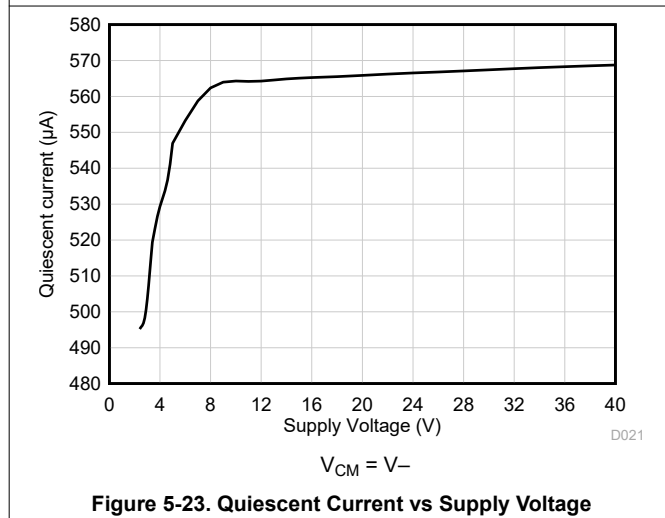

Figure 5-23. Quiescent Current vs Supply Voltage

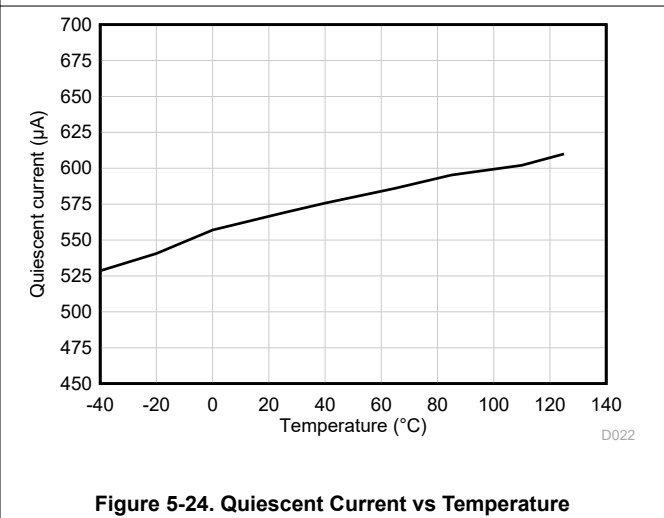

Figure 5-24. Quiescent Current vs Temperature

### 5.6 Typical Characteristics (continued)

at  $T_A = 25^\circ\text{C}$ ,  $V_S = \pm 20\text{V}$ ,  $V_{CM} = V_S / 2$ ,  $R_{LOAD} = 10\text{k}\Omega$  connected to  $V_S / 2$ , and  $C_L = 10\text{pF}$  (unless otherwise noted)

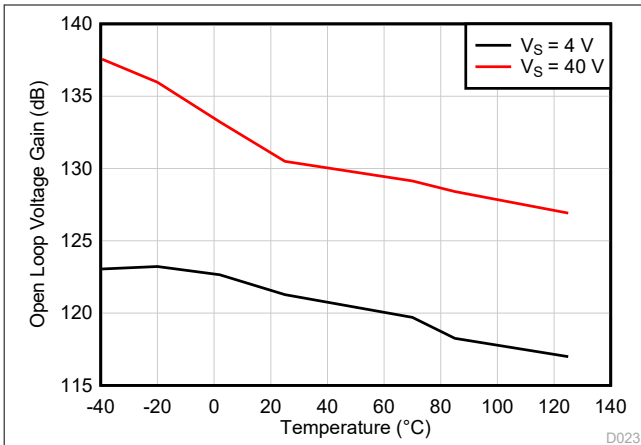

Figure 5-25. Open-Loop Voltage Gain vs Temperature (dB)

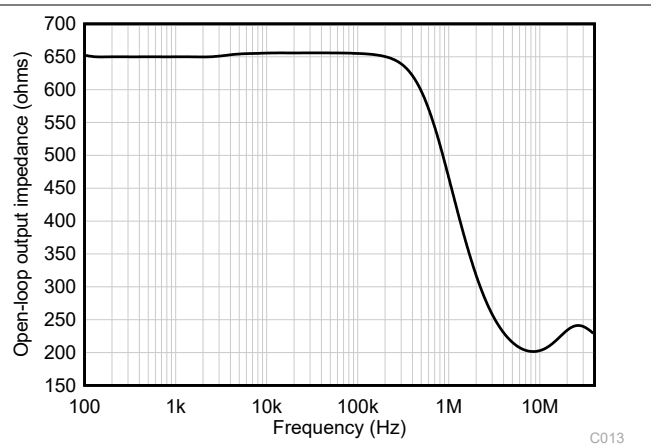
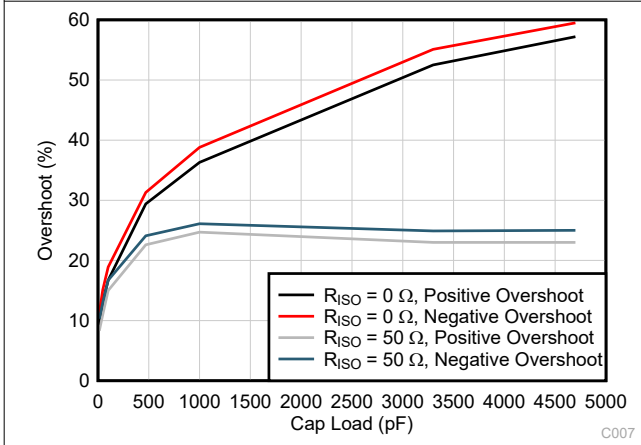
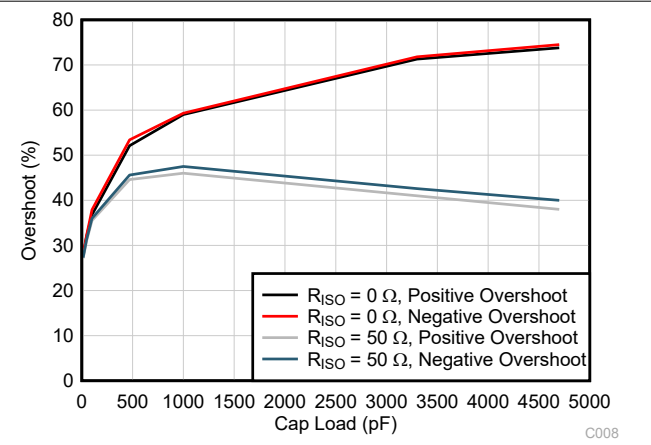

Figure 5-26. Open-Loop Output Impedance vs Frequency



$G = -1$ , 10mV output step

Figure 5-27. Small-Signal Overshoot vs Capacitive Load



$G = 1$ , 10mV output step

Figure 5-28. Small-Signal Overshoot vs Capacitive Load

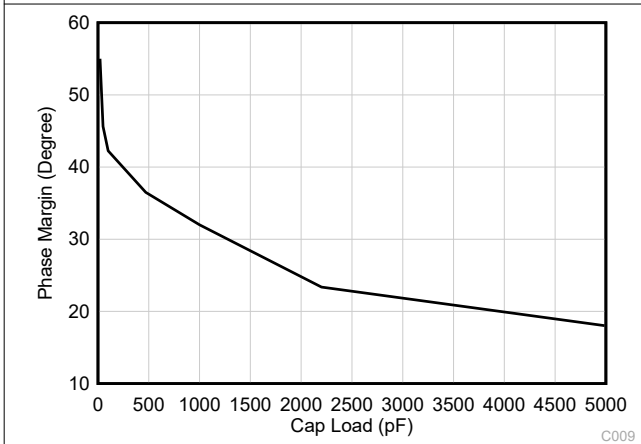
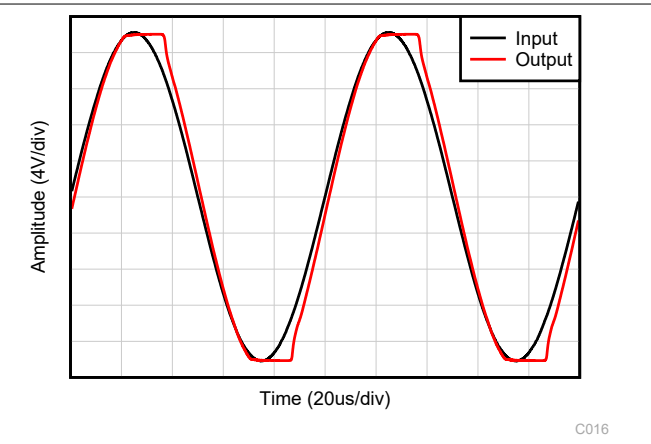

Figure 5-29. Phase Margin vs Capacitive Load



$V_{IN} = \pm 20\text{V}$ ;  $V_S = V_{OUT} = \pm 17\text{V}$

Figure 5-30. No Phase Reversal

## 5.6 Typical Characteristics (continued)

at  $T_A = 25^\circ\text{C}$ ,  $V_S = \pm 20\text{V}$ ,  $V_{CM} = V_S / 2$ ,  $R_{LOAD} = 10\text{k}\Omega$  connected to  $V_S / 2$ , and  $C_L = 10\text{pF}$  (unless otherwise noted)

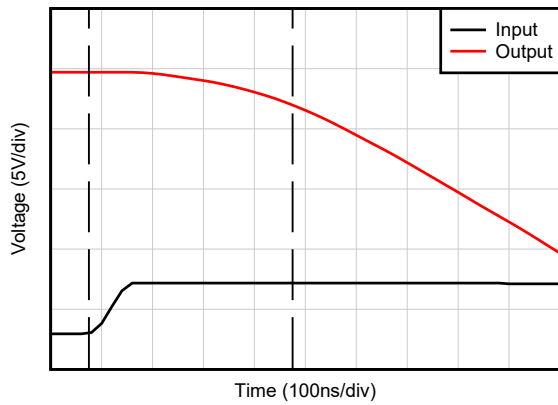

$G = -10$

**Figure 5-31. Positive Overload Recovery**

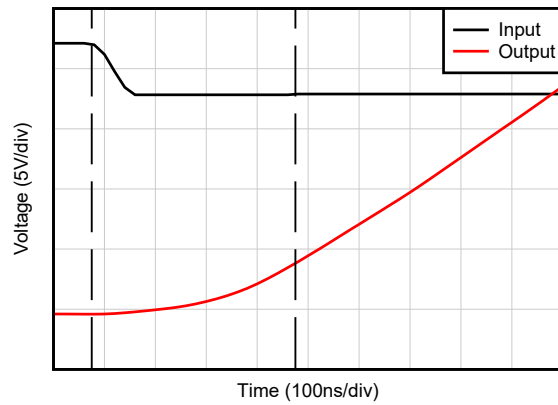

$G = -10$

**Figure 5-32. Negative Overload Recovery**

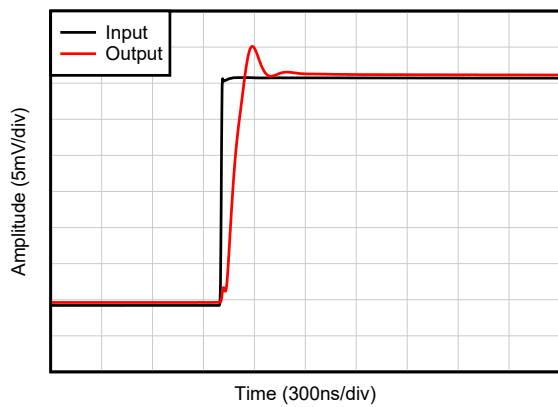

$C_L = 20\text{pF}$ ,  $G = 1$ , 20mV step response

**Figure 5-33. Small-Signal Step Response, Rising**

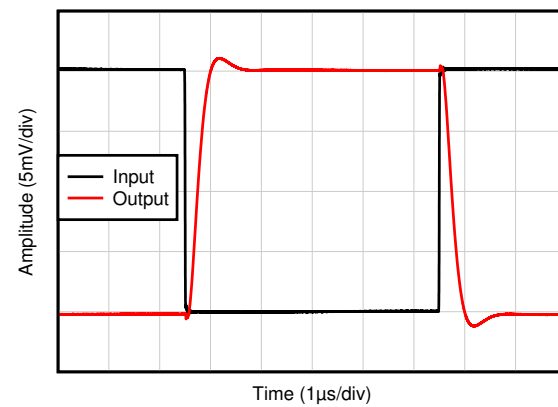

$C_L = 20\text{pF}$ ,  $G = -1$ , 20mV step response

**Figure 5-34. Small-Signal Step Response**

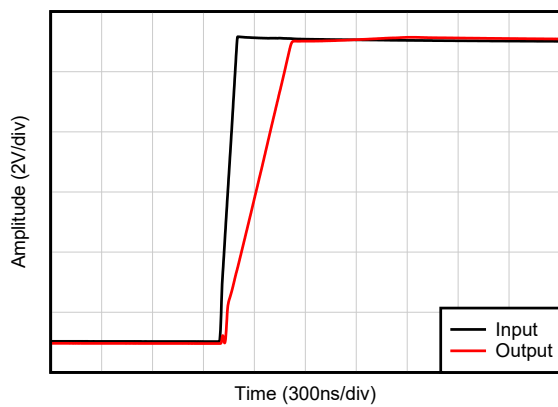

$C_L = 20\text{pF}$ ,  $G = 1$

**Figure 5-35. Large-Signal Step Response (Rising)**

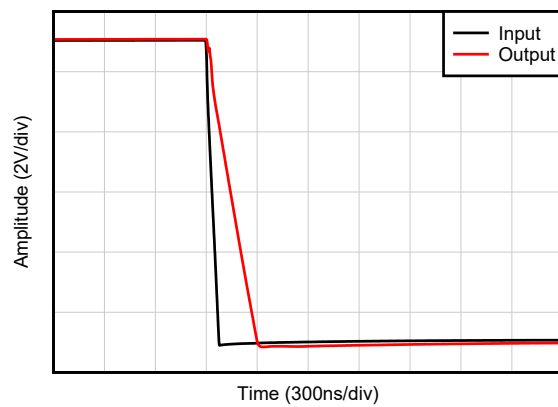

$C_L = 20\text{pF}$ ,  $G = 1$

**Figure 5-36. Large-Signal Step Response (Falling)**

### 5.6 Typical Characteristics (continued)

at  $T_A = 25^\circ\text{C}$ ,  $V_S = \pm 20\text{V}$ ,  $V_{CM} = V_S / 2$ ,  $R_{LOAD} = 10\text{k}\Omega$  connected to  $V_S / 2$ , and  $C_L = 10\text{pF}$  (unless otherwise noted)

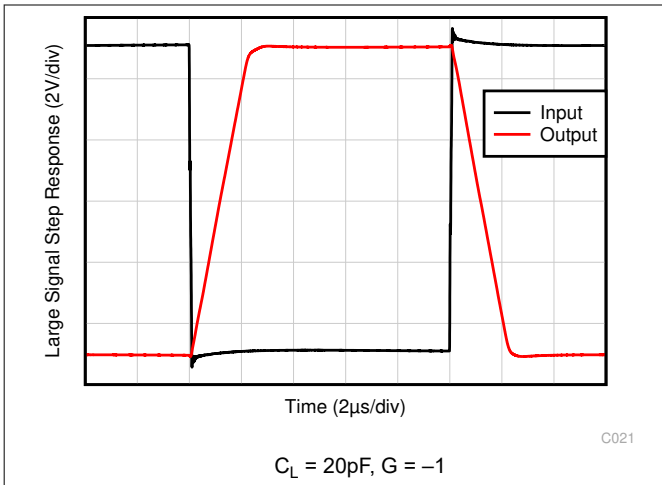

Figure 5-37. Large-Signal Step Response

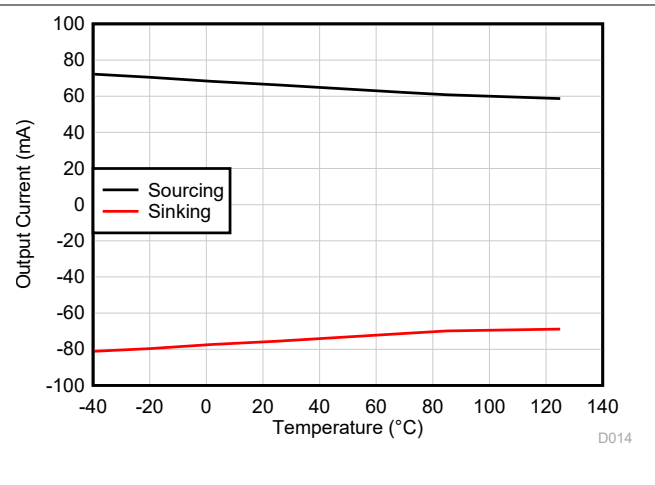

Figure 5-38. Short-Circuit Current vs Temperature

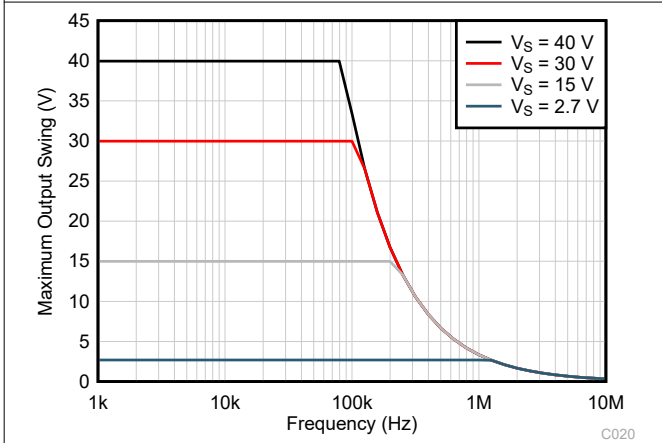

Figure 5-39. Maximum Output Voltage vs Frequency

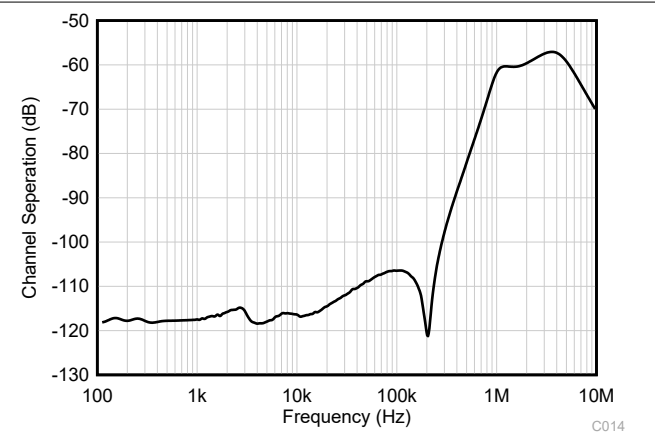

Figure 5-40. Channel Separation vs Frequency

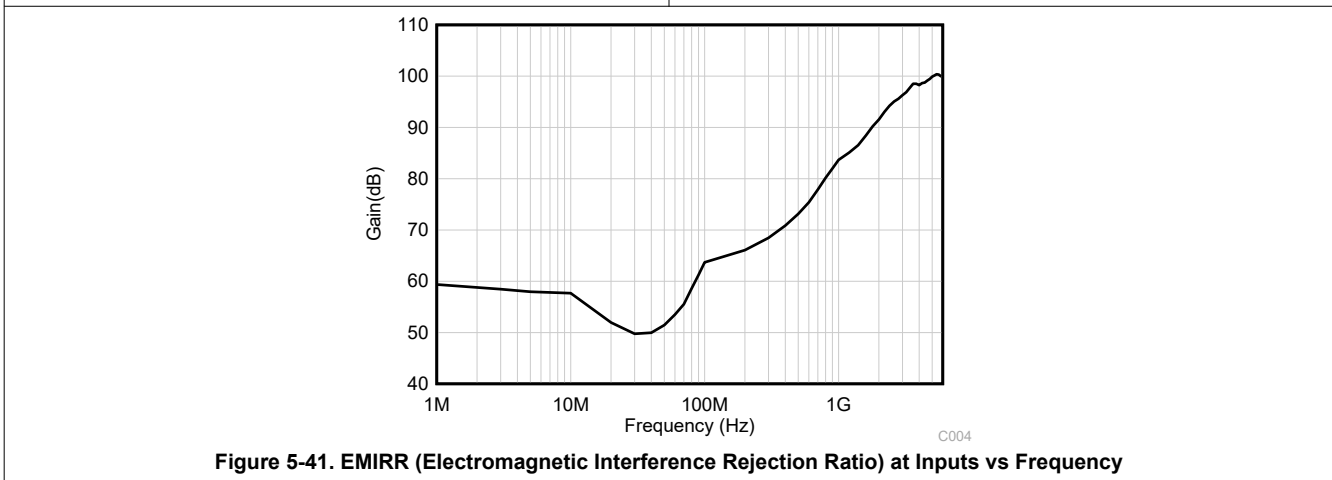

Figure 5-41. EMIRR (Electromagnetic Interference Rejection Ratio) at Inputs vs Frequency

## 6 Detailed Description

### 6.1 Overview

The OPA4H199-SP is a 40V general purpose operational amplifier.

This device offers excellent DC precision and AC performance, including rail-to-rail input/output, low offset ( $\pm 125\mu\text{V}$ , typical), low offset drift ( $\pm 0.3\mu\text{V}/^\circ\text{C}$ , typical), and 4.5MHz bandwidth.

Unique features, such as differential and common-mode input-voltage range to the supply rail, high output current ( $\pm 75\text{mA}$ ), and high slew rate ( $21\text{V}/\mu\text{s}$ ), make the OPA4H199-SP a robust, high-performance operational amplifier for high-voltage space applications.

### 6.2 Functional Block Diagram

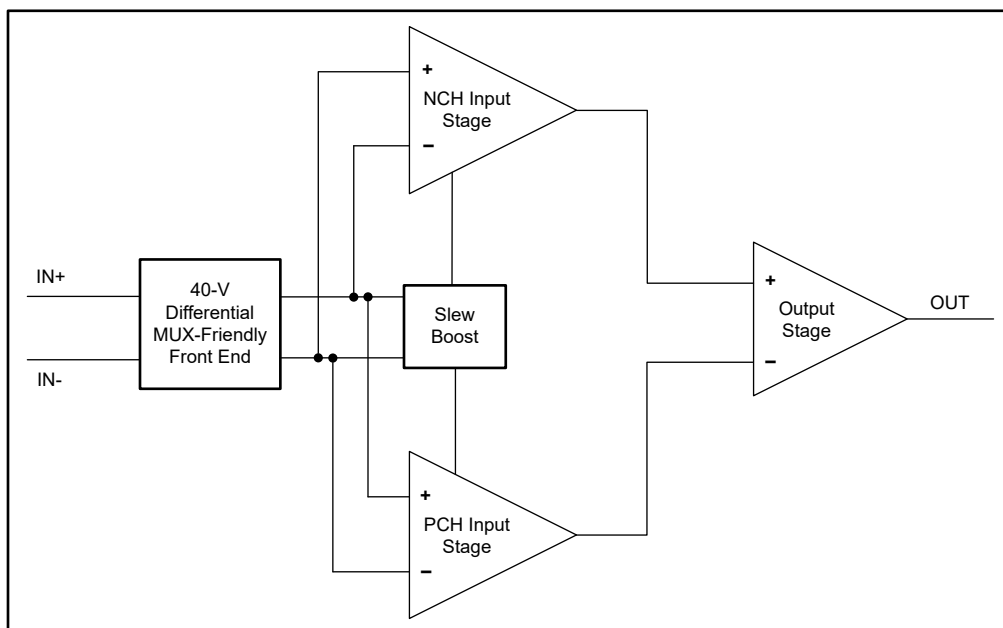

## 6.3 Feature Description

### 6.3.1 Input Protection Circuitry

The OPA4H199-SP uses a unique input architecture to eliminate the requirement for input protection diodes, but still provides robust input protection under transient conditions. Figure 6-1 shows conventional input diode protection schemes that are activated by fast transient step responses and introduce signal distortion and settling time delays because of alternate current paths, as shown in Figure 6-2. For low-gain circuits, these fast-ramping input signals forward-bias back-to-back diodes, causing an increase in input current and resulting in extended settling time.

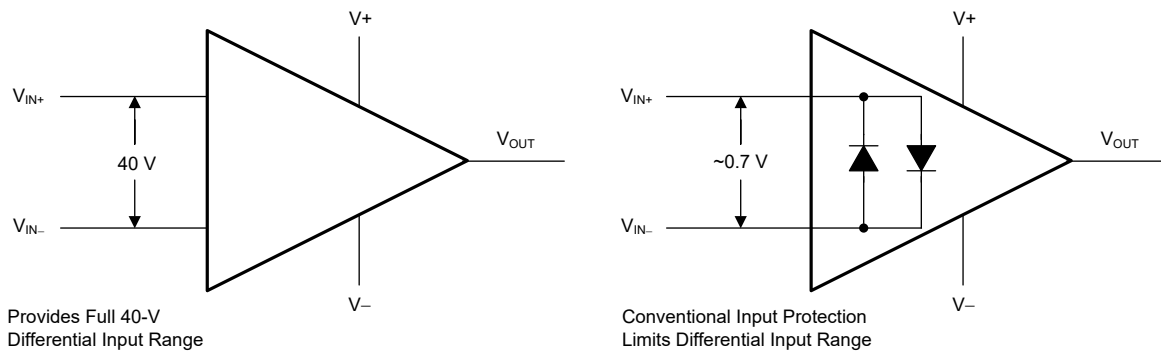

Figure 6-1. OPA4H199-SP Input Protection Does Not Limit Differential Input Capability

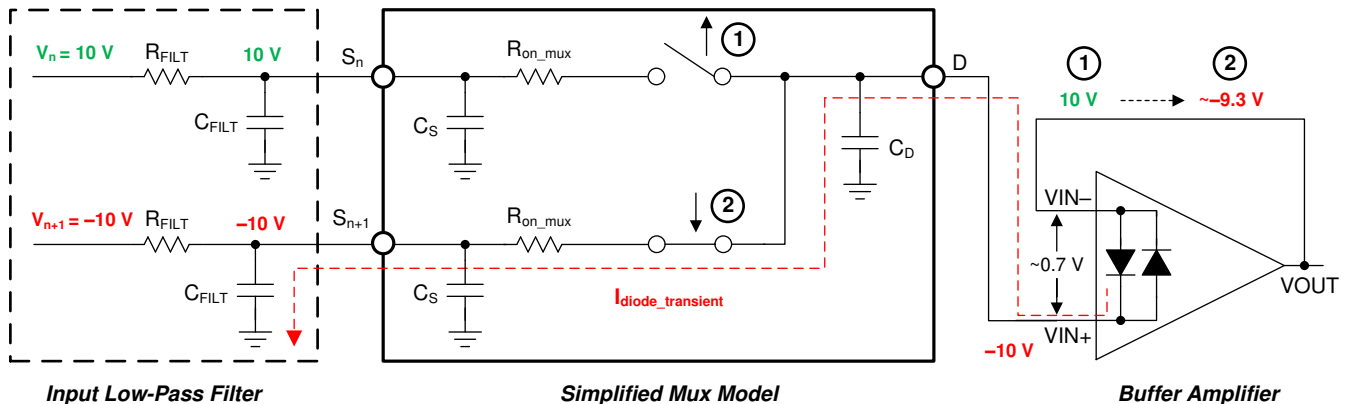

Figure 6-2. Back-to-Back Diodes Create Settling Issues

The OPA4H199-SP provides a true high-impedance differential input capability for high-voltage applications using a patented input protection architecture that does not introduce additional signal distortion or delayed settling time, making the device an excellent choice as op amp for multichannel, high-switched, input applications. The OPA4H199-SP tolerates a maximum differential swing (voltage between inverting and noninverting pins of the op amp) of up to 40V, so the device can be used as a comparator or in applications with fast-ramping input signals such as data-acquisition systems. See the [MUX-Friendly Precision Operational Amplifiers](#) application brief for more information.

### 6.3.2 EMI Rejection

The OPA4H199-SP uses integrated electromagnetic interference (EMI) filtering to reduce the effects of EMI from sources such as wireless communications and densely-populated boards with a mix of analog signal chain and digital components. EMI immunity can be improved with circuit design techniques; the OPA4H199-SP benefits from these design improvements. Texas Instruments has developed the ability to accurately measure and quantify the immunity of an operational amplifier over a broad frequency spectrum extending from 10MHz to 6GHz. Figure 6-3 shows the results of this testing on the OPA4H199-SP. Table 6-1 shows the EMIRR IN+ values for the OPA4H199-SP at particular frequencies commonly encountered in real-world applications. The

[EMI Rejection Ratio of Operational Amplifiers](#) application report contains detailed information on the topic of EMIRR performance as it relates to op amps and is available for download from [www.ti.com](http://www.ti.com).

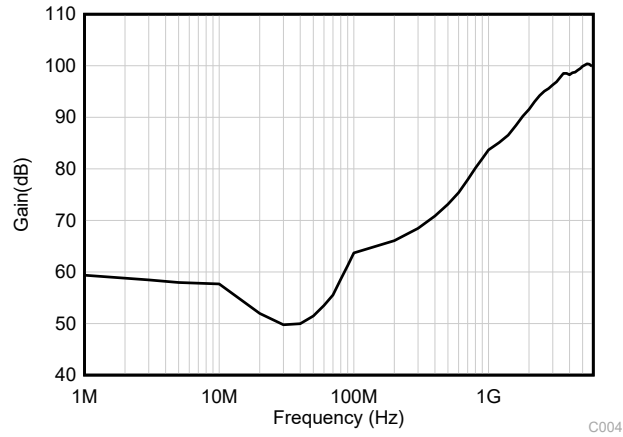

**Figure 6-3. EMIRR Testing**

**Table 6-1. OPA4H199-SP EMIRR IN+ for Frequencies of Interest**

FREQUENCY	APPLICATION OR ALLOCATION	EMIRR IN+
400MHz	Mobile radio, mobile satellite, space operation, weather, radar, ultra-high frequency (UHF) applications	73.2dB
900MHz	Global system for mobile communications (GSM) applications, radio communication, navigation, GPS (to 1.6GHz), GSM, aeronautical mobile, UHF applications	82.5dB
1.8GHz	GSM applications, mobile personal communications, broadband, satellite, L-band (1GHz to 2GHz)	89.7dB
2.4GHz	802.11b, 802.11g, 802.11n, Bluetooth®, mobile personal communications, industrial, scientific and medical (ISM) radio band, amateur radio and satellite, S-band (2GHz to 4GHz)	93.9dB
3.6GHz	Radiolocation, aero communication and navigation, satellite, mobile, S-band	95.7dB
5GHz	802.11a, 802.11n, aero communication and navigation, mobile communication, space and satellite operation, C-band (4GHz to 8GHz)	98.0dB



### 6.3.3 Thermal Protection

The internal power dissipation of any amplifier causes the internal (junction) temperature to rise. This phenomenon is called *self heating*. The absolute maximum junction temperature of the OPA4H199-SP is 150°C. Exceeding this temperature causes damage to the device. The OPA4H199-SP has a thermal protection feature that reduces damage from self heating. The protection works by monitoring the temperature of the device and turning off the op amp output drive for temperatures above 170°C. Figure 6-4 shows an application example for the OPA4H199-SP that has significant self heating because of the power dissipation (0.81W). Thermal calculations indicate that for an ambient temperature of 65°C, the device junction temperature can reach 177°C. The actual device, however, turns off the output drive to recover towards a safe junction temperature. Figure 6-4 shows how the circuit behaves during thermal protection. During normal operation, the device acts as a buffer so the output is 3V. When self heating causes the device junction temperature to increase above the internal limit, the thermal protection forces the output to a high-impedance state and the output is pulled to ground through resistor  $R_L$ . If the condition that caused excessive power dissipation is not removed, then the amplifier can oscillate between a shutdown and enabled state until the output fault is corrected.

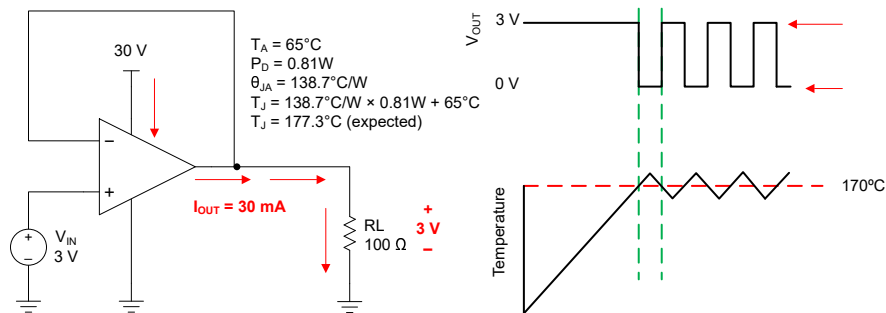
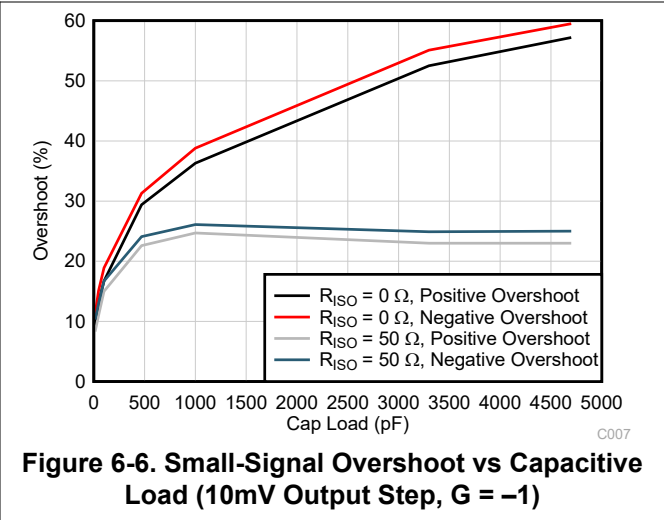
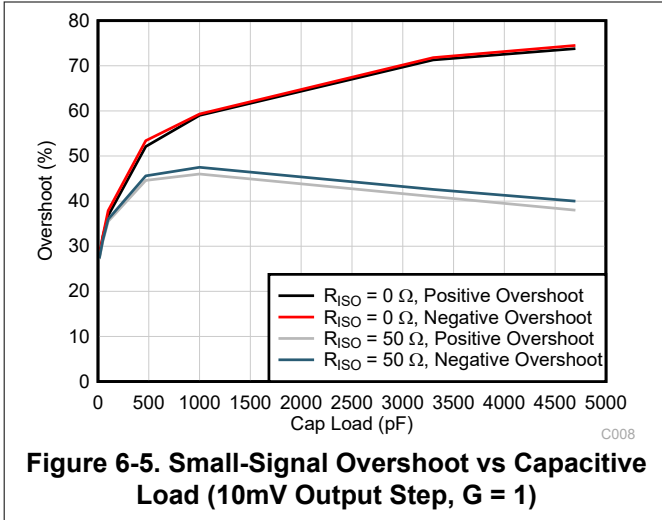

**Figure 6-4. Thermal Protection**

If the device continues to operate at high junction temperatures with high output power over a long period of time, regardless if the device is or is not entering thermal shutdown, the thermal dissipation of the device can slowly degrade performance of the device and eventually cause catastrophic destruction. Designers must be careful to limit output power of the device at high temperatures, or control ambient and junction temperatures under high output power conditions.

### 6.3.4 Capacitive Load and Stability

The OPA4H199-SP features a resistive output stage capable of driving moderate capacitive loads, and by leveraging an isolation resistor, the device can easily be configured to drive large capacitive loads. Increasing the gain enhances the ability of the amplifier to drive greater capacitive loads (see Figure 6-5 and Figure 6-6). The particular op amp circuit configuration, layout, gain, and output loading are some of the factors to consider when establishing whether an amplifier can be stable in operation.



For additional drive capability in unity-gain configurations, improve capacitive load drive by inserting a small resistor,  $R_{ISO}$ , in series with the output, as shown in Figure 6-7. This resistor significantly reduces ringing and maintains DC performance for purely capacitive loads. However, if a resistive load is in parallel with the capacitive load, then a voltage divider is created, thus introducing a gain error at the output and slightly reducing the output swing. The error introduced is proportional to the ratio  $R_{ISO} / R_L$ , and is generally negligible at low output levels. A high capacitive load drive makes the OPA4H199-SP an excellent choice for applications such as reference buffers, MOSFET gate drives, and cable-shield drives. The circuit shown in Figure 6-7 uses an isolation resistor,  $R_{ISO}$ , to stabilize the output of an op amp.  $R_{ISO}$  modifies the open-loop gain of the system for increased phase margin.

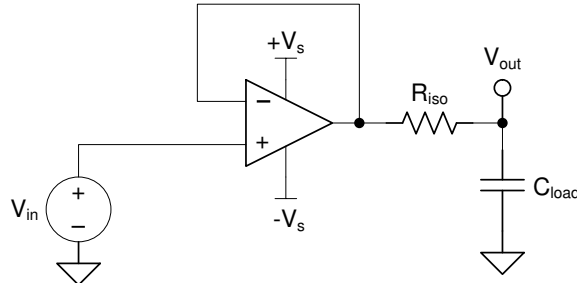

**Figure 6-7. Extending Capacitive Load Drive With the OPA4H199-SP**

### 6.3.5 Common-Mode Voltage Range

The OPA4H199-SP is a 40V, true rail-to-rail input operational amplifier with an input common-mode range that extends 100mV beyond either supply rail. This wide range is achieved with paralleled complementary N-channel and P-channel differential input pairs, as shown in Figure 6-8. The N-channel pair is active for input voltages close to the positive rail, typically  $(V+) - 1V$  to 100mV above the positive supply. The P-channel pair is active for inputs from 100mV below the negative supply to approximately  $(V+) - 2V$ . There is a small transition region, typically  $(V+) - 2V$  to  $(V+) - 1V$  in which both input pairs are turned on. This transition region can vary modestly with process variation, and within this region PSRR, CMRR, offset voltage, offset drift, noise, and THD performance can be degraded compared to operation outside this region.

Figure 5-5 shows this transition region for a typical device in terms of input voltage offset in more detail.

For more information on common-mode voltage range and PMOS/NMOS pair interaction, see the [Op amps with complementary-pair input stages: What are the design trade-offs?](#) Analog Design Journal.

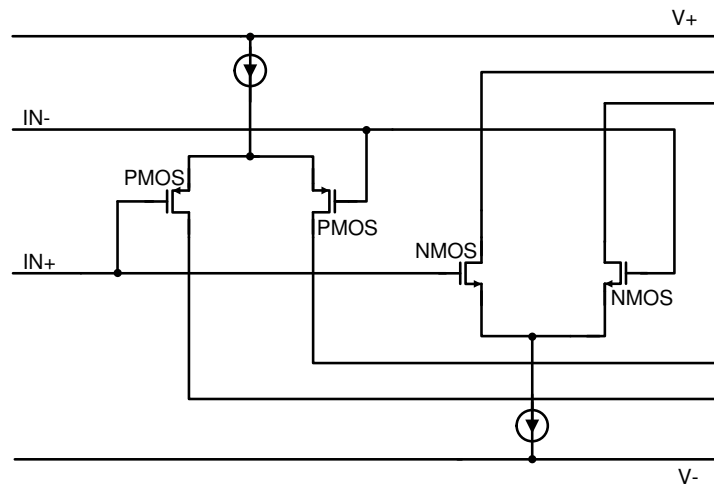
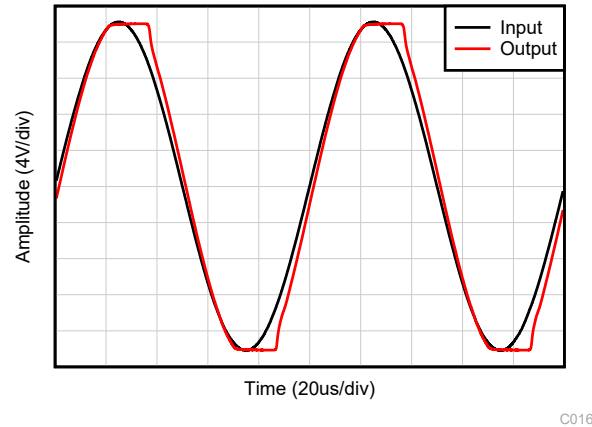

Figure 6-8. Rail-to-Rail Input Stage

### 6.3.6 Phase Reversal Protection

The OPA4H199-SP family has internal phase-reversal protection. Many op amps exhibit phase reversal when the input is driven beyond the linear common-mode range. This condition is most often encountered in non-inverting circuits when the input is driven beyond the specified common-mode voltage range, causing the output to reverse into the opposite rail. The OPA4H199-SP is a rail-to-rail input op amp; therefore, the common-mode range can extend beyond the rails. Input signals beyond the rails do not cause phase reversal; instead, the output limits into the appropriate rail. This performance is shown in Figure 6-9. For more information on phase reversal, see the [Op amps with complementary-pair input stages: What are the design trade-offs?](#) Analog Design Journal.

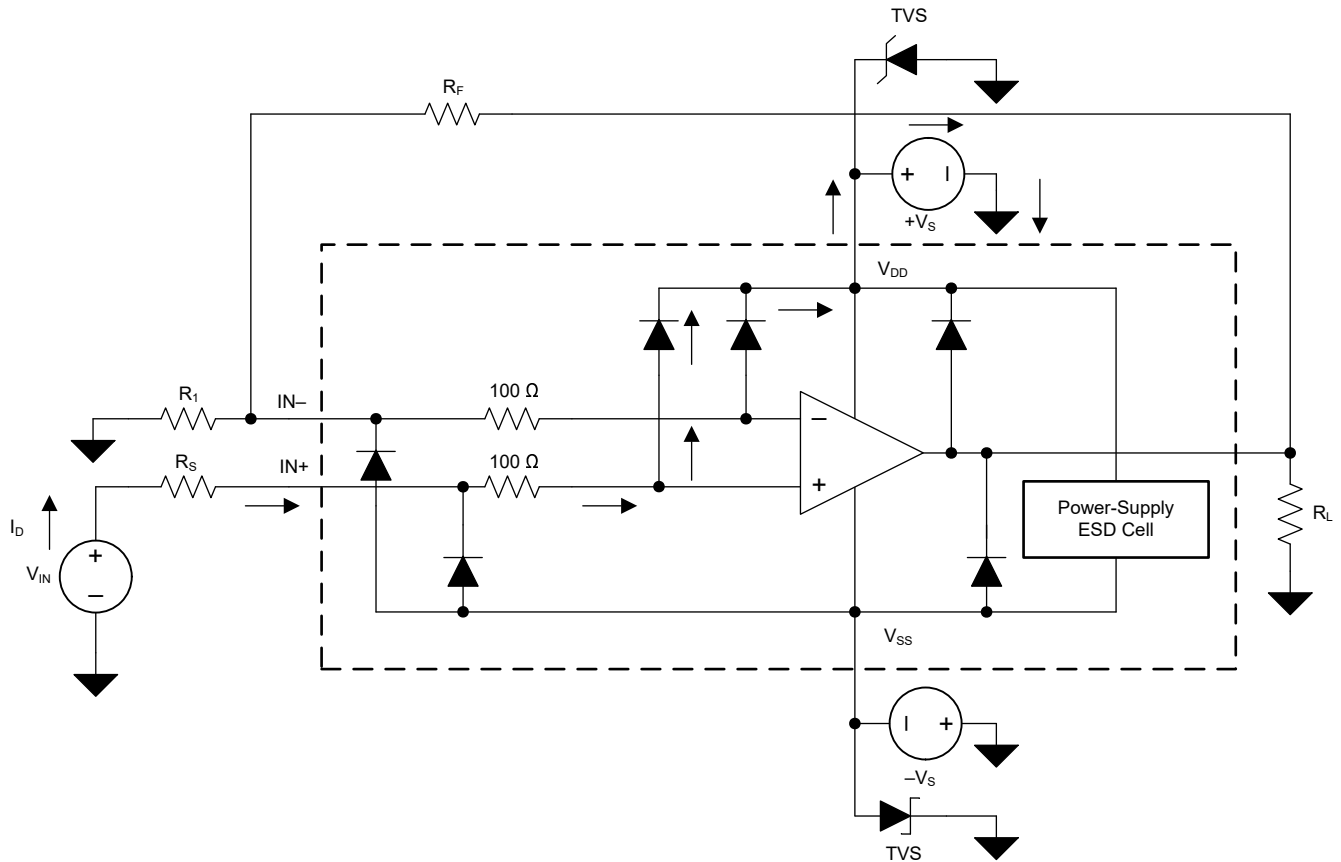

**Figure 6-9. No Phase Reversal**

### 6.3.7 Electrical Overstress

Designers often ask questions about the capability of an operational amplifier to withstand electrical overstress (EOS). These questions tend to focus on the device inputs, but can involve the supply voltage pins or even the output pin. Each of these different pin functions have electrical stress limits determined by the voltage breakdown characteristics of the particular semiconductor fabrication process and specific circuits connected to the pin. Additionally, internal electrostatic discharge (ESD) protection is built into these circuits to protect them from accidental ESD events both before and during product assembly.

Having a good understanding of this basic ESD circuitry and the relevance to an electrical overstress event is helpful. [Figure 6-10](#) shows an illustration of the ESD circuits contained in the OPA4H199-SP (indicated by the dashed line area). The ESD protection circuitry involves several current-steering diodes connected from the input and output pins and routed back to the internal power-supply lines, where the diodes meet at an absorption device or the power-supply ESD cell, internal to the operational amplifier. This protection circuitry is intended to remain inactive during normal circuit operation.



**Figure 6-10. Equivalent Internal ESD Circuitry Relative to a Typical Circuit Application**

An ESD event is very short in duration and very high voltage (for example; 1kV, 100ns), whereas an EOS event is long duration and lower voltage (for example; 50V, 100ms). The ESD diodes are designed for out-of-circuit ESD protection (that is, during assembly, test, and storage of the device before being soldered to the PCB). During an ESD event, the ESD signal is passed through the ESD steering diodes to an absorption circuit (labeled ESD power-supply circuit). The ESD absorption circuit clamps the supplies to a safe level.

Although this behavior is necessary for out-of-circuit protection, excessive current and damage is caused if activated in-circuit. A transient voltage suppressors (TVS) can be used to prevent against damage caused by turning on the ESD absorption circuit during an in-circuit ESD event. Using the appropriate current limiting resistors and TVS diodes allows for the use of device ESD diodes to protect against EOS events.

### 6.3.8 Overload Recovery

Overload recovery is defined as the time required for the op amp output to recover from a saturated state to a linear state. The output devices of the op amp enter a saturation region when the output voltage exceeds the rated operating voltage, either due to the high input voltage or the high gain. After the device enters the saturation region, the charge carriers in the output devices require time to return back to the linear state. After the charge carriers return back to the linear state, the device begins to slew at the specified slew rate. Thus, the propagation delay in case of an overload condition is the sum of the overload recovery time and the slew time. The overload recovery time for the OPA4H199-SP is approximately 400ns.

### 6.3.9 Typical Specifications and Distributions

Designers often have questions about a typical specification of an amplifier to design a more robust circuit. Due to natural variation in process technology and manufacturing procedures, every specification of an amplifier exhibits some amount of deviation from the proper value, like an input offset voltage of the amplifier. These deviations often follow *Gaussian* (bell curve), or *normal* distributions, and circuit designers can leverage this information to guardband their system, even when there is not a minimum or maximum specification in [Electrical Characteristics](#).

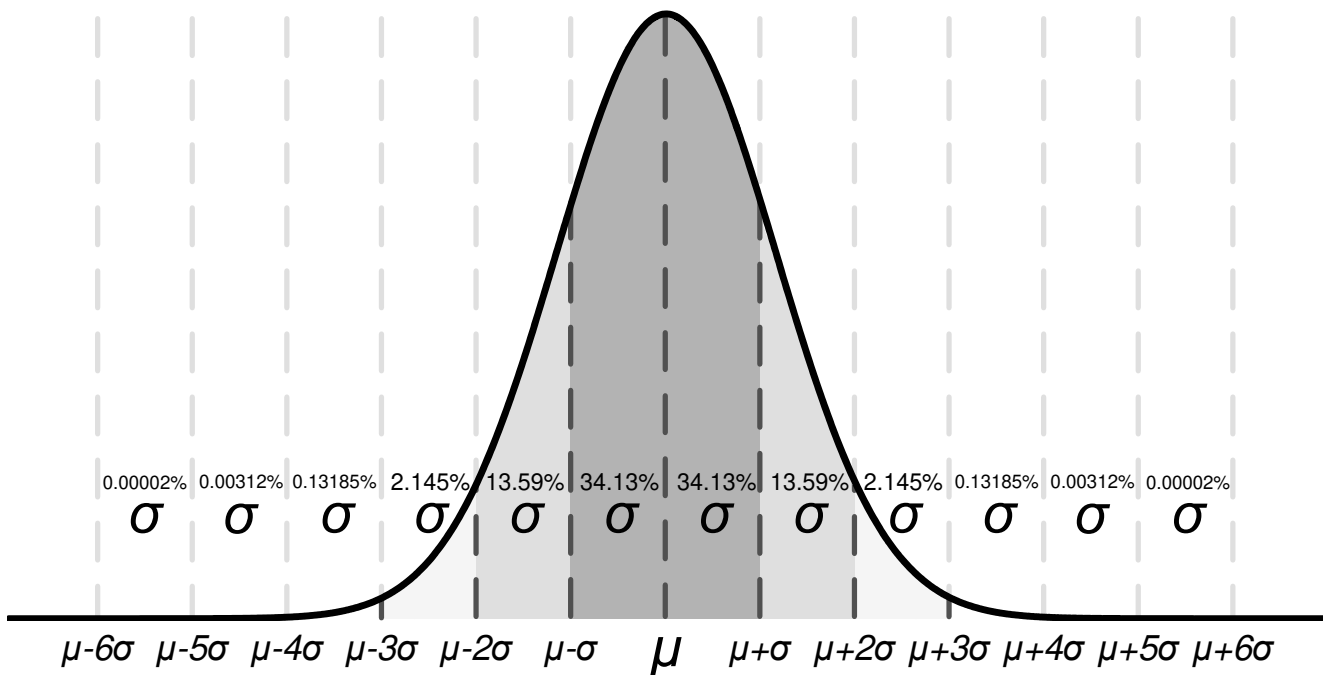

Figure 6-11. Ideal Gaussian Distribution

Figure 6-11 shows an example distribution, where  $\mu$ , or *mu*, is the mean of the distribution, and where  $\sigma$ , or *sigma*, is the standard deviation of a system. For a specification that exhibits this kind of distribution, approximately two-thirds (68.26%) of all units can be expected to have a value within one standard deviation, or one sigma, of the mean (from  $\mu - \sigma$  to  $\mu + \sigma$ ).

Depending on the specification, values listed in the *typical* column of the [Electrical Characteristics](#) are represented in different ways. General guidance suggests that if a specification naturally has a nonzero mean (for example, like gain bandwidth), then the typical value is equal to the mean ( $\mu$ ). However, if a specification naturally has a mean near zero (like input offset voltage), then the typical value is equal to the mean plus one standard deviation ( $\mu + \sigma$ ) to most accurately represent the typical value.

You can use this chart to calculate approximate probability of a specification in a unit; for example, for OPA4H199-SP, the typical input voltage offset is 125 $\mu$ V, so 68.2% of all OPA4H199-SP devices are expected to have an offset from  $-125\mu$ V to 125 $\mu$ V. At  $4\sigma$  ( $\pm 500\mu$ V), 99.9937% of the distribution has an offset voltage less

than  $\pm 500\mu\text{V}$ , which means 0.0063% of the population is outside of these limits, which corresponds to about 1 in 15,873 units.

TI verifies specifications with a value in the minimum or maximum column, and units outside these limits are removed from production material. For example, the OPA4H199-SP family has a maximum offset voltage of  $895\mu\text{V}$  at  $25^\circ\text{C}$ , and even though this corresponds to more than  $5\sigma$  (approximately 1 in 1.7 million units), which is extremely unlikely, TI specifies that any unit with larger offset than  $895\mu\text{V}$  is removed from production material.

For specifications with no value in the minimum or maximum column, consider selecting a sigma value of sufficient guardband for your application, and design worst-case conditions using this value. For example, the  $6\sigma$  value corresponds to approximately 1 in 500 million units, which is an extremely unlikely chance, and can be an option as a wide guardband to design a system around. In this case, the OPA4H199-SP family does not have a maximum or minimum for offset voltage drift, but based on [Figure 5-2](#) and the typical value of  $0.3\mu\text{V}/^\circ\text{C}$  in the [Electrical Characteristics](#), the calculation results in a  $6\sigma$  value for offset voltage drift is about  $1.8\mu\text{V}/^\circ\text{C}$ . When designing for worst-case system conditions, this value can be used to estimate the worst possible offset across temperature without having an actual minimum or maximum value.

However, process variation and adjustments over time can shift typical means and standard deviations, and unless there is a value in the minimum or maximum specification column, the performance of a device is not verified. This information must be used only to estimate the performance of a device.

## 6.4 Device Functional Modes

The OPA4H199-SP has a single functional mode and is operational when the power-supply voltage is greater than  $2.7\text{V}$  ( $\pm 1.35\text{V}$ ). The maximum power supply voltage for the OPA4H199-SP is  $40\text{V}$  ( $\pm 20\text{V}$ ).

## 7 Application and Implementation

### Note

Information in the following applications sections is not part of the TI component specification, and TI does not warrant its accuracy or completeness. TI's customers are responsible for determining suitability of components for their purposes, as well as validating and testing their design implementation to confirm system functionality.

### 7.1 Application Information

The OPA4H199-SP family offers excellent DC precision and AC performance. These devices operate up to 40V supply rails and offer true rail-to-rail input/output, low offset voltage and offset voltage drift, as well as 4.5MHz bandwidth and high output drive. These features make the OPA4H199-SP a robust, high-performance operational amplifier for high-voltage industrial applications.

### 7.2 Typical Applications

#### 7.2.1 Low-Side Current Measurement

Figure 7-1 shows the OPA4H199-SP configured in a low-side current sensing application. For a full analysis of the circuit shown in Figure 7-1 including theory, calculations, simulations, and measured data, see TI Precision Design TIPD129, [0A to 1A Single-Supply Low-Side Current-Sensing Solution](#).

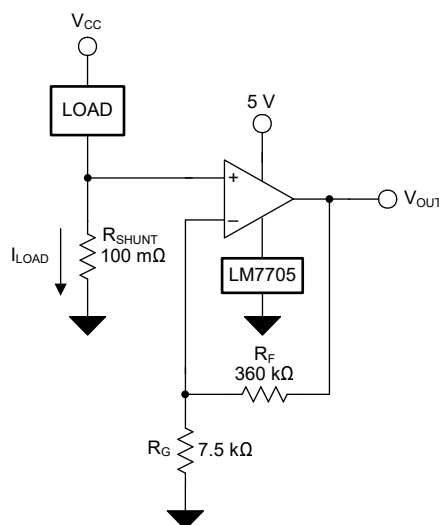

Figure 7-1. OPA4H199-SP in a Low-Side, Current-Sensing Application

#### 7.2.1.1 Design Requirements

The design requirements for this design are:

- Load current: 0A to 1A
- Output voltage: 4.9V
- Maximum shunt voltage: 100mV



### 7.2.1.2 Detailed Design Procedure

The transfer function of the circuit in [Figure 7-1](#) is given in [Equation 1](#).

$$V_{OUT} = I_{LOAD} \times R_{SHUNT} \times \text{Gain} \quad (1)$$

The load current ( $I_{LOAD}$ ) produces a voltage drop across the shunt resistor ( $R_{SHUNT}$ ). The load current is set from 0A to 1A. To keep the shunt voltage below 100mV at maximum load current, the largest shunt resistor is defined using [Equation 2](#).

$$R_{SHUNT} = \frac{V_{SHUNT\_MAX}}{I_{LOAD\_MAX}} = \frac{100 \text{ mV}}{1 \text{ A}} = 100 \text{ m}\Omega \quad (2)$$

Using [Equation 2](#),  $R_{SHUNT}$  is calculated to be 100m $\Omega$ . The voltage drop produced by  $I_{LOAD}$  and  $R_{SHUNT}$  is amplified by the OPA4H199-SP to produce an output voltage of 0V to 4.9V. The gain needed by the OPA4H199-SP to produce the necessary output voltage is calculated using [Equation 3](#).

$$\text{Gain} = \frac{(V_{OUT\_MAX} - V_{OUT\_MIN})}{(V_{IN\_MAX} - V_{IN\_MIN})} \quad (3)$$

Using [Equation 3](#), the required gain is calculated to be 49V/V, which is set with resistors  $R_F$  and  $R_G$ . [Equation 4](#) is used to size the resistors,  $R_F$  and  $R_G$ , to set the gain of the OPA4H199-SP to 49V/V.

$$\text{Gain} = 1 + \frac{(R_F)}{(R_G)} \quad (4)$$

Choosing  $R_F$  as 360k $\Omega$ ,  $R_G$  is calculated to be 7.5k $\Omega$ .  $R_F$  and  $R_G$  were chosen as 360k $\Omega$  and 7.5k $\Omega$  because they are standard value resistors that create a 49:1 ratio. Other resistors that create a 49:1 ratio can also be used. [Figure 7-2](#) shows the measured transfer function of the circuit shown in [Figure 7-1](#).

### 7.2.1.3 Application Curve

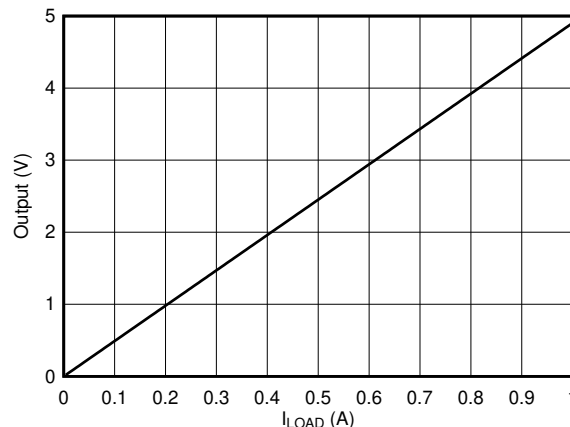

**Figure 7-2. Low-Side, Current-Sense, Transfer Function**

## 7.3 Power Supply Recommendations

The OPA4H199-SP is specified for operation from 2.7V to 40V ( $\pm 1.35\text{V}$  to  $\pm 40\text{V}$ ); many specifications apply from  $-55^{\circ}\text{C}$  to  $125^{\circ}\text{C}$ . Parameters that can exhibit significant variance with regard to operating voltage or temperature are presented in [Typical Characteristics](#).

### CAUTION

Supply voltages larger than 40V can permanently damage the device; see [Absolute Maximum Ratings](#).

Place 0.1 $\mu\text{F}$  bypass capacitors close to the power-supply pins to reduce errors coupling in from noisy or high-impedance power supplies. For more detailed information on bypass capacitor placement, refer to [Layout](#).

## 7.4 Layout

### 7.4.1 Layout Guidelines

For best operational performance of the device, use good PCB layout practices, including:

- Noise can propagate into analog circuitry through the power pins of the circuit as a whole and op amp itself. Bypass capacitors are used to reduce the coupled noise by providing low-impedance power sources local to the analog circuitry.
  - Connect low-ESR, 0.1 $\mu\text{F}$  ceramic bypass capacitors between each supply pin and ground, placed as close to the device as possible. A single bypass capacitor from V+ to ground is applicable for single-supply applications.
- Separate grounding for the analog and digital portions of circuitry is one of the simplest and most-effective methods of noise suppression. One or more layers on multilayer PCBs are usually devoted to ground planes. A ground plane helps distribute heat and reduces EMI noise pickup. Make sure to physically separate digital and analog grounds paying attention to the flow of the ground current.
- To reduce parasitic coupling, run the input traces as far away from the supply or output traces as possible. If these traces cannot be kept separate, crossing the sensitive trace perpendicular is much better as opposed to in parallel with the noisy trace.
- Place the external components as close to the device as possible. As illustrated in [Figure 7-4](#), keeping RF and RG close to the inverting input minimizes parasitic capacitance.
- Keep the length of input traces as short as possible. Always remember that the input traces are the most sensitive part of the circuit.
- Consider a driven, low-impedance guard ring around the critical traces. A guard ring can significantly reduce leakage currents from nearby traces that are at different potentials.
- Cleaning the PCB following board assembly is recommended for best performance.
- Any precision integrated circuit can experience performance shifts due to moisture ingress into the plastic package. Following any aqueous PCB cleaning process, baking the PCB assembly is recommended to remove moisture introduced into the device packaging during the cleaning process. A low-temperature, post-cleaning bake at  $85^{\circ}\text{C}$  for 30 minutes is sufficient for most circumstances.

### 7.4.2 Layout Example

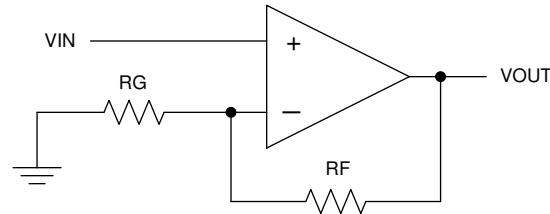

**Figure 7-3. Schematic Representation**

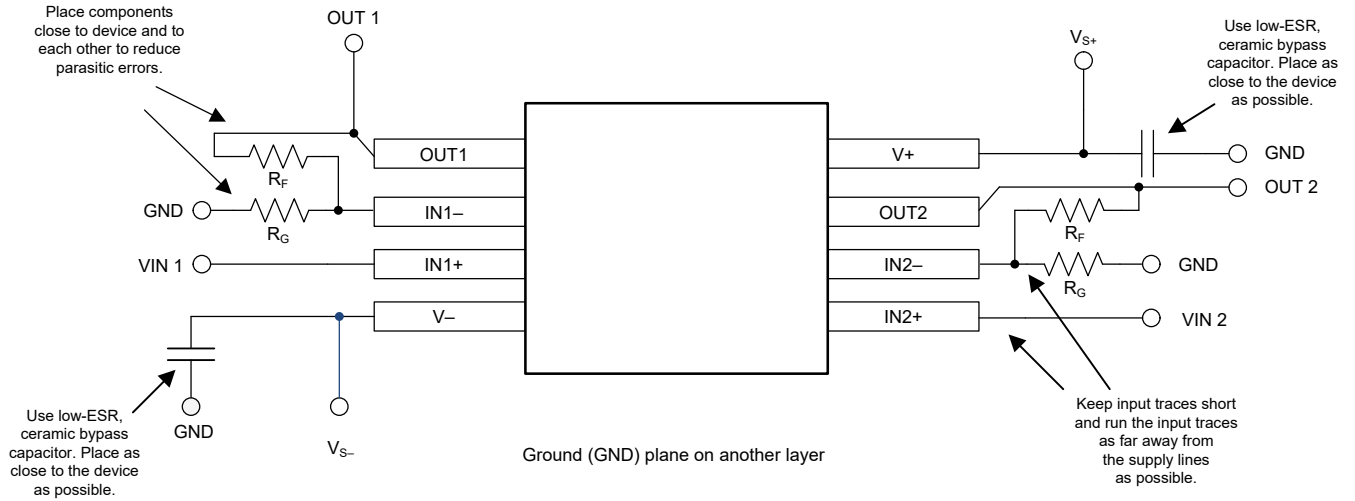

**Figure 7-4. Operational Amplifier Board Layout for Noninverting Configuration**

## 8 Device and Documentation Support

### 8.1 Device Support

#### 8.1.1 Development Support

##### 8.1.1.1 TINA-TI™ (Free Software Download)

TINA™ is a simple, powerful, and easy-to-use circuit simulation program based on a SPICE engine. TINA-TI is a free, fully-functional version of the TINA software, preloaded with a library of macro models in addition to a range of both passive and active models. TINA-TI provides all the conventional dc, transient, and frequency domain analysis of SPICE, as well as additional design capabilities.

Available as a [free download](#) from the Analog eLab Design Center, TINA-TI offers extensive post-processing capability that allows users to format results in a variety of ways. Virtual instruments offer the ability to select input waveforms and probe circuit nodes, voltages, and waveforms, creating a dynamic quick-start tool.

---

#### Note

These files require that either the TINA software (from DesignSoft™) or TINA-TI software be installed. Download the free TINA-TI software from the [TINA-TI folder](#).

---

### 8.2 Documentation Support

#### 8.2.1 Related Documentation

For related documentation, see the following:

- Texas Instruments, [Analog Engineer's Circuit Cookbook: Amplifiers](#) solution guide
- Texas Instruments, [AN31 Amplifier Circuit Collection](#) application note
- Texas Instruments, [MUX-Friendly Precision Operational Amplifiers](#) application brief
- Texas Instruments, [EMI Rejection Ratio of Operational Amplifiers](#) application note
- Texas Instruments, [Op Amps With Complementary-Pair Input Stages](#) application note
- Texas Instruments, [Op amps with complementary-pair input stages: What are the design trade-offs?](#) Analog Design Journal

### 8.3 Receiving Notification of Documentation Updates

To receive notification of documentation updates, navigate to the device product folder on [ti.com](#). Click on *Notifications* to register and receive a weekly digest of any product information that has changed. For change details, review the revision history included in any revised document.

### 8.4 Support Resources

[TI E2E™ support forums](#) are an engineer's go-to source for fast, verified answers and design help — straight from the experts. Search existing answers or ask your own question to get the quick design help you need.

Linked content is provided "AS IS" by the respective contributors. They do not constitute TI specifications and do not necessarily reflect TI's views; see TI's [Terms of Use](#).

### 8.5 Trademarks

TINA-TI™ and TI E2E™ are trademarks of Texas Instruments.

TINA™ and DesignSoft™ are trademarks of DesignSoft, Inc.

Bluetooth® is a registered trademark of Bluetooth SIG, Inc.

All trademarks are the property of their respective owners.

### 8.6 Electrostatic Discharge Caution



This integrated circuit can be damaged by ESD. Texas Instruments recommends that all integrated circuits be handled with appropriate precautions. Failure to observe proper handling and installation procedures can cause damage.

ESD damage can range from subtle performance degradation to complete device failure. Precision integrated circuits may be more susceptible to damage because very small parametric changes could cause the device not to meet its published specifications.

## 8.7 Glossary

[TI Glossary](#) This glossary lists and explains terms, acronyms, and definitions.

## 9 Revision History

DATE	REVISION	NOTES
December 2024	*	Initial Release

## 10 Mechanical, Packaging, and Orderable Information

The following pages include mechanical, packaging, and orderable information. This information is the most current data available for the designated devices. This data is subject to change without notice and revision of this document. For browser-based versions of this data sheet, refer to the left-hand navigation.

**PACKAGING INFORMATION**

Orderable Device	Status (1)	Package Type	Package Drawing	Pins	Package Qty	Eco Plan (2)	Lead finish/ Ball material (6)	MSL Peak Temp (3)	Op Temp (°C)	Device Marking (4/5)	Samples
5962R2321401PXE	ACTIVE	SOT-23-THIN	DYY	14	250	RoHS & Green	NIPDAU	Level-2-260C-1 YEAR	-55 to 125	5962R 2321401PXE 4H199DYYSP	

(1) The marketing status values are defined as follows:

**ACTIVE:** Product device recommended for new designs.

**LIFEBUY:** TI has announced that the device will be discontinued, and a lifetime-buy period is in effect.

**NRND:** Not recommended for new designs. Device is in production to support existing customers, but TI does not recommend using this part in a new design.

**PREVIEW:** Device has been announced but is not in production. Samples may or may not be available.

**OBSOLETE:** TI has discontinued the production of the device.

(2) **RoHS:** TI defines "RoHS" to mean semiconductor products that are compliant with the current EU RoHS requirements for all 10 RoHS substances, including the requirement that RoHS substance do not exceed 0.1% by weight in homogeneous materials. Where designed to be soldered at high temperatures, "RoHS" products are suitable for use in specified lead-free processes. TI may reference these types of products as "Pb-Free".

**RoHS Exempt:** TI defines "RoHS Exempt" to mean products that contain lead but are compliant with EU RoHS pursuant to a specific EU RoHS exemption.

**Green:** TI defines "Green" to mean the content of Chlorine (Cl) and Bromine (Br) based flame retardants meet JS709B low halogen requirements of <=1000ppm threshold. Antimony trioxide based flame retardants must also meet the <=1000ppm threshold requirement.

(3) MSL, Peak Temp. - The Moisture Sensitivity Level rating according to the JEDEC industry standard classifications, and peak solder temperature.

(4) There may be additional marking, which relates to the logo, the lot trace code information, or the environmental category on the device.

(5) Multiple Device Markings will be inside parentheses. Only one Device Marking contained in parentheses and separated by a "~" will appear on a device. If a line is indented then it is a continuation of the previous line and the two combined represent the entire Device Marking for that device.

(6) Lead finish/Ball material - Orderable Devices may have multiple material finish options. Finish options are separated by a vertical ruled line. Lead finish/Ball material values may wrap to two lines if the finish value exceeds the maximum column width.

**Important Information and Disclaimer:** The information provided on this page represents TI's knowledge and belief as of the date that it is provided. TI bases its knowledge and belief on information provided by third parties, and makes no representation or warranty as to the accuracy of such information. Efforts are underway to better integrate information from third parties. TI has taken and continues to take reasonable steps to provide representative and accurate information but may not have conducted destructive testing or chemical analysis on incoming materials and chemicals. TI and TI suppliers consider certain information to be proprietary, and thus CAS numbers and other limited information may not be available for release.

In no event shall TI's liability arising out of such information exceed the total purchase price of the TI part(s) at issue in this document sold by TI to Customer on an annual basis.

**OTHER QUALIFIED VERSIONS OF OPA4H199-SP :**

- Catalog : [OPA4H199-SEP](#)

NOTE: Qualified Version Definitions:

- Catalog - TI's standard catalog product

**TAPE AND REEL INFORMATION**

**QUADRANT ASSIGNMENTS FOR PIN 1 ORIENTATION IN TAPE**

\*All dimensions are nominal

Device	Package Type	Package Drawing	Pins	SPQ	Reel Diameter (mm)	Reel Width W1 (mm)	A0 (mm)	B0 (mm)	K0 (mm)	P1 (mm)	W (mm)	Pin1 Quadrant
5962R2321401PXE	SOT-23-THIN	DYY	14	250	178.0	12.4	3.56	4.5	1.3	8.0	12.0	Q1



**TAPE AND REEL BOX DIMENSIONS**

\*All dimensions are nominal

Device	Package Type	Package Drawing	Pins	SPQ	Length (mm)	Width (mm)	Height (mm)
5962R2321401PXE	SOT-23-THIN	DYY	14	250	208.0	191.0	35.0

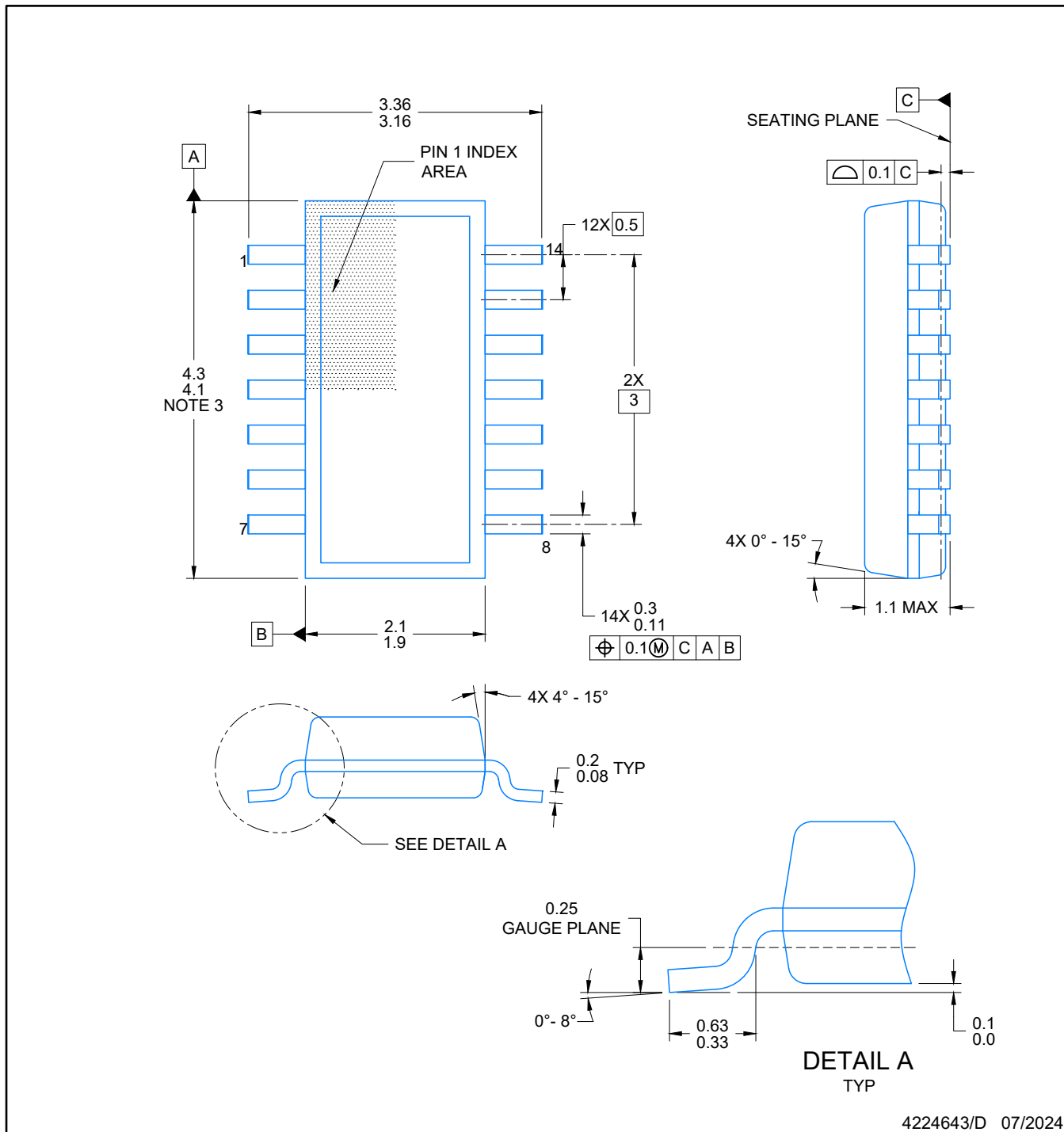

4224643/D 07/2024

NOTES:

1. All linear dimensions are in millimeters. Any dimensions in parenthesis are for reference only. Dimensioning and tolerancing per ASME Y14.5M.
2. This drawing is subject to change without notice.
3. This dimension does not include mold flash, protrusions, or gate burrs. Mold flash, protrusions, or gate burrs shall not exceed 0.15 per side.
4. This dimension does not include interlead flash. Interlead flash shall not exceed 0.50 per side.
5. Reference JEDEC Registration MO-345, Variation AB

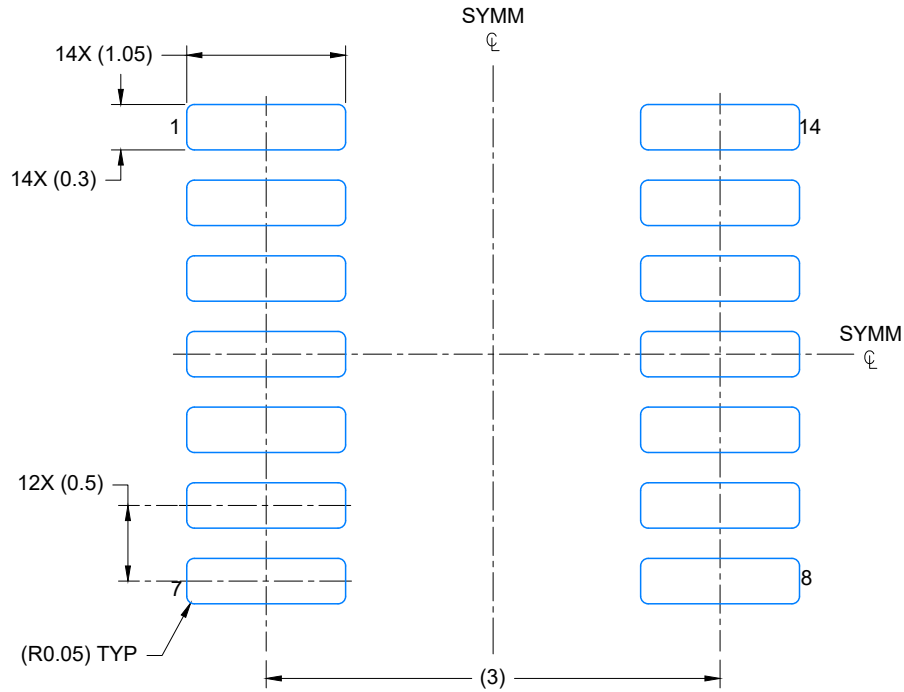

LAND PATTERN EXAMPLE  
EXPOSED METAL SHOWN  
SCALE: 20X

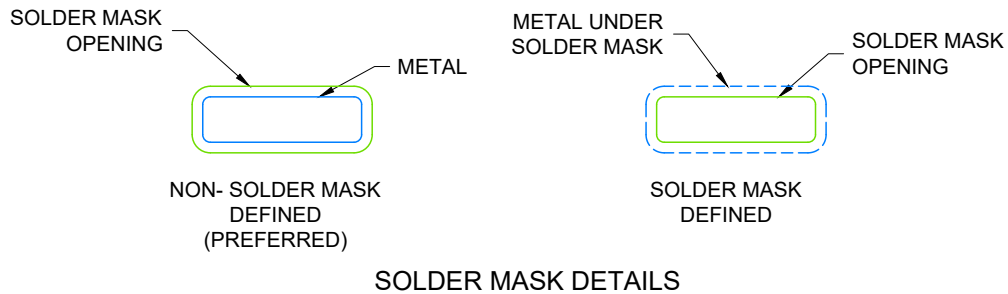

4224643/D 07/2024

NOTES: (continued)

- 6. Publication IPC-7351 may have alternate designs.
- 7. Solder mask tolerances between and around signal pads can vary based on board fabrication site.

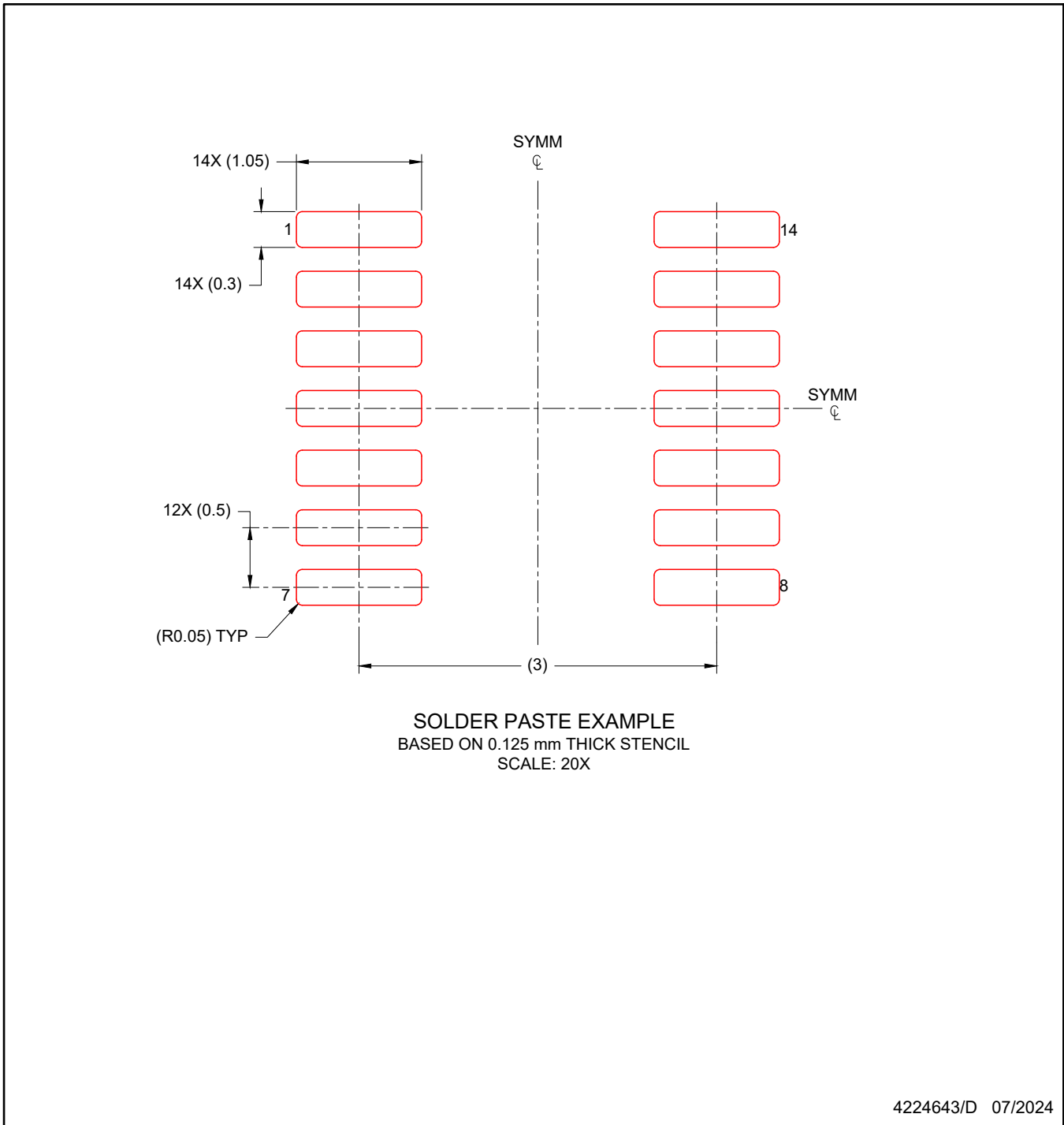

NOTES: (continued)

8. Laser cutting apertures with trapezoidal walls and rounded corners may offer better paste release. IPC-7525 may have alternate design recommendations.
9. Board assembly site may have different recommendations for stencil design.

## IMPORTANT NOTICE AND DISCLAIMER

TI PROVIDES TECHNICAL AND RELIABILITY DATA (INCLUDING DATA SHEETS), DESIGN RESOURCES (INCLUDING REFERENCE DESIGNS), APPLICATION OR OTHER DESIGN ADVICE, WEB TOOLS, SAFETY INFORMATION, AND OTHER RESOURCES "AS IS" AND WITH ALL FAULTS, AND DISCLAIMS ALL WARRANTIES, EXPRESS AND IMPLIED, INCLUDING WITHOUT LIMITATION ANY IMPLIED WARRANTIES OF MERCHANTABILITY, FITNESS FOR A PARTICULAR PURPOSE OR NON-INFRINGEMENT OF THIRD PARTY INTELLECTUAL PROPERTY RIGHTS.

These resources are intended for skilled developers designing with TI products. You are solely responsible for (1) selecting the appropriate TI products for your application, (2) designing, validating and testing your application, and (3) ensuring your application meets applicable standards, and any other safety, security, regulatory or other requirements.

These resources are subject to change without notice. TI grants you permission to use these resources only for development of an application that uses the TI products described in the resource. Other reproduction and display of these resources is prohibited. No license is granted to any other TI intellectual property right or to any third party intellectual property right. TI disclaims responsibility for, and you will fully indemnify TI and its representatives against, any claims, damages, costs, losses, and liabilities arising out of your use of these resources.

TI's products are provided subject to [TI's Terms of Sale](#) or other applicable terms available either on [ti.com](https://www.ti.com) or provided in conjunction with such TI products. TI's provision of these resources does not expand or otherwise alter TI's applicable warranties or warranty disclaimers for TI products.

TI objects to and rejects any additional or different terms you may have proposed.

Mailing Address: Texas Instruments, Post Office Box 655303, Dallas, Texas 75265  
Copyright © 2025, Texas Instruments Incorporated